

Instruction Manual

PN 51-Xmt-T/rev.C

February 2006

Model Solu Comp® Xmt-T

Two-Wire Toroidal Conductivity Transmitter



ESSENTIAL INSTRUCTIONS

READ THIS PAGE BEFORE PROCEEDING!

Rosemount Analytical designs, manufactures, and tests its products to meet many national and international standards. Because these instruments are sophisticated technical products, you must properly install, use, and maintain them to ensure they continue to operate within their normal specifications. The following instructions must be adhered to and integrated into your safety program when installing, using, and maintaining Rosemount Analytical products. Failure to follow the proper instructions may cause any one of the following situations to occur: Loss of life; personal injury; property damage; damage to this instrument; and warranty invalidation.

- Read all instructions prior to installing, operating, and servicing the product. If this Instruction Manual is not the correct manual, telephone 1-800-654-7768 and the requested manual will be provided. Save this Instruction Manual for future reference.
- If you do not understand any of the instructions, contact your Rosemount representative for clarification.
- Follow all warnings, cautions, and instructions marked on and supplied with the product.
- Inform and educate your personnel in the proper installation, operation, and maintenance of the product.
- Install your equipment as specified in the Installation Instructions of the appropriate Instruction Manual and per applicable local and national codes. Connect all products to the proper electrical and pressure sources.
- To ensure proper performance, use qualified personnel to install, operate, update, program, and maintain the product.
- When replacement parts are required, ensure that qualified people use replacement parts specified by Rosemount. Unauthorized parts and procedures can affect the product's performance and place the safe operation of your process at risk. Look alike substitutions may result in fire, electrical hazards, or improper operation.
- Ensure that all equipment doors are closed and protective covers are in place, except when maintenance is being performed by qualified persons, to prevent electrical shock and personal injury.

NOTICE

If a Model 375 Universal Hart® Communicator is used with these transmitters, the software within the Model 375 may require modification. If a software modification is required, please contact your local Emerson Process Management Service Group or National Response Center at 1-800-654-7768.

About This Document

This manual contains instructions for installation and operation of the Model Xmt-T Two-Wire Toroidal Conductivity Transmitter. The following list provides notes concerning all revisions of this document.

<u>Rev. Level</u>	<u>Date</u>	<u>Notes</u>
A	3/05	This is the initial release of the product manual. The manual has been reformatted to reflect the Emerson documentation style and updated to reflect any changes in the product offering. This manual contains information on HART Smart and FOUNDATION Fieldbus versions of Model Solu Comp Xmt-T.
B	10/05	Add Foundation fieldbus agency approvals and FISCO version.
C	2/06	Revised section 1.0, page 1, and the case specification on page 2. Added new drawings of FF and FI on section 4.0, pages 24-35.

Emerson Process Management

Rosemount Analytical Inc.

2400 Barranca Parkway
Irvine, CA 92606 USA
Tel: (949) 757-8500
Fax: (949) 474-7250

<http://www.raihome.com>

QUICK START GUIDE

FOR MODEL SOLU COMP XMT-T TRANSMITTER

1. Refer to page 11 for installation instructions.
2. Wire conductivity sensor to the transmitter. Refer to the sensor instruction sheet for details.
3. Once connections are secure and verified, apply DC power to the transmitter.
4. When the transmitter is powered up for the first time, **Quick Start** screens appear. Using **Quick Start** is easy.
 - a. A blinking field shows the position of the cursor.
 - b. Use the ◀ or ▶ key to move the cursor left or right. Use the ▲ or ▼ key to move the cursor up or down or to increase or decrease the value of a digit. Use the ▲ or ▼ key to move the decimal point.
 - c. Press ENTER to store a setting. Press EXIT to leave without storing changes. Pressing EXIT also returns the display to the previous screen.

Measure?	Cond
TDS	Custom %Conc

5. Choose measurement: **Conductivity**, **Total Dissolved Solids**, **Custom**, or **% Concentration**.

S1 %Conc?	NaCl
NaOH	H2SO4 HCl

6. This screen appears only if you selected **%Conc** in step 5. Choose **NaCl**, **NaOH**, **H2SO4**, or **HCl**. If you chose **H2SO4**, select **0-25%** or **96-999.7%**.

Cell Constant?
3.0000/cm

7. Enter the cell constant of the sensor. (This is only required in Quick Start if you chose **% Concentration**.)

Temperature in?
C F

8. Choose temperature units: **°C** or **°F**.

Enter Data Pts
Ref Temp Slope

9. If you selected **Custom**, you must enter the appropriate conductivity and concentration data points. From the main display, press MENU. Choose **Program** followed by **Measurement** and **Custom**. The screen shown at left appears. Select **Enter Data Pts**. Follow the prompts and enter the display units, the number of data points, and enter the concentration and conductivity data points. Enter the reference temperature and the temperature coefficient (slope). Once the analyzer has been configured, press EXIT. For a guide to the program menu, see the menu trees on pages 5 & 6.

Concentration
Units? % PPM none

10. To change output settings, to scale the 4-20 mA output, to change measurement-related settings from the default values, and to set security codes, press MENU. Select Program and follow the prompts. Refer to the menu tree on page 10.

11. To return the transmitter to default settings, choose **ResetAnalyzer** in the Program menu.

MODEL XMT-T TWO-WIRE CONDUCTIVITY TRANSMITTER

TABLE OF CONTENTS

Section	Title	Page
1.0	DESCRIPTION AND SPECIFICATIONS	1
1.1	Features and Applications.....	1
1.2	Specifications.....	2
1.3	Hazardous Location Approval.....	4
1.4	Menu Tree for Model Xmt-T-HT.....	5
1.5	Menu Tree for Model Xmt-T-FF.....	6
1.6	HART Communications.....	7
1.7	FOUNDATION Fieldbus.....	7
1.8	Asset Management Solutions.....	8
1.9	Ordering Information.....	10
1.10	Accessories.....	10
2.0	INSTALLATION	11
2.1	Unpacking and Inspection.....	11
2.2	Installation.....	11
3.0	WIRING.....	15
3.1	Power Supply / Current Loop — Model Xmt-T-HT.....	15
3.2	Power Supply Wiring for Model Xmt-T-FF.....	16
3.2	Sensor Wiring.....	17
4.0	INTRINSICALLY SAFE INSTALLATION.....	18
5.0	DISPLAY AND OPERATION	36
5.1	Display.....	36
5.2	Keypad.....	36
5.3	Programming and Calibrating the Model Xmt — Tutorial.....	37
5.4	Menu Trees.....	38
5.5	Diagnostic Messages.....	38
5.6	Security.....	41
5.7	Using Hold.....	41
6.0	OPERATION WITH MODEL 375.....	42
6.1	Note on Model 375 HART and Foundation Fieldbus Communicator.....	42
6.2	Connecting the HART and Foundation Fieldbus Communicator.....	42
6.3	Operation.....	43
7.0	CALIBRATION — TEMPERATURE.....	47
7.1	Introduction.....	47
7.2	Calibrating Temperature.....	47
8.0	CALIBRATION — CONDUCTIVITY	48
8.1	Introduction.....	48
8.2	Entering the Cell Constant.....	49
8.3	Zeroing the Instrument.....	50
8.4	Calibrating the Sensor in a Conductivity Standard.....	51
8.5	Calibrating the Temperature Slope.....	52

TABLE OF CONTENTS CONT'D

9.0	PROGRAMMING THE TRANSMITTER.....	53
9.1	General	53
9.2	Changing Start-up Settings	53
9.3	Configuring and Ranging the Output	54
9.4	Choosing and Configuring the Analytical Measurement	57
9.5	Choosing Temperature Units & Manual or Automatic Temperature Compensation ..	58
9.6	Setting a Security Code	59
9.7	Making HART-related Settings.....	60
9.8	Resetting Factory Calibration and Factory Default Settings	60
9.9	Selecting a Default Screen and Screen Contrast	61
10.0	MAINTENANCE	62
10.1	Overview	62
10.2	Replacement Parts	62
11.0	THEORY OF OPERATION	63
11.1	Conductivity / % Concentration.....	63
11.2	Temperature Correction	63
12.0	THEORY — REMOTE COMMUNICATIONS.....	65
12.1	Overview of HART Communications.....	65
12.2	HART Interface Devices.....	65
12.2	Asset Management Solutions	66
13.0	RETURN OF MATERIAL.....	67

LIST OF FIGURES

Number	Title	Page
1-1	Menu Tree — Xmt-T-HT	5
1-2	Menu Tree — Xmt-T-FF	6
1-3	Configuring Model XMT Transmitter with FOUNDATION Fieldbus	7
1-4	HART and FOUNDATION Fieldbus Communicators	8
1-5	AMS Main Menu Tools	9
2-1	Removing the Knockouts	11
2-2	Power Supply / Current Loop Wiring	11
2-3	Panel Mount Installation	12
2-4	Pipe Mount Installation	13
2-5	Surface Mount Installation	14
3-1	Load/Power Supply Requirements	15
3-2	Power Supply / Current Loop Wiring	15
3-3	Typical Fieldbus Network Electrical Wiring Configuration	16
3-4	Loop Power and Sensor Wiring	16
4-1	FM Intrinsically Safe Label for Model Xmt-T-HT	18
4-2	FM Intrinsically Safe Installation for Model Xmt-T-HT	19
4-3	CSA Intrinsically Safe Label for Model Xmt-T-HT	20
4-4	CSA Intrinsically Safe Installation for Model Xmt-T-HT	21
4-5	ATEX Intrinsically Safe Label for Model Xmt-T-HT	22
4-6	ATEX Intrinsically Safe Installation for Model Xmt-T-HT	23
4-7	FM Intrinsically Safe Label for Model Xmt-T-FF	24
4-8	FM Intrinsically Safe Installation for Model Xmt-T-FF	25
4-9	CSA Intrinsically Safe Label for Model Xmt-T-FF	26
4-10	CSA Intrinsically Safe Installation for Model Xmt-T-FF	27
4-11	ATEX Intrinsically Safe Label for Model Xmt-T-FF	28
4-12	ATEX Intrinsically Safe Installation for Model Xmt-T-FF	29
4-13	FM Intrinsically Safe Label for Model Xmt-T-FI	30
4-14	FM Intrinsically Safe Installation for Model Xmt-T-FI	31
4-15	CSA Intrinsically Safe Label for Model Xmt-T-FI	32
4-16	CSA Intrinsically Safe Installation for Model Xmt-T-FI	33
4-17	ATEX Intrinsically Safe Label for Model Xmt-T-FI	34
4-18	ATEX Intrinsically Safe Installation for Model Xmt-T-FI	35
5-1	Displays During Normal Operation	36
5-2	Solu Comp Xmt Keypad	36
5-3	Menu Tree for Model Xmt-T-HT	39
5-4	Menu Tree for Model Xmt-T-FF	40
6-1	Connecting the Model 375 Communicator	42
6-2	Xmt-T-HT HART / Model 375 Menu Tree	44
12-1	HART Communicators	65
12-2	AMS Main Menu Tools	66

LIST OF TABLES

Table	Title	Page
3-1	Model Xmt-T Sensor Selection	17

SECTION 1.0 DESCRIPTION AND SPECIFICATIONS

Model Xmt Family of Two-wire Transmitters

- CHOICE OF COMMUNICATION PROTOCOLS: HART® or FOUNDATION® Fieldbus
- CLEAR, EASY-TO-READ two-line display shows commissioning menus and process measurement displays in English
- SIMPLE TO USE MENU STRUCTURE
- CHOICE OF PANEL OR PIPE/SURFACE MOUNTING
- NON-VOLATILE MEMORY retains program settings and calibration data during power failures
- SIX LOCAL LANGUAGES - English, French, German, Italian, Spanish and Portuguese



1.1 FEATURES AND APPLICATIONS

The Solu Comp Model Xmt family of transmitters can be used to measure pH, ORP, conductivity (using either contacting or toroidal sensors), resistivity, oxygen (ppm and ppb level), free chlorine, total chlorine, monochloramine and ozone in a variety of process liquids. The Xmt is compatible with most Rosemount Analytical sensors. See the Specification sections for details.

The transmitter has a rugged, weatherproof, corrosion-resistant enclosure (NEMA 4X and IP65). The panel mount version fits standard ½ DIN panel cutouts, and its shallow depth is ideally suited for easy mounting in cabinet-type enclosures. A panel mount gasket is included to maintain the weather rating of the panel. Surface/pipe mount enclosure includes self-tapping screws for surface mounting. A pipe mounting accessory kit is available for mounting to a 2-inch pipe.

The transmitter has a two-line 16-character display. Menu screens for calibrating and registering choices are simple and intuitive. Plain language prompts guide the user through the procedures. There are no service codes to enter before gaining access to menus.

Two digital communication protocols are available: HART (model option -HT) and FOUNDATION fieldbus (model option -FF or -FI). Digital communications allow access to AMS (Asset Management Solutions). Use AMS to set up and configure the transmitter, read process variables, and troubleshoot problems from a personal computer or host anywhere in the plant.

The seven-button membrane-type keypad allows local programming and calibrating of the transmitter. The HART Model 375 communicator can also be used for programming and calibrating the transmitter.

The Model Xmt-T Transmitter with the appropriate sensor

measures dissolved oxygen (ppm and ppb level), free chlorine, total chlorine, monochloramine, and ozone in water and aqueous solutions. The transmitter is compatible with Rosemount Analytical 499A amperometric sensors for oxygen, chlorine, monochloramine, and ozone; and with Hx438, Bx438, and Gx448 steam-sterilizable oxygen sensors.

For free chlorine measurements, both automatic and manual pH correction are available. pH correction is necessary because amperometric free chlorine sensors respond only to hypochlorous acid, not free chlorine, which is the sum of hypochlorous acid and hypochlorite ion. To measure free chlorine, most competing instruments require an acidified sample. Acid lowers the pH and converts hypochlorite ion to hypochlorous acid. The Model Xmt-T eliminates the need for messy and expensive sample conditioning by measuring the sample pH and using it to correct the chlorine sensor signal. If the pH is relatively constant, a fixed pH correction can be used, and the pH measurement is not necessary. If the pH is greater than 7.0 and fluctuates more than about 0.2 units, continuous measurement of pH and automatic pH correction is necessary. See Specifications section for recommended pH sensors. Corrections are valid to pH 9.5.

The transmitter fully compensates oxygen, ozone, free chlorine, total chlorine, and monochloramine readings for changes in membrane permeability caused by temperature changes.

For pH measurements — pH is available with free chlorine only — the Xmt-T features automatic buffer recognition and stabilization check. Buffer pH and temperature data for commonly used buffers are stored in the transmitter. Glass impedance diagnostics warn the user of an aging or failed pH sensor.

1.2 SPECIFICATIONS

1.2.1 GENERAL SPECIFICATIONS

Case: ABS (panel mount), polycarbonate (pipe/wall mount); NEMA 4X/CSA 4 (IP65)

Dimensions

Panel (code -10): 6.10 x 6.10 x 3.72 in. (155 x 155 x 94.5 mm)

Surface/Pipe (code -11): 6.23 x 6.23 x 3.23 in. (158 x 158 x 82 mm); see page 15 for dimensions of pipe mounting bracket.

Conduit openings: Accepts PG13.5 or 1/2 in. conduit fittings

Ambient Temperature: 32 to 122°F (0 to 50°C). Some degradation of display above 50°C.

Storage Temperature: -4 to 158°F (-20 to 70°C)

Relative Humidity: 10 to 90% (non-condensing)

Weight/Shipping Weight: 2 lb/3 lb (1 kg/1.5 kg)

Display: Two line, 16-character display. Character height: 4.8 mm; first line shows process variable, second line shows process temperature and output current. Fault and warning messages, when triggered, alternate with temperature and output readings.

During calibration and programming, messages, prompts, and editable values appear on the two-line display.

Temperature resolution: 0.1°C ($\leq 99.9^\circ\text{C}$);
1°C ($\geq 100^\circ\text{C}$)

Hazardous Location Approval: For details, see specifications for the measurement of interest.

RFI/EMI: EN-61326 

Solu Comp is a registered trademark of Rosemount Analytical.

Xmt is a trademark of Rosemount Analytical.

HART is a registered trademark of the HART Communication Foundation.

FOUNDATION is a registered trademark of Fieldbus Foundation.

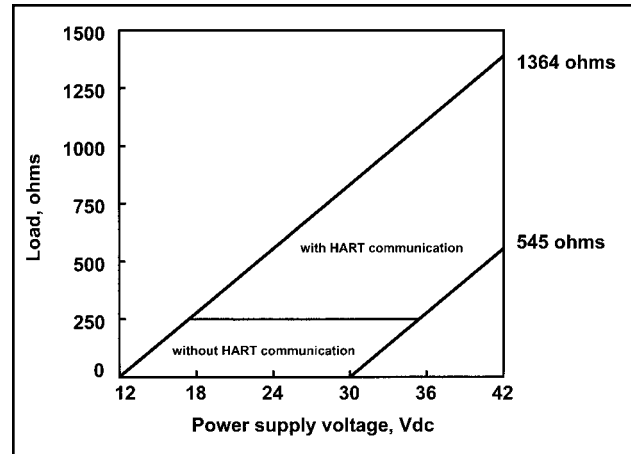

DIGITAL COMMUNICATIONS:

HART —

Power & Load Requirements: Supply voltage at the transmitter terminals should be at least 12 Vdc. Power supply voltage should cover the voltage drop on the cable plus the external load resistor required for HART communications (250 Ω minimum). Minimum power supply voltage is 12 Vdc. Maximum power supply voltage is 42.4 Vdc. The graph shows the supply voltage required to maintain 12 Vdc (upper line) and 30 Vdc (lower line) at the transmitter terminals when the current is 22 mA.

Analog Output: Two-wire, 4-20 mA output with superimposed HART digital signal. Fully scalable over the operating range of the sensor.

Output accuracy: ± 0.05 mA

FOUNDATION FIELDBUS —

Power & Load Requirements: A power supply voltage of 9-32 Vdc at 13 mA is required.

Fieldbus Intrinsically Safe **CO**ncept/FISCO-compliant versions of Model Xmt Foundation Fieldbus transmitters are available.

1.2.2 FUNCTIONAL SPECIFICATIONS**Automatic Temperature Compensation:**

3-wire Pt 100 RTD or Pt 1000 RTD

Conductivity: 0 to 200°C (32 to 392°F)

% Concentration: 0 to 100°C (32 to 212°F)

Diagnostics: The internal diagnostics can detect:

Calibration Error ROM Failure

Temperature Slope Error Zero Error

High Temperature Warning CPU Failure

Low Temperature Warning Input Warning

Once one of the above is diagnosed, the LCD will display a message describing the problem.

Digital Communications:

HART: PV, SV, and TV assignable to measurement (conductivity, resistivity, or concentration), temperature, and raw conductivity. Raw conductivity is measured conductivity before temperature correction.

Fieldbus: Three AI blocks assignable to measurement (conductivity, resistivity, or concentration), temperature, and raw conductivity. Raw conductivity is measured conductivity before temperature correction. Execution time 75 msec. One PID block; execution time 150 msec. Device type: 4084. Device revision: 1. Certified to ITK 4.5.

1.2.3 TRANSMITTER SPECIFICATIONS @ 25°C**Measured Range:** 50 to 2,000,000 µS/cm (see chart)**Repeatability:** ± 0.25% of reading**Temperature Accuracy:**

± 0.2°C between 0 and 50°C

± 0.5°C above 50°C

(excludes inaccuracies in sensor)

Temperature Slope Adjustment: 0-5%/° C**% Concentration Ranges:**

Sodium Hydroxide: 0 to 12%

Hydrochloric Acid: 0 to 15%

Sulfuric Acid: 0 to 25% and 96.0 to 99.7%

Sodium Chloride: 0 to 20%

Ambient Temperature Coefficient:

± 0.1% of reading ±2µS/cm per °C

Maximum Cable Length: 100 ft (30 m)**1.2.4 LOOP SPECIFICATIONS**

Loop Accuracy: With a standard Model 228 or 225 sensor with 20' cable, following a single point calibration, laboratory accuracy at 25°C can be as good as ±2% of reading and ±50 µS/cm.

For optimum performance, standardize the sensor in the process at the conductivity and temperature of interest.

Results under real process conditions, at different temperatures, or using other sensors may differ from above.

Calibration: Calibrate against previously calibrated standard sensor and analyzer, or calibrate against solution of known conductivity.

RECOMMENDED SENSORS:

Model 222 Flow-Through

Model 225 Clean-In-Place (CIP)

Model 226 Submersion/Insertion

Model 228 Submersion/Insertion/Retractable

Model 242 Flow-Through

Model 245 Sanitary Flow-Through

Model 247 Submersion/Flow-Tee

1.3 HAZARDOUS LOCATION APPROVALS**Intrinsic Safety:**

Class I, II, III, Div. 1
Groups A-G
T4 Tamb = 50°C



Class I, II, III, Div. 1
Groups A-G
T4 Tamb = 50°C

ATEX

CE 1180



II 1 G
Baseefa04ATEX0215X
EEx ia IIC T4
Tamb = 0°C to 50°C

Non-Incendive:

Class I, Div. 2, Groups A-D
Dust Ignition Proof
Class II & III, Div. 1, Groups E-G
NEMA 4/4X Enclosure



Class I, Div. 2, Groups A-D
Dust Ignition Proof
Class II & III, Div. 1, Groups E-G
NEMA 4/4X Enclosure
T4 Tamb = 50°C

1.4 MENU TREE FOR MODEL Xmt-T-HT

FIGURE 1-1. MENU TREE FOR MODEL SOLU COMP XMT-T-HT TRANSMITTER

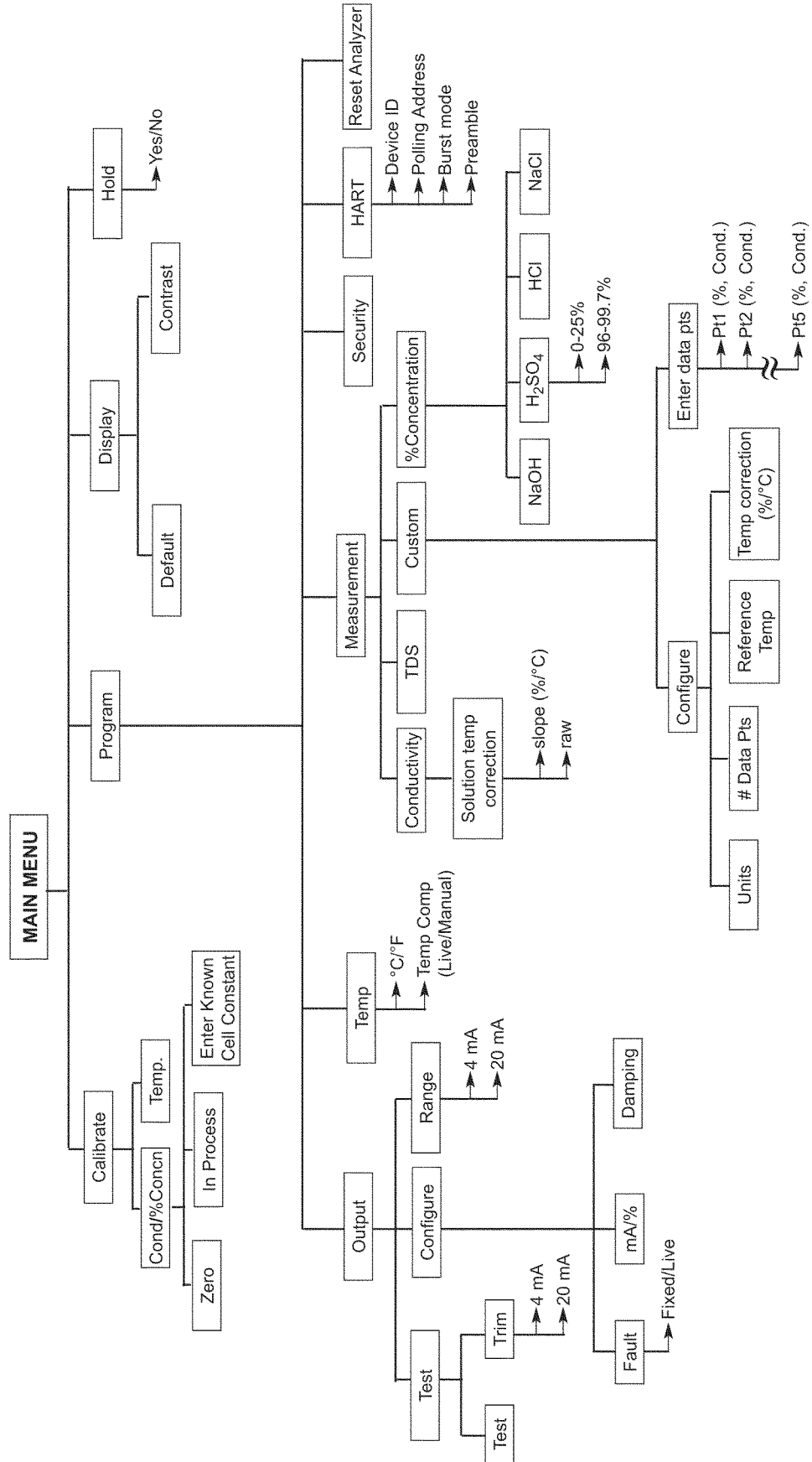

1.5 MENU TREE FOR MODEL Xmt-T-FF

FIGURE 1-2. MENU TREE FOR MODEL SOLU COMP XMT-T-FF TRANSMITTER

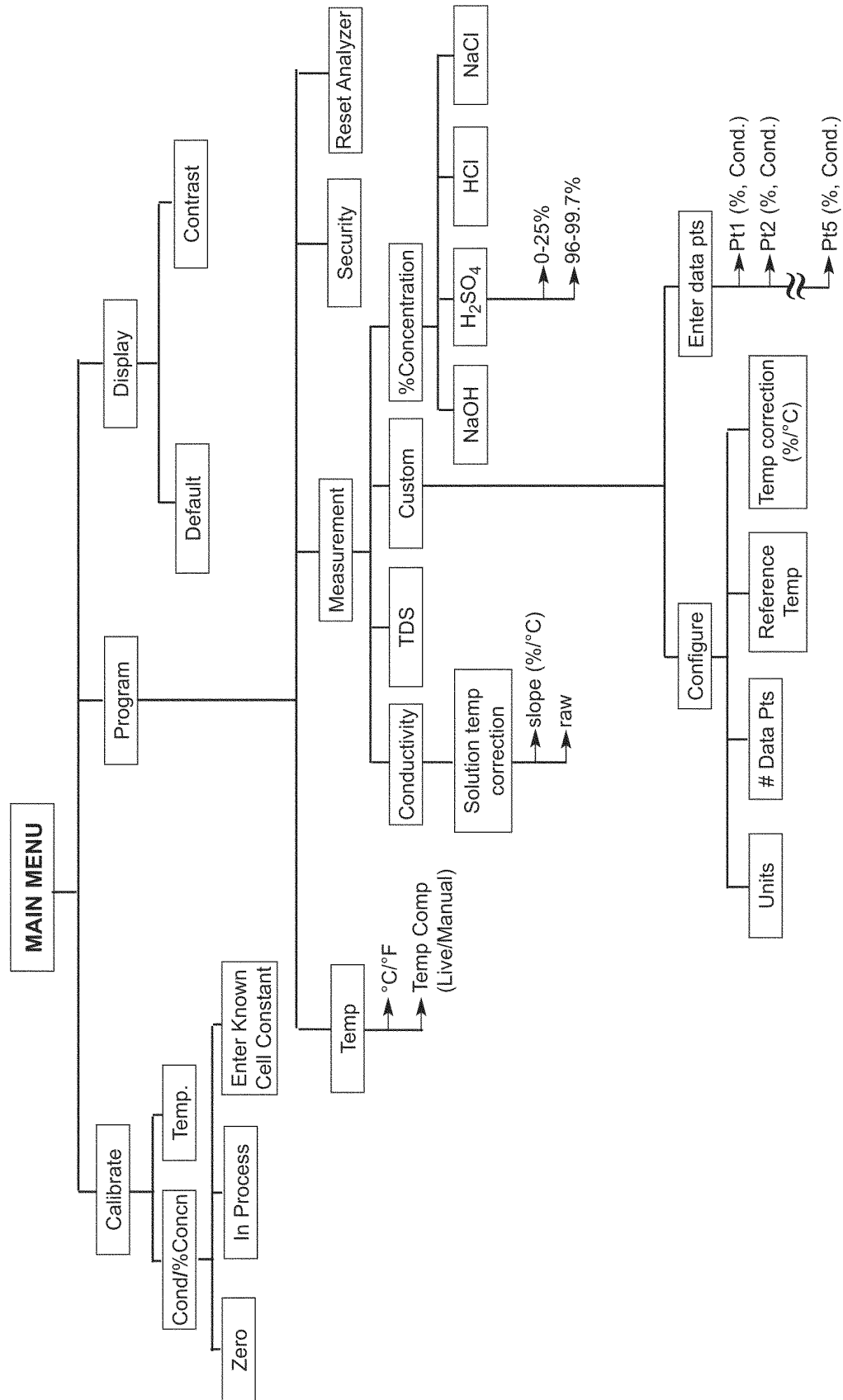

1.6 HART COMMUNICATIONS

1.6.1 OVERVIEW OF HART COMMUNICATION

HART (highway addressable remote transducer) is a digital communication system in which two frequencies are superimposed on the 4 to 20 mA output signal from the transmitter. A 1200 Hz sine wave represents the digit 1, and a 2400 Hz sine wave represents the digit 0. Because the average value of a sine wave is zero, the digital signal adds no dc component to the analog signal. HART permits digital communication while retaining the analog signal for process control.

The HART protocol, originally developed by Fisher-Rosemount, is now overseen by the independent HART Communication Foundation. The Foundation ensures that all HART devices can communicate with one another. For more information about HART communications, call the HART Communication Foundation at (512) 794-0369. The internet address is <http://www.hartcomm.org>.

1.6.2 HART INTERFACE DEVICES

The Model 375 HART Communicator is a hand-held device that provides a common link to all HART SMART instruments and allows access to AMS (Asset Management Solutions). Use the HART communicator to set up and control the Xmt-T-HT and to read measured variables. Press ON to display the on-line menu. All setup menus are available through this menu.

HART communicators allow the user to view measurement data (conductivity, TDS, % concentration, and temperature), program the transmitter, and download information from the transmitter for transfer to a computer for analysis. Downloaded information can also be sent to another HART transmitter. Either a hand-held communicator, such as the Rosemount Model 375, or a computer can be used. HART interface devices operate from any wiring termination point in the 4 - 20 mA loop. A minimum load of 250 ohms must be present between the transmitter and the power supply. See Figure 1-4.

If your communicator does not recognize the Model Xmt-T transmitter, the device description library may need updating. Call the manufacturer of your HART communication device for updates.

1.7 FOUNDATION FIELDBUS

Figure 1-3 shows a Xmt-T-FF being used to measure conductivity. The figure also shows three ways in which Fieldbus communication can be used to read process variables and configure the transmitter.

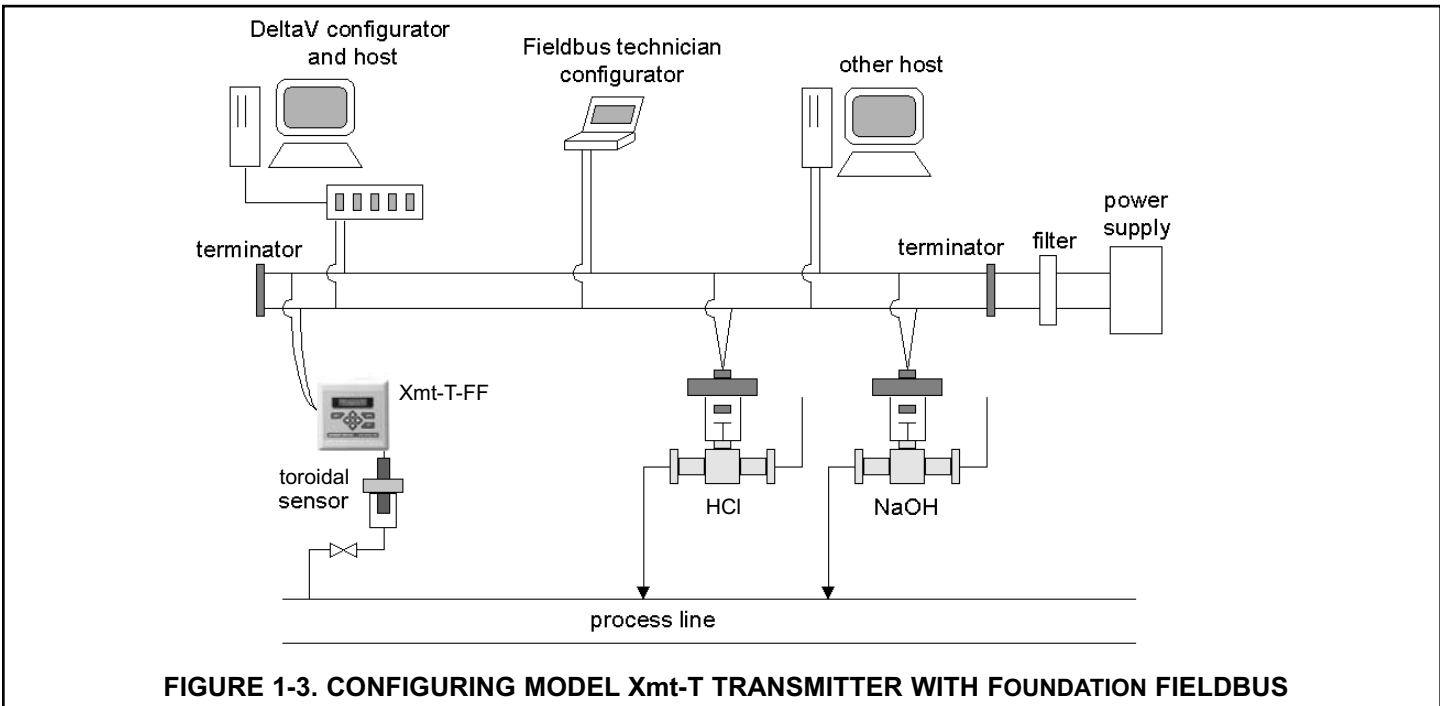

FIGURE 1-3. CONFIGURING MODEL Xmt-T TRANSMITTER WITH FOUNDATION FIELDBUS

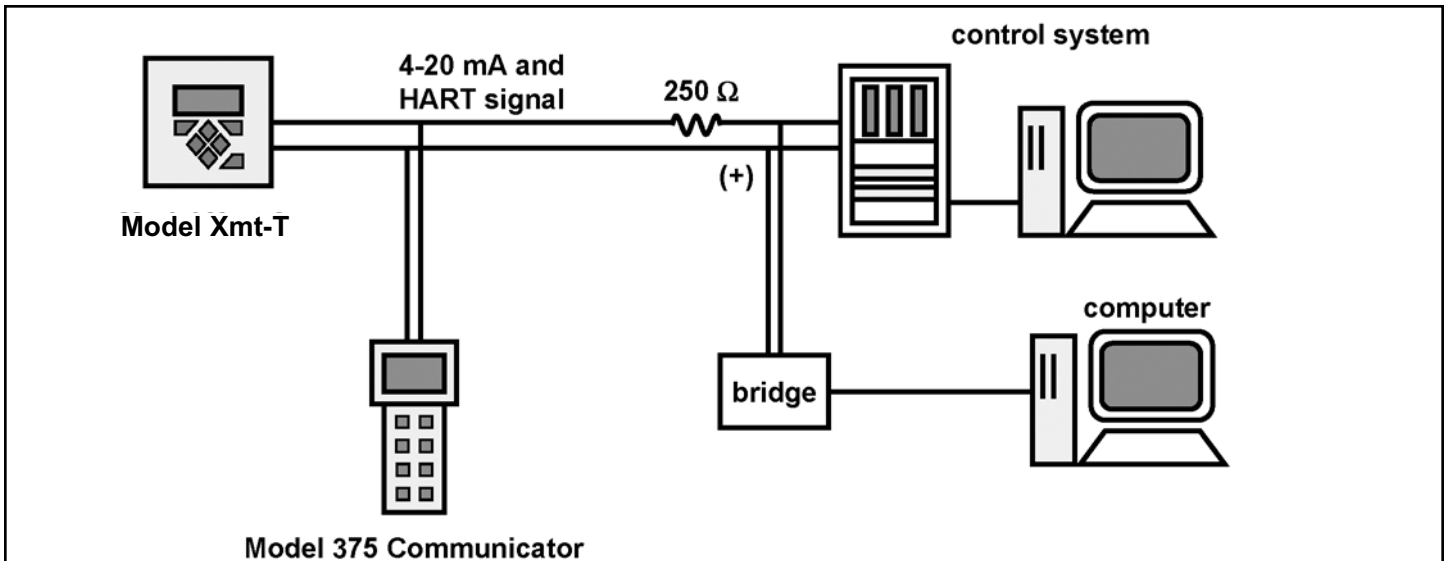

FIGURE 1-4. HART and FOUNDATION™ Fieldbus Communicators.

Both the Rosemount Model 375 (or 275) and a computer can be used to communicate with a HART transmitter. The 250 ohm load (minimum) must be present between the transmitter and the power supply.

1.8 ASSET MANAGEMENT SOLUTIONS

Asset Management Solutions (AMS) is software that helps plant personnel better monitor the performance of analytical instruments, pressure and temperature transmitters, and control valves. Continuous monitoring means maintenance personnel can anticipate equipment failures and plan preventative measures before costly breakdown maintenance is required.

AMS uses remote monitoring. The operator, sitting at a computer, can view measurement data, change program settings, read diagnostic and warning messages, and retrieve historical data from any HART-compatible device, including the Model Xmt-T transmitter. Although AMS allows access to the basic functions of any HART compatible device, Rosemount Analytical has developed additional software for that allows access to all features of the Model Xmt-T transmitter.

AMS can play a central role in plant quality assurance and quality control. Using AMS Audit Trail, plant operators can track calibration frequency and results as well as warnings and diagnostic messages. The information is available to Audit Trail whether calibrations were done using the infrared remote transmitter, the Model 375 HART communicator, or AMS software.

AMS operates in Windows 2000, NT, and XP operating systems. See Figure 1-5 for a sample screen. AMS communicates through a HART-compatible modem with any HART transmitters, including those from other manufacturers. AMS is also compatible with FOUNDATION Fieldbus, which allows future upgrades to Fieldbus instruments.

Rosemount Analytical AMS windows provide access to all transmitter measurement and configuration variables. The user can read raw data, final data, and program settings and can reconfigure the transmitter from anywhere in the plant.

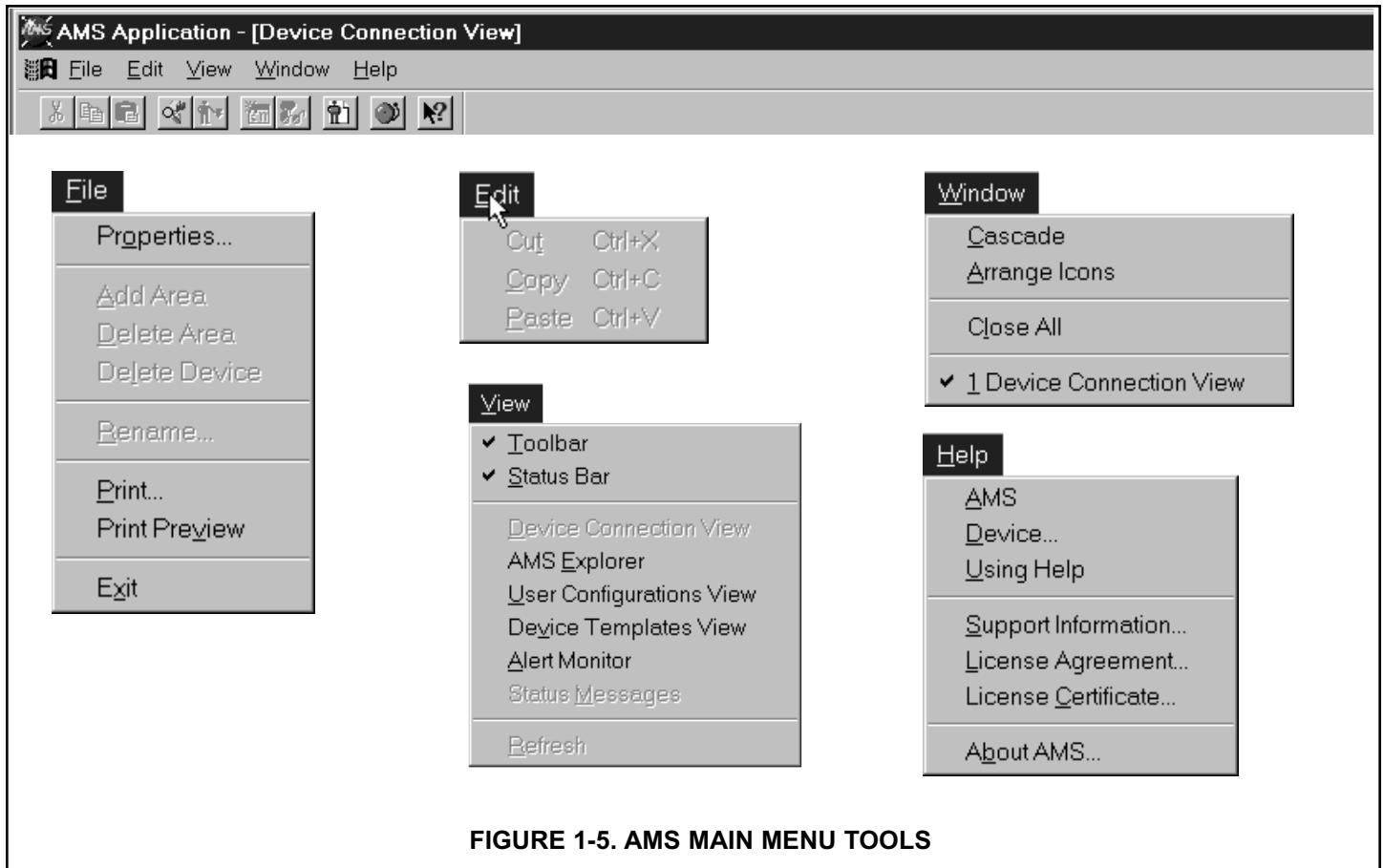

1.9 ORDERING INFORMATION

The **Solu Comp Model Xmt-T Two-Wire Transmitter** is intended for conductivity and % concentration measurements using toroidal (inductive) conductivity sensors.

MODEL	
Xmt	SMART TWO-WIRE MICROPROCESSOR TRANSMITTER
CODE	REQUIRED SELECTION
P	pH/ORP
CODE	REQUIRED SELECTION
HT	Analog 4-20 mA output with superimposed HART digital signal
FF	Foundation fieldbus digital output
FI	Foundation fieldbus digital output with FISCO
CODE	REQUIRED SELECTION
10	Panel mounting enclosure
11	Pipe/Surface mounting enclosure (pipe mounting requires accessory kit PN 23820-00)
CODE	AGENCY APPROVALS
60	No approval
67	FM approved intrinsically safe and non-incendive (when used with appropriate sensor and safety barrier)
69	CSA approved intrinsically safe and non-incendive (when used with appropriate sensor and safety barrier)
73	ATEX approved intrinsically safe (when used with appropriate sensor and safety barrier)
Xmt-P-HT-10-67 EXAMPLE	

1.10 ACCESSORIES

POWER SUPPLY: Use the Model 515 Power Supply to provide dc loop power to the transmitter. The Model 515 provides two isolated sources at 24Vdc and 200 mA each. For more information refer to product data sheet 71-515.

ALARM MODULE: The Model 230A alarm Module receives the 4-20 mA signal from the Xmt-T-HT transmitter and activates two alarm relays. High/high, low/low, and high/low are available. Hysteresis (deadband) is also adjustable. For more information, refer to product data sheet 71-230A.

HART COMMUNICATOR: The Model 375 HART communicator allows the user to view measurement values as well as to program and configure the transmitter. The Model 375 attaches to any wiring terminal across the output loop. A minimum 250 Ω load must be between the power supply and transmitter. Order the Model 375 communicator from Emerson Process Management. Call (800) 999-9307.

ACCESSORIES

MODEL/PN	DESCRIPTION
515	DC loop power supply (see product data sheet 71-515)
230A	Alarm module (see product data sheet 71-230A)
23820-00	2-in. pipe mounting kit
9240048-00	Stainless steel tag, specify marking
23554-00	Gland fittings PG 13.5, 5 per package

SECTION 2.0 INSTALLATION

2.1 Unpacking and Inspection

2.2 Installation

2.1 UNPACKING AND INSPECTION

Inspect the shipping container. If it is damaged, contact the shipper immediately for instructions. Save the box. If there is no apparent damage, remove the transmitter. Be sure all items shown on the packing list are present. If items are missing, immediately notify Rosemount Analytical.

Save the shipping container and packaging. They can be reused if it is later necessary to return the transmitter to the factory.

2.2 INSTALLATION

1. Although the transmitter is suitable for outdoor use, do not install it in direct sunlight or in areas of extreme temperatures.
2. Install the transmitter in an area where vibrations and electromagnetic and radio frequency interference are minimized or absent.
3. Keep the transmitter and sensor wiring at least one foot from high voltage conductors. Be sure there is easy access to the transmitter.
4. The transmitter is suitable for panel (Figure 2-3), pipe (Figure 2-4), or surface (Figure 2-5) mounting.
5. The transmitter case has two 1/2-inch (PG13.5) conduit openings and either three or four 1/2-inch knockouts. The panel mount Xmt-T-HT has four knockouts. The pipe/surface mount transmitter has three knockouts*. One conduit opening is for the power/output cable; the other opening is for the sensor cable.

Figure 1 shows how to remove a knockout. The knockout grooves are on the outside of the case. Place the screwdriver blade on the inside of the case and align it approximately along the groove. Rap the screwdriver sharply with a hammer until the groove cracks. Move the screwdriver to an uncracked portion of the groove and continue the process until the knockout falls out. Use a small knife to remove the flash from the inside of the hole.

6. Use weathertight cable glands to keep moisture out to the transmitter. If conduit is used, plug and seal the connections at the transmitter housing to prevent moisture from getting inside the instrument.
7. To reduce the likelihood of stress on wiring connections, do not remove the hinged front panel (-11 models) from the base during wiring installation. Allow sufficient wire leads to avoid stress on conductors.

*NEMA plug may be supplied instead of knockout for pipe/surface version.

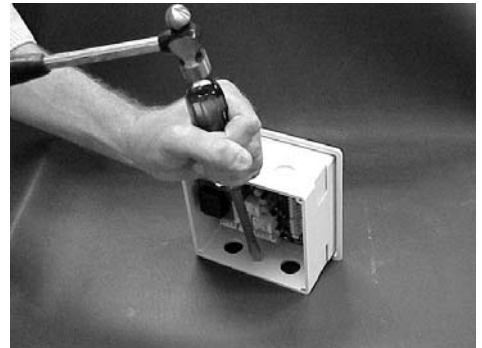

FIGURE 2-1. Removing the Knockouts

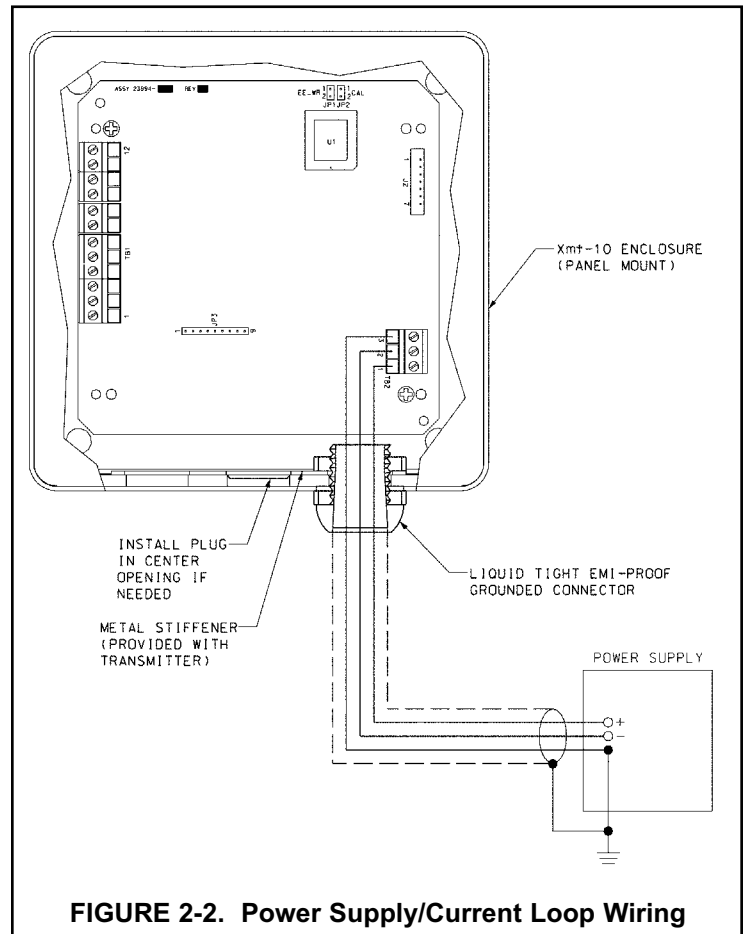

FIGURE 2-2. Power Supply/Current Loop Wiring

Panel Mounting.

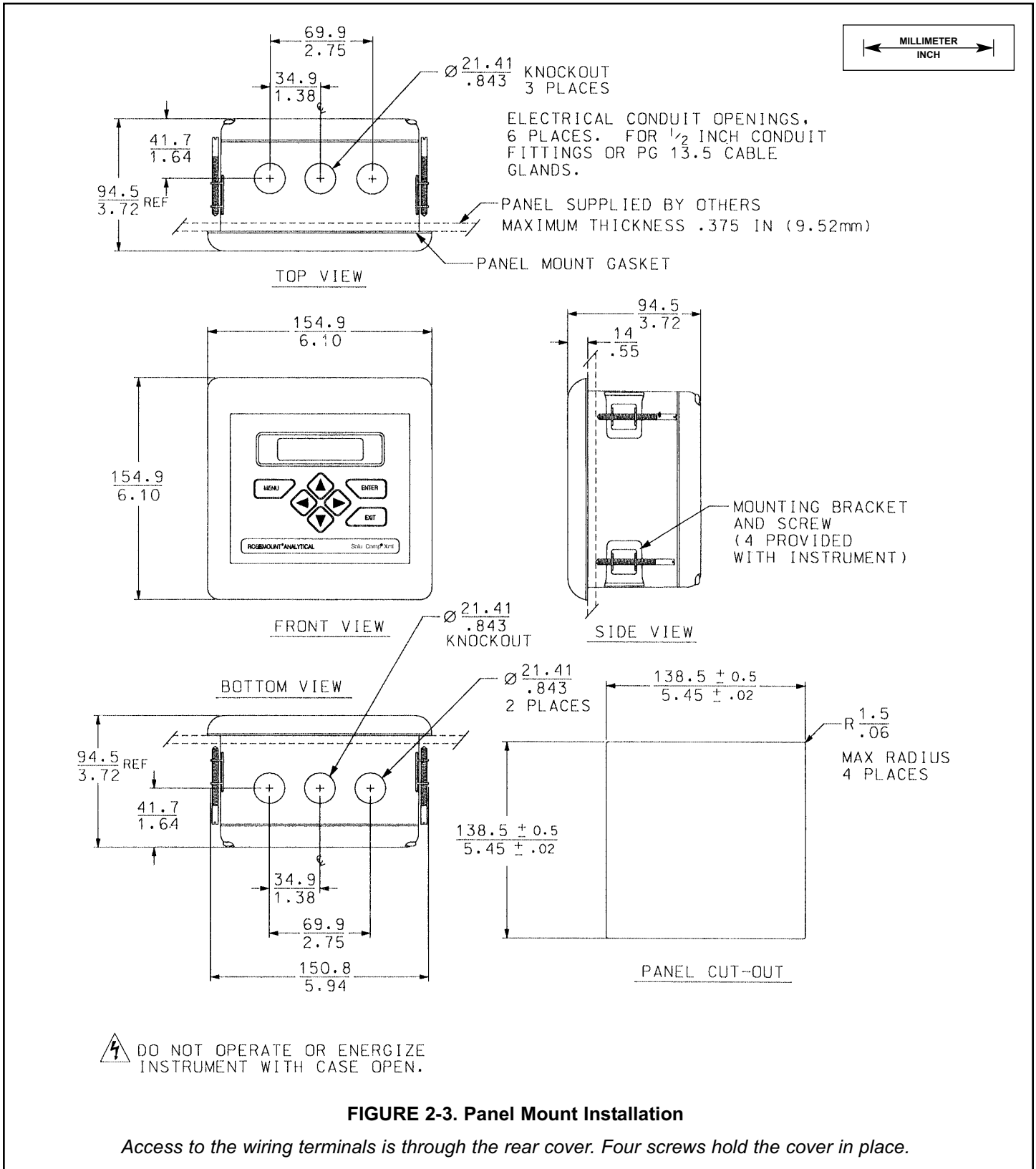
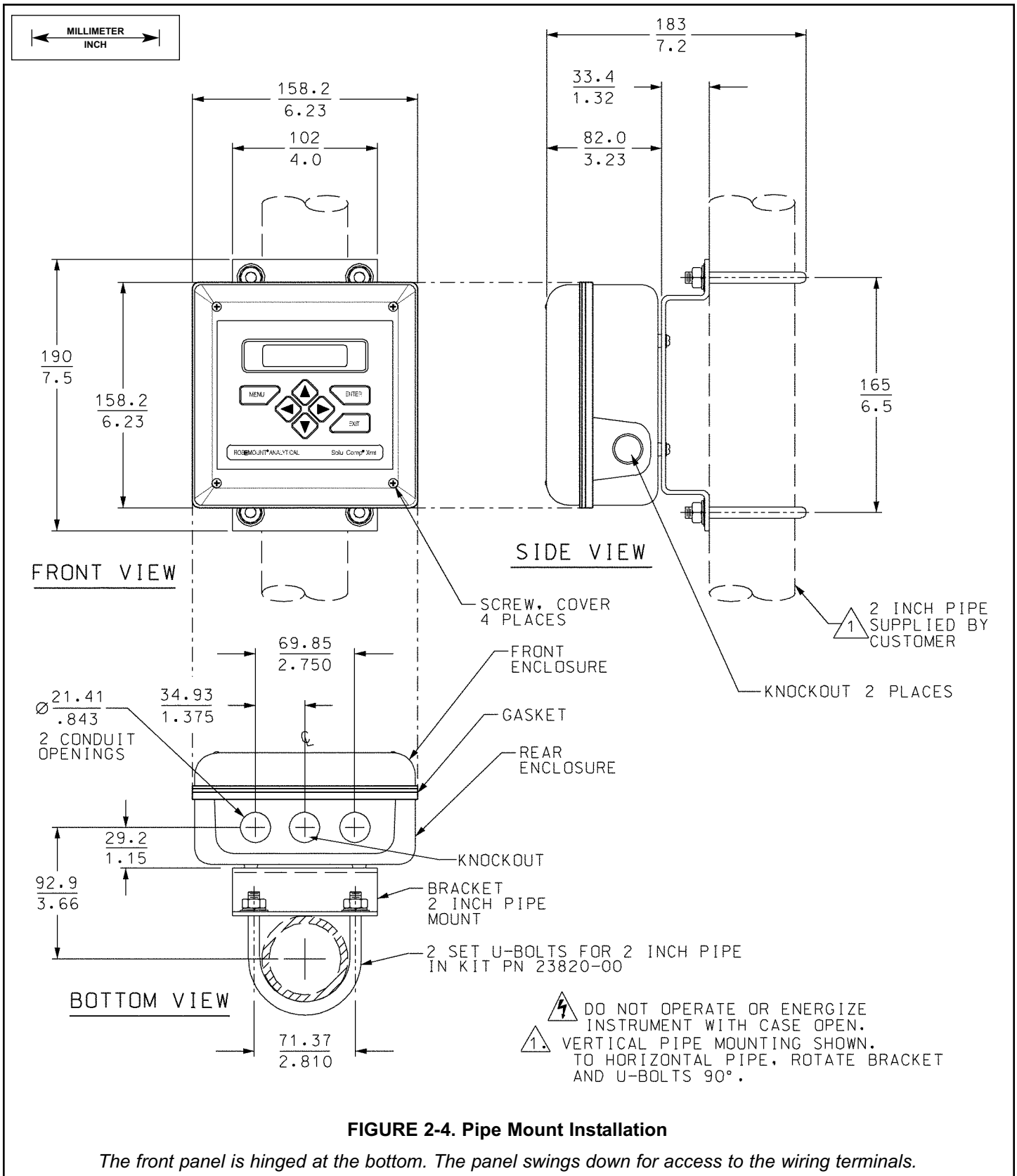

FIGURE 2-3. Panel Mount Installation

Access to the wiring terminals is through the rear cover. Four screws hold the cover in place.

Pipe Mounting.



Surface Mounting.

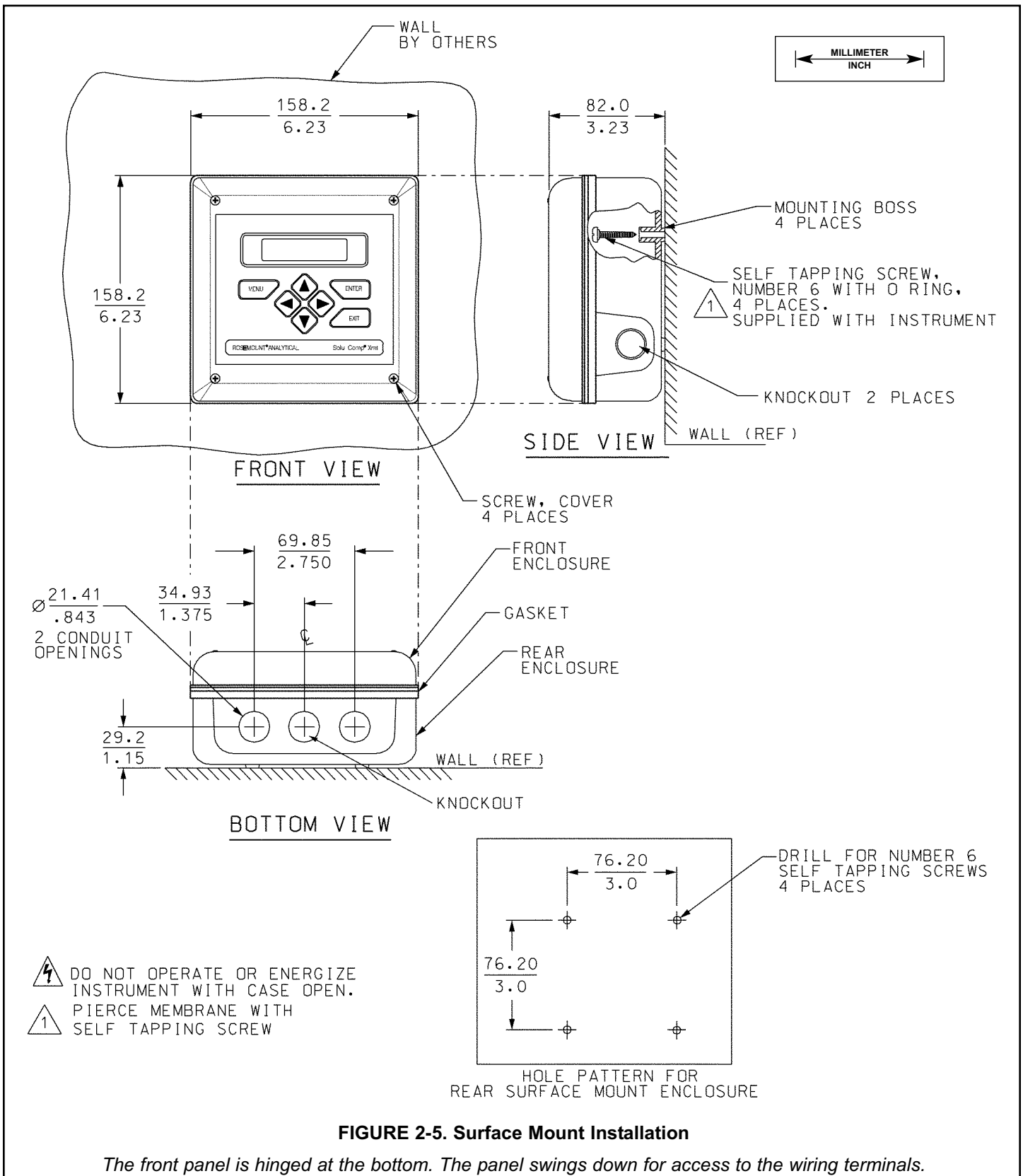

FIGURE 2-5. Surface Mount Installation

The front panel is hinged at the bottom. The panel swings down for access to the wiring terminals.

SECTION 3.0 WIRING

3.1 POWER SUPPLY/CURRENT LOOP — MODEL Xmt-T-HT

3.1.1 Power Supply and Load Requirements.

Refer to Figure 3-1.

The supply voltage must be at least 12.0 Vdc at the transmitter terminals. The power supply must be able to cover the voltage drop on the cable as well as the load resistor (250 Ω minimum) required for HART communications. The maximum power supply voltage is 42.0 Vdc. For intrinsically safe installations, the maximum power supply voltage is 30.0 Vdc. The graph shows load and power supply requirements. The upper line is the power supply voltage needed to provide 12 Vdc at the transmitter terminals for a 22 mA current. The lower line is the power supply voltage needed to provide 30 Vdc for a 22 mA current.

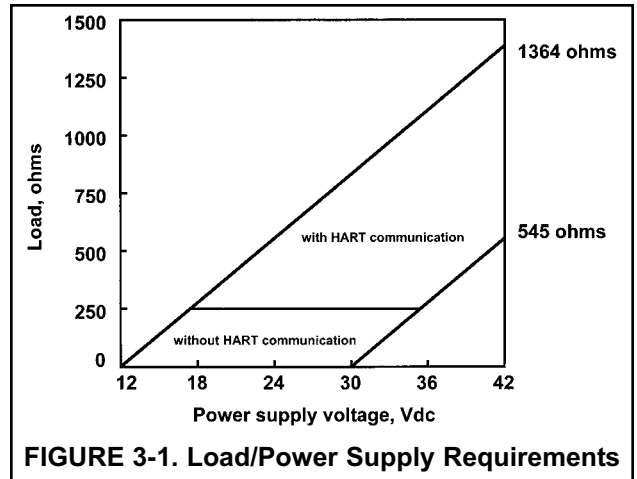

FIGURE 3-1. Load/Power Supply Requirements

The power supply must provide a surge current during the first 80 milliseconds of startup. The maximum current is about 24 mA.

For digital communications, the load must be at least 250 ohms. To supply the 12.0 Vdc lift off voltage at the transmitter, the power supply voltage must be at least 17.5 Vdc.

3.1.2 Power Supply-Current Loop Wiring.

For general purpose areas, wire power as shown in Figure 3-2. For hazardous areas, please see hazardous area installation drawings.

Run the power/signal wiring through the opening nearest TB-2.

For optimum EMI/RFI protection . . .

1. Use shielded power/signal cable and ground the shield at the power supply.
2. Use a metal cable gland and be sure the shield makes good electrical contact with the gland.
3. Use the metal backing plate when attaching the gland to transmitter enclosure.

The power/signal cable can also be enclosed in an earth-grounded metal conduit.

Do not run power supply/signal wiring in the same conduit or cable tray with AC power lines or with relay actuated signal cables. Keep power supply/signal wiring at least 6 ft (2 m) away from heavy electrical equipment.

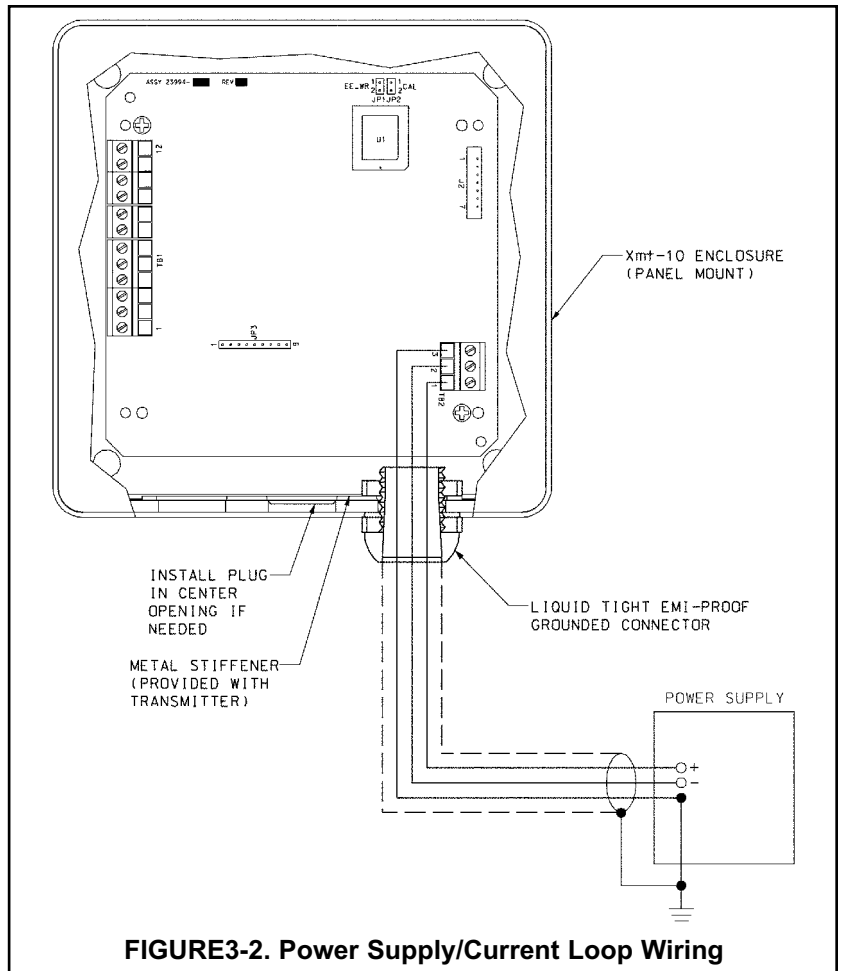

FIGURE 3-2. Power Supply/Current Loop Wiring

3.2 POWER SUPPLY WIRING FOR MODEL Xmt-T-FF

3.2.1 Power Supply Wiring. For general purpose areas, wire power as shown in Figure 3-4. For hazardous areas, please see hazardous area installation drawings. Refer to Figure 3-3 and Figure 3-4.

Run the power/signal wiring through the opening nearest TB2. Use shielded cable and ground the shield at the power supply. To ground the transmitter, attach the shield to TB2-3.

NOTE

For optimum EMI/RFI immunity, the power supply/output cable should be shielded and enclosed in an earth-grounded metal conduit.

Do not run power supply/signal wiring in the same conduit or cable tray with AC power lines or with relay actuated signal cables. Keep power supply/signal wiring at least 6 ft (2 m) away from heavy electrical equipment.

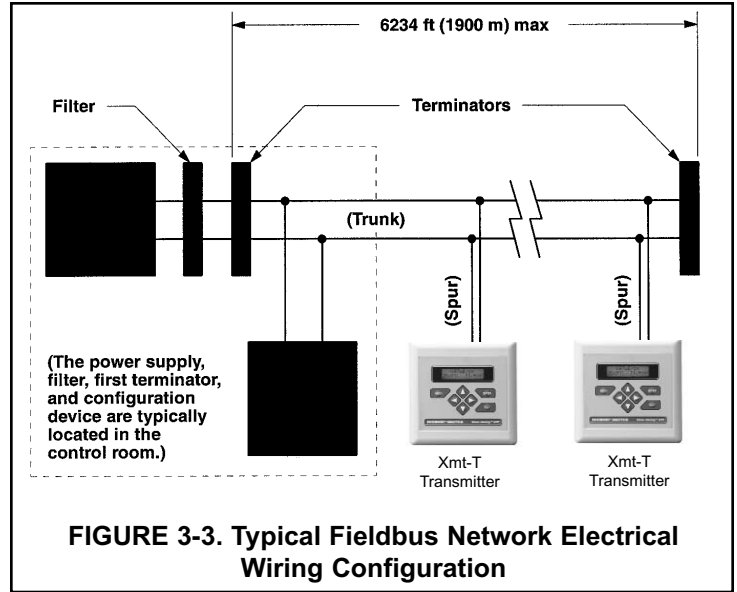

FIGURE 3-3. Typical Fieldbus Network Electrical Wiring Configuration

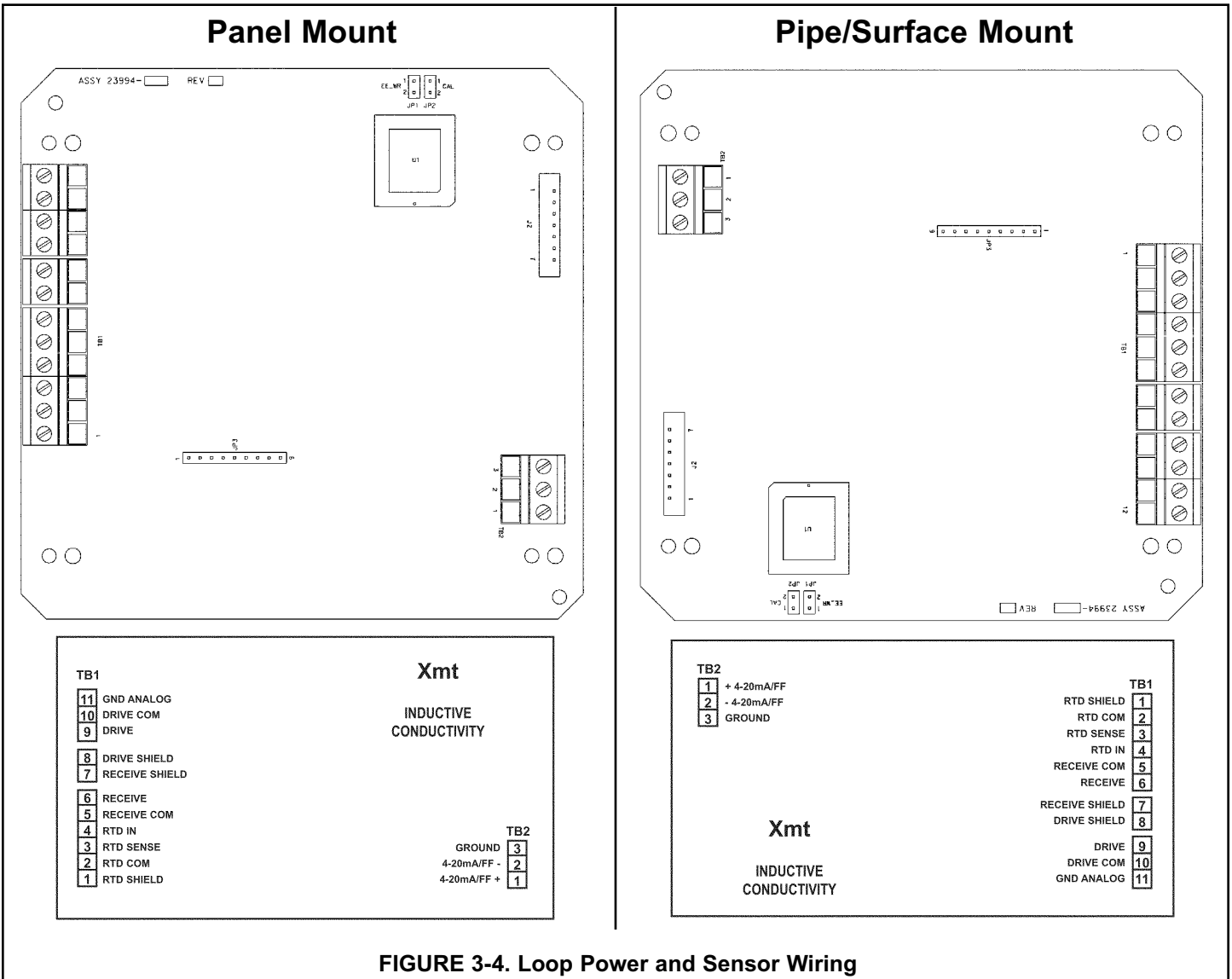

FIGURE 3-4. Loop Power and Sensor Wiring

3.3 SENSOR WIRING

Keep sensor wiring separate from power wiring. For best EMI/RFI protection, use shielded output signal cable in an earth-grounded metal conduit. See Figure 3-4. Refer to the Instruction Sheet provided with each sensor for specific wiring instructions.

3.1.1 WIRING THROUGH A JUNCTION BOX

The sensor can be wired to the analyzer through a remote junction box (PN 23550-00). Wire the extension cable and sensor cable point-to-point. See Figure 3-4. Refer to the sensor instruction manual for more details.

Factory-terminated (PN 23294-05) and unterminated (PN 9200276) connecting cable are available. The use of factory-terminated cable is strongly recommended. To prepare unterminated cable for use, follow the instructions in the sensor instruction manual.

For maximum EMI/RFI protection, the outer braid of the sensor cable should be connected to the outer braided shield of the extension cable. At the instrument, connect the outer braid of the extension cable to earth ground.

3.1.2 SENSOR SELECTION

All Rosemount Analytical toroidal conductivity sensors with PT100 RTD or PT1000 RTD are compatible with the Model Xmt-T transmitter. Refer to the Instruction Sheet provided with each sensor for specific wiring instructions.

Choose a toroidal conductivity sensor that is appropriate for your process conditions and range of conductivity measurement.

TABLE 3-1. Model Xmt-T Sensor Selection

RECOMMENDED RANGES FOR TOROIDAL SENSORS								
Conductivity Sensor Model	226	228	225	222 (1in.)	222 (2 in.)	242	245	247
Nominal Cell Constant	1.0	3.0	3.0	6.0	4.0	*	*	3.5
Minimum Conductivity ($\mu\text{S/cm}$)	50	200	200	500	500	100*	100*	500
Maximum Conductivity ($\mu\text{S/cm}$)	1,000,000	2,000,000	2,000,000	2,000,000	2,000,000	2,000,000*	2,000,000	2,000,000

* Model 242 values depend on sensor configuration and wiring.

Values shown are for 25°C conductivity with a temperature slope of 2% per degree C. The maximum range value will be lower for solutions with a higher temperature slope. Minimum conductivity depends on sensor.

SECTION 4.0 INTRINSICALLY SAFE INSTALLATION

B 9241567-00

RELEASE DATE	ECO NO	REV	LTR	ECO	DESCRIPTION	BY	DATE	CHK
1-22/04	8810	A						

2.45

5.2" (132.7mm)

4X R .060

Rosemount[®] Analytical

MODEL: XMT-T-HT-87
OUTPUT: 4-20mA
SUPPLY: 42.4 VDC MAXIMUM

INTRINSICALLY SAFE FOR CLASS I, II & III, DIVISION 1,
GROUPS A, B, C, D, E, F & G
HAZARDOUS AREA WHEN CONNECTED PER DWG. 1400247

T4 Tamb = 50°C
OPERATING TEMPERATURE PROOF CLASS II AND III, DIVISION 1,
GROUPS A, B, C, D, E, F & G
WARNING: COMPONENT SUBSTITUTION MAY IMPAIR INTRINSIC
SAFETY OR SUITABILITY FOR DIVISION 2
NEMA 4X ENCLOSURE

1.25

FM APPROVED

4. NO CHANGE WITHOUT FM APPROVAL.

3. ALL ALPHA AND NUMERIC CHARACTERS ON LABEL TO BE BLACK HELVETICA MEDIUM. BACKGROUND TO BE WHITE.

UNLESS OTHERWISE SPECIFIED

XX : 232 TELEGRAPHS ANGLES : 1/2°
XXX : 010 2 VESICONS ARE 1/16" INCHES
REMOVE LIPS & SHARP EDGES 220/0AX
MIL INES - LET 9001 120/0AX
MATERIAL FINISH: 2

MATERIAL FINISH

2. MATERIAL FINISH: 2 MIL GLOSS WHITE POLYESTER WITH PRESSURE SENSITIVE ACRYLIC ADHESIVE.
NOMENCLATURE TO BE PRINTED USING INTERMEC SUPER PREMIUM BLACK THERMAL TRANSFER RIBBON.
SEE BLANK LABEL PN 9241406-01.

1. ARTWORK IS SHEET 2 OF 2.

NOTES: UNLESS OTHERWISE SPECIFIED

THIS DOCUMENT IS CERTIFIED BY

REV _____

REV _____

REV _____

REV _____

REV _____

REVISIONS NOT PERMITTED
W/O AGENCY APPROVAL

ITEM	PART NO	DESCRIPTION	QTY
BILL OF MATERIAL			
Emerson			
TITLE: LABEL, I.S. FM XMT-T-HT			
DWG NO: B 9241567-00			
SCALE: 2:1			

FIGURE 4-1. FM Intrinsically Safe Label for Model Xmt-T-HT

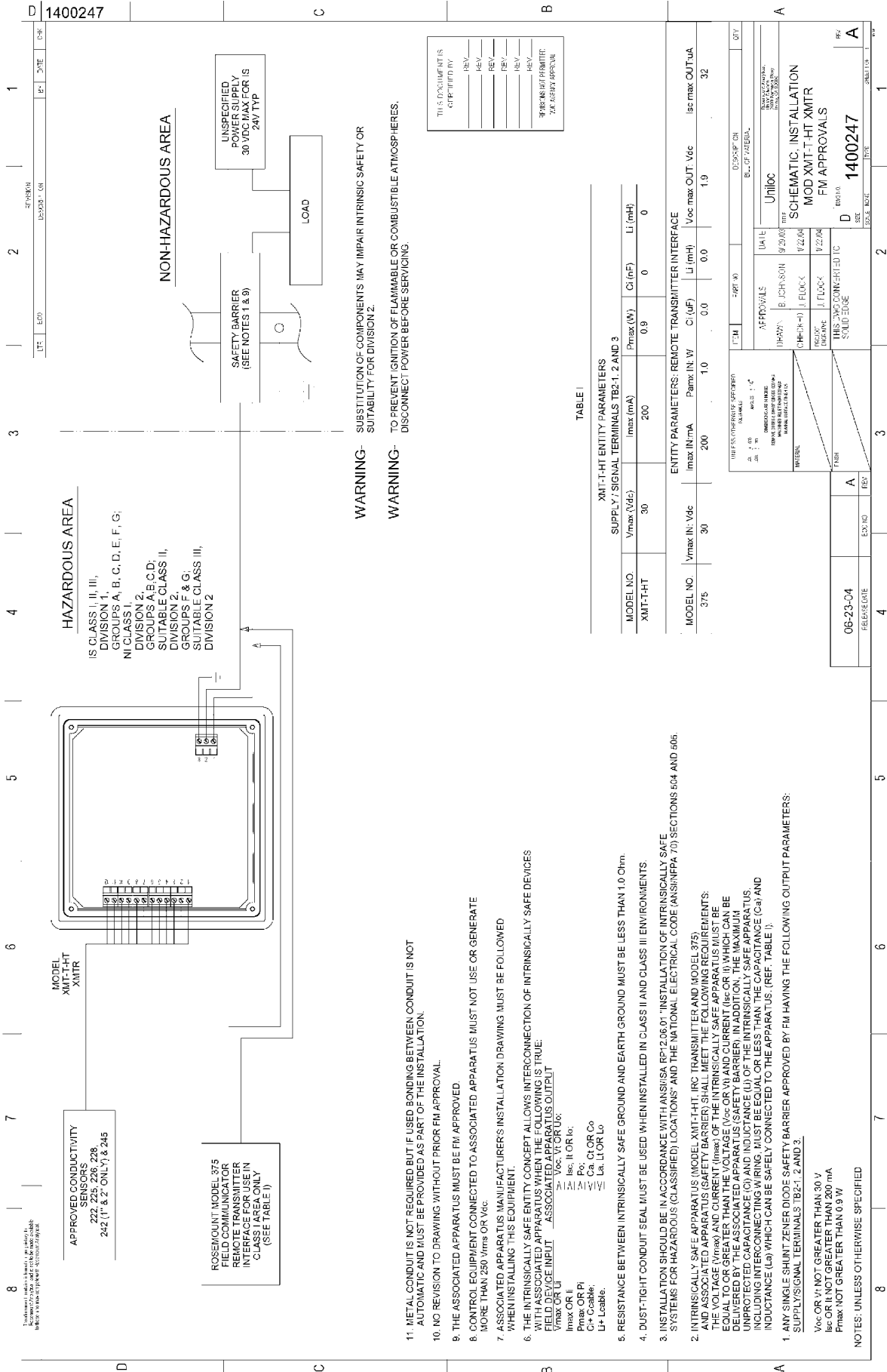
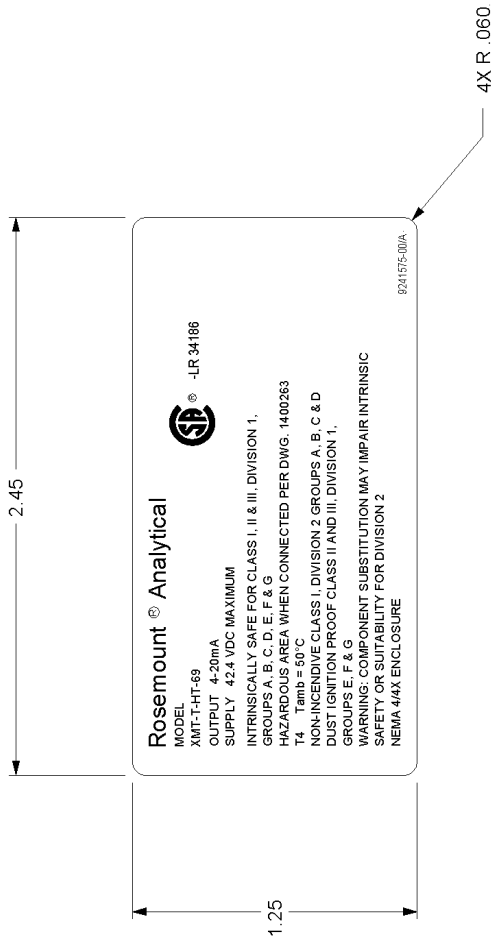

FIGURE 4-2. FM Intrinsically Safe Installation for Model Xmt-T-HT

This document contains information proprietary to Rosemount Analytical, and is not to be made available to those who may compete with Rosemount Analytical.		REVISIONS		REV		ECO NO		RELEASE DATE	
		DESCRIPTION		A		8810		6-23-04	
		BY		DATE		LTR		ECO	
		CHK							

9241575-00



Rosemount Analytical
 MODEL XMT-T-HT-89
 OUTPUT 4-20mA
 SUPPLY 42.4 VDC MAXIMUM
 INTRINSICALLY SAFE FOR CLASS I, II & III, DIVISION 1,
 GROUPS A, B, C, D, E, F & G
 HAZARDOUS AREA WHEN CONNECTED PER DWG. 1400263
 T4
 Temp = 50°C
 NON-INCENDIVE CLASS I, DIVISION 2, GROUPS A, B, C & D
 DUST/IGNITION PROOF CLASS II AND III, DIVISION 1,
 GROUPS E, F & G
 WARNING: COMPONENT SUBSTITUTION MAY IMPAIR INTRINSIC
 SAFETY OR SUITABILITY FOR DIVISION 2
 NEMA 4/4X ENCLOSURE

THIS DOCUMENT IS
 CERTIFIED BY
 _____ REV _____
 _____ REV _____
 _____ REV _____
 _____ REV _____
 _____ REV _____
 _____ REV _____
 REVISIONS NOT PERMITTED
 W/O AGENCY APPROVAL

- NO CHANGE WITHOUT CSA APPROVAL.
- ALL ALPHA AND NUMERIC CHARACTERS ON LABEL TO BE BLACK HELVETICA MEDIUM. BACKGROUND TO BE WHITE.
- MATERIAL: 3M SCOTCHCAL #3650-10 (WHITE VINYL FACESTOCK) OR POLYESTER, (.002 REFERENCE THICKNESS CLEAR MATTE MYLAR OVERLAMINATE .002-.005 FINISH THICKNESS, PRESSURE SENSITIVE ADHESIVE, FAR SIDE AND SPLIT LINER) OR (INTERMEC PN L7211210, 2 MIL GLOSS WHITE POLYESTER WITH PRESSURE SENSITIVE ACRYLIC ADHESIVE. NOMENCLATURE TO BE PRINTED USING INTERMEC SUPER PREMIUM BLACK THERMAL TRANSFER RIBBON). SEE BLANK LABEL PN 9241406-01.
- ARTWORK IS SHEET 2 OF 2.

UNLESS OTHERWISE SPECIFIED		ITEM	PART NO	DESCRIPTION	QTY
XX ± .030	TOLERANCES				
XX ± .010	ANGLES ± 10°				
	DIMENSIONS ARE IN INCHES	APPROVALS		BILL OF MATERIAL	
	REMOVE BURRS & SHARP EDGES (.002 MAX)	DRAWN	B. JOHNSON	Emerson	
	MACHINED FILLET RADI (.002 MAX)	CHECKED	J. FLOCK	TITLE	
	NOMINAL SURFACE FINISH 125	PROJECT ENGR APVD	J. FLOCK	LABEL, I.S. CSA	
				XMT-T-HT	
MATERIAL		THIS DWG CONVERTED TO SOLID EDGE		DWG NO	
FINISH				B	
				SIZE	
				9241575-00	
				SCALE	
				2:1	
				REV	
				A	
				SHEET 1 OF 2	

FIGURE 4-3. CSA Intrinsically Safe Label for Model Xmt-T-HT

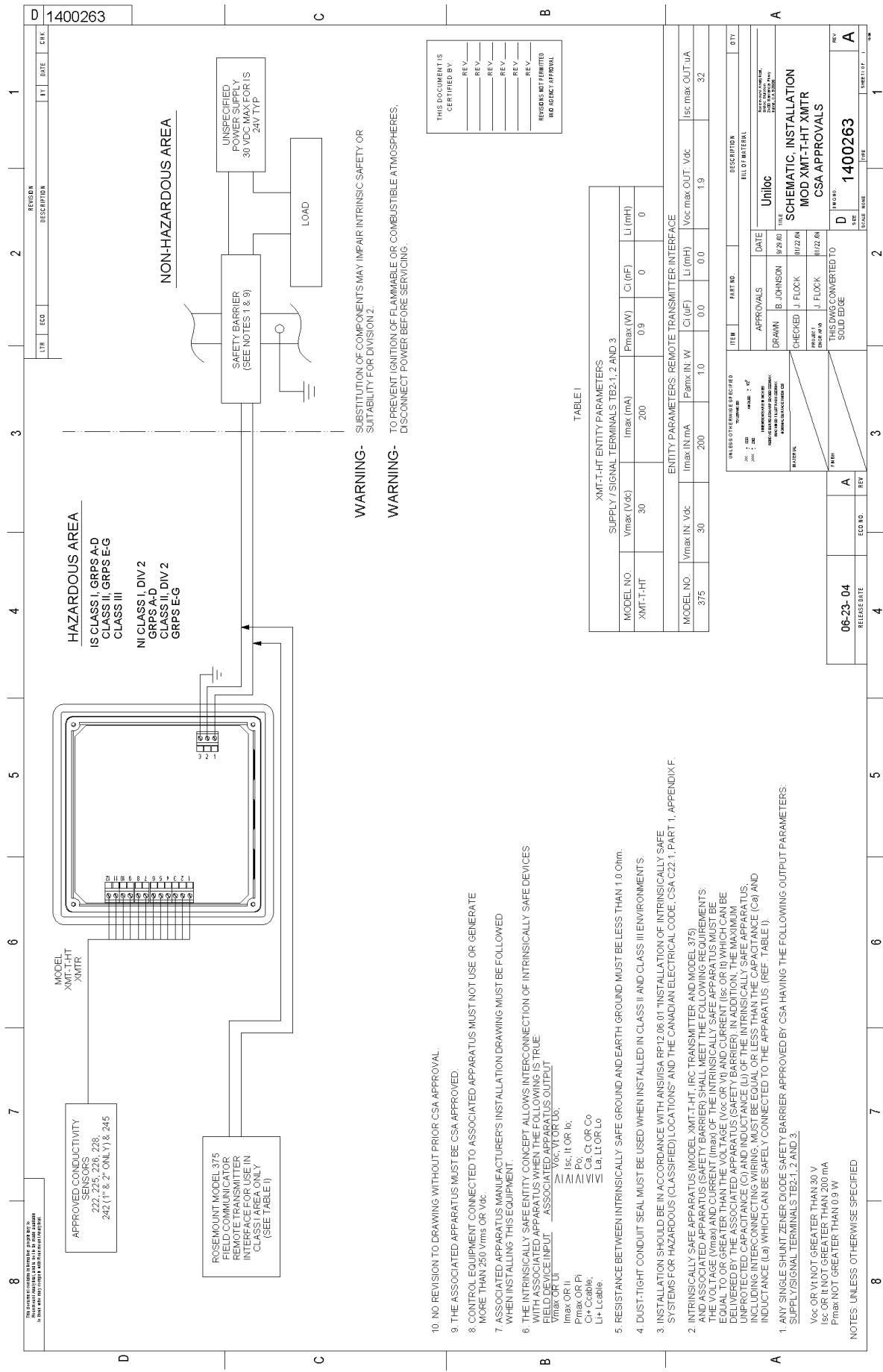

THIS DOCUMENT IS
 CERTIFIED BY
 REV. _____
 REV. _____
 REV. _____
 REV. _____
 REV. _____
 REV. _____
 REVISIONS NOT PERMITTED
 UNLESS INDICATED OTHERWISE

TABLE I

XMT-T-HT ENTITY PARAMETERS			
SUPPLY / SIGNAL TERMINALS TB2-1, 2 AND 3			
MODEL NO.	Vmax (Vdc)	Imax (mA)	Pmax (W)
XMT-T-HT	30	200	0.9
			0
			0

ENTITY PARAMETERS: REMOTE TRANSMITTER INTERFACE			
MODEL NO.	Vmax IN Vdc	Imax IN mA	Pmax IN W
375	30	200	1.0
			0.0
			0.0

UNLESS OTHERWISE SPECIFIED:
 UNITS: mm (INCHES) - 1/8"
 DIMENSIONS: mm (INCHES)
 TOLERANCES: mm (INCHES)
 FINISHES: mm (INCHES)
 MATERIALS: mm (INCHES)

ITEM	PART NO.	DESCRIPTION	QTY
APPROVALS			
DRAWN	B. JOHNSON	DATE	
CHECKED	J. FLOCK	DATE	
APPROVED	J. FLOCK	DATE	
THIS DRAWING CONVERTED TO SOLID EDGE			

UNITLOC
 TITLE
 MOD XMT-T-HT XMT-R
 CSA APPROVALS

REV. _____
 DATE _____
 SCALE _____
 SHEET 1 OF 1

FIGURE 4-4. CSA Intrinsically Safe Installation for Model Xmt-T-HT

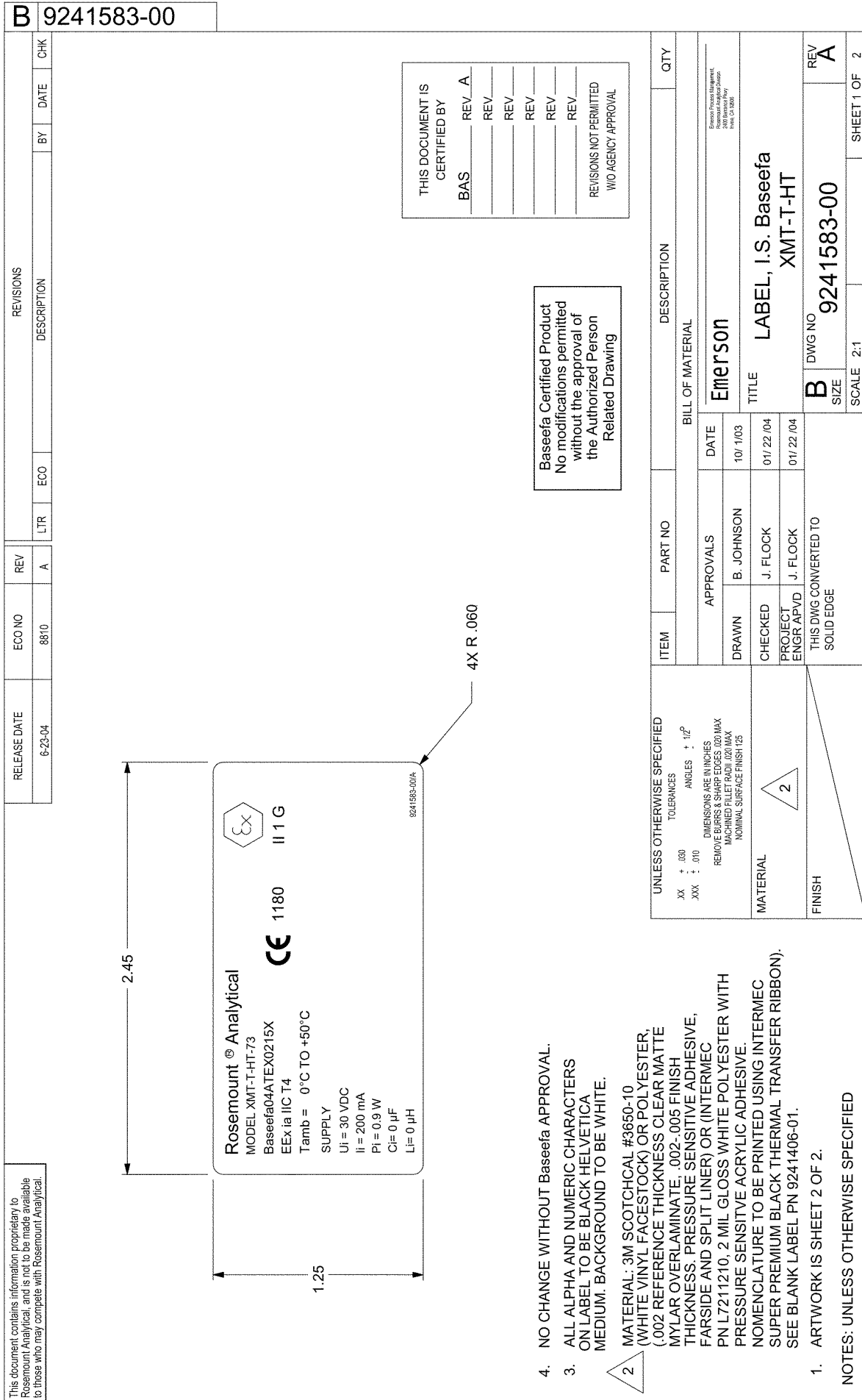

FIGURE 4-5. ATEX Intrinsically Safe Label for Model Xmt-T-HT

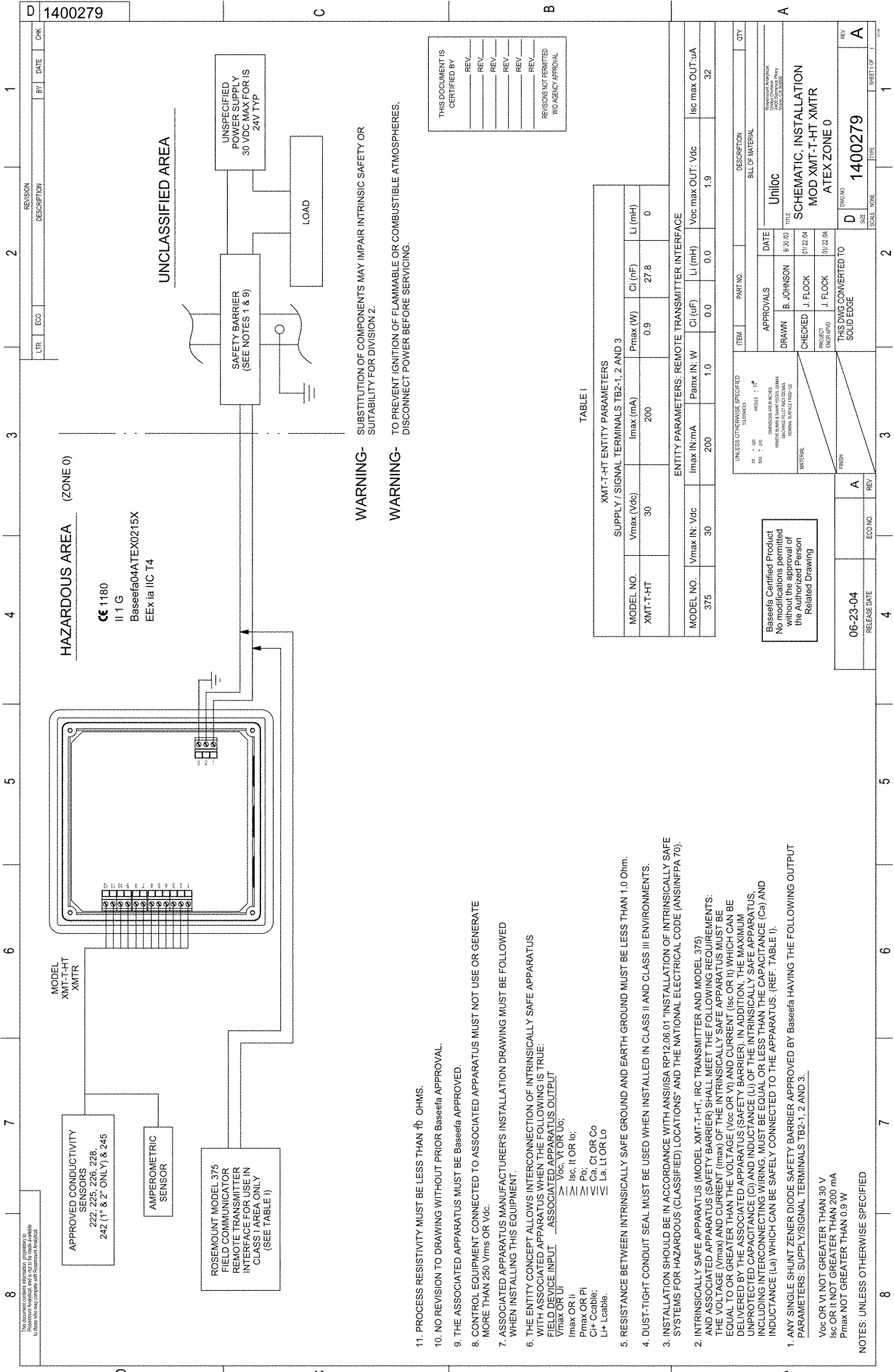

FIGURE 4-6. ATEX Intrinsically Safe Installation for Model Xmt-T-HT

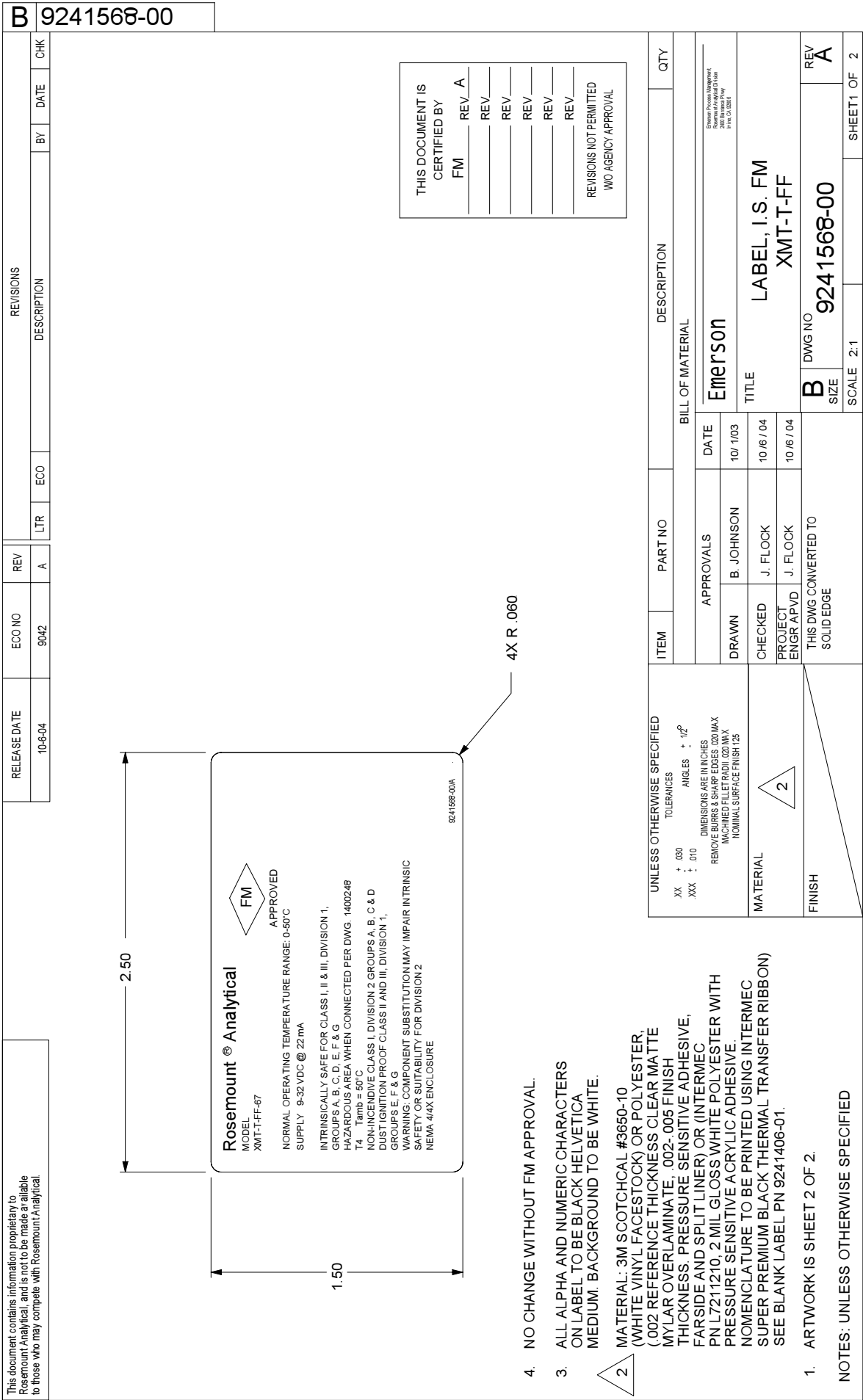
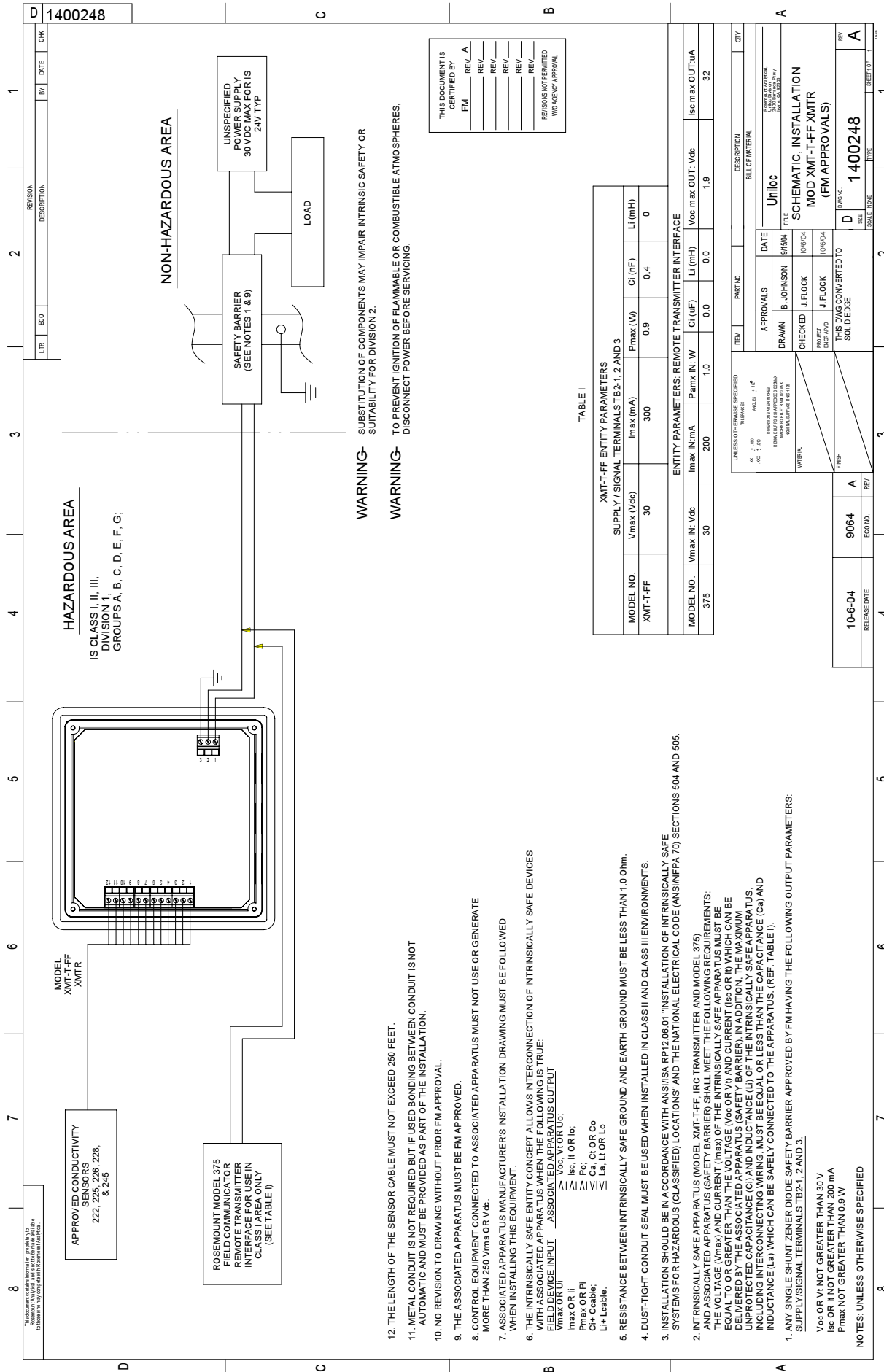

FIGURE 4-7. FM Intrinsically Safe Label for Model Xmt-T-FF



THIS DOCUMENT IS
CERTIFIED BY
FM REV. A
REV. _____
REV. _____
REV. _____
REV. _____
REVISIONS NOT PERMITTED
WITHOUT APPROVAL
BY AGENCY APPROVAL

TABLE I

XMT-T-FF ENTITY PARAMETERS					
SUPPLY / SIGNAL TERMINALS TB2-1, 2 AND 3					
MODEL NO.	V _{max} (Vdc)	I _{max} (mA)	P _{max} (W)	C _i (nF)	L _i (mH)
XMT-T-FF	30	300	0.9	0.4	0

ENTITY PARAMETERS: REMOTE TRANSMITTER INTERFACE					
MODEL NO.	V _{max} IN: Vdc	I _{max} IN: mA	P _{max} IN: W	C _i (nF)	L _i (mH)
375	30	200	1.0	0.0	0.0
					V _{oc} max OUT: Vdc
					I _{sc} max OUT: IA
					32

ITEM		PART NO.		DESCRIPTION		QTY
UNLESS OTHERWISE SPECIFIED						
XX	10-6-04	9064	A	REST		
<small> UNLESS OTHERWISE SPECIFIED DIMENSIONS ARE IN INCHES DIMENSIONS IN PARENTHESIS ARE METRIC EQUIVALENTS FINISHES: UNLESS OTHERWISE SPECIFIED SURFACE FINISHES: UNLESS OTHERWISE SPECIFIED MATERIALS: UNLESS OTHERWISE SPECIFIED </small>						
APPROVALS		DATE		DESCRIPTION		QTY
DRAWN: B. JOHNSON		DATE: 10/06/04		BILL OF MATERIAL		
CHECKED: J. FLOCK		DATE: 10/06/04		UNiloc		
PROJECT: ENGR 490		DATE: 10/06/04		SCHEMATIC, INSTALLATION		
THIS DWG CONVERTED TO		DATE: 10/06/04		MOD XMT-T-FF XMTR		
SOLID EDGE		DATE: 10/06/04		(FM APPROVAL)		
REV	DESCRIPTION	DATE	BY	APP'D	SCALE	TYPE
A	1400248					

FIGURE 4-8. FM Intrinsically Safe Installation for Model Xmt-T-FF

12. THE LENGTH OF THE SENSOR CABLE MUST NOT EXCEED 250 FEET.
11. METAL CONDUIT IS NOT REQUIRED BUT IF USED BONDING BETWEEN CONDUIT IS NOT AUTOMATIC AND MUST BE PROVIDED AS PART OF THE INSTALLATION.
10. NO REVISION TO DRAWING WITHOUT PRIOR FM APPROVAL.
9. THE ASSOCIATED APPARATUS MUST BE FM APPROVED.
8. CONTROL EQUIPMENT CONNECTED TO ASSOCIATED APPARATUS MUST NOT USE OR GENERATE MORE THAN 250 Vrms OR Vdc.
7. ASSOCIATED APPARATUS MANUFACTURER'S INSTALLATION DRAWING MUST BE FOLLOWED WHEN INSTALLING THIS EQUIPMENT.
6. THE INTRINSICALLY SAFE ENTITY CONCEPT ALLOWS INTERCONNECTION OF INTRINSICALLY SAFE DEVICES WITH ASSOCIATED APPARATUS WHEN THE FOLLOWING IS TRUE:
 (a) THE INTRINSICALLY SAFE ENTITY IS THE ONLY SOURCE OF ENERGY TO THE INTRINSICALLY SAFE DEVICES.
 (b) THE INTRINSICALLY SAFE ENTITY IS THE ONLY SOURCE OF ENERGY TO THE INTRINSICALLY SAFE DEVICES.
 (c) THE INTRINSICALLY SAFE ENTITY IS THE ONLY SOURCE OF ENERGY TO THE INTRINSICALLY SAFE DEVICES.
 (d) THE INTRINSICALLY SAFE ENTITY IS THE ONLY SOURCE OF ENERGY TO THE INTRINSICALLY SAFE DEVICES.
 (e) THE INTRINSICALLY SAFE ENTITY IS THE ONLY SOURCE OF ENERGY TO THE INTRINSICALLY SAFE DEVICES.
 (f) THE INTRINSICALLY SAFE ENTITY IS THE ONLY SOURCE OF ENERGY TO THE INTRINSICALLY SAFE DEVICES.
 (g) THE INTRINSICALLY SAFE ENTITY IS THE ONLY SOURCE OF ENERGY TO THE INTRINSICALLY SAFE DEVICES.
 (h) THE INTRINSICALLY SAFE ENTITY IS THE ONLY SOURCE OF ENERGY TO THE INTRINSICALLY SAFE DEVICES.
 (i) THE INTRINSICALLY SAFE ENTITY IS THE ONLY SOURCE OF ENERGY TO THE INTRINSICALLY SAFE DEVICES.
 (j) THE INTRINSICALLY SAFE ENTITY IS THE ONLY SOURCE OF ENERGY TO THE INTRINSICALLY SAFE DEVICES.
 (k) THE INTRINSICALLY SAFE ENTITY IS THE ONLY SOURCE OF ENERGY TO THE INTRINSICALLY SAFE DEVICES.
 (l) THE INTRINSICALLY SAFE ENTITY IS THE ONLY SOURCE OF ENERGY TO THE INTRINSICALLY SAFE DEVICES.
 (m) THE INTRINSICALLY SAFE ENTITY IS THE ONLY SOURCE OF ENERGY TO THE INTRINSICALLY SAFE DEVICES.
 (n) THE INTRINSICALLY SAFE ENTITY IS THE ONLY SOURCE OF ENERGY TO THE INTRINSICALLY SAFE DEVICES.
 (o) THE INTRINSICALLY SAFE ENTITY IS THE ONLY SOURCE OF ENERGY TO THE INTRINSICALLY SAFE DEVICES.
 (p) THE INTRINSICALLY SAFE ENTITY IS THE ONLY SOURCE OF ENERGY TO THE INTRINSICALLY SAFE DEVICES.
 (q) THE INTRINSICALLY SAFE ENTITY IS THE ONLY SOURCE OF ENERGY TO THE INTRINSICALLY SAFE DEVICES.
 (r) THE INTRINSICALLY SAFE ENTITY IS THE ONLY SOURCE OF ENERGY TO THE INTRINSICALLY SAFE DEVICES.
 (s) THE INTRINSICALLY SAFE ENTITY IS THE ONLY SOURCE OF ENERGY TO THE INTRINSICALLY SAFE DEVICES.
 (t) THE INTRINSICALLY SAFE ENTITY IS THE ONLY SOURCE OF ENERGY TO THE INTRINSICALLY SAFE DEVICES.
 (u) THE INTRINSICALLY SAFE ENTITY IS THE ONLY SOURCE OF ENERGY TO THE INTRINSICALLY SAFE DEVICES.
 (v) THE INTRINSICALLY SAFE ENTITY IS THE ONLY SOURCE OF ENERGY TO THE INTRINSICALLY SAFE DEVICES.
 (w) THE INTRINSICALLY SAFE ENTITY IS THE ONLY SOURCE OF ENERGY TO THE INTRINSICALLY SAFE DEVICES.
 (x) THE INTRINSICALLY SAFE ENTITY IS THE ONLY SOURCE OF ENERGY TO THE INTRINSICALLY SAFE DEVICES.
 (y) THE INTRINSICALLY SAFE ENTITY IS THE ONLY SOURCE OF ENERGY TO THE INTRINSICALLY SAFE DEVICES.
 (z) THE INTRINSICALLY SAFE ENTITY IS THE ONLY SOURCE OF ENERGY TO THE INTRINSICALLY SAFE DEVICES.
5. RESISTANCE BETWEEN INTRINSICALLY SAFE GROUND AND EARTH GROUND MUST BE LESS THAN 1.0 Ohm.
4. DUST-TIGHT CONDUIT SEAL MUST BE USED WHEN INSTALLED IN CLASS II AND CLASS III ENVIRONMENTS.
3. INSTALLATION SHOULD BE IN ACCORDANCE WITH ANSI/ISA RPT12.06.01 "INSTALLATION OF INTRINSICALLY SAFE SYSTEMS FOR HAZARDOUS (CLASSIFIED) LOCATIONS" AND THE NATIONAL ELECTRICAL CODE (ANSI/NFPA 70) SECTIONS 504 AND 505.
2. INTRINSICALLY SAFE APPARATUS (MODEL XMT-T-FF, IRC TRANSMITTER AND MODEL 375) AND ASSOCIATED APPARATUS (SAFETY BARRIER) SHALL MEET THE FOLLOWING REQUIREMENTS:
 (a) THE VOLTAGE (V_{max}) AND CURRENT (I_{max}) OF THE INTRINSICALLY SAFE APPARATUS MUST BE EQUAL TO OR GREATER THAN THE VOLTAGE (V_{oc} OR V_i) AND CURRENT (I_{sc} OR I_i) WHICH CAN BE DELIVERED BY THE ASSOCIATED APPARATUS (SAFETY BARRIER). IN ADDITION, THE MAXIMUM PERMITTED CURRENT (I_{sc}) OF THE INTRINSICALLY SAFE APPARATUS MUST BE LESS THAN THE CAPACITANCE (C_i) AND INDUCTANCE (L_i) WHICH CAN BE SAELY CONNECTED TO THE APPARATUS. (REF. TABLE I).
1. ANY SINGLE SHUNT ZENER DIODE SAFETY BARRIER APPROVED BY FM HAVING THE FOLLOWING OUTPUT PARAMETERS:
 V_{oc} OR V_i NOT GREATER THAN 30 V
 I_{sc} OR I_i NOT GREATER THAN 200 mA
 P_{max} NOT GREATER THAN 0.9 W

NOTES: UNLESS OTHERWISE SPECIFIED

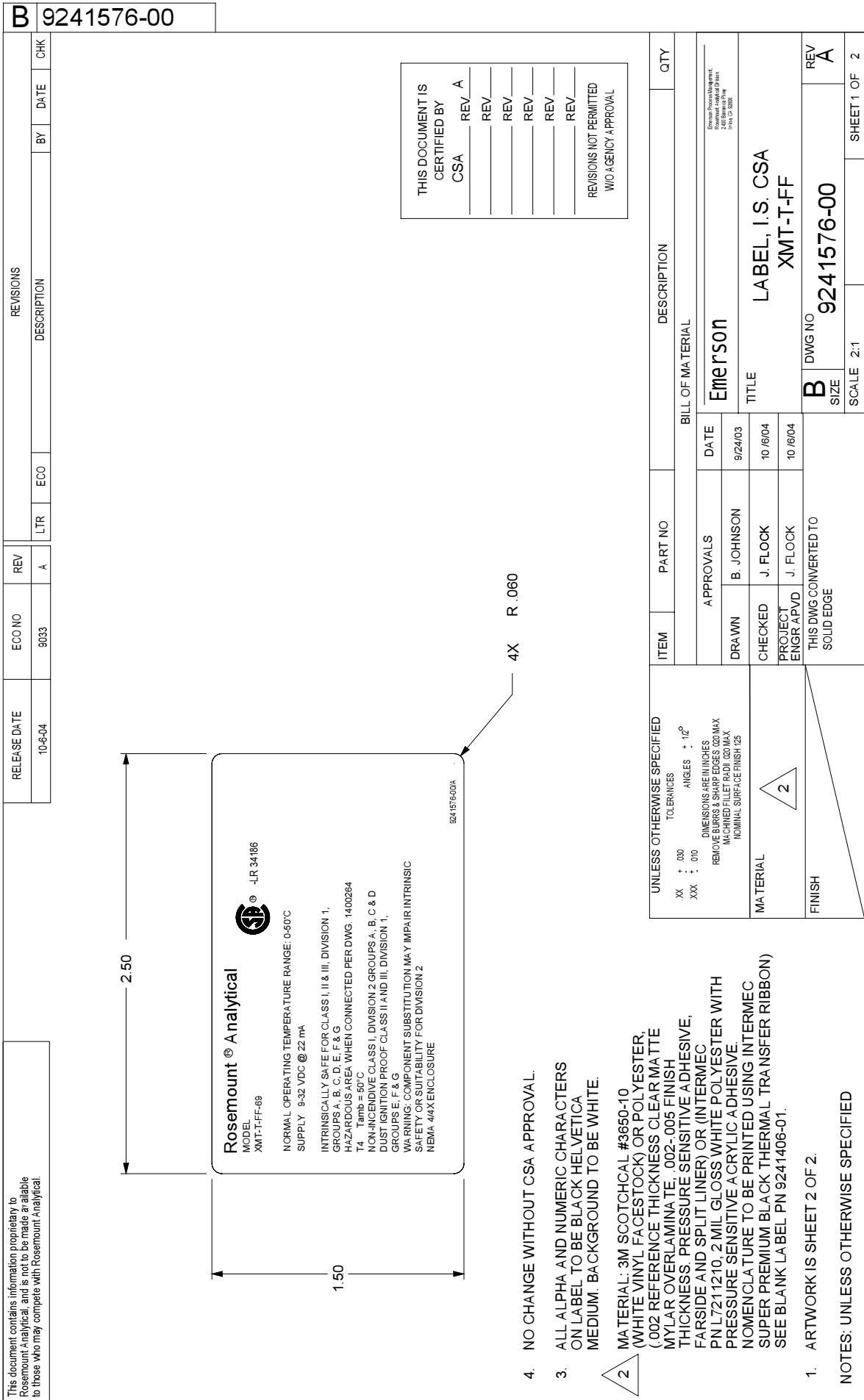
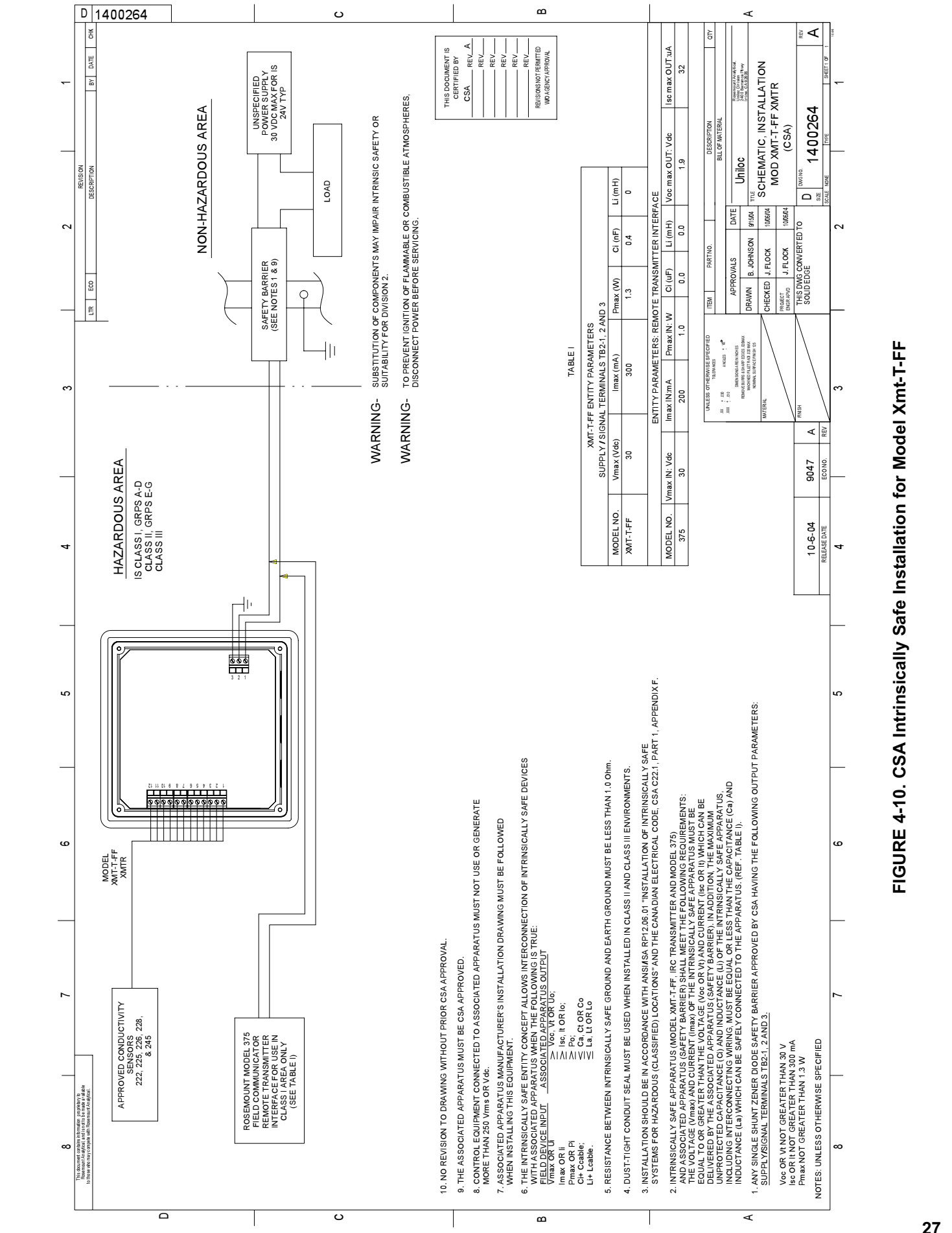

FIGURE 4-9. CSA Intrinsically Safe Label for Model Xmt-T-FF



REVISION		BY	DATE	CHK
D	1400264			

HAZARDOUS AREA
IS CLASS I, GRPS A-D
CLASS II, GRPS E-G
CLASS III

NON-HAZARDOUS AREA

- 10. NO REVISION TO DRAWING WITHOUT PRIOR CSA APPROVAL.
- 9. THE ASSOCIATED APPARATUS MUST BE CSA APPROVED.
- 8. CONTROL EQUIPMENT CONNECTED TO ASSOCIATED APPARATUS MUST NOT USE OR GENERATE MORE THAN 250 Vrms OR Vdc.
- 7. WHEN INSTALLING THIS EQUIPMENT.
- 6. THE INTRINSICALLY SAFE ENTITY CONCEPT ALLOWS INTERCONNECTION OF INTRINSICALLY SAFE DEVICES WITH ASSOCIATED APPARATUS WHEN THE FOLLOWING IS TRUE:
FIELD DEVICE INPUT: ASSOCIATED APPARATUS OUTPUT
Vmax OR Vc
Imax OR Ii
Pc OR Pi
Ca OR Ci
Lr OR Lc
Lr OR Lc
- 5. RESISTANCE BETWEEN INTRINSICALLY SAFE GROUND AND EARTH GROUND MUST BE LESS THAN 1.0 Ohm.
- 4. DUST-TIGHT CONDUIT SEAL MUST BE USED WHEN INSTALLED IN CLASS II AND CLASS III ENVIRONMENTS.
- 3. INSTALLATION SHOULD BE IN ACCORDANCE WITH ANSI/ISA RPI2.06.01 "INSTALLATION OF INTRINSICALLY SAFE SYSTEMS FOR HAZARDOUS (CLASSIFIED) LOCATIONS" AND THE CANADIAN ELECTRICAL CODE, CSA C22.1, PART 1, APPENDIX F.
- 2. INTRINSICALLY SAFE APPARATUS (MODEL XMT-T-FF, IRC TRANSMITTER AND MODEL 375) AND ASSOCIATED APPARATUS (SAFETY BARRIER) SHALL MEET THE FOLLOWING REQUIREMENTS:
THE VOLTAGE (Vmax) AND CURRENT (Imax) OF THE INTRINSICALLY SAFE APPARATUS MUST BE EQUAL TO OR GREATER THAN THE VOLTAGE (Voc OR Vi) AND CURRENT (Isc OR Ii) WHICH CAN BE DELIVERED BY THE ASSOCIATED APPARATUS (SAFETY BARRIER). IN ADDITION, THE MAXIMUM UNPROTECTED CAPACITANCE (Ca) AND INDUCTANCE (Li) OF THE INTRINSICALLY SAFE APPARATUS, INCLUDING INTERCONNECTING WIRING, MUST BE EQUAL OR LESS THAN THE CAPACITANCE (Ca) AND INDUCTANCE (La) WHICH CAN BE SAFELY CONNECTED TO THE APPARATUS. (REF. TABLE I).
- 1. ANY SINGLE SHUNT ZENER DIODE SAFETY BARRIER APPROVED BY CSA HAVING THE FOLLOWING OUTPUT PARAMETERS:
SUPPLY SIGNAL TERMINALS TB2-1, 2 AND 3:
Voc OR Vi NOT GREATER THAN 30 V
Isc OR Ii NOT GREATER THAN 300 mA
Pmax NOT GREATER THAN 1.3 W

TABLE I
XMT-T-FF ENTITY PARAMETERS

SUPPLY SIGNAL TERMINALS TB2-1, 2 AND 3		
MODEL NO.	Vmax (Vdc)	Imax (mA)
XMT-T-FF	30	300
		Pmax (W)
		1.3
		Ci (nF)
		0.4
		Li (mH)
		0

ENTITY PARAMETERS: REMOTE TRANSMITTER INTERFACE		
MODEL NO.	Vmax IN: Vdc	Imax IN: mA
375	30	200
		Pmax IN: W
		1.0
		Ci (uF)
		0.0
		Li (mH)
		0.0
		Voc max OUT: Vdc
		1.9
		Isc max OUT: uA
		32

UNLESS OTHERWISE SPECIFIED
XX : 1 : 28
XXX : 1 : 28
UNLESS OTHERWISE SPECIFIED
UNLESS OTHERWISE SPECIFIED
UNLESS OTHERWISE SPECIFIED

ITEM PART NO. DESCRIPTION QUANTITY
BILL OF MATERIAL

APPROVALS DATE
DRAWN B. JOHNSON 9/5/94
CHECKED J. FLOCK 10/6/94
PRODUCT SHIPPING J. FLOCK 10/6/94

UNLESS OTHERWISE SPECIFIED
UNLESS OTHERWISE SPECIFIED
UNLESS OTHERWISE SPECIFIED

ITEM PART NO. DESCRIPTION QUANTITY
BILL OF MATERIAL

APPROVALS DATE
DRAWN B. JOHNSON 9/5/94
CHECKED J. FLOCK 10/6/94
PRODUCT SHIPPING J. FLOCK 10/6/94

DATE	BY	TYPE	SCALE	NO.	REV
10-6-04	9047	A			

THIS DOCUMENT IS CERTIFIED BY CSA REV. A
REV. REV. REV. REV. REV.
REVISIONS NOT PERMITTED
UNLESS OTHERWISE SPECIFIED
UNLESS OTHERWISE SPECIFIED

THIS DOCUMENT IS CERTIFIED BY CSA REV. A
REV. REV. REV. REV. REV.
REVISIONS NOT PERMITTED
UNLESS OTHERWISE SPECIFIED
UNLESS OTHERWISE SPECIFIED

FIGURE 4-10. CSA Intrinsically Safe Installation for Model Xmt-T-FF

B 9241584-00

RELEAS DATE	ECO NO	REV	LTR	ECO	BY	DATE	CHK
6-30-05	9066	A					

This document contains information proprietary to Rosemount Analytical, and is not to be made available to those who may compete with Rosemount Analytical.

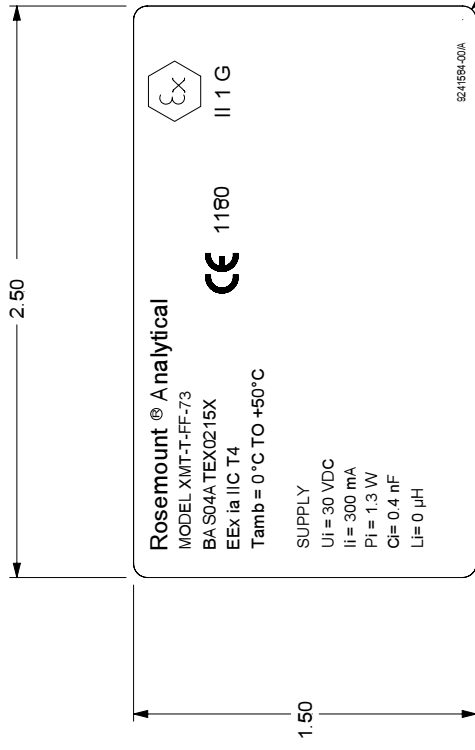

THIS DOCUMENT IS CERTIFIED BY
Baseefa REV. A
 _____ REV. _____
 _____ REV. _____
 _____ REV. _____
 _____ REV. _____
 _____ REV. _____
 REVISIONS NOT PERMITTED
 W/O AGENCY APPROVAL

Baseefa Certified Product
 No modifications permitted
 without the approval of
 the Authorized Person
 Related Drawing

4. NO CHANGE WITHOUT Baseefa APPROVAL.

3. ALL ALPHA AND NUMERIC CHARACTERS ON LABEL TO BE BLACK HELVETICA MEDIUM. BACKGROUND TO BE WHITE.

2 MATERIAL: 3M SCOTCHCAL #3650-10 (WHITE VINYL FACESTOCK) OR POLYESTER, (.002 REFERENCE THICKNESS CLEAR MATTE MYLAR OVERLAMINATE, .002-.005 FINISH THICKNESS, PRESSURE SENSITIVE ADHESIVE, FAR SIDE AND SPLIT LINER).

1. ARTWORK IS SHEET 2 OF 2.

NOTES: UNLESS OTHERWISE SPECIFIED

UNLESS OTHERWISE SPECIFIED		ITEM	PART NO	DESCRIPTION	QTY
XX +.000	TOLERANCES	BILL OF MATERIAL			
XXX ±.010	ANGLES ±1/2°	Emerson			
DIMENSIONS ARE IN INCHES		Emerson Process Management			
REVISIONS ARE IN INCHES		10/16/04			
UNLESS OTHERWISE SPECIFIED		2000 Sherman Pkwy			
NOMINAL SURFACE FINISH 125		Emerson Process Management			
MATERIAL		TITLE LABEL, I.S. Baseefa			
FINISH		XMT-T-FF			
THIS DWG CONVERTED TO SOLID EDGE		DWG NO B 9241584-00			
		SCALE 2:1			
		SHEET 1 OF 2			

FIGURE 4-11. ATEX Intrinsically Safe Label for Model Xmt-T-FF

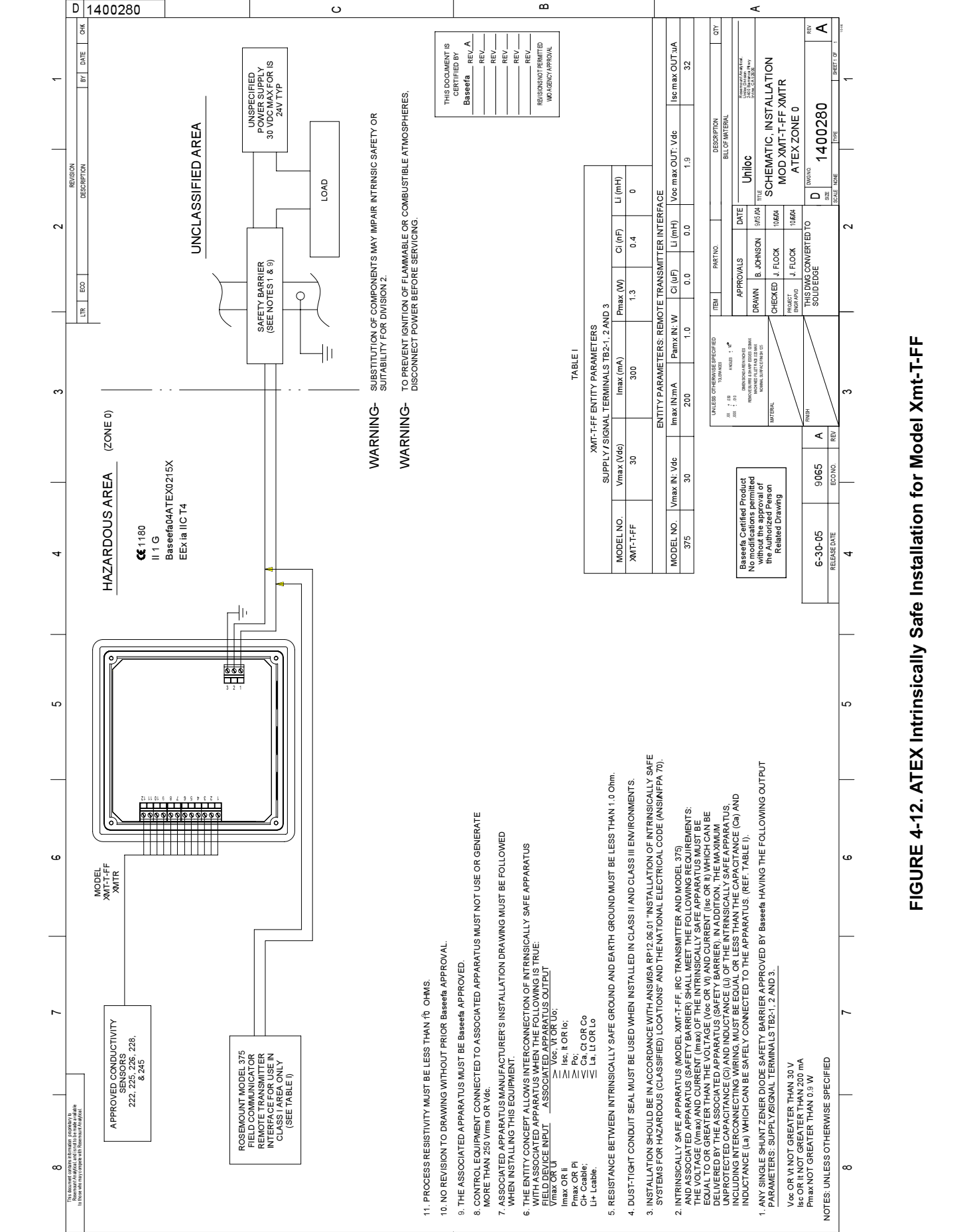

- 11. PROCESS RESISTIVITY MUST BE LESS THAN 10 OHMS.
- 10. NO REVISION TO DRAWING WITHOUT PRIOR Baseefa APPROVAL.
- 9. THE ASSOCIATED APPARATUS MUST BE Baseefa APPROVED.
- 8. CONTROL EQUIPMENT CONNECTED TO ASSOCIATED APPARATUS MUST NOT USE OR GENERATE MORE THAN 250 Vrms OR Vdc.
- 7. ASSOCIATED APPARATUS MANUFACTURER'S INSTALLATION DRAWING MUST BE FOLLOWED WHEN INSTALLING THIS EQUIPMENT.
- 6. THE ENTITY CONCEPT ALLOWS INTERCONNECTION OF INTRINSICALLY SAFE APPARATUS WITH ASSOCIATED APPARATUS WHEN THE FOLLOWING IS TRUE:
 FIELD DEVICE INPUT: ASSOCIATED APPARATUS OUTPUT
 Vmax OR Uo = Voc, VI OR Uo;
 Imax OR Ii = Isc, Ii OR I0;
 Pmax OR Pi = Po;
 Cc: Cable; Ca, Ct OR Co
 LI: Cable; La, Lt OR L0
- 5. RESISTANCE BETWEEN INTRINSICALLY SAFE GROUND AND EARTH GROUND MUST BE LESS THAN 1.0 Ohm.
- 4. DUST-TIGHT CONDUIT SEAL MUST BE USED WHEN INSTALLED IN CLASS II AND CLASS III ENVIRONMENTS.
- 3. INSTALLATION SHOULD BE IN ACCORDANCE WITH ANS/ISA RP12.06.01 "INSTALLATION OF INTRINSICALLY SAFE SYSTEMS FOR HAZARDOUS (CLASSIFIED) LOCATIONS" AND THE NATIONAL ELECTRICAL CODE (ANSI/NFPA 70).
- 2. INTRINSICALLY SAFE APPARATUS (MODEL XMT-T-FF, IRC TRANSMITTER AND MODEL 375) AND ASSOCIATED APPARATUS (SAFETY BARRIER) SHALL MEET THE FOLLOWING REQUIREMENTS: THE VOLTAGE (Vmax) AND CURRENT (Imax) OF THE INTRINSICALLY SAFE APPARATUS MUST BE EQUAL OR GREATER THAN THE VOLTAGE (Voc) AND CURRENT (Isc) OF THE ASSOCIATED APPARATUS (SAFETY BARRIER) UNLESS OTHERWISE SPECIFIED. APPARATUS (SAFETY BARRIER) MUST BE UNPROTECTED CAPACITANCE (C) AND INDUCTANCE (L) OF THE INTRINSICALLY SAFE APPARATUS INCLUDING INTERCONNECTING WIRING MUST BE EQUAL OR LESS THAN THE CAPACITANCE (Ca) AND INDUCTANCE (La) WHICH CAN BE SAFELY CONNECTED TO THE APPARATUS. (REF. TABLE I).
- 1. ANY SINGLE SHUNT ZENER DIODE SAFETY BARRIER APPROVED BY Baseefa HAVING THE FOLLOWING OUTPUT PARAMETERS: SUPPLY / SIGNAL TERMINALS TB2-1, 2 AND 3.
 Voc OR Vi NOT GREATER THAN 30 V
 Isc OR Ii NOT GREATER THAN 200 mA
 Pmax NOT GREATER THAN 0.9 W

NOTES: UNLESS OTHERWISE SPECIFIED

THIS DOCUMENT IS CERTIFIED BY
Baseefa REV. A

REV.	
REV.	
REV.	
REV.	
REV.	
REV.	
REV.	
REVISIONS NOT PERMITTED	WITHOUT AGENCY APPROVAL

Baseefa Certified Product
No modifications permitted without approval of the Authorizing Personnel or a Related Drawing

APPROVALS	DATE
DRAWN B. JOHNSON	5/15/04
CHECKED J. FLOCK	10/6/04
PROJECT ENGR AP'D J. FLOCK	10/6/04
THIS DWG CONVERTED TO SOLIDEDGE	

RELEASE DATE	6-30-05
ECO NO.	9065
REV.	A

REV.	A	SHEET OF	1
DATE	1400280	TYPE	
SCALE	2		

FIGURE 4-12. ATEX Intrinsically Safe Installation for Model Xmt-T-FF

B 9241606-00

RELEASE DATE	ECO NO	REV	REVISIONS
10-6-04	9042	A	DESCRIPTION
			BY
			DATE
			CHK

This document contains information proprietary to Rosemount Analytical, and is not to be made available to those who may compete with Rosemount Analytical.

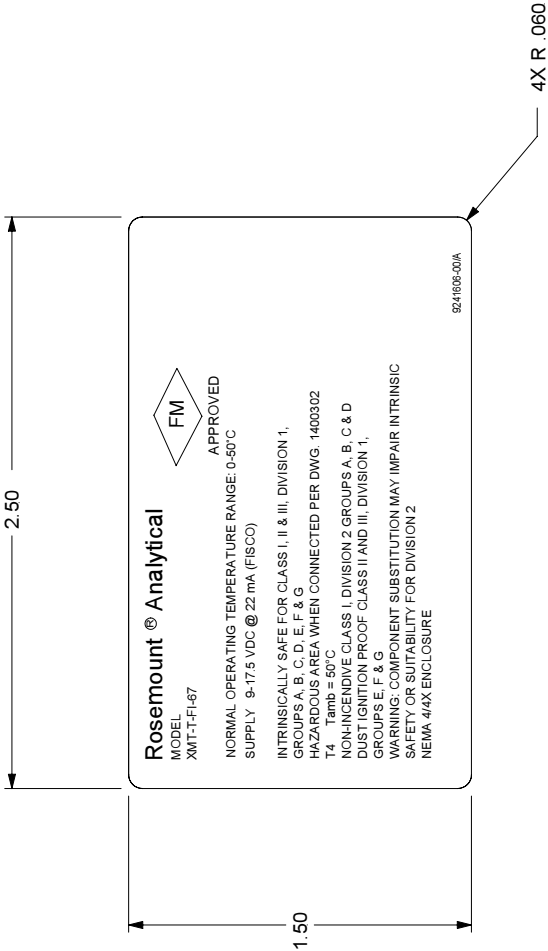

THIS DOCUMENT IS CERTIFIED BY
 FM REV. A
 _____ REV. _____
 _____ REV. _____
 _____ REV. _____
 _____ REV. _____
 _____ REV. _____
 REVISIONS NOT PERMITTED
 W/O AGENCY APPROVAL

4. NO CHANGE WITHOUT FM APPROVAL.
3. ALL ALPHA AND NUMERIC CHARACTERS ON LABEL TO BE BLACK HELVETICA MEDIUM. BACKGROUND TO BE WHITE.
2. MATERIAL: 3M SCOTCHCAL #3650-10 (WHITE VINYL FACESTOCK) OR POLYESTER, (.002 REFERENCE THICKNESS CLEAR MATTE MYLAR OVERLAMINATE, .002-.005 FINISH THICKNESS. PRESSURE SENSITIVE ADHESIVE, FAR SIDE AND SPLIT LINER) OR (INTERMEC PN L7211210, 2 MIL GLOSS WHITE POLYESTER WITH PRESSURE SENSITIVE ACRYLIC ADHESIVE. NOMENCLATURE TO BE PRINTED USING INTERMEC SUPER PREMIUM BLACK THERMAL TRANSFER RIBBON). SEE BLANK LABEL PN 9241406-01).
1. ARTWORK IS SHEET 2 OF 2.

UNLESS OTHERWISE SPECIFIED XX + .030 XXX ± .010 DIMENSIONS ARE IN INCHES REMOVE BURRS & SHARP EDGES .003 MAX MACHINED FILLET RADIUS .003 MAX NOMINAL SURFACE FINISH 125	APPROVALS DRAWN B. JOHNSON CHECKED J. FLOCK PROJECT ENGR APVD J. FLOCK	DATE 09/20/04 10/6/04 10/6/04	DESCRIPTION Emerson TITLE LABEL, I.S. FM XMT-T-FI	QTY
MATERIAL	THIS DWG CONVERTED TO SOLIDEDGE		DWG NO B 9241606-00	REV A
FINISH	SCALE 2:1		SHEET 1 OF 2	

FIGURE 4-13. FM Intrinsically Safe Label for Model Xmt-T-FI

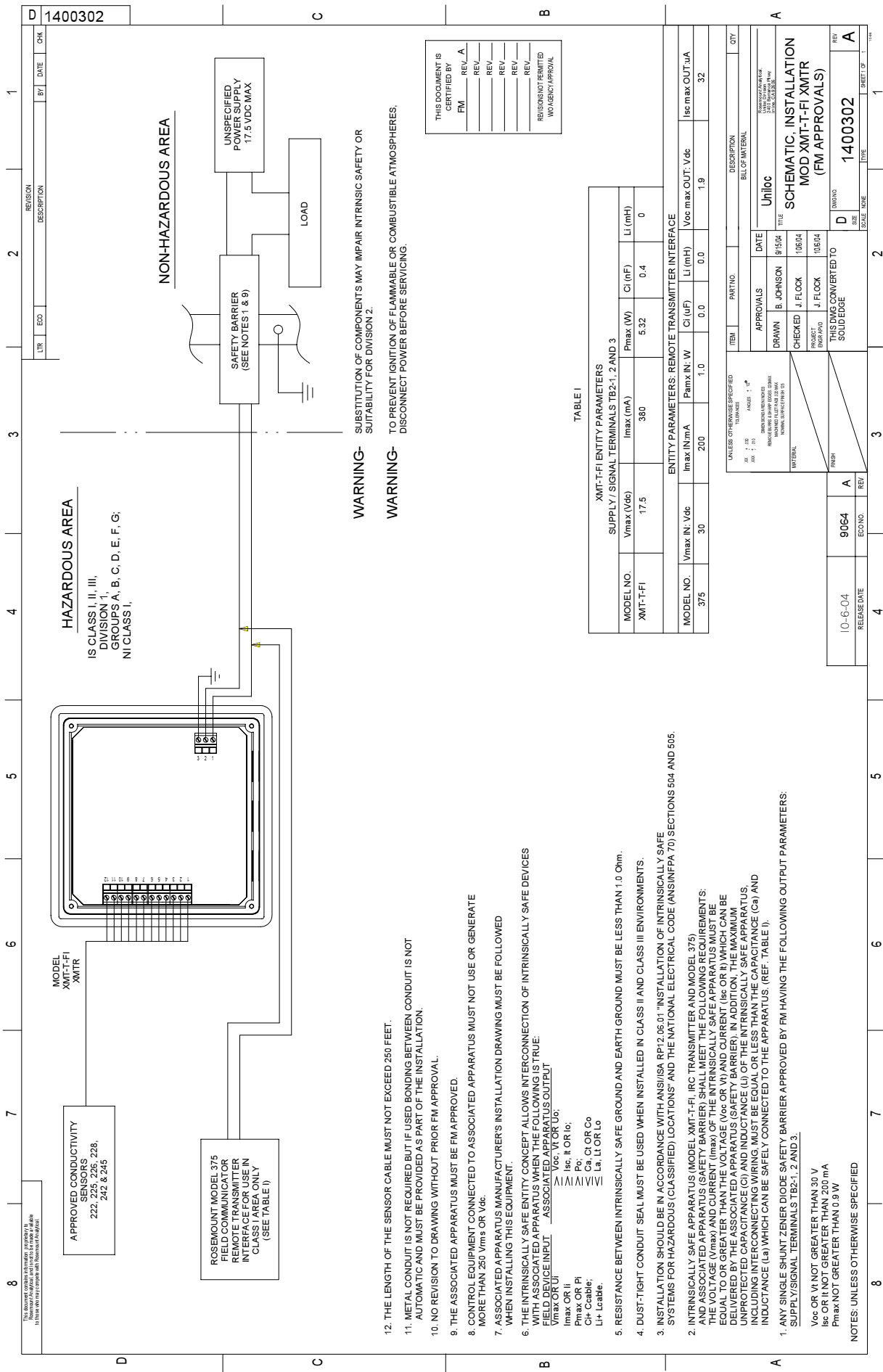

12. THE LENGTH OF THE SENSOR CABLE MUST NOT EXCEED 250 FEET.
 11. METAL CONDUIT IS NOT REQUIRED BUT IF USED BONDING BETWEEN CONDUIT IS NOT AUTOMATIC AND MUST BE PROVIDED AS PART OF THE INSTALLATION.
 10. NO REVISION TO DRAWING WITHOUT PRIOR FM APPROVAL.
 9. THE ASSOCIATED APPARATUS MUST BE FM APPROVED.
 8. CONTROL EQUIPMENT CONNECTED TO ASSOCIATED APPARATUS MUST NOT USE OR GENERATE MORE THAN 250 Vrms OR Vdc.
 7. ASSOCIATED APPARATUS MANUFACTURER'S INSTALLATION DRAWING MUST BE FOLLOWED WHEN INSTALLING THIS EQUIPMENT.
 6. THE INTRINSICALLY SAFE ENTITY CONCEPT ALLOWS INTERCONNECTION OF INTRINSICALLY SAFE DEVICES WITH ASSOCIATED APPARATUS WHEN THE FOLLOWING IS TRUE:
 FIELD DEVICE INPUT ASSOCIATED APPARATUS OUTPUT
 $V_{max} OR U_i \geq V_{oc}, V OR U_o$
 $I_{max} OR I_i \leq I_{sc}, I OR I_o$
 $P_{max} OR P_i \leq P_o$
 $C_i \geq C OR C_o$
 $L_i \leq L OR L_o$
 5. RESISTANCE BETWEEN INTRINSICALLY SAFE GROUND AND EARTH GROUND MUST BE LESS THAN 1.0 Ohm.
 4. DUST-TIGHT CONDUIT SEAL MUST BE USED WHEN INSTALLED IN CLASS II AND CLASS III ENVIRONMENTS.
 3. INSTALLATION SHOULD BE IN ACCORDANCE WITH ANSI/ISA RP12.06.01 "INSTALLATION OF INTRINSICALLY SAFE SYSTEMS FOR HAZARDOUS (CLASSIFIED) LOCATIONS" AND THE NATIONAL ELECTRICAL CODE (ANSI/NFPA 70) SECTIONS 504 AND 505.
 2. INTRINSICALLY SAFE APPARATUS (MODEL XMT-T-FI, IRC TRANSMITTER AND MODEL 375) AND ASSOCIATED APPARATUS (SAFETY BARRIER) SHALL MEET THE FOLLOWING REQUIREMENTS:
 a. THE INTRINSICALLY SAFE APPARATUS SHALL BE INTRINSICALLY SAFE.
 b. THE INTRINSICALLY SAFE APPARATUS SHALL BE INTRINSICALLY SAFE.
 c. THE INTRINSICALLY SAFE APPARATUS SHALL BE INTRINSICALLY SAFE.
 d. THE INTRINSICALLY SAFE APPARATUS SHALL BE INTRINSICALLY SAFE.
 e. THE INTRINSICALLY SAFE APPARATUS SHALL BE INTRINSICALLY SAFE.
 f. THE INTRINSICALLY SAFE APPARATUS SHALL BE INTRINSICALLY SAFE.
 g. THE INTRINSICALLY SAFE APPARATUS SHALL BE INTRINSICALLY SAFE.
 h. THE INTRINSICALLY SAFE APPARATUS SHALL BE INTRINSICALLY SAFE.
 i. THE INTRINSICALLY SAFE APPARATUS SHALL BE INTRINSICALLY SAFE.
 j. THE INTRINSICALLY SAFE APPARATUS SHALL BE INTRINSICALLY SAFE.
 k. THE INTRINSICALLY SAFE APPARATUS SHALL BE INTRINSICALLY SAFE.
 l. THE INTRINSICALLY SAFE APPARATUS SHALL BE INTRINSICALLY SAFE.
 m. THE INTRINSICALLY SAFE APPARATUS SHALL BE INTRINSICALLY SAFE.
 n. THE INTRINSICALLY SAFE APPARATUS SHALL BE INTRINSICALLY SAFE.
 o. THE INTRINSICALLY SAFE APPARATUS SHALL BE INTRINSICALLY SAFE.
 p. THE INTRINSICALLY SAFE APPARATUS SHALL BE INTRINSICALLY SAFE.
 q. THE INTRINSICALLY SAFE APPARATUS SHALL BE INTRINSICALLY SAFE.
 r. THE INTRINSICALLY SAFE APPARATUS SHALL BE INTRINSICALLY SAFE.
 s. THE INTRINSICALLY SAFE APPARATUS SHALL BE INTRINSICALLY SAFE.
 t. THE INTRINSICALLY SAFE APPARATUS SHALL BE INTRINSICALLY SAFE.
 u. THE INTRINSICALLY SAFE APPARATUS SHALL BE INTRINSICALLY SAFE.
 v. THE INTRINSICALLY SAFE APPARATUS SHALL BE INTRINSICALLY SAFE.
 w. THE INTRINSICALLY SAFE APPARATUS SHALL BE INTRINSICALLY SAFE.
 x. THE INTRINSICALLY SAFE APPARATUS SHALL BE INTRINSICALLY SAFE.
 y. THE INTRINSICALLY SAFE APPARATUS SHALL BE INTRINSICALLY SAFE.
 z. THE INTRINSICALLY SAFE APPARATUS SHALL BE INTRINSICALLY SAFE.
 1. ANY SINGLE SHUNT ZENER DIODE SAFETY BARRIER APPROVED BY FM HAVING THE FOLLOWING OUTPUT PARAMETERS:
 $V_{oc} OR V_i NOT GREATER THAN 30 V$
 $I_{sc} OR I_i NOT GREATER THAN 200 mA$
 $P_{max} NOT GREATER THAN 0.9 W$
 NOTES: UNLESS OTHERWISE SPECIFIED

HAZARDOUS AREA
 IS CLASS I, II, III,
 DIVISION 1,
 GROUPS A, B, C, D, E, F, G;
 NI CLASS I.

APPROVED CONDUCTIVITY
 SENSORS
 222, 225, 226, 228,
 242 & 245

ROSEMOUNT MODEL 375
 FIELD COMMUNICATOR
 REMOTE TRANSMITTER
 INTERFACE FOR USE IN
 CLASS I AREA ONLY
 (SEE TABLE I)

MODEL XMT-T-FI XMITR

HAZARDOUS AREA

NON-HAZARDOUS AREA

UNSPECIFIED POWER SUPPLY
 17.5 VDC MAX

SAFETY BARRIER
 (SEE NOTES 1 & 9)

LOAD

WARNING-
 SUBSTITUTION OF COMPONENTS MAY IMPAIR INTRINSIC SAFETY OR
 SUITABILITY FOR DIVISION 2.

WARNING-
 TO PREVENT IGNITION OF FLAMMABLE OR COMBUSTIBLE ATMOSPHERES,
 DISCONNECT POWER BEFORE SERVICING.

THIS DOCUMENT IS
 CERTIFIED BY
 FM REV. A
 REV. _____
 REV. _____
 REV. _____
 REV. _____
 REV. _____
 REVISIONS NOT PERMITTED
 WITHOUT APPROVAL

TABLE I

XMT-T-FI ENTITY PARAMETERS				
SUPPLY / SIGNAL TERMINALS TB2-1, 2 AND 3				
MODEL NO.	Vmax (Vdc)	Imax (mA)	Pmax (W)	Li (mH)
XMT-T-FI	17.5	380	5.32	0.4
				0

ENTITY PARAMETERS: REMOTE TRANSMITTER INTERFACE				
MODEL NO.	Vmax IN: Vdc	Imax IN: mA	Pmax IN: W	Li (mH)
375	30	200	1.0	0.0
				0.0
				1.9
				Iss max OUT: uA

UNLESS OTHERWISE SPECIFIED		PART NO.		DESCRIPTION		QTY	
XX : 00	XXXXXX	APPROVALS	DATE	ITEM	DESCRIPTION	TYPE	REV
XX : 00	XXXXXX	B. JOHNSON	9/15/04	UNILIC	UNILIC		
XX : 00	XXXXXX	J. FLOCK	1/8/04	SCHEMATIC INSTALLATION	SCHEMATIC INSTALLATION		
XX : 00	XXXXXX	J. FLOCK	1/8/04	MOD XMT-T-FI XMITR	MOD XMT-T-FI XMITR		
XX : 00	XXXXXX	J. FLOCK	1/8/04	(FM APPROVALS)	(FM APPROVALS)		
XX : 00	XXXXXX	J. FLOCK	1/8/04	THIS DWG CONVERTED TO SOLIDEDGE	THIS DWG CONVERTED TO SOLIDEDGE		
XX : 00	XXXXXX	J. FLOCK	1/8/04	1400302	1400302		

10-6-04
 RELEASE DATE
 9064
 ECONO. REV

1400302
 REVISION
 DESCRIPTION
 DATE
 BY
 DATE
 CHK

1
 2
 3
 4
 5
 6
 7
 8

FIGURE 4-14. FM Intrinsically Safe Installation for Model Xmt-T-FI

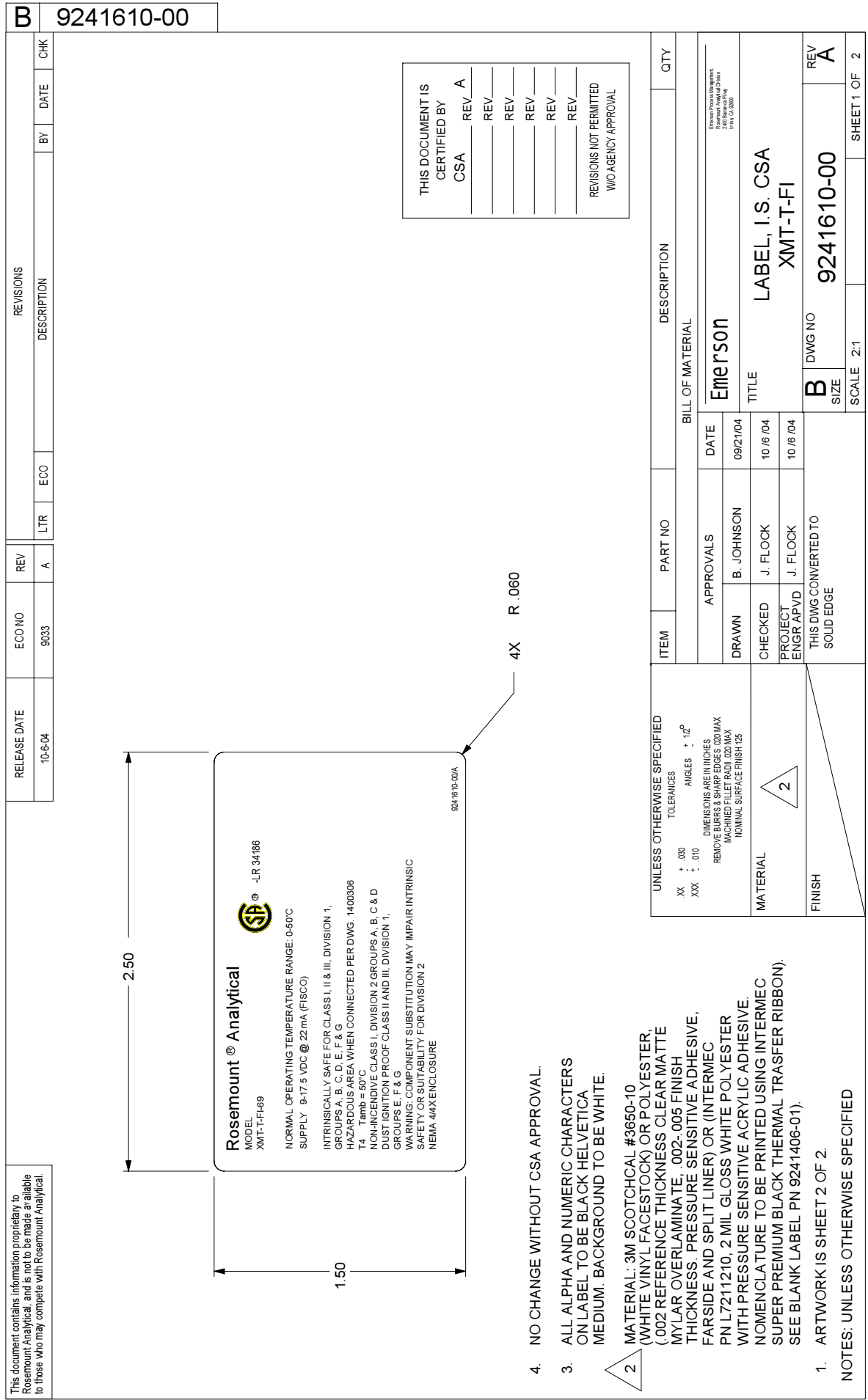
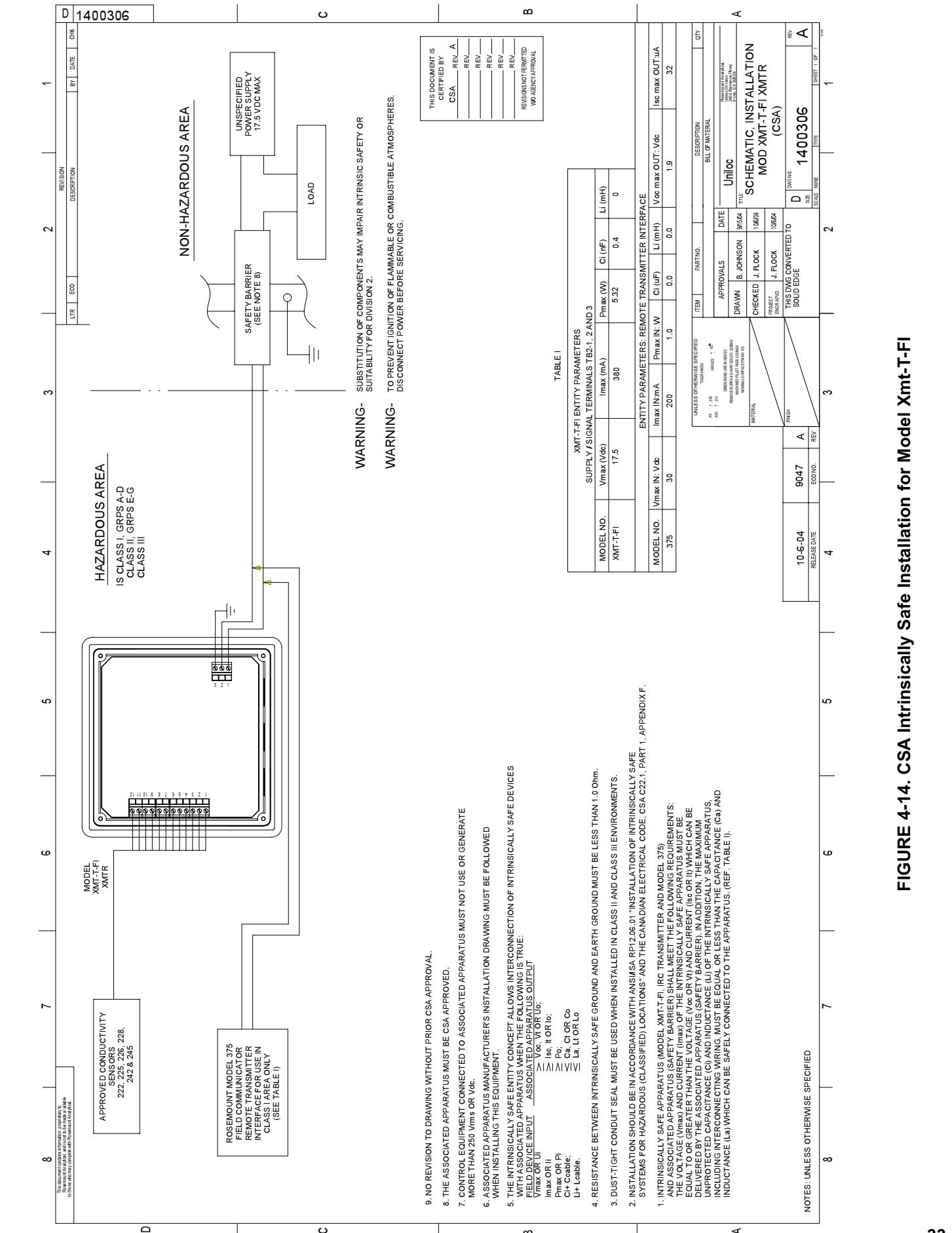

FIGURE 4-15. CSA Intrinsically Safe Label for Model Xmt-T-FI



1	2	3	4	5	6	7	8
REVISION		DATE		BY		CHK	
DESCRIPTION							
LTR		ECO		REV		DATE	
1400306							

HAZARDOUS AREA
IS CLASS I, GRPS A-D
CLASS II, GRPS E-G
CLASS III

NON-HAZARDOUS AREA

MODEL XMT-T-FI XMTR

APPROVED CONDUCTIVITY SENSORS
222, 225, 226, 242 & 245

ROSEMOUNT MODEL 375
FIELD COMMUNICATOR
REMOTE TRANSMITTER
INTERFACE FOR USE IN
CLASS II, III ONLY
(SEE TABLE I)

SAFETY BARRIER
(SEE NOTE 6)

UNSPECIFIED
POWER SUPPLY
17.5 VDC MAX

LOAD

WARNING- SUBSTITUTION OF COMPONENTS MAY IMPAIR INTRINSIC SAFETY OR SUITABILITY FOR DIVISION 2.

WARNING- TO PREVENT IGNITION OF FLAMMABLE OR COMBUSTIBLE ATMOSPHERES, DISCONNECT POWER BEFORE SERVICING.

THIS DOCUMENT IS CERTIFIED BY

CSA	REV. A
REV.	
REV.	
REV.	
REV.	
REASONS NOT PERMITTED	
WFO AGENCY APPROVAL	

TABLE I

XMT-T-FI ENTITY PARAMETERS

MODEL NO.	SUPPLY / SIGNAL TERMINALS TB2-1, 2 AND 3		
	Vmax (Vdc)	Imax (mA)	Li (mH)
XMT-T-FI	17.5	380	0
	Pmax (W)	Ci (nF)	Li (mH)
	5.32	0.4	0

ENTITY PARAMETERS: REMOTE TRANSMITTER INTERFACE

MODEL NO.	Vmax IN: Vdc	Imax IN: mA	Pmax IN: W	Ci (uF)	Li (mH)	Voc max OUT: Vdc	Isc max OUT: uA
375	30	200	1.0	0.0	0.0	1.9	32

UNLESS OTHERWISE SPECIFIED

WFO AGENCY APPROVAL

APPROVALS

DATE	DATE
06/04	06/04
B. JOHNSON	J. FLOCK
CHECKED	CHECKED
J. FLOCK	J. FLOCK
DATE	DATE
06/04	06/04

TITLE

SCHEMATIC, INSTALLATION
MOD XMT-T-FI XMTR
(CSA)

UNITOC

SCALE

1:1

REV

1400306

RELEASE DATE

10-6-04

ECO. NO.

9047

REV

A

REV

A

NOTES: UNLESS OTHERWISE SPECIFIED

- INTRINSICALLY SAFE APPARATUS (MODEL XMT-T-FI, IRC TRANSMITTER AND MODEL 375) AND ASSOCIATED APPARATUS (SAFETY BARRIER) SHALL MEET THE FOLLOWING REQUIREMENTS: THE VOLTAGE (Vmax) AND CURRENT (Imax) OF THE INTRINSICALLY SAFE APPARATUS MUST BE EQUAL TO OR GREATER THAN THE VOLTAGE (Voc or Vi) AND CURRENT (Isc or Ii) WHICH CAN BE DELIVERED BY THE ASSOCIATED APPARATUS (SAFETY BARRIER). IN ADDITION, THE MAXIMUM UNPROTECTED CAPACITANCE (Ci) AND INDUCTANCE (Li) OF THE INTRINSICALLY SAFE APPARATUS, INDUCTANCE (Lb) WHICH CAN BE SAFELY CONNECTED TO THE APPARATUS. (REF: TABLE I).
- INSTALLATION SHOULD BE IN ACCORDANCE WITH ANSI/ISA RP12.05 01 "INSTALLATION OF INTRINSICALLY SAFE SYSTEMS FOR HAZARDOUS (CLASSIFIED) LOCATIONS" AND THE CANADIAN ELECTRICAL CODE, CSA C22.1, PART 1, APPENDIX F.
- DUST-TIGHT CONDUIT SEAL MUST BE USED WHEN INSTALLED IN CLASS II AND CLASS III ENVIRONMENTS.
- RESISTANCE BETWEEN INTRINSICALLY SAFE GROUND AND EARTH GROUND MUST BE LESS THAN 1.0 Ohm.

- NO REVISION TO DRAWING WITHOUT PRIOR CSA APPROVAL.
- THE ASSOCIATED APPARATUS MUST BE CSA APPROVED.
- CONTROL EQUIPMENT CONNECTED TO ASSOCIATED APPARATUS MUST NOT USE OR GENERATE MORE THAN 250 Vrms OR Vdc.
- ASSOCIATED APPARATUS MANUFACTURER'S INSTALLATION DRAWING MUST BE FOLLOWED WHEN INSTALLING THIS EQUIPMENT.

THE INTRINSICALLY SAFE ENTITY CONCEPT ALLOWS INTERCONNECTION OF INTRINSICALLY SAFE DEVICES WITH ASSOCIATED APPARATUS WHEN THE FOLLOWING IS TRUE:

1. ASSOCIATED APPARATUS (SAFETY BARRIER) MUST BE CSA APPROVED.

2. CONTROL EQUIPMENT CONNECTED TO ASSOCIATED APPARATUS MUST NOT USE OR GENERATE MORE THAN 250 Vrms OR Vdc.

3. ASSOCIATED APPARATUS MANUFACTURER'S INSTALLATION DRAWING MUST BE FOLLOWED WHEN INSTALLING THIS EQUIPMENT.

THE INTRINSICALLY SAFE ENTITY CONCEPT ALLOWS INTERCONNECTION OF INTRINSICALLY SAFE DEVICES WITH ASSOCIATED APPARATUS WHEN THE FOLLOWING IS TRUE:

1. ASSOCIATED APPARATUS (SAFETY BARRIER) MUST BE CSA APPROVED.

2. CONTROL EQUIPMENT CONNECTED TO ASSOCIATED APPARATUS MUST NOT USE OR GENERATE MORE THAN 250 Vrms OR Vdc.

3. ASSOCIATED APPARATUS MANUFACTURER'S INSTALLATION DRAWING MUST BE FOLLOWED WHEN INSTALLING THIS EQUIPMENT.

1. INTRINSICALLY SAFE APPARATUS (MODEL XMT-T-FI, IRC TRANSMITTER AND MODEL 375) AND ASSOCIATED APPARATUS (SAFETY BARRIER) SHALL MEET THE FOLLOWING REQUIREMENTS: THE VOLTAGE (Vmax) AND CURRENT (Imax) OF THE INTRINSICALLY SAFE APPARATUS MUST BE EQUAL TO OR GREATER THAN THE VOLTAGE (Voc or Vi) AND CURRENT (Isc or Ii) WHICH CAN BE DELIVERED BY THE ASSOCIATED APPARATUS (SAFETY BARRIER). IN ADDITION, THE MAXIMUM UNPROTECTED CAPACITANCE (Ci) AND INDUCTANCE (Li) OF THE INTRINSICALLY SAFE APPARATUS, INDUCTANCE (Lb) WHICH CAN BE SAFELY CONNECTED TO THE APPARATUS. (REF: TABLE I).

INSTALLATION SHOULD BE IN ACCORDANCE WITH ANSI/ISA RP12.05 01 "INSTALLATION OF INTRINSICALLY SAFE SYSTEMS FOR HAZARDOUS (CLASSIFIED) LOCATIONS" AND THE CANADIAN ELECTRICAL CODE, CSA C22.1, PART 1, APPENDIX F.

DUST-TIGHT CONDUIT SEAL MUST BE USED WHEN INSTALLED IN CLASS II AND CLASS III ENVIRONMENTS.

RESISTANCE BETWEEN INTRINSICALLY SAFE GROUND AND EARTH GROUND MUST BE LESS THAN 1.0 Ohm.

NO REVISION TO DRAWING WITHOUT PRIOR CSA APPROVAL.

THE ASSOCIATED APPARATUS MUST BE CSA APPROVED.

CONTROL EQUIPMENT CONNECTED TO ASSOCIATED APPARATUS MUST NOT USE OR GENERATE MORE THAN 250 Vrms OR Vdc.

ASSOCIATED APPARATUS MANUFACTURER'S INSTALLATION DRAWING MUST BE FOLLOWED WHEN INSTALLING THIS EQUIPMENT.

THE INTRINSICALLY SAFE ENTITY CONCEPT ALLOWS INTERCONNECTION OF INTRINSICALLY SAFE DEVICES WITH ASSOCIATED APPARATUS WHEN THE FOLLOWING IS TRUE:

1. ASSOCIATED APPARATUS (SAFETY BARRIER) MUST BE CSA APPROVED.

2. CONTROL EQUIPMENT CONNECTED TO ASSOCIATED APPARATUS MUST NOT USE OR GENERATE MORE THAN 250 Vrms OR Vdc.

3. ASSOCIATED APPARATUS MANUFACTURER'S INSTALLATION DRAWING MUST BE FOLLOWED WHEN INSTALLING THIS EQUIPMENT.

THIS DOCUMENT IS CERTIFIED BY

CSA	REV. A
REV.	
REV.	
REV.	
REV.	
REASONS NOT PERMITTED	
WFO AGENCY APPROVAL	

FIGURE 4-14. CSA Intrinsically Safe Installation for Model Xmt-T-Fi

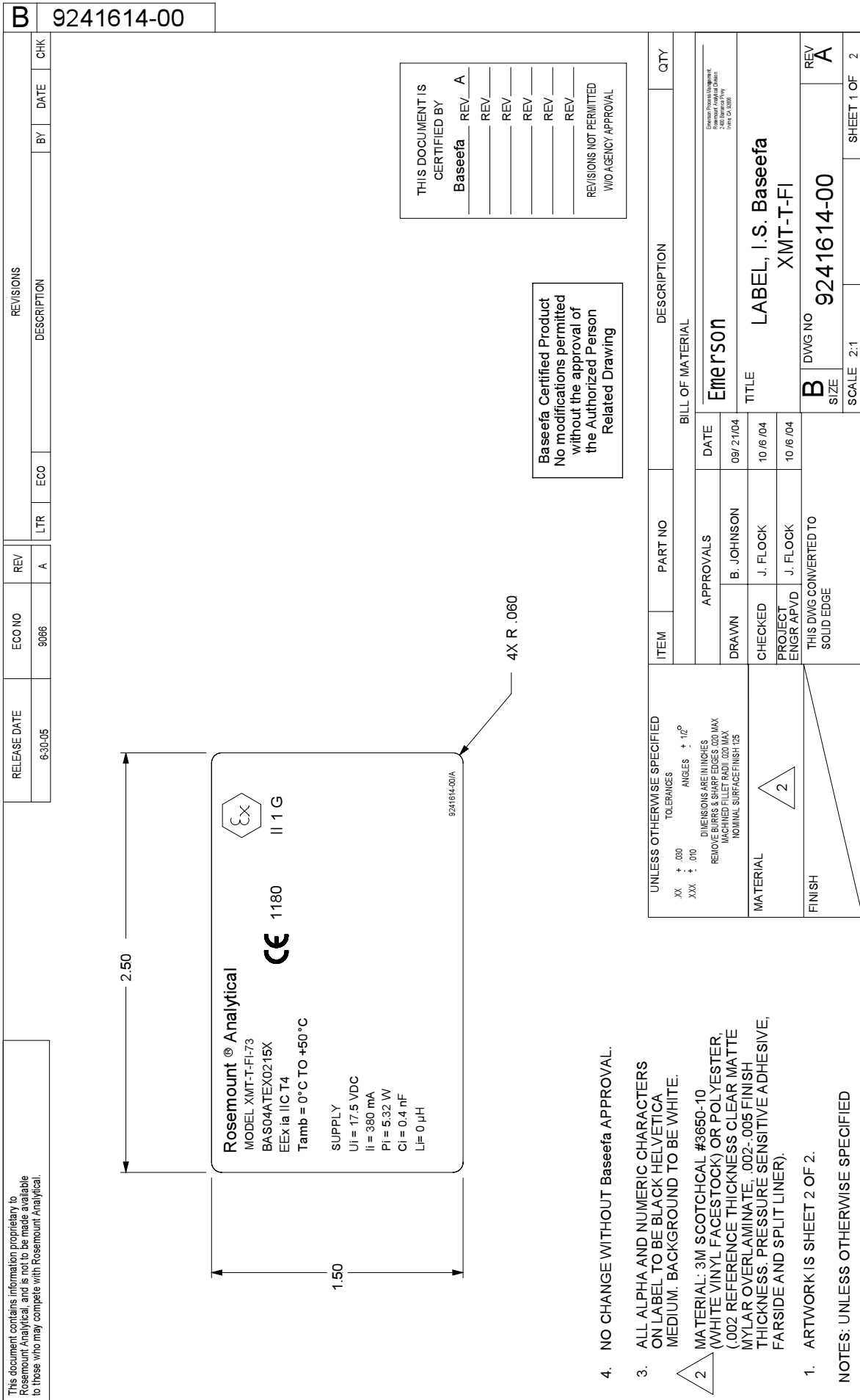

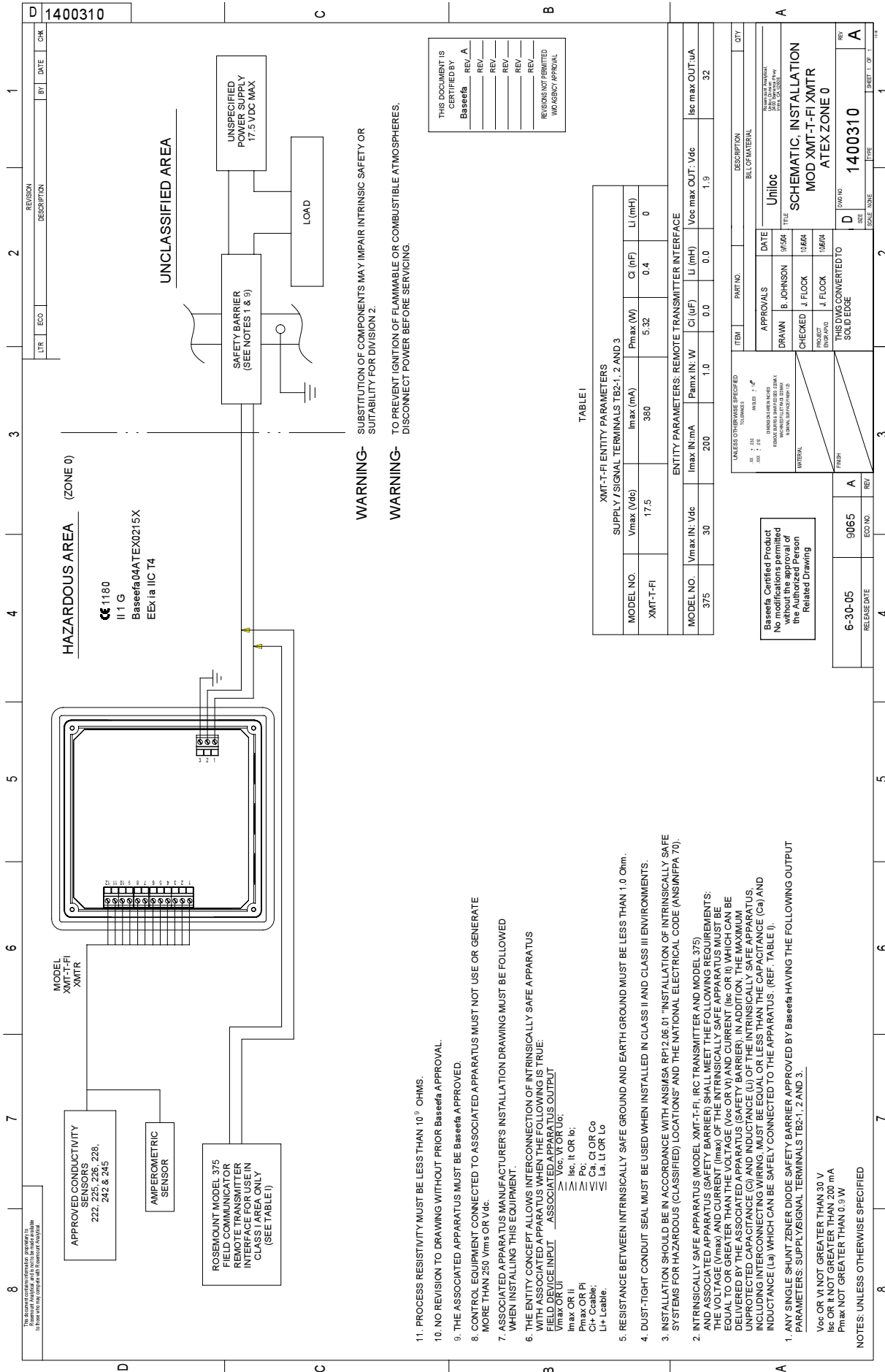

FIGURE 4-16. ATEX Intrinsically Safe Installation for Model Xmt-T-Fi

SECTION 5.0 DISPLAY AND OPERATION

5.1. DISPLAY

The Model Xmt-T has a two-line display. Generally, the user can program the transmitter to show one of three displays. If the transmitter has been configured to measure total dissolved solids, conductivity, or percent concentration, similar displays are available. Figure 5-1 shows the displays available for conductivity.

The transmitter has information screens that supplement the data in the main display. Press ▼ to view the information screens. The first information screen shows the type of measurement being made (conductivity, % concentration, TDS, custom). **The last information screen is the software version number.**

During calibration and programming, key presses cause different displays to appear. The displays are self-explanatory and guide the user step-by-step through the procedure.

5.2 KEYPAD

Figure 5-2 shows the Solu Comp Xmt keypad.

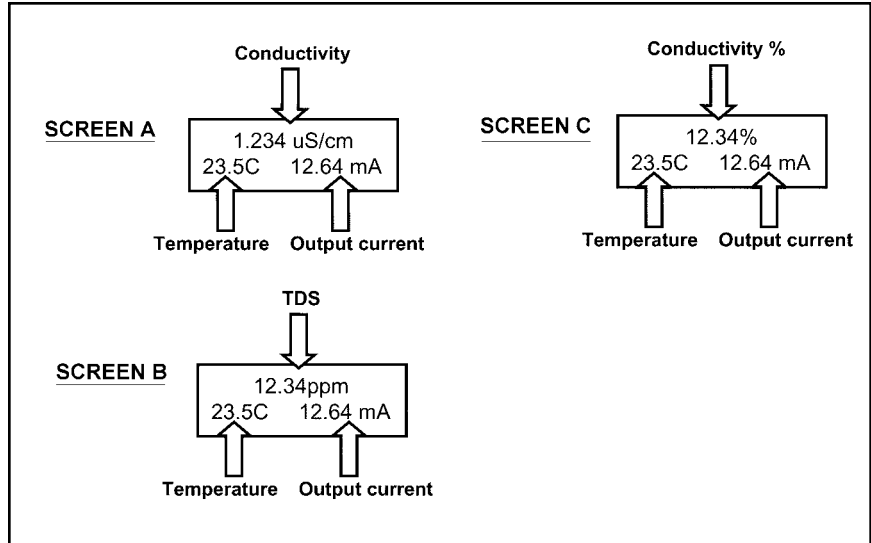

FIGURE 5-1. Displays During Normal Operation

Screen A shows the conductivity reading, the temperature, and the output current generated by the transmitter. Screen B shows the same information as Screen A except conductivity is shown as percent of scale. Screen C shows conductivity as parts per million total dissolved solids.

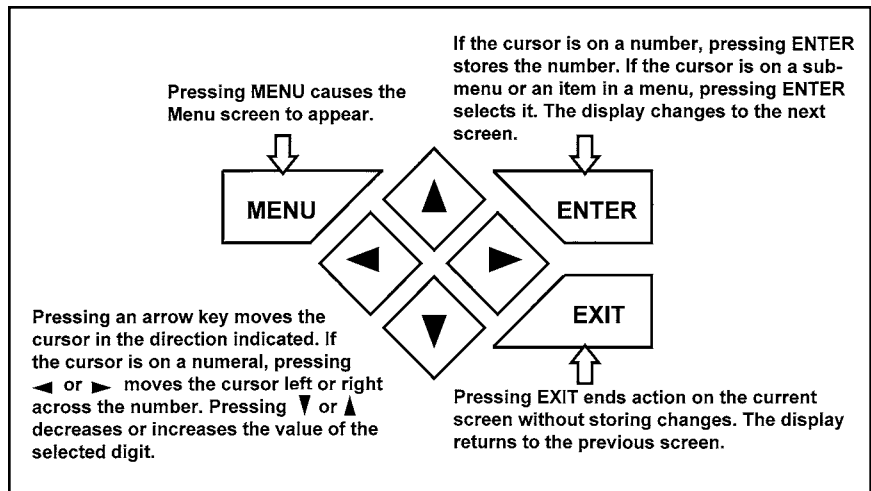

FIGURE 5-2. Solu Comp Xmt Keypad

Four arrow keys move the cursor around the screen. A blinking word or numeral show the position of the cursor. The arrow keys are also used to change the value of a numeral. Pressing ENTER stores numbers and settings and moves the display to the next screen. Pressing EXIT returns to the previous screen without storing changes. Pressing MENU always causes the main menu screen to appear. Pressing MENU followed by EXIT causes the main display to appear.

5.3 PROGRAMMING AND CALIBRATING THE MODEL XMT - TUTORIAL

Setting up and calibrating the Model Xmt is easy. The following tutorial describes how to move around in the programming menus. For practice, the tutorial also describes how to assign values to the 4 and 20 mA output.

Calibrate	Hold
Program	Display

Calibrate	Hold
Program	Display

Output	Temp
Measurement	>>

Security	HART
ResetAnalyzer	>>

Output?	Test
Configure	Range

Output Range?	
4mA	200 μ S/cm

Output Range?	
20mA	2000 μ S/cm

Output?	Test
Configure	Range

1. If the menu screen (shown at the left) is not already showing, press MENU. **Calibrate** is blinking, which means the cursor is on **Calibrate**.
2. To assign values to the current output, the **Program** sub-menu must be open. Press \blacktriangledown . The cursor moves to **Program** (**Program** blinking.) Press ENTER. Pressing ENTER opens the **Program** sub-menu.
3. The **Program** sub-menu permits the user to configure and assign values to the 4-20 mA output, to test and trim the output, to change the type of measurement from what was selected during Quick Start, to set manual or automatic temperature correction for membrane permeability, and to set security codes. When the sub-menu opens, **Output** is blinking, which means the cursor is on **Output**. Press \blacktriangledown or \blacktriangleright (or any arrow key) to move the cursor around the display. Move the cursor to \gg and press ENTER to cause a second screen with more program items to appear. There are three screens in the **Program** sub-menu. Pressing \gg and ENTER in the third screen cause the display to return to the first screen (**Output, Temp, Measurement**).
4. For practice, assign values to the 4 and 20 mA output. Move the cursor to **Output** and press ENTER.
5. The screen shown at left appears. **Test** is blinking. Move the cursor to **Range** and press ENTER.
6. The screen shown at left appears. + is blinking, which means the cursor is on +.
 - a. To toggle between + and - press \blacktriangle or \blacktriangledown .
 - b. To move from one digit to the next, press \blacktriangleleft or \blacktriangleright .
 - c. To increase or decrease the value of a digit, press \blacktriangle or \blacktriangledown .
 - d. To move the decimal point, press \blacktriangleleft or \blacktriangleright until the cursor is on the decimal point. Press \blacktriangle to move the decimal to the right. Press \blacktriangledown to move the decimal point to the left.
 - e. Press ENTER to store the number.
7. The screen shown at left appears. Use this screen to assign a full scale value to the 20 mA output. Use the arrow keys to change the number to the desired value. Press ENTER to store the setting.
8. The screen shown at left appears. To configure the output or to test the output, move the cursor to the appropriate place and press ENTER.
9. To return to the main menu, press MENU. To return to the main display, press MENU then EXIT, or press EXIT repeatedly until the main display appears. To return to the previous display, press EXIT.

NOTE

To store values or settings, press ENTER before pressing EXIT.

5.4 MENU TREES — TOROIDAL CONDUCTIVITY

The Model Xmt-T-HT transmitter has four menus: CALIBRATE, PROGRAM, HOLD, and DISPLAY. Under the Calibrate and Program menus are several sub-menus. For example, under CALIBRATE, the sub-menus are **Conductivity**, **% Concentration**, and **Temperature**. Under each sub-menu are prompts. Under PROGRAM, the sub-menus for Xmt-T-HT are **Output**, **Temp**, **Measurement**, **Security**, **HART**, and **Reset Analyzer**. The HOLD menu (HART only) enables or disables the 4-20 mA outputs. The DISPLAY menu allows the user to configure the main display information fields and to adjust the LCD display contrast. Figure 5-3 shows the complete menu tree for Model Xmt-T-HT. Figure 5-4 shows the complete menu tree for Model Xmt-T-FF.

5.5 DIAGNOSTIC MESSAGES

Whenever a warning or fault limit has been exceeded, the transmitter displays diagnostic messages to aid in troubleshooting. “Fault” or “Warn” appears in the main display to alert the user of an adverse condition. The display alternates between the regular display and the Fault or Warning message. If more than one warning or fault message has been generated, the messages appear alternately.

FIGURE 5-3. MENU TREE FOR MODEL SOLU COMP Xmt-T-HT TRANSMITTER

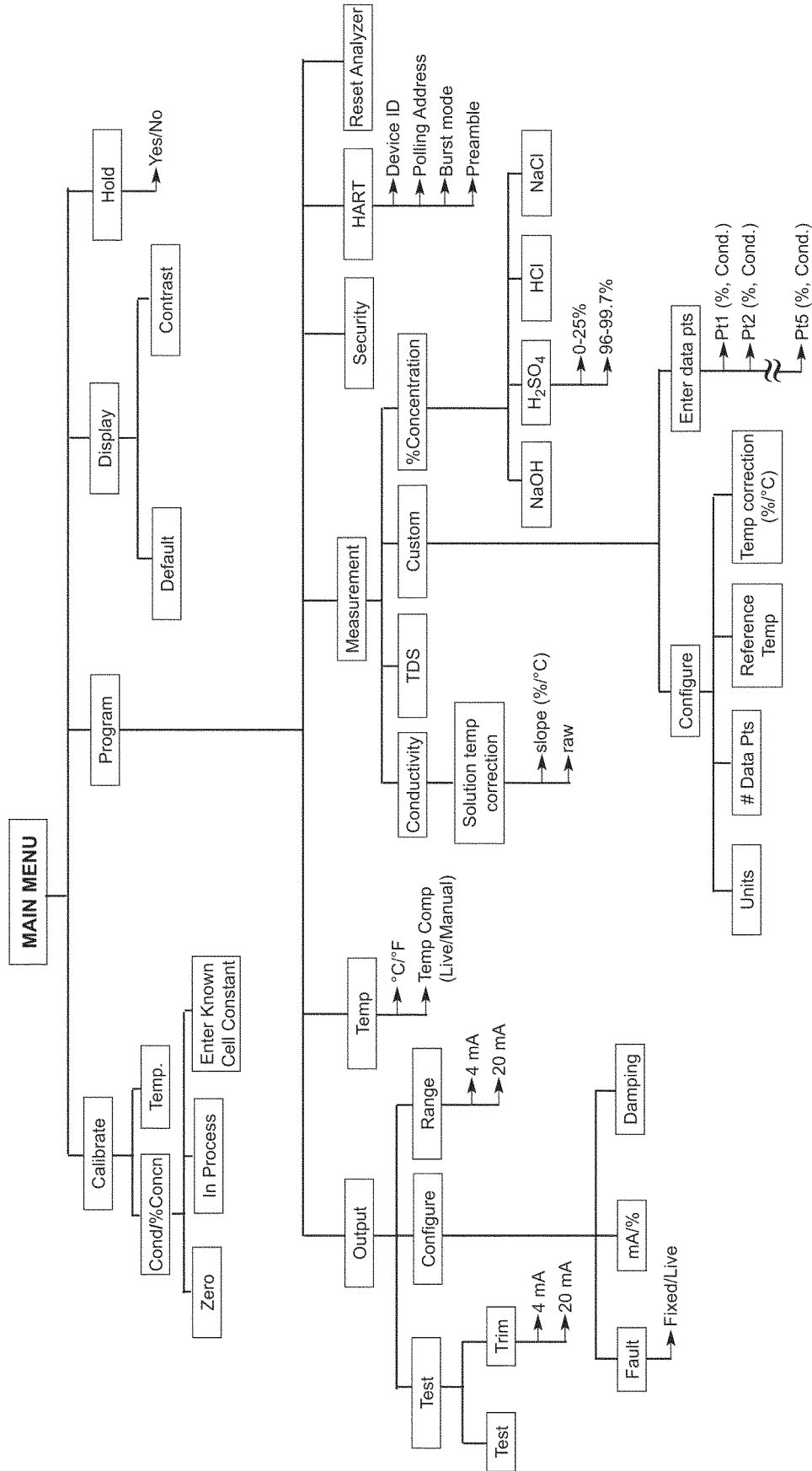
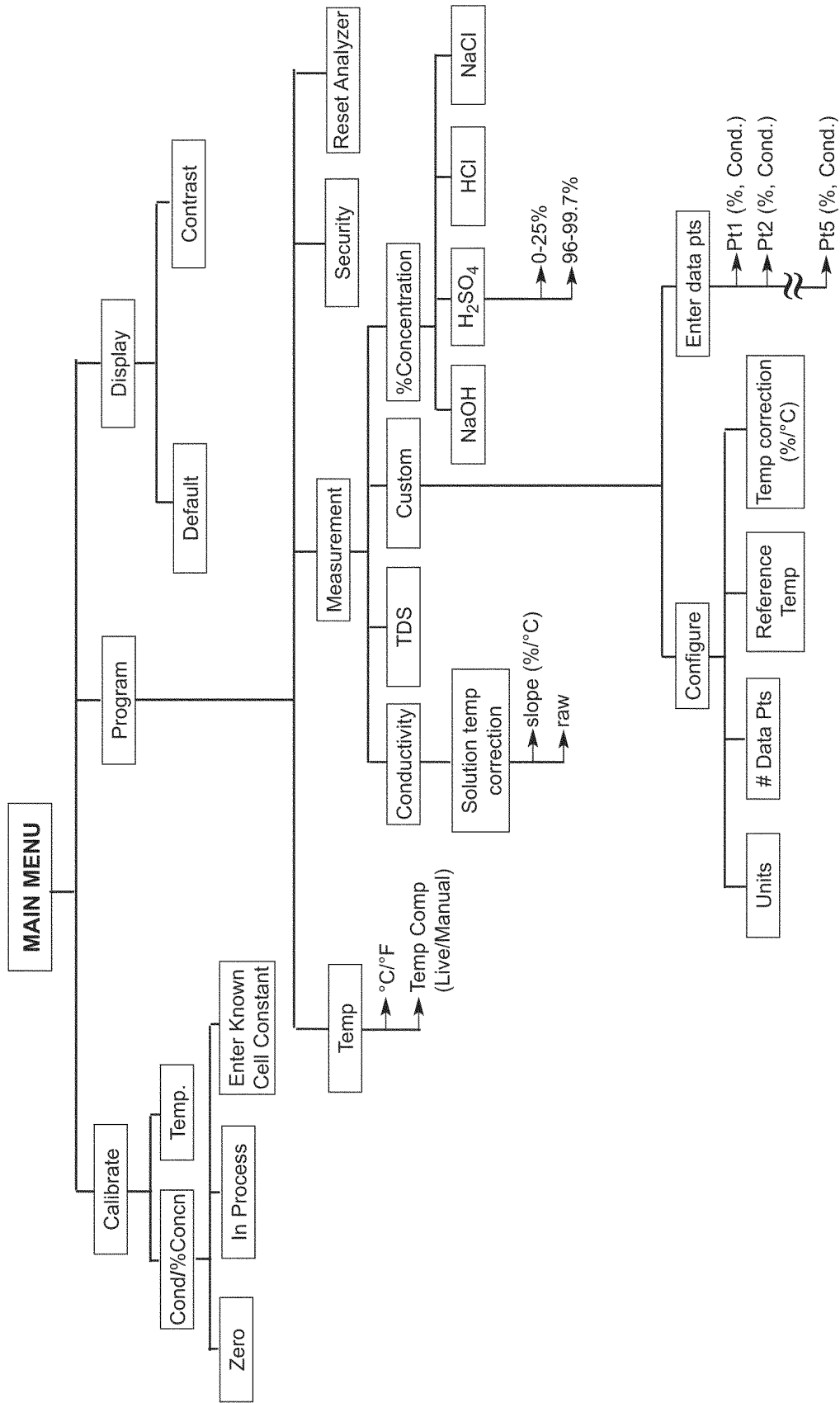

FIGURE 5-4. MENU TREE FOR MODEL SOLU COMP Xmt-T-FF TRANSMITTER



5.6 SECURITY

5.6.1 How the Security Code Works

Use security codes to prevent accidental or unwanted changes to program settings, displays, and calibration. Two three-digit security codes can be used to do the following...

- a. Allow a user to view the default display and information screens only.
- b. Allow a user access to the calibration and hold menus only.
- c. Allow a user access to all the menus.

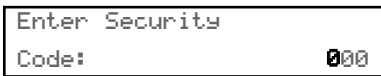

1. If a security code has been programmed, pressing MENU causes the security screen to appear.
2. Enter the three-digit security code.
 - a. If a security code has been assigned to **configure** only, entering it will unlock all the menus.
 - b. If separate security codes have been assigned to **calibrate** and **configure**, entering the calibrate code will allow the user access to only the calibrate and hold menus; entering the configuration code will allow the user access to all menus.
3. If the entered code is correct, the main menu screen appears. If the code is incorrect, the **Invalid Code** screen appears. The **Enter Security Code** screen reappears after two seconds.

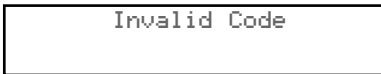

5.6.2 Bypassing the Security Code

Enter 555. The main menu will open.

5.6.3 Setting a Security Code

See Section 7.6.

5.7 USING HOLD (HART version only)

5.7.1 Purpose

The transmitter output is always proportional to the process variable (conductivity or resistivity). To prevent improper operation of control systems or dosing pumps, place the transmitter in hold before removing the sensor for maintenance. Be sure to remove the transmitter from hold once the work is complete and the sensor has been returned to the process liquid. During hold the transmitter current goes to the value programmed by the user. Once in hold, the transmitter remains there indefinitely. While in hold, the word "hold" appears periodically in the display.

5.7.2 Using the Hold Function

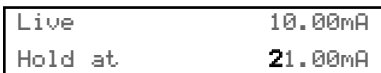
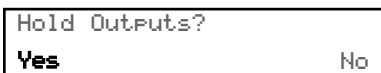

1. Press MENU. The main menu screen appears. Choose **Hold**.
2. The **Hold Output** screen appears. Choose **Yes** to put the transmitter in hold.
3. The top line in the display is the present current output. Use the arrow keys to change the number in the second line to the desired current during hold.
4. The main display screen appears.
5. To take the transmitter out of hold, repeat steps 1 and 2 and choose **No** in step 2.

SECTION 6.0 OPERATION WITH MODEL 375

6.1 Note on Model 375 HART and Foundation Fieldbus Communicator

The Model 375 HART Communicator is a product of Emerson Process Management, Rosemount Inc. This section contains selected information on using the Model 375 with the Rosemount Analytical Model Xmt-T-HT Transmitter and Model Xmt-T-FF Transmitter. For complete information on the Model 375 Communicator, see the Model 375 instruction manual. For technical support on the Model 375 Communicator, call Rosemount Inc. at (800) 999-9307 within the United States. Support is available worldwide on the internet at <http://rosemount.com>.

6.2 Connecting the HART and Foundation Fieldbus Communicator

Figure 6-1 shows how the Model 275 or 375 Communicator connects to the output lines from the Model Xmt-T Transmitter.

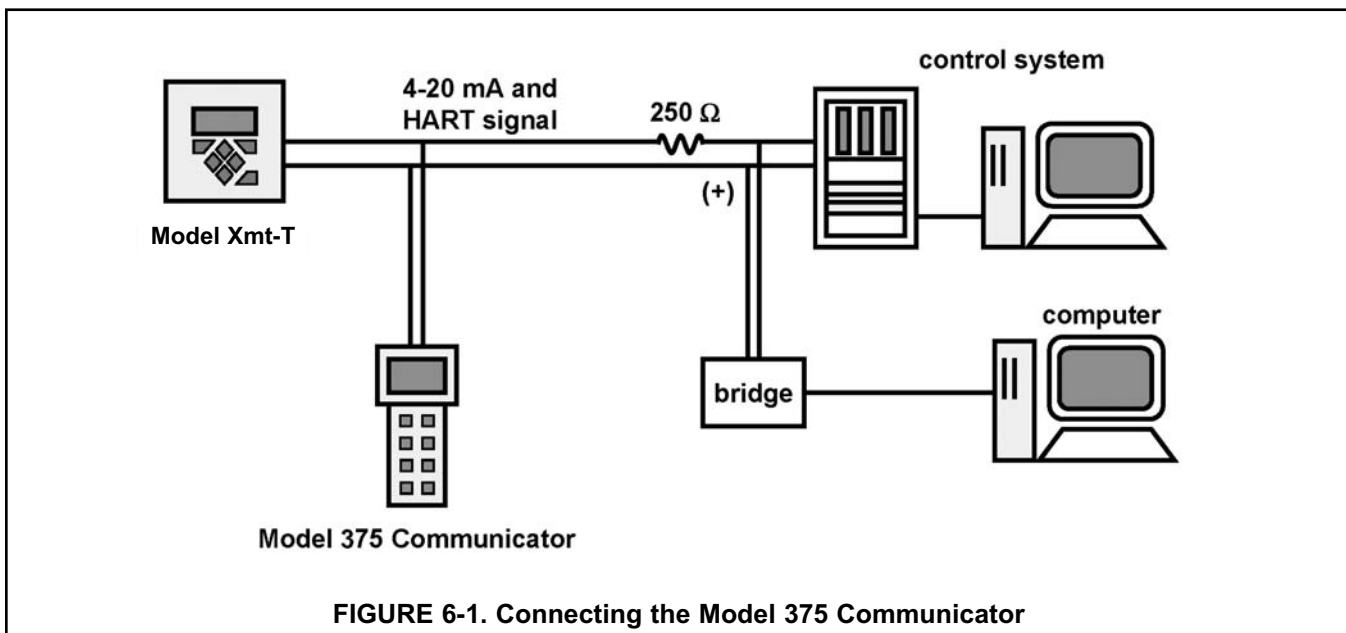
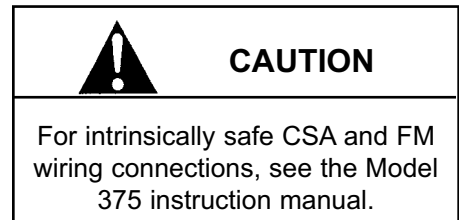

6.3 Operation

6.3.1 Off-line and On-line Operation

The Model 375 Communicator features off-line and on-line communications. On-line means the communicator is connected to the transmitter in the usual fashion. While the communicator is on line, the operator can view measurement data, change program settings, and read diagnostic messages. Off-line means the communicator is not connected to the transmitter. When the communicator is off line, the operator can still program settings into the communicator. Later, after the communicator has been connected to a transmitter, the operator can transfer the programmed settings to the transmitter. Off-line operation permits settings common to several transmitters to be easily stored in all of them.

6.3.2 Making HART related settings from the keypad

Calibrate	Hold
Program	Display

1. Press MENU. The main menu screen appears. Choose **Program**.

Output	Temp
Measurement	>>

2. Choose >>.

Security	HART
	>>

3. Choose **HART**.

DevID	PollAddr
Burst	Preamble

4. To display the device ID, choose **DevID**. To change the polling address, choose **PollAddr**. To make burst mode settings, choose **Burst**. To change the preamble count, choose **Preamble**.

6.3.3 Menu Tree

The menu tree for the Model 275 and Model 375 HART communicators are on the following pages.

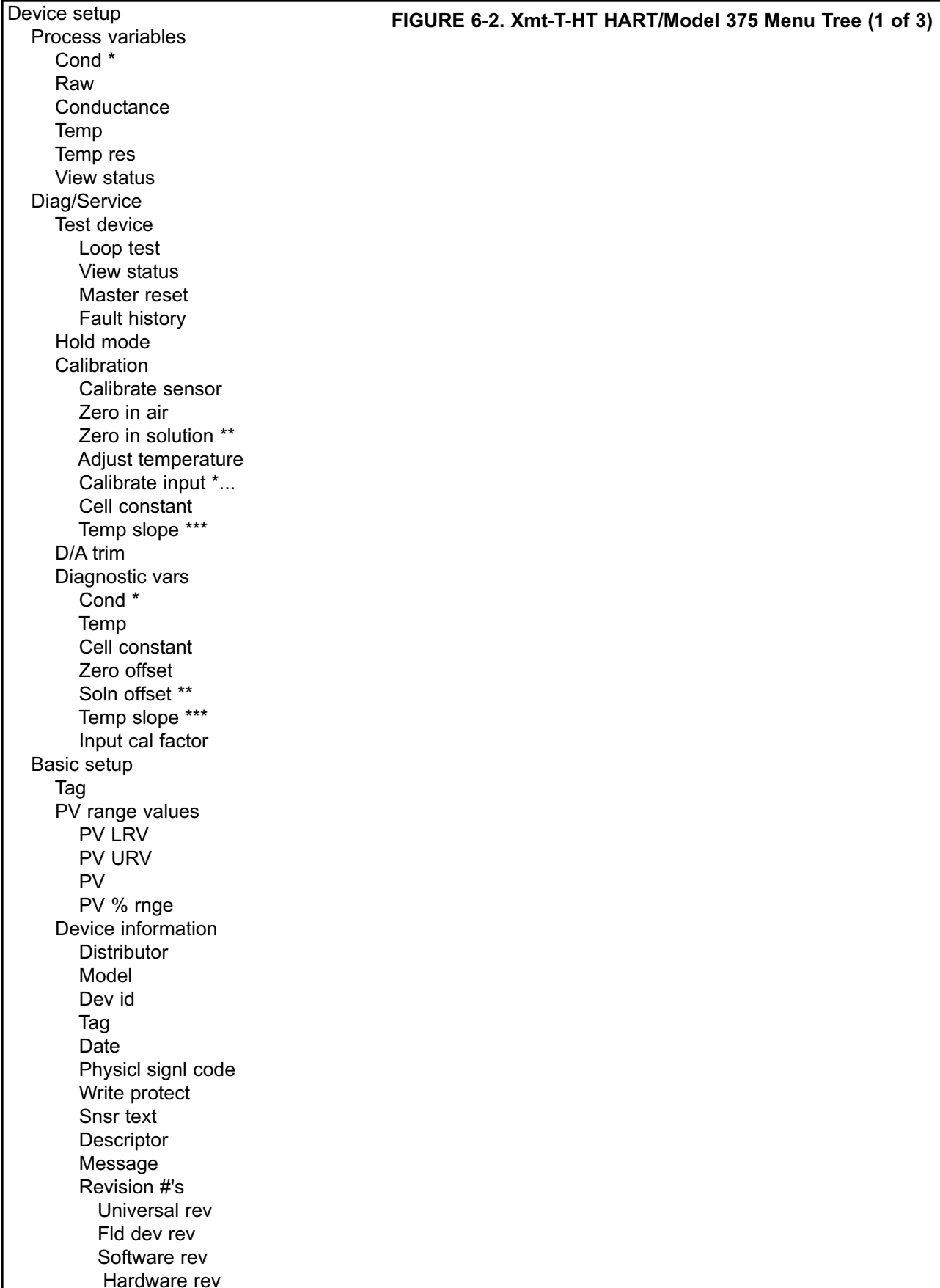

Detailed setup

FIGURE 6-2. Xmt-T-HT HART/Model 375 Menu Tree (2 of 3)

Sensors

Main sensor

PV Type [Conductivity, Resistivity, 0-12% NaOH, 0-15% HCl, 0-25% H2SO4, 96-99.7% H2SO4, 0-20% NaCl, TDS, Custom]

PV Snsr unit [uS/cm, uS/m, mS/cm, mS/m, Mohm-cm, %, ppm, _]

Cond unit [uS/cm, uS/m, mS/cm, mS/m] ****

Define curve ****

View custom points ****

Cell constant

Temp comp type [Linear, Neutral salt, Cation, None/Off] *..

Temp slope ***

Ref temp *** AND * , ****

PV sensor type

Sensor information

LSL

USL

Min span

Temperature

ATC [On, Off]

Man temp

Temp unit [°C, °F]

Temp snsr [RTD PT100, RTD PT1000, Manual]

Diag override

PV>display limit [ON, OFF]

EE write Error [ON, OFF]

EE chksum Error [ON, OFF]

EE buf overflow [ON, OFF]

% out of range [ON, OFF]

Need zero cal [ON, OFF]

Temperature high [ON, OFF]

Temperature low [ON, OFF]

Sense line open [ON, OFF]

Need factory cal [ON, OFF]

Input Overrange [ON, OFF]

A2D Read Error [ON, OFF]

RTDohm overrange [ON, OFF]

RTD open [ON, OFF]

Signal condition

LRV

URV

AO Damp

% rng

Xfer fnctn

AO1 lo end point

AO1 hi end pt

Output condition

Analog output

AO1

AO Alrm typ

Fixed

Fault mode [Fixed, Live]

Fault

Loop test

D/A trim

FIGURE 6-2. Xmt-T-HT HART/Model 375 Menu Tree (3 of 3)

HART output	
PV is Process	
SV is Temperature	
TV is Raw process	
Poll addr	
Burst option [PV, %range/current, Process vars/crnt]	
Burst mode [Off, On]	
Num req preams	
Num resp preams	
Device information	
Distributor	
Model	
Dev id	
Tag	
Date	
Physicl signl code	
Write protect	
Snsr text	
Descriptor	
Message	
Revision #'s	
Universal rev	
Fld dev rev	
Software rev	
Hardware rev	
Local Display	
AO LOI units [mA, %]	
LOI cfg code	
LOI cal code	
Load Default Conf.	
Review	
PV	
PV AO	
PV LRV	
PV URV	

Notes:	
* Can be Cond, Res, NaOH, HCl, H2SO4, NaCl, TDS or Custom	
** Valid only when PV Type = NaOH, HCl, 0-25% H2SO4, or NaCl	
*** Valid only when Temp comp type = Linear	
**** Valid only when PV Type = Custom	
*. Valid only when PV Sensor Type = Toroidal	
*.. Valid only when PV Type = Conductivity or Resistivity. For contacting sensors, the item list is [Linear, Neutral salt, Cation, None/off]. For toroidal sensors, the item list is [Linear, None/off].	
*... Valid only when PV Sensor Type = Contacting	
/* Xmt CT done */	

SECTION 7.0

CALIBRATION — TEMPERATURE

7.1 INTRODUCTION

The Calibrate Menu allows the user to calibrate the conductivity readings and temperature response of the sensor.

7.2 CALIBRATING TEMPERATURE

7.2.1 Purpose

This procedure is used to ensure an accurate temperature measurement by the temperature sensor. It enables the instrument to display process temperature accurately as well as to compensate for the effect of temperature on the conductivity reading when the temperature in your process changes. The following steps should be performed with the sensor in the process or in a grab sample near the operating temperature of the process.

7.2.2 Procedure

1. Check the instrument temperature reading (main display) to make sure the sensor has acclimated to the process temperature. Compare the instrument temperature to a calibrated temperature reading device. Proceed to the next step if the reading requires adjustment.

Calibrate	Hold
Program	Display

2. Press MENU. The menu screen appears. Choose **Calibrate**.

Cal?	Conductivity
	Temperature

3. Choose **Temperature**.

Live	25.0°C
Cal	+025.0°C

4. To calibrate the temperature, change the number in the second line to match the temperature measured **in the process**. Press ENTER.
5. Press MENU then EXIT to return to the main display.

SECTION 8.0 CALIBRATION — CONDUCTIVITY

The following procedures are described in this section:

- Entering the cell constant (Section 8.2)
- Zeroing the transmitter (Section 8.3)
- Calibrating the sensor in a Conductivity Standard (Section 8.4)
- Entering the temperature slope (Section 8.5)

8.1 INTRODUCTION

Calibration is the process of adjusting or standardizing the transmitter to a lab test (such as free acid titration) or a calibrated laboratory instrument, or standardizing to some known reference (such as a commercial chemical standard). Calibration ensures that the transmitter reads an accurate, and therefore, repeatable reading of conductivity and temperature. This section contains procedures for the first time use and for routine calibration of the Model Xmt-T transmitter.

Since conductivity measurements are affected by temperature, the Model Xmt-T reads the temperature at the probe and compensates for the changing temperature by referencing all conductivity measurements to 25°C (77°F).

To ensure the transmitter's accuracy, it is important to perform all the calibration procedures provided in this section if you are:

- installing this unit for the first time
- changing or replacing a probe
- troubleshooting

After the initial calibration, the accuracy of the conductivity reading should be checked periodically against some known standard of conductivity and temperature.

Entering the cell constant, zeroing the instrument, and calibrating the sensor should be done when first commissioning the Xmt and when changing the conductivity probe. These operations should be conducted with the conductivity probe wired to the transmitter with full length of extension cable (if any) for best results.

8.2 ENTERING THE CELL CONSTANT

The cell constant should be entered:

- When the unit is installed for the first time
- When the probe is replaced
- During troubleshooting

This procedure sets up the transmitter for the probe type connected to the transmitter. Each type of probe has a specific cell constant:

- Small toroidal (Model 228 or 225) = 3.0
- Large toroidal (Model 226) = 1.0
- Flow-through toroidal (Model 222): 1-inch = 6.0; 2-inch = 4.0

All cell constants can be located on the cable label of the conductivity probe.

```
Cal?      InProcess
Zero      >>
```

```
Enter Cell Const
TEMP Slope >>
```

```
Cell Constant?
          1.0000/cm
```

1. Press MENU. The main menu appears. Choose **Calibrate**. Press ENTER.
2. Choose **Conductivity**. Press ENTER. The screen at the left will appear.
3. Scroll right with the right arrow key. The screen at the left will appear.
4. Choose **Enter Cell Constant**. The screen at the left will appear.
5. Enter the actual cell constant as printed on the sensor tag attached to the sensor cable. Alternatively, you can enter the Nominal Cell Constant as shown in the table below for the inductive conductivity sensor to be used.

TOROIDAL SENSORS								
Conductivity Sensor Model	226	228	225	222 (1in.)	222 (2 in.)	242	245	247
Nominal Cell Constant	1.0	3.0	3.0	6.0	4.0	*	*	3.5
Minimum Conductivity (µS/cm)	50	200	200	500	500	100*	100*	500
Maximum Conductivity (µS/cm)	1,000,000	2,000,000	2,000,000	2,000,000	2,000,000	2,000,000*	2,000,000	2,000,000

* Model 242 values depend on sensor configuration and wiring.

Values shown are for 25°C conductivity with a temperature slope of 2% per degree C. The maximum range value will be lower for solutions with a higher temperature slope. Minimum conductivity depends on sensor.

NOTE

For sensors that show a "cal constant" on the label, the actual cell constant can be calculated adding 500 to the cal constant, multiply this value by the nominal cell constant, then divide the result by 1000.

6. Press ENTER. All conductivity readings will reference this sensor-specific cell constant.
7. Press EXIT once.

NOTE

The cell constant you are about to enter is changed after the Standardizing Conductivity procedure is performed. **For inductive sensors and contacting sensors that only show nominal cell constants, do not change it back to the value on the probe.**

8.3 ZEROING THE INSTRUMENT

This procedure is used to compensate for small offsets to the conductivity signal that are present even when there is no conductivity to be measured. This procedure is affected by the length of extension cable and should always be repeated if any changes in extension cable or sensor have been made. **Electrically connect the conductivity probe as it will actually be used and place the measuring portion of the probe in air.**

```
Cal?      Conductivity
          Temperature
```

1. If continuing from the previous procedure, the screen on the left will appear.

```
Sensor must be
dry and in air
```

2. Choose **Conductivity**. Press ENTER.

```
Live      1.000µS
Zeroing   Wait
```

3. Choose **Zero**. Press ENTER. The screens at the left will appear briefly during zeroing.

Verify that the sensor is actually in air. If the displayed value is not very close to zero, pressing ENTER will establish a new zero. While setting the zero, the message "wait" is displayed. A slight variation from zero is to be expected, and the procedure may be repeated several times, if necessary. A successful zero is indicated with a message of "Zero Done."

An unsuccessful zero will result if the conductivity reading is more than 1000 µS/cm or if the reading is too unstable. The "Sensor Zero Fail" message indicates the reading is too high for the zero routine. If repeated attempts do not result in an acceptable zero, there is a good chance that there is a wiring problem.

```
Live      0.000µS
Sensor Zero Done
```

4. After electronic zeroing, the screen at the left showing the zero calibration value (negative mS) will appear followed by the Calibration menu screen.

8.4 CALIBRATING THE SENSOR IN A CONDUCTIVITY STANDARD

This procedure is used to check and correct the conductivity reading of the Model Xmt-T to ensure that the reading is accurate. This is done by submerging the probe in the sample of known conductivity, then adjusting the displayed value, if necessary, to correspond to the conductivity value of the sample.

This procedure must always be done after cleaning the probe. The temperature reading must also be checked and standardized if necessary, prior to performing this procedure.

1. Be sure that the probe has been cleaned of heavy deposits of dirt, oils, or chemical residue.
2. Commercial standards are referenced to a known temperature, for example, 4000 micromhos at 25°C (77°F). As the temperature of the standard changes, the conductivity will change. Therefore it is recommended that this procedure be performed at a temperature between 22 and 28 °C. **Be sure the probe has reached a stable temperature before standardizing.**
3. Pour the standard into a clean container. Submerge the clean probe in the standard. Place the probe so that a minimum of 1 in. of liquid surrounds the probe. Do not allow the probe to be closer than 1 in. to the sides or bottom of the container. Shake the probe slightly to eliminate any trapped air bubbles. Observe the displayed conductivity to determine if the sensor needs to be moved.

Alternatively, the probe can be calibrated while inserted in the process. This is done by adjusting the Model Xmt-T conductivity reading to the known conductivity of the process water which is close to the probe to be calibrated.

Live	10.00µS/cm
Cal	10.00µS/cm

Cal in progress.
Please wait.

Updated	Cell
Const:	1.0013/cm

- a. From the Calibration menu screen, choose **In Process**. Press ENTER. The screen at the left will appear.
- b. Using the arrow keys, enter the actual conductivity of the conductivity standard or the known conductivity value in µS/cm. Press ENTER. The screens at the left will appear during this standardization process.

The conductivity reading in the display will change to the new value and the cell constant or cell factor will be recalculated. The cell factor can be viewed in the information screens.

If too large an adjustment is attempted, the transmitter will display "calibration error" and no change will be made.

8.5 CALIBRATING TEMPERATURE SLOPE

Temperature has a significant effect on the conductivity signal. The size of this effect depends on what kind of liquid is being measured. This procedure is used to adjust the type of compensation used by the transmitter.

Temperature compensation is in the form of a constant slope of 0-5%/°C. The table below lists some representative values of temperature slopes. The temperature slope currently being used by the transmitter is shown. If this value is acceptable, press Exit. 2%/°C is a good value for natural waters. For more specialized applications, use the representative values in the table. To change the temperature slope, complete the following procedure.

TYPICAL TEMPERATURE SLOPES

Chemical	Slope (%/°C)
Cleaner (alkaline)	2.25
Cleaner (acid)	1.4
Conversion coating	1.6
Rinse Water	2.0

```
Cal?      InProcess
Zero      >>
```

```
Enter Cell Const
Temp Slope >>
```

```
Temperature
Slope?    2.00% C
```

1. If continuing from the previous steps, the screen on the left will appear.
2. Scroll right until the screen at the left appears. Choose **Temp Slope**. Press ENTER.
3. Enter the percent change of conductivity ($\mu\text{S}/\text{cm}$) per degree Centigrade. Press ENTER. All conductivity readings will be temperature-compensated according to the linear slope constant that you have manually entered.

SECTION 9.0 PROGRAMMING THE TRANSMITTER

9.1 GENERAL

This section describes how to program the transmitter using the keypad.

1. Configure and assign values to the 4-20 mA output [-HT version only] (Section 9.3)
2. Test and trim the current output [-HT version only] (Section 9.3)
3. Select the measurement to be made [conductivity, TDS, % concentration, or custom] (Section 9.4)
4. Choose temperature units and automatic or manual temperature mode (Section 9.5)
5. Set a security code (Section 9.6)
6. Resetting factory default settings (Section 9.8)
7. Selecting a default display screen and adjusting screen contrast (Section 9.9)

9.2 CHANGING START-UP SETTINGS

When the Solu Comp Xmt is powered up for the first time, startup screens appear. The screens prompt the user to enter the measurement being made and enter the cell constant of the sensor being used, to select a specific conductivity concentration curve (if % Concentration was selected), and to select temperature units. If incorrect settings were entered at startup, enter the correct settings now. To change the measurement, refer to Section 9.4.

9.3 CONFIGURING AND RANGING THE OUTPUT (-HT version only)

9.3.1 Purpose

1. Configuring an output means
 - a. displaying the output reading in units of mA or percent of full scale.
 - b. changing the time constant for output dampening.
 - c. assigning the value the output current will take if the transmitter detects a fault in itself or the sensor.
2. Ranging the output means assigning values to the 4 mA and 20 mA outputs.
3. Testing an output means entering a test value from the keypad to check the operation of recorders or transmitters.
4. Trimming an output means calibrating the 4 and 20 mA current outputs against a referee milliammeter.

9.3.2 Definitions

1. CURRENT OUTPUT. The transmitter provides a continuous 4-20 mA output current directly proportional to the pH of the sample.
2. FAULT. The transmitter continuously monitors itself and the sensor for faults. If the transmitter detects a fault, the 4-20 mA output can be programmed to go to a fixed value or it can be programmed to continue to display the live current reading. In any event Fault appears intermittently in the second line of the display.
3. DAMPEN. Output dampening smooths out noisy readings. But it also increases the response time of the output. To estimate the time (in minutes) required for the output to reach 95% of the final reading following a step change, divide the setting by 20. Thus, a setting of 140 means that, following a step change, the output takes about seven minutes to reach 95% of final reading. The output dampen setting does not affect the response time of the process display. The maximum setting is 255.
4. TEST. The transmitter can be programmed to generate a test current.

9.3.3 Procedure: Configuring the Output

Calibrate	Hold
Program	Display

1. Press MENU. The menu screen appears. Choose **Program**.

Output	Temp
Measurement	>>

2. Choose **Output**.

Output?	Test
Configure	Range

3. Choose **Configure**.

Configure?	Fault
mA/%	Damping

4. Choose **Fault**.

Set to value?	
Fixed	Live

5. Choose **Fixed** or **Live**.

Current Output	
if Fault:	22.00mA

6. If you chose **Fixed**, the screen at left appears. Use the arrow keys to change the fault current to the desired value. The limits are 4.00 to 22.00 mA. If you chose **Live**, there are no settings to make.

Configure?	Fault
mA/%	Damping

7. The screen at left appears. Choose **mA/%**.

Display Output?	
mA	percent

8. Choose **mA** or **percent**. Percent means the display will show percent of full scale reading.

Configure?	Fault
mA/%	Damping

9. The screen at left appears. Choose **Damping**.

Damping?	000 255
	000 sec

10. Use the arrow keys to change the blinking display to the desired time constant.

9.3.4 Procedure: Ranging the output

Calibrate	Hold
Program	Display

1. From the main display, press MENU. The menu screen appears. Choose **Program**.

Output	Temp
Measurement	>>

2. Choose **Output**.

Output?	Test
Configure	Range

3. Choose **Range**.

Output range?	
4mA	200µS/cm

4. Assign a value to the 4 mA output and press ENTER. Then assign a value to the 20 mA output. Press ENTER. Use the arrow keys to change the flashing display to the desired value.

9.3.5 Procedure: Testing the output

Calibrate	Hold
Program	Display

1. From the main display, press MENU. The menu screen appears. Choose **Program**.

Output	Temp
Measurement	>>

2. Choose **Output**.

Output?	Test
Configure	Range

3. Choose **Test**.

Test Output
Trim Output

4. Choose **Test Output**.

Current Output
for Test: 12.00mA

5. Use the arrow keys to change the displayed current to the desired value. Press ENTER. The output will change to the value just entered.

6. To return to normal operation, press EXIT. The output will return to the value determined by the process variable.

7. To return to the main display, press MENU then EXIT.

9.3.6 Procedure: Trimming the output

1. Connect an accurate milliammeter in series with the current output.

Calibrate	Hold
Program	Display

2. Press MENU. The menu screen appears. Choose **Program**.

Output	Temp
Measurement	>>

3. Choose **Output**.

Output?	Test
Configure	Range

4. Choose **Test**.

Test Output
Trim Output

5. Choose **Trim Output**.

Meter reading:
04.00mA

6. The output goes to 4.00 mA. If the milliammeter does not read 4.00 mA, use the arrow keys to change the display to match the current measured by the milliammeter. Press ENTER.

Meter reading:
20.00mA

7. The output goes to 20.00 mA. If the milliammeter does not read 20.00 mA, use the arrow keys to change the display to match the current measured by the milliammeter. Press ENTER.

Trim Complete

8. To return to the main display, press MENU then EXIT.

9.4 CHOOSING AND CONFIGURING THE ANALYTICAL MEASUREMENT

9.4.1 Purpose

This section describes how to do the following:

1. Configure the transmitter to measure conductivity, % concentration, or TDS.
2. If % concentration was selected, one of the following concentration curves must be selected:
 - a. NaOH
 - b. H₂SO₄ (0-25%, 96-99.7%)
 - c. HCl
 - d. NaCl

9.4.2 Procedure: Measurement.

To choose a menu item, move the cursor to the item and press ENTER.
To store a number or setting, press ENTER.

Calibrate	Hold
Program	Display

1. Press MENU. The main menu screen appears. Choose **Program**.

Outputs	Temp
Measurement	>>

2. Choose **Measurement**.

Measure?	Cond
TDS	Custom %Conc

3. Choose **Conductivity**, **TDS**, **Custom**, or **% Concentration**.

If you chose **Conductivity** or **TDS**, no further measurement programming is required.

If you chose **% Concentration**, do steps 7 and 8.

If you chose **Custom**, see Quick Start, step 8.

Unit?	(μS mS)/cm
(μ S mS S)/m	

4. For **Conductivity**, select measurement units: (μ S, mS)/cm or (μ S, mS, S)/m

Temp Correction?	
Slope	Raw/None

5. Choose **slope** or **raw/none** for temperature correction.

Temperature	
Slope?	2.00%/C

6. If you chose **Slope**, enter the linear conductivity change in percent per degrees (C or F). Press ENTER.

%Conc?	NaCl
NaOH	H2SO4 HCl

7. For % Concentration measurement, select the process solution that best represents your measurement application — NaCl, NaOH, H₂SO₄, or HCl. If you chose H₂SO₄, select 0-25% or 96-99.7%.

H2SO4 Range?	
0 25%	96 99.7%

8. To return to the main display, press MENU followed by EXIT.

9.5 CHOOSING TEMPERATURE UNITS AND MANUAL OR AUTOMATIC TEMPERATURE COMPENSATION

9.5.1 Purpose

This section describes how to do the following:

1. Choose temperature display units (°C or °F).
2. Choose automatic or manual temperature compensation.
3. Enter a temperature for manual temperature compensation

9.5.2 Definitions

1. **AUTOMATIC TEMPERATURE COMPENSATION.** The analyzer uses a temperature-dependent factor to convert raw conductivity to temperature-compensated conductivity. In automatic temperature compensation, the analyzer measures the temperature and automatically calculates the correct conversion factor unless **Slope** (user-entered) or **Raw/None** was selected. For maximum accuracy, use automatic temperature compensation.
2. **MANUAL TEMPERATURE COMPENSATION.** In manual temperature compensation, the analyzer converts raw conductivity to temperature-compensated conductivity using the temperature entered by the user. It does not use the actual process temperature. Manual temperature compensation is useful if the sensor temperature element has failed and a replacement sensor is not available. If manual temperature correction is selected, the display will not show the measured temperature. It will show the manually entered value.

9.5.3 Procedure: Temperature.

To choose a menu item, move the cursor to the item and press ENTER.

To store a number or setting, press ENTER.

Calibrate	Hold
Program	Display

Outputs	TEMP
Measurement	>>

Config TEMP?	
°C/F	Live/Manual

1. Press MENU. The main menu screen appears. Choose **Program**.
2. Choose **Temp**.
3. Choose **°C/F** to change temperature units. Choose **Live/Manual** to turn on (Live) or turn off (Manual) automatic temperature compensation.
 - a. If **°C/F** is chosen, select **°C** or **°F** in the next screen.
 - b. If **Live/Manual** is chosen, select **Live** or **Manual** in the next screen.
 - c. If **Manual** is chosen, enter the temperature in the next screen. The temperature entered in this step will be used in all subsequent measurements, no matter what the process temperature is.

9.6 SETTING A SECURITY CODE

9.6.1 Purpose

This section describes how to set a security code. There are three levels of security:

- a. A user can view the default display and information screens only.
- b. A user has access to the calibration and hold menus only.
- c. A user has access to all menus.

The security code is a three-digit number. The table shows what happens when security codes are assigned to **Calib** (calibration) and **Config** (configure). In the table XXX and YYY are the assigned security codes. To bypass security, enter 555.

Code assignments		What happens
Calib	Config	
000	XXX	User enters XXX and has access to all menus.
XXX	YYY	User enters XXX and has access to calibration and hold menus only. User enters YYY and has access to all menus.
XXX	000	User needs no security code to have access to all menus.
000	000	User needs no security code to have access to all menus.

9.6.2 Procedure: Setting a security code

Calibrate	Hold
Program	Display

Outputs	Temp
Measurement	>>

Security	HART
Reset Analyzer	>>

Lock?	
Calib	Config

1. Press MENU. The menu screen appears. Choose **Program**.
2. Choose >>.
3. Choose **Security**.
4. Choose **Calib** or **Config**.
 - a. If you chose **Calib**, enter a three-digit security code.
 - b. If you chose **Config**, enter a three-digit security code.
5. To return to the main display, press MENU the EXIT.

9.7 MAKING HART RELATED SETTINGS

For more information refer to Section 6.0.

9.8 RESETTING FACTORY CALIBRATION AND FACTORY DEFAULT SETTINGS

9.8.1 Purpose

This section describes how to install factory calibration and default values. The process also clears all fault messages and returns the display to the first quick start screen.

9.8.2 Procedure: Installing default settings

Calibrate	Hold
Program	Display

1. Press MENU. The menu screen appears. Choose **Program**.

Outputs	Temp
Measurement	>>

2. Choose >>.

Security	HART
Reset Analyzer	>>

3. Choose **ResetTransmitter**.

Load factory		
settings?	Yes	No

4. Choose **Yes** or **No**. Choosing **Yes** clears previous settings and calibrations and returns the transmitter to the first quick start screen.

9.9 SELECTING A DEFAULT SCREEN AND SCREEN CONTRAST

9.9.1 Purpose

This section describes how to do the following:

1. Set a default screen. The default screen is the screen shown during normal operation. The Solu Comp Xmt allows the user to choose from a number of screens. Which screens are available depends on the measurement the transmitter is making.
2. Change the screen contrast.

9.9.2 Procedure: Choosing a display screen.

```
Calibrate           Hold
Program            Display
```

```
Default Display
Display Contrast
```

1. Press MENU. The menu screen appears. Choose **Display**.
2. Choose **Default Display**.
3. Press ↓ until the desired screen appears. Press ENTER. One of two display screen layouts can be selected for any measurement selected.
4. The display returns to the screen in step 2. Press MENU then EXIT to return to the main display.

9.9.3 Procedure: Changing screen contrast.

```
Calibrate           Hold
Program            Display
```

```
Default Display
Display Contrast
```

```
Display contrast
Lighter             Darker
```

1. Press MENU. The menu screen appears. Choose **Display**.
2. Choose **Display Contrast**.
3. To increase the contrast, select **darker**. Press ENTER. Each key press increases the contrast. To reduce the contrast, select **lighter**, Press ENTER. Each key press decreases the contrast.
4. To return to the main display, press MENU then EXIT.

NOTE:

Screen contrast can also be adjusted from the main display. Press MENU and ↑ at the same time to increase contrast. Press MENU and ↓ at the same time to decrease contrast. Repeatedly pressing the arrow key increases or reduces the contrast.

SECTION 10.0 MAINTENANCE

10.1 OVERVIEW

The Solu Comp Xmt needs little routine maintenance. The calibration of the analyzer and sensor should be checked periodically. To recalibrate the sensor and analyzer, refer to sections 9 through 14.

10.2 REPLACEMENT PARTS

Only a few components of the analyzer are replaceable. Refer to the tables below. Circuit boards, display, and enclosure are not replaceable.

REPLACEMENT PARTS FOR SOLU COMP XMT (PANEL MOUNT VERSION)

PART NUMBER	DESCRIPTION	SHIPPING WEIGHT
23823-00	Panel mounting kit, includes four brackets and four set screws	1 lb/0.5 kg
33654-00	Gasket, front, for panel mount version	1 lb/0.5 kg
33658-00	Gasket, rear cover, for panel mount version	1 lb/0.5 kg

REPLACEMENT PARTS FOR SOLU COMP XMT (PIPE/SURFACE MOUNT VERSION)

PART NUMBER	DESCRIPTION	SHIPPING WEIGHT
33655-00	Gasket for pipe/surface mount version	1 lb/0.5 kg
23833-00	Surface mount kit, consists of four self tapping screws and four O-rings	1 lb/0.5 kg

SECTION 11.0 THEORY OF OPERATION

11.1 CONDUCTIVITY / % CONCENTRATION

Liquids can only conduct electrical currents when they contain particles that carry charges. These particles are called ions, and they are produced when acids, bases, and salts are mixed with water. The conductivity of a substance determines how well it can carry electrical currents and is used to indicate the concentration of acids, bases, and salts in water.

Conductance is the reciprocal of resistance. The traditional unit of conductance is mho, a term representing the reciprocal of ohm. Recently, the unit siemen has replaced the mho, but the amount of conductance is exactly the same. Liquid water has relatively low conductivity, so measurements are expressed in millisiemens (.001 siemen) or microsiemens (.000001 siemen), and abbreviated as mS or μ S, respectively.

The Model Xmt-T conductivity transmitter is a device used to measure conductivity in most chemical processes. Conductivity is a function of ion concentration, ionic charge, and ion mobility. Ions in water conduct current when an electrical potential is applied across electrodes immersed in the solution.

Model Xmt-T is designed for use with inductive (toroidal) probes for measurement of high conductivity. Generally, inductive probes are used for conductivity above 200 microsiemens. This sensor design is more sensitive to high-level measurement and water solutions that tend to foul the sensor.

For % concentration measurement, the Model Xmt-T transmitter uses the measured temperature and absolute conductivity and applies specific algorithms that have been developed for each of the substances available in the instrument.

11.2 TEMPERATURE CORRECTION

The conductivity of an electrolyte solution depends strongly on temperature. To allow comparison among measurements made at different temperatures, conductivity values are usually converted to the value at 25°C. The Model Xmt-T performs the correction automatically with a user-programmable linear temperature coefficient (slope). Temperature correction can also be turned off. If temperature correction is off, the Model Xmt-T displays the raw or non-temperature corrected conductivity.

DEFINITIONS

1. **LINEAR TEMPERATURE COEFFICIENT OR TEMPERATURE SLOPE.** The change in the conductivity of most electrolyte solutions having conductivity greater than about 5 mS/cm at 25°C can be expressed by the following equation:

$$C_{25} = \frac{C_t}{1 + a(t - 25)}$$

In the equation, C_{25} is the conductivity at 25°C, C_t is the conductivity at $t^\circ\text{C}$, and a is the linear temperature coefficient. The linear temperature coefficient, sometimes called the temperature slope, has units of $\%/^\circ\text{C}$. In the equation, the temperature coefficient is expressed as a decimal fraction. The linear temperature coefficient depends to some extent on both the temperature and the concentration of the salt solution. The temperature coefficient also varies from salt to salt.

For maximum accuracy, the temperature coefficient must be appropriate for the salt or salts in solution, their concentration, and the temperature. Frequently the relationship must be determined by experiment. Fortunately, for most dilute neutral electrolyte solutions, a linear temperature coefficient of $2.00\%/^\circ\text{C}$ (0.0200) works reasonably well. The table below gives typical ranges for different electrolytes.

	Slope ($\%/^\circ\text{C}$)
Neutral salts	1.8 - 3.0
Acids	1.0 - 1.6
Bases	1.8 - 2.2
High purity water	Use standard correction

2. **RAW.** Raw conductivity is the conductivity of the sample at the measurement temperature.

SECTION 12.0

THEORY - REMOTE COMMUNICATIONS

12.1 OVERVIEW OF HART COMMUNICATION

HART (highway addressable remote transducer) is a digital communication system in which two frequencies are superimposed on the 4 to 20 mA output signal from the transmitter. A 1200 Hz sine wave represents the digit 1, and a 2400 Hz sine wave represents the digit 0. Because the average value of a sine wave is zero, the digital signal adds no dc component to the analog signal. HART permits digital communication while retaining the analog signal for process control.

The HART protocol, originally developed by Fisher-Rosemount, is now overseen by the independent HART Communication Foundation. The Foundation ensures that all HART devices can communicate with one another. For more information about HART communications, call the HART Communication Foundation at (512) 794-0369. The internet address is <http://www.hartcomm.org>.

12.2 HART INTERFACE DEVICES

HART communicators allow the user to view measurement data (conductivity readings and temperature), program the transmitter, and download information from the transmitter for transfer to a computer for analysis. Downloaded information can also be sent to another HART transmitter. Either a hand-held communicator, such as the Rosemount Model 275, or a computer can be used. HART interface devices operate from any wiring termination point in the 4 - 20 mA loop. A minimum load of 250 ohms must be present between the transmitter and the power supply. See Figure 12-1.

If your communicator does not recognize the Model XMT-T transmitter, the device description library may need updating. Call the manufacturer of your HART communication device for updates.

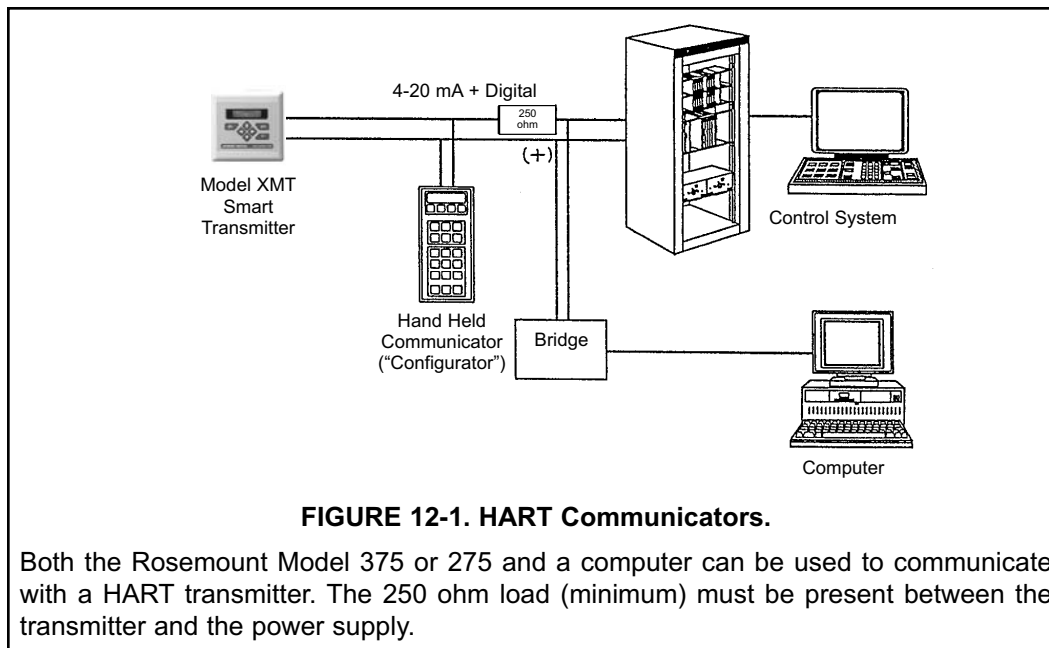

12.3 ASSET MANAGEMENT SOLUTIONS

Asset Management Solutions (AMS) is software that helps plant personnel better monitor the performance of analytical instruments, pressure and temperature transmitters, and control valves. Continuous monitoring means maintenance personnel can anticipate equipment failures and plan preventative measures before costly breakdown maintenance is required.

AMS uses remote monitoring. The operator, sitting at a computer, can view measurement data, change program settings, read diagnostic and warning messages, and retrieve historical data from any HART-compatible device, including the Model XMT-T transmitter. Although AMS allows access to the basic functions of any HART compatible device, Rosemount Analytical has developed additional software for that allows access to all features of the Model XMT-T transmitter.

AMS can play a central role in plant quality assurance and quality control. Using AMS Audit Trail, plant operators can track calibration frequency and results as well as warnings and diagnostic messages. The information is available to Audit Trail whether calibrations were done using the infrared remote controller, the Model 375 or 275 HART communicator, or AMS software.

AMS operates in Windows 95. See Figure 12-2 for a sample screen. AMS communicates through a HART-compatible modem with any HART transmitters, including those from other manufacturers. AMS is also compatible with FOUNDATION™ Fieldbus, which allows future upgrades to Fieldbus instruments.

For more information about AMS, including upgrades, renewals, and training, call Fisher-Rosemount Systems, Inc. at (612) 895-2000.

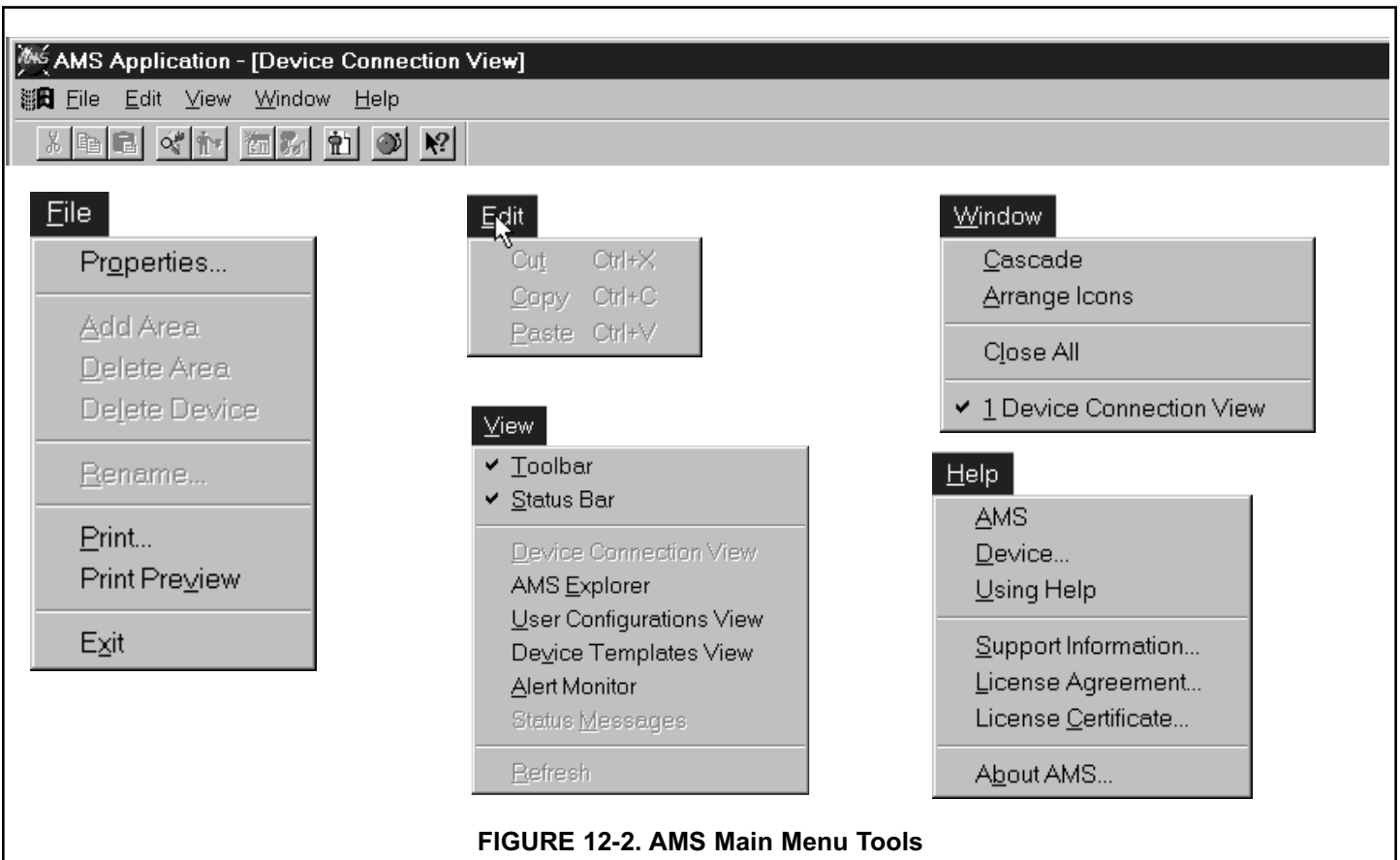

FIGURE 12-2. AMS Main Menu Tools

SECTION 13.0 RETURN OF MATERIAL

13.1 GENERAL.

To expedite the repair and return of instruments, proper communication between the customer and the factory is important. Call 1-949-757-8500 for a Return Materials Authorization (RMA) number.

13.2 WARRANTY REPAIR.

The following is the procedure for returning instruments still under warranty:

1. Call Rosemount Analytical for authorization.
2. To verify warranty, supply the factory sales order number or the original purchase order number. In the case of individual parts or sub-assemblies, the serial number on the unit must be supplied.
3. Carefully package the materials and enclose your "Letter of Transmittal" (see Warranty). If possible, pack the materials in the same manner as they were received.
4. Send the package prepaid to:

Emerson Process Management
Liquid Division
2400 Barranca Parkway
Irvine, CA 92606

Attn: Factory Repair

RMA No. _____

Mark the package: Returned for Repair

Model No. _____

13.3 NON-WARRANTY REPAIR.

The following is the procedure for returning for repair instruments that are no longer under warranty:

1. Call Rosemount Analytical for authorization.
2. Supply the purchase order number, and make sure to provide the name and telephone number of the individual to be contacted should additional information be needed.
3. Do Steps 3 and 4 of Section 13.2.

NOTE

Consult the factory for additional information regarding service or repair.

WARRANTY

Goods and part(s) (excluding consumables) manufactured by Seller are warranted to be free from defects in workmanship and material under normal use and service for a period of twelve (12) months from the date of shipment by Seller. Consumables, pH electrodes, membranes, liquid junctions, electrolyte, O-rings, etc. are warranted to be free from defects in workmanship and material under normal use and service for a period of ninety (90) days from date of shipment by Seller. Goods, part(s) and consumables proven by Seller to be defective in workmanship and / or material shall be replaced or repaired, free of charge, F.O.B. Seller's factory provided that the goods, parts(s), or consumables are returned to Seller's designated factory, transportation charges prepaid, within the twelve (12) month period of warranty in the case of goods and part(s), and in the case of consumables, within the ninety (90) day period of warranty. This warranty shall be in effect for replacement or repaired goods, part(s) and consumables for the remaining portion of the period of the twelve (12) month warranty in the case of goods and part(s) and the remaining portion of the ninety (90) day warranty in the case of consumables. A defect in goods, part(s) and consumables of the commercial unit shall not operate to condemn such commercial unit when such goods, parts(s) or consumables are capable of being renewed, repaired or replaced.

The Seller shall not be liable to the Buyer, or to any other person, for the loss or damage, directly or indirectly, arising from the use of the equipment or goods, from breach of any warranty or from any other cause. All other warranties, expressed or implied are hereby excluded.

IN CONSIDERATION OF THE STATED PURCHASE PRICE OF THE GOODS, SELLER GRANTS ONLY THE ABOVE STATED EXPRESS WARRANTY. NO OTHER WARRANTIES ARE GRANTED INCLUDING, BUT NOT LIMITED TO, EXPRESS AND IMPLIED WARRANTIES OF MERCHANTABILITY AND FITNESS FOR A PARTICULAR PURPOSE.

RETURN OF MATERIAL

Material returned for repair, whether in or out of warranty, should be shipped prepaid to:

**Emerson Process Management
Liquid Division
2400 Barranca Parkway
Irvine, CA 92606**

The shipping container should be marked:

Return for Repair

Model _____

The returned material should be accompanied by a letter of transmittal which should include the following information (make a copy of the "Return of Materials Request" found on the last page of the Manual and provide the following thereon):

1. Location type of service, and length of time of service of the device.
2. Description of the faulty operation of the device and the circumstances of the failure.
3. Name and telephone number of the person to contact if there are questions about the returned material.
4. Statement as to whether warranty or non-warranty service is requested.
5. Complete shipping instructions for return of the material.

Adherence to these procedures will expedite handling of the returned material and will prevent unnecessary additional charges for inspection and testing to determine the problem with the device.

If the material is returned for out-of-warranty repairs, a purchase order for repairs should be enclosed.



*The right people,
the right answers,
right now.*

ROSEMOUNT ANALYTICAL
CUSTOMER SUPPORT CENTER
1-800-854-8257



ON-LINE ORDERING NOW AVAILABLE ON OUR WEB SITE
<http://www.raihome.com>

Specifications subject to change without notice.

Credit Cards for U.S. Purchases Only.



Emerson Process Management

Liquid Division

2400 Barranca Parkway
Irvine, CA 92606 USA
Tel: (949) 757-8500
Fax: (949) 474-7250

<http://www.raihome.com>

