

Instruction Manual

51-54eA/rev.1

April 2005

Model 54eA

Amperometric HART[®] Analyzer/Controller



ESSENTIAL INSTRUCTIONS

READ THIS PAGE BEFORE PROCEEDING!

Rosemount Analytical designs, manufactures, and tests its products to meet many national and international standards. Because these instruments are sophisticated technical products, you must properly install, use, and maintain them to ensure they continue to operate within their normal specifications. The following instructions must be adhered to and integrated into your safety program when installing, using, and maintaining Rosemount Analytical products. Failure to follow the proper instructions may cause any one of the following situations to occur: Loss of life; personal injury; property damage; damage to this instrument; and warranty invalidation.

- Read all instructions prior to installing, operating, and servicing the product. If this Instruction Manual is not the correct manual, telephone 1-800-654-7768 and the requested manual will be provided. Save this Instruction Manual for future reference.
- If you do not understand any of the instructions, contact your Rosemount representative for clarification.
- Follow all warnings, cautions, and instructions marked on and supplied with the product.
- Inform and educate your personnel in the proper installation, operation, and maintenance of the product.
- Install your equipment as specified in the Installation Instructions of the appropriate Instruction Manual and per applicable local and national codes. Connect all products to the proper electrical and pressure sources.
- To ensure proper performance, use qualified personnel to install, operate, update, program, and maintain the product.
- When replacement parts are required, ensure that qualified people use replacement parts specified by Rosemount. Unauthorized parts and procedures can affect the product's performance and place the safe operation of your process at risk. Look alike substitutions may result in fire, electrical hazards, or improper operation.
- Ensure that all equipment doors are closed and protective covers are in place, except when maintenance is being performed by qualified persons, to prevent electrical shock and personal injury.

WARNING

ELECTRICAL SHOCK HAZARD

Making cable connections to and servicing this instrument require access to shock hazard level voltages which can cause death or serious injury, therefore, disconnect all hazardous voltage before accessing the electronics.

Relay contacts made to separate power sources must be disconnected before servicing.

Electrical installation must be in accordance with the National Electrical Code (ANSI/NFPA-70) and/or any other applicable national or local codes.

Unused cable conduit entries must be securely sealed by non-flammable closures to provide enclosure integrity in compliance with personal safety and environmental protection requirements. Use NEMA 4X or IP65 conduit plugs supplied with the instrument to maintain the ingress protection rating (IP65).

For safety and proper performance this instrument must be connected to a properly grounded three-wire power source.

Proper relay use and configuration is the responsibility of the user. No external connection to the instrument of more than 60VDC or 43V peak allowed with the exception of power and relay terminals. Any violation will impair the safety protection provided.

Do not operate this instrument without front cover secured. Refer installation, operation and servicing to qualified personnel.

WARNING

This product is not intended for use in the residential, commercial or light industrial environment per **CE** certification to EN61326.

About This Document

This manual contains instructions for installation and operation of the Model 54eA Amperometric HART Analyzer/Controller. The following list provides notes concerning all revisions of this document.

<u>Rev. Level</u>	<u>Date</u>	<u>Notes</u>
A	11/01	This is the initial release of the product manual. The manual has been reformatted to reflect the Emerson documentation style and updated to reflect any changes in the product offering.
B	2/02	Revised wiring diagrams on pages 9, 11, & 13.
C	5/02	Added configuration note to page 10.
D	11/02	Change to intro verbiage in Section 5.3 on page 26.
E	11/02	Added note re 499A sensors to page 8.
F	4/03	Added monochloramine section and updated CE info.
G	8/03	Minor textual revisions on pages 48, 65, 67, 93.
H	12/03	Updated ISO & warranty info, and fixed minor typos throughout.
I	4/05	Added note re ordering replacement boards/integrated board stack on page 105.

Emerson Process Management

Rosemount Analytical Inc.

2400 Barranca Parkway
Irvine, CA 92606 USA
Tel: (949) 757-8500
Fax: (949) 474-7250

<http://www.raihome.com>



EMERSON[™]
Process Management

CAUTION

Ground conduit to metal stiffener or to metal enclosure. Use non-flammable watertight conduit fittings/plugs to preserve enclosure rating.

DANGER

 **LIVE VOLTAGES MAY BE PRESENT**
When fuse or this cover is removed will cause severe injury or death.

CAUTION

For continued protection against fire, replace only with fuses of specified voltage and current ratings. Fuses are located under this cover.

VAROVANI

Zemnici vodici musi byt vodive spojeni s kostrou pristroje. Pouzivejte nehorlavé vodotesné pruchodky, aby ste zachovali stupeň kryti pristroje.

NEBEZPECI

 **ZARIZENI POD NAPETIM**
Odstraneni pojistky nebo tohoto krytu muze zpusobit vazne zraneni nebo smrt.

VAROVANI

Poskozene pojistky nahrazujte pouze pojistkami se stejnym jmenovitym napetim a proudem. Pojistky jsou umisteny pod timto krytem.

FORSIGTIG

Brug uantændelig vandtæt forskrning som sikkerhed for bevaring af kapslings klasse.

Jordforbindelse til metal kapsel.

FARE

 **UBESKYTTET SPÆNDING**
Hvis sikringen eller denne påskrift fjernes kan dette medføre alvorlige kvæstelser eller død.

FORSIGTIG

Brug kun sikringer med nærmere angivet spænding og strømstyrke som sikkerhed for vedvarende beskyttelse mod brandfare. Sikringerne er placeret under denne påskrift.

ATENCION

La toma a tierra debe hacerse a un contrafuerte de metal o a la caja metálica. Utilice accesorios/enchufes no inflamables y estancos al agua para preservar las especificaciones de la caja.

PELIGRO

 **VOLTAJE PUEDE ESTAR PRESENTE**
Cuando los fusibles o esta cubierta son removidos causará severas lesiones o muerte.

ATENCION

Para una proteccion continua contra el fuego, reemplace solamente con fusibles de voltaje y corriente especificados. Los fusibles se encuentran debajo de esta cubierta.

VOORZICHTIG

Aardleiding naar metalen profiel of naar metalen behuizing. Gebruik onbrandbare, waterdichte wartels en pluggen om de beschermingsklasse te handhaven.

GEVAAR

 **KAN ONDER SPANNING STAAN**
Verwijderen van zekering of dit deksel kan dit leiden tot ernstig of dodelijk letsel.

VOORZICHTIG

Voor duurzame bescherming tegen brand, uitsluitend zekeringen gebruiken met aangegeven nominale spannings- en stroomwaarden. De zekeringen bevinden zich onder dit deksel.

ATTENTION

Raccorder le tube à la masse métallique d'une entretoise ou du coffret. Utiliser des raccords et des bouchons étanches ininflammables afin de préserver la classification du boîtier.

DANGER

 **POSSIBILITE DE HAUTE TENSION**
En cas de démontage de ce capot ou des fusibles. Risques de Blessures graves ou de mort

ATTENTION

Afin d'assurer une protection permanente contre le feu, ne remplacer les fusibles que par des modèles équivalents en tension et en courant. Les fusibles se trouvent derriere cette plaquette.

ADVARSEL

Kabelinnføring må jordes til metallavstiver eller til metalenkapslingen. Bruk flammesikre og vannette nipler/plugger slik at kapslingens tetthetsgrad opprettholdes.

FARE

 **SPENNING KAN VÆRE TIL STEDE**
når sikringen eller dette dekslet fjernes, og kan føre til alvorlige skader eller dødsulykker.

ADVARSEL

For at beskyttelse mot antennelse skal opprettholdes, må sikringer bare erstattes med tilsvarende som har spesifisert spenning- og strømstyrke. Sikringer er plassert under dette dekslet.

ACHTUNG

Der Analysator ist vorschriftsmässig zu erden.

Um die Schutzart des Gerätes sicherzustellen ist es mit den entsprechenden Kabelverschraubungen und Blindkappen auszurüsten.

ACHTUNG

 **GEFAEHRLICHE ELEK-TRISCHE SPANNUNG**
Ist die Schutzabdeckung oder die Sicherung entfernt, so koennen am Geraet ernsthafte oder toedliche Verletzungen entstehen.

ATTENTION

Um die Gefahr von Kurzschluß und Funkenbildung zu verhindern dürfen die Sicherungen nur durch solche gleicher Spannung und Stromwerte ausgetauscht werden. Die Sicherungen befinden sich unter dieser Abdeckung.

Attenzione

Tubo di protezione per messa a terra con elemento di ingresso in metallo o con custodia in metallo.

Utilizzare accessori/connettori del tubo di protezione a tenuta stagna, non infiammabili, per assicurare i limiti di resistenza della custodia

Pericolo

 **POSSIBILE PRESENZA DI ALTA TENSIONE**
La rimozione del fusibile o del coperchio può causare gravi lesioni o morte.

ATTENZIONE

Per garantire una continua protezione contro gli incendi, sostituire solo con fusibili del voltaggio indicato e dell'attuale potenza. I fusibili sono alloggiati sotto il coperchio.

UWAGA

Uziemij przewod do metalowego płaskownika lub obudowy. Aby zachowac stopien szczelnosci obudowy stosuj niepalne, wodoszczelne dławiki.

NIEBEZPIECZENSTWO

 **URZADZENIE MOZE BYC POD NAPIECIEM**
Gdy bezpieczniki lub ta pokrywa sa usuniete istnieje mozliwosc uszkodzenia ciala lub smierci.

UWAGA

W celu utrzymania zabezpieczenia przed zapaleniem, nalezy stosowac bezpieczniki o identycznym z oryginalnym napieciu i amperazu. Bezpieczniki sa umieszczone pod ta pokrywa.

ATENÇÃO

Ligar a conducta de cabos à terra através de suporte ou invólucro metálicos. Utilize buçins e acessórios ignífugos e estanques para preservação da estanqueidade.

PERIGO

 **POSSIBILIDADE DE TENSÃO PERIGOSA**
A remoção do fusível ou desta tampa pode causar lesões graves ou a morte.

ATENÇÃO

Para manter sempre uma boa proteção contra incêndio, substituir somente por fusíveis com a tensão e corrente especificadas. Os fusíveis encontram-se sob esta tampa.

IAKTTAG FÖRSIKTIGHET

Anslutningspunkt är jordad till chassi. Använd brandsäker, vattentät kabelanslutning för att bevara klassificering av apparatskåp.

FARA

 **HÖGSPÄNNING KAN FÖREKOMMA**
Avlägsnande av säkring eller skyddskåpa kan förorsaka allvarlig skada eller dödsfall

IAKTTAG FÖRSIKTIGHET

För kontinuerligt skydd mot brandfara, ersätt endast med specificerad säkringsstorlek och spänning.

MODEL 54eA ANALYZER/CONTROLLER

TABLE OF CONTENTS

Section Title	Page
1.0 SPECIFICATIONS	1
1.1 Features and Applications	1
1.2 Specifications.....	2
1.3 Ordering Information.....	4
2.0 INSTALLATION	5
2.1 Unpacking and Inspection	5
2.2 Installation.....	5
3.0 WIRING	8
3.1 General.....	8
3.2 Power, Alarm, and Output Wiring	8
3.3 Sensor Wiring.....	10
4.0 DISPLAY AND OPERATION	16
4.1 General Description	16
4.2 Display.....	16
4.3 Key Functions and Controls	16
4.4 Alarm Status	16
5.0 SOFTWARE CONFIGURATION	17
5.1 Changing Alarm Setpoints	24
5.2 Ranging the Outputs.....	25
5.3 Changing Output Setpoints (PID only)	26
5.4 Testing Outputs and Alarms	27
5.5 Choosing Display Options	28
5.6 Changing Output Parameters.....	30
5.7 Changing Alarm Parameters	33
5.8 Configuring the pH Measurement	38
5.9 Temperature Compensation and Temperature Units.....	41
5.10 Noise Reduction	42
5.11 Main Sensor Calibration Parameters	43
5.12 Barometric Pressure.....	44
5.13 Security.....	45
5.14 Controller Mode Priority.....	46
6.0 CALIBRATION - TEMPERATURE	47
6.1 Introduction	47
6.2 Temperature Calibration	48
7.0 CALIBRATION - DISSOLVED OXYGEN	49
7.1 Introduction	49
7.2 Zeroing the Sensor.....	50
7.3 Calibrating the Sensor in Air.....	51
7.4 Calibrating the Sensor Against a Standard Instrument	53
7.5 Calibrating Barometric Pressure.....	54
8.0 CALIBRATION - FREE CHLORINE	55
8.1 Introduction	55
8.2 Zeroing the Sensor.....	56
8.3 Full Scale Calibration.....	57
8.4 Dual Slope Calibration.....	58

TABLE OF CONTENTS (CONTINUED)

Section	Title	Page
9.0	CALIBRATION - TOTAL CHLORINE	60
9.1	Introduction	60
9.2	Zeroing the Sensor	61
9.3	Full Scale Calibration.....	62
9.4	Dual Slope Calibration.....	63
10.0	CALIBRATION - MONOCHLORAMINE	65
10.1	Introduction	65
10.2	Zeroing the Sensor	66
10.3	Full Scale Calibration.....	67
11.0	CALIBRATION - OZONE	68
11.1	Introduction	68
11.2	Zeroing the Sensor	69
11.3	Full Scale Calibration.....	70
12.0	CALIBRATION - pH	71
12.1	Introduction	71
12.2	Automatic Two-Point Calibration	72
12.3	Manual Two-Point Calibration.....	74
12.4	Standardization (One-Point Calibration).....	76
12.5	pH Slope Adjustment.....	77
13.0	CALIBRATION - CURRENT OUTPUTS.....	78
13.1	Introduction	78
13.2	Trimming the Outputs	78
14.0	PID AND TPC CONTROL.....	79
14.1	PID Control	79
14.2	Time Proportional Control (TPC).....	83
15.0	TROUBLESHOOTING	84
15.1	Overview.....	84
15.2	Troubleshooting When a Fault Message is Showing	84
15.3	Troubleshooting When No Fault Message is Showing - Temperature	86
15.4	Troubleshooting When No Fault Message is Showing - Oxygen.....	86
15.5	Troubleshooting When No Fault Message is Showing - Free Chlorine	89
15.6	Troubleshooting When No Fault Message is Showing - Total Chlorine	91
15.7	Troubleshooting When No Fault Message is Showing - Monochloramine	92
15.8	Troubleshooting When No Fault Message is Showing - Ozone	95
15.9	Troubleshooting When No Fault Message is Showing - pH	97
15.10	Troubleshooting Not Related to Measurement Problems	100
15.11	Simulating Inputs - Dissolved Oxygen.....	100
15.12	Simulating Inputs - Other Amperometric Measurements	101
15.13	Simulating Inputs - pH.....	102
15.14	Simulating Temperature.....	103
15.15	Measuring Reference Voltage	104
16.0	MAINTENANCE	105
17.0	RETURN OF MATERIALS.....	106

LIST OF FIGURES

Section	Title	Page
2-1	Wall Mounting	5
2-2	Pipe Mounting.....	6
2-3	Pipe and Wall Mounting Dimensions.....	6
2-4	Panel Mounting.....	7
2-5	Panel Mounting Dimensions.....	7
3-1	Power Input and Relay Output Wiring for Model 54eA	9
3-2	Wiring Label.....	10
3-3	Amperometric Sensors with Standard Cable.....	10
3-4	Amperometric Sensors with Optimum EMI/RFI Cable or Variopol Cable	10
3-5	Free Chlorine Sensor with Standard Cable and 399VP-09 pH Sensor without Internal Preamplifier	11
3-6	Free Chlorine Sensor with Standard Cable and 399-14 pH Sensor Having Internal Preamplifier.....	12
3-7	Free Chlorine Sensor with Standard Cable and 399-09-62 pH sensor without Internal Preamplifier	12
3-8	Free Chlorine Sensor with Optimum EMI/RFI Cable or Variopol Cable and 399VP-09 pH Sensor without Internal Preamplifier.....	13
3-9	Free Chlorine Sensor with Optimum EMI/RFI Cable or Variopol Cable and 399-14 pH Sensor Having Internal Preamplifier.....	13
3-10	Free Chlorine Sensor with Optimum EMI/RFI Cable or Variopol Cable and 399-09-62 pH Sensor without Internal Preamplifier	14
3-11	Hx438 and Gx448 Sensors	15
4-1	Configuration of Inputs and Outputs for Free Chlorine	16
4-2	Main Display Screen.....	16
5-1	Menu Tree for the 54eA Controller	21
5-2	Low Alarm	35
5-3	High Alarm	35
5-4	Interval Timer	37
7-1	Sensor Current as a Function of Dissolved Oxygen Concentration	49
8-1	Sensor Current as a Function of Free Chlorine Concentration.....	55
8-2	Dual Slope Calibration.....	58
9-1	Determination of Total Chlorine	60
9-2	Sensor Current as a Function of Total Chlorine Concentration.....	60
9-3	Dual Slope Calibration.....	63
10-1	Sensor Current as a Function of Monochloramine Concentration	65
11-1	Sensor Current as a Function of Ozone Concentration	68
12-1	Calibration Slope and Offset	71
14-1	The Process Reaction Curve	81
14-2	Time Proportional Control.....	83
15-1	Simulate Dissolved Oxygen.....	100
15-2	Simulate Chlorine and Ozone	101
15-3	Simulate pH.....	102
15-4	Three-Wire RTD Configuration.....	103
15-5	Simulating RTD Inputs.....	103
15-6	Checking for a Poisoned Reference Electrode	104

LIST OF TABLES

Table No.	Title	Page
5-1	Program Settings List.....	17
5-2	Controller Mode Priority Chart.....	46

SECTION 1.0 SPECIFICATIONS

1.1 FEATURES AND APPLICATIONS

The Model 54eA Analyzer/Controller with the appropriate sensor monitors and controls dissolved oxygen (ppm and ppb level), free chlorine, total chlorine, and ozone in a variety of process liquids. The analyzer is compatible with Rosemount Analytical series 499A amperometric sensors for oxygen, chlorine, and ozone; and with Hx438 and Gx448 steam sterilizable oxygen sensors.

The amperometric sensors used with the Model 54eA produce a current directly proportional to the concentration of the substance being determined. Sensor currents are in the microampere to nanoampere range.

For oxygen measurements, an on-board pressure sensor allows truly automatic air calibration. Simply expose the sensor to water-saturated air. Wait until readings are stable and press a button. The analyzer measures temperature and barometric pressure and automatically completes the calibration.

For free chlorine measurements, both automatic and manual pH correction are available. pH correction is necessary because amperometric chlorine sensors respond only to hypochlorous acid. To measure free chlorine (hypochlorous acid plus hypochlorite ion) most competing analyzers require an acidified sample. Acid lowers the pH and converts hypochlorite ion to hypochlorous acid. The 54eA analyzer eliminates the need for messy and expensive reagents by using the sample pH to correct the chlorine sensor signal. If the pH is relatively constant, a fixed pH correction can be used. If the pH is greater than 7 and fluctuates more than about 0.2 units, continuous measurement of pH and automatic pH correction is necessary. Corrections are valid to pH 9.5.

The 54eA analyzer fully compensates oxygen, ozone, free chlorine, and total chlorine readings for changes in membrane permeability caused by temperature changes.

For pH measurements — pH is available with free chlorine only — the 54eA features automatic buffer recognition with stabilization check. Buffer pH and temperature data for commonly used buffers are stored in the analyzer. Glass impedance diagnostics warn the user of an aging or failed pH sensor.

The analyzer has a rugged, weatherproof, corrosion-resistant enclosure (NEMA 4X and IP65) of epoxy-painted aluminum. It is suitable for panel, pipe, or wall mounting. A hinged front cover provides convenient access to wiring. Programming and calibration are through the front membrane keypad, which has tactile feedback. The large back-lit dot-matrix display shows the main measurement (oxygen, chlorine, or ozone) in large numerals. The temperature and output current are shown in smaller numerals on the second line. Two user-selectable variables can be displayed on the third line. The pH measurement, if used, appears on the third line.

Two independent, galvanically isolated outputs provide 4-20 mA or 0-20 mA signals for oxygen, chlorine, ozone, pH, or temperature. Output 1 includes a HART digital signal superimposed on the analog signal. The controller option allows PID control on any measurement.

The Model 54eA has three programmable alarm relays. Alarms can be assigned to the amperometric measurement, pH, or temperature. Alarms have programmable high or low activation, independent set-points, adjustable deadband, and time delay. Any relay can be configured as a timer to control a spray cleaner for the dissolved oxygen sensor. An over-feed timer feature is also available. The controller option allows each alarm to be configured for time proportional control (TPC). A fourth relay is a dedicated fault alarm.

The Model 54eA analyzer is a member of the Rosemount SMART FAMILY[®] of instruments. The analyzer communicates with the Model 275 HART[®] communicator or any other host, including AMS, that supports the 275 HART communication protocol.

[®]SMART FAMILY is a registered trademark of Rosemount Inc.

[®]HART is a registered trademark of the HART Communication Foundation.

1.2 SPECIFICATIONS - GENERAL

Enclosure: Epoxy-painted (light gray) cast aluminum, NEMA4X (IP65). 144 x 144 x 132 mm (5.7 x 5.7 x 5.2 in.), DIN size.

Front Panel: Membrane keypad with tactile feedback. Three green LEDs indicate alarm status. Red LED indicates fault condition.

Display: Three-line, back-lit, dot matrix LCD, 70 x 35 mm. First line is oxygen, chlorine, or ozone reading. Second line is temperature and current output. Third line is user-selectable. pH reading appears on third line. Character heights: 1st line - 16 mm (0.6 in.), 2nd and 3rd lines - 7 mm (0.3 in.).

Hazardous Location Approvals:

Class I, Division 2, Groups A, B, C, & D.
T5 Ta=50°C. Dust ignition proof: Class II, Division 1, Groups E, F, & G; Class III.

FM: Max. relay contact rating: 28 Vdc resistive

150 mA - Groups A & B;
400 mA - Group C;
540 mA - Group D



CSA:



-LR 34186

Max. relay contact rating:
28 Vdc; 110 Vac; 230 Vac;
6 amps resistive. Enclosure Type 4.

Power:

Code -01: 115 VAC ± 10%, 50/60 Hz ± 6%, 8 W
230 VAC ± 10%, 50/60 Hz ± 6%, 8 W

Code -02: 20 - 30 VDC, 6 W

RFI/EMI: EN-61326



LVD (Code -01 only): EN-61010-1

Repeatability (input): ± 1 nA

Stability (input): ± 1 nA/month at 25°C

Outputs: Two 4-20 mA or 0-20 mA isolated outputs. Continuously adjustable. Outputs can be assigned to oxygen, chlorine, ozone, pH, or temperature. Output dampening is user-selectable. Maximum load at 24 Vdc or 115/230 Vac is 600 ohms. Maximum load at 100/200 Vac is 550 ohms. Output 1 has superimposed HART signal (option -09 only). Outputs can be programmed for PID control (option -20 only).

Output Accuracy: ± 0.05 mA

Alarms:



Relay 1 - Process, Interval, or Time Proportional Control (TPC requires code -20)

Relay 2 - Process, Interval, or Time Proportional Control (TPC requires code -20)

Relay 3 - Process, Interval, or Time Proportional Control (TPC requires code -20)

Relay 4 - Sensor/analyzer and process fault alarm

Each relay has a dedicated LED on the front panel.

Relay Contacts: Relays 1-3: Epoxy sealed form A contacts, SPST, normally open



Relay 4: Epoxy sealed form C, SPDT

	<u>Resistive</u>	<u>Inductive</u>
28 Vdc	5.0 Amps	3.0 Amps
115 Vac	5.0 Amps	3.0 Amps
230 Vac	5.0 Amps	1.5 Amps

Temperature Sensors Accepted: Pt 100 RTD, Pt 1000 RTD, 22K NTC thermistor.

Ambient Temperature: 0 to 50°C (32 to 122°F).

Analyzer can be operated between -20 and 60°C (-4 to 140°F) with some degradation in display quality.

Relative Humidity: 95% (maximum) non-condensing

Weight/Shipping Weight: 5 lb/6 lb (2 kg/2.5 kg)

SPECIFICATIONS — OXYGEN

Measurement Range: 0-99 ppm (mg/L), 0-200% saturation

Resolution: 0.01 ppm, 0.1 ppb for 499A TrDO sensor

Temperature correction for membrane permeability: automatic between 0 and 50°C (can be disabled)

Calibration: automatic air calibration or calibration against a standard instrument

Pressure sensor range: 113 to 862 mmHg (151 to 1149 mbar)

RECOMMENDED SENSORS — OXYGEN:

Model 499A DO-54 for ppm level

Model 499A TrDO-54 for ppb level

Hx438 and Gx448 steam-sterilizable oxygen sensors

SPECIFICATIONS — FREE CHLORINE

Measurement Range: 0-20 ppm (mg/L) as Cl₂

Resolution: 0.001 ppm

Temperature correction for membrane permeability: automatic between 0 and 50°C (can be disabled)

pH Correction: Automatic between pH 6.0 and 9.5. Manual pH correction is also available.

Calibration: against grab sample analyzed using portable test kit.

RECOMMENDED SENSOR — FREE CHLORINE:

Model 499A CL-01-54

SPECIFICATIONS — pH

Application: pH measurement available with free chlorine only.

Measurement Range: 0-14 pH

Resolution: 0.01 pH

Sensor Diagnostics: Glass impedance (for broken or aging electrode) and reference offset. Reference impedance (for fouled reference junction) is not available.

Repeatability: ±0.01 pH at 25°C

Stability: ±0.01 pH/month, non-cumulative at 25°C

RECOMMENDED pH SENSORS:

Model 399-09-62, 399-14, and 399VP-09

See pH sensor product data sheet for complete ordering information.

SPECIFICATIONS — TOTAL CHLORINE

Measurement Range: 0-20 ppm (mg/L) as Cl₂

Resolution: 0.001 ppm

Temperature correction for membrane permeability: automatic between 5 and 35°C (can be disabled)

Calibration: against grab sample analyzed using portable test kit.

RECOMMENDED SENSOR — TOTAL CHLORINE:

Model 499A CL-02-54 (must be used with SCS 921)

SPECIFICATIONS — OZONE

Measurement Range: 0-10 ppm (mg/L)

Resolution: 0.001 ppm

Temperature correction for membrane permeability: automatic between 5 and 35°C (can be disabled)

Calibration: against grab sample analyzed using portable test kit.

RECOMMENDED SENSOR — OZONE:

Model 499A OZ-54

1.3 ORDERING INFORMATION

The **Model 54eA Microprocessor Analyzer** measures dissolved oxygen, free chlorine, total chlorine, ozone, and pH. pH is available for free chlorine only. The analyzer has an on-board pressure sensor for automatic air calibration of oxygen sensors. Amperometric measurements are fully compensated for changes in membrane permeability with temperature. Free chlorine is corrected for pH. Standard features include a three-line back-lit display, dual isolated outputs, and three programmable alarm relays. HART communications and PID and TPC control are optional.

MODEL 54eA MICROPROCESSOR ANALYZER	
CODE	OPTIONS
01	115/230 VAC, 50/60 Hz Power
02	24 VDC

CODE	OPTIONS
09	HART Communications Protocol
20	Controller Outputs - PID and TPC
54eA -01 -20	EXAMPLE

ACCESSORIES	
PART NO.	DESCRIPTION
2002577	Wall and two inch pipe mounting kit
23545-00	Panel mounting kit
23554-00	Cable glands, kit (Qty 5 of PG 13.5)
9240048-00	Stainless steel tag (specify marking)

SECTION 2.0 INSTALLATION

2.1 UNPACKING AND INSPECTION

Inspect the shipping container. If it is damaged, contact the shipper immediately for instructions. Save the box. If there is no apparent damage, unpack the container. Be sure all items shown on the packing list are present. If items are missing, notify Rosemount Analytical immediately.

2.2 INSTALLATION

2.2.1 General information

1. Although the controller is suitable for outdoor use, do not install it in direct sunlight or in areas of extreme temperatures.
2. Install the controller in an area where vibrations and electromagnetic and radio frequency interference are minimized or absent.
3. Keep the controller and sensor wiring at least one foot from high voltage conductors. Be sure there is easy access to the controller.
4. The controller is suitable for panel, pipe, or wall mounting. Refer to the table below.

Type of mounting	Section
Wall	2.2.2
Pipe	2.2.3
Panel	2.2.4

2.2.2 Wall or surface mounting

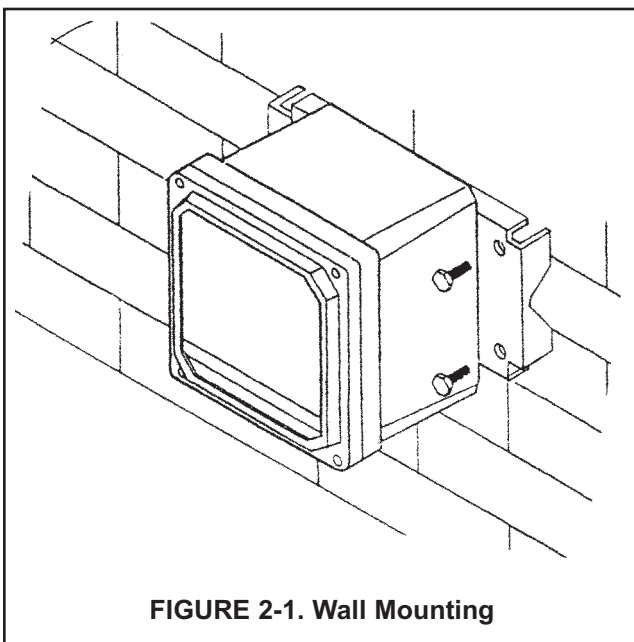

FIGURE 2-1. Wall Mounting

2.2.3 Pipe mounting

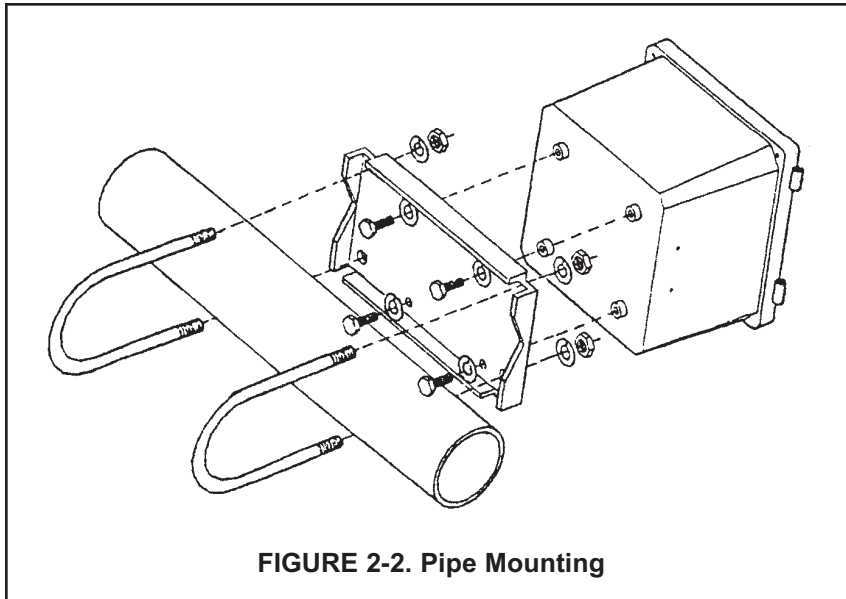
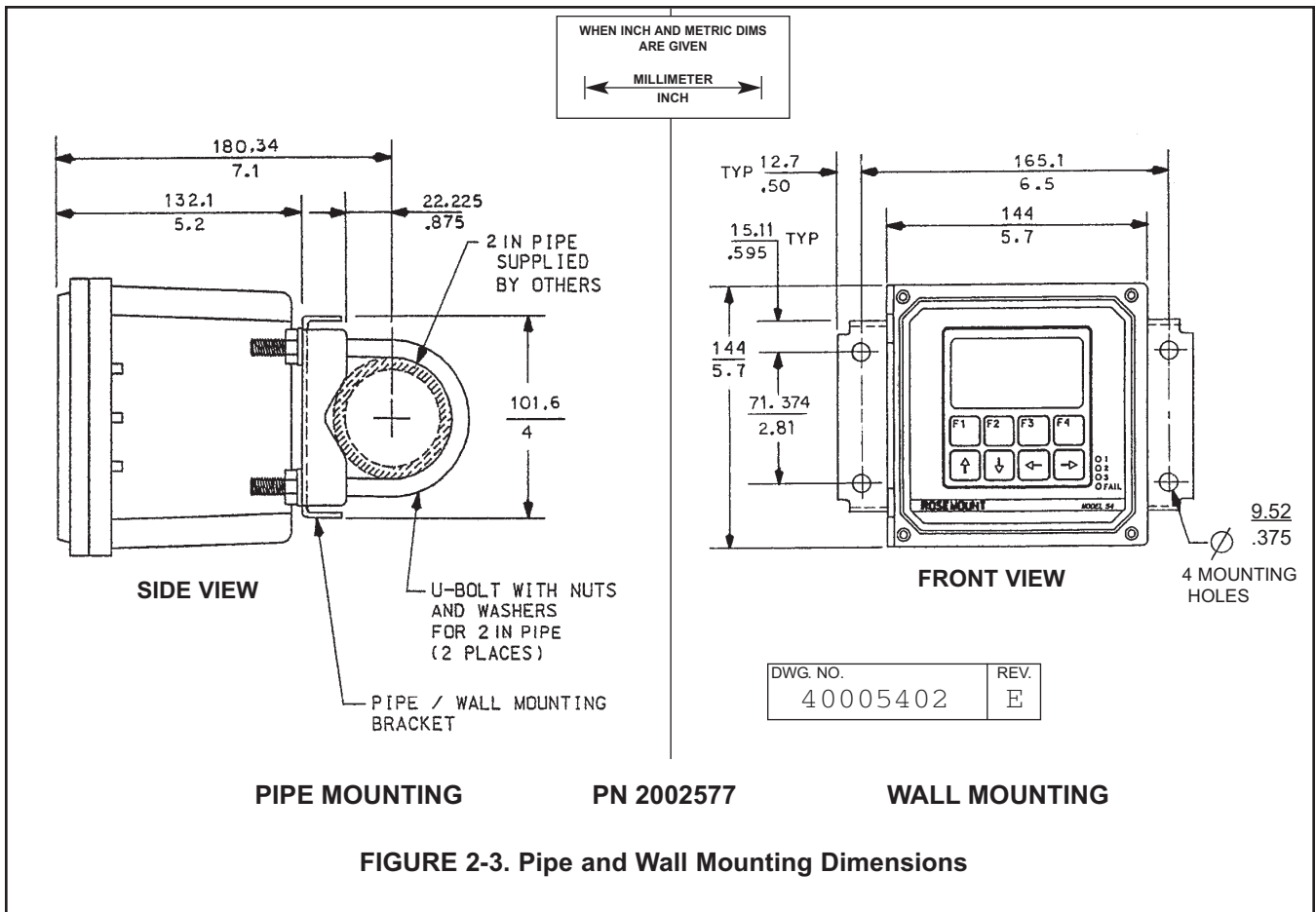

FIGURE 2-2. Pipe Mounting



2.2.4 Panel mounting

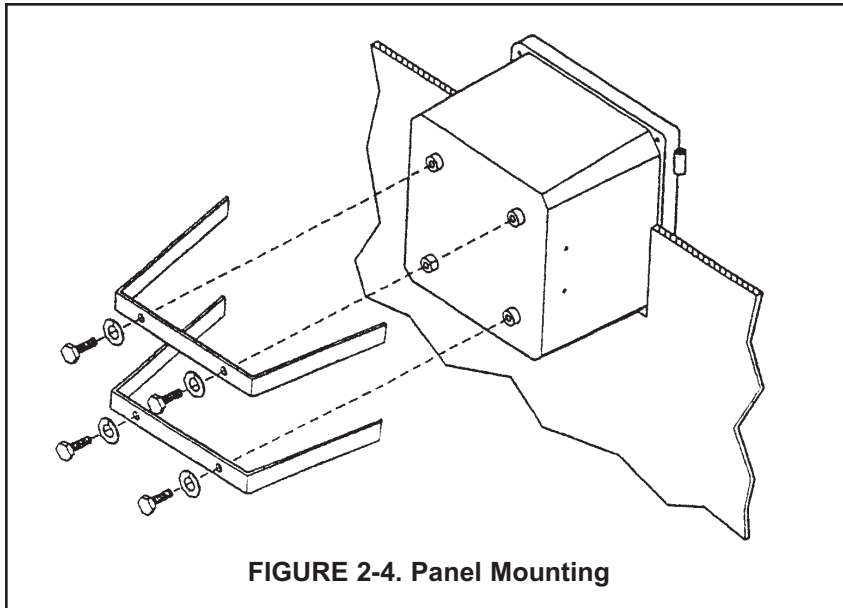

FIGURE 2-4. Panel Mounting

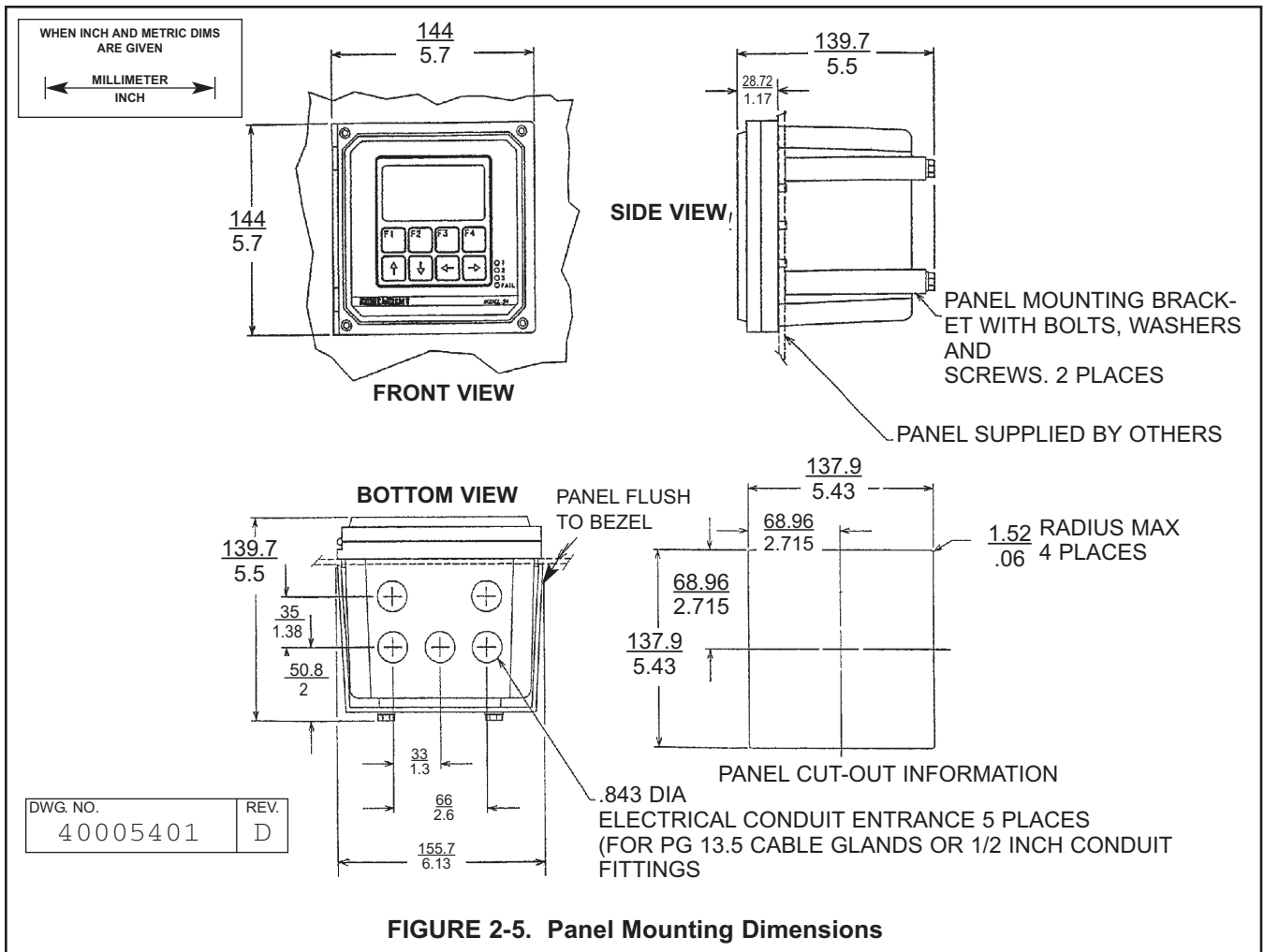

FIGURE 2-5. Panel Mounting Dimensions

SECTION 3.0 WIRING

NOTE

The Model 54eA analyzer leaves the factory configured for use with the Model 499ADO sensor (ppm dissolved oxygen). If a 499ADO sensor is NOT being used, turn to Section 5.5 and configure the transmitter for the desired measurement (ppb oxygen, oxygen measured using a steam-sterilizable sensor, free chlorine, total chlorine, monochloramine, or ozone) before wiring the sensor to the analyzer. Operating the analyzer and sensor for longer than five minutes while the analyzer is improperly configured will greatly increase the stabilization time for the sensor. Be sure to turn off power to the analyzer before wiring the sensor.

3.1 GENERAL

WARNING

Electrical installation must conform to the National Electrical Code, all state and local codes, and all plant codes and standards for electrical equipment. Electrical installation and wiring must be done by qualified personnel.

The five holes in the bottom of the instrument case accept 1/2-in. strain relief connectors or conduit fittings. The rear openings are for power and alarm relay wiring. The left front opening is for sensor wiring and the right front opening is for analog output wiring. Seal unused openings with conduit plugs.

3.2 POWER, ALARM, AND OUTPUT WIRING

Refer to Figure 3-1. Make power and alarm connections on TB3. Make analog output wiring connections on TB2. For access to power and alarm terminals, loosen the screw holding the protective cover in place and remove the cover.

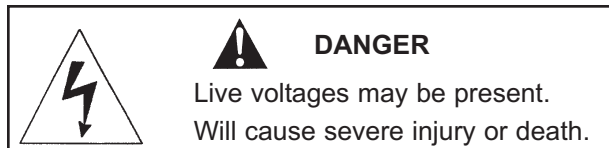

Alarm contacts are dry (i.e., not powered) and are normally open. Refer to Section 1.0 for relay specifications.

For best EMI/RFI protection, shield the output cable and enclose it in an earth-grounded, rigid, metal conduit. Connect the outer shield of the output cable to the earth ground connection on TB2 (see Figure 3-1).

Keep sensor and output signal wiring separate from power wiring. Do not run sensor and power cables in the same conduit or close together in a cable tray.

AC wiring must be 14 gauge or greater. Be sure to connect earth ground from the power cable to the nearby ground lug. A good earth ground is necessary for proper operation of the controller. Provide a switch or breaker to disconnect the analyzer from the main power supply. Install the switch or breaker near the analyzer and label it as the disconnecting device.



WARNING: RISK OF ELECTRICAL SHOCK

AC connections and grounding must comply with UL 508 or local electrical code. DO NOT apply power to the analyzer until all electrical connections are verified and secure.

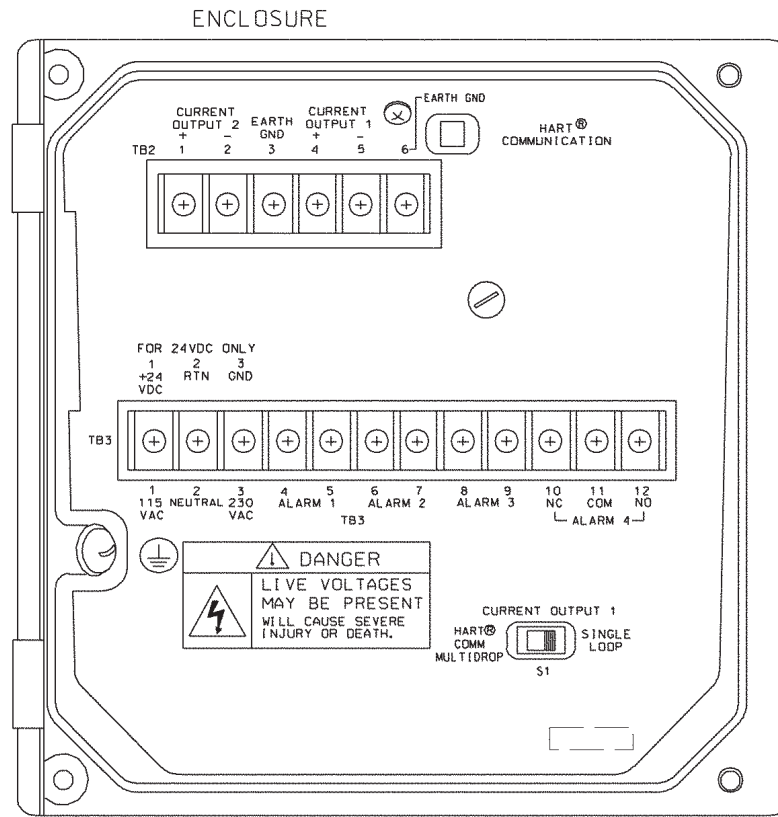

OUTPUT AND POWER WIRING

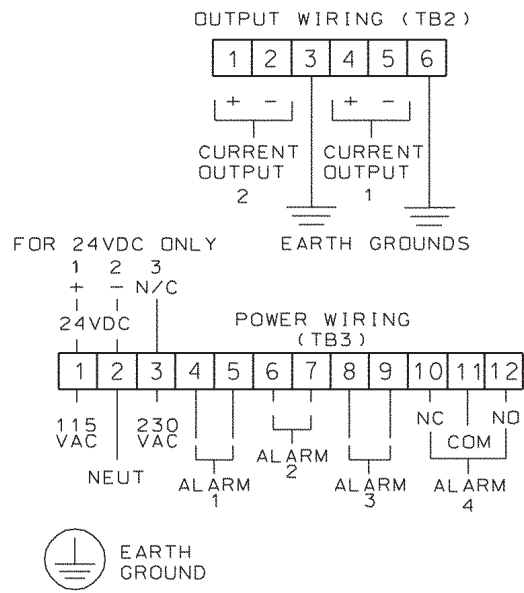

DWG. NO. 454EPH02	REV. D
----------------------	-----------

FIGURE 3-1. Power Input and Relay Output Wiring for Model 54eA

NOTE

The Model 54eA analyzer leaves the factory configured for use with the Model 499ADO sensor (ppm dissolved oxygen). If a 499ADO sensor is not being used, turn to Section 5.5 and configure the analyzer for the desired measurement (ppb oxygen, oxygen measured using a steam-sterilizable sensor, free chlorine, total chlorine, monochloramine, or ozone) before wiring the sensor to the analyzer. Operating the analyzer and sensor for longer than five minutes while the analyzer is improperly configured will greatly increase the stabilization time for the sensor.

Be sure to turn off power to the analyzer before wiring the sensor.

3.3 SENSOR WIRING

3.3.1 General

The wiring label, which is shown in Figure 3-2, is a general purpose label. It has wiring information concerning other sensors, for example, contacting and inductive conductivity sensors, that can be used with the 54e instrument platform. For amperometric measurements, only TB3 and TB5 are used. Wire the amperometric sensor to TB3. Wire the pH sensor, if one is being used, to TB5.

3.3.2 Wiring Model 499A oxygen, chlorine, and ozone sensors

All 499A amperometric sensors (499ATrDO, 499ADO, 499ACL-01, 499ACL-02, 499ACL-03, and 499AOZ) have identical wiring.

Use the pigtail wire and wire nuts provided with the amperometric sensor when more than one wire must be attached to a single terminal.

See Figures 3-3 and 3-4.

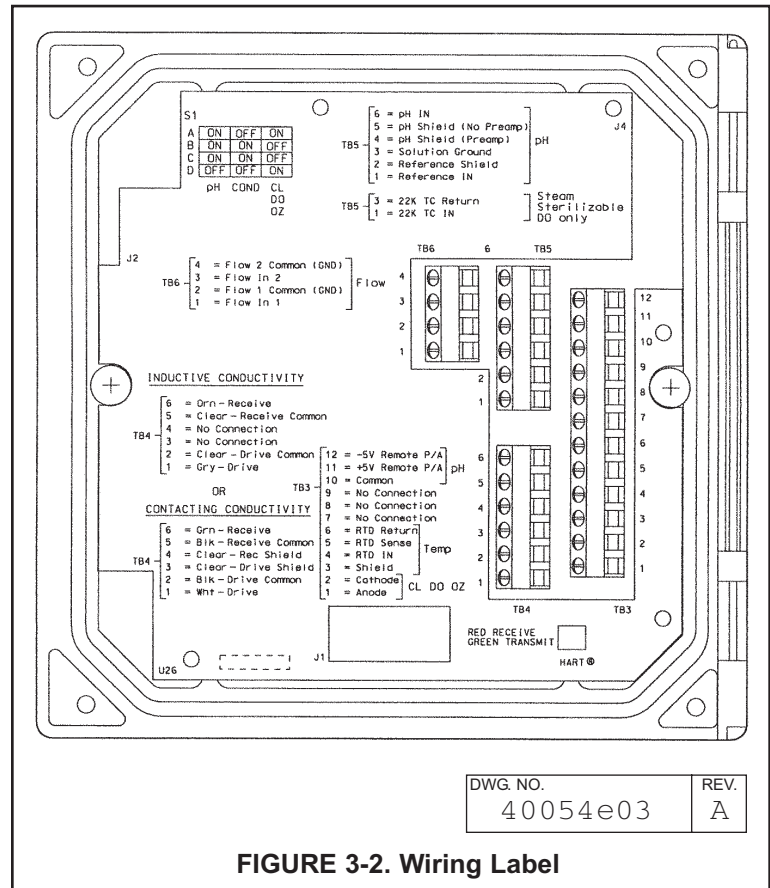

FIGURE 3-2. Wiring Label

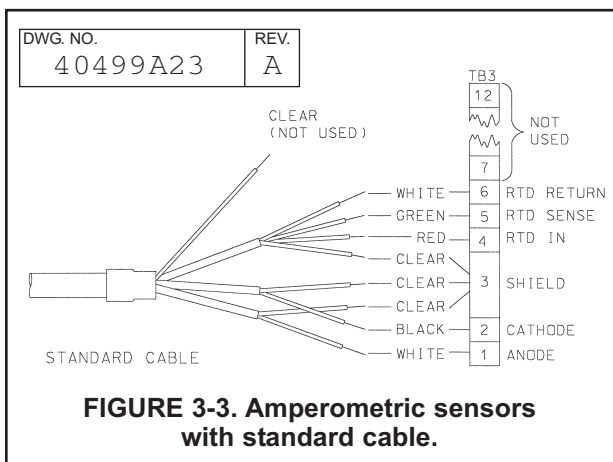

FIGURE 3-3. Amperometric sensors with standard cable.

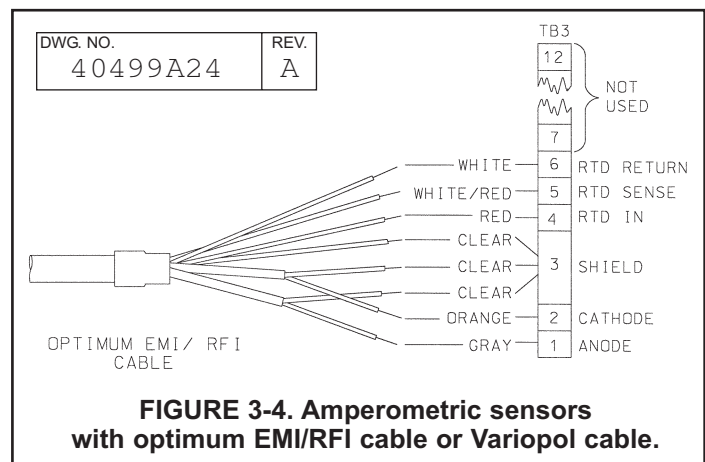

FIGURE 3-4. Amperometric sensors with optimum EMI/RFI cable or Variopol cable.

3.3.3 Wiring 499ACL-01 (free chlorine) sensors and pH sensors for automatic pH correction.

If free chlorine is being measured and the pH of the liquid varies more than 0.2 pH unit, a continuous correction for pH **must** be applied to the chlorine reading. Therefore, a pH sensor must also be wired to the 54eA controller. This section gives wiring diagrams for the pH sensors typically used.

When using the 499ACL-01 sensor (free chlorine) with a pH sensor, use the RTD in the pH sensor for measuring temperature. DO NOT use the RTD in the free chlorine sensor.

The pH sensor RTD is needed for temperature measurement during buffer calibration. During normal operation, the RTD in the pH sensor also provides the temperature measurement required for the free chlorine membrane permeability correction.

NOTE

When wiring a pH and amperometric sensor to the controller, connect the anode and reference terminals (TB3-1 and TB5-1) with the 10MΩ jumper (PN 23980-00) provided with the analyzer.

Refer to the table to select the appropriate wiring diagram. Most of the wiring diagrams require that two or more shield wires be attached to a single terminal. Use the pigtail wire and wire nuts packed with the chlorine sensor to make the connection.

Insulate and tape back unused wires.

Free chlorine sensor cable	pH sensor	Figure
Standard	399VP-09	3-5
Standard	399-14	3-6
Standard	399-09-62	3-7
EMI/RFI or Variopol	399VP-09	3-8
EMI/RFI or Variopol	399-14	3-9
EMI/RFI or Variopol	399-09-62	3-10

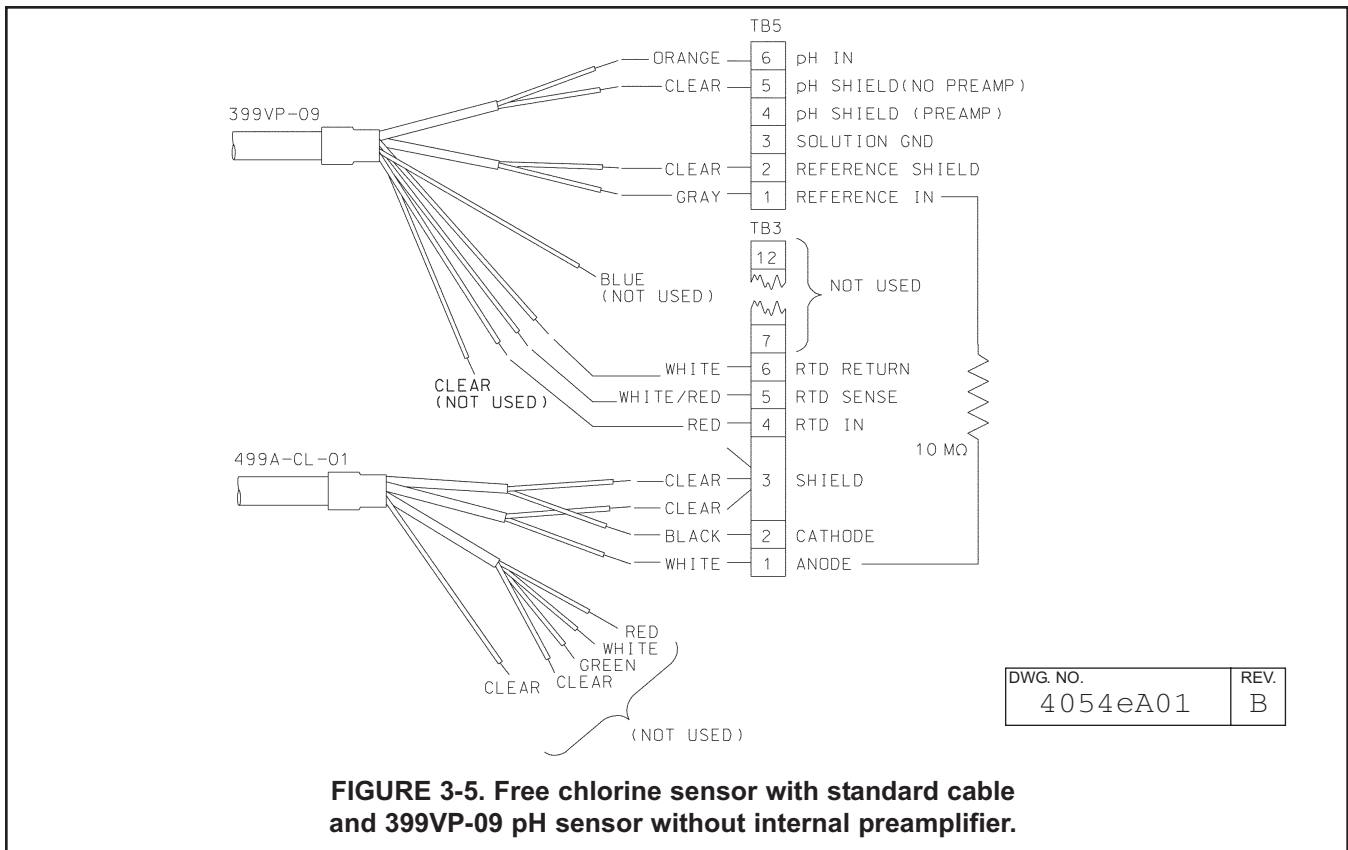

FIGURE 3-5. Free chlorine sensor with standard cable and 399VP-09 pH sensor without internal preamplifier.

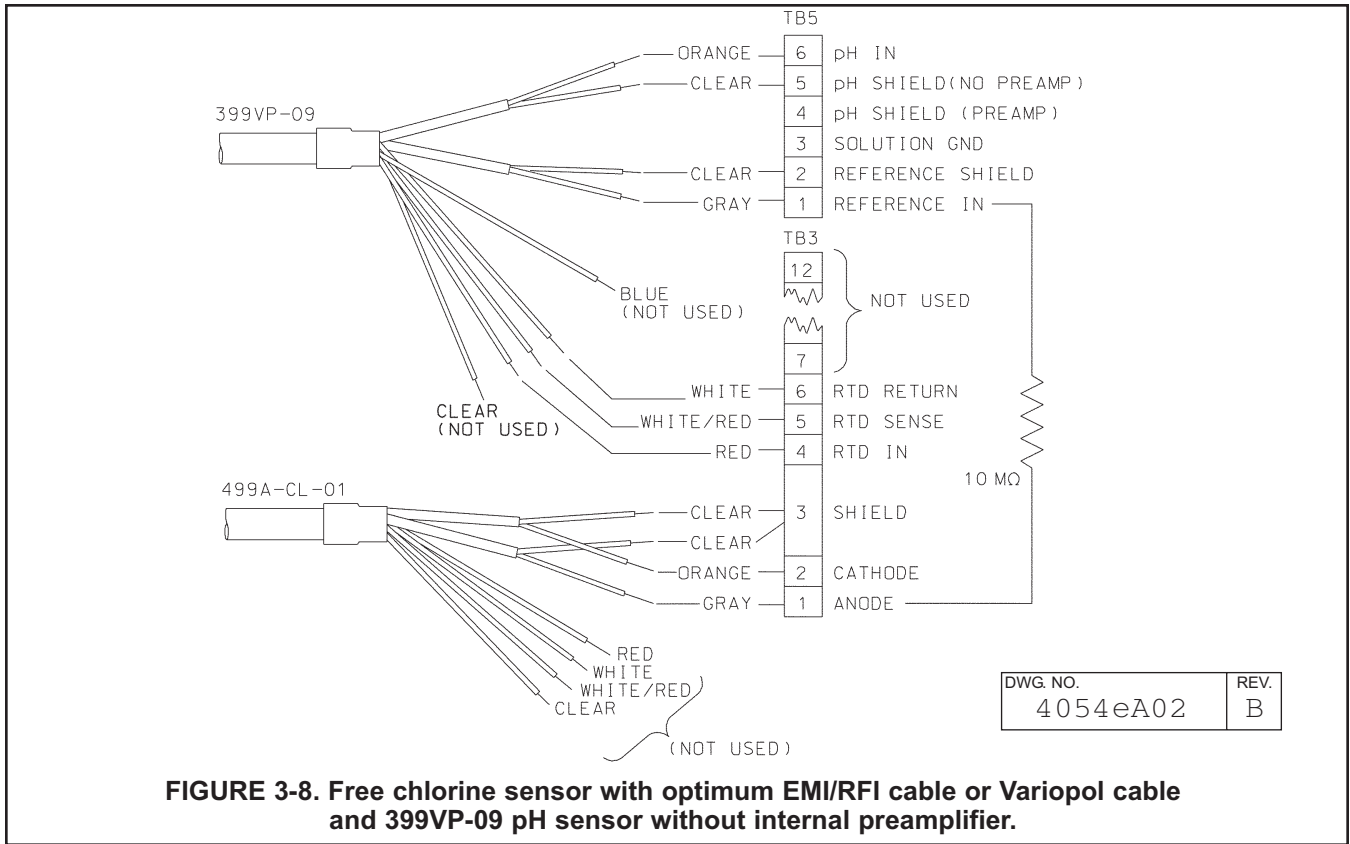
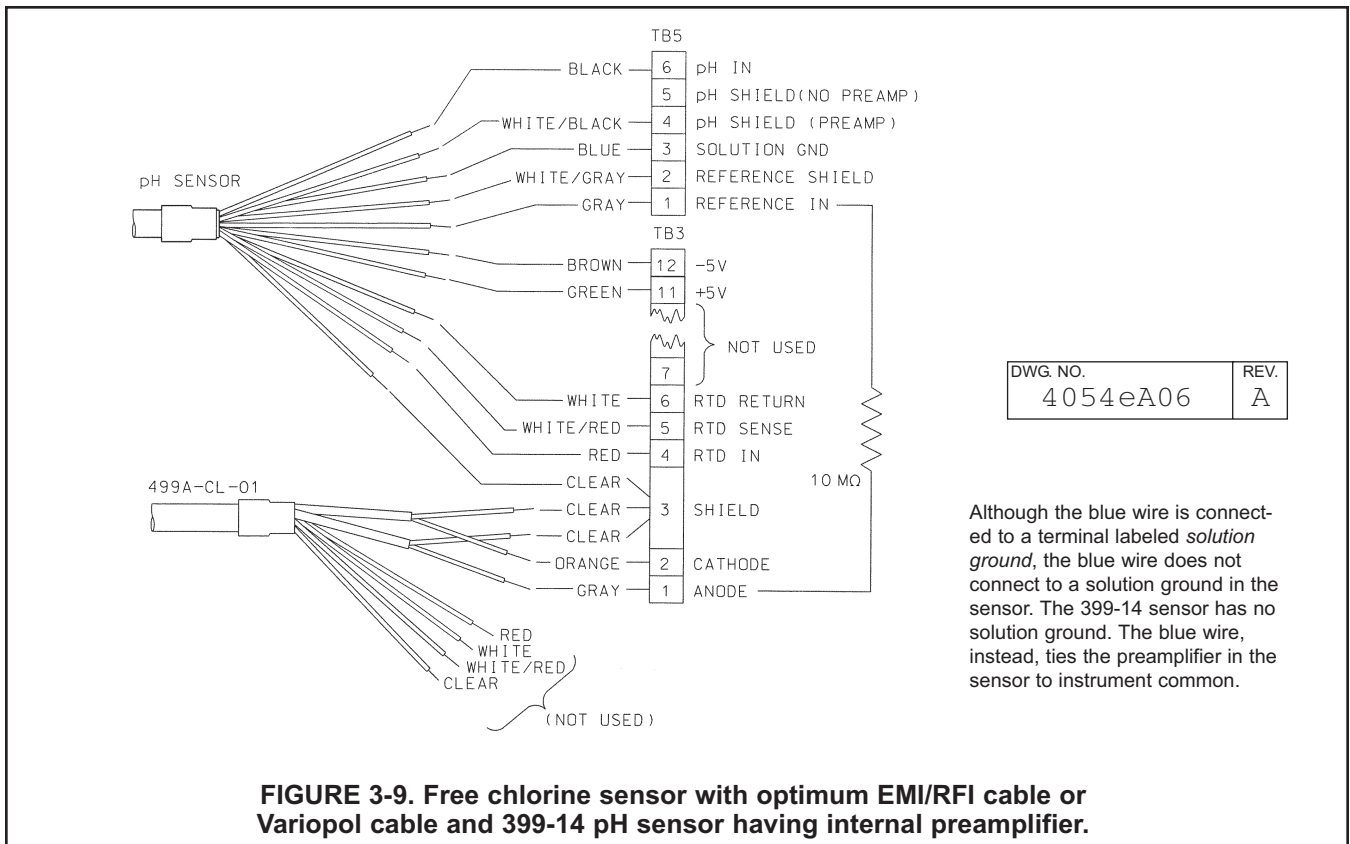
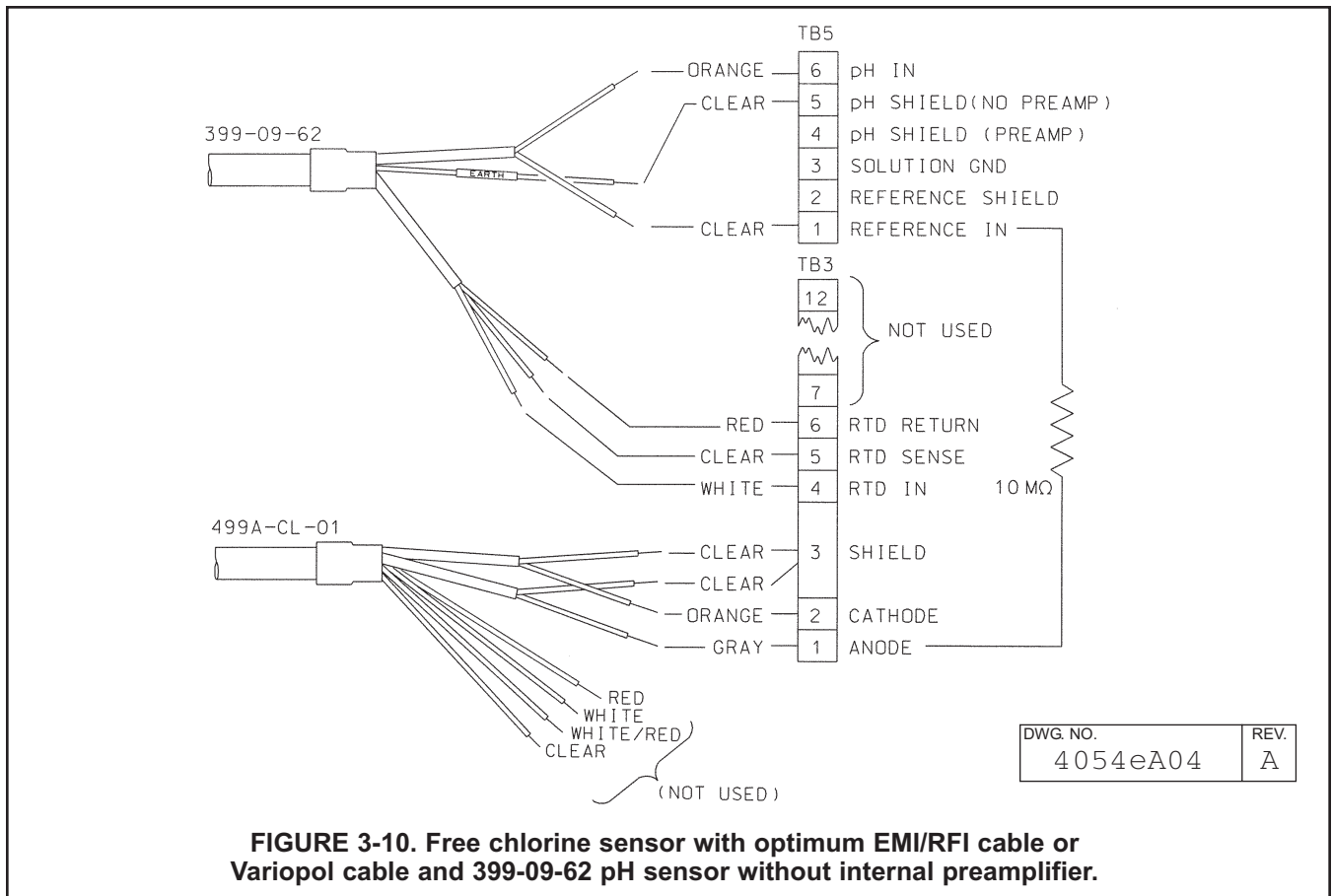

FIGURE 3-8. Free chlorine sensor with optimum EMI/RFI cable or Variopol cable and 399VP-09 pH sensor without internal preamplifier.



Although the blue wire is connected to a terminal labeled *solution ground*, the blue wire does not connect to a solution ground in the sensor. The 399-14 sensor has no solution ground. The blue wire, instead, ties the preamplifier in the sensor to instrument common.

FIGURE 3-9. Free chlorine sensor with optimum EMI/RFI cable or Variopol cable and 399-14 pH sensor having internal preamplifier.



3.3.4 Wiring Hx438 and Gx448 sensors

Hx438 and Gx448 steam-sterilizable dissolved oxygen sensors use a 22k NTC thermistor. The thermistor is wired to terminals 1 and 3 on TB5.

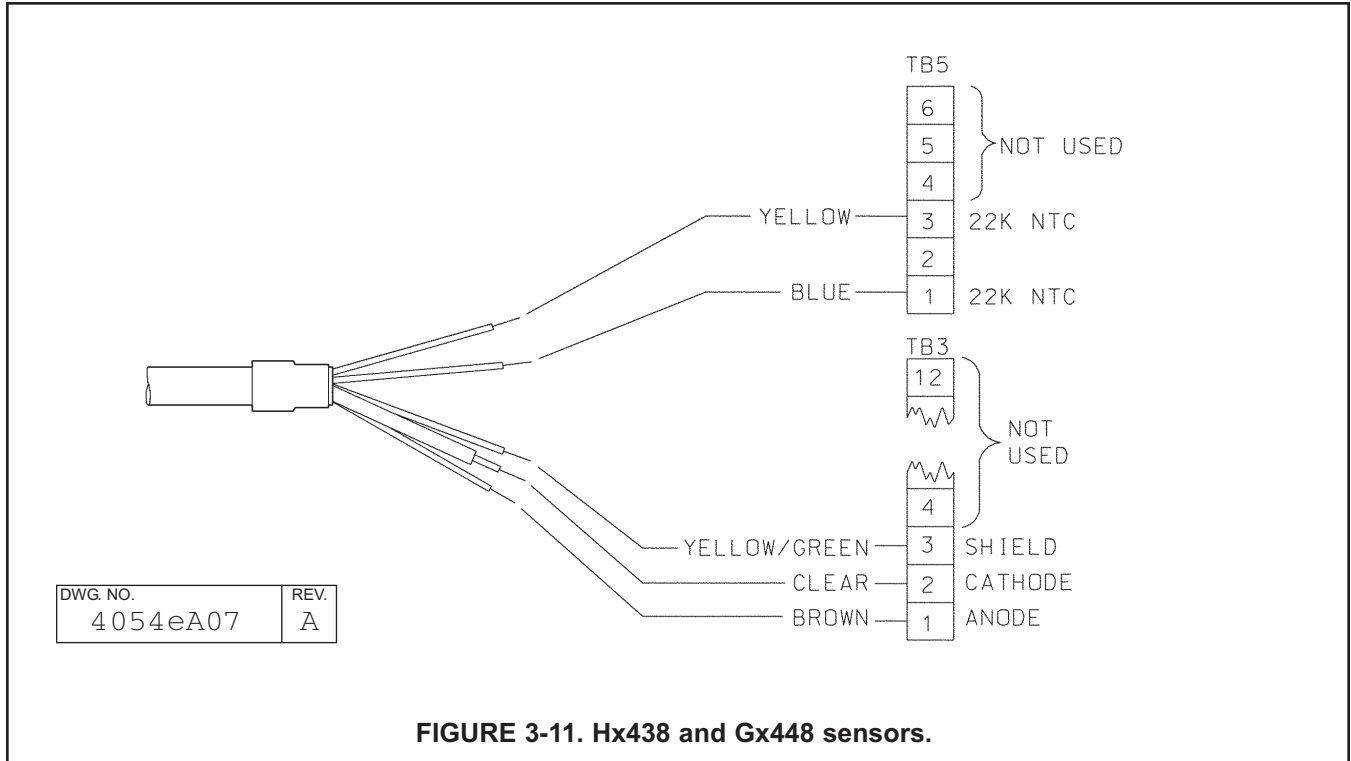

SECTION 4.0 DISPLAY AND OPERATION

4.1 GENERAL DESCRIPTION

The 54eA analyzer/controller is normally a single input, dual output instrument. It does, however, accept a second input for pH when the main measurement is free chlorine. Figure 4-1 shows how the instrument inputs and outputs can be configured for free chlorine.

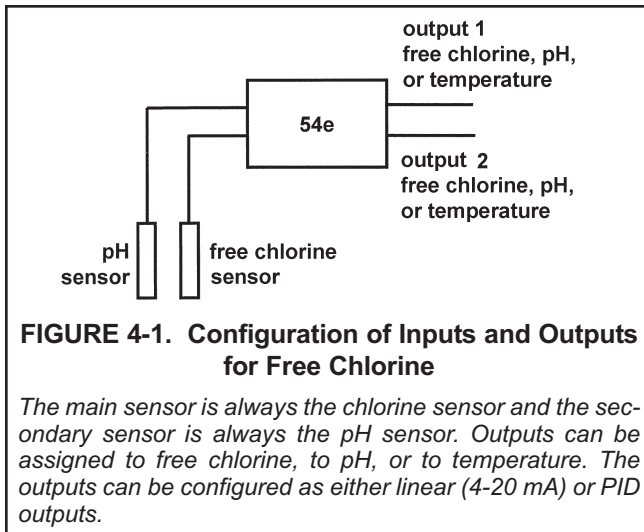

In addition to PID control, the 54eA controller can be used for time proportional control (TPC). TPC control uses the alarm relays.

4.2 DISPLAY

Figure 4-2 shows the main display.

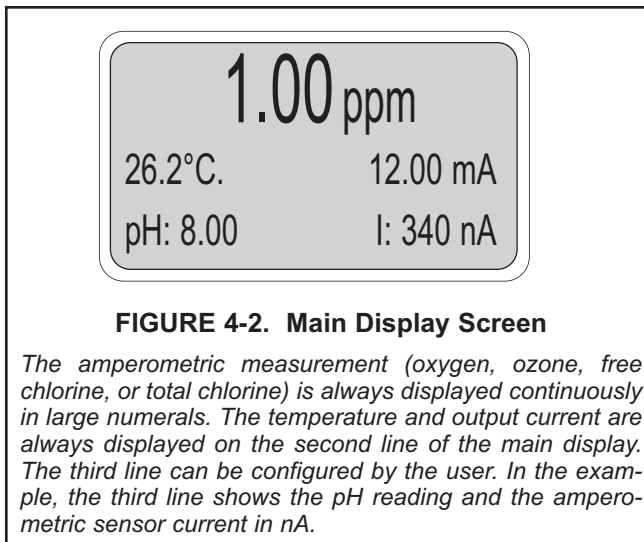

4.3 KEY FUNCTIONS AND CONTROLS

The keys labeled F1, F2, F3, and F4 are multi-function. The function appears in the main display just above the key. For example, F1 is usually labeled Exit and F4 may be labeled Edit, Save, or Enter.

1. To enter the main menu, press any key.
2. Use the \uparrow and \downarrow keys to move the cursor to the desired sub-menu. The position of the cursor is shown in reverse video.

NOTE

When the last item of a menu has been reached, the cursor will be on the third line of the display. If the cursor is on the second line of the display more items remain. Continue pressing the \downarrow key.

3. Press Enter (F4) to access a sub-menu or an item in a sub-menu.
4. To change a number or a setting press Edit (F4). The display will change to show the cursor on the first digit or on a + or - sign. Use the \uparrow and \downarrow keys to increase or decrease a digit or to toggle the + and - signs. Use the \leftarrow and \rightarrow keys to move the cursor left and right.
5. If an entire number or a word is highlighted, use the \uparrow and \downarrow keys to scroll through the list of choices.
6. To store a number or setting in memory, press Save (F4).
7. To leave without storing changes, press Esc (F3).
8. To leave and return to the previous screen, press Exit (F1).
9. To end a calibration step and leave the previous calibration in place, press Abort (F1).
10. Occasionally, information screens will appear. To leave the information screen and move to the next screen press Cont (F3).

4.4 ALARM STATUS

Green LEDs (labeled 1, 2, and 3) indicate when alarm relays 1, 2, and 3 are energized. The fourth relay indicates a fault condition. When a fault occurs, the red LED (labeled FAIL) lights up, a descriptive error message appears, and the outputs and alarm relays act as described in Section 5.6 and Section 5.7 under fault value.

The red LED also indicates when the interval timer routine is activated and when the time limit has been reached on a feed limit timer. For more information on these subjects, see Section 5.7.

SECTION 5.0 SOFTWARE CONFIGURATION

The instrument is configured at the factory to measure oxygen.

Figure 5-1 is an outline of the menu structure.

Table 5-1 lists the default settings and the range of choices available for each setting. To reduce the chance of error when configuring the controller the first time, enter settings in the order shown in the table.

TABLE 5-1. Program Settings List

ITEM SETPOINTS	CHOICES	FACTORY SETTINGS
A. Alarms (Section 5.1)		
1. Alarm 1 (low action)		
a. if oxygen (ppm)	-99 to 99 ppm	0 ppm
b. if oxygen (ppb)	-999 to 999 ppb	0 ppb
c. if oxygen (% saturation)	0 to 200%	0 %
d. if chlorine, monochloramine, or ozone	-9999 to 9999 ppm	0 ppm
e. if pH	-2.00 to 20.00	0.00
f. if temperature	-5 to 130°C	0.1°C
2. Alarm 2 (high action)		
a. if oxygen (ppm)	-99 to 99 ppm	20 ppm
b. if oxygen (ppb)	-999 to 999 ppb	900 ppb
c. if oxygen (% saturation)	0 to 200%	200 %
d. if chlorine, monochloramine, or ozone	-9999 to 9999 ppm	20 ppm
e. if pH	-2.00 to 20.00	14.00
f. if temperature	-5 to 130°C	130°C
3. Alarm 3	See alarm 2	See alarm 2
B. Outputs (Section 5.2 and 5.3)		
1. Output 1 or 2: 4 mA setting		
a. if oxygen (ppm)	-99 to 99 ppm	0 ppm
b. if oxygen (ppb)	-999 to 999 ppb	0 ppb
c. if oxygen (% saturation)	0 to 200%	0 %
d. if chlorine, monochloramine, or ozone	-9999 to 9999 ppm	0 ppm
e. if pH	-2.00 to 20.00	0.0
f. if temperature	-5 to 130°C	0.1°C
2. Output 1 or 2: 20 mA setting		
a. if oxygen (ppm)	-99 to 99 ppm	20 ppm
b. if oxygen (ppb)	-999 to 999 ppb	900 ppb
c. if oxygen (% saturation)	0 to 200%	200%
d. if chlorine, monochloramine, or ozone	-9999 to 9999 ppm	20 ppm
e. if pH	-2.00 to 20.00	14.00
f. if temperature	-5 to 130°C	130°C
3. Setpoint (PID)		
a. if oxygen (ppm)	-99 to 99 ppm	1.00 ppm
b. if oxygen (ppb)	-999 to 999 ppb	100 ppb
c. if oxygen (% saturation)	0 to 200%	100%
d. if chlorine, monochloramine, or ozone	-9999 to 9999 ppm	1.00 ppm
e. if pH	-2.00 to 20.00	7.00
f. if temperature	-5 to 130°C	25°C

Continued on the following page

TABLE 5-1. Program Settings List (continued)

ITEM CONFIGURE	CHOICES	FACTORY SETTINGS
A. Display options (Section 5.5)		
1. Measurement	Oxygen, ozone, free chlorine, total chlorine, monochloramine	Oxygen
2. Sensor (Oxygen only)	Rosemount standard, Rosemount biopharm, or other steam sterilizable	Rosemount standard
3. Units (Oxygen only)	ppm, ppb, % saturation	ppm
4. Temperature units	°C or °F	°C
5. Output 1	mA or % of full scale	mA
6. Output 2	mA or % of full scale	mA
7. Language	English, Français, Español, Deutsch, Italiano	English
8. Main display left	See section 5.5	Sensor current
9. Main display right	See section 5.5	Output 1 current
10. Display contrast	00-99 (darkest)	50
11. Test timeout	On or off	On
12. Timeout value	1 to 60 min	10 min
B Outputs (Section 5.6)		
1. Output 1 Control		
a. Measurement	Oxygen, chlorine, ozone, pH, or temperature	Oxygen
b. Control	Normal or PID	Normal
2. Output 1 Setup (normal)		
a. Current	4-20 mA or 0-20 mA	4-20 mA
b. Dampening	0-299 sec	0 sec
c. Hold mode	Hold last value or go to fixed value	Hold last value
d. Fixed hold value	0-22 mA	21 mA
e. Fault value	0-22 mA	22 mA
3. Output 1 Setup (PID)		
a. Proportional	0 to 299.9%	100 %
b. Integral	0 to 2999 sec	0 sec
c. Derivative	0 to 299.9%	0/0%
4. Output 2 Control		
a. Measurement	Oxygen, chlorine, ozone, pH, or temperature	Temperature
b. Control	Normal or PID	Normal
5. Output 2 Setup (normal)	See output 1	See output 1
6. Output 2 Setup (PID)	See output 1	See output 1
7. Hold feature	Enable, disable, or 20 min timeout	Disable
C. Alarms (Section 5.7)		
1. Alarm 1 Control		
a. Activation method	Oxygen, chlorine, ozone, temperature, pH	Oxygen
b. Control mode	Normal or TPC	Normal
2. Alarm 1 setup (normal)		
a. Configuration	Low, high, or off	High
b. Hysteresis		
if oxygen (ppm)	0 to 20 ppm	0 ppm
if oxygen (ppb)	0 to 999 ppb	0 ppb
if oxygen (% saturation)	0 to 200%	0%
if chlorine, monochloramine, or ozone	-9999 to 9999 ppm	0 ppm
if pH	0 to 14.00	0 pH
if temperature	0 to 10°C	0.1°C
c. Delay time	0-99 sec	0 sec
d. Relay fault	none, open, closed	None

TABLE 5-1. Program Settings List (continued)

ITEM	CHOICES	FACTORY SETTINGS
CONFIGURE (continued)		
C. Alarms (Section 5.7) (continued)		
3. Alarm 1 setup (TPC)		
a. Setpoint		
if oxygen (ppm)	-20 to 20 ppm	1 ppm
if oxygen (ppb)	-999 to 999 ppb	100 ppb
if oxygen (% saturation)	0 to 200%	100%
if chlorine, monochloramine, or ozone	-9999 to 9999 ppm	1.0 ppm
if pH	-2.0 to 20.00	7.00
if temperature	-5 to 130°C	25°C
b. Proportional	0 to 299.9%	100 %
c. Integral	0 to 2999 sec	0 sec
d. Derivative	0 to 299.9%	0.0%
e. Time period	10 to 2999 sec	30 sec
f. LRV (100% on)		
if oxygen (ppm)	-20 to 20 ppm	0 ppm
if oxygen (ppb)	-999 to 999 ppb	0 ppb
if oxygen (% saturation)	0 to 200%	0%
if chlorine, monochloramine, or ozone	-9999 to 9999 ppm	0 ppm
if pH	-2.0 to 20.00	0.00
if temperature	-5 to 130°C	0°C
g. URV (100% off)		
if oxygen (ppm)	-20 to 20 ppm	2 ppm
if oxygen (ppb)	-999 to 999 ppb	100 ppb
if oxygen (% saturation)	0 to 200%	200%
if chlorine, monochloramine, or ozone	-9999 to 9999 ppm	2 ppm
if pH	-2.0 to 20.00	2.00
if temperature	-5 to 130°C	100°C
h. Relay fault		
	None, open, or closed	None
4. Alarm 2 Control		
a. Activation method	Oxygen, chlorine, monochloramine, ozone, temperature, pH	Oxygen
b. Control mode	Normal or TPC	Normal
5. Alarm 2 setup (normal)		
a. Configuration	Low, high, or off	Low
Rest of alarm 2 setup is the same as alarm 1		
6. Alarm 3 control and setup is the same as alarm 1		
7. Alarm 4 control		
Alarm	Fault or off	Fault
8. Feed limit timer		
a. Feed limit	Disable, alarm 1, alarm 2, or alarm 3	Disable
b. Timeout value	0 to 10,800 sec	600 sec
9. Interval timer		
a. Select alarm	Disable, alarm 1, alarm 2, or alarm 3	Disable
b. Interval time	0 to 999.9 hr	24.0 hr
c. Repeats	1 to 60	1
d. On time	0 to 2999 sec	120 sec
e. Off time	0 to 2999 sec	1 sec
f. Recovery time	0 to 999 sec	600 sec

Continued on the following page

TABLE 5-1. Program Settings List (continued)

ITEM	CHOICES	FACTORY SETTINGS
CONFIGURE (continued)		
D. pH measurement (Section 5.8)		
1. pH sensor	Enable or disable	Enable
2. pH compensation (free chlorine only)	Auto or manual	Auto
3. pH value	0.00 - 14.00	7.00
4. pH diagnostic	On or off	Off
a. Glass impedance high	0-2000 M Ω (0 disables)	1000 M Ω
b. Glass impedance low	0-900 M Ω (0 disables)	20 M Ω
c. Reference impedance high	0-140 k Ω (0 disables)	140 k Ω
d. Zero offset	0-999 mV	60 mV
e. Impedance temp. compensation	On or off	On
5. pH calibration		
a. Auto calibration (buffer list)	Manual, Standard, Merck, Ingold, DIN 19267	Standard
b. Stabilize pH	0.01 - 0.50	0.1
c. Stabilization time	0-30 sec	10 sec
6. Solution temperature coefficient		
a. Temperature coefficient	-0.044 to 0.028 pH/ $^{\circ}$ C	0.000
b. Operating isopotential	-1.35 to 20.12 pH	7.00
c. Sensor isopotential	0 to 14 pH	7.00
E. Temperature compensation (Section 5.9)		
1. Temperature compensation	Auto or manual	Auto
2. Manual temperature	-15 to 130 $^{\circ}$ C	25 $^{\circ}$ C
F. Noise Reduction (section 5.10)		
Noise rejection	50 or 60 Hz	60 Hz
G. Main sensor calibration (Section 5.11)		
1. Stabilize reading		
a. oxygen (ppm)	0 to 20 ppm	0.05 ppm
b. oxygen (ppb)	0 to 999 ppb	50 ppb
c. oxygen (% saturation)	0 to 200%	1%
d. chlorine, monochloramine, or ozone	0 to 9999 ppm	0.05 ppm
2. Stabilize time	0 - 30 sec	10 sec
3. Sensor zero stabilization value		
4. Dual range calibration	Enable or disable	disable
5. Salinity (parts per thousand)	0.0 - 99.9 ‰	0.0 ‰
H. Barometric Pressure (Section 5.12)		
1. Barometric pressure (oxygen only)	Auto or manual	Auto
2. Barometric pressure manual	0.4 - 1.2 atm (or equivalent units)	1.00 atm
3. Barometric pressure units	mm Hg, in Hg, bar, kPa	mm Hg
I. Security (Section 5.13)		
1. Lock all	000-999 (000 disables)	000
2. Lock program	000-999 (000 disables)	000
3. Lock configuration	000-999 (000 disables)	000

FIGURE 5-1. Menu Tree for the 54eA Controller

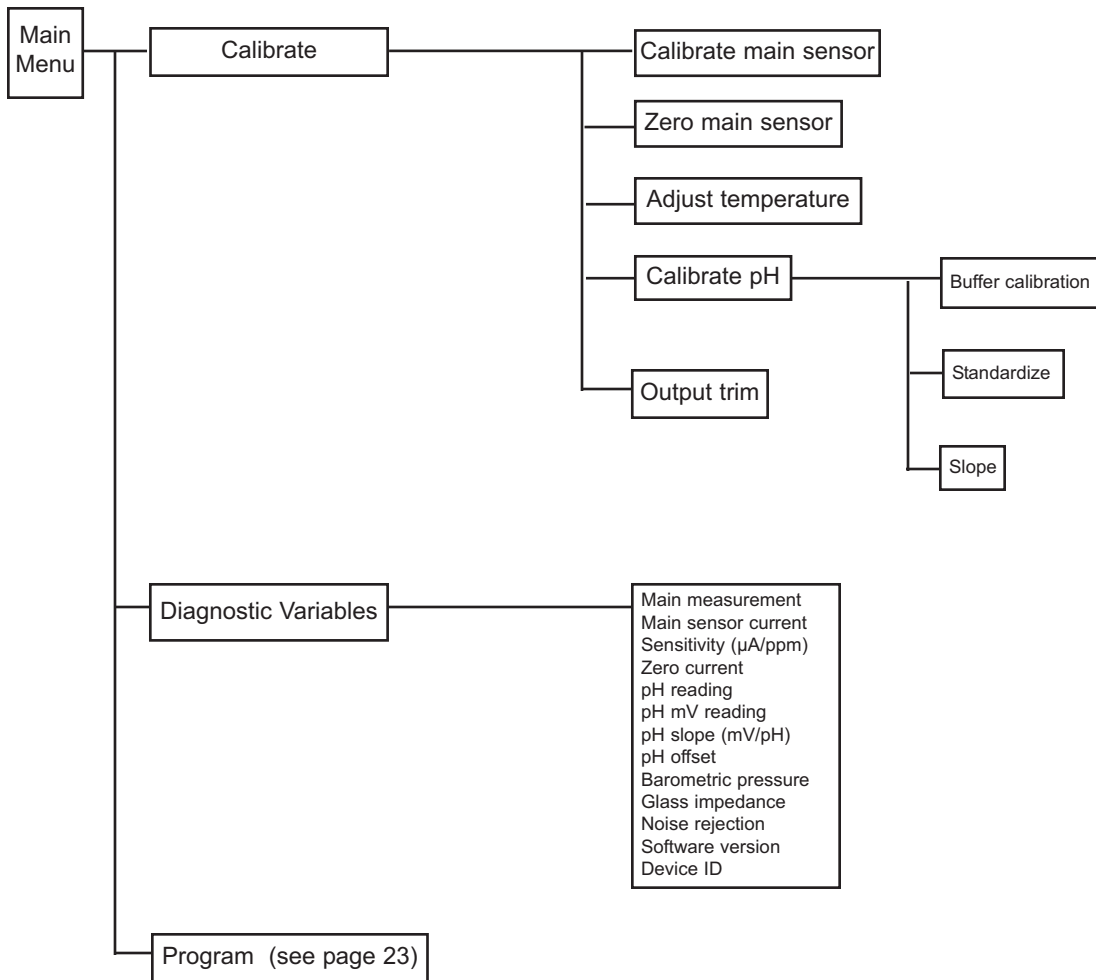

**FIGURE 5-1. Menu Tree for the 54eA Controller
(continued)**

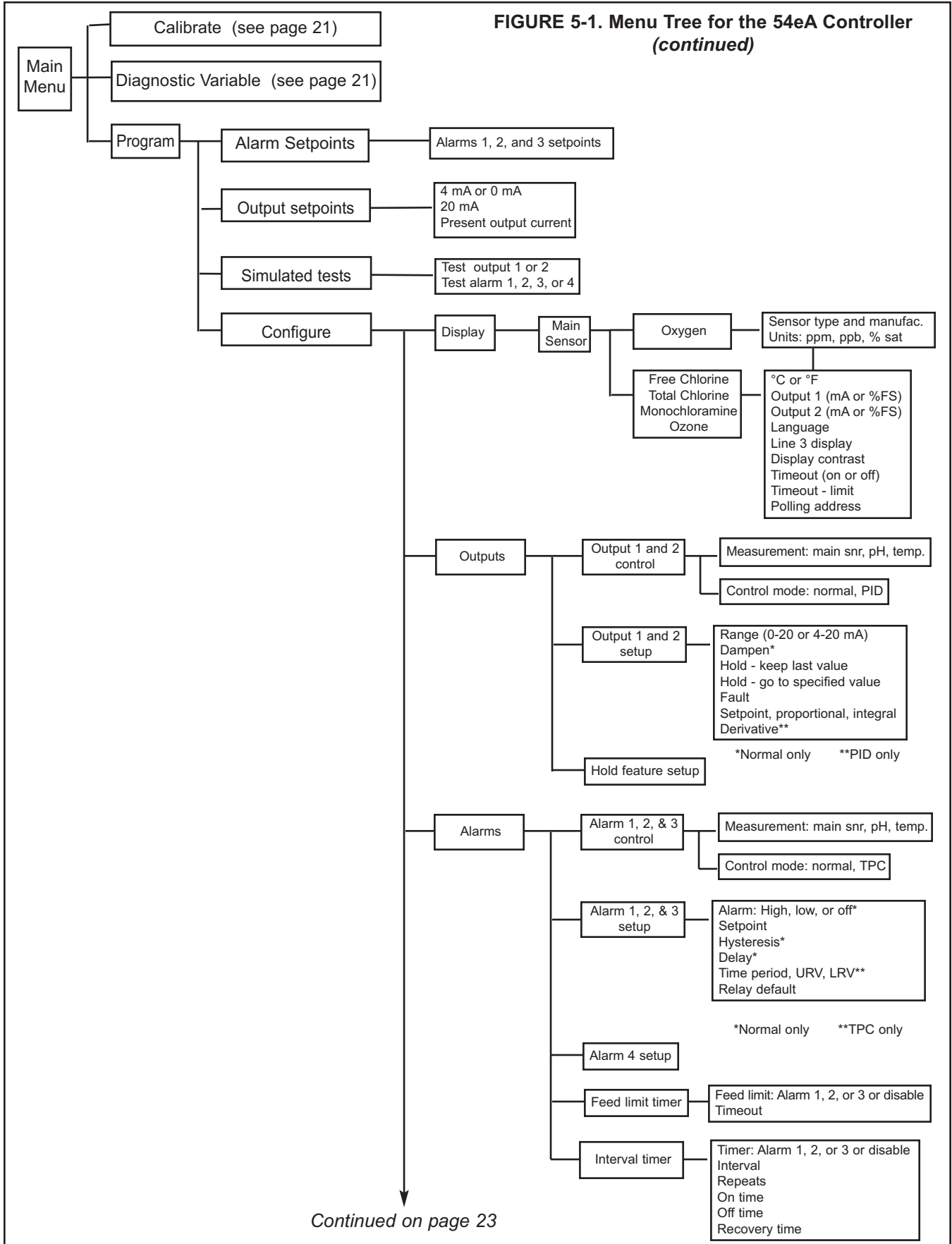
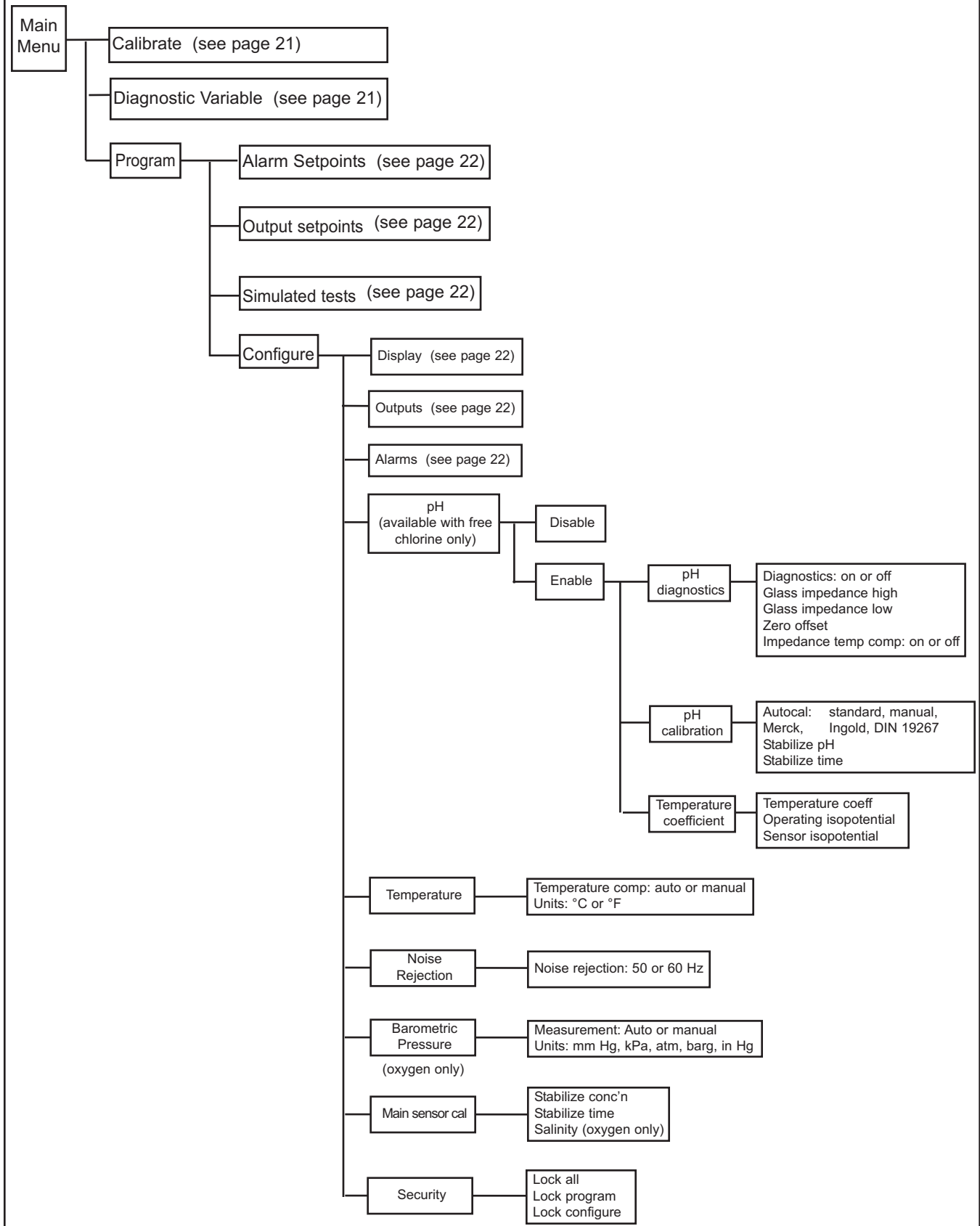
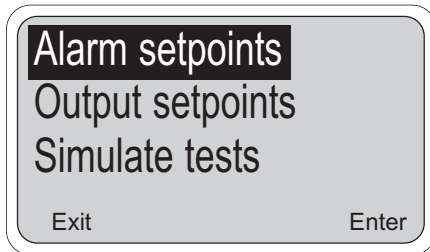

FIGURE 5-1. Menu Tree for the 54eA Controller (continued)



5.1 CHANGING ALARM SETPOINTS

1. Before changing alarm setpoints, be sure that alarms are properly configured. See Section 5.7.



2. Press any key to enter the main menu. Move the cursor to "Program" and press Enter (F4).

3. Press Enter (F4).

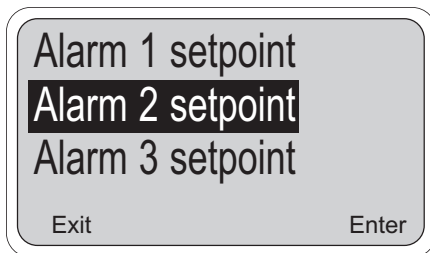

4. Move the cursor to the desired alarm and press Enter (F4).

5. The screen appearing at this point depends on how the alarm was configured.

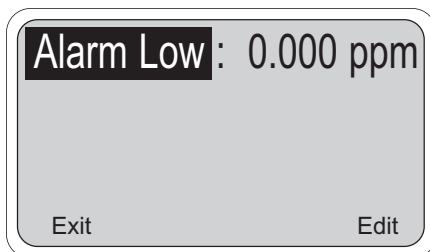

6. If the alarm is a normal (i.e., not TPC) alarm, a screen like the one shown will appear. The alarm is a low alarm and the setpoint is 0.00 ppm. Press Edit (F4). Use the arrow keys to change the setpoint. Press Save (F4) to store the new value. Press Exit (F1) to return to the screen in step 4. Choose a new alarm.

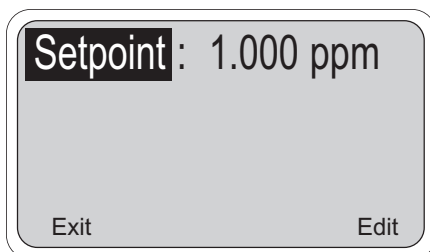

7. If the alarm is TPC, a screen like the one shown will appear. The setpoint is +1.000 ppm. Press Edit (F4). Use the arrow keys to change the setpoint. Press Save (F4) to store the new value. Press Exit (F1) to return to the screen in step 4. Choose a new alarm.

5.2 RANGING THE OUTPUTS

1. Ranging the outputs means assigning values to the low (0 or 4 mA) and high (20 mA) outputs. **Before ranging the outputs, be sure the outputs are properly configured. See Section 5.6.**

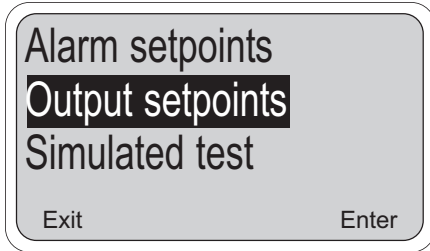

2. Press any key to enter the main menu. Move the cursor to "Program" and press Enter (F4).

3. Move the cursor to "Output setpoints" and press Enter (F4).

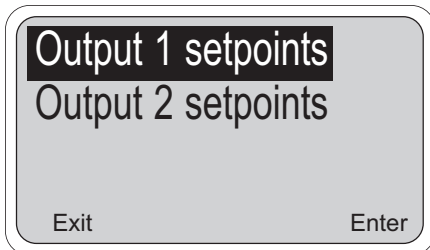

4. Move the cursor to the desired output and press Enter (F4).

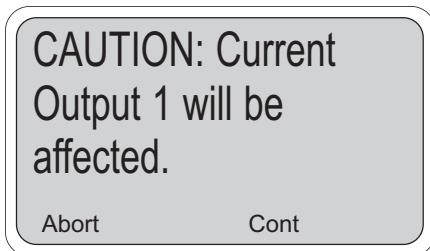

5. This screen confirms that changes to output 1 are going to be made. Use caution. Changes may degrade process control. Press Cont (F3) to continue. Otherwise, press Abort (F1).

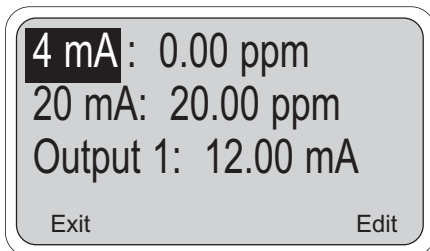

6. This screen shows the present settings for Output 1. If the output was configured to be 0-20 mA, the first line will show "0mA" instead of "4mA". The live current output is shown on the third line.

Move the cursor to the desired line and press Edit (F4). Use the arrow keys to change the setpoint. Press Save (F4) to store the new value.

Press Exit (F1) to return to the screen in step 4. Choose the other output and continue.

5.3 CHANGING OUTPUT SETPOINTS (PID ONLY)

1. This section describes how to assign the setpoint and the upper and lower range values (URV and LRV) when the 54eA is being used for PID control. Assign the LRV to 4 mA and the URV to 20 mA. The LRV is the deviation from the setpoint that will result in a 4 mA output. The URV is the deviation from the setpoint that will result in a 20 mA output.

Example: The setpoint is 1.00 ppm. The URV is +0.50 and the LRV is 0.00. If the present reading is 1.20 ppm, the output will be $(1.20 - 1.00)/(0.50 - 0.00)$ or 40% of the range (10.40 mA). If the present reading is 1.50 ppm, the output will be $(1.50 - 1.00)/(0.50 - 0.00)$ or 100% of the range (20.00 mA). If the present reading is less than the setpoint, the output will be 4 mA.

The control setpoint is usually the condition where the output current is a minimum. The P and I control calculations use the setpoint to adjust the output to the desired level based on the parameters established in Section 5.6.

To configure the controller for PID control, see Section 5.6.

2. Press any key to enter the main menu. Move the cursor to "Program" and press Enter (F4).

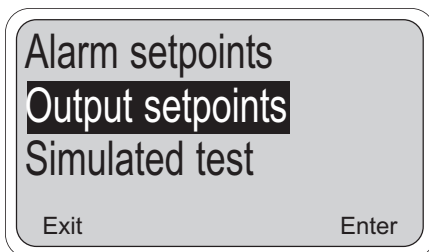

3. Move the cursor to "Output setpoints" and press Enter (F4).

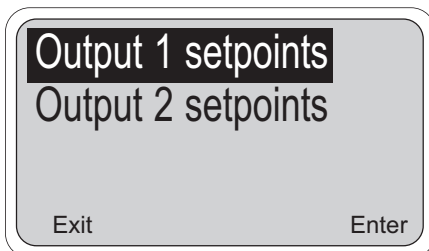

4. Move the cursor to the desired output and press Enter (F4).

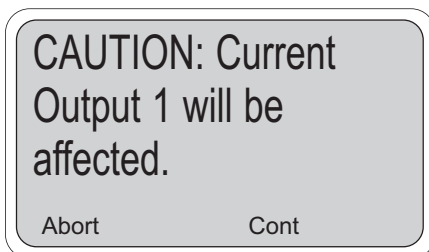

5. This screen confirms that changes to output 1 are going to be made. Use caution. Changes may degrade process control. Press Cont (F3) to continue. Otherwise, press Abort (F1).

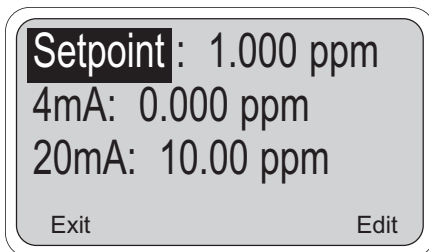

6. This screen shows the present settings for Output 1. If the output was configured to be 0-20 mA, the second line will show "0mA" instead of "4mA". The live current output is shown on the fourth line. Press the ↓ key once to view the live output.

Move the cursor to the desired line and press Edit (F4). Use the arrow keys to change the value. Press Save (F4) to store the new value.

Press Exit (F1) to return to the screen in step 4. Choose the other output and continue.

5.4 TESTING OUTPUTS AND ALARMS

- For testing purposes, the controller can be programmed to generate simulated outputs and to activate and deactivate alarms.

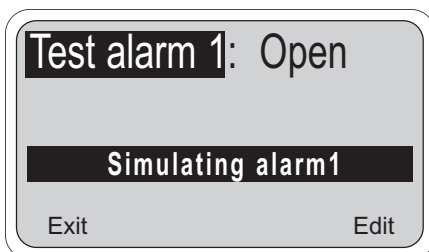
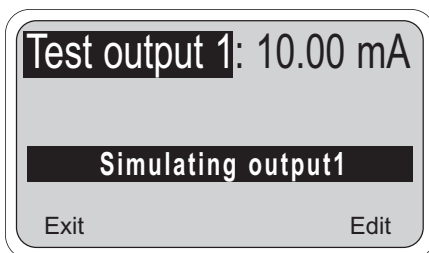
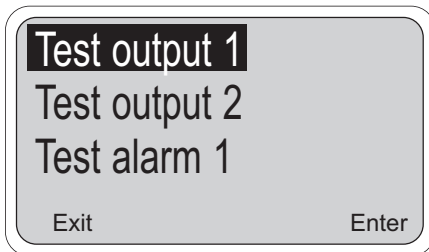
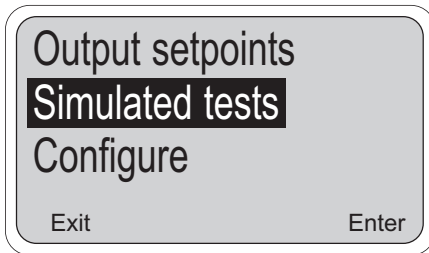

- Press any key to enter the main menu. Move the cursor to "Program" and press Enter (F4).

- Move the cursor to "Simulated tests" and press Enter (F4).

- Move the cursor to the desired output or alarm. Both outputs and all four alarms can be tested. Press Enter (F4).

A screen will appear warning that the output or alarm will change. Press Cont (F3) to continue. Press Abort (F1) to cancel the simulation.

- This screen appears when an output is being simulated. To change the simulation current, press Edit (F4). Use the arrow keys to change the current to the desired value. Press Test (F4), then Esc (F3).

The simulated current will be generated for 10 minutes, then the output returns to normal operation. To change the timeout to a different value see Section 5.5.

To end the simulation at any time, press Exit (F1).

- This screen appears when an alarm is being simulated. To change the state of the relay, press Edit (F4). Use the \uparrow or \downarrow keys to change from open to closed. Press Test (F4), then Esc (F3).

The alarm will be simulated for 10 minutes, then the alarm returns to normal operation. To change the timeout to a different value, see Section 5.5.

To end the simulation at any time, press Exit (F1).

5.5 CHOOSING DISPLAY OPTIONS

1. The 54eA controller can be used with most amperometric sensors manufactured by Rosemount Analytical. The user must configure the analyzer to match the sensor being used.
2. The display menu also lets the user customize the third line in the display, change timeout values, choose a language other than English, and change the display contrast.

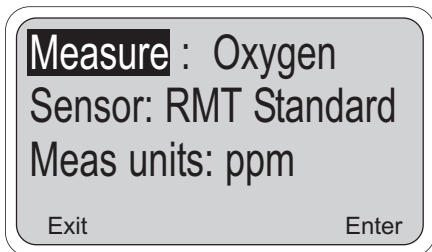
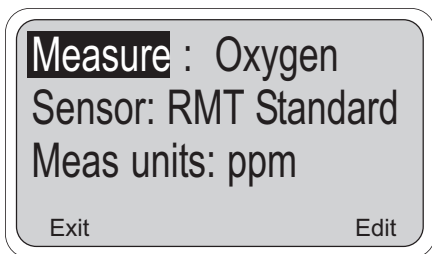
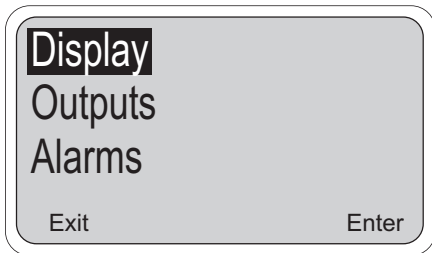
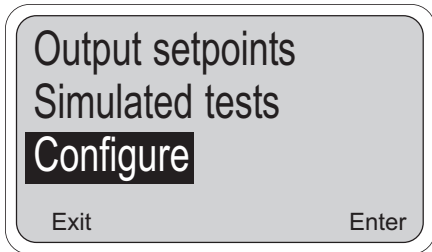

3. Press any key to enter the main menu. Move the cursor to "Program" and press Enter (F4).

4. Move the cursor to "Configure" and press Enter (F4).

5. With the cursor on "Display", press Enter (F4).

6. A screen showing the present main measurement will appear. To change the measurement, for example, from oxygen to ozone, press Edit (F4), then use the ↑ key to scroll through the choices. Press Save (F4) to store the setting.

A screen will appear warning that if the measurement is changed, the analyzer will return to factory default settings. Press Cont (F3) to continue. Press Abort (F1) to cancel the change.

7. If oxygen is being measured, the screen at left appears. Use the ↓ key to move the cursor to "Sensor" and press Edit (F4). Use the ↑ or ↓ keys to scroll through the choices. Press Save (F4) to store the selection.

RMT Standard	499ADO or 499ATrDO
RMT Biopharm	Hx438 or Gx448
SSDO Other	Steam sterilizable sensor from other manufacturers

Use the ↓ key to move the cursor to "Meas units" and press Edit (F4). Use the ↑ or ↓ keys to scroll through the choices. Press Save (F4) to store the selection.

ppm	(mg/L) use with any sensor except 499ATrDO
ppb	(ug/L) use with 499ATrDO sensor
% sat	(concentration as a percent of saturation value) use with any sensor except 499ATrDO

5.5 CHOOSING DISPLAY OPTIONS (CONTINUED)

Temp units: °C
Output 1: mA
Output 2: mA
Exit Edit

Language: English
Display left: I
Display right: Out 2
Exit Edit

Display contrast: 40
Timeout: On
Timeout value: 10 min
Exit Edit

8. Set the remainder of the display parameters. Use the ↑ and ↓ keys to choose the desired parameter. Then press Edit (F4). Use the ↑ key to move the cursor to the desired selection. Press Save (F4) to store.

Temp units	°C or °F
Output 1	mA or % of full scale
Output 2	mA or % of full scale
Language	English, Français, Español, Deutsch, Italiano
Display left	sensor current (I), pH (appears only if free chlorine is being measured and pH was enabled), alarm 1 setpoint (no units), alarm 3 setpoint (no units), or blank
Display right	sensor current (I), pH (appears only if free chlorine is being measured and pH was enabled), alarm 2 setpoint (no units), alarm 3 setpoint (no units), output 2, or blank
Display Contrast	00 (lightest)-99 (darkest); the display contrast changes as the number changes
Timeout	Timeout returns the display from any other screen to the main display if no key is pressed before the timeout value is exceeded.
Timeout value	
Polling address	Identifies controller in multi-drop HART applications.

SECURITY CAUTION

The controller uses the timeout value to activate security. Once the controller is unlocked by entering a security code, security will not re-activate until a display timeout occurs. If timeout has been turned off, security will never reactivate.

5.6 CHANGING OUTPUT PARAMETERS

1. This section describes how to configure the controller outputs. Outputs can be configured to represent the main amperometric measurement (oxygen, ozone, free chlorine, or total chlorine), temperature, or pH (if free chlorine is being measured and pH was enabled).
2. The output can be configured as either a normal or PID output. Normal means the output current is directly proportional to the measurement assigned to the output. PID means the output is used for PID control.

3. Press any key to enter the main menu. Move the cursor to "Program" and press Enter (F4).

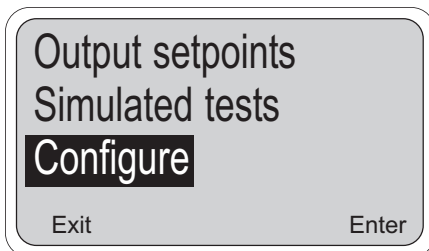

4. Move the cursor to "Configure" and press Enter (F4).

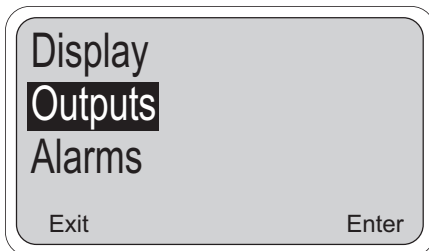

5. Move the cursor to "Outputs" and press Enter (F4).

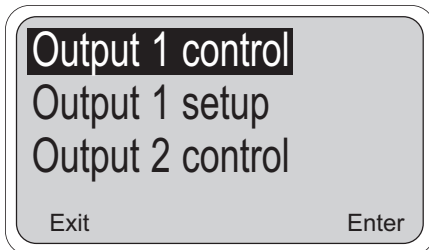

6. Five menu headers relate to outputs. Each output has a control header and a setup header. The fifth header allows the output hold feature to be configured.

Always configure the control parameters BEFORE making changes in the output setup.

To access a header, move the cursor to the desired header and press Enter (F4).

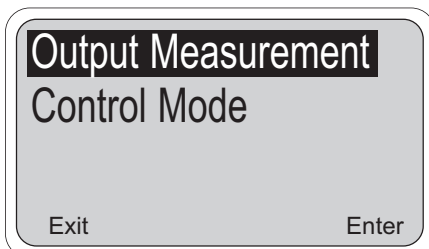

7. **Output Control Settings:**

- a. Move the cursor to the desired output control header. Press Enter (F4).

- b. With the cursor on "Output Measurement" press Enter (F4).

- c. Press Edit (F4).

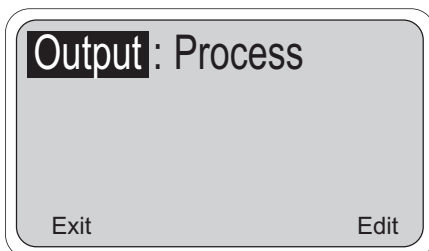

- d. Use the ↑ key to scroll through the choices: "Process", "Temperature", and "pH" (if free chlorine is being measured and pH was enabled). "Process" means the measurement made by the main sensor (oxygen, ozone, free chlorine, or total chlorine). Press Save (F4) to store the selection.

5.6 CHANGING OUTPUT PARAMETERS (continued)

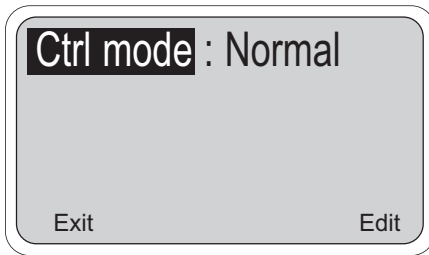

e. The display returns to the "Output: Process" screen. Press Exit (F1). The display returns to the "Output Measurement" screen. Move the cursor to "Control mode" and press Enter (F4).

f. Press Edit (F4). Use the \uparrow key to toggle between "Normal" and "PID". Press Save (F4) to store the selection.

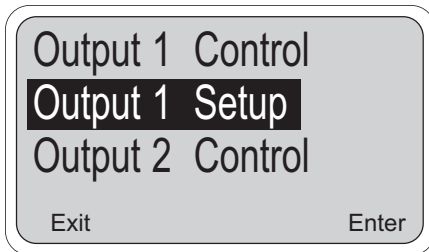

8. Output setup for normal outputs:

a. Move the cursor to the desired output setup and press Enter (F4).

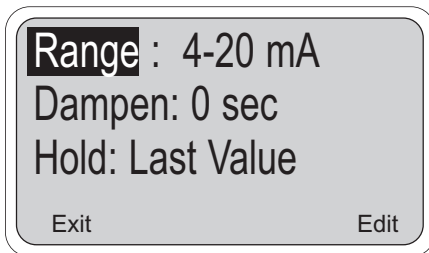

b. Use the \uparrow and \downarrow arrow keys to move the cursor to the desired parameter. Press Edit (F4). Use the arrow keys to change the setting to the desired value and press Save (F4) to store the value.

Range: Choose 4-20 mA or 0-20 mA.

Dampen: Dampening averages the output current, thus smoothing out a noisy reading. Higher values provide more smoothing but increase the response time of the output.

Hold and Fixed Hold: If the analyzer is placed in hold, the outputs will either remain at the last value or go to a fixed value selected by the user. The fixed value must be between 0 and 22.00 mA.

Fault: If the analyzer detects a fault, the output will signal the fault by going to a user-selected current between 0 and 22.00 mA.

For allowed values, see Table 5-1.

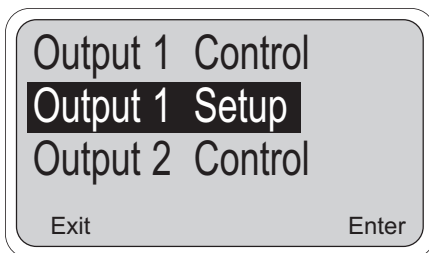

9. Output setup for PID outputs:

a. Move the cursor to the desired output setup and press Enter (F4).

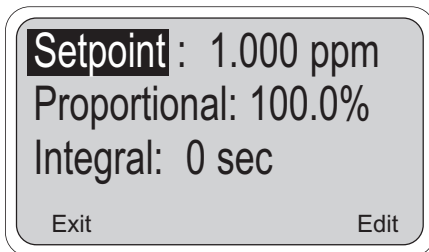

b. Use the \uparrow and \downarrow keys to move the cursor to the desired parameter. Press Edit (F4). Use the arrow keys to change the setting to the desired value and press Save (F4) to store the value.

Setpoint: Setpoint is usually the value at which the process is being controlled. Typically, the output will be 4 mA (or 0 mA) when the value is near the setpoint.

Proportional: Proportional is the same as proportional band and is the range over which control is being used. It is the opposite of process gain. Smaller values provide tighter control.

5.6 CHANGING OUTPUT PARAMETERS (continued)

Integral: Integral is the number of seconds over which deviations from the setpoint are integrated to remove continuing offsets. Smaller values provide higher response.

Derivative: Derivative is a form of control that resists all changes in readings. Higher readings increase the derivative function. To prevent process oscillation, use caution in setting the derivative value.

Range: Choose 4-20 mA or 0-20 mA.

For an explanation of **Hold**, **Fixed Hold**, and **Fault**, see step 8b above.

For allowed values, see Table 5-1.

For more information using PID control, see Section 13.0.

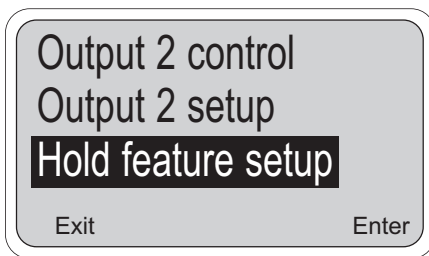

10. Hold setup.

- Move the cursor to "Hold feature setup" and press Enter (F4).
- Press Edit (F4). Use the \uparrow to scroll through the choices: "Disable feature", "Enable feature", and "20 min timeout". If "20 min timeout" is selected, hold mode will automatically disengage after being on for 20 minutes.

NOTE

Selecting "Enable hold" or "20-min timeout" does not put the controller in hold. It only allows the user to put the controller in hold when the controller is in calibrate mode.

11. Using hold.

If hold was enabled in step 10 above, the hold screen will appear as soon as the user enters the Calibrate menu. To activate Hold, press Edit (F4). Use the \uparrow key to change Off to On and press Save (F4). "Hold Mode Activated" will be displayed. Outputs and relays will go to the values programmed in step 8b.

"Hold Mode Activated" will continue to flash in the main display even after the user has left the Calibrate menu. To deactivate hold, enter the Calibrate menu and press Edit (F4). Use the \uparrow key to change On to Off and press Save (F4). Press Exit (F1) twice to return to the main display.

5.7 CHANGING ALARM PARAMETERS

1. This section describes how to configure the controller alarms. Alarms 1, 2, and 3 can be assigned to the main amperometric measurement (oxygen, ozone, free chlorine, or total chlorine), temperature, or pH (if pH was enabled). In addition, alarm 1, 2, or 3 can be configured as a feed limit timer or as an interval timer (see steps 10 and 11). Alarm 4 is always a fault alarm.
2. An alarms assigned to the main amperometric measurement, temperature, or pH can be configured as either a simple on/off alarm or as TPC (time proportional control) alarm.

3. Press any key to enter the main menu. Move the cursor to "Program" and press Enter (F4).

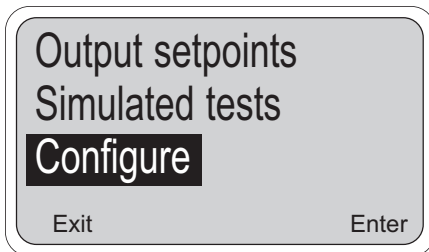

4. Move the cursor to "Configure" and press Enter (F4).

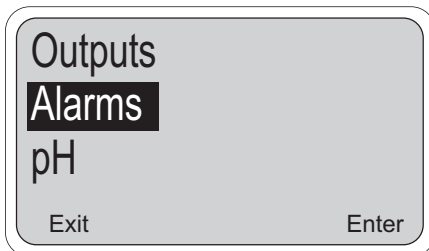

5. Move the cursor to "Alarms" and press Enter (F4).

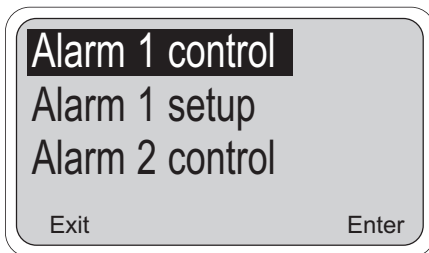

6. Nine menu headers relate to alarms. Alarms 1, 2 and 3, each have a control header and a setup header. Alarm 4 has only a setup header. The eighth menu header is for configuring the feed limit timer, and the ninth menu header is for configuring the interval timer.

Always configure the control parameters BEFORE making changes in the alarm setup.

To access a header, move the cursor to the desired header and press Enter (F4).

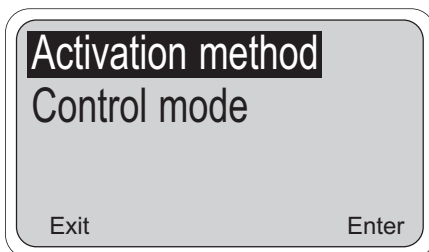

7. **Alarm Control Settings:**
 - a. Move the cursor to the desired output control header. Press Enter (F4).
 - b. With the cursor on "Activation method" press Enter (F4).

5.7 CHANGING ALARM PARAMETERS (continued)

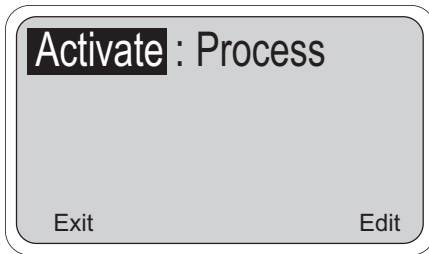

- c. To change the activation method, press Edit (F4). Use the ↑ key to scroll through the choices: "Process", "Temperature", and "pH" (if pH was enabled). "Process" means the measurement made by the main sensor (oxygen, ozone, free chlorine, or total chlorine). Press Save (F4) to store the selection.

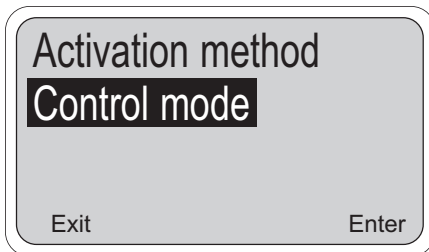

- d. The display returns to the "Activate: Process" screen. Press Exit (F1). The display returns to the "Activation method" screen. Move the cursor to "Control mode" and press Enter (F4).

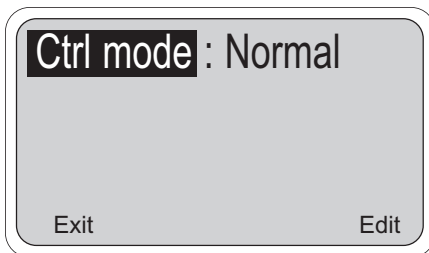

- e. To change the control mode, press Edit (F4). Use the ↑ key to toggle between "Normal" and "TPC". Press Save (F4) to store the selection.

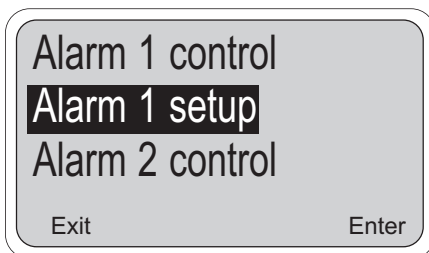

8. Alarm setup for normal alarms:

- a. Move the cursor to the desired alarm setup and press Enter (F4).

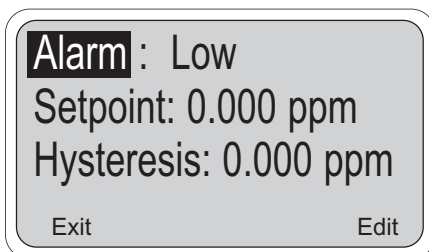

- b. Use the ↑ and ↓ keys to move the cursor to the desired parameter. Press Edit (F4). Use the arrow keys to change the setting to the desired value and press Save (F4) to store the value. See the Figures 5-2 and 5-3 for an explanation of terms: **low alarm**, **high alarm**, **hysteresis**, and **delay**. See Table 5-1 for allowed values and limits.

Relay default determines how the relay will operate if there is a fault or the controller is in hold. Alarms can be forced on (Close), off (Open), or remain unchanged (None).

5.7 CHANGING ALARM PARAMETERS (continued)

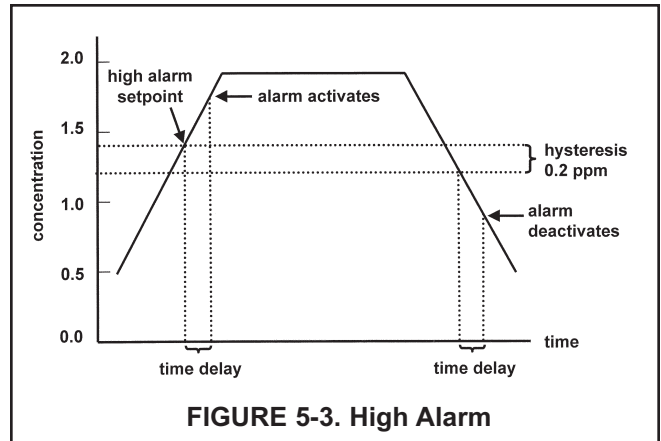
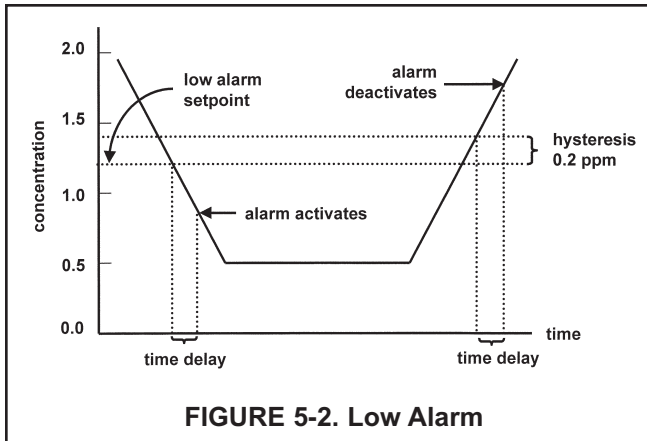

9. Alarm setup for TPC alarms:

- a. Move the cursor to the desired alarm setup and press Enter (F4).

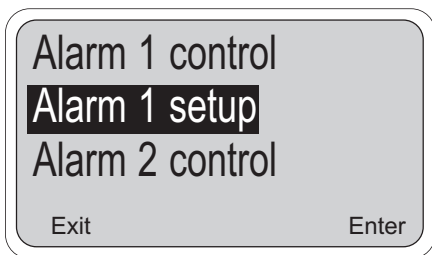

- b. Use the ↑ and ↓ keys to move the cursor to the desired parameter. Press Edit (F4). Use the arrow keys to change the setting to the desired value and press Save (F4) to store the value

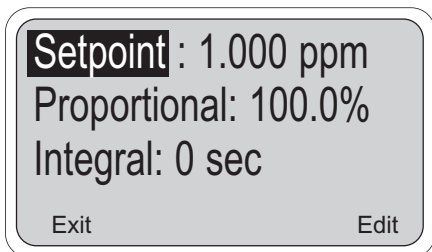

Setpoint: Setpoint is the usually the value to which the process is to be controlled. The alarm will not be on much when the process is at the setpoint value.

Proportional: Proportional is the same as proportional band and is the range over which control is being used. It is the opposite of process gain. Smaller values provide tighter control.

Integral: Integral is the number of seconds over which deviations from the setpoint are integrated to remove continuing offsets. Smaller values provide higher response.

Derivative: Derivative is a form of control that resists all changes in readings. Higher readings increase the derivative function. To prevent process oscillation, use caution in setting the derivative value.

Time period: Time period is the cycle time for TPC control. One cycle consists of an energized (relay on) time and a deenergized (relay off) time.

URV: URV is the deviation from the setpoint that results in the alarm being on all the time.

LRV: LRV is the deviation from the setpoint that results in the alarm being off all the time. The LRV should be set to 0.00.

5.7 CHANGING ALARM PARAMETERS (continued)

Example: The setpoint is 3.00 ppm. The URV is +5.00 ppm and the LRV is 0.00 ppm. The time period is 30 seconds. When the concentration is 4.00 ppm, the relay will be on $(4-3)/(5-0) = 20\%$ of the time or 6 seconds.

Relay default: Relay default determines how the relay will act if there is a fault or hold condition. The choices are on (relay closed), off (relay open), or none (relay remains unchanged).

USE OF TPC

Setting TPC parameters is not trivial. Substantial trial and error is often needed before results are acceptable. For non-linear measurements, like pH, applying PID algorithms can result in unintended effects.

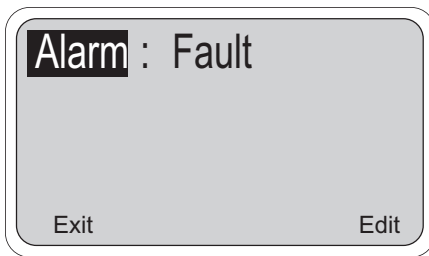

9. Alarm 4 setup:

Alarm 4 is a dedicated fault alarm. When a fault condition exists, the red LED on the front display will light.

- From the menu header screen (step 6) move the cursor to "Alarm 4 setup."
- To disable the alarm, press Edit (F4) and use the \uparrow key to change the "Fault" to "Off"

10. Feed limit timer setup:

Alarm 1, 2, or 3 can be configured as a feed limit timer. The feed limit timer prevents overfeeding of treatment chemicals by automatically turning off the relay after a timeout period.

- From the menu header screen (step 6) move the cursor to "Feed limit timer." Press Enter (F4).
- With the cursor on "Feed limit" press Edit. Use the \uparrow key to scroll through the choices: disable, AL 1, AL 2, and AL 3. Press Save (F4) to store the selection.
- Move the cursor to "Timeout". Press Edit (F4) and use the arrow keys to change the timeout to the desired value. Press Save (F4) to store the setting.

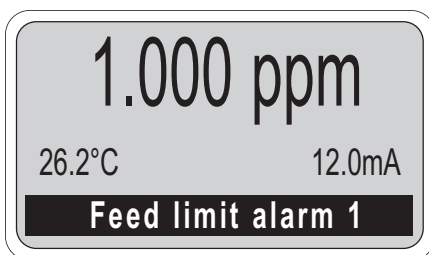
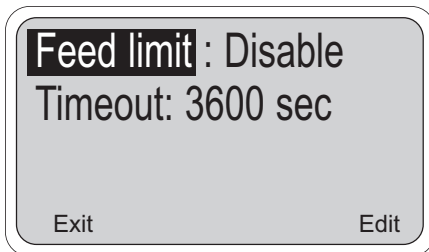

Operation of the feed limit timer. When a feed limit alarm has timed out, "Feed limit alarm 1" (if alarm 1 was chosen) appears in the display. At the same time the red FAIL LED will light and alarm 4 will close (if not turned off), and the selected feed limit relay (alarm 1) will open (de-energize). All other alarms and current outputs will remain unchanged. The relays remain in the state described until the Ack (F2) key is pressed, at which time the controller returns to normal operation and the feed limit clock starts again.

NOTE

Pressing Ack (F2) acknowledges all conditions that turn on the red LED. If another event occurs after F2 is pressed, F2 must be pressed again to acknowledge the new event.

5.7 CHANGING ALARM PARAMETERS (continued)

11. Interval timer setup:

Alarm 1, 2, or 3 can be used as an interval timer. The selected relay will open and close at time intervals programmed by the user. The interval timer is useful for automatic cleaning of sensors.

NOTE

The alarm relay used for the interval timer cannot be used for other purposes. When a timer sequence is occurring, both current outputs are placed in hold (even if hold was not enabled) and the other two alarms will be placed in their default states.

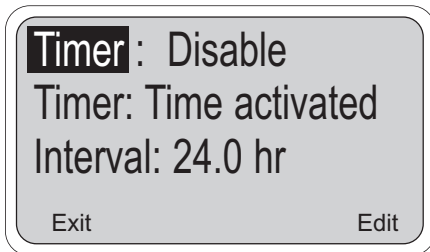
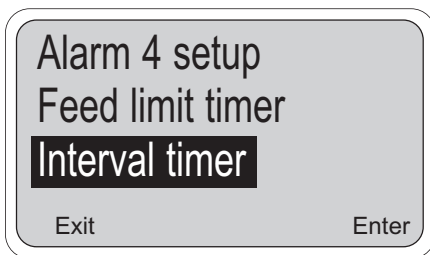

- a. From the menu header screen (step 6) move the cursor to "Interval timer."

- b. With the cursor on "Interval timer", press Enter (F4). Use the ↓ key to scroll through the selections. Use the arrow keys to change settings. Press Save (F4) to store.

Refer to the diagram for definition of terms: **interval**, **repeats**, **on time**, **off time**, and **recovery**.

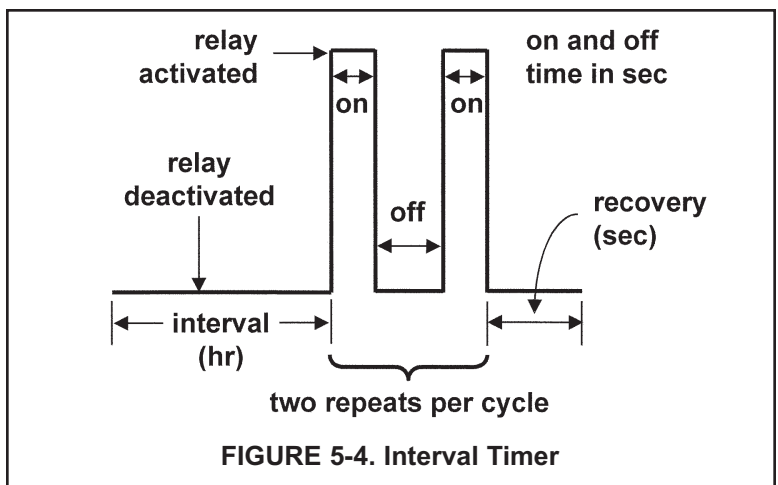

5.8 CONFIGURING THE pH MEASUREMENT

NOTE

pH is available only if the Model 54eA controller was configured to measure free chlorine.

1. Press any key to enter the main menu. Move the cursor to "Program" and press Enter (F4).
2. Move the cursor to "Configure" and press Enter (F4).
3. Move the cursor to "pH" and press Enter (F4).

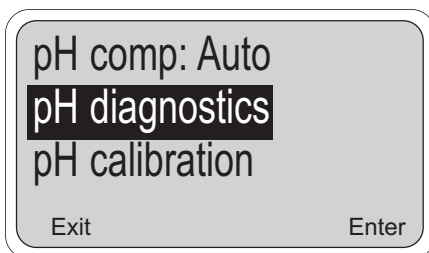
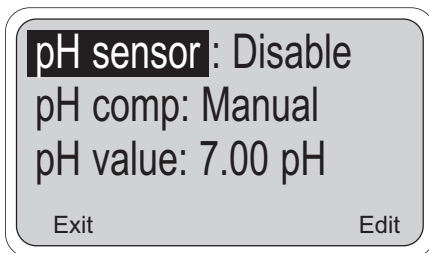
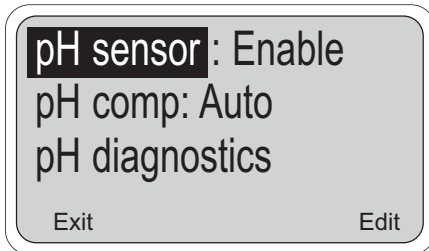
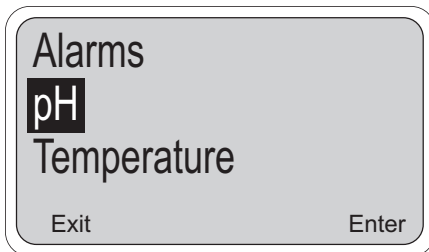

4. The default settings are "pH sensor: Enable" and "pH comp: Auto." Keeping these settings permits the controller to continuously correct raw chlorine readings for pH changes. Go to step 6.

If continuous pH correction is not required, the controller must be configured for manual pH correction. Go to step 5.

5. For manual pH correction, press Edit (F4).
 - a. Use the **↑** key to change "Enable" to "Disable" and press Save (F4).
 - b. The screen at left appears. Use the **↓** key to move the cursor to "pH value." Press Edit (F4). Use the arrow keys to change the pH value to the desired number. The controller will use the value entered in **ALL** pH correction calculations no matter what the true pH is.
6. This screen appears if automatic pH correction for chlorine readings is being used. To enable diagnostic fault alarms and warning messages and to change pH diagnostic warning limits...
 - a. Move the cursor to "pH diagnostics" and press Enter (F4).

5.8 CONFIGURING THE pH MEASUREMENT (continued)

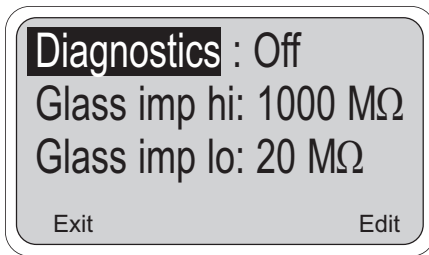

- b. Move the cursor to "Diagnostics". Press Edit (F4) and use the ↑ key to change "Off" to "On". Press Save (F4).

NOTE

Choosing "On" means the controller will display pH diagnostic warning messages and fault alarms. Choosing "Off" means the messages and fault alarms will not be displayed. Diagnostic variables will still be measured and can be viewed under the Diagnostics menu.

- c. Use the ↑ and ↓ keys to move through the list of diagnostic measurements. To change a warning limit, press Edit (F4). Use the arrow keys to change the setting and press Save (F4) to store the change. For allowed ranges, see Table 5-1. Setting the limit to 0 disables the warning limit.

Glass imp hi: High glass impedance implies that the sensor may be nearing the end of its useful life. Set the warning limit about two times higher than the impedance of a new electrode. A typical glass electrode has an impedance of about 150 MΩ at 25°C.

Glass imp lo: Low glass impedance warns of a broken electrode. A good setting is 20 MΩ.

Zero offset: pH measuring cells are designed to have a potential of 0 mV in pH 7 buffer. Zero offset is a measure of how far the true value is from 0.0 mV. Zero offset is calculated every time the sensor is calibrated. A good limit is 60 mV.

Imped comp: The impedance of a glass electrode is a strong function of temperature. For accurate comparison of impedances, readings must be temperature corrected. For best results, leave "Imped comp" on.

- d. Press Exit (F4) to return to the screen in step 6a.

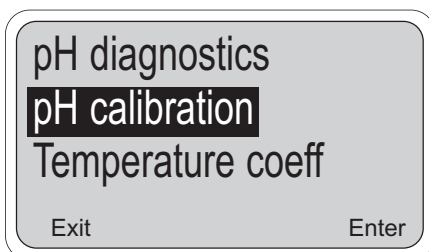

7. To change calibration parameters...

- a. Move the cursor to pH calibration and press Enter (F4).



- b. Use the ↑ and ↓ keys to move through the list of items. To make a change press Edit (F4). Use the arrow keys to the setting to the desired value and press Save (F4). For allowed ranges see Table 5-1.

Autocal: To disable automatic calibration, choose "Manual". The other choices in the list ("Standard", "Merck", "Ingold", and "DIN 19267") refer to standard and technical buffers. Refer to the table in Section 11.0 for a list of the standard buffers. Merck buffers are pH 2.00, 7.00, 9.00 and 12.00. Ingold buffers are 2.00, 4.01, 7.00, and 9.21. DIN 19267 are 1.09, 3.06, 4.65, 6.79, 9.23, and 12.75.

5.8 CONFIGURING THE pH MEASUREMENT (continued)

Stabilize pH and Stabilize time: For the controller to accept calibration data, the pH must remain within a specified range for a specified period of time. The default values are 0.01 pH for 10 seconds. Using a small pH value and a large time provides the best protection against calibration while the reading is still changing.

8. In many industries pH is used and reported at a reference temperature of 25°C. Correcting a pH reading to 25°C is often referred to as a solution temperature correction. To perform the correction, the solution temperature coefficient must be known.

a. With the cursor on "Temperature coeff", press Enter (F4).

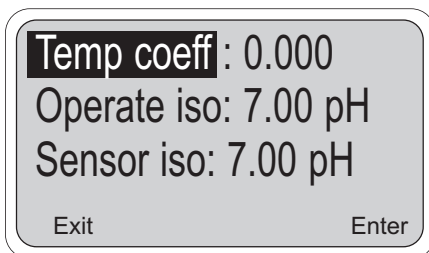
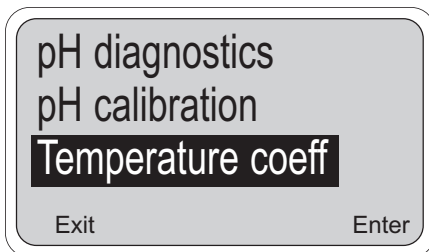

- b. Use the \uparrow and \downarrow keys to move through the list of items. To make a change press Edit (F4). Use the arrow keys to change the setting to the desired value and press Save (F4). For allowed ranges see Table 5-1.

Temp coeff: Enter the temperature coefficient in units of $\Delta\text{pH}/^\circ\text{C}$. If the pH decreases as temperature increases, the temperature coefficient is negative. The temperature coefficient must usually be determined empirically.

APPLICATION WARNING

If pH is being measured for the purposes of correcting a free chlorine reading, do NOT use solution temperature correction. Keep the temperature coefficient at 0.000 pH/°C.

Operate iso: Entering a temperature coefficient ALWAYS causes the operating isopotential to change from the normal value of 7.00. When programming the controller to perform solution temperature compensation, ALWAYS enter the solution temperature coefficient and allow the transmitter to calculate the operating isopotential pH.

Sensor iso: The isopotential pH is the pH at which the cell voltage is independent of temperature. Most sensors have an isopotential pH fairly close to 7.0, so the default value is 7.00. Certain specialized pH electrodes have isopotential pH significantly different from 7.0.

NOTE

Do NOT change the isopotential pH of the controller unless you are thoroughly familiar with the role of isopotential points in pH measurements OR the sensor operating instructions specifically state the isopotential pH is a value other than pH 7.

5.9 TEMPERATURE COMPENSATION AND TEMPERATURE UNITS

1. Refer to Section 6.1 for a discussion of the ways in which temperature affects amperometric and pH measurements.
2. Press any key to enter the main menu. Move the cursor to "Program" and press Enter (F4).
3. Move the cursor to "Configure" and press Enter (F4).
4. Move the cursor to "Temperature" and press Enter (F4).

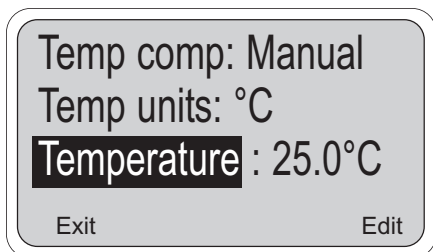
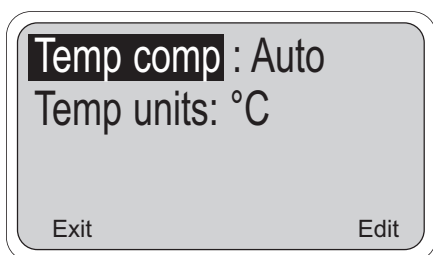
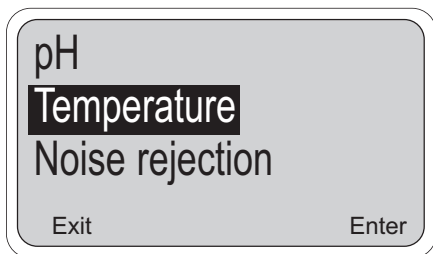

5. Use the \uparrow and \downarrow keys to move through the list of items. To make a change press Edit (F4). Use the arrow keys to change settings to the desired value. Press Save (F4) to store changes.

Auto: In automatic temperature compensation, the controller measures the temperature using an RTD (resistance temperature device) or 22kNTC thermistor in the sensor. The controller then uses the measured temperature to calculate membrane permeability corrections, solubility factors (for oxygen only), and the millivolt to pH conversion factor (for pH-corrected free chlorine only).

Manual: In manual temperature compensation, the controller uses the temperature entered by the user to calculate membrane permeability corrections, solubility factors (for oxygen only), and the millivolt to pH conversion factor. It does **NOT** use the actual process temperature. Do **NOT** use manual temperature compensation unless the difference between the calibration and measurement temperatures is less than 2°C.

Manual temperature compensation is useful if the sensor RTD has failed and a replacement sensor is not available.

If Manual temperature compensation is selected, be sure to enter the desired temperature.

5.10 NOISE REDUCTION

1. For maximum noise reduction the frequency of the ac power must be entered into the analyzer.
2. Press any key to enter the main menu. Move the cursor to "Program" and press Enter (F4).
3. Move the cursor to "Configure" and press Enter (F4).
4. Move the cursor to "Noise rejection" and press Enter (F4).

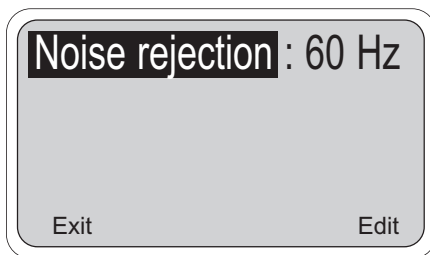
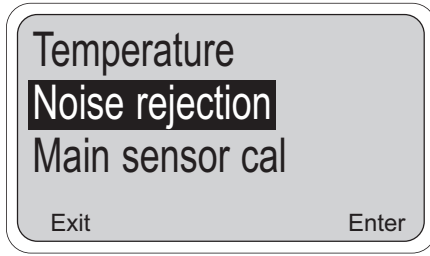

5. To change the frequency setting, press Edit (F4). Use the **↑** key to toggle between 50 and 60 Hz. Press Save (F4) to store the change.

5.11 MAIN SENSOR CALIBRATION PARAMETERS

1. Main sensor refers to the amperometric sensor.
2. Press any key to enter the main menu. Move the cursor to "Program" and press Enter (F4).
3. Move the cursor to "Configure" and press Enter (F4).
4. Move the cursor to "Main sensor cal" and press Enter (F4).
5. Use the \uparrow and \downarrow keys to move through the list of items. To make a change press Edit (F4). Use the arrow keys to change settings to the desired value and press Save (F4). For allowed ranges, see Table 5-1.

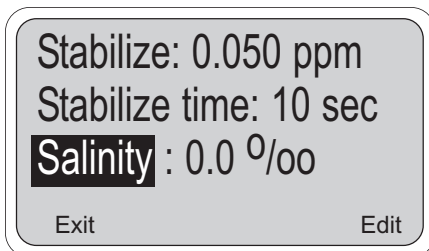
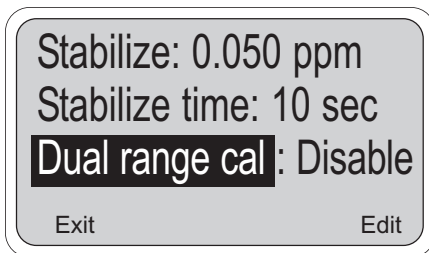
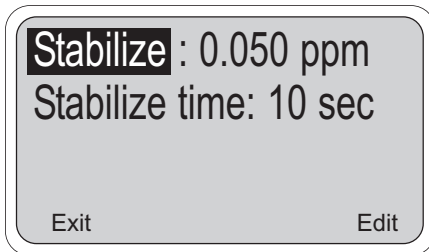

The choices depend on the measurement being made.

Stabilize and Stabilize time: For the controller to accept calibration data, the concentration must remain within a specified range for a specified period of time. The default values are 0.05 ppm (50 ppb) and 10 seconds. Using a small stabilize value and a long stabilize time is the best protection against calibration while a reading is still changing.

Dual range cal: Free and total chlorine sensors from Rosemount Analytical (Model 499ACL-01 and 499ACL-02, respectively) become non-linear at high concentrations of chlorine. Dual range calibration allows the analyzer to correct for the non-linearity of the sensor. For more information see Sections 8.0 and 9.0.

Salinity: Salinity is used with oxygen measurements only. The solubility of oxygen in water depends on the concentration of dissolved salts in the water. Increasing the concentration decreases the solubility. If the salt concentration is greater than about 1000 ppm, the accuracy of the measurement can be improved by applying a salinity correction. Enter the salinity as parts per thousand (‰). One percent is ten parts per thousand.

5.12 BAROMETRIC PRESSURE

1. The barometric pressure menu header appears only if an oxygen sensor (ppm or ppb level) is being used. Barometric pressure is used during air calibration.
 2. Press any key to enter the main menu. Move the cursor to "Program" and press Enter (F4).
 3. Move the cursor to "Configure" and press Enter (F4).
 4. Move the cursor to "Barometric pressure" and press Enter (F4).

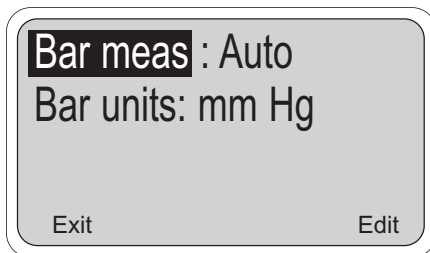
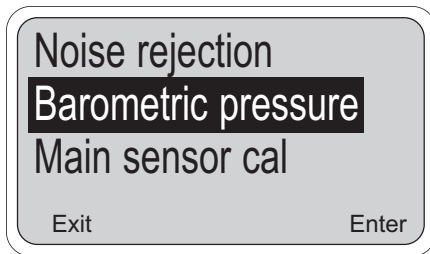

5. Use the ↑ and ↓ keys to move through the list of items. To make a change, press Edit (F4). Use the arrow keys to change settings to the desired value and press Save (F4).

Bar meas: The controller has an on-board sensor that automatically measures barometric pressure. To bypass the pressure sensor, select "Manual". Be sure to enter the desired pressure in the third line. During air calibration, the controller will use the barometric pressure entered in this step no matter what the true pressure is.

Bar units: Select the units in which barometric pressure will be displayed.

5.13 SECURITY

- The controller can be programmed to require a password for access to menus. There are three levels:

Level 1: A level 1 user can

- Zero and calibrate the main (amperometric) sensor
- Calibrate the barometric pressure sensor
- Calibrate the pH sensor
- Enter a temperature slope for a pH sensor
- Change temperature compensation from automatic to manual and enter a manual compensation temperature
- View diagnostic variables.

Level 2: A level 2 user can

- Do everything a level 1 user can do
- Change control setpoints for PID current outputs
- Change alarm setpoints for normal and TPC alarms
- Rerange the 4-20 mA outputs
- Manually test both outputs and all four alarm relays.

Level 3: A level 3 user has access to every menu item. Only a level 3 user can change passwords.

A person with no password can only view the main display.

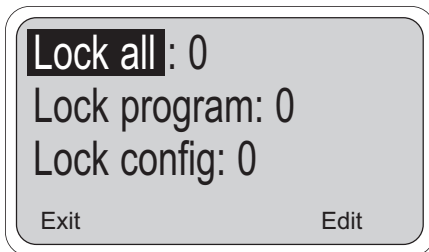

- Press any key to enter the main menu. Move the cursor to "Program" and press Enter (F4).
- Move the cursor to "Configure" and press Enter (F4).
- Move the cursor to "Security" and press Enter (F4).
- Use the \uparrow and \downarrow keys to move through the list of items. To enter a password, press Edit (F4). Use the arrow keys to enter a three-digit password. Press Save (F4) to store the value.

Lock all: Until the user enters the "lock all" password, all he can do is view the main display. Entering the "lock all" password allows the user access to all Level 1 functions.

Lock program: Entering the "lock program" password allows the user access to all Level 2 functions.

Lock config: Entering the "lock config" password allows the user access to all Level 3 functions.

The controller will accept a higher level security code at a lower level security gate. For example, the controller will accept a level 2 password at a level 1 gate.

NOTES:

- A code of 000 disables security for that level.
- The security feature will not activate until after the timeout period has passed with no key presses.
- A hold condition will indefinitely prolong the timeout period.
- Security will activate immediately if power is removed and then restored.
- To recall a forgotten code, press and hold F4 for five seconds when the security screen appears. The code for that level will appear.

5.14 CONTROLLER MODE PRIORITY

The Model 54eA controller can function in different modes depending on both how it is configured, what process conditions exist, and actions an operator may have made. To reconcile these possible modes, there is a set priority that determines exactly what will happen to the two (2) current outputs and the four (4) alarm relays in the event of multiple modes occurring at the same time. See Table 5-2 below.

Priority is in the following order (from lowest to highest): normal, fault, timer, hold, feed limit, test. Each output or relay acts as if it is only in the state of highest priority.

NOTE

Some of these features may not be in use in the controller.

TABLE 5-2. Controller Mode Priority Chart

Condition	Priority	Current Output 1	Current Output 2	Alarm Relay 1	Alarm Relay 2	Alarm Relay 3	Alarm Relay 4
Normal	1	Normal	Normal	Normal	Normal	Normal	Open
Fault	2	Default	Default	Default	Default	Default	Closed
Interval Timer	3	Hold	Hold	Default/ Normal ¹	Default/ Normal ¹	Default/ Normal ¹	Prior
Hold Mode	4	Hold	Hold	Default	Default	Default	Prior
Feed Limit	5	Normal	Normal	Open ¹	Open ¹	Open ¹	Closed
Simulate tests	6	Test ¹	Test ¹	Test ¹	Test ¹	Test ¹	Test ¹

¹ Indicates the state **IF** that item has been configured or selected (i.e. if it is an interval timer or a feed limit timer or it is the one being tested). Unconfigured or unselected items are not affected by that mode.

Condition Definitions:

1. Normal refers to conditions when no other mode is present.
2. Fault means the instrument has diagnosed a fault condition. A fault message is displayed and the red LED is on.
3. Interval Timer means the timer sequence is occurring.
4. Hold Mode occurs when hold is activated by the operator (i.e. during calibration).
5. Feed Limit occurs when a feed limit timer has reached its limit and is turned off after being on for too long.
6. Simulate tests are described in Section 5.4.

Action Definitions:

1. Normal is determined by process conditions or how the item has been configured (Section 5.6)
2. Open is a deenergized alarm relay (alarm off).
3. Default is the setting configured for each item if there is a fault. (Section 5.6)
4. Closed is an energized alarm relay (alarm on).
5. Hold is the setting for the current output configured in Section 5.5 (fixed mA value or the last normal value).
6. Prior is the state the alarm had before that mode occurred.
7. Test is the value input by the operator (mA for current, on or off for a relay).

SECTION 6.0

CALIBRATION - TEMPERATURE

6.1 INTRODUCTION

All four amperometric sensors (oxygen, ozone, free chlorine, total chlorine, and monochloramine) are membrane-covered sensors. As the sensor operates, the analyte (the substance to be determined) diffuses through the membrane and is consumed at an electrode immediately behind the membrane. The reaction produces a current that depends on the rate at which the analyte diffuses through the membrane. The diffusion rate, in turn, depends on the concentration of the analyte and how easily it passes through the membrane (the membrane permeability). Because the membrane permeability is a function of temperature, the sensor current will change if the temperature changes. To correct for changes in sensor current caused by temperature, the controller automatically applies a membrane permeability correction. Although the membrane permeability is different for each sensor, the change is about 3%/°C at 25°C, so a 1°C error in temperature produces about a 3% error in the reading.

Temperature plays an additional role in oxygen measurements. Oxygen sensors are calibrated by exposing them to water-saturated air, which, from the point of view of the sensor, is equivalent to water saturated with atmospheric oxygen (see Section 7.0 for more information). During calibration, the controller calculates the solubility of atmospheric oxygen in water using the following steps. First, the controller measures the temperature. From the temperature, the controller calculates the vapor pressure of water and, using the barometric pressure, calculates the partial pressure of atmospheric oxygen. Once the controller knows the partial pressure, it calculates the equilibrium solubility of oxygen in water using a temperature-dependent factor called the Bunsen coefficient. Overall, a 1°C error in the temperature measurement produces about a 2% error in the solubility calculated during calibration and about the same error in subsequent measurements.

Temperature is also important in the pH measurement required to correct free chlorine readings.

1. The controller uses a temperature dependent factor to convert measured cell voltage to pH. Normally, a slight inaccuracy in the temperature reading is unimportant unless the pH reading is significantly different from 7.00. Even then, the error is small. For example, at pH 12 and 25°C, a 1°C error produces a pH error less than ± 0.02 .
2. During auto calibration, the controller recognizes the buffer being used and calculates the actual pH of the buffer at the measured temperature. Because the pH of most buffers changes only slightly with temperature, reasonable errors in temperature do not produce large errors in the buffer pH. For example, a 1°C error causes **at most** an error of ± 0.03 in the calculated buffer pH.

Without calibration the accuracy of the temperature measurement is about $\pm 0.4^\circ\text{C}$. Calibrate the controller if

1. $\pm 0.4^\circ\text{C}$ accuracy is not acceptable
2. the temperature measurement is suspected of being in error. Calibrate temperature by making the controller reading match the temperature measured with a standard thermometer.

6.2 TEMPERATURE CALIBRATION

Place the sensor and a standard thermometer in the process liquid.

1. Check the controller temperature reading (main display) to make sure the sensor has stabilized. Compare the controller temperature with the standard thermometer. The readings should differ by at most 1°C. If the readings differ by a greater amount, refer to Section 15.3. Go to the next step if the reading requires adjustment.
2. From the main display, press any key. With the cursor on "Calibrate," press Enter (F4).

NOTE

If Hold was enabled in Section 5.6, the hold screen will appear. To activate hold, refer to Section 5.6, step 11.

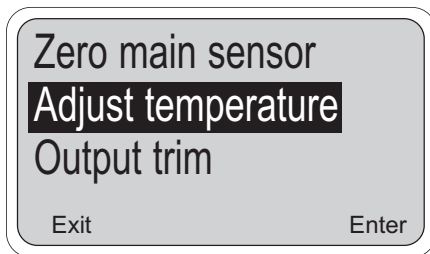

3. Press the ↓ key twice to move the cursor to "Adjust temperature," then press Enter (F4).

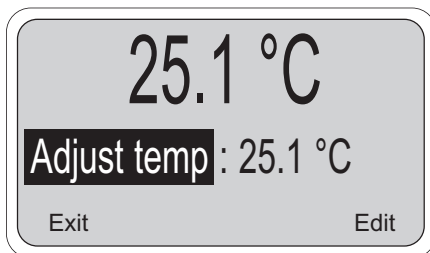

4. Press Edit (F4) to adjust the temperature. The screen below will then appear. Using the arrow keys, enter the correct temperature and press Save (F4). The controller will enter the value in memory. To abort the change, press Esc (F3). Press Exit (F1) three times for the main display.

NOTE

If Hold was activated during calibration, "Hold Mode Activated" will continue to flash in the main display. Return the sensor to normal and deactivate Hold. Refer to Section 5.6, step 11.

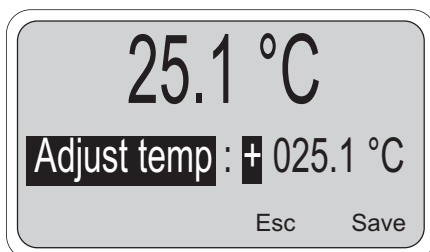

SECTION 7.0

CALIBRATION - DISSOLVED OXYGEN

7.1 INTRODUCTION

As Figure 7-1 shows, oxygen sensors generate a current directly proportional to the concentration of dissolved oxygen in the sample. Calibrating the sensor requires exposing it to a solution containing no oxygen (zero standard) and to a solution containing a known amount of oxygen (full-scale standard).

The zero standard is necessary because oxygen sensors, even when no oxygen is present in the sample, generate a small current called the residual current. The analyzer compensates for the residual current by subtracting it from the measured current before converting the result to a dissolved oxygen value. New sensors require zeroing before being placed in service, and sensors should be zeroed whenever the electrolyte solution is replaced. The recommended zero standard is 5% sodium sulfite in water, although oxygen-free nitrogen can also be used.

The Model 499A TrDO sensor, used for the determination of trace (ppb) oxygen levels, has very low residual current and does not normally require zeroing. The residual current in the 499A TrDO sensor is equivalent to less than 0.5 ppb oxygen.

The purpose of the full-scale standard is to establish the slope of the calibration curve. Because the solubility of atmospheric oxygen in water as a function of temperature and barometric pressure is well known, the natural choice for a full-scale standard is air-saturated water. However, air-saturated water is difficult to prepare and use, so the universal practice is to use air for calibration. From the point of view of the oxygen sensor, air and air-saturated water are identical. The equivalence comes about because the sensor really measures the chemical potential of oxygen. Chemical potential is the force that causes oxygen molecules to diffuse from the sample into the sensor where they can be measured. It is also the force that causes oxygen molecules in air to dissolve in water and to continue to dissolve until the water is saturated with oxygen. Once the water is saturated, the chemical potential of oxygen in the two phases (air and water) is the same.

Oxygen sensors generate a current directly proportional to the rate at which oxygen molecules diffuse through a membrane stretched over the end of the sensor. The diffusion rate depends on the difference in chemical potential between oxygen in the sensor and oxygen in the sample. An electrochemical reaction, which destroys any oxygen molecules entering the sensor, keeps the concentration (and the chemical potential) of oxygen inside the sensor equal to zero. Therefore, the chemical potential of oxygen in the sample alone determines the diffusion rate and the sensor current.

When the sensor is calibrated, the chemical potential of oxygen in the standard determines the sensor current. Whether the sensor is calibrated in air or air-saturated water is immaterial. The chemical potential of oxygen is the same in either phase. Normally, to make the calculation of solubility in common units (like ppm DO) simpler, it is convenient to use water-saturated air for calibration.

Automatic air calibration is standard. The user simply exposes the sensor to water-saturated air. The controller monitors the sensor current. When the current is stable, the controller stores the current and measures the barometric pressure and temperature. The temperature element is part of the dissolved oxygen sensor. The pressure sensor is inside the analyzer. From the temperature, the controller calculates the saturation vapor pressure of water. Next, it calculates the pressure of dry air by subtracting the vapor pressure from the barometric pressure. Using the fact that dry air always contains 20.95% oxygen, the analyzer calculates the partial pressure of oxygen. Once the analyzer knows the partial pressure of oxygen, it uses the Bunsen coefficient to calculate the equilibrium solubility of atmospheric oxygen in water at the prevailing temperature. At 25°C and 760 mm Hg, the equilibrium solubility is 8.24 ppm.

Often it is too difficult or messy to remove the sensor from the process liquid for calibration. In this case, the sensor can be calibrated against a measurement made with a portable laboratory instrument. The laboratory instrument typically uses a membrane-covered amperometric sensor that has been calibrated against water-saturated air.

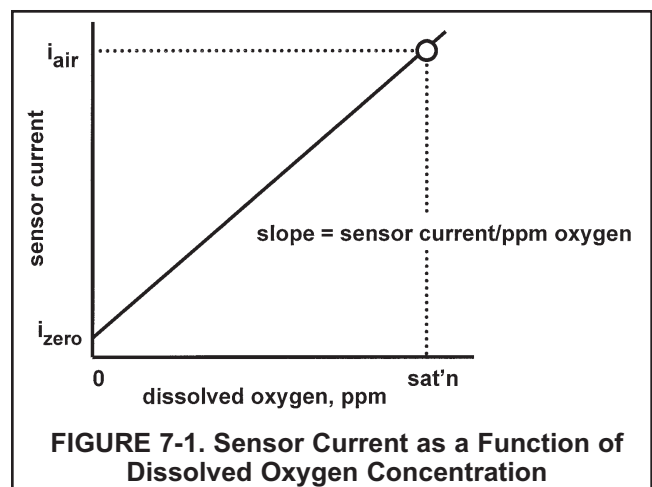

7.2 ZEROING THE SENSOR

- Place the sensor in a **fresh** solution of 5% sodium sulfite (Na_2SO_3) in water. Be sure air bubbles are not trapped against the membrane. The current will drop rapidly at first and then gradually reach a stable zero value. To monitor the sensor current, go to the main display. Press any key to obtain the main menu. Press the \downarrow key once to highlight "Diagnostic variables." Press Enter (F4). The sensor current is the second item in the display. Note the units: nA is nanoamps, μA is microamps. To return to the main display, press exit (F1) twice. The table gives typical zero currents for Rosemount Analytical sensors.

Sensor	Zero current (nA)
499ADO	<50 nA
499A TrDO	<5 nA
Hx438 and Gx448	<1 nA

The Model 499A TrDO does not normally require zeroing.

A new sensor or a sensor in which the electrolyte solution has been replaced may require several hours (occasionally as long as overnight) to reach a minimum current. **DO NOT START THE ZERO ROUTINE UNTIL THE SENSOR HAS BEEN IN ZERO SOLUTION FOR AT LEAST TWO HOURS.**

- From the main display, press any key to obtain the main menu. With the cursor on "Calibrate," press Enter (F4).

NOTE

If Hold was enabled in Section 5.6, the hold screen will appear. To activate hold, refer to Section 5.6, step 11.

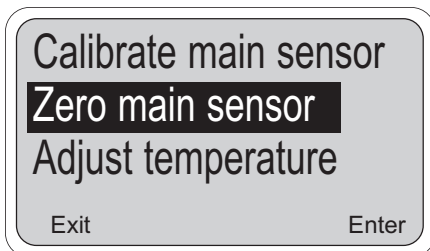

- Press the \downarrow key once to move the cursor to "Zero main sensor." Press Enter (F4).

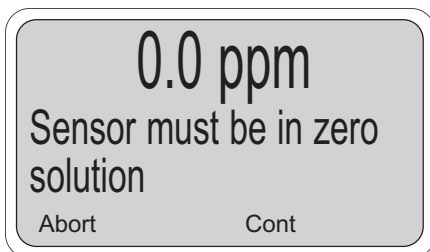

- The screen at left appears. Press Cont (F3). "Wait" flashes until the sensor is stabilized. Once the zero step is complete, the message "Sensor zero done" appears.

- Press Exit (F1) three times to return to the main display.

NOTE

If Hold was activated during calibration, "Hold Mode Activated" will continue to flash in the main display. Return the sensor to normal and deactivate Hold. Refer to Section 5.6, step 11.

NOTE

During calibration, ERROR and WARNING messages may appear. If an ERROR message appears, press Exit (F1) to leave and return to the previous screen. If a WARNING message appears, press Cont (F3) to continue the calibration or press Abort (F1) to leave. Continuing the calibration after a warning message appears may cause substantial errors in the subsequent measurement. Refer to Section 15.4 for assistance.

7.3 CALIBRATING THE SENSOR IN AIR

1. Remove the sensor from the process liquid. Use a soft tissue and a stream of water from a wash bottle to clean the membrane. Blot dry. **The membrane must be dry during air calibration.**
2. Pour some water in a beaker and suspend the sensor with the membrane about 0.5 inch (1 cm) above the water surface. To avoid drift caused by temperature changes, keep the sensor out of the direct sun.
3. Monitor the dissolved oxygen reading and the temperature. Once readings have stopped drifting, begin the calibration. It may take 5 - 10 minutes for the sensor reading in air to stabilize. Stabilization time may be even longer if the process temperature is appreciably different from the air temperature. For an accurate calibration, temperature measured by the sensor must be stable.

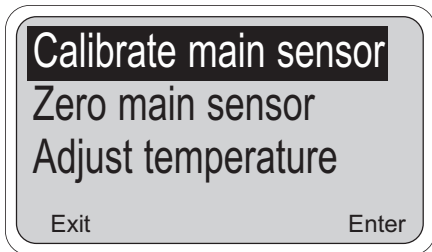

4. From the main display, press any key to obtain the main menu. With the cursor on "Calibrate," press Enter (F4).

NOTE

If Hold was enabled in Section 5.6, the hold screen will appear. To activate hold, refer to Section 5.6, step 11.

Press Enter (F4). The screen shown in step 5 appears.



5. Press Enter (F4) to select "Calibrate in air."

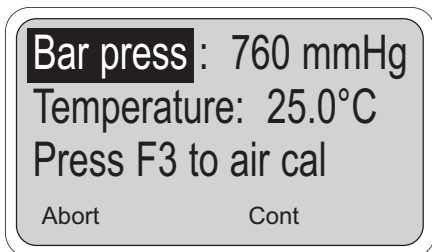

6. This screen shows the barometric pressure and temperature that will be used for the calibration. If the barometric pressure or temperature is incorrect, press Abort (F1). Refer to Section 7.5 for the pressure calibration procedure. Refer to Section 6.2 for the temperature calibration procedure.

NOTE

The barometric pressure sensor is inside the controller enclosure. When cable glands are in place and the front panel is tightly closed, the enclosure is moderately airtight. Therefore, as the controller heats or cools, the pressure of the air trapped inside the enclosure may be different from ambient. Opening the front panel will equalize the pressure.



7. Press Cont (F3). "Wait" flashes until the sensor is stabilized. Once air calibration is complete, the message "Air calibration done" appears. The display will show the equilibrium solubility of atmospheric oxygen in water at the prevailing temperature and pressure.

procedure continued on next page . . .

8. Press Exit (F1) four times to return to the main display.

NOTE

If Hold was activated during calibration, "Hold Mode Activated" will continue to flash in the main display. Return the sensor to normal and deactivate Hold. Refer to Section 5.6, step 11.

9. During calibration, the analyzer stores the measured current and calculates the sensitivity. Sensitivity is the sensor current in nA divided by the saturation concentration of oxygen in ppm. The table gives typical sensitivity for Rosemount Analytical dissolved oxygen sensors.

Sensor	Current in air at 25°C	Sensitivity (nA/ppm)
499ADO	15-25 μ A	1,800-3,100
499A Tr DO	30-50 μ A	3,600-6,100
Hx438 and Gx448	40-80 nA	4.8-9.8

To view the sensitivity from the main display, press any key to enter the main menu. Press the \blacktriangledown key once. Then press Enter (F4) to display the diagnostic variables. The sensitivity is the third line on the screen. Note the units: nA is nanoamps, μ A is microamps.

NOTE

During calibration, ERROR and WARNING messages may appear. If an ERROR message appears, press Exit (F1) to leave and return to the previous screen. If a WARNING message appears, press Cont (F3) to continue the calibration or press Abort (F1) to leave. Continuing the calibration after a warning message appears may cause substantial errors in the subsequent measurement. Refer to Section 15.4 for assistance.

7.4 CALIBRATING THE SENSOR AGAINST A STANDARD INSTRUMENT

The analyzer and sensor can be calibrated against a standard instrument. For oxygen sensors installed in aeration basins in waste treatment plants, calibration against a second instrument is often preferred. For an accurate calibration be sure that...

1. The standard instrument has been zeroed and calibrated against water-saturated air following the manufacturer's instructions.
2. The standard sensor is immersed in the liquid as close to the process sensor as possible.
3. Adequate time is allowed for the standard sensor to stabilize before calibrating the process instrument.

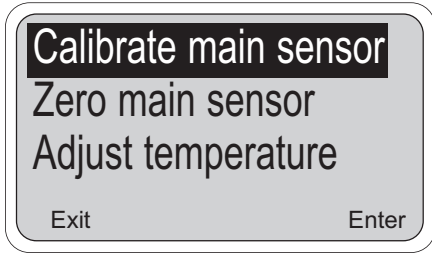

4. From the main display, press any key to obtain the main menu. With the cursor on "Calibrate," press Enter (F4).

NOTE

If Hold was enabled in Section 5.6, the hold screen will appear. To activate hold, refer to Section 5.6, step 11.

Press Enter (F4).



5. The screen at left appears. Press the ↓ key once to move the cursor to "Calibrate in process." Then, press Enter (F4).

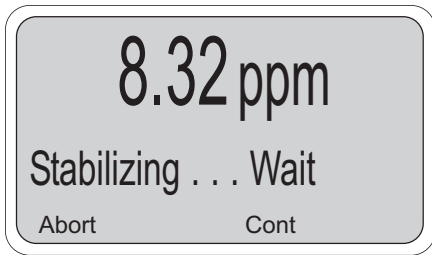

6. Press Cont (F3). "Wait" flashes until the sensor is stabilized.

If the controller appears locked, the reading is not stable enough. Increase the amount the concentration is permitted to vary or decrease the stabilization time. See Section 5.11. Repeat the calibration. To proceed with the calibration as is, press Cont (F3).

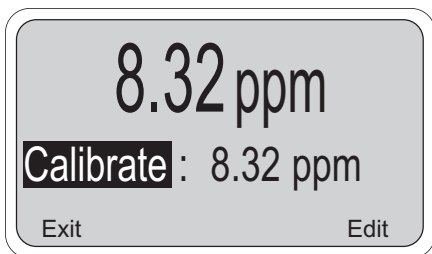

7. Once the reading is stable, the screen at left appears. Press Edit (F4). Use the arrow keys to change the concentration in the second line of the display to the desired value. Press Save (F4) to store the value.

8. Press Exit (F1) four times to return to the main display.

NOTE

If Hold was activated during calibration, "Hold Mode Activated" will continue to flash in the main display. Return the sensor to normal and deactivate Hold. Refer to Section 5.6, step 11.

7.5 CALIBRATING BAROMETRIC PRESSURE

1. If the barometric pressure measured by the controller does not agree with the local barometric pressure, calibrate the pressure sensor. A pressure error of 3 mm Hg introduces an error of about 0.5% in the final measurement. When calibrating the pressure reading, be sure to use the actual barometric pressure. Weather forecasters and airports usually report barometric pressure corrected to sea level; they do not report the actual pressure. It is good practice to open the enclosure door before starting a barometric pressure calibration. When gland fittings are used, the controller enclosure is moderately airtight. As the controller enclosure heats or cools, the pressure of the air trapped inside the enclosure may be as much as 5% different from ambient pressure.

2. From the main display, press any key. With the cursor on "Calibrate," press Enter (F4).

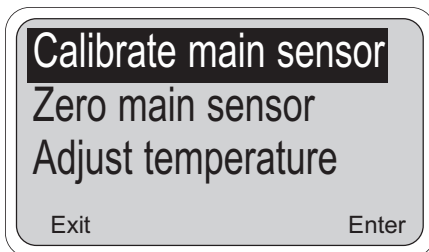

3. Press Enter (F4) to select "Calibrate main sensor."



4. Press the ↓ key twice to move the cursor to "Barometric pressure." Press Enter (F4).

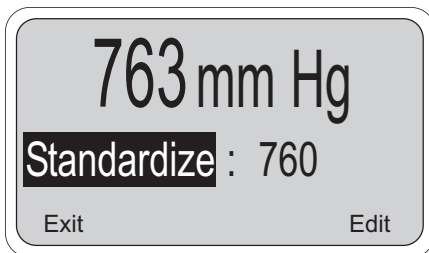

5. Press Edit (F4). Use the arrow keys to change the pressure reading to the desired value. Press Save (F4) to store the value.

6. Press Exit (F1) four times to return to the main display.

SECTION 8.0

CALIBRATION - FREE CHLORINE

8.1 INTRODUCTION

As Figure 8-1 shows, a free chlorine sensor generates a current directly proportional to the concentration of free chlorine in the sample. Calibrating the sensor requires exposing it to a solution containing no chlorine (zero standard) and to a solution containing a known amount of chlorine (full-scale standard).

The zero standard is necessary because chlorine sensors, even when no chlorine is in the sample, generate a small current called the residual current. The controller compensates for the residual current by subtracting it from the measured current before converting the result to a chlorine value. New sensors require zeroing before being placed in service, and sensors should be zeroed whenever the electrolyte solution is replaced. Either of the following makes a good zero standard:

- Deionized water containing about 500 ppm sodium chloride. Dissolve 0.5 grams (1/8 teaspoonful) of table salt in 1 liter of water. **DO NOT USE DEIONIZED WATER ALONE FOR ZEROING THE SENSOR. THE CONDUCTIVITY OF THE ZERO WATER MUST BE GREATER THAN 50 μ S/cm.**
- Tap water known to contain no chlorine. Expose tap water to bright sunlight for at least 24 hours.

The purpose of the full-scale standard is to establish the slope of the calibration curve. Because stable chlorine standards do not exist, **the sensor must be calibrated against a test run on a grab sample of the process liquid.** Several manufacturers offer portable test kits for this purpose. Observe the following precautions when taking and testing the grab sample.

- Take the grab sample from a point as close to the sensor as possible. Be sure that taking the sample does not alter the flow of the sample to the sensor. It is best to install the sample tap just downstream from the sensor.
- Chlorine solutions are unstable. Run the test immediately after taking the sample. Try to calibrate the sensor when the chlorine concentration is at the upper end of the normal operating range.

Free chlorine measurements made with the 499ACL-01 sensor also require a pH correction. Free chlorine is the sum of hypochlorous acid (HOCl) and hypochlorite ion (OCl⁻). The relative amount of each depends on the pH. As pH increases, the concentration of HOCl decreases and the concentration of OCl⁻ increases. Because the sensor responds only to HOCl, a pH correction is necessary to properly convert the sensor current into a free chlorine reading.

The controller uses both automatic and manual pH correction. In automatic pH correction, the controller continuously monitors the pH of the solution and corrects the free chlorine reading for changes in pH. In manual pH correction, the controller uses a fixed pH value entered by the user to make the correction. Generally, if the pH changes more than about 0.2 units over short periods of time, automatic pH correction is best. If the pH is relatively steady or subject only to seasonal changes, manual pH correction is adequate.

During calibration, the controller must know the pH of the sample. If the controller is using automatic pH correction, the pH sensor (properly calibrated) **must be in the process liquid before starting the calibration.** If the controller is using manual pH correction, be sure to enter the pH value before starting the calibration.

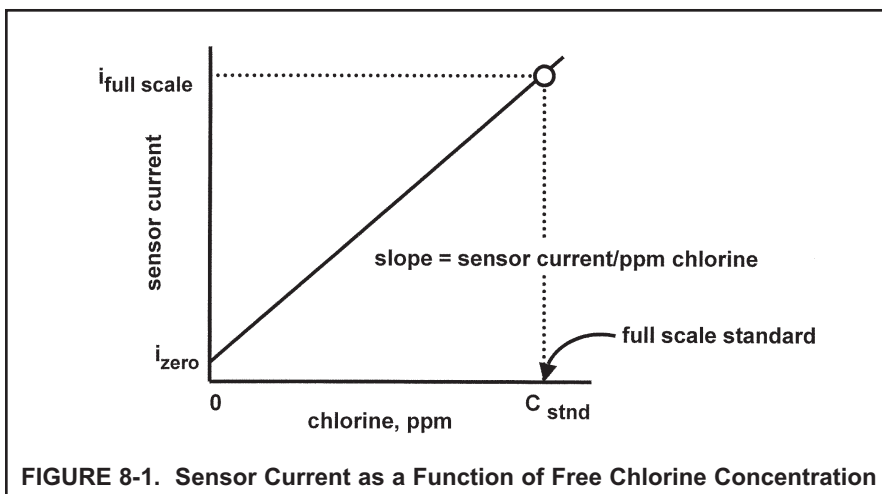

The Model 499ACL-01 free chlorine sensor loses sensitivity at high concentrations of chlorine. The 54eA controller has a dual slope feature that allows the user to compensate for the non-linearity of the sensor. However, for the vast majority of applications, dual slope calibration is unnecessary.

FIGURE 8-1. Sensor Current as a Function of Free Chlorine Concentration

8.2 ZEROING THE SENSOR

1. Place the sensor in the zero standard (see Section 8.1). Be sure no air bubbles are trapped against the membrane. The sensor current will drop rapidly at first and then gradually reach a stable zero value. To monitor the sensor current, go to the main display. Press any key to obtain the main menu. Press the ↓ key once to highlight “Diagnostic variables.” Press Enter (F4). The sensor current is the second item in the display. Note the units: nA is nanoamps, μA is microamps. To return to the main display, press exit (F1) twice. Typical zero current for a free chlorine sensor is -10 to +10 nA.

A new sensor or a sensor in which the electrolyte solution has been replaced may require several hours (occasionally as long as overnight) to reach a minimum zero current. **DO NOT START THE ZERO ROUTINE UNTIL THE SENSOR HAS BEEN IN ZERO SOLUTION FOR AT LEAST TWO HOURS.**

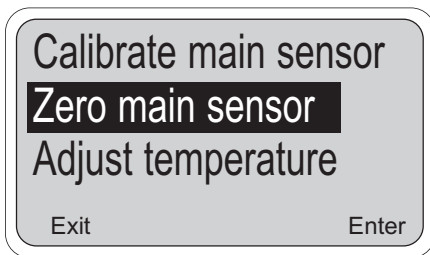

2. From the main display, press any key to obtain the main menu. With the cursor on “Calibrate,” press Enter (F4).

NOTE

If Hold was enabled in Section 5.6, the hold screen will appear. To activate hold, refer to Section 5.6, step 11.

Press the ↓ key once to move the cursor to “Zero main sensor.” Press Enter (F4).

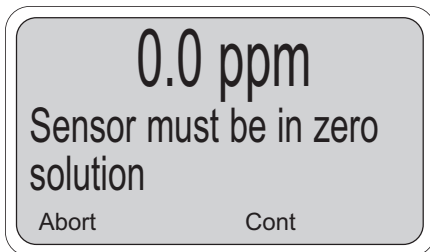

3. The screen at left appears. Press Cont (F3). “Wait” flashes until the sensor is stabilized. Once the zero step is complete, the message “Sensor zero done” appears.
4. Press Exit (F1) three times to return to the main display.

NOTE

If Hold was activated during calibration, “Hold Mode Activated” will continue to flash in the main display. Return the sensor to normal and deactivate Hold. Refer to Section 5.6, step 11.

NOTE

During calibration, ERROR and WARNING messages may appear. If an ERROR message appears, press Exit (F1) to leave and return to the previous screen. If a WARNING message appears, press Cont (F3) to continue the calibration or press Abort (F1) to leave. Continuing the calibration after a warning message appears may cause substantial errors in the subsequent measurement. Refer to Section 15.5 for assistance.

8.3 FULL SCALE CALIBRATION

- Place the sensor in the process liquid. If automatic pH correction is being used, calibrate the pH sensor (see Section 11.0) and place it in the process liquid. If manual pH correction is being used, measure the pH of the process liquid and enter the value. See Section 5.8. Adjust the sample flow until it is within the range recommended for the chlorine sensor. Refer to the sensor instruction sheet.
- Adjust the chlorine concentration until it is near the upper end of the control range. Wait until the controller reading is stable before starting the calibration.

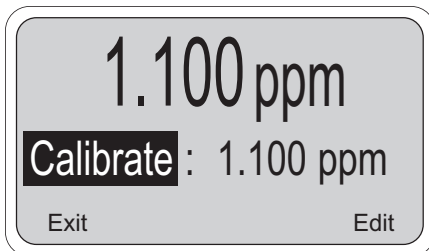
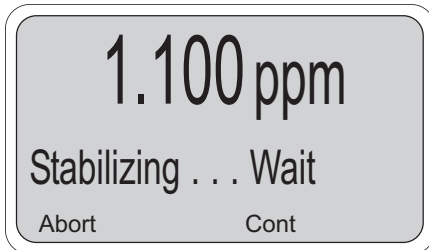
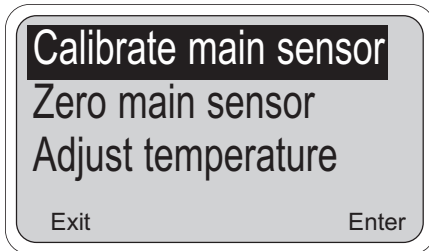

- From the main display, press any key to obtain the main menu. With the cursor on "Calibrate," press Enter (F4).

NOTE

If Hold was enabled in Section 5.6, the hold screen will appear. To activate hold, refer to Section 5.6, step 11.

Press Enter (F4).

- Press Cont (F3). "Wait" flashes until the sensor is stabilized. If the controller appears locked, the reading is not stable enough. Wait until the process readings are stable before starting the calibration. Alternatively, increase the stability concentration or reduce the stability time. See Section 5.11. Calibrating while readings are unstable may substantially reduce accuracy.

- Once the reading is stable, the screen at left appears. Sample the process liquid. Make a note of the reading before taking the sample. Immediately determine free chlorine. Note the controller reading again. If the present reading (X) differs from the reading when the sample was taken (Y), calculate the value to enter (C) from the following formula:

$$C = (X/Y) (A)$$

where A is the concentration of chlorine measured in the grab sample.

Press Edit (F4). Use the arrow keys to change the concentration in the second line of the display to the desired value. Press Save (F4) to store the value.

- Press Exit (F1) four times to return to the main display.

NOTE

If Hold was activated during calibration, "Hold Mode Activated" will continue to flash in the main display. Return the sensor to normal and deactivate Hold. Refer to Section 5.6, step 11.

- During the calibration, the analyzer stores the measured current and calculates the sensitivity. Sensitivity is the sensor current in nA divided by the measured concentration. The sensitivity of the 499ACL-01 (free chlorine) sensor is 250-350 nA/ppm at 25°C and pH 7.

To view the sensitivity from the main display, press any key to enter the main menu. Press the ↓ key once. Then press Enter (F4) to display the diagnostic variables. The sensitivity is the third line on the screen. Note the units: nA is nanoamps, μA is microamps.

NOTE

During calibration, ERROR and WARNING messages may appear. If an ERROR message appears, press Exit (F1) to leave and return to the previous screen. If a WARNING message appears, press Cont (F3) to continue the calibration or press Abort (F1) to leave. Continuing the calibration after a warning message appears may cause substantial errors in the subsequent measurement. Refer to Section 15.5 for assistance.

8.4 DUAL SLOPE CALIBRATION

Figure 8-2 shows the principle of dual slope calibration. Between zero and concentration C1, the sensor response is linear. When the concentration of chlorine becomes greater than C1, the response is non-linear. In spite of the non-linearity, the response can be approximated by a straight line between point 1 and point 2.

Dual slope calibration is rarely needed. It is probably useful in fewer than 5% of applications.

1. Be sure the analyzer has been configured for dual slope calibration. See Section 5.11.
2. Zero the sensor. See Section 8.2.
3. Place the sensor in the process liquid. If automatic pH correction is being used, calibrate the pH sensor (see Section 11.0) and place it in the process liquid. If manual pH correction is being used, measure the pH of the process liquid and enter the value. See Section 5.8. Adjust the sample flow until it is within the range recommended for the chlorine sensor. Refer to the sensor instruction sheet.

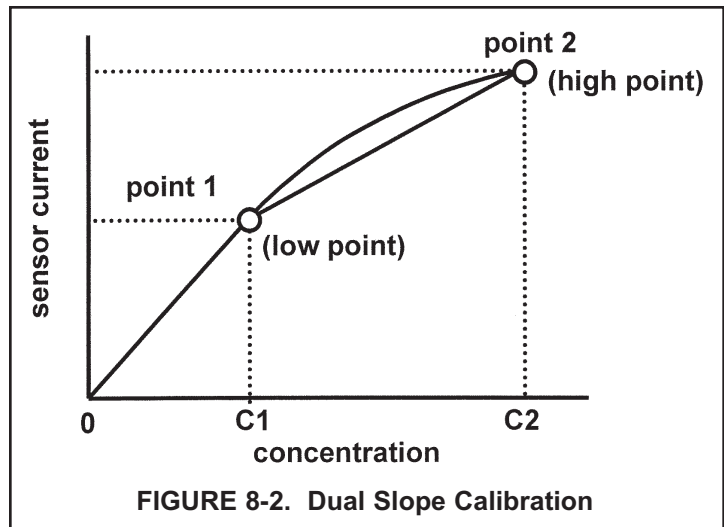
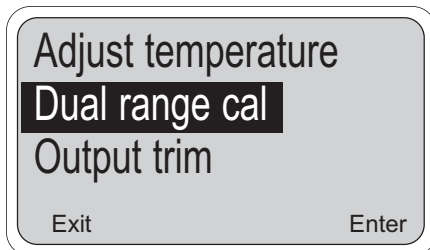

FIGURE 8-2. Dual Slope Calibration



4. From the main display, press any key to obtain the main menu. With the cursor on "Calibrate," press Enter (F4).

NOTE

If Hold was enabled in Section 5.6, the hold screen will appear. To activate hold, refer to Section 5.6, step 11.

Press the \downarrow key three times to move the cursor to "Dual range cal." Press Enter (F4).

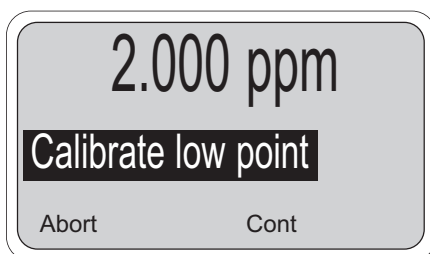

5. Adjust the concentration of chlorine in the process until it is near the upper end of the linear response range of the sensor, i.e., concentration near C1 as shown in Figure 8-2.

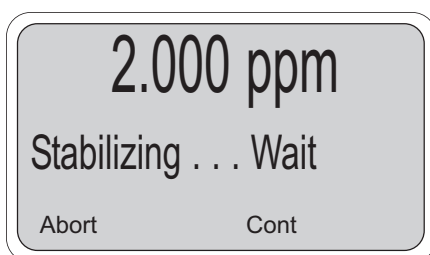

6. Press Cont (F3). "Wait" flashes until the sensor is stabilized.

If the controller appears locked, the reading is not stable enough. Wait until the process readings are stable before starting the calibration.

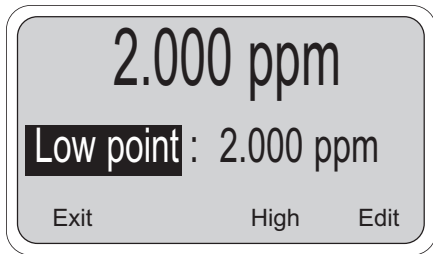

7. Once the reading is stable, the screen at left appears.

Sample the process liquid. Make a note of the reading before taking the sample. Immediately determine free chlorine. Note the controller reading again. If the present reading (X) differs from the reading when the sample was taken (Y), calculate the value to enter (C) from the following formula:

$$C = (X/Y) (A)$$

where A is the concentration of chlorine measured in the grab sample.

Press Edit (F4). Use the arrow keys to change the concentration in the second line of the display to the desired value. Press Save (F4) to store the value.

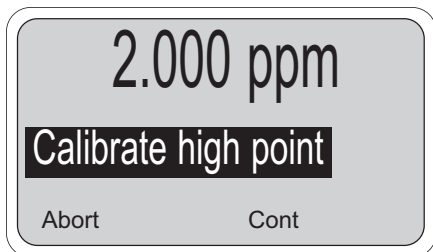

8. Press High (F3). Adjust the concentration of chlorine in the process until it is near the top end of the range, i.e., concentration near C2 as shown in Figure 6-2.

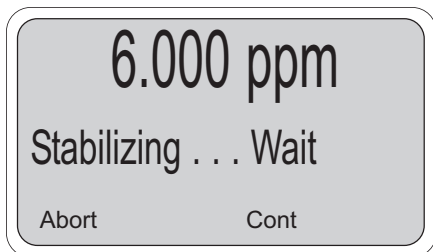

9. Press Cont (F3). "Wait" flashes until the sensor is stabilized.

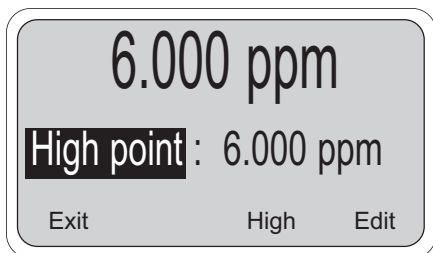

10. Once the reading is stable, the screen at left appears. Following the procedure in step 7, determine chlorine in a sample of the process liquid.

Press Edit (F4). Use the arrow keys to change the concentration in the second line of the display to the desired value. Press Save (F4) to store the value.

11. Press Exit (F1) three times to return to the main display.

NOTE

If Hold was activated during calibration, "Hold Mode Activated" will continue to flash in the main display. Return the sensor to normal and deactivate Hold. Refer to Section 5.6, step 11.

NOTE

During calibration, ERROR and WARNING messages may appear. If an ERROR message appears, press Exit (F1) to leave and return to the previous screen. If a WARNING message appears, press Cont (F3) to continue the calibration or press Abort (F1) to leave. Continuing the calibration after a warning message appears may cause substantial errors in the subsequent measurement. Refer to Section 15.5 for assistance.

SECTION 9.0 CALIBRATION - TOTAL CHLORINE

9.1 INTRODUCTION

Total chlorine is the sum of free and combined chlorine. The continuous determination of total chlorine requires two steps. See Figure 9-1. First, the sample flows into a conditioning system (SCS 921) where a pump continuously adds acetic acid and potassium iodide to the sample. The acid lowers the pH, which allows total chlorine in the sample to quantitatively oxidize the iodide in the reagent to iodine. In the second step, the treated sample flows to the sensor. The sensor is a membrane-covered amperometric sensor, whose output is proportional to the concentration of iodine. Because the concentration of iodine is proportional to the concentration of total chlorine, the analyzer can be calibrated to read total chlorine.

Figure 9-2 shows a typical calibration curve for a total chlorine sensor. Because the sensor really measures iodine, calibrating the sensor requires exposing it to a solution containing no iodine (zero standard) and to a solution containing a known amount of iodine (full-scale standard).

The zero standard is necessary because the sensor, even when no iodine is present, generates a small current called the residual current. The analyzer compensates for the residual current by subtracting it from the measured current before converting the result to a total chlorine value. New sensors require zeroing before being placed in service, and sensors should be zeroed whenever the electrolyte solution is replaced. The best zero standard is sample without reagent added.

The purpose of the full-scale standard is to establish the slope of the calibration curve. Because stable total chlorine standards do not exist, **the sensor must be calibrated against a test run on a grab sample of the process liquid.** Several manufacturers offer portable test kits for this purpose. Observe the following precautions when taking and testing the grab sample.

- Take the grab sample from a point as close as possible to the inlet of the SCS921 sample conditioning system. Be sure that taking the sample does not alter the flow through the SCS921. Sample flow must remain between 80 and 100 mL/min.
- Chlorine solutions are unstable. Run the test immediately after taking the sample. Try to calibrate the sensor when the chlorine concentration is at the upper end of the normal operating range.

The Model 499ACL-02 (total chlorine) sensor loses sensitivity at high concentrations of chlorine. The 54eA controller has a dual slope feature that allows the user to compensate for the non-linearity of the sensor. However, for the vast majority of applications, dual slope calibration is unnecessary.

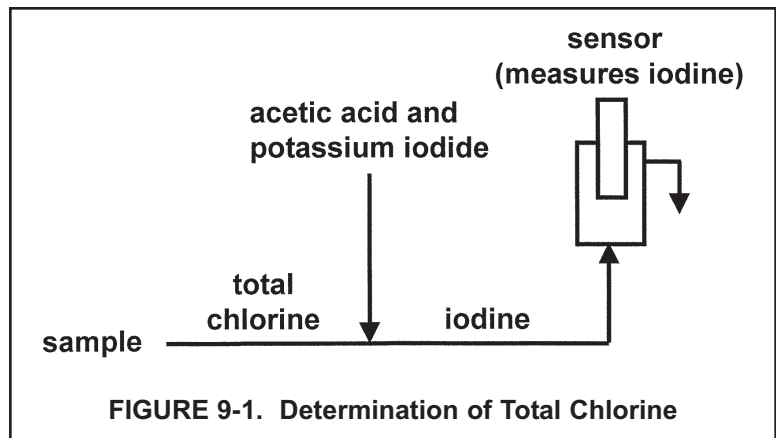

FIGURE 9-1. Determination of Total Chlorine

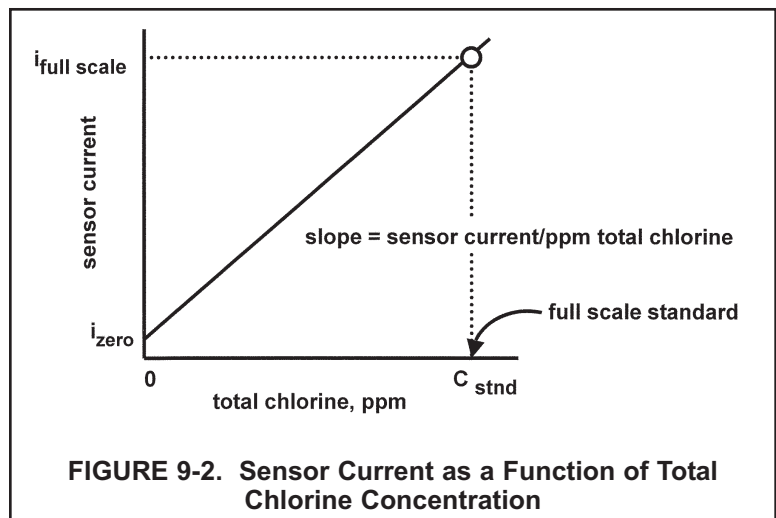
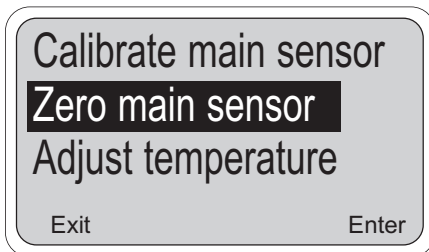

FIGURE 9-2. Sensor Current as a Function of Total Chlorine Concentration

9.2 ZEROING THE SENSOR

1. Complete the startup sequence described in the SCS921 instruction manual. Adjust the sample flow to between 80 and 100 mL/min, and set the sample pressure to between 3 and 5 psig.
2. Remove the reagent uptake tube from the reagent bottle and let it dangle in air. The peristaltic pump will simply pump air into the sample.
3. Let the system run until the sensor current is stable. The sensor current will drop rapidly at first and then gradually reach a stable zero value. To monitor the sensor current, go to the main display. Press any key to obtain the main menu. Press the ↓ key once to highlight “Diagnostic variables.” Press Enter (F4). The sensor current is the second item in the display. Note the units: nA is nanoamps, μA is microamps. To return to the main display, press exit (F1) twice. Typical zero current for a total chlorine sensor is -10 to +30 nA.

A new sensor or a sensor in which the electrolyte solution has been replaced may require several hours (occasionally as long as overnight) to reach a minimum zero current. **DO NOT START THE ZERO ROUTINE UNTIL THE SENSOR HAS BEEN IN ZERO SOLUTION FOR AT LEAST TWO HOURS.**



4. From the main display, press any key to obtain the main menu. With the cursor on “Calibrate,” press Enter (F4).

NOTE

If Hold was enabled in Section 5.6, the hold screen will appear. To activate hold, refer to Section 5.6, step 11.

Press the ↓ key once to move the cursor to “Zero main sensor.” Press Enter (F4).

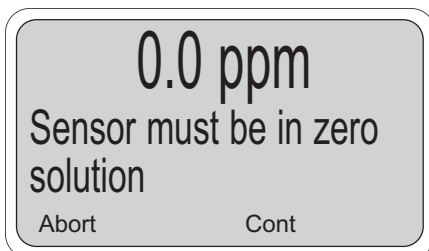

5. The screen at left appears. Press Cont (F3). “Wait” flashes until the sensor is stabilized. Once the zero step is complete, the message “Sensor zero done” appears.
6. Press Exit (F1) three times to return to the main display.

NOTE

If Hold was activated during calibration, “Hold Mode Activated” will continue to flash in the main display. Return the sensor to normal and deactivate Hold. Refer to Section 5.6, step 11.

NOTE

During calibration, ERROR and WARNING messages may appear. If an ERROR message appears, press Exit (F1) to leave and return to the previous screen. If a WARNING message appears, press Cont (F3) to continue the calibration or press Abort (F1) to leave. Continuing the calibration after a warning message appears may cause substantial errors in the subsequent measurement. Refer to the SCS921 instruction manual for assistance.

9.3 FULL SCALE CALIBRATION

1. If the sensor was just zeroed, place the reagent uptake tube back in the bottle. Once the flow of reagent starts, it takes about one minute for the sensor current to begin to increase. It may take an hour or longer for the reading to stabilize. Be sure the sample flow stays between 80 and 100 mL/min and the pressure is between 3 and 5 psig.
2. Adjust the chlorine concentration until it is near the upper end of the control range. Wait until the controller reading is stable before starting the calibration.

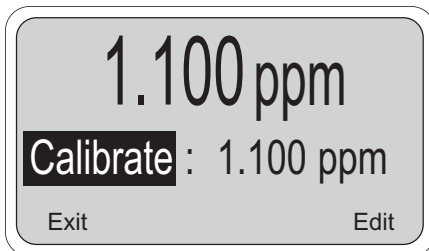
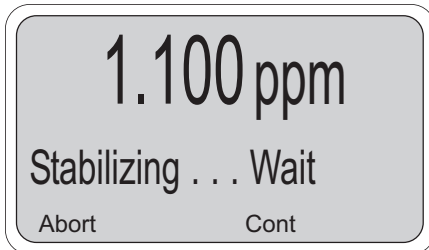
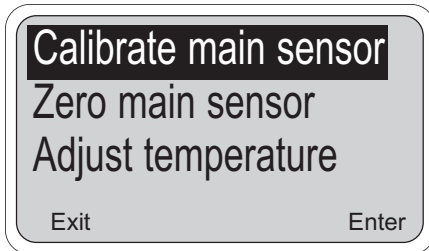

3. From the main display, press any key to obtain the main menu. With the cursor on "Calibrate," press Enter (F4).

NOTE

If Hold was enabled in Section 5.6, the hold screen will appear. To activate hold, refer to Section 5.6, step 11.

Press Enter (F4).

4. Press Cont (F3). "Wait" flashes until the sensor is stabilized. If the controller appears locked, the reading is not stable enough. Wait until the process readings are stable before starting the calibration. Alternatively, increase the stability concentration or reduce the stability time. See Section 5.11. Calibrating while readings are unstable may substantially reduce accuracy.

5. Once the reading is stable, the screen at left appears. Sample the process liquid. Make a note of the reading before taking the sample. Immediately determine total chlorine. Note the controller reading again. If the present reading (X) differs from the reading when the sample was taken (Y), calculate the value to enter (C) from the following formula:

$$C = (X/Y) (A)$$

where A is the concentration of chlorine measured in the grab sample.

Press Edit (F4). Use the arrow keys to change the concentration in the second line of the display to the desired value. Press Save (F4) to store the value.

6. Press Exit (F1) four times to return to the main display.

NOTE

If Hold was activated during calibration, "Hold Mode Activated" will continue to flash in the main display. Return the sensor to normal and deactivate Hold. Refer to Section 5.6, step 11.

7. During the calibration, the analyzer stores the measured current and calculates the sensitivity. Sensitivity is the sensor current in nA divided by the measured concentration. The sensitivity of the 499ACL-02 (total chlorine) sensor is about 1300 nA/ppm at 25°C.

To view the sensitivity from the main display, press any key to enter the main menu. Press the ↓ key once. Then press Enter (F4) to display the diagnostic variables. The sensitivity is the third line on the screen. Note the units: nA is nanoamps, μA is microamps.

NOTE

During calibration, ERROR and WARNING messages may appear. If an ERROR message appears, press Exit (F1) to leave and return to the previous screen. If a WARNING message appears, press Cont (F3) to continue the calibration or press Abort (F1) to leave. Continuing the calibration after a warning message appears may cause substantial errors in the subsequent measurement. Refer to the SCS921 instruction manual for assistance.

9.4 DUAL SLOPE CALIBRATION

Figure 9-3 shows the principle of dual slope calibration. Between zero and concentration C1, the sensor response is linear. When the concentration of chlorine becomes greater than C1, the response is non-linear. In spite of the non-linearity, the response can be approximated by a straight line between point 1 and point 2.

Dual slope calibration is rarely needed. It is probably useful in fewer than 5% of applications.

1. Be sure the analyzer has been configured for dual slope calibration. See Section 5.11.
2. Zero the sensor. See Section 9.2.
3. Place the sensor in the process liquid. Adjust the sample flow until it is between 80 and 100 mL/min. Refer to the sensor instruction sheet.

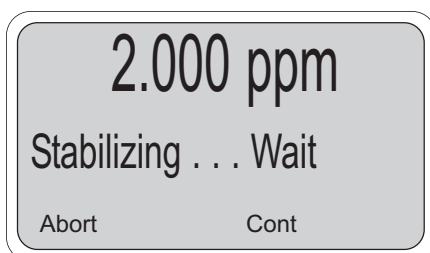
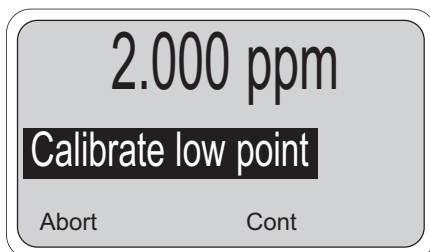
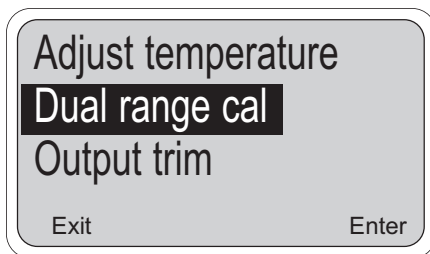
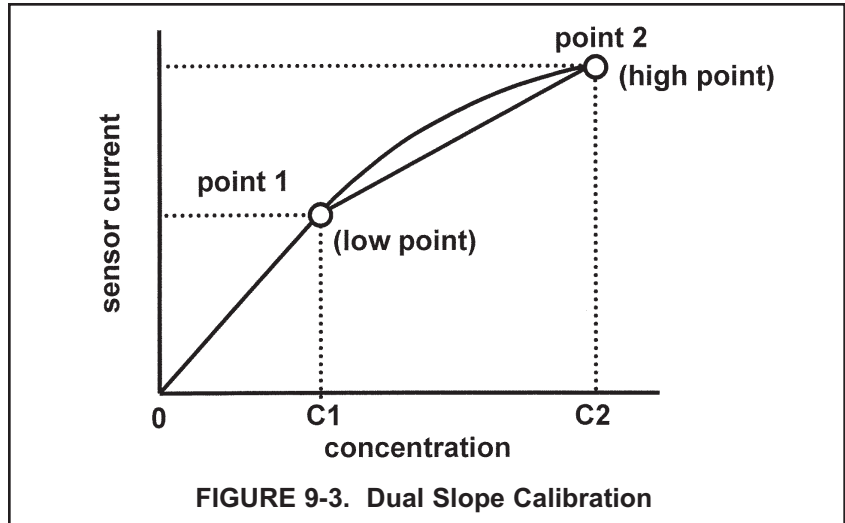

4. From the main display, press any key to obtain the main menu. With the cursor on "Calibrate," press Enter (F4).

NOTE

If Hold was enabled in Section 5.6, the hold screen will appear. To activate hold, refer to Section 5.6, step 11.

Press the ↓ key three times to move the cursor to "Dual range cal." Press Enter (F4).

5. Adjust the concentration of chlorine in the process until it is near the upper end of the linear response range of the sensor, i.e., concentration near C1 as shown in Figure 9-3.

6. Press Cont (F3). "Wait" flashes until the sensor is stabilized. If the controller appears locked, the reading is not stable enough. Wait until the process readings are stable before starting the calibration.

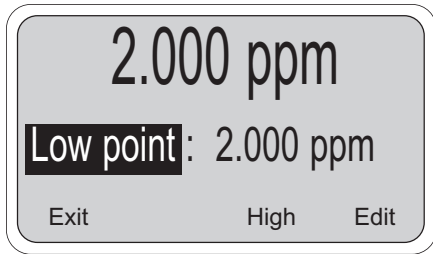

7. Once the reading is stable, the screen at left appears.

Sample the process liquid. Make a note of the reading before taking the sample. Immediately determine total chlorine. Note the controller reading again. If the present reading (X) differs from the reading when the sample was taken (Y), calculate the value to enter (C) from the following formula:

$$C = (X/Y) (A)$$

where A is the concentration of chlorine measured in the grab sample.

Press Edit (F4). Use the arrow keys to change the concentration in the second line of the display to the desired value. Press Save (F4) to store the value.

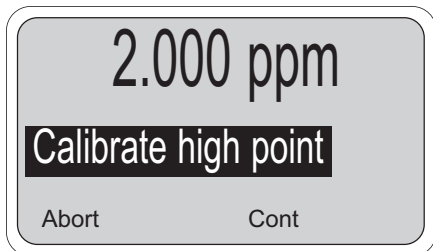

8. Press High (F3). Adjust the concentration of chlorine in the process until it is near the top end of the range, i.e., concentration near C2 as shown in Figure 6-2.

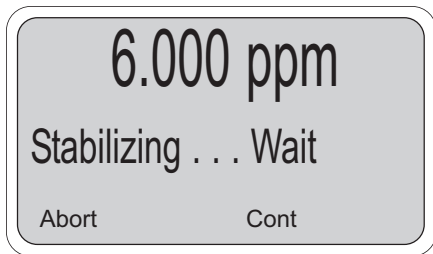

9. Press Cont (F3). "Wait" flashes until the sensor is stabilized.

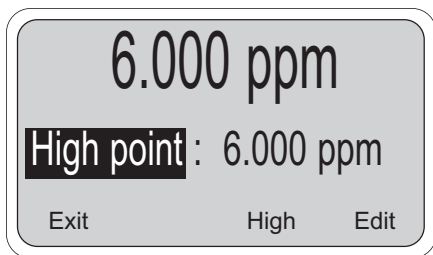

10. Once the reading is stable, the screen at left appears. Following the procedure in step 7, determine chlorine in a sample of the process liquid.

Press Edit (F4). Use the arrow keys to change the concentration in the second line of the display to the desired value. Press Save (F4) to store the value.

11. Press Exit (F1) three times to return to the main display.

NOTE

If Hold was activated during calibration, "Hold Mode Activated" will continue to flash in the main display. Return the sensor to normal and deactivate Hold. Refer to Section 5.6, step 11.

NOTE

During calibration, ERROR and WARNING messages may appear. If an ERROR message appears, press Exit (F1) to leave and return to the previous screen. If a WARNING message appears, press Cont (F3) to continue the calibration or press Abort (F1) to leave. Continuing the calibration after a warning message appears may cause substantial errors in the subsequent measurement. Refer to the SCS921 instruction manual for details.

SECTION 10.0 CALIBRATION - MONOCHLORAMINE

10.1 INTRODUCTION

As Figure 10-1 shows, a monochloramine sensor generates a current directly proportional to the concentration of monochloramine in the sample. Calibrating the sensor requires exposing it to a solution containing no monochloramine (zero standard) and to a solution containing a known amount of monochloramine (full-scale standard).

The zero standard is necessary because monochloramine sensors, even when no monochloramine is in the sample, generate a small current called the residual or zero current. The analyzer compensates for the residual current by subtracting it from the measured current before converting the result to a monochloramine value. New sensors require zeroing before being placed in service, and sensors should be zeroed whenever the electrolyte solution is replaced. The best zero standard is deionized water.

The purpose of the full-scale standard is to establish the slope of the calibration curve. Because stable monochloramine standards do not exist, **the sensor must be calibrated against a test run on a grab sample of the process liquid.** Several manufacturers offer portable test kits for this purpose. Observe the following precautions when taking and testing the grab sample.

- Take the grab sample from a point as close to the sensor as possible. Be sure that taking the sample does not alter the flow of the sample to the sensor. It is best to install the sample tap just downstream from the sensor.
- Monochloramine solutions are unstable. Run the test immediately after taking the sample. Try to calibrate the sensor when the monochloramine concentration is at the upper end of the normal operating range.

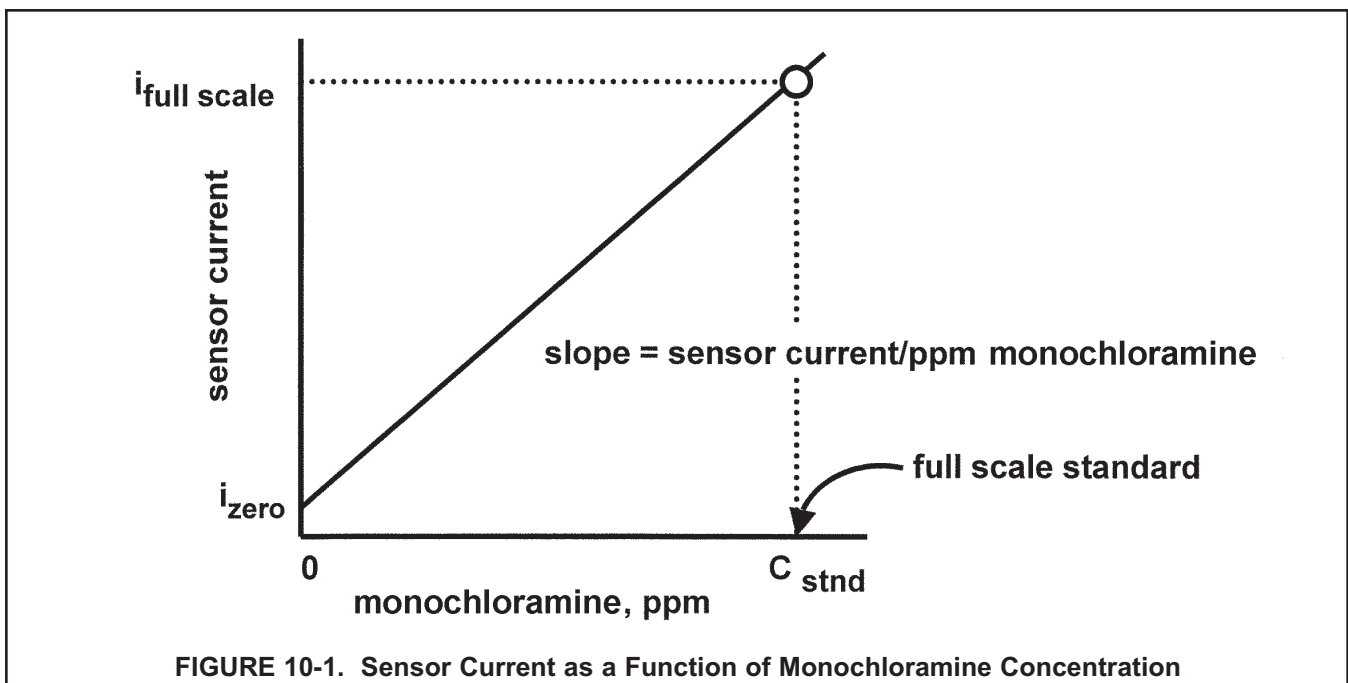
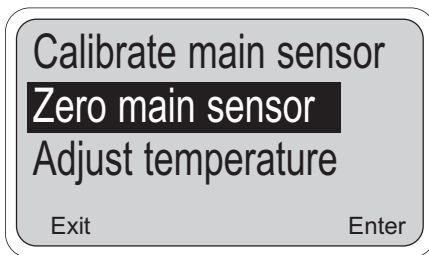

FIGURE 10-1. Sensor Current as a Function of Monochloramine Concentration

10.2 ZEROING THE SENSOR

1. Place the sensor in the zero standard. Be sure no air bubbles are trapped against the membrane. The sensor current will drop rapidly at first and then gradually reach a stable zero value. To monitor the sensor current, go to the main display. Press any key to obtain the main menu. Press the ↓ key once to highlight “Diagnostic variables.” Press Enter (F4). The sensor current is the second item in the display. Note the units: nA is nanoamps, μA is microamps. To return to the main display, press exit (F1) twice. Typical zero current for a monochloramine sensor is 0 to +20 nA.

A new sensor or a sensor in which the electrolyte solution has been replaced may require several hours (occasionally as long as overnight) to reach a minimum zero current. **DO NOT START THE ZERO ROUTINE UNTIL THE SENSOR HAS BEEN IN ZERO SOLUTION FOR AT LEAST TWO HOURS.**



2. From the main display, press any key to obtain the main menu. With the cursor on “Calibrate,” press Enter (F4).

NOTE

If Hold was enabled in Section 5.6, the hold screen will appear. To activate hold, refer to Section 5.6, step 11.

Press the ↓ key once to move the cursor to “Zero main sensor.” Press Enter (F4).

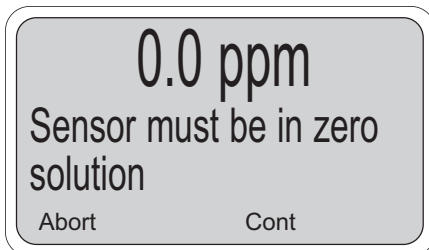

3. The screen at left appears. Press Cont (F3). “Wait” flashes until the sensor is stabilized. Once the zero step is complete, the message “Sensor zero done” appears.
4. Press Exit (F1) three times to return to the main display.

NOTE

If Hold was activated during calibration, “Hold Mode Activated” will continue to flash in the main display. Return the sensor to normal and deactivate Hold. Refer to Section 5.6, step 11.

NOTE

During calibration, ERROR and WARNING messages may appear. If an ERROR message appears, press Exit (F1) to leave and return to the previous screen. If a WARNING message appears, press Cont (F3) to continue the calibration or press Abort (F1) to leave. Continuing the calibration after a warning message appears may cause substantial errors in the subsequent measurement. Refer to Section 15.7 for assistance.

10.3 FULL SCALE CALIBRATION

- Place the sensor in the process liquid. Adjust the sample flow until it is within the range recommended for the sensor. Refer to the sensor instruction sheet.
- Adjust the monochloramine concentration until it is near the upper end of the control range. Wait until the controller reading is stable before starting the calibration.

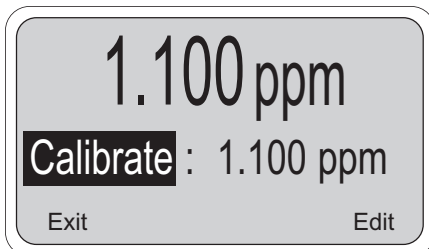
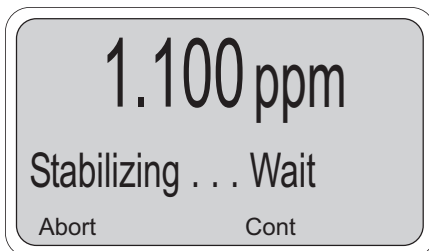
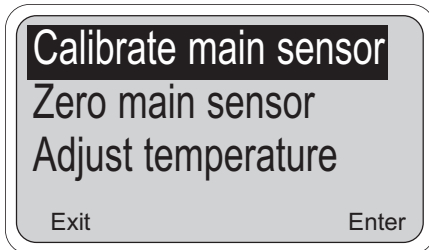

- From the main display, press any key to obtain the main menu. With the cursor on "Calibrate," press Enter (F4).

NOTE

If Hold was enabled in Section 5.6, the hold screen will appear. To activate hold, refer to Section 5.6, step 11.

Press Enter (F4).

- Press Cont (F3). "Wait" flashes until the sensor is stabilized. If the controller appears locked, the reading is not stable enough. Wait until the process readings are stable before starting the calibration. Alternatively, increase the stability concentration or reduce the stability time. See Section 5.11. Calibrating while readings are unstable may substantially reduce accuracy.

- Once the reading is stable, the screen at left appears. Sample the process liquid. Make a note of the reading before taking the sample. Immediately determine ozone. Note the controller reading again. If the present reading (X) differs from the reading when the sample was taken (Y), calculate the value to enter (C) from the following formula:

$$C = (X/Y) (A)$$

where A is the concentration of ozone measured in the grab sample.

Press Edit (F4). Use the arrow keys to change the concentration in the second line of the display to the desired value. Press Save (F4) to store the value.

- Press Exit (F1) four times to return to the main display.

NOTE

If Hold was activated during calibration, "Hold Mode Activated" will continue to flash in the main display. Return the sensor to normal and deactivate Hold. Refer to Section 5.6, step 11.

- During the calibration, the analyzer stores the measured current and calculates the sensitivity. Sensitivity is the sensor current in nA divided by the measured concentration. The sensitivity of the 499ACL-03 (monochloramine) sensor is 250-450 nA/ppm at 25°C. To view the sensitivity from the main display, press any key to enter the main menu. Press the ↓ key once. Then press Enter (F4) to display the diagnostic variables. The sensitivity is the third line on the screen. Note the units: nA is nanoamps, μA is microamps.

NOTE

During calibration, ERROR and WARNING messages may appear. If an ERROR message appears, press Exit (F1) to leave and return to the previous screen. If a WARNING message appears, press Cont (F3) to continue the calibration or press Abort (F1) to leave. Continuing the calibration after a warning message appears may cause substantial errors in the subsequent measurement. Refer to Section 15.7 for assistance.

SECTION 11.0 CALIBRATION - OZONE

11.1 INTRODUCTION

As Figure 11-1 shows, an ozone sensor generates a current directly proportional to the concentration of ozone in the sample. Calibrating the sensor requires exposing it to a solution containing no ozone (zero standard) and to a solution containing a known amount of ozone (full-scale standard).

The zero standard is necessary because ozone sensors, even when no ozone is in the sample, generate a small current called the residual current. The analyzer compensates for the residual current by subtracting it from the measured current before converting the result to an ozone value. New sensors require zeroing before being placed in service, and sensors should be zeroed whenever the electrolyte solution is replaced. Either of the following makes a good zero standard:

- Deionized water.
- Tap water known to contain no ozone. Expose tap water to ozone-free air for several hours.

The purpose of the full-scale standard is to establish the slope of the calibration curve. Because stable ozone standards do not exist, **the sensor must be calibrated against a test run on a grab sample of the process liquid.** Several manufacturers offer portable test kits for this purpose. Observe the following precautions when taking and testing the grab sample.

- Take the grab sample from a point as close to the sensor as possible. Be sure that taking the sample does not alter the flow of the sample to the sensor. It is best to install the sample tap just downstream from the sensor.
- Ozone solutions are unstable. Run the test immediately after taking the sample. Try to calibrate the sensor when the ozone concentration is at the upper end of the normal operating range.

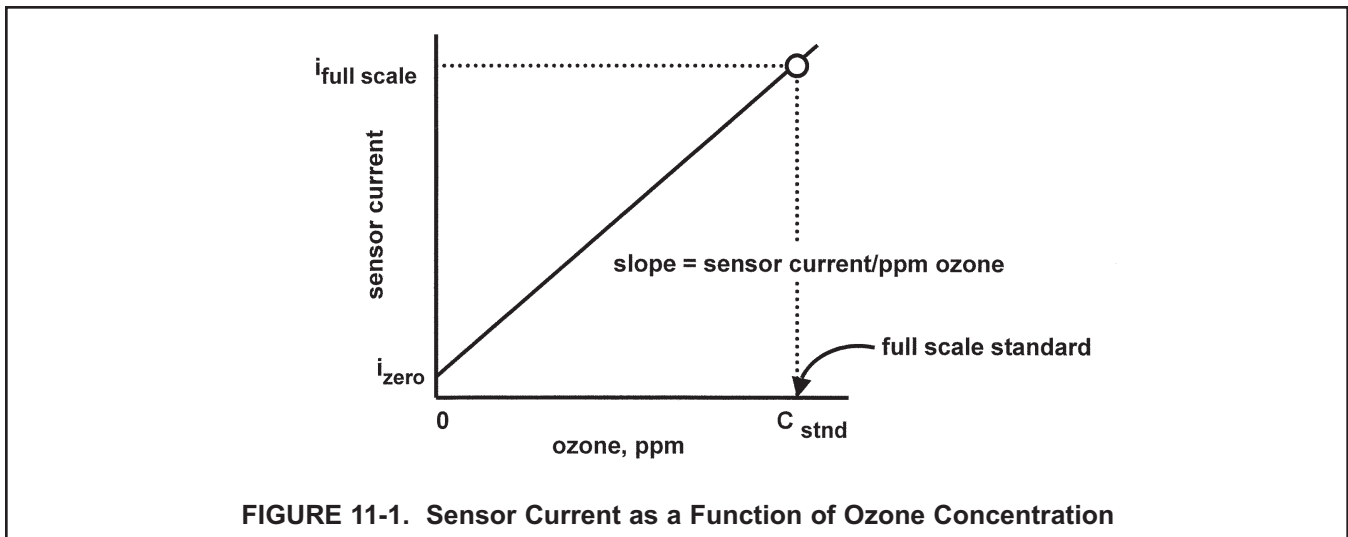

11.2 ZEROING THE SENSOR

1. Place the sensor in the zero standard. Be sure no air bubbles are trapped against the membrane. The sensor current will drop rapidly at first and then gradually reach a stable zero value. To monitor the sensor current, go to the main display. Press any key to obtain the main menu. Press the ↓ key once to highlight “Diagnostic variables.” Press Enter (F4). The sensor current is the second item in the display. Note the units: nA is nanoamps, μA is microamps. To return to the main display, press exit (F1) twice. Typical zero current for an ozone sensor is -10 to +10 nA.

A new sensor or a sensor in which the electrolyte solution has been replaced may require several hours (occasionally as long as overnight) to reach a minimum zero current. **DO NOT START THE ZERO ROUTINE UNTIL THE SENSOR HAS BEEN IN ZERO SOLUTION FOR AT LEAST TWO HOURS.**

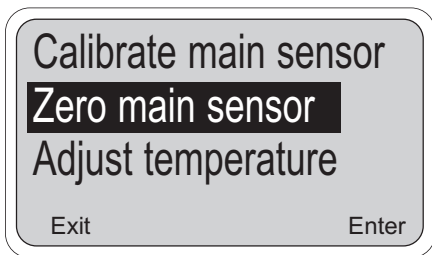

2. From the main display, press any key to obtain the main menu. With the cursor on “Calibrate,” press Enter (F4).

NOTE

If Hold was enabled in Section 5.6, the hold screen will appear. To activate hold, refer to Section 5.6, step 11.

Press the ↓ key once to move the cursor to “Zero main sensor.” Press Enter (F4).

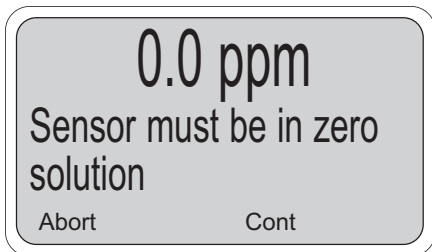

3. The screen at left appears. Press Cont (F3). “Wait” flashes until the sensor is stabilized. Once the zero step is complete, the message “Sensor zero done” appears.
4. Press Exit (F1) three times to return to the main display.

NOTE

If Hold was activated during calibration, “Hold Mode Activated” will continue to flash in the main display. Return the sensor to normal and deactivate Hold. Refer to Section 5.6, step 11.

NOTE

During calibration, ERROR and WARNING messages may appear. If an ERROR message appears, press Exit (F1) to leave and return to the previous screen. If a WARNING message appears, press Cont (F3) to continue the calibration or press Abort (F1) to leave. Continuing the calibration after a warning message appears may cause substantial errors in the subsequent measurement. Refer to Section 15.8 for assistance.

11.3 FULL SCALE CALIBRATION

1. Place the sensor in the process liquid. Adjust the sample flow until it is within the range recommended for the sensor. Refer to the sensor instruction sheet.
2. Adjust the ozone concentration until it is near the upper end of the control range. Wait until the controller reading is stable before starting the calibration.

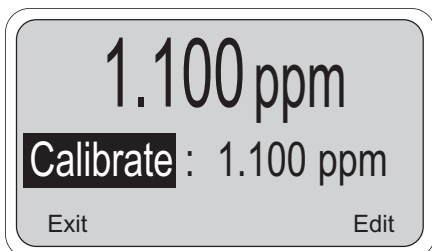
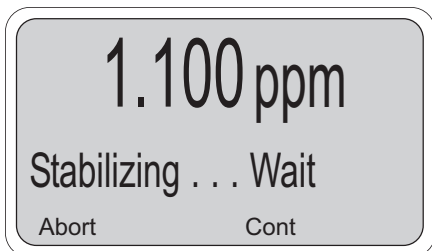
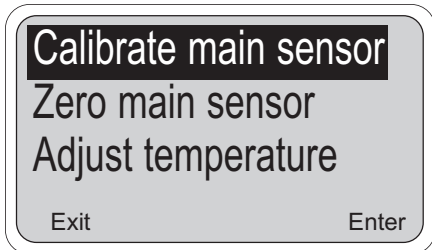

3. From the main display, press any key to obtain the main menu. With the cursor on "Calibrate," press Enter (F4).

NOTE

If Hold was enabled in Section 5.6, the hold screen will appear. To activate hold, refer to Section 5.6, step 11. Press Enter (F4).

4. Press Cont (F3). "Wait" flashes until the sensor is stabilized. If the controller appears locked, the reading is not stable enough. Wait until the process readings are stable before starting the calibration. Alternatively, increase the stability concentration or reduce the stability time. See Section 5.11. Calibrating while readings are unstable may substantially reduce accuracy.

5. Once the reading is stable, the screen at left appears. Sample the process liquid. Make a note of the reading before taking the sample. Immediately determine ozone. Note the controller reading again. If the present reading (X) differs from the reading when the sample was taken (Y), calculate the value to enter (C) from the following formula:

$$C = (X/Y) (A)$$

where A is the concentration of ozone measured in the grab sample. Press Edit (F4). Use the arrow keys to change the concentration in the second line of the display to the desired value. Press Save (F4) to store the value.

6. Press Exit (F1) four times to return to the main display.

NOTE

If Hold was activated during calibration, "Hold Mode Activated" will continue to flash in the main display. Return the sensor to normal and deactivate Hold. Refer to Section 5.6, step 11.

7. During the calibration, the analyzer stores the measured current and calculates the sensitivity. Sensitivity is the sensor current in nA divided by the measured concentration. The sensitivity of the 499AOZ (ozone) sensor is about 350 nA/ppm at 25°C.

To view the sensitivity from the main display, press any key to enter the main menu. Press the ↓ key once. Then press Enter (F4) to display the diagnostic variables. The sensitivity is the third line on the screen. Note the units: nA is nanoamps, μA is microamps.

NOTE

During calibration, ERROR and WARNING messages may appear. If an ERROR message appears, press Exit (F1) to leave and return to the previous screen. If a WARNING message appears, press Cont (F3) to continue the calibration or press Abort (F1) to leave. Continuing the calibration after a warning message appears may cause substantial errors in the subsequent measurement. Refer to Section 15.8 for assistance.

SECTION 12.0 CALIBRATION - pH

12.1 INTRODUCTION

A new pH sensor must be calibrated before use. Regular recalibration is also necessary.

A pH measurement cell (pH sensor and the solution to be measured) can be pictured as a battery with an extremely high internal resistance. The voltage of the battery depends on the pH of the solution. The pH meter, which is basically a voltmeter with a very high input impedance, measures the cell voltage and calculates pH using a conversion factor. The actual value of the voltage-to-pH conversion factor depends on the sensitivity of the pH sensing element (and the temperature). The sensing element is a thin, glass membrane at the end of the sensor. As the glass membrane ages, the sensitivity drops. Regular recalibration corrects for the loss of sensitivity. pH calibration standards, also called buffers, are readily available.

Two-point calibration is standard. Both automatic calibration and manual calibration are available. Auto calibration avoids common pitfalls and reduces errors. Its use is recommended.

In automatic calibration the controller recognizes the buffer and uses temperature-corrected pH values in the calibration. The table below lists the standard buffers the controller recognizes. The controller also recognizes several technical buffers: Merck, Ingold, and DIN 19267. Temperature-pH data stored in the controller are valid between at least 0 and 60°C.

pH at 25°C (nominal pH)	Standard(s)
1.68	NIST, DIN 19266, JSI 8802, BSI (see note 1)
3.56	NIST, BSI
3.78	NIST
4.01	NIST, DIN 19266, JSI 8802, BSI
6.86	NIST, DIN 19266, JSI 8802, BSI
7.00	(see note 2)
7.41	NIST
9.18	NIST, DIN 19266, JSI 8802, BSI
10.01	NIST, JSI 8802, BSI
12.45	NIST, DIN 19266

Note 1: NIST is National Institute of Standards, DIN is Deutsche Institute für Normung, JSI is Japan Standards Institute, and BSI is British Standards Institute.

Note 2: pH 7 buffer is not a standard buffer. It is a popular commercial buffer in the United States.

During automatic calibration, the controller also measures noise and drift and does not accept calibration data until readings are stable. Calibration data will be accepted as soon as the pH reading is constant to within the factory-set limits of 0.02 pH units for 10 seconds. The stability settings can be changed. See Section 5.11.

In manual calibration, the controller still monitors readings for stability; however, the buffer pH lookup feature is missing. The user has to enter the correct pH at the temperature the buffer is being used.

Once the controller completes the calibration, it calculates the calibration slope and offset. The slope is reported as the slope at 25°C. Figure 12-1 defines the terms.

The controller can also be standardized. Standardization is the process of forcing the controller reading to match the reading from a second pH instrument. Standardization is sometimes called a one-point calibration.

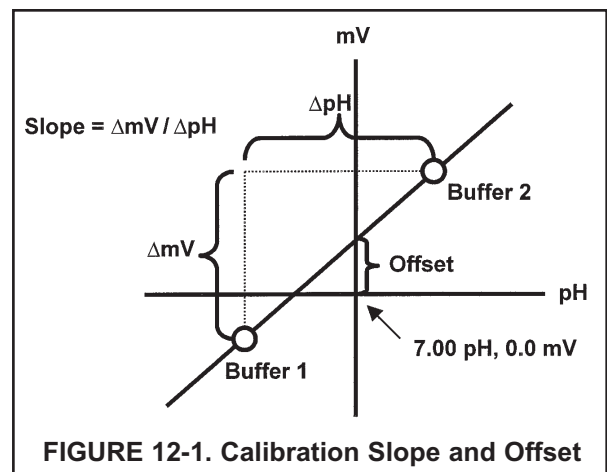

FIGURE 12-1. Calibration Slope and Offset

12.2 AUTOMATIC TWO-POINT CALIBRATION

1. Be sure the pH feature has been enabled. See Section 5.8.
2. Obtain two buffer solutions. Ideally the buffer pH values should bracket the range of pH values to be measured.
3. Remove the sensor from the process liquid. If the process and buffer temperatures are appreciably different, place the sensor in a container of tap water at the buffer temperature. Do not start the calibration until the sensor has reached the buffer temperature. Thirty minutes is usually adequate.

4. From the main display, press any key to obtain the main menu. With the cursor on "Calibrate" press Enter (F4).

NOTE

If Hold was enabled in Section 5.6, the hold screen will appear. To activate hold, refer to Section 5.6, step 11.

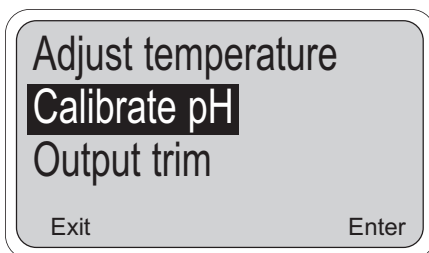

5. Press the ↓ key three times to move the cursor to "Calibrate pH". Press Enter (F4).

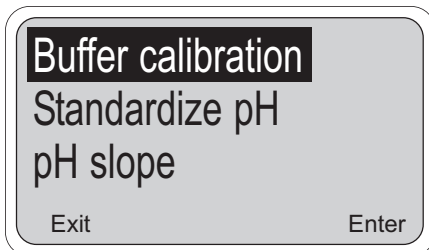

6. Press Enter (F4).

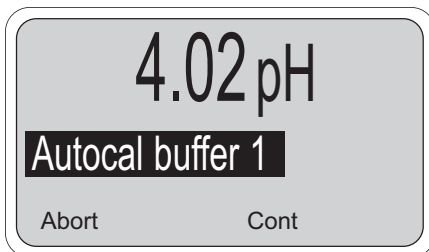

7. Rinse the sensor with water and place it in buffer 1. Be sure the glass bulb and reference junction are completely submerged. Swirl the sensor. Press Cont (F3). "Wait" flashes until the reading stabilizes.

If the controller appears locked, the reading is not stable enough. Investigate and correct the cause of the noise or drift (see Section 14.8). Alternatively, change the stability limits (see Section 5.8) and repeat the calibration.

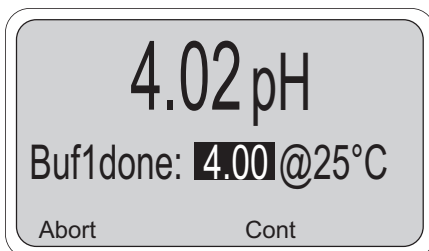

8. The screen at left appears once the reading is stable. Use the ↑ or ↓ key to change the reading to the nominal pH of the buffer. The nominal pH is the pH of the buffer at 25°C. Press Cont (F3).

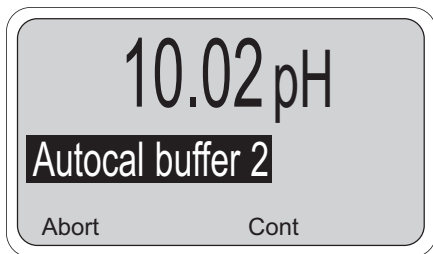

9. Remove the sensor from buffer 1, rinse it with water, and place it in buffer 2. Swirl the sensor. Press Cont (F3). "Wait" flashes until the reading is stable.

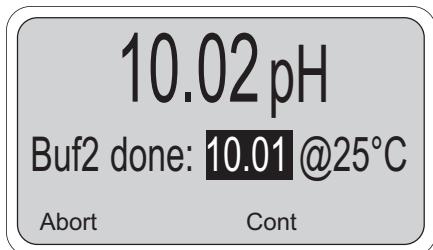

10. The screen at left appears once the reading is stable. Use the \uparrow or \downarrow key to change the reading to the nominal pH of the buffer. The nominal pH is the pH of the buffer at 25°C. Press Cont (F3).

11. Press Exit (F1) four times to return to the main display.

NOTE

If Hold was activated during calibration, "Hold Mode Activated" will continue to flash in the main display. Return the sensor to normal and deactivate Hold. Refer to Section 5.6, step 11.

12. To view the slope and offset press any key to enter the main menu. Press the \downarrow key once to move the cursor to "Diagnostic variables". Press Enter (F4). Press the \downarrow key six times to scroll through the list of diagnostic variables. Note that the pH slope is at 25°C.

NOTE

During calibration, ERROR and WARNING messages may appear. If an ERROR message appears, press Exit (F1) to leave and return to the previous screen. If a WARNING message appears, press Cont (F3) to continue the calibration or press Abort (F1) to leave. Continuing the calibration after a warning message appears may cause substantial errors in the subsequent measurement. Refer to Section 15.9 for assistance.

12.3 MANUAL TWO-POINT CALIBRATION

1. Be sure the pH feature has been enabled. See Section 5.8.
2. The controller comes from the factory set for automatic pH calibration. To do a manual calibration, the factory default setting must be changed. Refer to Section 5.8.
3. Obtain two buffer solutions. Ideally the buffer pH values should bracket the range of pH values to be measured. Also obtain a thermometer. The pH of most buffer solutions is a function of temperature. To calibrate the sensor properly, the pH of the buffer at the measurement temperature must be entered in the analyzer.
4. Remove the sensor from the process liquid. If the process and buffer temperatures are appreciably different, place the sensor in a container of tap water at the buffer temperature. Do not start the calibration until the sensor has reached the buffer temperature. Thirty minutes is usually adequate.

5. From the main display, press any key to obtain the main menu. With the cursor on "Calibrate" press Enter (F4).

NOTE

If Hold was enabled in Section 5.6, the hold screen will appear. To activate hold, refer to Section 5.6, step 11.

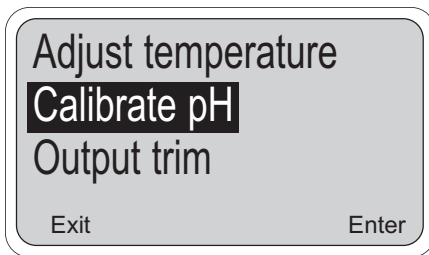

6. Press the ↓ arrow key three times to move the cursor to "Calibrate pH". Press Enter (F4).

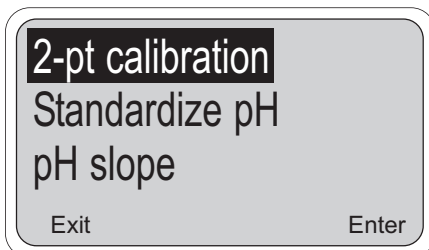

7. With the cursor on "2-pt calibration" press Enter (F4).

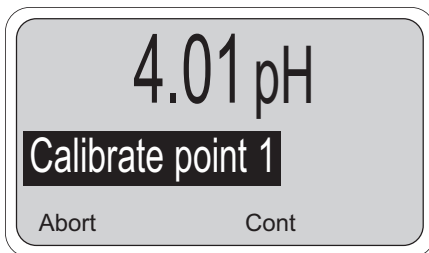

8. Rinse the sensor and thermometer with water and place them in buffer 1. Be sure the glass bulb and junction are completely submerged. Swirl the sensor. Press Cont (F3). "Wait" flashes until the reading stabilizes. The large number on the first line is the measured pH based on the previous calibration.

If the controller appears locked, the reading is not stable enough. Investigate and correct the cause of the noise or drift (see Section 14.8). Alternatively, change the stability limits (see Section 5.8) and repeat the calibration.

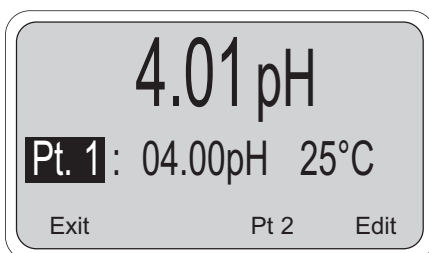

9. The screen at left appears once the reading is stable. Press Edit (F4) and use the arrow keys to change the reading to the pH of the buffer at the measured temperature. Most commercial buffers have a table of pH values as a function of temperature on the label. Press Save (F4) to store the value. If the pH value on the first line is correct, press Pt 2 (F3) and go to step 11.

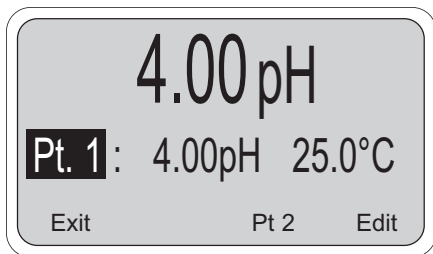

10. The screen at left appears if the pH reading in step 9 was changed. Press Pt2 (F3). Go to step 11.

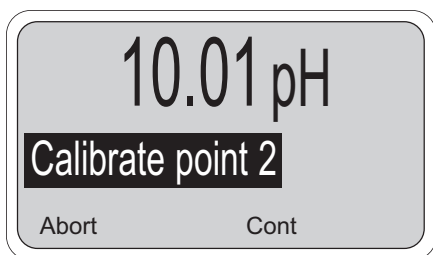

11. Rinse the sensor and thermometer with water and place them in buffer 2. Be sure the glass bulb and junction are completely submerged. Swirl the sensor. Press Cont (F3). "Wait" flashes until the reading stabilizes.

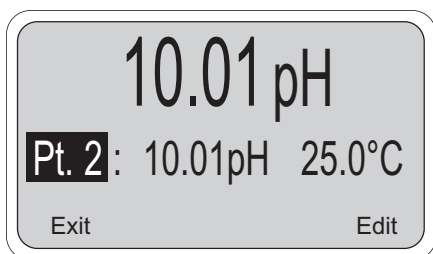

12. The screen at left appears once the reading is stable. Press Edit (F4) and use the arrow keys to change the reading to the pH of the buffer at the measured temperature. Press Save (F4) to store the value.

Press Exit (F1) four times to return to the main display.

NOTE

If Hold was activated during calibration, "Hold Mode Activated" will continue to flash in the main display. Return the sensor to normal and deactivate Hold. Refer to Section 5.6, step 11.

13. To view the slope and offset press any key to enter the main menu. Press the ↓ key once to move the cursor to "Diagnostic variables". Press Enter (F4). Press the ↓ key six times to scroll through the list of diagnostic variables. Note that the pH slope is at 25°C.

NOTE

During calibration, ERROR and WARNING messages may appear. If an ERROR message appears, press Exit (F1) to leave and return to the previous screen. If a WARNING message appears, press Cont (F3) to continue the calibration or press Abort (F1) to leave. Continuing the calibration after a warning message appears may cause substantial errors in the subsequent measurement. Refer to Section 15.9 for assistance.

12.4 STANDARDIZATION (ONE-POINT CALIBRATION)

1. The pH measured by the controller can be changed to match the reading from a second or referee instrument. The process of making the two reading agree is called standardization, or one-point calibration.
2. During standardization, the difference between the two pH values is converted to the equivalent voltage. The voltage, called the reference offset, is added to all subsequent measured cell voltages before they are converted to pH. If a sensor that has been calibrated with buffers is then standardized and placed back in a buffer, the measured pH will differ from the buffer pH by an amount equivalent to the standardization offset.
3. Install the sensor in the process liquid. Once readings are stable, measure the pH of the liquid using a referee instrument. Normally, it is acceptable to test a grab sample. Because the pH of the process liquid may change if the temperature changes, measure the pH immediately after taking the grab sample. For poorly buffered samples, it is best to determine the pH of a continuously flowing sample from a point as close as possible to the process sensor.

4. From the main display, press any key to obtain the main menu. With the cursor on "Calibrate" press Enter (F4).

NOTE

If Hold was enabled in Section 5.6, the hold screen will appear. To activate hold, refer to Section 5.6, step 11.

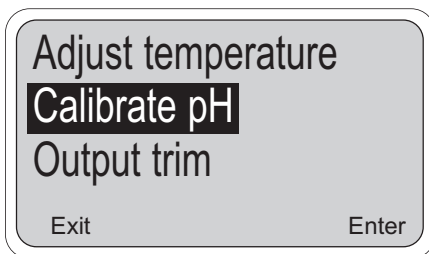

5. Press the ↓ key three times to move the cursor to "Calibrate pH". Press Enter (F4).

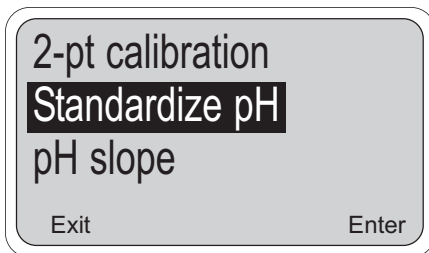

6. Press the ↓ key once to move the cursor to "Standardize pH". Press Enter (F4).



7. The pH reading in large numbers is the current process reading. Press Edit (F4). Use the arrow keys to change the reading in the second line to match the referee instrument. Press Save (F4).

8. Press Exit (F1) four times to return to the main display.

NOTE

If Hold was activated during calibration, "Hold Mode Activated" will continue to flash in the main display. Return the sensor to normal and deactivate Hold. Refer to Section 5.6, step 11.

NOTE

During calibration, ERROR and WARNING messages may appear. If an ERROR message appears, press Exit (F1) to leave and return to the previous screen. If a WARNING message appears, press Cont (F3) to continue the calibration or press Abort (F1) to leave. Continuing the calibration after a warning message appears may cause substantial errors in the subsequent measurement. Refer to Section 15.9 for assistance.

12.5 pH SLOPE ADJUSTMENT

1. If the electrode slope is known from other measurements, it can be entered directly into the controller. The slope must be entered as the slope at 25°C. To calculate the slope at 25°C from the slope at temperature t°C, use the equation:

$$\text{slope at } 25^{\circ}\text{C} = (\text{slope at } t^{\circ}\text{C}) \frac{298}{t^{\circ}\text{C} + 273}$$

Changing the slope overrides the slope determined from the previous buffer calibration.

2. From the main display, press any key to obtain the main menu. With the cursor on "Calibrate" press Enter (F4).

NOTE

If Hold was enabled in Section 5.6, the hold screen will appear. To activate hold, refer to Section 5.6, step 11.

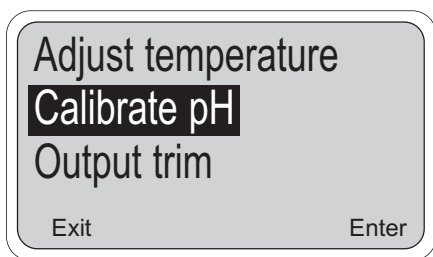

3. Press the ↓ key three times to move the cursor to "Calibrate pH". Press Enter (F4).

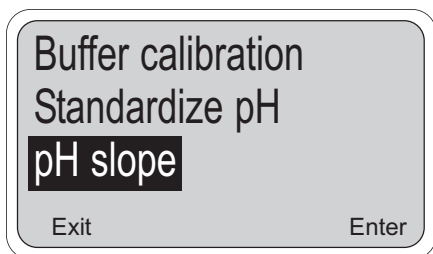

4. Press the ↓ key twice to move the cursor to "pH slope." Press Enter (F4).

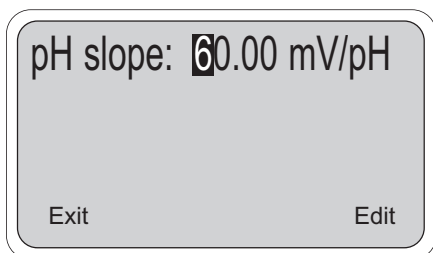

5. Press Edit (F4). Use the arrow keys to change the slope to the desired value. The slope must be between 45 and 60 mV/pH. Press Save (F4).
6. Press Exit (F1) four times to return to the main display.

NOTE

If Hold was activated during calibration, "Hold Mode Activated" will continue to flash in the main display. Return the sensor to normal and deactivate Hold. Refer to Section 5.6, step 11.

NOTE

During calibration, ERROR and WARNING messages may appear. If an ERROR message appears, press Exit (F1) to leave and return to the previous screen. If a WARNING message appears, press Cont (F3) to continue the calibration or press Abort (F1) to leave. Continuing the calibration after a warning message appears may cause substantial errors in the subsequent measurement. Refer to Section 15.9 for assistance.

SECTION 13.0 CALIBRATION - CURRENT OUTPUTS

13.1 INTRODUCTION

Although the controller outputs are calibrated at the factory, they can be trimmed in the field to match the reading from a standard current meter. Both the low output (0 or 4 mA) and the high output (20 mA) can be trimmed.

13.2 TRIMMING THE OUTPUTS

1. From the main display, press any key to obtain the main menu. With the cursor on "Calibrate" press Enter (F4).

NOTE

If Hold was enabled in Section 5.6, the hold screen will appear. To activate hold, refer to Section 5.6, step 11.

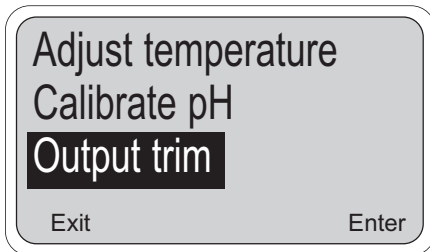

2. Move the cursor to "Output trim" and press Enter (F4).

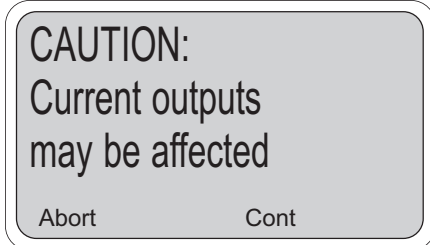

3. The warning screen reminds the user that the output currents will be affected. Pres Cont (F3) to continue.

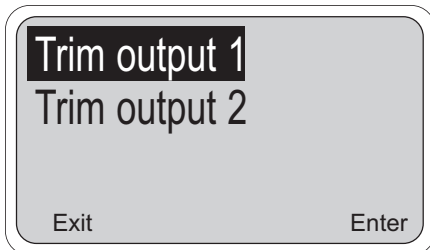

4. Use the ↑ or ↓ keys to move the cursor to the desired output and press Enter (F4).

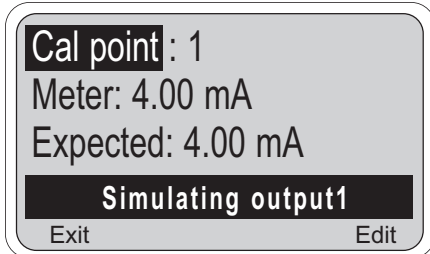

5. Select "Cal point 1" (0 or 4 mA) or "Cal point 2" (20 mA).
6. Move the cursor to "Meter" and press Enter (F4). Measure the output current with a calibrated ammeter. Use the ↑ or ↓ keys to change the display to match the ammeter reading and press Save (F4).
7. Move the cursor to the other "Cal point" and select it. Repeat step 6.

NOTE

If Hold was activated during calibration, "Hold Mode Activated" will continue to flash in the main display. Return the sensor to normal and deactivate Hold. Refer to Section 5.6, step 11.

SECTION 14.0

PID AND TPC CONTROL

14.1 PID CONTROL (CODE -20)

PID Control

The Model 54eA current outputs can be programmed for PID control. PID control is used with a control device that is capable of varying its output from 0 to 100 percent in response to a changing signal in milliamps. Automated control valves or variable volume pumps are commonly used. These devices are referred to as modulating control devices because of their 0 to 100% adjustability. PID control is typically used where greater accuracy than is achievable with an on/off device is required, or where it is desirable to have the pump or valve "on" continuously, or where the existing or preferred pump or valve is of the modulating type.

Any process control system must manually or automatically hold the controlled variable (pH, concentration, temperature) in a steady condition at selected set point values. For manual control, the operator looks at the value of the process variable, decides whether or not it is correct, and makes necessary adjustments. He decides the amount, direction, rate of change and duration of the adjustment. With automatic control, the controller does all of this. The operator only adjusts the set point of the controller to the selected value of the measured variable. Automatic process control such as PID is usually feedback control; it eliminates the deviation between measurement and set point based on continuous updates (feedback) from the process itself.

Measurement and Set Point (Feedback Control)

The Model 54eA controller is given two items of information: measurement and set point. The controller reacts to the difference in value of these two signals and produces an analog output signal to eliminate that difference. As long as the difference exists, the controller will try to eliminate it with the output signal. When measurement and set point are equal, the condition of the controller is static and its output is unchanged. Any deviation of measurement from set point will cause the controller to react by changing its output signal.

PID Control Mode Combinations

All PID controllers have several control modes which can be used in various combinations: proportional plus integral (reset), proportional plus derivative (rate) and a combination of proportional (P), integral (I) and derivative (D). Each control mode produces a response to the deviation of measurement from set point that is the result of a specific characteristic of the deviation, and each control mode is separately adjustable. D, the derivative, or rate mode, is seldom used in water treatment and is beyond the scope of this manual.

Proportional Mode (Gain)

The simplest control is proportional. Proportional may also be referred to as sensitivity or gain. Although these terms may refer to a different version of proportional, the control function is still fundamentally the same - the error from set point is multiplied by this factor to produce the output.

In the Model 54eA controller, proportional mode is referred to as proportional "band" which is configurable from 0 to 299%. For good control of a specific process, the proportional band must be properly adjusted. The proportional band is the percent of the analog output span (the difference between the 4 (or 0) mA and 20 mA settings) through which the measured variable must move to change the output from minimum to maximum. The larger the proportional band, the less the controller reacts to changes in the measured variable. As the proportional band is made smaller, the reaction of the controller increases. At 0 proportional band, the proportional-only controller behaves like an on/off controller (an alarm set at 20 mA).

Most processes require that the measured variable be held at the set point. The proportional mode alone will not automatically do this. Proportional alone will only stabilize the measured variable at some offset to the actual control point. To control at an exact setpoint, proportional plus integral mode is used.

Proportional (Gain) Plus Integral (Reset)

For the automatic elimination of deviation, I (Integral mode), also referred to as Reset, is used. The proportional function is modified by the addition of automatic reset. With the reset mode, the controller continues to change its output until the deviation between measurement and set point is eliminated.

The action of the reset mode depends on the proportional band. The rate at which it changes the controller output is based on the proportional band size and the reset adjustment. **The reset time is the time required for the reset mode to repeat the proportional action once. It is expressed as seconds per repeat, adjustable from 0-2999 seconds.**

The reset mode repeats the proportional action as long as an offset from the set point exists. Reset action is cumulative. The longer the offset exists, the more the output signal is increased.

The controller configured with reset continues to change until there is no offset. If the offset persists, the reset action eventually drives the controller output to its 100% limit - a condition known as **"reset windup"**. To prevent reset windup, a controller with reset mode should never be used to control a measured variable influenced by uncorrectable conditions. Once the controller is "wound up", the deviation must be eliminated or redirected before the controller can unwind and resume control of the measured variable. The integral time can be cleared and the "windup" condition quickly eliminated by **manually overriding the analog output using the simulate tests feature (detailed in Section 5.4)**.

Control Loop Adjustment and Tuning

There are several methods for tuning PID loops including: Ziegler-Nichols frequency response, open loop step response, closed loop step response, and trial and error. Described in this section is a form of the open loop response method called the process reaction curve method. The reaction times and control characteristics of installed equipment and real processes are difficult to predict. The process reaction curve method of tuning works well because it is based on the response of the installed system. This procedure, outlined in the following paragraphs, can be used as a starting point for the **P** and **I** settings. Experience has shown that PID controllers will do a fair job of controlling most processes with many combinations of reasonable control mode settings.

Process Reaction Curve Method

A PID loop can be tuned using the process reaction curve method. This method involves making a step change in the chemical feedrate (usually about 50% of the pump or valve range) and graphing the response of the Model 54eA controller reading versus time.

The process reaction curve graphically shows the reaction of the process to step change in the input signal. Figure 14-1 shows an example of a tuning process for a pH controller. Similar results can be obtained for the oxygen, ozone, or chlorine controller.

To use this procedure with a Model 54eA controller and a control valve or metering pump, follow the steps outlined below.

Wire the controller to the control valve or metering pump. Introduce a step change to the process by using the simulate test function to make the step change in the output signal.

Graph the change in the measured variable (concentration or pH) as shown in Figure 14-1. Observe the reading on the Model 54eA controller and note values at intervals timed with a stop watch. A strip chart recorder can be used for slower reacting processes. To collect the data, perform the following steps:

1. Let the system come to a steady state where the measured variable (pH, concentration or temperature) is relatively stable.
2. Observe the output current on the main display of the controller.
3. Using the simulate test, manually set the controller output signal at the value which represented the stable process measurement observed in step 1, then observe the process reading to ensure steady state conditions (a stable process measurement).
4. Using the simulate test, cause a step change in the output signal. This change should be large enough to produce a significant change in the measured variable in a reasonable amount of time, but not too large to drive the process out of desired limits.
5. The reaction of the system, when graphed, will resemble Figure 14-1, showing a change in the measured variable over the change in time. After a period of time (the process delay time), the measured variable will start to increase (or decrease) rapidly. At some further time the process will begin to change less rapidly as the process begins to stabilize from the imposed step change. It is important to collect data for a long enough period of time to see the process begin to level off to establish a tangent to the process reaction curve.

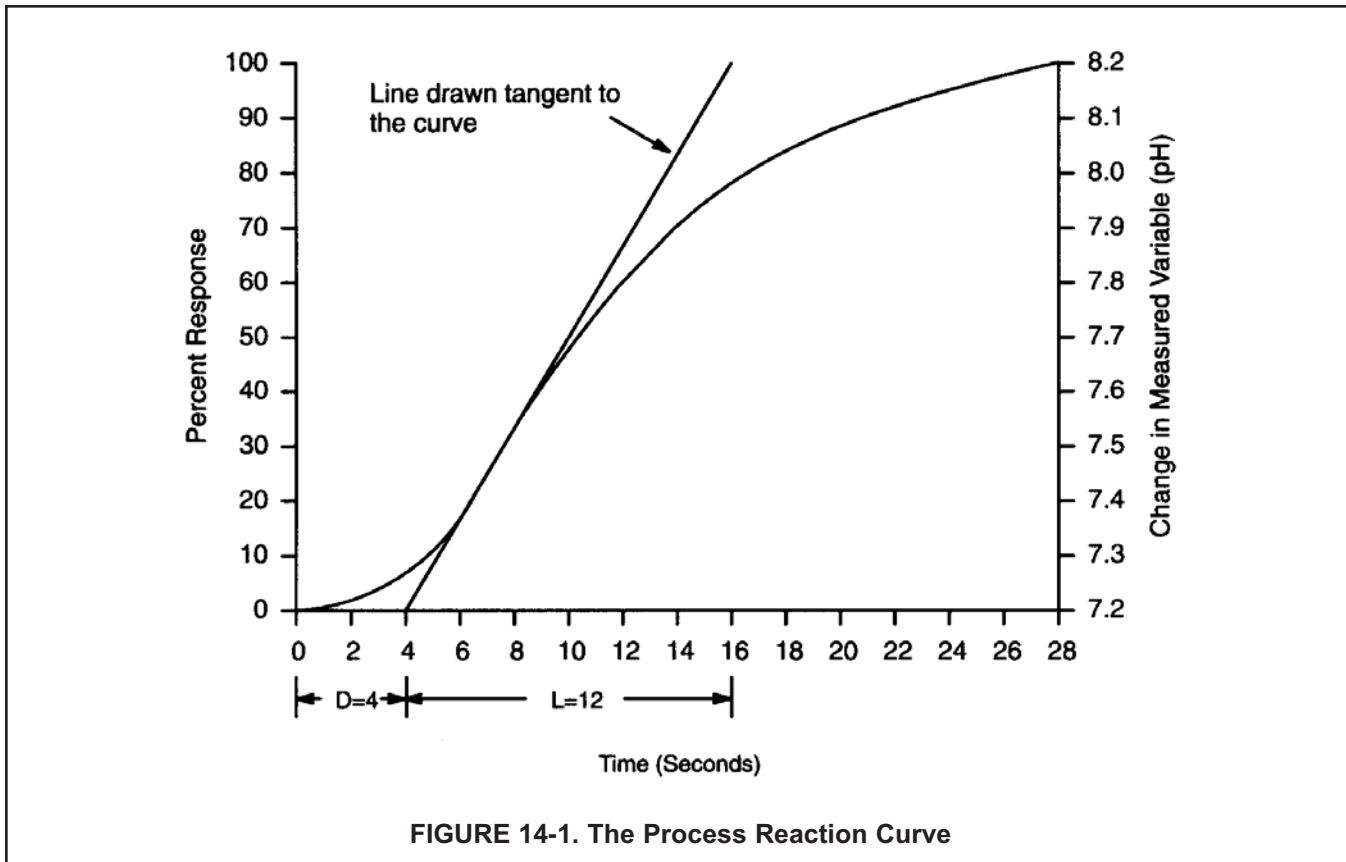

FIGURE 14-1. The Process Reaction Curve

6. When sufficient data have been collected, return the output signal to its original value using the simulate test function. Maintain the controller in this manual mode until you are ready to initiate automatic PID control, after you have calculated the tuning constants.

Once these steps are completed, the resulting process reaction curve is used to obtain information about the overall dynamics of the system. It will be used to calculate the needed tuning parameters of the Model 54eA controller.

NOTE

The tuning procedure outlined below is adapted from "Instrumentation and Process Measurement and Control", by Norman A. Anderson, Chilton Co., Radnor, Pennsylvania, ©1980.

Information derived from the process reaction curve will be used with the following empirical formulas to predict the optimum settings for proportional and integral tuning parameters.

Four quantities are determined from the process reaction curve for use in the formulas: time delay (D), time period (L), a ratio of these two (R), and plant gain (C).

A line is drawn on the process reaction curve tangent to the curve at point of maximum rise (slope) as shown in Figure 14-1. The Time Delay (D), or lag time, extends from "zero time" on the horizontal axis to the point where the tangent line intersects the time axis. The Response Time period (L), extends from the end of delay period to the time at which the tangent line intersects the 100% reaction completion line representing the process stabilization value. The ratio (R) of the Response Time period to the Time Delay describes the dynamic behavior of the system.

In the example, the process Delay Time (D) was four seconds and the Response Time period (L) was 12 seconds, so:

$$R = \frac{L}{D} = \frac{12 \text{ seconds}}{4 \text{ seconds}} = 3$$

The last parameter used in the equations is a plant gain (C). The plant gain is defined as a percent change in the controlled variable divided by the percent change in manipulated variable; in other words, the change in the measured variable (pH, conductivity, temperature) divided by the percent change in the analog output signal.

The percent change in the controlled variable is defined as the change in the measured variable (pH,

concentration, temperature) compared to the measurement range, the difference between the 20 mA (Hi) and 4 (or 0) mA (Lo) setpoints, which you determined when configuring the analog output.

In the example shown in Figure 14-1:

The percent change in pH was:

$$\frac{\text{pH}_2 - \text{pH}_1}{\text{pH "Hi"} - \text{pH "Lo"}} \times 100\% = \frac{8.2 - 7.2 \text{ pH}}{9.0 - 6.0 \text{ pH}} = 33.3\%$$

The change in the output signal was:

$$\frac{6 - 4 \text{ milliamps}}{20 - 4} \times 100\% = 12.5\%$$

So the Plant Gain is:

$$C = \frac{33.3}{12.5} = 2.66$$

Once R and C are calculated, the proportional and integral bands can be determined as follows:

$$\text{Proportional band (\%)} = P = 286 \frac{C}{R}$$

$$\text{Integral Time (seconds per repeat)} = I = 3.33 \times D \times C$$

So for the example:

$$P = \frac{286 (2.66)}{3} = 254\%$$

$$I = 3.33 (4 \text{ sec.}) 2.66 = 36 \text{ seconds}$$

To enter these parameters, use the procedure detailed in Section 5.6.

14.2 TIME PROPORTIONAL CONTROL (TPC) MODE (Code -20)

In the TPC mode, you must establish the following parameters which will determine how the Model 54eA controller responds to your system (see Section 5.7):

- Setpoint
- Time period
- URV point (or 100% on)
- LRV point (or 0% on)
- Proportional
- Integral
- Derivative

The following describes how TPC works. In the example, pH is to be controlled.

The setpoint is the pH you want to control the process to. Time period is programmed in seconds and defines the interval during which the controller compares the pH input from the sensor with the setpoint. In the TPC mode the controller divides the period up into pump on-time (feed time) and pump off-time (blend time).

The URV setting determines how far the pH must deviate from the setpoint to get the pump to be on for the entire period. The LRV setting determines how close the pH must be to the setpoint for the pump to be off for the entire period. The LRV setting should always be set at zero. When the error (the pH minus the setpoint) is between the URV and LRV values, the relay will be energized for some portion of the time period. As the pH value approaches the setpoint, the pump will be feeding for shorter and shorter intervals, and the chemicals will be allowed to mix for longer and longer intervals of the period. This relationship is illustrated in Figure 14-3.

The exact amount of on time and off time per period is determined by the settings for proportional, integral, and derivative bands. The proportional band (P) in % is a separate adjustment that narrows (or widens) the range of the TPC 0-100% action. Smaller values are used for more control response. For a setpoint of 7 pH, a URV of 2 pH, and P=100%, a pH reading of 8 would result in a relay on $(8-7)/((2-0)*(100\%))$ or 50% of the time. If P was changed to 50%, the same relay would be on $(8-7)/((2-0)*50\%)$ or 100% of the time.

The integral band is set in seconds and acts to increase the controller output as more time is spent away from the setpoint. A smaller value in seconds will result in faster integration response. Too low a value will result in excess oscillation.

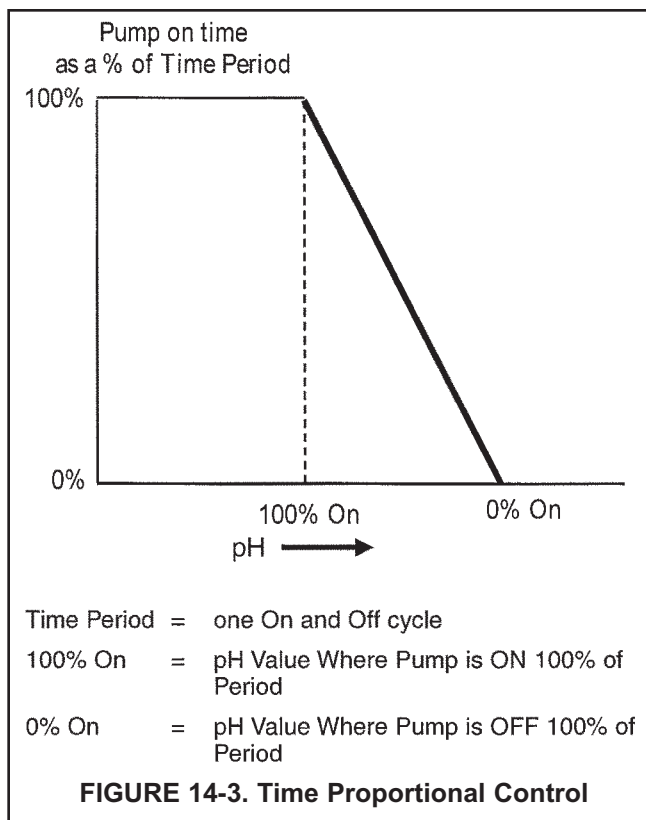

The derivative band is set in % and acts to prevent changes in the reading. This setting should generally be set to zero for pH applications.

TPC offers precise control by forcing the pump to feed chemical for shorter periods of time as you approach the desired setpoint. If the process faces a large upset, TPC mode forces the pump to feed chemical for longer periods of time as the process deviates further from the setpoint. This action continues until the pump is feeding all the time, providing a speedy recovery from large up-sets.

The controller can be programmed to be direct or reverse acting, depending on the pH (or temperature) value selected for URV. For example, if the controller is direct acting based on pH, such as in caustic chemical addition control, the pH will rise as chemical is added, so the URV value will be below the LRV (i.e. below zero). As the pH rises toward the control point value, the pump will be on for gradually less time. Conversely, if the controller is reverse-acting based on pH, such as in acid addition for control, the pH will drop as acid is added, and the URV value will be positive. The pH will fall toward the control point value, and the pump will be on for gradually less time.

Complete TPC configuration is explained and typical settings for these parameters are listed in Section 5.0. After startup, the operator needs to adjust only the 0% On to maintain the desired chemical concentration.

SECTION 15.0 TROUBLESHOOTING

15.1 OVERVIEW

The 54eA controller continuously monitors itself and the sensor for faults. When the controller detects a fault in the amperometric or pH sensor or in the instrument itself it displays a **fault message**. If alarm 4 was enabled, the red FAIL LED will also light and relay 4 will activate. The outputs will go to 22.00 mA or to the value programmed in Section 5.6.

Special rules apply to pH sensor diagnostics (high and low glass impedance). Alarm 4, the FAIL LED, and the output current failure mode will operate only if pH sensor diagnostics have been enabled. See Section 5.8.

See Section 15.2 for an explanation of fault messages and suggested corrective actions.

The controller also displays **error** and **warning messages** if a calibration is seriously in error. Refer to the section below for assistance. Each section also contains hints for correcting **other measurement and calibration problems**.

Measurement	Section
Temperature	15.3
Dissolved oxygen	15.4
Free chlorine	15.5
Total chlorine	15.6
Monochloramine	15.7
Ozone	15.8
pH	15.9

For **troubleshooting not related to measurement** problems, see Section 15.10.

To view **diagnostic variables**, go to the main display and press any key. Move the cursor to “Diagnostic variables” and press Enter (F4). Use the **↑** or **↓** key to move up or down the list.

15.2 TROUBLESHOOTING WHEN A FAULT MESSAGE IS SHOWING

Fault message	Explanation	See Section
High input current	input current exceeds 210 uA	15.2.1
Check sensor zero	sensor current was too high when sensor was zeroed	15.2.2
pH low input voltage	input voltage is less than -1400 mV	15.2.3
pH high input voltage	input voltage exceeds 1400 mV	15.2.3
pH low reference voltage	input voltage is less than -1600 mV	15.2.4
pH high reference voltage	input voltage exceeds 1600 mV	15.2.4
Old glass warning	glass impedance exceeds high limit	15.2.5
Cracked glass failure	glass impedance is less than low limit	15.2.6
Temp error low	temperature less than -15°C	15.2.7
Temp error high	temperature greater than 130°C	15.2.7
Sense line open	RTD sense line is open	15.2.8
Failure factory	instrument needs factory calibration	15.2.9
Failure eeprom	write verify error has occurred	15.2.9

15.2.1 High input current

Excessive sensor current implies that the amperometric sensor is miswired or the sensor has failed. Verify that wiring is correct, including connections through a junction box. See Section 3.3. If wiring is correct, try replacing the sensor.

15.2.2 Check sensor zero

The sensor current was extremely high when the sensor was zeroed. Refer to the calibration section for the analyte being determined for typical zero currents. Zeroing the sensor before the zero current has reached a stable minimum value will lead to low results. Allow adequate time, possibly as long as overnight, for the sensor to stabilize before starting the zero routine. Also refer to the troubleshooting section specific for the sensor. See the table in Section 15.1.

15.2.3 pH low or high input voltage

The input voltage fault message usually means there is an open connection somewhere in the wiring between the pH sensor and controller. Check wiring connections. See Section 3.3. If a junction box is being used, check the connections at the junction box, too. If wiring is correct, try replacing the sensor.

15.2.4 pH low or high reference voltage

The reference voltage fault message can mean several things: the pH sensor is no longer submerged in the process, the sensor is coated or fouled, or there is an open connection between the sensor and the controller. First, verify all electrical connections. If a junction box is being used, check the connections at the junction box, too. Verify that the pH sensor is completely submerged in the process liquid. Also, verify that the sensor is not coated with solids or oil. If the sensor looks dirty, clean it. Refer to the sensor instruction manual for details. If cleaning the sensor fails to solve the problem, replace the sensor.

15.2.5 Old glass warning

Old glass warning means the pH sensor is no longer submerged in the process or the sensor is possibly nearing the end of its useful life. First, verify that the sensor is clean and submerged in the process liquid. Also verify that the sensor can still be calibrated in buffers. Make a note of the sensor slope. If the slope is between 54 and 60 mV/unit pH, the sensor is good. If the slope is between 48 and 50 mV/unit pH, the sensor is near the end of its life. To make the warning message disappear, increase the warning limit (see Section 5.8).

15.2.6 Cracked glass failure

This fault message almost always means the pH sensor has failed and must be replaced. Before discarding the sensor, try calibrating it in buffers. If the buffer calibration is successful, the sensor is okay, but the diagnostic limit is set too high. To make the fault message disappear, lower the glass failure limit (see Section 5.8, step 6). Do not lower the impedance below 10 M Ω .

15.2.7 Temperature error low or high

Temperature error usually means the RTD (or the thermistor in the case of the Hx438 and Gx448 sensors) is open or shorted or there is an open or short in the connecting wiring. First, verify all wiring connections, including wiring connections in the junction box if one is being used. Next, disconnect the RTD IN, SENSE, and RETURN leads or the thermistor leads at the controller. Be sure to note the color of the wire and where it was attached. Measure the resistance between the RTD IN and RETURN leads. For the thermistor, measure the resistance between the two leads. The resistance should be close to the value in the table in Section 15.14.2. If the temperature element is open or shorted, the sensor should be replaced. In the meantime use manual temperature compensation.

For oxygen measurements using the Hx438, the Gx448, or other steam sterilizable sensor using a 22kNTC, temperature error high will appear if the controller was not properly configured to recognize the sensor. Verify that either "RMT Biopharm" or "SSDO other" was selected in Section 5.5.

15.2.8 Sense line open

Most Rosemount Analytical sensors use a Pt100 or a Pt1000 in a three-wire configuration (see Figure 15-4). The in and return leads connect the RTD to the measuring circuit in the analyzer. A third wire, called the sense line, is connected to the return lead. The sense line allows the analyzer to correct for the resistance of the in and return leads and to correct for changes in lead wire resistance with changes in ambient temperature. If the sense line is open, check all wiring connections, including connections at a junction box. Next, verify that the sense line is open. Disconnect the sense and return leads and measure the resistance between them. It should be less than 5Ω. If the sense line is open, replace the sensor as soon as possible.

The analyzer can be operated with the sense line open. The measurement will be less accurate because the analyzer can no longer compensate for lead wire resistance. However, if the sensor is to be used at approximately constant ambient temperature, the lead wire resistance error can be eliminated by calibrating the sensor at the measurement temperature. Errors caused by changes in resistance with changes in ambient temperature cannot be eliminated. To make the error message disappear, connect the RTD sense and return terminal with a jumper.

15.2.9 Failure factory and Failure eeprom

Turn the power off, wait about 30 sec, then turn the power back on. If the error message does not clear, call the factory. In the United States, call (800) 854-8257. Outside the United States, call (949) 757-8500.

15.3 TROUBLESHOOTING WHEN NO FAULT MESSAGE IS SHOWING - TEMPERATURE

15.3.1 Temperature measured by standard was more than 1°C different from controller.

- A. Is the standard thermometer, RTD, or thermistor accurate? General purpose liquid-in-glass thermometers, particularly ones that have been mistreated, can have surprisingly large errors.
- B. Is the temperature element in the sensor completely submerged in the liquid?
- C. Is the standard temperature sensor submerged to the correct level?

15.4 TROUBLESHOOTING WHEN NO FAULT MESSAGE IS SHOWING - OXYGEN

Problem	See Section
Zero current was accepted, but current is greater than the value in the table in Section 7.2	15.4.1
Error or warning message while zeroing the sensor (zero current is too high)	15.4.1
Zero reading is unstable	15.4.2
Sensor can be calibrated, but current is outside the range in the table in Section 7.3	15.4.3
Possible error warning during air calibration	15.4.3
Possible error warning during in-process calibration	15.4.4
Barometric pressure reading is too high or too low	15.4.5
Process readings are erratic	15.4.6
Readings drift	15.4.7
Sensor does not respond to changes in oxygen level	15.4.8
Readings are too low	15.4.9

15.4.1 Zero current is too high

- A. Is the sensor properly wired to the analyzer? See Section 3.3.
- B. Is the membrane completely covered with zero solution and are air bubbles not trapped against the membrane? Swirl and tap the sensor to release air bubbles.
- C. Is the zero solution fresh and properly made? Zero the sensor in a solution of 5% sodium sulfite in water. Prepare the solution immediately before use. It has a shelf life of only a few days.
- D. If the sensor is being zeroed with nitrogen gas, verify that the nitrogen is oxygen-free and the flow is adequate to prevent back-diffusion of air into the chamber.
- E. The major contributor to the zero current is dissolved oxygen in the electrolyte solution inside the sensor. A long zeroing period usually means that an air bubble is trapped in the electrolyte. To ensure the 499ADO or 499A TrDO sensor contains no air bubbles, carefully follow the procedure in the sensor manual for filling the sensor. If the electrolyte solution has just been replaced, allow several hours for the zero current to stabilize. On rare occasions, the sensor may require as long as overnight to zero.
- F. Check the membrane for damage and replace the membrane if necessary

15.4.2 Zero reading is unstable.

- A. Is the sensor properly wired to the analyzer? See Section 3.3. Verify that all wiring connections are tight.
- B. Readings are often erratic when a new or rebuilt sensor is first placed in service. Readings usually stabilize after an hour.
- C. Is the space between the membrane and cathode filled with electrolyte solution and is the flow path between the electrolyte reservoir and the membrane clear? Often the flow of electrolyte can be started by simply holding the sensor with the membrane end pointing down and sharply shaking the sensor a few times as though shaking down a clinical thermometer. If shaking does not work, perform the checks below. Refer to the sensor instruction manuals for additional information.

For 499ADO and 499A TrDO sensors, verify that the holes at the base of the cathode stem are open (use a straightened paperclip to clear the holes). Also verify that air bubbles are not blocking the holes. Fill the reservoir and establish electrolyte flow to the cathode. Refer to the sensor instruction manual for the detailed procedure.

For Gx438 and Hx438 sensors, the best way to ensure that there is an adequate supply of electrolyte solution is to simply add fresh electrolyte solution to the sensor. Refer to the sensor instruction manual for details.

15.4.3 Sensor can be calibrated, but current in air is too high or too low

- A. Is the sensor properly wired to the analyzer? See Section 3.3. Verify that all connections are tight.
- B. Is the membrane dry? The membrane must be dry during air calibration. A droplet of water on the membrane during air calibration will lower the sensor current and cause an inaccurate calibration.
- C. If the sensor current in air is very low and the sensor is new, either the electrolyte flow has stopped or the membrane is torn or loose. For instructions on how to restart electrolyte flow see Section 15.4.2 or refer to the sensor instruction manual. To replace a torn membrane, refer to the sensor instruction manual.
- D. Is the temperature low? Sensor current is a strong function of temperature. The sensor current decreases about 3% for every °C drop in temperature.
- E. Is the membrane fouled or coated? A dirty membrane inhibits diffusion of oxygen through the membrane, reducing the sensor current. Clean the membrane by rinsing it with a stream of water from a wash bottle or by gently wiping the membrane with a soft tissue. If cleaning the membrane does not improve the sensor response, replace the membrane and electrolyte solution. If necessary, polish the cathode. See the sensor instruction sheet for more information.

15.4.4 Possible error warning during in-process calibration

This error warning appears if the current process reading and the reading it is being changed to, ie, the reading from the standard instrument, are appreciably different.

- A. Is the standard instrument properly zeroed and calibrated?
- B. Are the standard and process sensor measuring the same sample? Place the sensors as close together as possible.
- C. Is the process sensor working properly? Check the response of the process sensor in air and in sodium sulfite solution.

15.4.5 Barometric pressure reading is too high or too low.

- A. Is the pressure inside the enclosure equal to ambient pressure? The pressure sensor is inside the controller enclosure. When cable glands are in place and the front panel is tightly closed, the enclosure is moderately airtight. Therefore, as the air trapped in the enclosure heats or cools, the pressure inside the enclosure may be different from ambient. Open the front door to equalize the pressure.
- B. If equalizing the pressure does not solve the problem, the pressure sensor is out of calibration. Calibrate the sensor against the **local** barometric pressure. Be sure to use the actual barometric pressure. Pressure, sometimes called altimeter, from a local airport or pressure from a weather forecasting service is usually corrected to sea level. It is not the actual barometric pressure.

15.4.6 Process readings are erratic.

- A. Readings are often erratic when a new sensor or a rebuilt sensor is first placed in service. The current usually stabilizes after a few hours.
- B. Is the sample flow within the recommended range? High sample flow may cause erratic readings. Refer to the sensor instruction manual for recommended flow rates.
- C. Gas bubbles impinging on the membrane may cause erratic readings. Orienting the sensor at an angle away from vertical may reduce the noise.
- D. The holes between the membrane and electrolyte reservoir might be plugged (applies to Models 499A DO and 499A TrDO sensors only). Refer to Section 15.4.2.
- E. Verify that wiring is correct. Pay particular attention to shield and ground connections.
- F. Is the membrane in good condition and is the sensor filled with electrolyte solution? Replace the fill solution and electrolyte. Refer to the sensor instruction manual for details.

15.4.7 Readings drift.

- A. Is the sample temperature changing? Membrane permeability is a function of temperature. For the 499ADO and 499ATrDO sensors, the time constant for response to a temperature change is about 5 minutes. Therefore, the reading may drift for a while after a sudden temperature change. The time constant for the Gx438 and Hx448 sensors is much shorter; these sensors respond fairly rapidly to temperature changes.
- B. Is the membrane clean? For the sensor to work properly oxygen must diffuse freely through the membrane. A coating on the membrane will interfere with the passage of oxygen, resulting in slow response.
- C. Is the sensor in direct sunlight? If the sensor is in direct sunlight during air calibration, readings will drift as the sensor warms up. Because the temperature reading lags the true temperature of the membrane, calibrating the sensor in direct sunlight may introduce an error.
- D. Is the sample flow within the recommended range? Gradual loss of sample flow will cause downward drift.
- E. Is the sensor new or has it been recently serviced? New or rebuilt sensors may require several hours to stabilize.

15.4.8 Sensor does not respond to changes in oxygen level.

- A. If readings are being compared with a portable laboratory instrument, verify that the laboratory instrument is working.
- B. Is the membrane clean? Clean the membrane and replace it if necessary. Check that the holes at the base of the cathode stem are open. Use a straightened paper clip to clear blockages. Replace the electrolyte solution.
- C. Replace the sensor.

15.4.9 Oxygen readings are too low.

- A. Low readings can be caused by zeroing the sensor before the residual current has reached a stable minimum value. Residual current is the current the sensor generates even when no oxygen is in the sample. Because the residual current is subtracted from subsequent measured currents, zeroing before the current is a minimum can lead to low results. Example: the true residual (zero) current for a 499ADO sensor is 0.05 μA , and the sensitivity based on calibration in water-saturated air is 2.35 $\mu\text{A/ppm}$. Assume the measured current is 2.00 μA . The true concentration is $(2.00 - 0.05)/2.35$ or 0.83 ppm. If the sensor was zeroed prematurely when the current was 0.2 μA , the measured concentration will be $(2.00 - 0.2)/2.35$ or 0.77 ppm. The error is 7.2%. Suppose the measured current is 5.00 μA . The true concentration is 2.11 ppm, and the measured concentration is 2.05 ppm. The error is now 3.3%. The absolute difference between the readings remains the same, 0.06 ppm.
- B. Sensor response depends on flow. If the flow is too low, readings will be low and flow sensitive. Verify that the flow past the sensor equals or exceeds the minimum value. See the sensor instruction manual for recommended flows. If the sensor is in an aeration basin, move the sensor to an area where the flow or agitation is greater.

15.5 TROUBLESHOOTING WHEN NO FAULT MESSAGE IS SHOWING - FREE CHLORINE

Problem	See Section
Zero current was accepted, but the current is outside the range -10 to 10 nA	15.5.1
Error or warning message appears while zeroing the sensor (zero current is too high)	15.5.1
Zero current is unstable	15.5.2
Sensor can be calibrated, but the current is less than about 250 nA/ppm at 25°C and pH 7	15.5.3
Process readings are erratic	15.5.4
Readings drift	15.5.5
Sensor does not respond to changes in chlorine level	15.5.6
Chlorine reading spikes following rapid change in pH	15.5.7
Chlorine readings are too low	15.5.8

15.5.1 Zero current is too high

- A. Is the sensor properly wired to the controller. See Section 3.3.
- B. Is the zero solution chlorine-free? Take a sample of the solution and test it for free chlorine level. The concentration should be less than 0.02 ppm.
- C. Has adequate time been allowed for the sensor to reach a minimum stable residual current? It may take several hours, sometimes as long as overnight, for a new sensor to stabilize.
- D. Check the membrane for damage and replace it if necessary.

15.5.2 Zero current is unstable

- A. Is the sensor properly wired to the analyzer? See Section 3.3. Verify that all wiring connections are tight.
- B. Readings are often erratic when a new or rebuilt sensor is first placed in service. Readings usually stabilize after about an hour.
- C. Is the conductivity of the zero solution greater than 50 $\mu\text{S}/\text{cm}$? **DO NOT USE DEIONIZED OR DISTILLED WATER TO ZERO THE SENSOR.** The zero solution should contain at least 0.5 grams of sodium chloride per liter.
- D. Is the space between the membrane and cathode filled with electrolyte solution and is the flow path between the electrolyte reservoir and membrane clear? Often the flow of electrolyte and be started by simply holding the sensor with the membrane end pointing down and sharply shaking the sensor a few times as though shaking down a clinical thermometer.

If shaking does not work, try clearing the holes around the cathode stem. Hold the sensor with the membrane end pointing up. Unscrew the membrane retainer and remove the membrane assembly. Be sure the wood ring remains with the membrane assembly. Use the end of a straightened paper clip to clear the holes at the base of the cathode stem. Replace the membrane.

Verify that the sensor is filled with electrolyte solution. Refer to the sensor instruction manual for details.

15.5.3 Sensor can be calibrated, but the current is too low

- A. Is the temperature low or is the pH high? Sensor current is a strong function of pH and temperature. The sensor current decreases about 3% for every °C drop in temperature. Sensor current also decreases as pH increases. Above pH 7, a 0.1 unit increase in pH lowers the current about 5%.
- B. Sensor current depends on the rate of sample flow past the sensor tip. If the flow is too low, chlorine readings will be low. Refer to the sensor instruction sheet for recommended sample flows.
- C. Low current can be caused by lack of electrolyte flow to the cathode and membrane. See step D in Section 15.5.2.
- D. Is the membrane fouled or coated? A dirty membrane inhibits diffusion of free chlorine through the membrane, reducing the sensor current and increasing the response time. Clean the membrane by rinsing it with a stream of water from a wash bottle. **DO NOT** use a membrane or tissue to wipe the membrane.
- E. If cleaning the membrane does not improve the sensor response, replace the membrane and electrolyte solution. If necessary, polish the cathode. See the sensor instruction sheet for details.

15.5.4 Process readings are erratic

- A. Readings are often erratic when a new sensor or a rebuilt sensor is first placed in service. The current usually stabilizes after a few hours.
- B. Is the sample flow within the recommended range? High sample flow may cause erratic readings. Refer to the sensor instruction sheet for recommended flow rates.
- C. Are the holes between the membrane and the electrolyte reservoir open. Refer to Section 15.5.2.
- D. Verify that wiring is correct. Pay particular attention to shield and ground connections.
- E. If automatic pH correction is being used, check the pH reading. If the pH reading is noisy, the chlorine reading will also be noisy. If the pH sensor is the cause of the noise, use manual pH correction until the problem with the pH sensor can be corrected.
- F. Is the membrane in good condition and is the sensor filled with electrolyte solution? Replace the fill solution and electrolyte. Refer to the sensor instruction manual for details.

15.5.5 Readings drift

- A. Is the sample temperature changing? Membrane permeability is a function of temperature. The time constant for the 499ACL-01 sensor is about five minutes. Therefore, the reading may drift for a while after a sudden temperature change.
- B. Is the membrane clean? For the sensor to work properly, chlorine must diffuse freely through the membrane. A coating on the membrane will interfere with the passage of chlorine, resulting in slow response. Clean the membrane by rinsing it with a stream of water from a wash bottle. **DO NOT** use a membrane or tissue to wipe the membrane.
- C. Is the sample flow within the recommended range? Gradual loss of sample flow will cause a downward drift.
- D. Is the sensor new or has it been recently serviced? New or rebuilt sensors may require several hours to stabilize.
- E. Is the pH of the process changing? If manual pH correction is being used, a gradual change in pH will cause a gradual change in the chlorine reading. As pH increases, chlorine readings will decrease, even though the free chlorine level (as determined by a grab sample test) remained constant. If the pH change is no more than about 0.2, the change in the chlorine reading will be no more than about 10% of reading. If the pH changes are more than 0.2, use automatic pH correction.

15.5.6 Sensor does not respond to changes in chlorine level.

- A. Is the grab sample test accurate? Is the grab sample representative of the sample flowing to the sensor?
- B. Is the pH compensation correct? If the controller is using manual pH correction, verify that the pH value in the controller equals the actual pH to within ± 0.1 pH. If the controller is using automatic pH correction, check the calibration of the pH sensor.
- C. Is the membrane clean? Clean the membrane and replace it if necessary. Check that the holes at the base of the cathode stem are open. Use a straightened paper clip to clear blockages. Replace the electrolyte solution.
- D. Replace the sensor.

15.5.7 Chlorine readings spike following sudden changes in pH (automatic pH correction).

Changes in pH alter the relative amounts of hypochlorous acid (HOCl) and hypochlorite ion (OCl⁻) in the sample. Because the sensor responds only to HOCl, an increase in pH causes the sensor current (and the apparent chlorine level) to drop even though the actual free chlorine concentration remained constant. To correct for the pH effect, the controller automatically applies a correction. Generally, the pH sensor responds faster than the chlorine sensor. After a sudden pH change, the controller will temporarily over-compensate and gradually return to the correct value. The time constant for return to normal is about 5 minutes.

15.5.8 Chlorine readings are too low.

- A. Was the sample tested as soon as it was taken? Chlorine solutions are unstable. Test the sample immediately after collecting it. Avoid exposing the sample to sunlight.
- B. Low readings can be caused by zeroing the sensor before the residual current has reached a stable minimum value. Residual current is the current the sensor generates even when no chlorine is in the sample. Because the residual current is subtracted from subsequent measured currents, zeroing before the current is a minimum can lead to low results.

Example: The true residual current for a free chlorine sensor is 4 nA, and the sensitivity is 350 nA/ppm. Assume the measured current is 200 nA. The true concentration is $(200-4)/350$ or 0.56 ppm. If the sensor was zeroed prematurely when the current was 10 nA, the measured concentration will be $(200-10)/350$ or 0.54 ppm. The error is 3.6%. Suppose the measured current is 400 nA. The true concentration is 1.13 ppm, and the measured concentration is 1.11 ppm. The error is now 1.8%. The absolute difference between the reading remains the same, 0.02 ppm.

- C. Sensor response depends on flow. If the flow is too low, readings will be low and flow sensitive. Verify that the flow past the sensor equals or exceeds the minimum value. See the sensor instruction manual for recommended flows.

15.6 TROUBLESHOOTING WHEN NO FAULT MESSAGE IS SHOWING - TOTAL CHLORINE

Refer to the instruction manual for the SCS921 for a complete troubleshooting guide.

15.7 TROUBLESHOOTING WHEN NO ERROR MESSAGE IS SHOWING — MONOCHLORAMINE

Problem	See Section
Zero current was accepted, but the current is outside the range -10 to 50 nA	15.7.1
Error or warning message appears while zeroing the sensor (zero current is too high)	15.7.1
Zero current is unstable	15.7.2
Sensor can be calibrated, but the current is less than about 350 nA/ppm at 25°C	15.7.3
Process readings are erratic	15.7.4
Readings drift	15.7.5
Sensor does not respond to changes in monochloramine level	15.7.6
Readings are too low	15.7.7

15.7.1 Zero current is too high

- A. Is the sensor properly wired to the analyzer? See Section 3.3.
- B. Is the zero solution monochloramine-free? Take a sample of the solution and test it for monochloramine level. The concentration should be less than 0.02 ppm.
- C. Has adequate time been allowed for the sensor to reach a minimum stable residual current? It may take several hours, sometimes as long as overnight, for a new sensor to stabilize.
- D. Check the membrane for damage and replace it if necessary. Be careful not to touch the membrane or cathode. Touching the cathode mesh may damage it.

15.7.2 Zero current is unstable

- A. Is the sensor properly wired to the analyzer? See Section 3.3. Verify that all wiring connections are tight.
- B. Readings are often erratic when a new or rebuilt sensor is first placed in service. Readings usually stabilize after about an hour.
- C. Is the conductivity of the zero solution greater than 50 $\mu\text{S}/\text{cm}$? DO NOT USE DEIONIZED OR DISTILLED WATER TO ZERO THE SENSOR. The zero solution should contain at least 0.5 grams of sodium chloride per liter.
- D. Is the space between the membrane and cathode mesh filled with electrolyte solution? Often the flow of electrolyte and be started by simply holding the sensor with the membrane end pointing down and sharply shaking the sensor a few times as though shaking down a clinical thermometer.

Verify that the sensor is filled with electrolyte solution. Refer to the sensor instruction manual for details.

15.7.3 Sensor can be calibrated, but the current is too low

- A. Is the temperature low? The sensor current decreases about 5% for every °C drop in temperature.
- B. Sensor current depends on the rate of sample flow past the sensor tip. If the flow is too low, monochloramine readings will be low. Refer to the sensor instruction sheet for recommended sample flows.
- C. Low current can be caused by lack of electrolyte flow to the cathode and membrane. See step D in Section 15.7.2.
- D. When was the sensor fill solution last replaced? The monochloramine sensor loses sensitivity, that is, it generates less current per ppm of monochloramine, as it operates. Gradual loss of sensitivity can usually be compensated for by calibrating the sensor weekly. After about two months, the sensitivity will have dropped to about 70% of its original value. At this point, the electrolyte solution and membrane should be replaced. Refer to the sensor instruction manual.
- E. Is the membrane fouled or coated? A dirty membrane inhibits diffusion of monochloramine through the membrane, reducing the sensor current and increasing the response time. Clean the membrane by vigorously swirling it in a beaker of water. **DO NOT** use a membrane or tissue to wipe the membrane.
- F. If cleaning the membrane does not improve the sensor response, replace the membrane and electrolyte solution. See the sensor instruction sheet for details.

15.7.4 Process readings are erratic

- A. Readings are often erratic when a new sensor or rebuilt sensor is first placed in service. The current usually stabilizes after a few hours.
- B. Is the sample flow within the recommended range? High sample flow may cause erratic readings. Refer to the sensor instruction sheet for recommended flow rates.
- C. Verify that wiring is correct. Pay particular attention to shield and ground connections.
- D. Is the membrane in good condition and is the sensor filled with electrolyte solution? Replace the fill solution and electrolyte. Refer to the sensor instruction manual for details.

15.7.5 Readings drift

- A. Is the sample temperature changing? Membrane permeability is a function of temperature. The time constant for the sensor is about five minutes. Therefore, the reading may drift for a while after a sudden temperature change.
- B. Is the membrane clean? For the sensor to work properly, monochloramine must diffuse freely through the membrane. A coating on the membrane will interfere with the passage of monochloramine, resulting in slow response. Clean the membrane by vigorously swirling it in a beaker of water. **DO NOT** use a membrane or tissue to wipe the membrane.
- C. Is the sample flow within the recommended range? Gradual loss of sample flow will cause a downward drift.
- D. Is the sensor new or has it been recently serviced? New or rebuilt sensors may require several hours to stabilize.
- E. Gradual downward drift is caused by depletion of the fill solution. Normally, calibrating the sensor every week adequately compensates for the drift. After the sensor has been in service for several months, it will probably be necessary to replace the fill solution and membrane. Refer to the sensor instruction manual for details.

15.7.6 Sensor does not respond to changes in monochloramine level.

- A. Is the grab sample test accurate? Is the grab sample representative of the sample flowing to the sensor?
- B. When was the sensor fill solution last replaced? The monochloramine sensor loses sensitivity, that is, it generates less current per ppm of monochloramine, as it operates. After about two months, the sensitivity will have dropped to about 70% of its original value. If the fill solution is extremely old, the sensor may be completely non-responsive to monochloramine. Replace the fill solution and membrane. See the sensor instruction manual for details.
- C. Is the membrane clean? Clean the membrane with a stream of water and replace it if necessary.
- D. Replace the sensor.

15.7.7 Readings are too low.

- A. Was the sample tested as soon as it was taken? Monochloramine solutions are moderately unstable. Test the sample immediately after collecting it. Avoid exposing the sample to sunlight.
- B. When was the sensor fill solution last replaced? The monochloramine sensor loses sensitivity, that is, it generates less current per ppm of monochloramine, as it operates. Generally, calibrating the sensor every week compensates for the gradual loss in sensitivity. After about two months, the sensitivity will have dropped to about 70% of its original value. At this point, the electrolyte solution and membrane should be replaced. Refer to the sensor instruction manual.
- C. Low readings can be caused by zeroing the sensor before the residual current has reached a stable minimum value. Residual current is the current the sensor generates even when no monochloramine is in the sample. Because the residual current is subtracted from subsequent measured currents, zeroing before the current is a minimum can lead to low results.

Example: The true residual current for a monochloramine sensor is 20 nA, and the sensitivity is 400 nA/ppm. Assume the measured current is 600 nA. The true concentration is $(600-20)/400$ or 1.45 ppm. If the sensor was zeroed prematurely when the current was 40 nA, the measured concentration will be $(600-40)/400$ or 1.40 ppm. The error is 3.5%. Suppose the measured current is 800 nA. The true concentration is 1.95 ppm, and the measured concentration is 1.90 ppm. The error is now 2.6%. The absolute difference between the reading remains the same, 0.05 ppm.

- D. Sensor response depends on flow. If the flow is too low, readings will be low and flow sensitive. Verify that the flow past the sensor equals or exceeds the minimum value. See the sensor instruction manual for recommended flows.

15.8 TROUBLESHOOTING WHEN NO FAULT MESSAGE IS SHOWING - OZONE

Problem	See Section
Zero current was accepted, but the current is outside the range -10 to 10 nA	15.8.1
Error or warning message appears while zeroing the sensor (zero current is too high)	15.8.1
Zero current is unstable	15.8.2
Sensor can be calibrated, but the current is less than about 350 nA/ppm at 25°C	15.8.3
Process readings are erratic	15.8.4
Readings drift	15.8.5
Sensor does not respond to changes in ozone level	15.8.6
Ozone readings are too low	15.8.7

15.8.1 Zero current is too high

- A. Is the sensor properly wired to the controller. See Section 3.3.
- B. Is the zero solution ozone free? Test the zero solution for ozone level. The concentration should be less than 0.02 ppm.
- C. Has adequate time been allowed for the sensor to reach a minimum stable residual current? It may take several hours, sometimes as long as overnight, for a new sensor to stabilize.
- D. Check the membrane for damage and replace it if necessary.

15.8.2 Zero current is unstable

- A. Is the sensor properly wired to the analyzer? See Section 3.3. Verify that all wiring connections are tight.
- B. Readings are often erratic when a new or rebuilt sensor is first placed in service. Readings usually stabilize after about an hour.
- C. Is the space between the membrane and cathode filled with electrolyte solution and is the flow path between the electrolyte reservoir and membrane clear? Often the flow of electrolyte can be started by simply holding the sensor with the membrane end pointing down and sharply shaking the sensor a few times as though shaking down a clinical thermometer.

If shaking does not work, try clearing the holes around the cathode stem. Hold the sensor with the membrane end pointing up. Unscrew the membrane retainer and remove the membrane assembly. Be sure the wood ring remains with the membrane assembly. Use the end of a straightened paper clip to clear the holes at the base of the cathode stem. Replace the membrane.

Verify that the sensor is filled with electrolyte solution. Refer to the sensor instruction manual for details.

15.8.3 Sensor can be calibrated, but the current is too low

- A. Sensor current is a strong function of temperature. The sensor current decreases about 3% for every °C drop in temperature.
- B. Sensor current depends on the rate of sample flow past the sensor tip. If the flow is too low, ozone readings will be low. Refer to the sensor instruction sheet for recommended sample flows.
- C. Low current can be caused by lack of electrolyte flow to the cathode and membrane. See step C in Section 15.8.2.
- D. Is the membrane fouled or coated? A dirty membrane inhibits diffusion of ozone through the membrane, reducing the sensor current and increasing the response time. Clean the membrane by rinsing it with a stream of water from a wash bottle or gently wipe the membrane with a soft tissue.

If cleaning the membrane does not improve the sensor response, replace the membrane and electrolyte solution. If necessary, polish the cathode. See the sensor instruction sheet for details.

15.8.4 Process readings are erratic

- A. Readings are often erratic when a new sensor or a rebuilt sensor is first placed in service. The current usually stabilizes after a few hours.
- B. Is the sample flow within the recommended range? High sample flow may cause erratic readings. Refer to the sensor instruction sheet for recommended flow rates.
- C. Are the holes between the membrane and the electrolyte reservoir open. Refer to Section 15.8.2.
- D. Verify that wiring is correct. Pay particular attention to shield and ground connections.
- E. Is the membrane in good condition and is the sensor filled with electrolyte solution? Replace the fill solution and electrolyte. Refer to the sensor instruction manual for details.

15.8.5 Readings drift

- A. Is the sample temperature changing? Membrane permeability is a function of temperature. The time constant for the 499AOZ sensor is about five minutes. Therefore, the reading may drift for a while after a sudden temperature change.
- B. Is the membrane clean? For the sensor to work properly, ozone must diffuse freely through the membrane. A coating on the membrane will interfere with the passage of ozone, resulting in slow response. Clean the membrane by rinsing it with a stream of water from a wash bottle, or gently wipe the membrane with a soft tissue.
- C. Is the sample flow within the recommended range? Gradual loss of sample flow will cause a downward drift.
- D. Is the sensor new or has it been recently serviced. New or rebuilt sensors may require several hours to stabilize.

15.8.6 Sensor does not respond to changes in ozone level.

- A. Is the grab sample test accurate? Is the grab sample representative of the sample flowing to the sensor?
- B. Is the membrane clean? Clean the membrane and replace it if necessary. Check that the holes at the base of the cathode stem are open. Use a straightened paper clip to clear blockages. Replace the electrolyte solution.
- C. Replace the sensor.

15.8.7 Ozone readings are too low.

- A. Was the sample tested as soon as it was taken? Ozone solutions are highly unstable. Test the sample immediately after collecting it.
- B. Low readings can be caused by zeroing the sensor before the residual current has reached a stable minimum value. Residual current is the current the sensor generates even when no ozone is in the sample. Because the residual current is subtracted from subsequent measured currents, zeroing before the current is a minimum can lead to low results.

Example: The true residual current for an ozone sensor is 4 nA, and the sensitivity is 350 nA/ppm. Assume the measured current is 200 nA. The true concentration is $(200-4)/350$ or 0.560 ppm. If the sensor was zeroed prematurely when the current was 10 nA, the measured concentration will be $(200-10)/350$ or 0.543 ppm. The error is 3.6%. Suppose the measured current is 100 nA. The true concentration is 0.274 ppm, and the measured concentration is 0.257 ppm. The error is now 6.2%. The absolute difference between the reading remains the same, 0.017 ppm.

- C. Sensor response depends on flow. If the flow is too low, readings will be low and flow sensitive. Verify that the flow past the sensor equals or exceeds the minimum value. See the sensor instruction manual for recommended flows.

15.9 TROUBLESHOOTING WHEN NO FAULT MESSAGE IS SHOWING - pH

Problem	See Section
Warning or error message during two-point calibration	15.9.1
Warning or error message during standardization	15.9.2
Controller will not accept manual slope	15.9.3
Sensor does not respond to known pH changes	15.9.4
Calibration was successful, but process pH is slightly different from expected value	15.9.5
Calibration was successful, but process pH is grossly wrong and/or noisy	15.9.6
Process reading is noisy	15.9.7

15.9.1 Warning or error message during two-point calibration.

Once the two-point (manual or automatic) calibration is complete, the controller automatically calculates the sensor slope (at 25°C). If the slope is less than 45 mV/pH, the controller displays a "Slope error low" message. If the slope is greater than 60 mV/pH, the controller displays a "Slope error high" message. The controller will not update the calibration. Check the following:

- A. Are the buffers accurate? Inspect the buffers for obvious signs of deterioration, such as turbidity or mold growth. Neutral and slightly acidic buffers are highly susceptible to molds. Alkaline buffers (pH 9 and greater), if they have been exposed to air for long periods, may also be inaccurate. Alkaline buffers absorb carbon dioxide from the atmosphere, which lowers the pH. If a high pH buffer was used in the failed calibration, repeat the calibration using a fresh buffer. If fresh buffer is not available, use a lower pH buffer. For example, use pH 4 and pH 7 buffer instead of pH 7 and pH 10 buffer.
- B. Was adequate time allowed for temperature equilibration? If the sensor was in a process liquid substantially hotter or colder than the buffer, place it in a container of water at ambient temperature for at least 20 minutes before starting the calibration.
- C. Were correct pH values entered during manual calibration? Using auto calibration eliminates error caused by improperly entered values.
- D. Is the sensor properly wired to the analyzer? Check sensor wiring including any connections in a junction box. See Section 3.3.
- E. Is the sensor dirty or coated? See the sensor instruction sheet for cleaning instructions.
- F. Is the sensor faulty? Check the glass impedance. From the main display, press any key to enter the main menu. Move the cursor to "Diagnostic variables". Press Enter (F4). Press the ↓ key until "Glass impeded" is showing. Refer to the table for an interpretation of the glass impedance value.

less than 10 MΩ	Glass bulb is cracked or broken. Sensor has failed.
between 10 MΩ and 1000 MΩ	Normal reading
greater than 1000 MΩ	pH sensor may be nearing the end of its service life.

- G. Is the controller faulty? The best way to check for a faulty controller is to simulate pH inputs. See Section 15.13.

15.9.2 Warning or error message during two-point calibration.

During standardization, the millivolt signal from the pH cell is increased or decreased until it agrees with the pH reading from a reference instrument. A unit change in pH requires an offset of about 59 mV. The controller limits the offset to ± 1400 mV. If the standardization causes an offset greater than ± 1400 mV, the analyzer will display the Calibration Error screen. The standardization will not be updated. Check the following:

- A. Is the referee pH meter working and properly calibrated? Check the response of the referee sensor in buffers.
- B. Is the process sensor working properly? Check the process sensor in buffers.
- C. Is the sensor fully immersed in the process liquid? If the sensor is not completely submerged, it may be measuring the pH of the liquid film covering the glass bulb and reference element. The pH of this film may be different from the pH of the bulk liquid.
- D. Is the sensor fouled? The sensor measures the pH of the liquid adjacent to the glass bulb. If the sensor is heavily fouled, the pH of liquid trapped against the bulb may be different from the bulk liquid.
- E. Has the sensor been exposed to poisoning agents (sulfides or cyanides) or has it been exposed to extreme temperature? Poisoning agents and high temperature can shift the reference voltage many hundred millivolts. To check the reference voltage, see Section 15.15.

15.9.3 Controller will not accept manual slope.

If the sensor slope is known from other sources, it can be entered directly into the controller. The controller will not accept a slope (at 25°) outside the range 45 to 60 mV/pH. If the user attempts to enter a slope less than 45 mV/pH, the controller will automatically change the entry to 45. If the user attempts to enter a slope greater than 60 mV/pH, the controller will change the entry to 60 mV/pH. See Section 15.9.1 for troubleshooting sensor slope problems.

15.9.4 Sensor does not respond to known pH changes.

- A. Did the expected pH change really occur? If the process pH reading was not what was expected, check the performance of the sensor in buffers. Also, use a second pH meter to verify the change.
- B. Is the sensor properly wired to the analyzer?
- C. Is the glass bulb cracked or broken? Check the glass electrode impedance. See Section 15.1
- D. Is the analyzer working properly. Check the analyzer by simulating the pH input.

15.9.5 Calibration was successful, but process pH is slightly different from expected value.

Differences between pH readings made with an on-line instrument and a laboratory or portable instrument are normal. The on-line instrument is subject to process variables, for example ground potentials, stray voltages, and orientation effects that may not affect the laboratory or portable instrument. To make the process reading agree with a reference instrument, see Section 12.4.

15.9.6 Calibration was successful, but process pH is grossly wrong and/or noisy.

Grossly wrong or noisy readings suggest a ground loop (measurement system connected to earth ground at more than one point), a floating system (no earth ground), or noise being brought into the analyzer by the sensor cable. The problem arises from the process or installation. It is not a fault of the analyzer. The problem should disappear once the sensor is taken out of the system. Check the following:

- A. Is a ground loop present?
 1. Verify that the system works properly in buffers. Be sure there is no direct electrical connection between the buffer containers and the process liquid or piping.
 2. Strip back the ends of a heavy gauge wire. Connect one end of the wire to the process piping or place it in the process liquid. Place the other end of the wire in the container of buffer with the sensor. The wire makes an electrical connection between the process and sensor.
 3. If offsets and noise appear after making the connection, a ground loop exists.
- B. Is the process grounded?
 1. The measurement system needs one path to ground: through the process liquid and piping. Plastic piping, fiberglass tanks, and ungrounded or poorly grounded vessels do not provide a path. A floating system can pick up stray voltages from other electrical equipment.
 2. Ground the piping or tank to a local earth ground.
 3. If noise still persists, simple grounding is not the problem. Noise is probably being carried into the instrument through the sensor wiring.
- C. Simplify the sensor wiring.
 1. First, verify that pH sensor wiring is correct. Note that it is not necessary to jumper the solution ground and reference terminals.
 2. Disconnect all sensor wires at the analyzer except pH/mV IN, REFERENCE IN, RTD IN and RTD RETURN. See the wiring diagrams in Section 3.3. If the sensor is wired to the analyzer through a remote junction box containing a preamplifier, disconnect the wires at the sensor side of the junction box.
 3. Tape back the ends of the disconnected wires to keep them from making accidental connections with other wires or terminals.
 4. Connect a jumper wire between the RTD RETURN and RTD SENSE terminals (see wiring diagrams in Section 3.3).
 5. If noise and/or offsets disappear, the interference was coming into the analyzer through one of the sensor wires. The system can be operated permanently with the simplified wiring.
- D. Check for extra ground connections or induced noise.
 1. If the sensor cable is run inside conduit, there may be a short between the cable and the conduit. Re-run the cable outside the conduit. If symptoms disappear, there is a short between the cable and the conduit. Likely a shield is exposed and touching the conduit. Repair the cable and reinstall it in the conduit.
 2. To avoid induced noise in the sensor cable, run it as far away as possible from power cables, relays, and electric motors. Keep sensor wiring out of crowded panels and cable trays.
 3. If ground loops persist, consult the factory. A visit from a technician may be required to solve the problem.

15.9.7 Process pH readings are noisy.

- A. Is the sensor dirty or fouled? Suspended solids in the sample can coat the reference junction and interfere with the electrical connection between the sensor and the process liquid. The result is often a noisy reading.
- B. Is the sensor properly wired to the analyzer? See Section 3.3.
- C. Is a ground loop present? Refer to Section 15.9.6.

15.10 TROUBLESHOOTING NOT RELATED TO MEASUREMENT PROBLEMS

Problem	Action
Display segments missing	Replace display board
Alarm relays are chattering	1. Check alarm setpoints. 2. Increase hysteresis time delay settings (see Section 5.7)
Incorrect current output	1. Verify that output load is less than 600 Ω. 2. For minor errors, trim outputs (see Section 13.0) 3. Replace power supply board
Display too light or too dark	Change contrast (see Section 5.5)
“Level 1, 2 or 3 security: Lock” shown in display	Controller has password protection (see Section 5.13)
“Hold mode activated” showing in display	Controller is in hold (see Section 5.6, steps 10 and 11)
“Simulating output 1 or 2” showing in display	Controller is simulating outputs (see Section 5.4)
“Simulating alarm 1, 2, 3 or 4” showing in display	Controller is simulating alarms (see Section 5.4)

15.11 SIMULATING INPUTS - DISSOLVED OXYGEN

To check the performance of the controller, use a decade box to simulate the current from the oxygen sensor.

- A. Disconnect the anode and cathode leads from terminals 1 and 2 on TB3 and connect a decade box as shown in Figure 15-1. It is not necessary to disconnect the RTD leads.
- B. Set the decade box to the resistance shown in the table.

Sensor	Polarizing Voltage	Resistance	Expected current
499ADO	-675 mV	34 kΩ	20 μA
499A TrDO	-800 mV	20 kΩ	40 μA
Hx438 and Gx448	-675 mV	8.4 MΩ	80 nA

- C. Note the sensor current. To view the sensor current from the main display, press any key to enter the main menu. Move the cursor to "Diagnostics" and press Enter (F4). The sensor current is the second line in the display. Note the units: μA is microamps, nA is nanoamps.
- D. Change the decade box resistance and verify that the correct current is shown. Calculate current from the equation:

$$\text{current } (\mu\text{A}) = \frac{\text{voltage (mV)}}{\text{resistance (k}\Omega\text{)}}$$

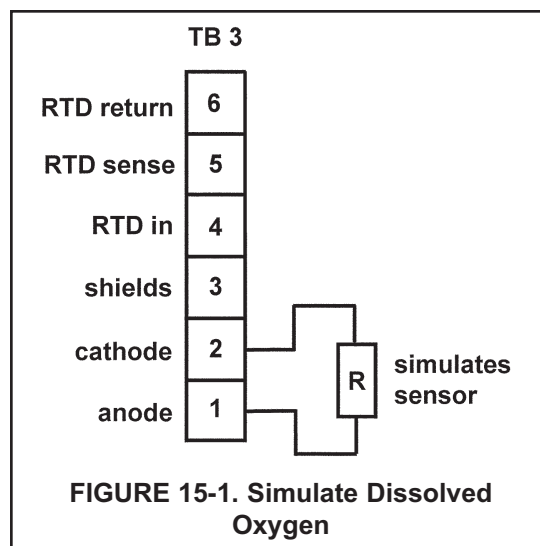

15.12 SIMULATING INPUTS - OTHER AMPEROMETRIC MEASUREMENTS

To check the performance of the controller, use a decade box and a battery to simulate the current from the sensor. The battery, which opposes the polarizing voltage, is necessary to ensure that the sensor current has the correct sign.

- A. Disconnect the anode and cathode leads from terminals 1 and 2 on TB3 and connect a decade box and battery as shown in Figure 15-2. It is not necessary to disconnect the RTD leads.
- B. Set the decade box to the resistance shown in the table.

Sensor	Polarizing Voltage	Resistance	Expected current
499ACL-01 (free chlorine)	200 mV	28 MΩ	500 nA
499ACL-02 (total chlorine)	250 mV	675 kΩ	2000 nA
499ACL-03 (monochloramine)	400 mV	3 MΩ	400 nA
499AOZ	250 mV	2.7 MΩ	500 nA

- C. Note the sensor current. It should be close to the value in the table. The actual value depends of the voltage of the battery. To view the sensor current from the main display, press any key to enter the main menu. Move the cursor to "Diagnostics" and press Enter (F4). The sensor current is the second line in the display. Note the units: μA is microamps, nA is nanoamps.
- D. Change the decade box resistance and verify that the correct current is shown. Calculate current from the equation:

$$\text{current } (\mu\text{A}) = \frac{V_{\text{battery}} - V_{\text{polarizing}} \text{ (mV)}}{\text{resistance (k}\Omega\text{)}}$$

The voltage of a fresh 1.5 volt battery is about 1.6 volt (1600 mV).

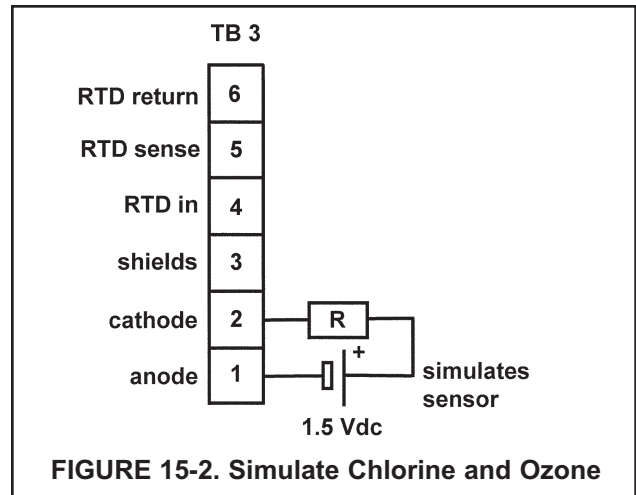

FIGURE 15-2. Simulate Chlorine and Ozone

15.13 SIMULATING INPUTS - pH

15.13.1 General

This section describes how to simulate a pH input into the controller. To simulate a pH measurement, connect a standard millivolt source to the controller. If the controller is working properly, it will accurately measure the input voltage and convert it to pH. Although the general procedure is the same, the wiring details depend on whether the preamplifier is in the sensor, a junction box, or the controller.

15.13.2 Simulating pH input when the preamplifier is in the analyzer.

1. Turn off automatic temperature correction (Section 5.9) and solution temperature correction (Section 5.8, step 8). Set the manual temperature to 25°C.
2. Disconnect the sensor, including the jumper between the ANODE and REFERENCE IN terminals, and connect a jumper wire between the pH IN and the REFERENCE IN terminals.
3. From the Diagnostics menu scroll down until the "pH input" line is showing. The pH input is the raw voltage signal in mV. The measured voltage should be 0 mV and the pH should be 7.00. Because calibration data stored in the analyzer may be offsetting the input voltage, the displayed pH may not be exactly 7.00.
4. If a standard millivolt source is available, disconnect the jumper wire between the pH IN and the REFERENCE IN terminals and connect the voltage source as shown in Figure 15-3.
5. Calibrate the controller using the procedure in Section 11.0. Use 0.0 mV for Buffer 1 (pH 7.00) and -177.4 mV for Buffer 2 (pH 10.00). If the analyzer is working properly, it should accept the calibration. The slope should be 59.16 mV/pH and the offset should be zero.
6. To check linearity, set the voltage source to the values shown in the table and verify that the pH and millivolt readings match the values in the table.

Voltage (mV)	pH (at 25°C)
295.8	2.00
177.5	4.00
59.2	6.00
-59.2	8.00
-177.5	10.00
-295.8	12.00

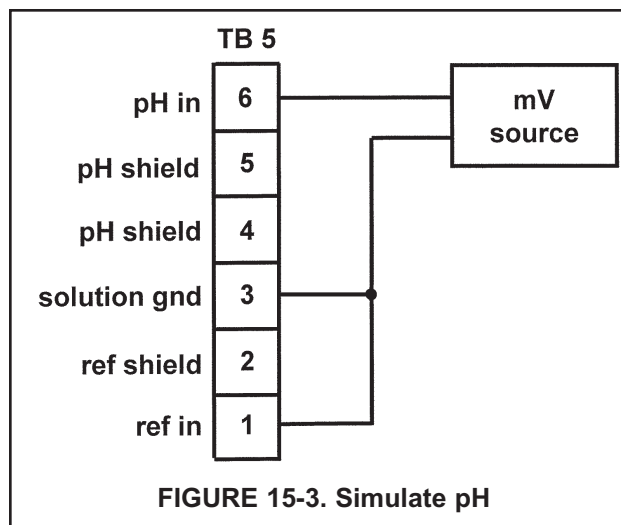

FIGURE 15-3. Simulate pH

15.13.3 Simulating pH input when the preamplifier is in a junction box.

The procedure is the same as described in Section 15.11.2. Keep the connections between the analyzer and the junction box in place. Disconnect the sensor at the sensor side of the junction box and connect the voltage source to the sensor side of the junction box. See Figure 15-3.

15.13.4 Simulating pH input when the preamplifier is in the sensor.

The preamplifier in the sensor converts the high impedance signal into a low impedance signal without amplifying it. To simulate pH values, follow the procedure in Section 15.13.2.

15.14 SIMULATING TEMPERATURE

15.14.1 General.

The 54eA controller accepts either a Pt100 RTD (for pH, 499ADO, 499ATrDO, 499ACL-01, 499ACL-02, 499ACL-03, and 499AOZ sensors) or a 22k NTC thermistor (for Hx438 and Gx448 DO sensors and most steam-sterilizable DO sensors from other manufacturers). The Pt100 RTD is in a three-wire configuration. See Figure 15-4. The 22k thermistor has a two-wire configuration.

15.14.2 Simulating temperature

To simulate the temperature input, wire a decade box to the analyzer or junction box as shown in Figure 15-5.

To check the accuracy of the temperature measurement, set the resistor simulating the RTD to the values indicated in the table and note the temperature readings. The measured temperature might not agree with the value in the table. During sensor calibration an offset might have been applied to make the measured temperature agree with a standard thermometer. The offset is also applied to the simulated resistance. The controller is measuring temperature correctly if the difference between measured temperatures equals the difference between the values in the table to within $\pm 0.1^\circ\text{C}$.

For example, start with a simulated resistance of $103.9\ \Omega$, which corresponds to 10.0°C . Assume the offset from the sensor calibration was $-0.3\ \Omega$. Because of the offset, the analyzer calculates temperature using $103.6\ \Omega$. The result is 9.2°C . Now change the resistance to $107.8\ \Omega$, which corresponds to 20.0°C . The analyzer uses $107.5\ \Omega$ to calculate the temperature, so the display reads 19.2°C . Because the difference between the displayed temperatures (10.0°C) is the same as the difference between the simulated temperatures, the analyzer is working correctly.

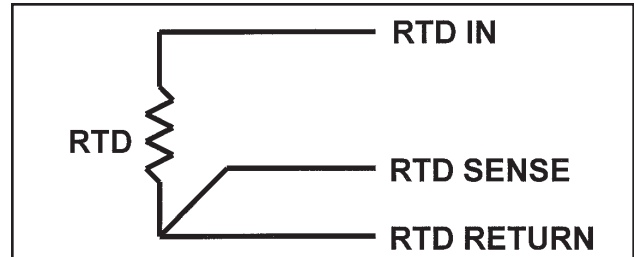

FIGURE 15-4. Three-Wire RTD Configuration.

Although only two wires are required to connect the RTD to the analyzer, using a third (and sometimes fourth) wire allows the analyzer to correct for the resistance of the lead wires and for changes in the lead wire resistance with temperature.

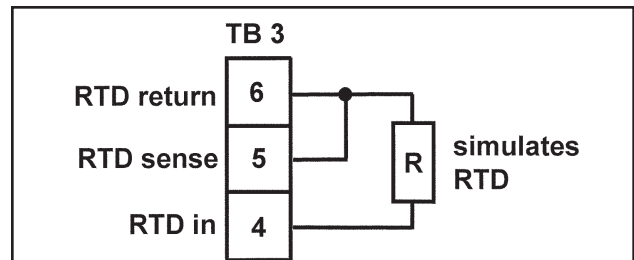

FIGURE 15-5. Simulating RTD Inputs.

The figure shows wiring connections for sensors containing a Pt 100 RTD. For sensors using a 22k NTC thermistor (Hx438 and Gx448 sensors), wire the decade box to terminals 1 and 3 on TB6.

Temp. ($^\circ\text{C}$)	Pt 100 (Ω)	22k NTC ($\text{k}\Omega$)
0	100.0	64.88
10	103.9	41.33
20	107.8	26.99
25	109.7	22.00
30	111.7	18.03
40	115.5	12.31
50	119.4	8.565
60	123.2	6.072
70	127.1	4.378
80	130.9	3.208
85	132.8	2.761
90	134.7	2.385
100	138.5	1.798

15.15 MEASURING REFERENCE VOLTAGE

Some processes contain substances that poison or shift the potential of the reference electrode. Sulfide is a good example. Prolonged exposure to sulfide converts the reference electrode from a silver/silver chloride electrode to a silver/silver sulfide electrode. The change in reference voltage is several hundred millivolts. A good way to check for poisoning is to compare the voltage of the reference electrode with a silver/silver chloride electrode known to be good. The reference electrode from a new sensor is best. See Figure 15-6. If the reference electrode is good, the voltage difference should be no more than about 20 mV. A poisoned reference electrode usually requires replacement.

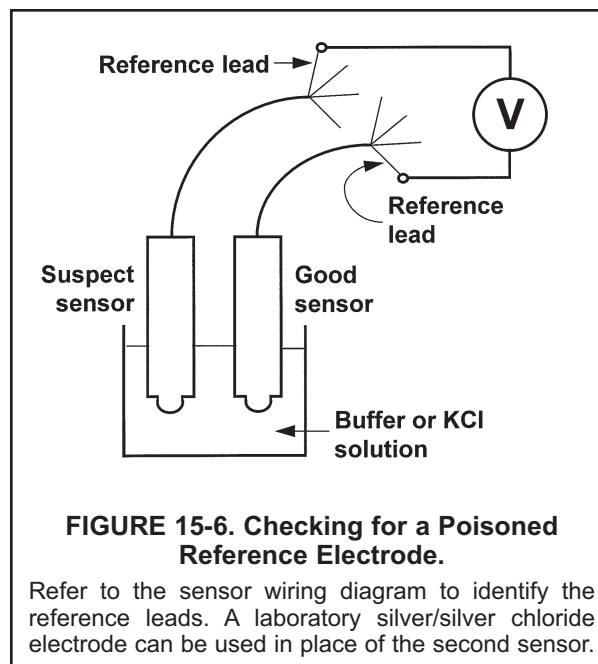

SECTION 16.0 MAINTENANCE

REPLACEMENT PARTS

PART NUMBER	DESCRIPTION
23540-05	Enclosure, Front with Keyboard
23848-00	Power Supply Circuit Board Shield
23849-00	Half Shield, Power Supply
23969-02	PCB, CPU and power supply, calibrated, 115/230 Vac
23969-06	PCB, CPU and power supply, calibrated, 24 Vdc
33281-00	Hinge Pin
33286-00	Gasket, Front Panel
33293-00	Enclosure, Rear
9010377	Back-lit Display, LCD Dot Matrix
9510048	Enclosure Conduit Plug, 1/2 inch

NOTE: Individual printed circuit boards cannot be ordered for Model 54e. Replacement boards for Model 54e are assembled and calibrated as an integrated board stack.

SECTION 17.0 RETURN OF MATERIAL

17.1 GENERAL.

To expedite the repair and return of instruments, proper communication between the customer and the factory is important. Before returning a product for repair, call 1-949-757-8500 for a Return Materials Authorization (RMA) number.

17.2 WARRANTY REPAIR.

The following is the procedure for returning instruments still under warranty:

1. Call Rosemount Analytical for authorization.
2. To verify warranty, supply the factory sales order number or the original purchase order number. In the case of individual parts or sub-assemblies, the serial number on the unit must be supplied.
3. Carefully package the materials and enclose your "Letter of Transmittal" (see Warranty). If possible, pack the materials in the same manner as they were received.
4. Send the package prepaid to:

Emerson Process Management
Liquid Division
2400 Barranca Parkway
Irvine, CA 92606

Attn: Factory Repair

RMA No. _____

Mark the package: Returned for Repair

Model No. _____

IMPORTANT

Please see second section of "Return of Materials Request" form. Compliance with the OSHA requirements is mandatory for the safety of all personnel. MSDS forms and a certification that the instruments have been disinfected or detoxified are required.

17.3 NON-WARRANTY REPAIR.

The following is the procedure for returning for repair instruments that are no longer under warranty:

1. Call Rosemount Analytical for authorization.
2. Supply the purchase order number, and make sure to provide the name and telephone number of the individual to be contacted should additional information be needed.
3. Do Steps 3 and 4 of Section 17.2.

NOTE

Consult the factory for additional information regarding service or repair.

WARRANTY

Goods and part(s) (excluding consumables) manufactured by Seller are warranted to be free from defects in workmanship and material under normal use and service for a period of twelve (12) months from the date of shipment by Seller. Consumables, pH electrodes, membranes, liquid junctions, electrolyte, O-rings, etc. are warranted to be free from defects in workmanship and material under normal use and service for a period of ninety (90) days from date of shipment by Seller. Goods, part(s) and consumables proven by Seller to be defective in workmanship and / or material shall be replaced or repaired, free of charge, F.O.B. Seller's factory provided that the goods, parts(s), or consumables are returned to Seller's designated factory, transportation charges prepaid, within the twelve (12) month period of warranty in the case of goods and part(s), and in the case of consumables, within the ninety (90) day period of warranty. This warranty shall be in effect for replacement or repaired goods, part(s) and consumables for the remaining portion of the period of the twelve (12) month warranty in the case of goods and part(s) and the remaining portion of the ninety (90) day warranty in the case of consumables. A defect in goods, part(s) and consumables of the commercial unit shall not operate to condemn such commercial unit when such goods, parts(s) or consumables are capable of being renewed, repaired or replaced.

The Seller shall not be liable to the Buyer, or to any other person, for the loss or damage, directly or indirectly, arising from the use of the equipment or goods, from breach of any warranty or from any other cause. All other warranties, expressed or implied are hereby excluded.

IN CONSIDERATION OF THE STATED PURCHASE PRICE OF THE GOODS, SELLER GRANTS ONLY THE ABOVE STATED EXPRESS WARRANTY. NO OTHER WARRANTIES ARE GRANTED INCLUDING, BUT NOT LIMITED TO, EXPRESS AND IMPLIED WARRANTIES OF MERCHANTABILITY AND FITNESS FOR A PARTICULAR PURPOSE.

RETURN OF MATERIAL

Material returned for repair, whether in or out of warranty, should be shipped prepaid to:

**Rosemount Analytical Inc.
Uniloc Division
2400 Barranca Parkway
Irvine, CA 92606**

The shipping container should be marked:

Return for Repair
Model _____

The returned material should be accompanied by a letter of transmittal which should include the following information (make a copy of the "Return of Materials Request" found on the last page of the Manual and provide the following thereon):

1. Location type of service, and length of time of service of the device.
2. Description of the faulty operation of the device and the circumstances of the failure.
3. Name and telephone number of the person to contact if there are questions about the returned material.
4. Statement as to whether warranty or non-warranty service is requested.
5. Complete shipping instructions for return of the material.

Adherence to these procedures will expedite handling of the returned material and will prevent unnecessary additional charges for inspection and testing to determine the problem with the device.

If the material is returned for out-of-warranty repairs, a purchase order for repairs should be enclosed.



*The right people,
the right answers,
right now.*

**ROSEMOUNT ANALYTICAL
CUSTOMER SUPPORT CENTER
1-800-854-8257**



Emerson Process Management

Liquid Division

2400 Barranca Parkway
Irvine, CA 92606 USA
Tel: (949) 757-8500
Fax: (949) 474-7250

<http://www.raihome.com>



ON-LINE ORDERING NOW AVAILABLE ON OUR WEB SITE
<http://www.raihome.com>

Specifications subject to change without notice.

Credit Cards for U.S. Purchases Only.

