



# QMA601

## Process Moisture Analyzer

### User's Manual



97449 Issue 3  
June 2018

Please fill out the form(s) below for each analyzer that has been purchased.

Use this information when contacting Michell Instruments for service purposes.

Analyzer	
Code	
Serial Number	
Invoice Date	
Location of Analyzer	
Tag No	

Analyzer	
Code	
Serial Number	
Invoice Date	
Location of Analyzer	
Tag No	

Analyzer	
Code	
Serial Number	
Invoice Date	
Location of Analyzer	
Tag No	



## QMA601

For Michell Instruments' contact information please go to  
[www.michell.com](http://www.michell.com)

© 2018 Michell Instruments

This document is the property of Michell Instruments Ltd. and may not be copied or otherwise reproduced, communicated in any way to third parties, nor stored in any Data Processing System without the express written authorization of Michell Instruments Ltd.

---

## Contents

Safety .....	viii
Warnings.....	viii
Electrical Safety .....	viii
Pressure Safety.....	viii
Hazardous Materials (WEEE, RoHS2 & REACH).....	viii
Calibration (Factory Validation).....	ix
Repair and Maintenance .....	ix
Abbreviations.....	x
1 INTRODUCTION .....	1
1.1 General.....	1
1.2 Theory of Operation .....	2
1.3 Sample Gas Path .....	3
2 INSTALLATION .....	4
2.1 Analyzer Storage Instructions.....	4
2.2 Unpacking the Analyzer .....	5
2.3 Lifting and Handling .....	5
2.4 Mounting the Analyzer .....	6
2.5 Hazardous Area/Location Safety .....	7
2.6 Electrical Safety.....	8
2.6.1 Equipment Ratings and Installation Details.....	8
2.6.2 Power Connection .....	10
2.6.3 Other Electrical Connections .....	11
2.7 Pressure Safety .....	12
2.8 Gas Sample Connections.....	13
3 OPERATION .....	15
3.1 General Operational Information.....	15
3.1.1 First Time Operation.....	16
3.1.2 Analyzer Set-Up .....	17
3.2 User Interface .....	18
3.2.1 Interface Controls .....	18
3.2.2 'Up/Down Arrow' Keys.....	18
3.2.3 'ENTER' Key .....	19
3.2.4 'ESC' Key .....	19
3.2.5 Pop Up Keypad .....	19
3.3 Menu Structure .....	20
3.4 Description of Measured Parameters .....	21
3.5 Main Screen .....	21
3.5.1 Large Display Mode.....	23
3.6 Main Screen Sub Menus.....	25
3.6.1 Warning Screen .....	25
3.6.2 Logging Screen.....	26
3.6.3 Alarm Screen .....	27
3.6.4 Field Calibration Screen .....	28
3.6.5 Monitor screen.....	32
3.7 Settings Menu .....	33
3.7.1 Measurement Screen.....	33
3.7.2 Outputs Screen.....	38
3.7.3 HMI Screen .....	40
3.7.4 Real Time Clock Screen .....	42
3.7.5 Software Communications Screen.....	43
3.7.6 Ethernet Screen .....	43

3.7.7	Field Calibration History .....	44
3.7.8	About Screen .....	44
3.8	Sampling Guidelines .....	46
3.9	Measurement Cycle .....	49
3.10	Calibration Cycle.....	51
4	MAINTENANCE .....	53
4.1	Safety.....	54
4.2	Removal and Replacement of the Power Supply Fuse.....	54
4.3	Replacing the Optional Contamination Trap .....	54
4.4	Removal and Replacement of the Desiccant Column.....	55
5	CALIBRATION.....	57
5.1	Traceability .....	57
6	SHIPPING .....	59
6.1	Preparation for Shipping and Packing if Not Supplied as a Sample System .....	59
7	APPLICATION SOFTWARE OVERVIEW .....	60
7.1	System Requirements .....	60
7.2	System Connection .....	60
7.3	Getting Started.....	61
7.3.1	Connection Method (Serial Connection (RS485 or TCP) .....	62
7.3.1.1	RS485 Connection.....	62
7.3.1.2	Modbus TCP Connection (Ethernet) .....	62
7.4	Main Window .....	63
7.5	Using the Chart.....	64
7.5.1	Chart Options Window.....	65
7.6	Data Logging .....	66
7.6.1	Configuring Logging Start Time.....	67
7.6.2	Configuring Logging Stop Time .....	67
7.6.3	Starting the Log .....	67
7.6.4	Viewing a Log.....	67
7.7	Parameters / Field Calibration.....	67
7.7.1	Field Calibration .....	68

## Figures

Figure 1	Measurement System .....	3
Figure 2	Mounting Dimensions .....	6
Figure 3	Earthing Stud And Nut Washer Assembly .....	9
Figure 4	24 VDC & 240 V AC Power Unit Connectors .....	10
Figure 5	Other Electrical Connections.....	11
Figure 6	RJ45 to screw terminal adapter connections .....	12
Figure 7	Typical Display .....	17
Figure 8	User Interface .....	18
Figure 9	Up/Down Arrow Keys.....	18
Figure 10	'ENTER' Key .....	19
Figure 11	'ESC' Key .....	19
Figure 12	Pop Up Keypad.....	19
Figure 13	Menu Structure .....	20
Figure 14	Main Screen.....	21
Figure 15	Large Display Modes.....	23
Figure 16	Full Screen Graph .....	24
Figure 17	Warning Screen.....	25
Figure 18	Logging Screen .....	26
Figure 19	Alarm Screen .....	27
Figure 21	Field Calibration Screen 2.....	30
Figure 22	Field Calibration Screen 3.....	30
Figure 23	Field Calibration Screen 4.....	31
Figure 24	Field Calibration Screen 5.....	31
Figure 25	Monitor Screen.....	32
Figure 26	Settings Menu Screen .....	33
Figure 27	Measurement Screen .....	34
Figure 28	Carrier Gas Screen.....	35
Figure 29	Measurement Screen .....	36
Figure 30	External Options.....	37
Figure 31	Fixed Options.....	37
Figure 32	Atmos. Option.....	37
Figure 33	User Gas Setup Screen .....	38
Figure 34	Outputs Screen .....	39
Figure 35	HMI Screen.....	40
Figure 36	Real Time Clock Screen.....	42
Figure 37	Software Communications Screen .....	43
Figure 38	Ethernet Screen .....	43
Figure 39	Calibration History Screen .....	44
Figure 40	About Screen .....	45
Figure 42	Measurement Cycle (Phase 2) Calibration Flow .....	50
Figure 43	Calibration Cycle (Phase 1) - Dried Sample Flow .....	51
Figure 44	Calibration Cycle (Phase 2) - Sample Flow .....	52
Figure 45	Typical QMA601 Calibration Certificate .....	58

## Tables

Table 1	Pop Up Keypad.....	20
Table 2	Main Screen Parameters.....	23
Table 3	Large Parameter Display Mode .....	24
Table 4	Warning Screen.....	27
Table 5	Logging Screen .....	27
Table 6	Alarm Screen Parameters .....	28
Table 7	Calibration Screen Parameters.....	30
Table 8	Monitor Screen Parameters .....	33
Table 9	Measurement Screen .....	35
Table 10	Outputs Screen Parameters .....	40
Table 11	HMI Setup Screen Parameters .....	42
Table 12	Real Time Clock Screen Parameters .....	43
Table 13	Software Communications Screen Parameters.....	44
Table 15	Calibration History Screen .....	45
Table 14	Ethernet Screen Parameters.....	45
Table 16	Using the Chart .....	65
Table 17	Chart Options.....	66
Table 18	Modbus Register Map .....	83

## Appendices

Appendix A	Technical Specification .....	71
Appendix B	Hazardous Area Certification .....	74
	B.1 Product Standards .....	74
	B.2 Product Certification .....	74
	B.3 Global Certificates/Approvals .....	74
	B.4 Special Conditions of Use .....	74
	B.5 Maintenance and Installation.....	75
Appendix C	Modbus Holding Register Map .....	77
	C.1 Set Points and Ranges .....	93
	C.2 Gases for Gas Correction Values .....	94
Appendix D	Quality, Recycling, Compliance & Warranty Information.....	96
Appendix E	Return Document & Decontamination Declaration.....	98
Appendix F	Calculating Conversion Factors for Gas Mixes.....	100

## Safety

The analyzer is designed to be completely safe when installed and operated correctly in accordance with the information provided in this manual.

This manual contains all the required information to install, operate and maintain this product. Prior to installation and use of this product, this entire manual should be read and understood. Installation and operation of this product should be carried out by suitably competent personnel only. The installation and operation of this product must be in accordance with the instructions provided and according to the terms of any associated safety certificates. Incorrect installation and use of this product other than those described in this manual and other than its intended purpose will render all warranties void.

This product meets the essential protection requirements of the relevant EU directives. Further details of applied directives may be found in the product specification.

Electricity and pressurized gas can be dangerous. This product must be installed and operated only by suitable trained personnel.

## Warnings



**Where this hazard warning symbol appears in the following sections, it is used to indicate areas where potentially hazardous operations need to be carried out and where particular attention to personal and personnel safety must be observed.**



**Where this symbol appears in the following sections it is used to indicate areas of potential risk of electric shock.**

## Electrical Safety

Ensure electrical safety is complied with by following the directions provided here and observing all local operation & installation requirements at the intended location of use.

This product is completely safe when using any options and accessories supplied by the manufacturer of this product for use with it. Refer to Section 2 (Installation) of this manual for further details.

## Pressure Safety

For this product to operate satisfactorily, pressurized gas must be connected to it. Observe all the information contained within this manual and all local operation & installation requirements at the intended location of use. Refer to Section 2 (Installation) of this manual for further details.

## Hazardous Materials (WEEE, RoHS2 & REACH)

This product does not contain or release any prohibited chemicals listed on the SVHC (Substances of Very High Concern) Candidate List. During the intended normal operation of this product it is not possible for the user to come into contact with any hazardous materials. This product is designed to be recyclable except where indicated, see relevant sections in this manual for further details.



## Calibration (Factory Validation)

Prior to shipment, the analyzer undergoes stringent factory calibration to traceable standards. Due to the inherent stability of the analyzer, regular factory calibration is not required under normal operating conditions. The analyzer should perform reliably for many years with just basic maintenance, housekeeping and regular field calibrations from the internal reference (moisture generator) or a known external reference.

There are, however some consumables that will require periodic replacement.

- Moisture generator - typical lifetime of around 3 years.
- Desiccant column - typical lifetime of around 1 year, but this strongly depends on the moisture content of the sample gas. The drier the sample gas, the longer lifetime of the desiccant.
- Optional contamination trap - typical lifetime of around 1 year, a column of activated charcoal that protects the Desiccant Column from contamination in applications where the process gas composition contains heavy hydrocarbon vapors.

Michell Instruments can provide a fully traceable factory calibration service for the analyzer and it is recommended that this is considered at intervals of every year of the analyzer's life. Please contact your local Michell Instruments' office or representative for further details ([www.michell.com](http://www.michell.com)).

## Repair and Maintenance

Apart from user-replaceable components required for routine operational maintenance described above, the analyzer must only be maintained either by the manufacturer or an accredited service agent. Refer to [www.michell.com](http://www.michell.com) for details of Michell Instruments' worldwide offices contact information.

---

## Abbreviations

The following abbreviations are used in this manual:

AC	alternating current
atm	pressure unit (atmosphere)
barg	pressure unit (=100 kP or 0.987 atm) gauge
°C	degrees Celsius
°F	degrees Fahrenheit
EU	European Union
Hz	Hertz
IEC	International Electrotechnical Commission
kg	kilogram
lb	pound
lbs/MMscf	pounds per million standard cubic foot
mA	milliampere
mV	millivolt(s)
mbar	millibar
ml/min	milliliters per minute
ppm <sub>w</sub>	parts per million (by weight)
ppm <sub>v</sub>	parts per million (by volume)
psig	pound(s) per square inch (gauge)
RH	relative humidity
RTU	Remote Terminal Unit
V	Volts
W	Watts
"	Inch

## 1 INTRODUCTION

### 1.1 General

The QMA601 Moisture Analyzer is designed to provide reliable, fast and accurate measurement of trace moisture content in a wide variety of process applications where keeping moisture levels as low as possible is of critical importance.

The high-contrast capacitive button operated LCD display presents all measured data to the user in a clear and understandable format. The main display incorporates a real-time trend graph and alarm indicators based on the NAMUR 102 standard. A powerful and intuitive HMI makes control, logging and configuration of analyzer parameters easy.

The analyzer provides two user-configurable analog outputs, and Modbus RTU/TCP communications, allowing it to interface with a SCADA DCS system, or by a computer using the dedicated application software. A set of 4 adjustable volt free alarm contacts allow the QMA601 to be used for direct process control.

#### **Use Your Preferred Communication Media**

For greater flexibility, the QMA601 offers:

- Modbus RTU/TCP
- 2 user-configurable analog outputs
- Status and Process Alarms

#### **Minimal & Straightforward Maintenance**

Sophisticated analyzers are often complicated and require experience and special care in use, increasing cost of ownership. The QMA601 differs through its very uncomplicated approach to field service; the Desiccant Column is easy to replace via its mounting on the sampling panel. The moisture generator has an average life span of 3 years after which it can simply be replaced with a calibrated moisture generator supplied by Michell Instruments.

#### **Automated Calibration for Continued Reliability**

The QMA601 incorporates an integrated automatic calibration system for complete user confidence. Periodic calibration checks of sensor performance can be initiated on demand, or automatically (at user defined intervals and time of day), providing a verification of analyzer performance and automatically adjusting out any change. The moisture generator at the core of this system is supplied with a calibration traceable to NPL and NIST, but an external calibration reference source can also be used if desired.

During a calibration cycle, the Data Hold function will prevent any interruption of dependant processes by holding the analog outputs at the same level for the duration of the calibration.

### Full Hazardous Area Certification

The analyzer is ATEX, IECEx and cCSAus certified. The main unit (electronics and sensing) and associated sampling system may be mounted at a convenient location next to the pipeline or process, with gas sample and vent connections. The analyzer is supplied in either a 85-264 V AC version or a 24 V DC version. The product serial number label will identify the required operating power supply.

### Purpose Designed Sample Systems

Sample extraction, handling and conditioning techniques are of critical importance to assure optimal performance and reliability of all gas analyzers which accurately quantify specific components within a process gas composition. Three sample systems have been designed for the most common process moisture analyzer applications:

- Natural Gas Glycol Dehydration & Transmission with an advanced membrane filter to combat liquid contamination.
- Trace Moisture in High Purity & Petrochemical Gases with protection against particulates.
- Trace moisture for Asymmetric Cycle variant, includes membrane filter and 3 way valve for purge gas.

Our QMA601 sample systems facilitate regulation of pressure and flow, and the removal of contaminants, delivering a properly conditioned sample to the analyzer for reliable measurements, and trouble-free operation. The integrated bypass system increases transport speed of the sample while reducing gas wastage. Each high quality sample system is constructed from 316 stainless steel components, with BS EN 10204 3.1 material certificates available on request.

## 1.2 Theory of Operation

A pair of frequency-matched quartz crystal oscillators are used for measurement and are both exposed to the sample gas. The measurement crystal features a hygroscopic coating to adsorb moisture, whereas the reference crystal is uncoated. As the hygroscopic coating on the measurement crystal adsorbs moisture from the sample, the overall mass of the crystal is increased, modifying the oscillation frequency in a precise, repeatable and measurable manner.

The resulting measurement is highly accurate, and insensitive to changes in background gas composition.

### 1.3 Sample Gas Path

The QMA601 measurement system must be supplied with gas at the required pressure (to match that of its calibration) via the 1/4" female NPT gas inlet on the flame arrestor. The flow is controlled automatically.

The sensor cell is located at the end of the sensor block and contains the sensor and reference oscillators. *Figure 1* shows a schematic diagram of this sampling system.

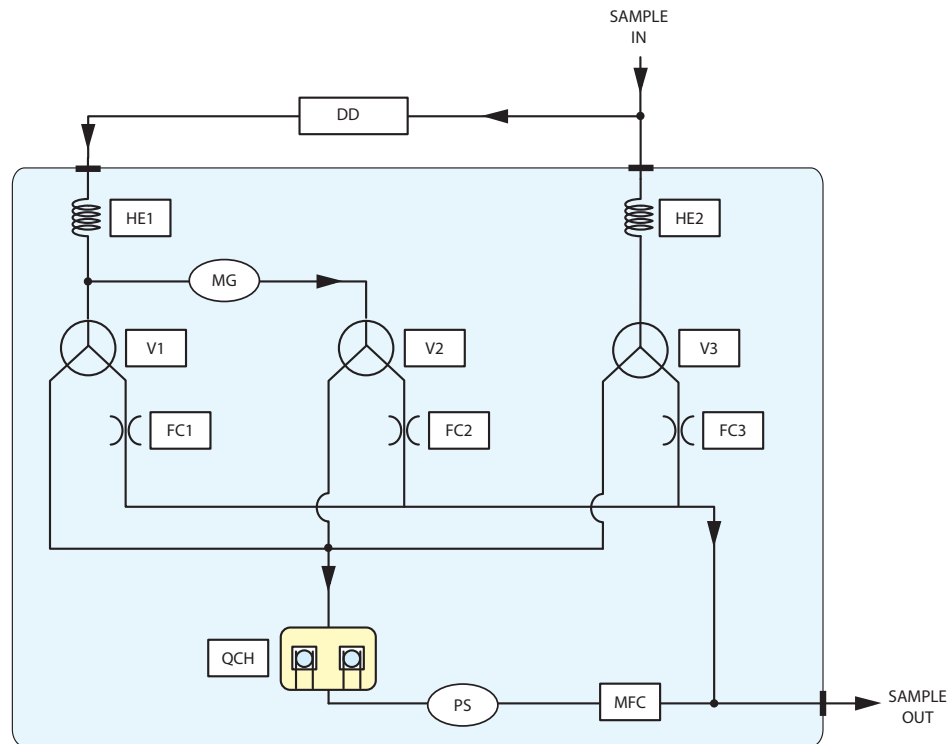

Key			
DD	Desiccant column	MG	Moisture generator
MFC	Mass flow controller	V1, V2, V3	Solenoid valves
QCH	Sensor cell	HE1, HE2	Heat exchanger
PS	Pressure sensor	FC1, FC2, FC3	Flow control

Figure 1 Measurement System

## 2 INSTALLATION

### 2.1 Analyzer Storage Instructions

In order for this product to be functional upon installation it should be stored in accordance with the guidelines below:

- The product must be housed in a sheltered area, out of direct sunlight and rain.
- The product should be stored to minimize the possibility of sitting in ground water.
- The temperature within the storage environment should be maintained between -20 to +60°C (-4 to +140°F).
- The humidity within the storage environment must be non-condensing.
- The storage environment must not expose the analyzer to any corrosive elements.
- The product should stay assembled with its sample conditioning system (if supplied).
- All electrical and process connections should remain disconnected and capped.
- All protective coatings should remain in place until installation.
- For prolonged periods of storage, the lid of the packaging crate should be removed to allow air to circulate.
- Any documentation supplied with the product should be removed from the packaging crate and stored elsewhere to protect its integrity.

For the period from installation of the product to commissioning start-up, the following precautions should be followed:

- The product and associated sampling system (if supplied) must remain isolated from the process gas, and the enclosure should remain closed to ensure ingress protection is maintained.
- If supplied, the sampling system enclosure heating/thermostat circuit should be operated if the climatic temperature might fall below +5°C (+41°F).
- At time of start-up the procedures contained in the user manuals for both analyzer and sampling system must be followed.

If the product was previously in service/operation then the following precautions should be followed before storage:

- Upon isolation from the gas sample the entire system should be purged with a dry nitrogen gas before powering down of the analyzer.
- All connections and ports (gas and electrical) to the analyzer or sample system (if provided) should be capped.
- If the product is not removed from its location, the electrical grounding of the analyzer should remain in place.

## 2.2 Unpacking the Analyzer

Open the crate and carefully unpack the analyzer.



**WARNING:**

**The analyzer weighs 35kg (77lbs) alone,  
or 50kg (110lbs) in the crate**

The accessories box should contain the following items:

- Traceable calibration certificate
- Application software CD
- Users manual

If there are any shortages please notify the supplier immediately.

**NOTE: Retain the packaging in case the analyzer is returned for factory calibration or service.**

## 2.3 Lifting and Handling



**WARNING:**

**Personnel must observe suitable lifting and handling precautions.**

The QMA601 is not designed as portable or transportable equipment. The product should be rigidly fixed in position as per the full installation instructions.

The weight of the analyzer is 35kg (77lbs). Therefore, appropriate lifting and handling techniques should be used during the installation process. Before commencing any lifting or handling ensure that its intended location is suitable and appropriately prepared. Make sure that mounting point design considerations have employed locally approved safety factors.

When handling and installing this analyzer (particularly after removal from its packaging) ensure that it is not dropped, impacted or subjected to high levels of vibration or environmental conditions that may impair its operation.

2.4 Mounting the Analyzer

The analyzer is housed in an aluminum Exd enclosure suitable for wall or panel mounting. Four mounting points are available with M10 clearance holes on fixing centers of X = 308mm and Y = 312mm.

The enclosure provides environmental ingress protection IP66/NEMA4 and should be mounted vertically in a location free of any appreciable vibration. It should be placed in a shaded position to prevent heating effects through sun radiation. The weight of the analyzer is 35kg (77lbs).

Conduit entries are intended for connection to threaded rigid metal conduit or other wiring methods in accordance with Article 501 of the National Electrical Code ANSI/NFPA 70-2005.

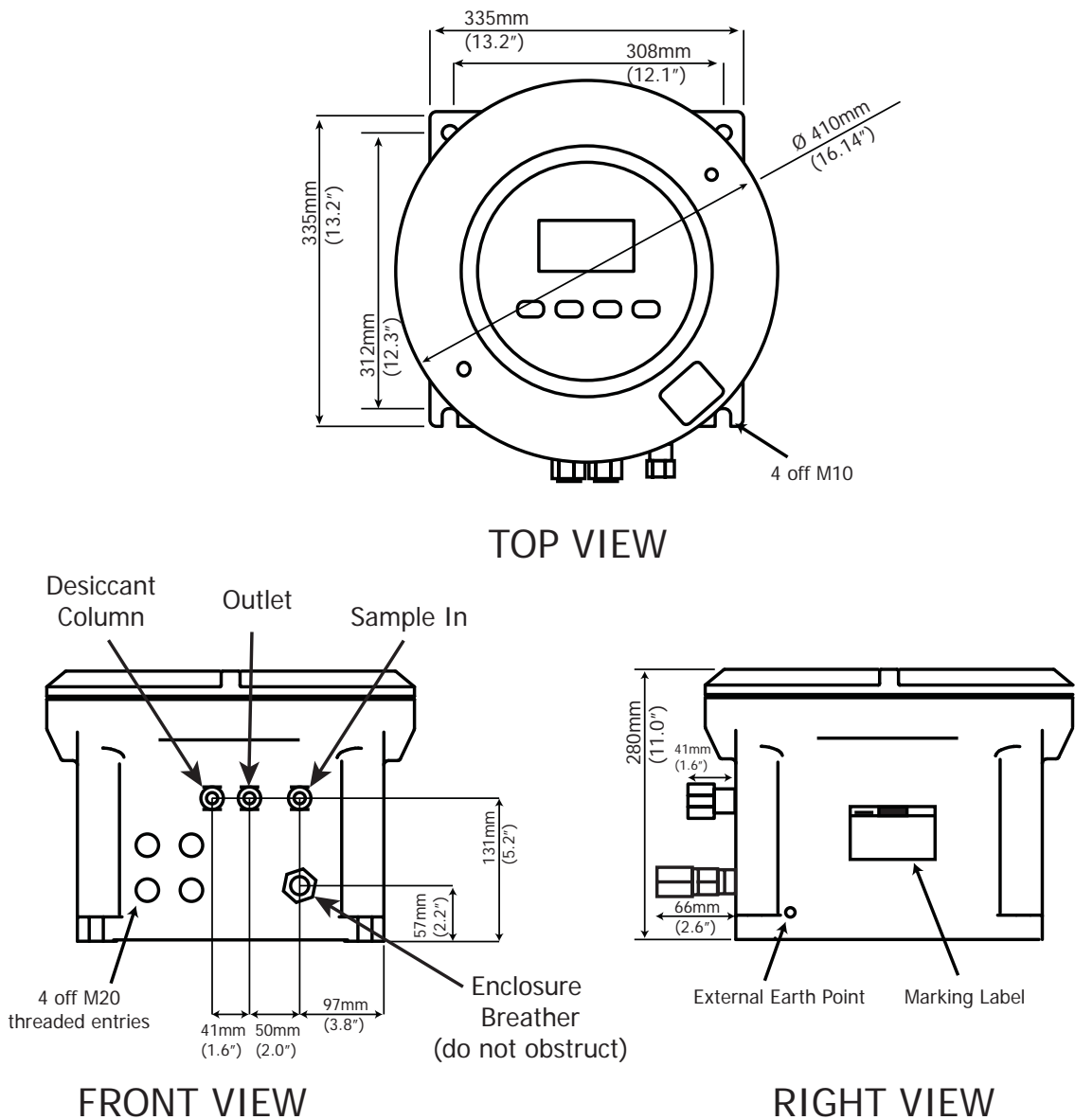

Figure 2 Mounting Dimensions



## 2.5 Hazardous Area/Location Safety

This product is compliant for installation and use in a Hazardous Area/Location. All certificates awarded to this product should be fully examined prior to installation and use.



**WARNING:**  
This product is certified safe for use in an ATEX Zone 1 and Zone 2 / Class I, Division 1 area only. This product must not be installed or used within a Zone 0 area.

**WARNING:**  
This product must not be operated within an explosive atmosphere greater than 1.1 bara (16 psia).

**WARNING:**  
This product must not be operated with enriched oxygen atmospheres (more than 21% oxygen content).

**WARNING:**  
This product must not be operated outside of the temperature range of +5 to +45°C (+41 to +113°F)

Refer to Appendix B for the Hazardous Area/Location certification details of this product.

Hazardous Area/Location certificates for this product may be downloaded from:

<http://www.michell.com>.

This product is fitted with a marking label that contains Hazardous Area/Location information pertinent to the suitable location and installation.

During all installation and operation activities, local regulations and permitted working routines must be observed. Installation should only be performed by competent personnel and, where applicable, in accordance with IEC/EN 60079-14:2008 or local equivalents.

Cable glands/barrier glands/conduit seals shall be installed in accordance with the manufacturer's instructions.

Repair and servicing of this equipment must only be carried out by the manufacturer. An Installation and Maintenance Information Sheet is supplied separately to the manual.

## 2.6 Electrical Safety

**WARNING:**  
During the installation of this product ensure that all applicable national and local electrical safety regulations are observed.



**WARNING:**  
Isolate the power prior to installation.

**WARNING:**  
Always ensure that power is switched off prior to accessing the product for any purpose other than normal operation, or prior to disconnecting any cables.

### Fuse

This product is provided with an internally mounted fuse located beneath the power connector.

The fuses are rated at 5 x 20mm anti-surge to IEC60127-2:

Mains 240 V AC	3 A
24 V DC	6.3 A

A replacement fuse can be obtained by contacting Michell Instruments' technical support.

### 2.6.1 Equipment Ratings and Installation Details

This equipment and all power isolation devices must be installed in a location and position that allows safe and easy access to their operation and is able to rigidly support the equipment.

For location and mounting arrangements - refer to the relevant sections of this manual for further details.

Do not install this equipment in a location that would expose it to impact or high levels of vibration. Installation of this equipment must include the provision of a suitable and locally positioned power isolation switch or circuit breaker. Indication of the purpose of the switch or circuit breaker is strongly recommended. An over-current protection device should be rated to a maximum of 10 A. Ensure that the power supply is sufficient to satisfy the instrument's power consumption requirements.

Any power supply terminals and voltages must be suitably separated from the other input/output requirements of this product.

The product enclosure is supplied with an external protective earthing/grounding terminal at the lower right hand side as shown in the figure below. As the first step of the electrical installation - connect this earthing/grounding terminal to plant earth/ground by a minimum 4mm<sup>2</sup> earth/ground bond strap. The earthing/grounding terminal comprises of an earth bolt, 2 x plain washers and 1 x spring washer, which are all nickel plated.



**Figure 3** *Earth Bolt And Nut Washer Assembly*

### Mains Powered Units

As a minimum, the power connection cable should be 3 core over sleeved, with minimum 0.5mm insulation and rated at 300 V. Cables should have Live (L), Neutral (N) and Earth [Ground] (E) conductors.

Ensure suitably rated power supply cables and glands are used to ensure that electrical safety is maintained. Connect each of the Live (L), Neutral (N) and Earth [Ground] (E) conductors to the similarly marked terminals (L, N, E) on the Power In connector shown above.

### 24 V DC Units

The cable should be rated at a minimum of 10 A at 50 V DC with minimum 0.5mm insulation. Connect the +24 V conductor to the terminal marked + and the 0 V conductor to the terminal marked -.

Before applying power, perform a continuity test to ensure that the power supply cable and product are effectively connected to the protective earth. A protective earth terminal is mounted internally and the Earth wire connected to it should never be disconnected.

Do not remove or exchange any of the cables, electrical components or any other parts supplied with this product. Doing so will invalidate all warranties.

If installing rigid conduit, a stopping fitting must be installed within 46cm (18") of the enclosure.

There are no additional or special electrical safety requirements other than those referred to in this manual.

This product is designed to be safe under the following conditions: between a temperature range of -40 to +60°C (-40 to +148°F), in maximum 80% relative humidity for temperatures up to +31°C (+88°F) decreasing linearly to 50% RH at +50°C (+122°F). Supply voltages of ±10% and transient over voltages up to Overvoltage Category II. Pollution Degree 2. Altitudes up to 2000m. Outdoor mounting is permitted using suitably rated glands equivalent to NEMA 4 / IP66. **See Appendix A, Technical Specification, for full operating parameters.**

2.6.2 Power Connection



The product is provided with 4 x M20 threaded cable gland entries for customer connection. Only these gland entry points may be used. The end user/installer is not permitted to machine additional entries into the enclosure.

This equipment must be supplied with a voltage between the range of 85 to 264 V AC, 47/63 Hz (140 W max) or 24 V DC (140 W max) to function correctly. Cable entry into the measurement system is made through the bottom of the enclosure.

For an 85/264 V AC powered unit the terminals are marked:

- L Live (= IEC Brown)
- N Neutral (= IEC Blue)
- E Earth/Ground (= IEC Green/Yellow)

For a 24 V DC powered unit, the terminals are marked:

- + 24 V DC
- 0 V DC

All power connections are made via a removable screw terminal connector mounted on the mains connection PCB shown in *Figure 4*.

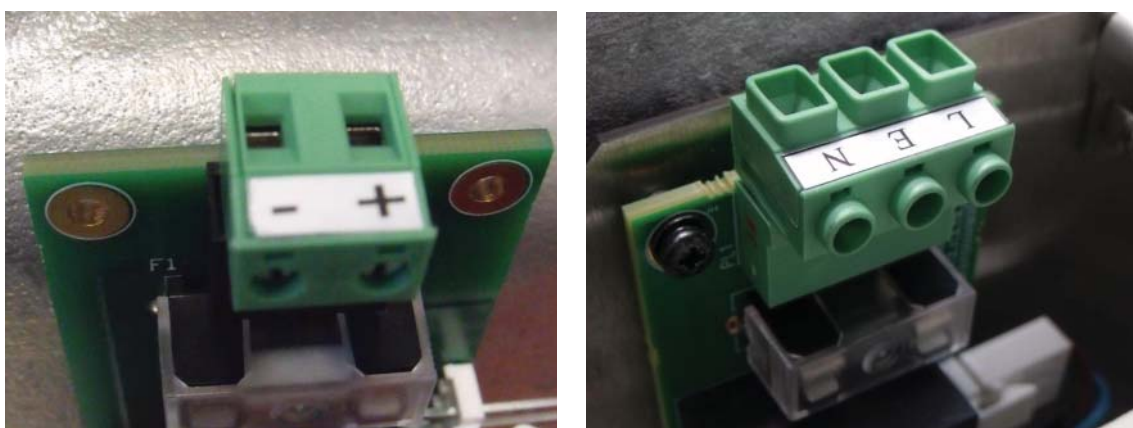

Figure 4 24 V DC & 240 V AC Power Unit Connectors

All input and output connectors are 2-part pcb mounted type rated @ 300 V 10 A. The detachable, screw terminal half of each connector is designed to accept 0.5 to 2.5mm<sup>2</sup> (24 -12 AWG) stranded or solid conductors. The connector 2-pin for 24 V DC and 3-pin for 240 V AC.

### 2.6.3 Other Electrical Connections

The power supply (shown below as a silver box) will not be in the 24 V DC version.

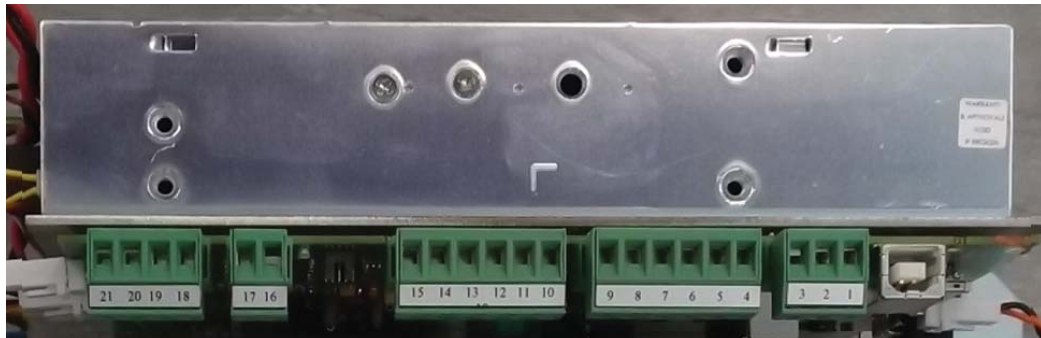

Figure 5 Other Electrical Connections

#### 1 Analog Outputs

21	OP2-
20	OP2+
19	OP1-
18	OP1+

#### 2 External Pressure

17	-
16	+

#### 3 Alarms 3-4

15	COM4	} Analyzer Status Alarm NO in warning/fault condition NC no warning/ no fault
14	NO4	
13	NC4	
12	COM3	
11	NO3	
10	NC3	

#### 4 Alarms 1-2

9	COM2
8	NO2
7	NC2
6	COM1
5	NO1
4	NC1

#### 5 RS485

3	G
2	B
1	A

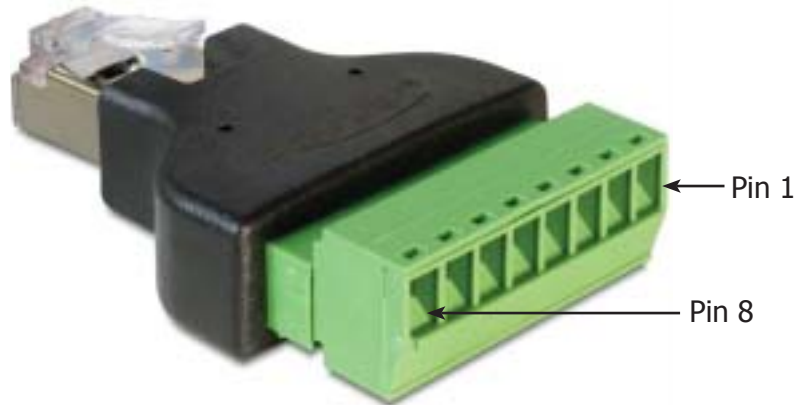

Figure 6 RJ45 to screw terminal adapter connections

Pin	Signal Name	Description	Cable Wire Color
1	TX+_D1	Transmit Data+	White with orange stripe
2	TX-_D1	Transmit Data-	Orange with white stripe or solid orange
3	RX+_D2	Receive Data+	White with green stripe
4	BI+_D3	Bi-directional+	Blue with white stripe or solid blue
5	BI-_D3	Bi-directional-	White with blue stripe
6	RX-_D2	Receive Data-	Green with white stripe or solid green
7	BI+_D4	Bi-directional+	White with brown stripe
8	BI-_D4	Bi-directional-	Brown with white stripe or solid brown

2.7 Pressure Safety



**WARNING:**

This product is used in conjunction with pressurized gases. Observe pressurized gas handling precautions.



**WARNING:**

Pressurized gas is dangerous and should only be handled by suitably trained personnel.

DO NOT permit pressures greater than the specified safe working pressure to be applied directly to the analyzer.



Unless otherwise specified the QMA601 is calibrated at a sample pressure of 3 barg (43.5 psig) on the gas inlet, and a back-pressure of 2 barg (29 psig) on the outlet. Operating the analyzer at a different pressure invalidates the calibration.

Similarly, gas pressure affects the output of the internal moisture generator, thereby invalidating further auto calibrations which use a built-in moisture generator as a reference.

## 2.8 Gas Sample Connections

The following points should be considered when installing the sample gas supply line:

- PTFE tape is recommended for pipe connections.
- Solvent based pipe thread sealant should not be used, as condensable components or contaminants can be leached during the curing period.

Care and attention to the position and installation of the tubing will minimize problems caused by avoidable contamination. The most common issue with of sample flow is the accumulation of liquid in impulse lines during a shutdown period. If the measurement system has not been isolated, condensate can be displaced, on re-start, into components and associated tubework.



### **WARNING:**

**Exd enclosure breather must remain open to atmosphere at all times, without any obstruction - See Figure 2.**

Michell Instruments' recommendations are:

- The sampling point from the process line should be taken from the top of the process line. If a radial probe is used the orifice should face downstream.
- It is recommended that Viton is used for all O-rings.
- The internal volume of the impulse tubing connecting between the process line and this product should be as small as possible to minimize response lag time to changing process conditions.
- Piping should be lagged and/or trace heated if ambient temperatures could cause the sample gas to fall below its dew-point temperature.
- A drain valve should be placed at the lowest point in the system.
- It should be standard procedure to isolate this product during shutdowns or when plant problems are being experienced and to adequately purge the supply lines before restarting.
- The relatively large area of surfaces and internal volume of inline components can be particularly troublesome if contamination is experienced.

Prolonged purging, or stripping and cleaning, followed by re-purging with gas may be necessary to remove the contamination.

- Avoid sample gas streams that are already very close to the dew point or which have dispersed liquid within them. In such cases, sampling from fast loops and/or from downstream of existing catch pot/coalesce systems is always preferred.

Failure to observe these recommendations will potentially cause problems of contamination as well as causing consequential inaccurate, unreliable and inconsistent monitoring. If a top-entry sample point is not available, extra attention should be given to the design of the sample line installation to avoid unwanted contamination.



### 3 OPERATION

This section describes both the general operation of the analyzer and the method of setting-up and changing the default parameters should this become necessary.

**NOTE: Before operating the analyzer read Sections 1 to 3 which explain the analyzer's functionality, installation, controls, display functions and screens.**

Prior to operation, the analyzer must have been connected to the correct electrical power supply and the relevant analog and alarm outputs connected to external systems as required and as described in Section 2. The analyzer must also have been installed as detailed in Section 2 and connected to a sample gas supply that is representative of the monitored process.

#### 3.1 General Operational Information

Operation of the QMA601 is completely automated and once set-up requires little or no operator intervention.

### 3.1.1 First Time Operation

To commence operation, proceed as follows:

1. Connect the sampling line to the sample system. It is recommended to heat trace the sample gas line.
2. Switch on the power supply to the analyzer. The Initializing Screen will appear.

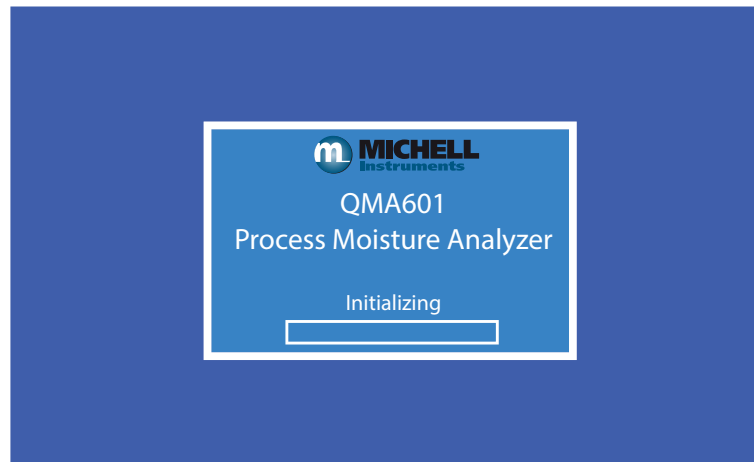

3. After the initializing period has finished, the following display will appear.

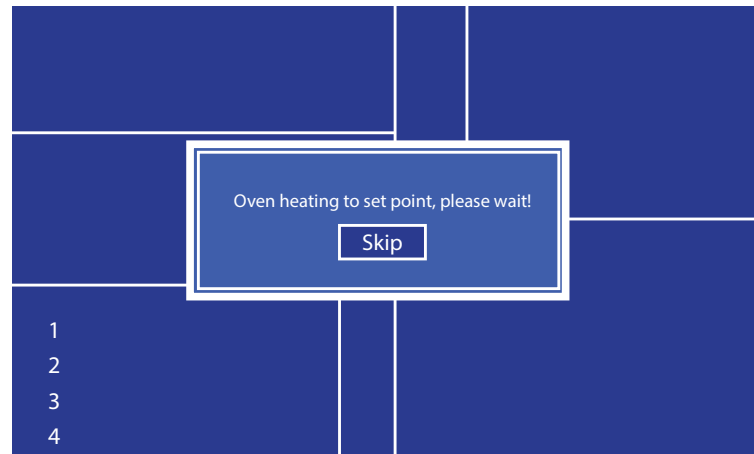

4. This heating period lasts about an hour allowing time for the internal sampling system to be purged with the sample gas.

3.1.2 Analyzer Set-Up

During the period when the oven is heating to set point, all functions, except for HMI adjustments, are disabled until the oven has reached its operating temperature. Press the **ENTER** key to enter the HMI Screen (see Section 3.73) to set up the temperature and pressure units before operating the analyzer for the first time. Note: Pressing the ENTER key only takes you to the HMI screen when the oven heating message with "skip" button is present.

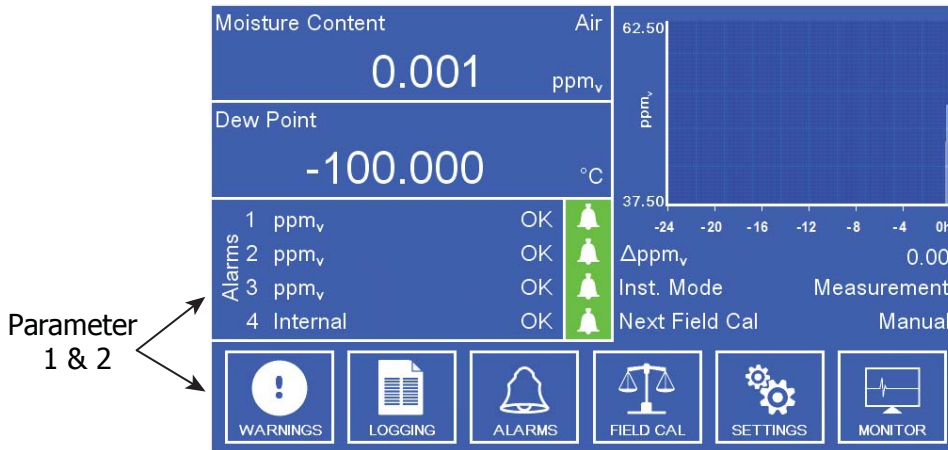

Figure 7 Typical Display

Using the inlet pressure regulator adjust the sample pressure until the reading on the internal sensor pressure readout matches the value on the calibration certificate. The back-pressure should also be adjusted to the value shown on the calibration certificate.



**Unless otherwise specified the QMA601 is calibrated at a sample pressure of 3 barg (43.5 psig) on the gas inlet, and a back-pressure of 2 barg (29 psig) on the outlet. Operating the analyzer at a different pressure invalidates the calibration.**

**Similarly, gas pressure affects the output of the internal moisture generator, thereby invalidating further auto calibrations which use a built-in moisture generator as a reference.**

## 3.2 User Interface

The QMA601 features a 7" color display.

### 3.2.1 Interface Controls



Figure 8 *User Interface*

Four capacitive touch keys are used to navigate the menu system.

Key presses are detected through the glass front panel, and are indicated by a blue LED above the key.

### 3.2.2 'Up/Down Arrow' Keys



Figure 9 *Up/Down Arrow Keys*

The **Up** (▲) and **Down** (▼) keys are used to move to required menu items. The selected menu item is surrounded by a black frame.

Numerical options activate a pop up keypad. For more information on the keypad see Section 3.2.5.

### 3.2.3 'ENTER' Key



Figure 10 'ENTER' Key

The **ENTER** key is used to navigate into menus, open keypads, cycle through options, and accept changes.

For non-data entry options pressing the **ENTER** key moves to the next available option.

### 3.2.4 'ESC' Key



Figure 11 'ESC' Key

The **ESC** key is used to return to the previous menu and is also used to leave keypads without accepting any changes.

### 3.2.5 Pop Up Keypad

Allows the user to enter numerical data. The figures below the box indicate the minimum and maximum limits which can be entered.



Figure 12 Pop Up Keypad

Key	Action	Note
ESC	Moves cursor to last digit. Exits to previous page.	
Up (▲) and Down (▼)	Increments or decrements selected number.	
ENTER	Moves cursor to next digit. If at last digit, and within allowable range, updates value.	If outside the allowable range then a message displays informing the user.

Table 1 Pop Up Keypad

3.3 Menu Structure

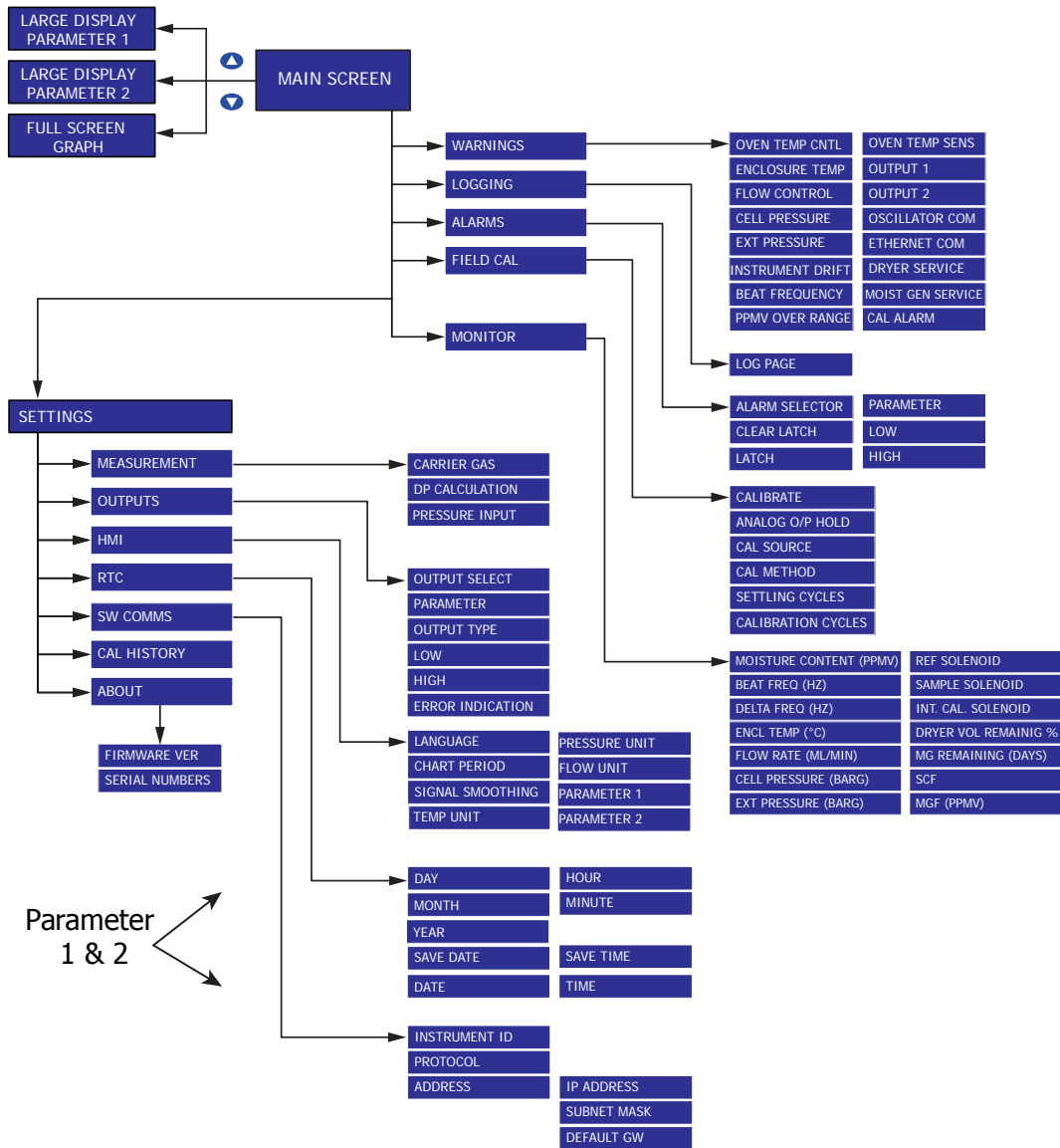

Figure 13 Menu Structure

### 3.4 Description of Measured Parameters

Moisture content ppm <sub>v</sub>	parts per million of H <sub>2</sub> O by volume
Moisture content ppm <sub>w</sub>	parts per million of H <sub>2</sub> O by weight
Moisture content mg/m <sup>3</sup>	milligrams of H <sub>2</sub> O per cubic meter gas
Water Vapor Pressure Pa	water vapor pressure in pascals
lbs/MMscf	pounds of H <sub>2</sub> O per million standard cubic feet
Dew point	dew-point temperature of either ideal or natural gas depending on options set on measurement screen
Oven Temperature	Temperature of the internal oven
Flow	Gas flow rate
Cell Pressure	Pressure measured by the internal pressure transducer
Ext. Pressure	Pressure measured by an external pressure transducer (if fitted)

### 3.5 Main Screen

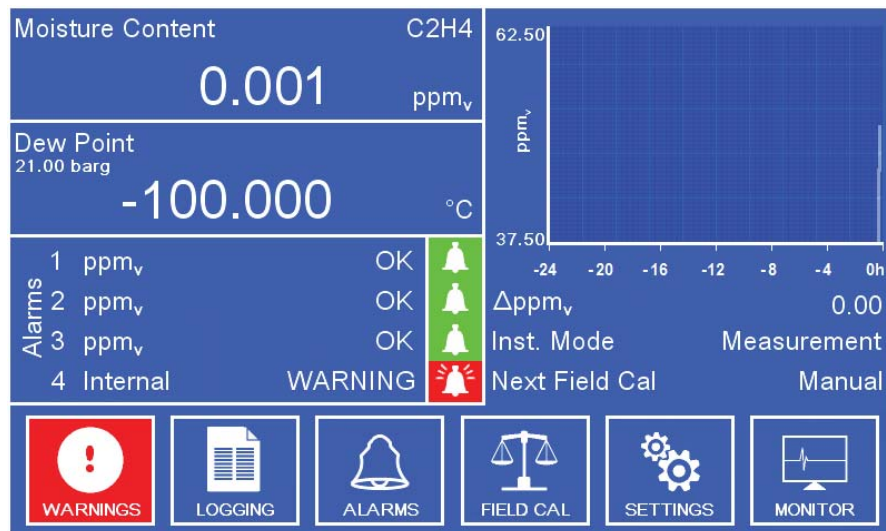

Figure 14 Main Screen



Parameter	Description
Parameter 1 & 2	Live reading of the selected display parameters.
Graph	Live graph reading of parameter 1.
Alarm 1, 2 & 3	The current state of the alarms.  <b>Possible States:</b> <b>Low</b> – Alarm type is set to Low, and has been triggered because the selected parameter is below the threshold value. <b>OK</b> – Alarm has not been triggered. <b>High</b> – Alarm type is set to High, and has been triggered because the selected parameter is above the threshold value. <b>Trip</b> - Alarm has been triggered at some point previously but is now OK. Only occurs when the alarm is set as 'Latched'
Alarm 4 Internal	Analyzer Status Alarm Relay Activated for warning/fault The parameter selection can be set in the "warnings" menu.
Warnings	Internal warning alarms.  <b>Possible States:</b> OK, WARNING
$\Delta$ DP	Shown as $\Delta X$ (where X=the currently selected primary measurement parameter) – Displays the difference between the minimum and maximum graph measurements.
Inst. Mode	Displays the current analyzer mode.  <b>Possible States:</b> <b>Measure</b> – QMA601 is performing a measurement cycle. <b>Cal Internal</b> – QMA601 is performing a self-calibration using the internal reference. <b>Cal External</b> – QMA601 is performing a self-calibration using an external reference. <b>Warm up</b> – Oven is still heating to the set-point temperature.
Next Mode	If Inst. Mode = Measure, Next Mode = Next Calibration If Inst. Mode = Cal Internal/External, Next Mode = Next Measurement If Inst. Mode = Heating, Next Mode = Oven Temperature  <b>Possible States:</b> Time until the next mode or Manual

Table 2 Main Screen Parameters

### 3.5.1 Large Display Mode

#### Parameter 1 & 2

To access the large display mode for Parameter 1 and 2, press the **DOWN** key from the Main Screen.

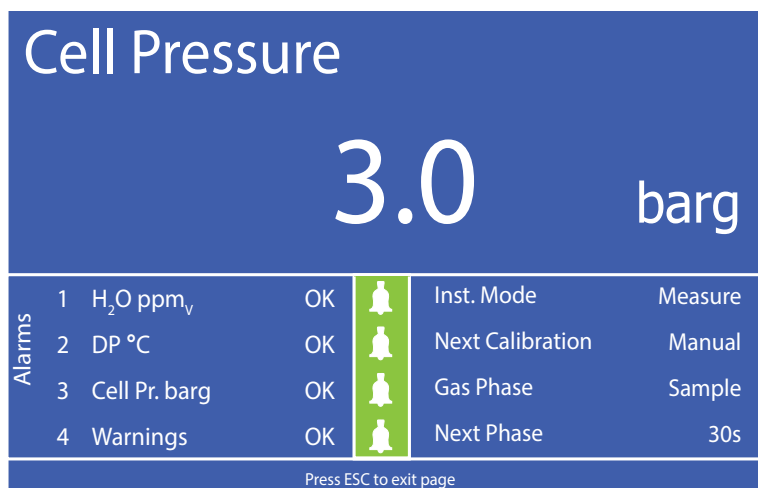

**Figure 15** Large Parameter Display Mode

<b>Gas Phase</b>	Displays the current gas phase being analyzed  <b>Possible States:</b> Reference, Calibration, Sample Refer to Sections 3.9 and 3.10 for a description of the measurement and calibration cycles.
<b>Next Phase</b>	Shows the countdown in seconds until the current gas phase ends and the next gas phase begins.

**Table 3** Large Parameter Display Mode

To return to the Main Screen press the **ESC** key.

### Full Screen Graph

This page displays a full screen graph of Parameter 1.

To access the full screen graph, press the **Up (▲)** key from the Main Screen.

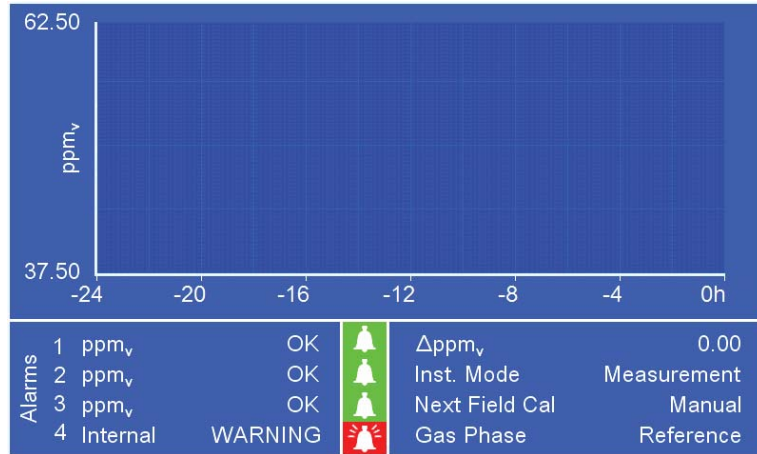

**Figure 16** *Full Screen Graph*

### 3.6 Main Screen Sub Menus

The following sub menus can be accessed from the Main Screen:

- Warnings
- Logging
- Alarms
- Field Cal
- Settings
- Monitor

#### 3.6.1 Warning Screen

This page is accessed through the 'Warnings' item on the Main Screen and is used to enable or disable the internal alarms. When an individual alarm is disabled it will not trigger the internal alarm.

This screen is accessed by pressing the **ENTER** key from the Configuration Screen.

Navigate between menu items with the **Up (▲)** and **Down (▼)** keys.

Press the **ENTER** key to change the required option.

To return to the Configuration Screen press the **ESC** key.

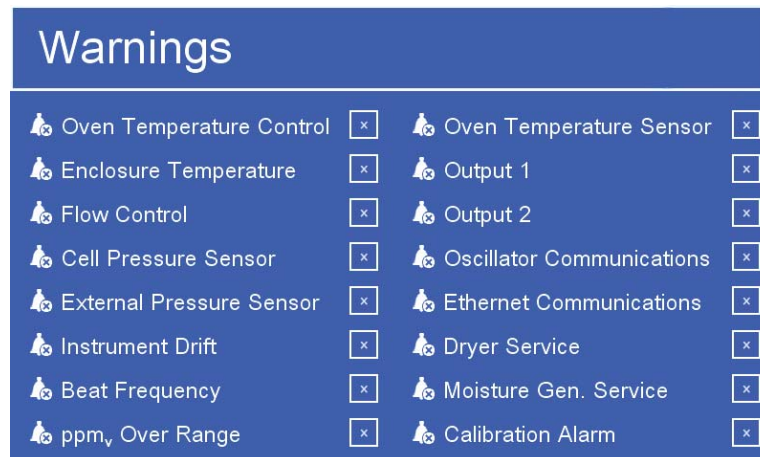

Figure 17 Warning Screen

The state of the internal alarm associated with each of the parameters above is indicated by the following icons:



Icon	Description
	Alarm disabled.
	Alarm enabled. No fault.
	Alarm enabled. Fault condition.

Table 4 Warning Screen

### 3.6.2 Logging Screen

This menu contains a record of the last 280 data points of the 'Log Parameter' value. It is accessed through the 'Logging' item on the Main screen.

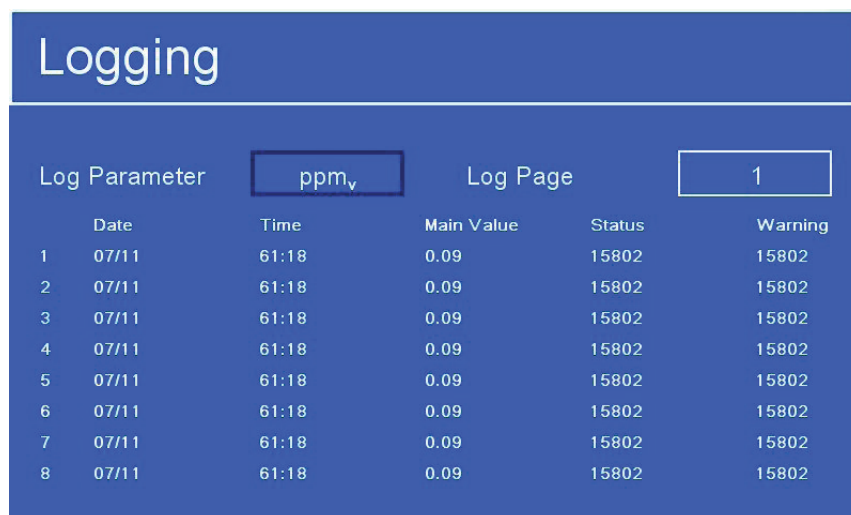

Logging					
Log Parameter	ppm <sub>v</sub>		Log Page	1	
	Date	Time	Main Value	Status	Warning
1	07/11	61:18	0.09	15802	15802
2	07/11	61:18	0.09	15802	15802
3	07/11	61:18	0.09	15802	15802
4	07/11	61:18	0.09	15802	15802
5	07/11	61:18	0.09	15802	15802
6	07/11	61:18	0.09	15802	15802
7	07/11	61:18	0.09	15802	15802
8	07/11	61:18	0.09	15802	15802

Figure 18 Logging Screen

Parameter	Description
Log Parameter	Parameter to be recorded in the log file
Log Page	Opens a keypad to select the page of logged data to view.

Table 5 Logging Screen

### 3.6.3 Alarm Screen

This menu allows the internal alarm parameters to be set. It is accessed through the 'Alarms' item on the Main screen.

This screen is accessed by pressing the **ENTER** key from the Configuration Screen.

Navigate between menu items with the **Up (▲)** and **Down (▼)** keys.

Select the alarm required with the **ENTER** key.

Press the **ENTER** key to change the required option. Numerical parameter options activate a pop up keypad. For more information on the keypad see Section 3.2.5.

To return to the Configuration Screen press the **ESC** key.

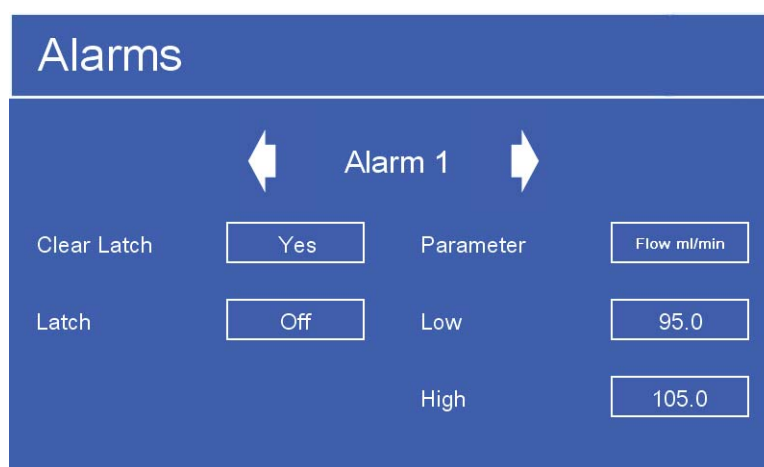

Figure 19 Alarm Screen

Parameter	Description
<b>Alarm Selector</b>	Selects the required alarm. <b>Available Options:</b> Alarm 1, Alarm 2, Alarm 3, Alarm 4 - Analyzer Status Alarm only
<b>Clear Latch</b>	Clears a latched alarm. <b>Available Options:</b> Yes, Cleared
<b>Latch</b>	Enables and disables latching of the selected alarm. If latching is enabled the alarm will enter a 'tripped' state when the cause of the alarm is corrected. <b>Available Options:</b> YES, NO
<b>Parameter</b>	Selects the parameter for the selected alarm. <b>Available Options:</b> Flow ml/min, Cell Pr. barg, Ext. Pr. barg, H <sub>2</sub> O ppm <sub>v</sub> , H <sub>2</sub> O ppm <sub>w</sub> , H <sub>2</sub> O mg/m <sup>3</sup> , WVP Pa, lbs/MMscf, DP °C/°F, Oven °C/°F
<b>Low</b>	Selects the lower limit for the selected alarm.
<b>High</b>	Selects the upper limit for the selected alarm.

Table 6 Alarm Screen Parameters

### 3.6.4 Field Calibration Screen

This menu allows the field calibration parameters to be set and activated if necessary. It is accessed through the 'Field Cal' item on the Main screen.

Depending upon the field calibration settings some parameters may become inactive. In these cases the inactive parameters are automatically hidden

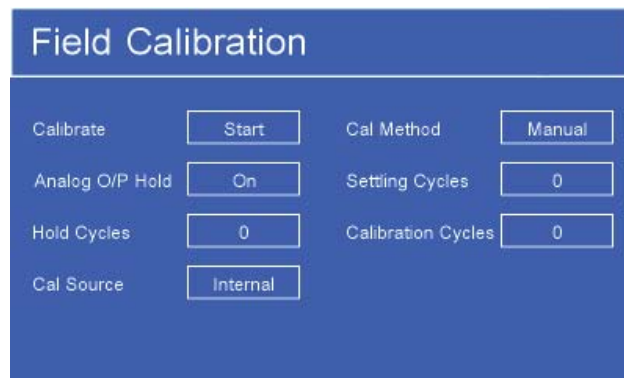

**Figure 20** Calibration Screen

Parameter	Description	
Calibrate	Starts a calibration procedure if a manual calibration has been selected.	
Analog O/P Hold	Toggles data hold mode. This determines whether the last valid measurement is held while a calibration is carried out. <b>Available Options:</b> On, Off	
	If data hold is selected, the user can select how many cycles, after the calibration, the last measured value is held for.	
Cal Source	Toggles between an external calibration source or the internal calibration source. If an external calibration source is selected the external reference moisture must be entered in the ext ref setting. <b>Available Options:</b> External, Internal	
	<b>External Cal Source</b> - when this is chosen <b>Ext Ref</b> will need to be entered to show the ppm <sub>v</sub> value of the external moisture reference.	
	<b>Internal Cal Source</b> - when this is chosen then the Cal Method can be set to Manual or Automatic.	
Cal Method	Toggles between manual calibration or automatic calibration mode. <b>Available Options:</b> Automatic, Manual	
	<b>Manual Cal Method</b> - if this is chosen the Start button must be pressed in order to initiate the calibration procedure. If this method is chosen then both the Interval and Hour selection boxes are hidden and a Start button is displayed.	
	<b>Automatic Cal Method</b> - if this is chosen then the following parameters will need to be set and will be displayed on the screen. Calibration will begin on the time selected using the interval and hour settings.	
	<b>Interval (Days)</b>	Frequency of automatic calibrations in days.
	<b>Hour</b>	The hour in the day at which an automatic calibration will start.
	<b>Settling Cycles</b>	Period of time for the QMA401 to stabilize to the new moisture level (as presented by the internal moisture generator or external ppm value) before conducting the actual calibration cycles.
	<b>Cal Cycles</b>	Sets how many calibration cycles are carried out.

**Table 7** Calibration Screen Parameters



If Analog O/P Hold is turned off then the 'Hold Cycles' selection box is hidden, as shown below:

Field Calibration			
Calibrate	Start	Cal Method	Manual
Analog O/P Hold	Off	Settling Cycles	0
Cal Source	Internal	Calibration Cycles	0

**Figure 21** *Field Calibration Screen 2*

Hold Cycles – If Analog O/P Hold is selected, the user can select for how many cycles after the calibration the last measured value is held for. This is done using the onscreen keypad which is opened.

If an external calibration source is selected the user must enter the external reference moisture in the Ext Ref (ppm) setting.

If an internal calibration source is selected then the 'Ext Ref' selection box is hidden (as shown above). If an external calibration is selected then the calibration mode is forced to manual i.e. an automatic calibration cannot be carried out if the external calibration source is active. The 'Cal Method' selection box is also hidden, as shown below:

Field Calibration			
Calibrate	Start	Settling Cycles	0
Analog O/P Hold	On	Calibration Cycles	0
Hold Cycles	0		
Cal Source	External		
Ext Ref (ppm)	0.0001		

**Figure 22** *Field Calibration Screen 3*

If an automatic calibration is selected then calibration will begin on the time selected using the interval and hour settings. This is done using the onscreen keypad which is opened.

If a manual calibration is selected then both the 'Interval' and 'Hour' selection boxes are hidden, as shown above. If an automatic calibration is selected then the "Calibrate", "Cal Source" and "Ext Ref" selection boxes are hidden, as shown below:

**Figure 23** *Field Calibration Screen 4*

- Interval (Days) – This is where the user selects how often in days a calibration is performed.
- Hour of Day – This is where the user selects the hour within the day at which the calibration will occur.
- Cal Cycles – This is where the user selects how many calibration cycles are carried out.
- Settling Cycles – This is where the user selects how many settling cycles are added after the calibration.

**If a field calibration has started all adjustable parameters are hidden. A control to stop the field calibration is added along with a countdown of the remaining settling cycles and calibration cycles:**

**Figure 24** *Field Calibration Screen 5*

### 3.6.5 Monitor screen

This screen displays a number of live parameters. No parameter can be changed on this screen: it is for reference only.

This screen is accessed through the Monitor item on the main screen.

To return to the Main Screen press the **ESC** key.

Monitor			
Moisture Content (ppm <sub>v</sub> )	0.084	Ref Solenoid	On
Beat Freq (Hz)	0.0000	Sample Solenoid	Off
Delta Freq (Hz)	0.0000	Internal Cal Solenoid	Off
Enclosure Temperature (°C)	0.0	Dryer vol. remaining (%)	0.00
Flow Rate (ml/min)	100.0	MG remaining (days)	0
Cell Pressure (barg)	3.00	SCF	0.000
External Pressure (barg)	--.--	MGV (ppm <sub>v</sub> )	0.0001

**Figure 25** Monitor Screen

Parameter	Description
<b>Moisture Content (ppm<sub>v</sub>)</b>	Live moisture reading in ppm <sub>v</sub>
<b>Beat Frequency(Hz)</b>	Live beat frequency reading: the frequency difference between the two crystals.
<b>Delta Frequency(Hz)</b>	Live delta frequency reading: the beat frequency difference between the sample and reference phase.
<b>Enclosure Temperature (°C)</b>	Live QMA601 enclosure temperature.
<b>Flow Rate (ml/min)</b>	Live flow rate reading.
<b>Cell pressure (barg)</b>	Live internal pressure transducer reading.
<b>Ext. pressure (barg)</b>	Live external pressure reading.
<b>Ref Solenoid</b>	Displays the reference solenoid state.
<b>Sample Solenoid</b>	Displays the sample solenoid state.
<b>Internal Cal Solenoid</b>	Displays the internal calibration solenoid state.
<b>Dryer vol. remaining %</b>	Remaining dryer life in %.
<b>MG remaining (days)</b>	Remaining moisture generator life in days.
<b>SCF</b>	Sensor correction factor set during a calibration cycle.
<b>MGV</b>	Moisture Generator value.

**Table 8** Monitor Screen Parameters

### 3.7 Settings Menu

The settings menu is accessed through the Settings item on the main screen.

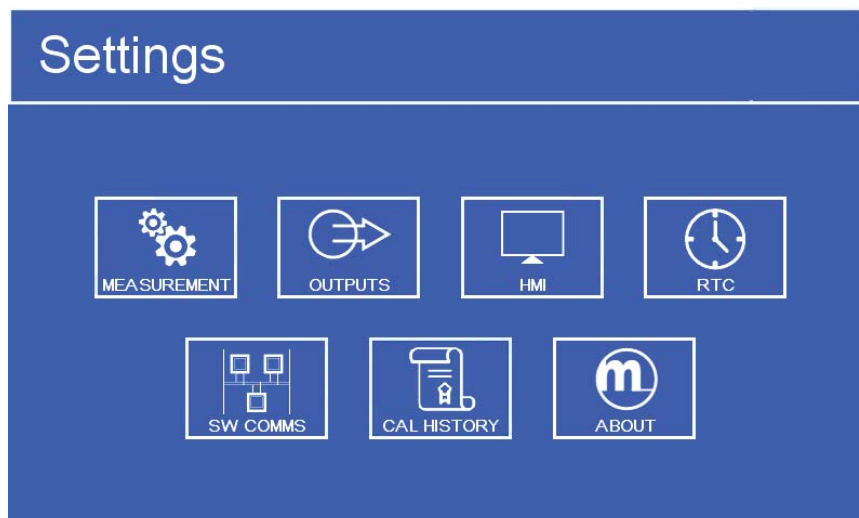

Figure 26 Settings Menu Screen

Allows access to the following sub menus to change instrument settings.

- Measurement
- Outputs
- HMI
- RTC
- SW Comms
- Cal History
- About

#### 3.7.1 Measurement Screen

This screen is accessed by pressing the **ENTER** key from the Configuration Screen.

Navigate between menu items with the **Up** (▲) and **Down** (▼) keys.

Press the **ENTER** key to change the required option. Numerical parameter options activate a pop up keypad and Carrier Gas parameter options activate a gas options screen. For more information on the keypad see Section 3.2.5.

To return to the Configuration Screen press the **ESC** key.

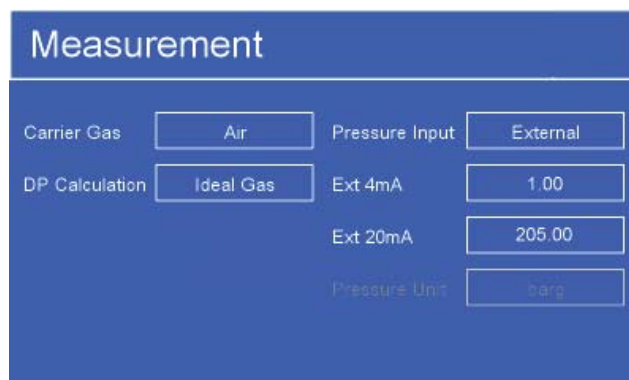

Figure 27 Measurement Screen

Parameter	Description
Carrier Gas	<p>The settings menu is accessed through the Settings item on the main screen.</p> <p><b>Available Options:</b> Air, Ar, CH<sub>4</sub>, C<sub>2</sub>H<sub>2</sub>, C<sub>2</sub>H<sub>4</sub>, C<sub>2</sub>H<sub>6</sub>, C<sub>3</sub>H<sub>6</sub>, C<sub>3</sub>H<sub>8</sub>, C<sub>4</sub>H<sub>10</sub>, CO, CO<sub>2</sub>, H<sub>2</sub>, He, Kr, N<sub>2</sub>, Ne, NH<sub>3</sub>, NO, N<sub>2</sub>O, O<sub>2</sub>, Xe, User 1, User 2, User 3</p> <p><b>User Gas Entry:</b> If a 'User' carrier gas is selected an additional option to set this gas is added to the menu. See section 3.7.1.1 for more information.</p>
DP Calculation	<p>Selects the dew-point calculation method.</p> <p><b>Available Options:</b>            IGT (IGT Bulletin #8)            ISO (ISO 18453),            Ideal Gas,</p>
Pressure Input	<p>Selects the pressure source.</p> <p><b>Available Options:</b>  <b>Atmos</b> – Atmospheric pressure.  <b>Fixed</b> – User-settable fixed value.            When the Fixed option is chosen it enables a fixed value to be entered (see screen shot below).  <b>External</b> – An externally connected pressure transducer.            When the External option is chosen it enables the choice of the zero and span range pressure transducer values of 4 or 20mA (see screen shot below).</p>
Pressure Unit	<p>for indication purposes only but can be changed in the "HMI Menu" (Section 3.7.3)</p>

Table 9 Measurement Screen

### 3.7.1.1 Carrier Gas

Used to select a different carrier gas. When the Carrier Gas option is selected the page shown below is opened.

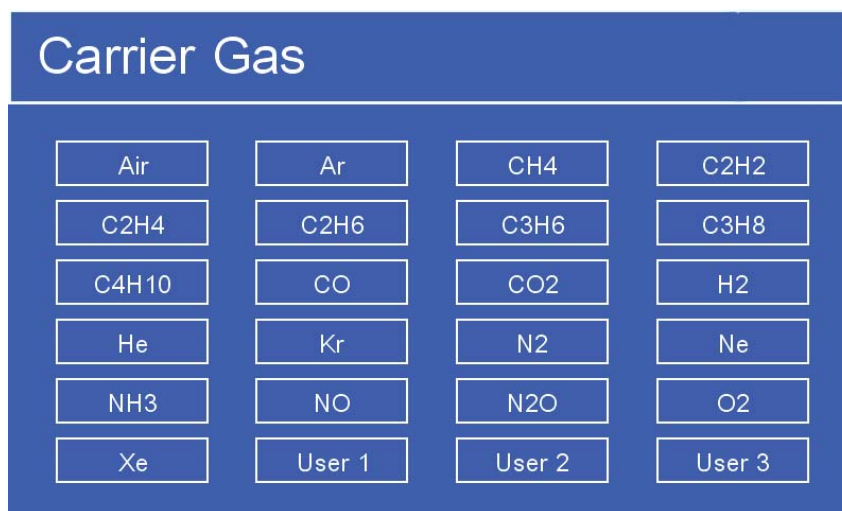

**Figure 28** *Carrier Gas Screen*

There are 20 different preset gases the user can choose from, along with 3 user definable presets:

- Air
- Argon
- Methane
- Acetylene
- Ethylene
- Ethane
- Propane
- Butane
- Propene
- Carbon Monoxide
- Carbon Dioxide
- Nitrogen
- Hydrogen
- Helium
- Neon
- Krypton
- Ammonia
- Nitric Oxide
- Nitrous Oxide
- Oxygen
- Xenon
- User 1
- User 2
- User 3

After selecting the carrier gas the user is taken back to the previous page.

**NB.** If User 1, 2 or 3 is selected as the carrier gas then a new parameter box will appear underneath the carrier gas toggle box called 'User Gas'. This can be seen below.

The screenshot shows a blue-themed interface titled "Measurement". It contains several rows of settings, each with a label and a corresponding input box:

Measurement			
Carrier Gas	User 1	Pressure Input	External
User Gas	User 1	Ext 4mA	0.00
DP Calculation	Ideal Gas	Ext 20mA	0.00
Purge	Off	Pressure Unit	barg

**Figure 29** *Measurement Screen*

When the User Gas option is selected from the carrier gas list, the user can enter the user gas settings, using the User Gas Setup page which is opened. See Appendix F for further information on calculating User Flow Correction Factors.

### 3.7.1.2 DP Calculation Method

Selects the calculation method used for dew point and lbs/MMscf. Options are:

- IGT - as per IGT Bulletin #8
- ISO - as per ISO18453
- Ideal Gas

### 3.7.1.3 Pressure Input

Selects the pressure source. Options are:

- Atmos.
- Fixed
- External

If the external option is selected the 'Fixed' selection box is hidden and replaced with the 'Ext. 4mA' and 'Ext. 20mA' selection boxes as shown below:

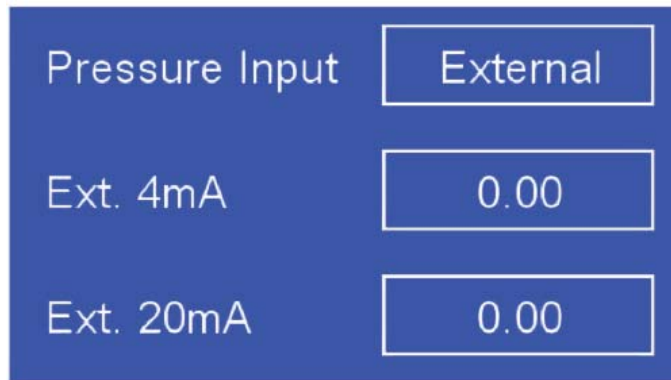

A screenshot of a blue menu titled 'External Options'. It contains three rows of settings. The first row is 'Pressure Input' with a selection box containing 'External'. The second row is 'Ext. 4mA' with a selection box containing '0.00'. The third row is 'Ext. 20mA' with a selection box containing '0.00'.

**Figure 30** *External Options*

If the fixed option is selected the 'Ext. 4mA' and 'Ext. 20mA' selection boxes are hidden and replaced with the 'Fixed' selection box as shown below:

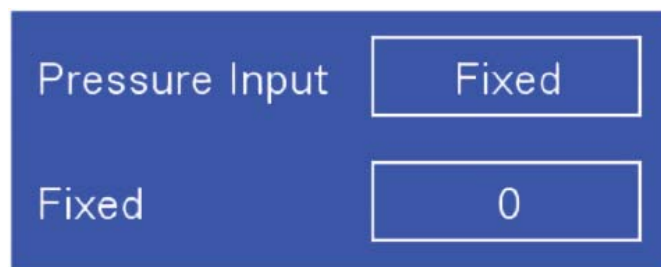

A screenshot of a blue menu titled 'Fixed Options'. It contains two rows of settings. The first row is 'Pressure Input' with a selection box containing 'Fixed'. The second row is 'Fixed' with a selection box containing '0'.

**Figure 31** *Fixed Options*

If the 'Atmos.' option is selected the 'Fixed', 'Ext. 4mA' and 'Ext. 20mA' selection boxes are all hidden as shown below:



A screenshot of a blue menu titled 'Atmos. Option'. It contains one row of settings: 'Pressure Input' with a selection box containing 'Atmos.'.

**Figure 32** *Atmos. Option*

- Fixed – Allows the user to enter the fixed pressure using the onscreen keypad.
- Ext. 4mA – Allows the user to enter the pressure at 4mA using the onscreen keypad.
- Ext. 20mA – Allows the user to enter the pressure at 20mA using the onscreen keypad.
- Pressure Unit –This displays the current Pressure unit. Please note this cannot be changed on this page.



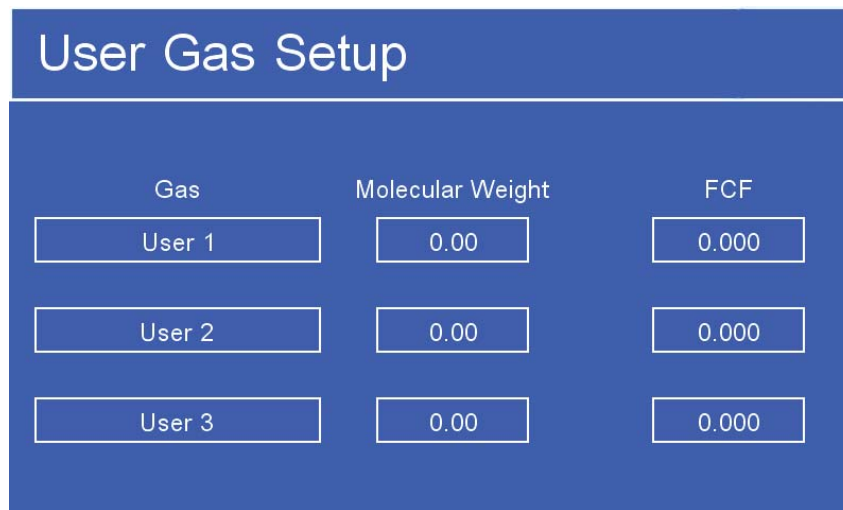

Gas	Molecular Weight	FCF
User 1	0.00	0.000
User 2	0.00	0.000
User 3	0.00	0.000

**Figure 33** *User Gas Setup Screen*

- Gas – Allows the user to enter a unique name for the gas using the onscreen keypad.
- Molecular Weight – Allows the user to enter the molecular weight of the gas using the onscreen keypad.
- FCF – Allows the user to enter the Flow Correction Factor using the onscreen keypad. See Appendix B for instruction on how to calculate the FCF.

### 3.7.2 Outputs Screen

The Outputs Screen allows the two analog output channels to be set up. It is accessed through the 'Outputs' item in the 'Settings menu'.

This screen is accessed by pressing the **ENTER** key from the Configuration Screen.

Navigate between menu items with the **Up (▲)** and **Down (▼)** keys.

Select output required with the **ENTER** key.

Press the **ENTER** key to change the required option. Numerical parameter options activate a pop up keypad. For more information on the keypad see Section 3.2.5.

To return to the Configuration Screen press the **ESC** key.

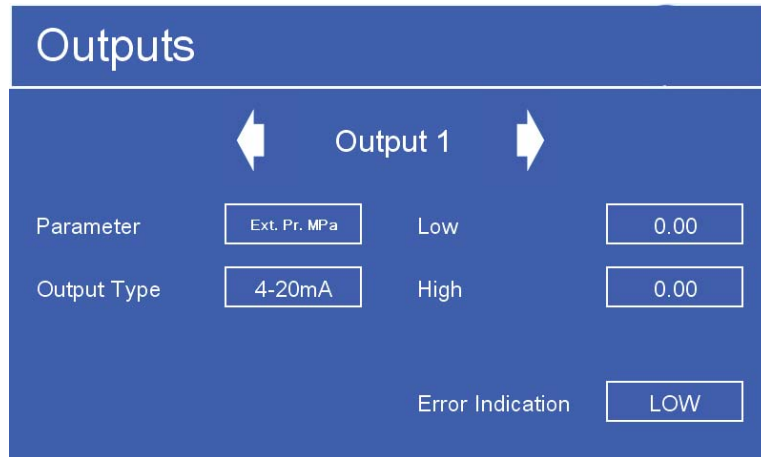

Figure 34 Outputs Screen

Parameter	Description
<b>Output Selector</b>	Selects the output channel to check and modify. <b>Available Options:</b> Output 1, Output 2
<b>Parameter</b>	Selects the parameter tracked by the output channel. <b>Available Options:</b> H2O ppmv, H2O ppmw, mg/m3, WVP Pa, H2O lbs/MMscf, DP, Oven, Flow, Cell Pr., Ext. Pr.
<b>Output Type</b>	Selects the signal type of the output. <b>Available Options:</b> 1-5 V, 4-20 mA
<b>Low</b>	Sets the lower output limit for the selected parameter.
<b>High</b>	Sets the higher output limit for the selected parameter.
<b>Error Indication</b>	Selects the error indication level for the outputs. <b>Available options:</b> LOW (3.2 mA / 0.80 V) HIGH (21.4 mA / 5.35 V)

Table 10 Outputs Screen Parameters

### 3.7.3 HMI Screen

The HMI Screen allows the setting of the display language, parameters and measurement units. It is accessed from either the HMI item on the Settings menu or directly during the QMA601 warm up procedure.

This screen is accessed by pressing the **ENTER** key from the Configuration Screen or from the Oven heating Screen at start-up. If this screen is entered during start-up - after any adjustments have been made press the **ESC** key twice to return to the Main Screen.

Navigate between menu items with the **Up (▲)** and **Down (▼)** keys. Select output required with the **ENTER** key.

Press the **ENTER** key to change the required option. Numerical parameter options activate a pop up keypad. For more information on the keypad see Section 3.2.5.

To return to the Configuration Screen press the **ESC** key.

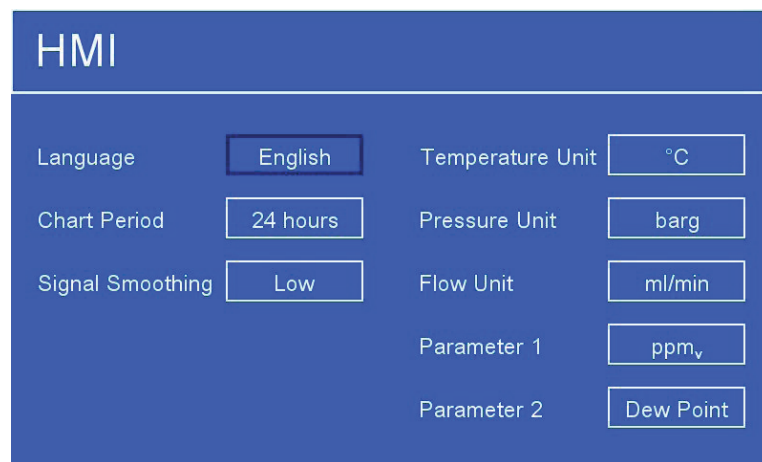

**Figure 35** *HMI Screen*

Parameter	Description
Language	Sets the HMI language <b>Available Options:</b> English, Japanese
Chart Period	Selects the time scale of the chart. Changing the chart period will remove all current data from the chart. <b>Available Options:</b> 5 mins, 30 mins, 1 hr, 5 hrs, 10 hrs, 24 hrs
Signal Smoothing	Select the signal smoothing level. <b>Available Options:</b> Low, medium, high
Temperature Unit	Selects the displayed temperature units. <b>Available Options:</b> °C, °F
Pressure Unit	Selects the units in which the pressure measurements are displayed. <b>Available Options:</b> barg, bara, psig, psia, MPag, mmHg, MPa Abs
Flow Unit	Selects the flow units. <b>Available Options:</b> ml/min, sccm/min
Parameter 1	Selects the parameter to be displayed on the front page and logged on the front page chart. <b>Available Options:</b> ppmv, ppmw, mg/m <sup>3</sup> , WVP Pa, lbs/MMscf, Dew Point, Oven Temp., Flow Rate, Cell Pr., External Pr
Parameter 2	Selects the secondary parameter to be displayed on the front page. Available Options: ppmv, ppmw, mg/m <sup>3</sup> , WVP Pa, lbs/MMscf, Dew Point, Oven Temp., Flow Rate, Cell Pr., External Pr.

Table 11 HMI Setup Screen Parameters

### 3.7.4 Real Time Clock Screen

The Real Time Clock screen is used to set the current date and time parameters for the instrument. It is accessed through the RTC item on the Settings menu.

This screen is accessed by pressing the **ENTER** key from the Configuration Screen.

Navigate between menu items with the **Up (▲)** and **Down (▼)** keys.

Press the **ENTER** key to access the menu item. Numerical parameter options activate a pop up keypad. For more information on the keypad see Section 3.2.5.

To return to the Configuration Screen press the **ESC** key.

**Figure 36** Real Time Clock Screen

Parameter	Description
<b>Day / Month / Year</b>	Sets the current date for the real time clock.
<b>Hour / Minute</b>	Sets the current time for the real time clock.
<b>Save Date</b>	Saves the updated date.
<b>Save Time</b>	Saves the updated time.

**Table 12** Real Time Clock Screen Parameters

### 3.7.5 Software Communications Screen

The Software Communication screen is used to set the physical method the QMA601 uses to communicate with external software. It is accessed through the 'SW COMMS' item on the Settings menu.



Figure 37 Software Communications Screen

Parameter	Description
Instrument ID	Instrument's Modbus address.
Protocol	Sets the physical communication method. <b>Available Options: RS485 / USB / Ethernet. (Note - Ethernet option only shows if this is installed.)</b>
Address	Opens the menu to set the Ethernet network parameters. This is only present if Protocol is set to Ethernet.

Table 13 Software Communications Screen Parameters

### 3.7.6 Ethernet Screen

The Ethernet screen is used to set the Ethernet network parameters. It is accessed from the address button on the Software Communications screen.

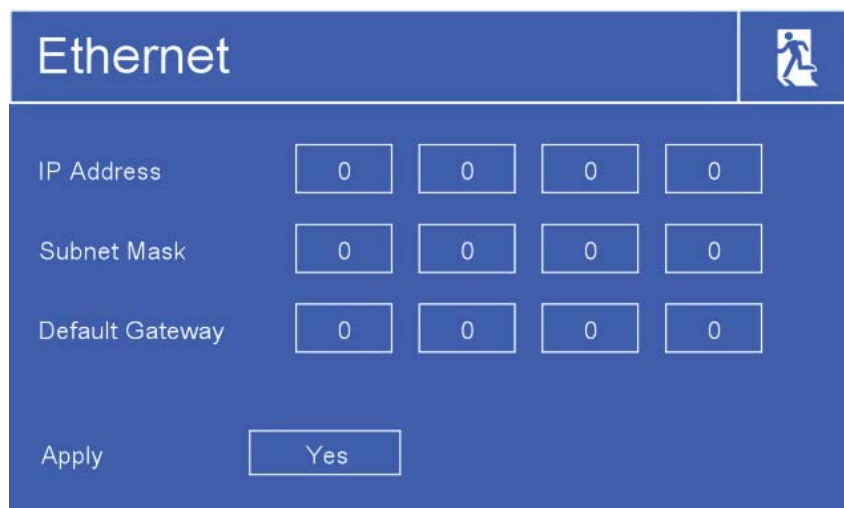

Figure 38 Ethernet Screen

Parameter	Description
IP Address	Instrument's static IP address on the network.
Subnet Mask	Subnet mask of network that the instrument is on.
Default Gateway	The default gateway of the network that the instrument is on.
Apply	Saves Ethernet settings.

Table 14 Ethernet Screen Parameters

### 3.7.7 Field Calibration History

The Calibration History page contains a summary of the previous five Sensor Correction Factors (SCF)s. The page also contains an option to re-load any of these SCFs.

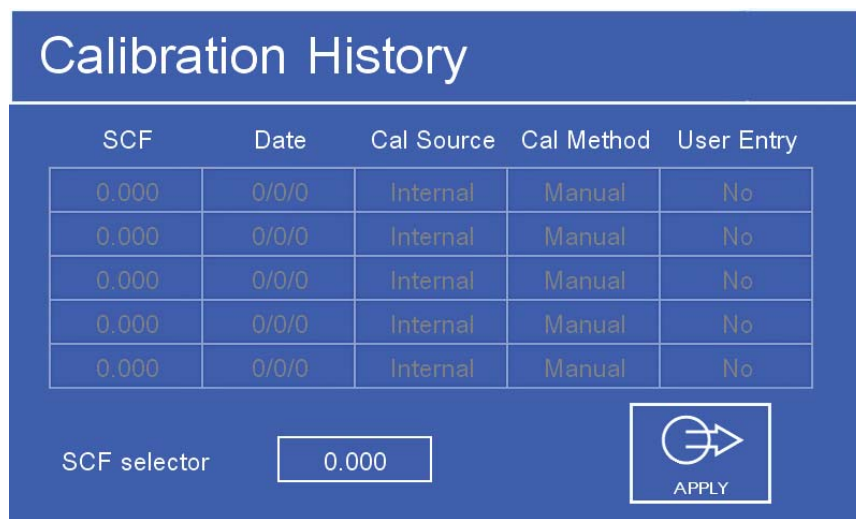

Figure 39 Calibration History Screen

Parameter	Description
SCF Selector	Cycles through the results of each previous calibration cycle
Apply	Applies the SCF from the selected previous calibration cycle

Table 15 Calibration History Screen

### 3.7.8 About Screen

This screen displays the analyzer firmware versions, serial numbers and protected service pages. This screen is accessed from the settings menu.

To return to the Configuration Screen press the **ESC** key.

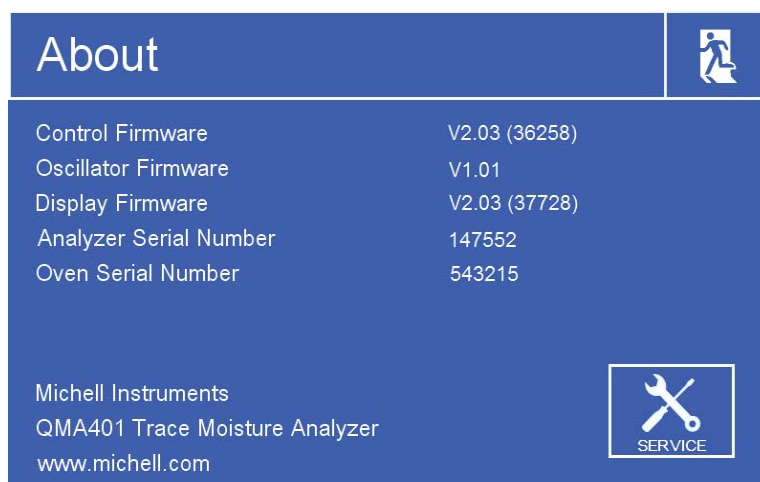

**Figure 40** *About Screen*

The service pages are intended for Michell Instruments approved personnel only. They do not contain any user accessible functions.

### 3.8 Sampling Guidelines

The QMA601 is designed to operate in a flowing gas stream and is suitable for the measurement of the moisture content of a wide variety of gases. In general, if the gas (in conjunction with water vapor) is not corrosive to the sampling system and the sensor base metals then it will be suitable for measurement by the QMA601.

The analyzer is designed to automatically regulate the sample flow rate. However, the sample pressure and back pressure must match what is shown on the calibration certificate (typically 3 barg (43.5 psig) sample pressure, 2 barg (29 psig) back pressure), and should be controlled using a high-quality pressure regulator on the gas inlet and a back pressure regulator on the outlet.

Dried samples and wet samples are alternately passed through the sensor cell. The difference in the measured beat frequency produced by the wet and dry samples is proportional to the moisture content in ppm<sub>v</sub> of the gas being analyzed.

General guidelines to be followed when setting-up a sampling system are as follows:

- **Ensure that the sample is representative of the gas under test**

To ensure that the sample is representative of the process being monitored, the sample point should be as close to the critical measurement point as possible. Also, never sample from the bottom of a pipe where entrained liquids may be drawn into the analyzer's sample input line.

- **Minimize the 'dead space' in sample lines**

Dead space in sample lines causes moisture entrapment points, increased system response times or measurement errors as the trapped moisture is released into passing sample gas, producing an increase in partial vapor pressure.



Avoid the use of too many T-pieces, in-line couplings or other unnecessary tubework. Sample tubework should, ideally, be specially designed for each application rather than adapted from that previously installed for another application. Dead space in sample lines increases response time by holding water molecules which are more slowly released to the passing gas sample.

- **Remove any particulate matter or oil from the gas sample**

Particulate matter can damage the sensors. If particulate matter, such as degraded desiccant, scale or rust, is likely to be present in the sample gas use a particulate in-line filter. Michell Instruments' technical sales department can be contacted for advice.

- **Use high quality sample tube fittings**

The sample tubework must be capable of withstanding the operating pressure of the sample line. Wherever possible, always use stainless steel tubework and fittings. This is particularly important at low dew points since other materials, e.g. nylon, have hygroscopic characteristics and adsorb moisture on the tube walls, giving rise to slower measurement response and, under certain circumstances, false readings.

In order to maximize response time, always use the shortest run of tubework and the smallest bore possible, taking care not to induce pressure differentials by aiming for too high a flow rate through too small a bore. Michell Instruments supplies a range of precision pressure fittings suitable for use with the QMA601. Contact Michell Instruments for details of the items available.

- **Gas samples**

Generally, if the sample gas (in conjunction with water vapor) is not corrosive to base metals, it will be suitable for measurement by the QMA601 analyzer. Gases containing entrained solids should be filtered before application to the analyzer.

Care should be taken with gas mixtures containing potentially condensable components in addition to water vapor, e.g. oil, to ensure that only water vapor is present in the sample. Once present on the surface of the sensors, oil will not dry out and will contaminate and damage them.

- **Material of construction**

All materials are permeable to water vapor, as the water molecule is extremely small compared to the structure of solids, even when compared to the crystalline structure of metals.

Many materials contain moisture as part of their structure, particularly organic materials, salts and anything which has small pores. It is important to ensure that the materials used are suitable for the application.

If the partial water vapor pressure exerted on the outside of a compressed air line is higher than on the inside, the atmospheric water vapor will naturally push through

the porous medium against a dry air water vapor pressure. Water will migrate into the pressurized air line, this effect is called transpiration.

Over a long tube run water will inevitably migrate into any line even through the most resistant materials. Moisture on the outlet of the line will be different than on the inlet. The best material to resist transpiration is 316L stainless steel.

It is also important to note that temperature changes can increase the tendency of these materials to affect the humidity of the surrounding air. With a given surface and gas composition, increases of line pressure and decreases in temperature increase surface adsorption.

- **Internal material surface finish**

Components with a smooth surface finish are always preferred. If a choice of surface finish is available for the materials dictated by the process or sample system, select the smoothest for fastest response.

- **Tube diameter**

The larger the sampling tube diameter, the more exposed the gas will be to the tube wall. Therefore it is recommended to use the smallest possible tube diameter to minimize the previously mentioned effects. This must be balanced with the desired response speed. Depending on the configuration 1/8" tube diameter is recommended. Please contact Michell Instruments if further recommendations are needed.

- **Ambient temperature variation**

Fluctuations in ambient temperature conditions can cause detectable changes in the sample gas' moisture content due to heating/cooling of the sample system. Small molecules such as water will migrate through the wall until the entire system reaches a new equilibrium. It is possible to minimize this effect on a sampling system by heat tracing sample lines and insulating/heating the sampling system enclosure to a stable temperature above the maximal ambient temperature.

It is important to control the temperature of all components of the sampling system, including regulators and sample lines. For this reason it is strongly advised to use heat traced lines to eliminate this temperature change effect and measure moisture content solely related to the gas under test.

### 3.9 Measurement Cycle

At the beginning of a measurement cycle V1 is energized. This allows the dried sample gas to be routed to the sensor cell for or the reference phase duration as shown by the red line in *Figure 41*. During this first phase of the measurement cycle the difference in frequency between the sensor and reference crystals is measured.

The sample and calibration gas paths are shown in green. These lines are continually purged during the reference phase of the measurement cycle.

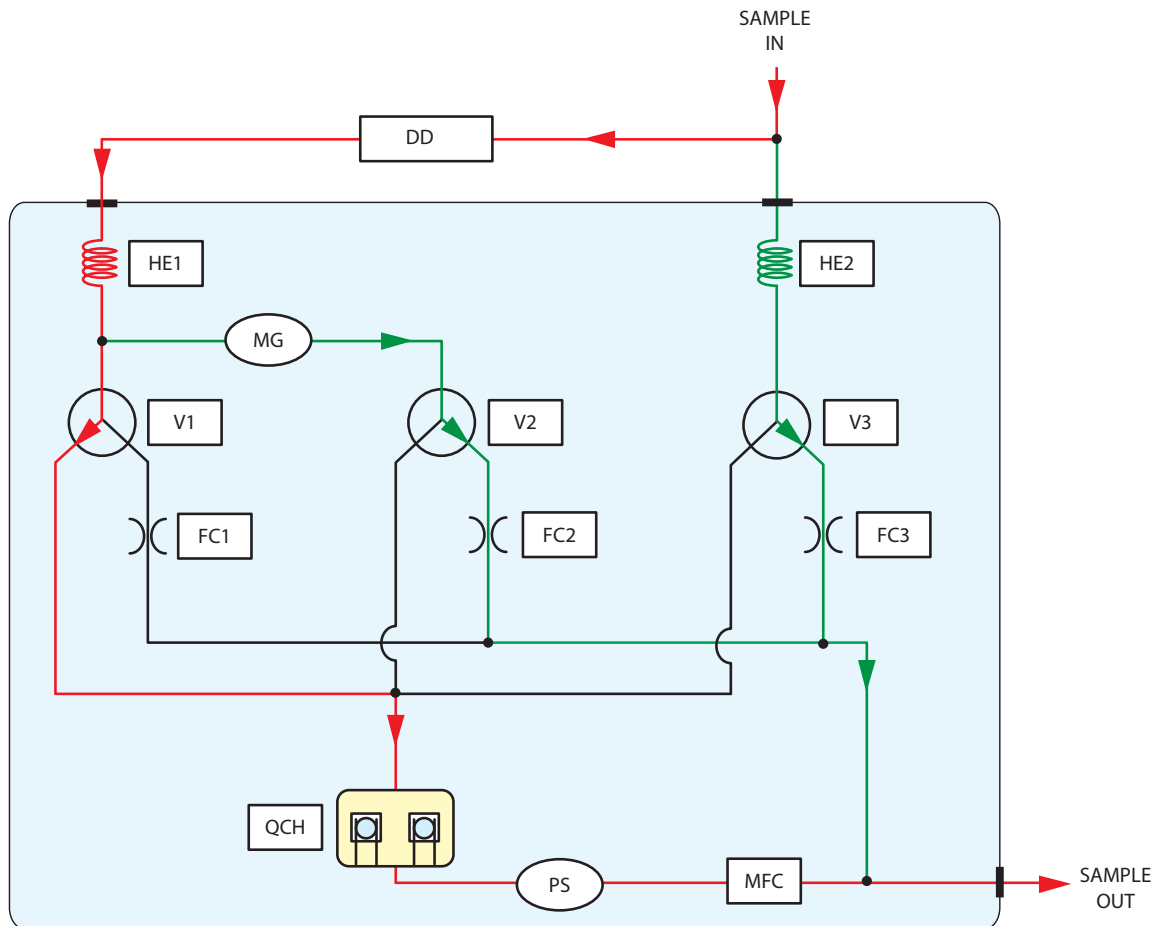

Key			
DD	Desiccant column	MG	Moisture generator
MFC	Mass flow controller	V1, V2, V3	Solenoid Valves
QCH	Sensor cell	HE1, HE2	Heat exchanger
PS	Pressure sensor	FC1, FC2, FC3	Flow control

Figure 41 Measurement Cycle (Reference phase) - Dried Sample Flow

After a 30 second sampling period, V1, V2, and V3, the reference phase is de-energized. This cuts off the dried gas supply to the sensor cell and V3 is energized connecting the sample gas (red line - see *Figure 42*) to the sensor cell for the sample phase duration. The reference and calibration gas paths are shown in green. These lines are continually purged during this second sample of the measurement cycle.

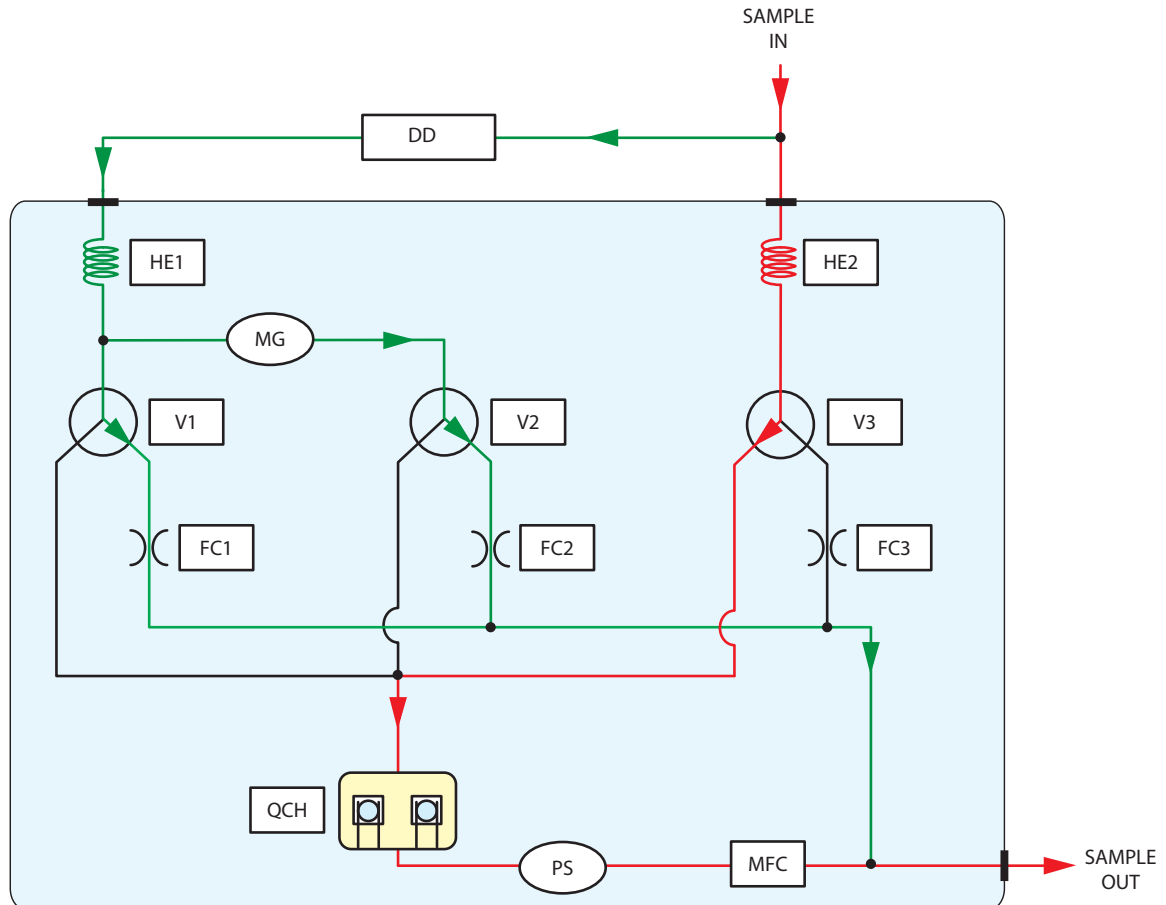

Key			
DD	Desiccant column	MG	Moisture generator
MFC	Mass flow controller	V1, V2, V3	Solenoid Valves
QCH	Sensor cell	HE1, HE2	Heat exchanger
PS	Pressure sensor	FC1, FC2, FC3	Flow control

**Figure 42** Measurement Cycle (Sample phase) Calibration Flow

During this sample phase of the measurement cycle the difference in frequency between the reference and sensor crystals is measured again. After signal processing the measured difference in frequency between the reference and sample phases is proportional to the moisture content of the sample gas.

### 3.10 Calibration Cycle

To maintain the accuracy of the analyzer, the unit can self calibrate and adjust its internal reference based on the result.

This is achieved as follows:

An internal moisture generator uses a permeation tube to generate a nominal moisture content of 0.5, 5 or 50 ppm<sub>v</sub>, depending on what was specified at the time of order.

The calibration is carried out in a two phase cycle. This is shown by the red line in Figure 43. The calibration and sample gas paths (as shown by the green lines) are constantly kept purged.

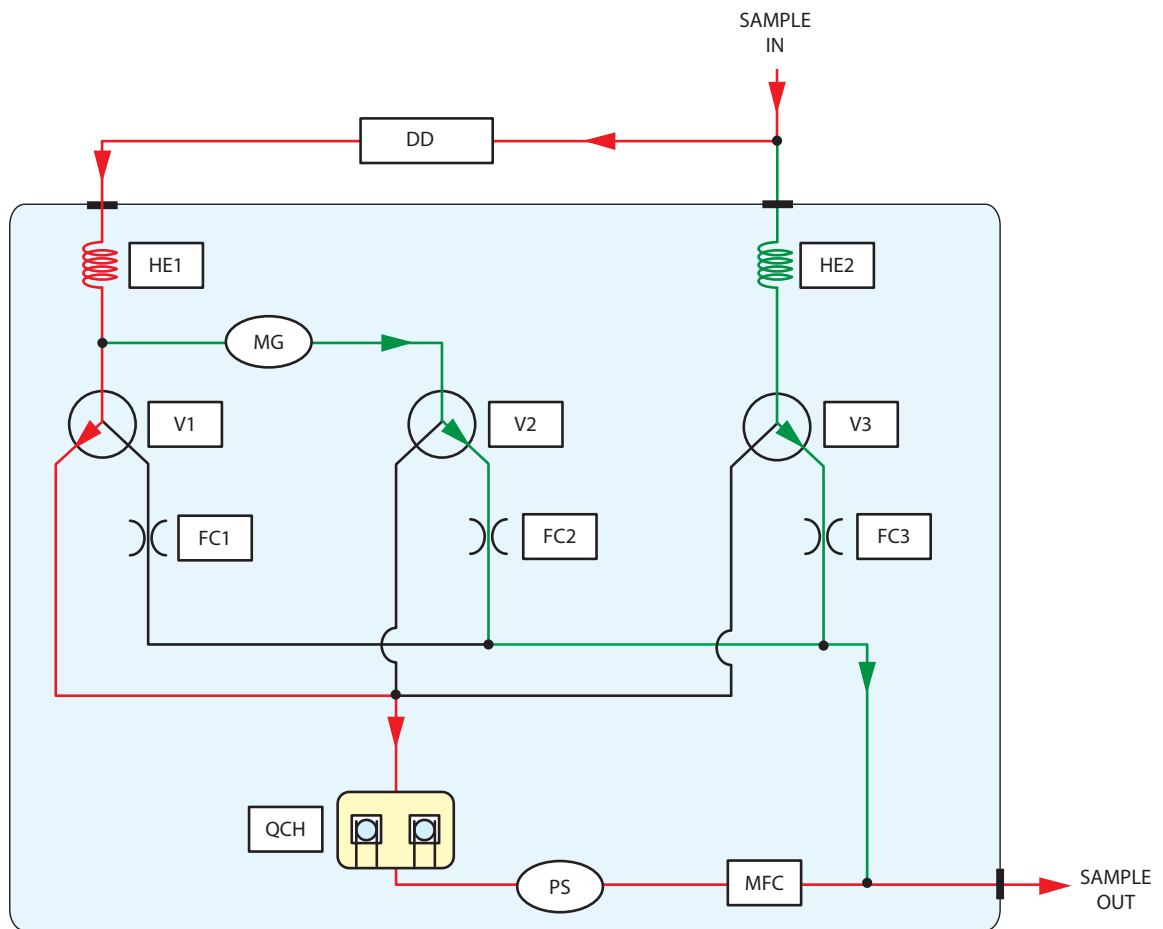

Key			
DD	Desiccant column	MG	Moisture generator
MFC	Mass flow controller	V1, V2, V3	Solenoid Valves
QCH	Sensor cell	HE1, HE2	Heat exchanger
PS	Pressure sensor	FC1, FC2, FC3	Flow control

**Figure 43** Calibration Cycle (Reference phase) - Dried Sample Flow

At the close of this 30 second sampling period, V1 is de-energized, and V2 is energized so that the reference gas from the moisture generator is now routed to the sensor cell. This is the beginning of the calibration phase, see *Figure 44*.

The calibration reference gas is measured for a further 30 seconds, until V2 is de-energized and the reference phase begins again.

The reference and sample paths are continually purged during each phase (as shown by the green lines in *Figure 44*) during the calibration phase.

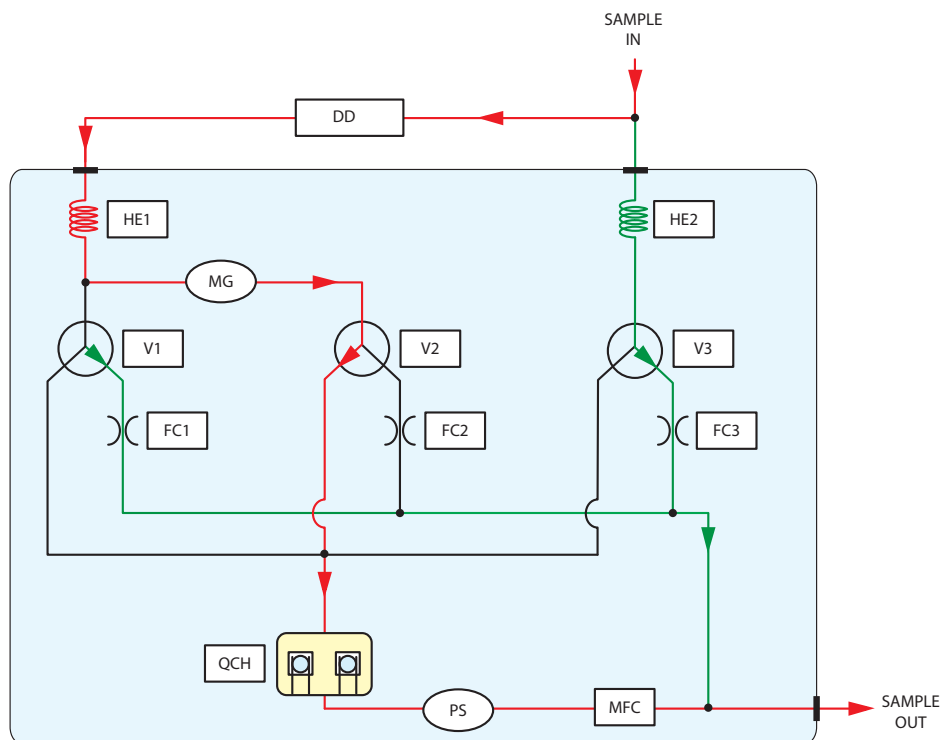

Key			
DD	Desiccant column	MG	Moisture generator
MFC	Mass flow controller	V1, V2, V3	Solenoid Valves
QCH	Sensor cell	HE1, HE2	Heat exchanger
PS	Pressure sensor	FC1, FC2, FC3	Flow control

**Figure 44** Calibration Phase - Sample Flow

If an external calibration gas is used, the 'Cal Source' and 'Ext Ref' values should be entered onto the Field Calibration screen (Section 3.6.4). The field calibration then follows the same phases as used during a standard measurement cycle, as the internal moisture generator is no longer required.

The analyzer will run through a number of 'settling cycles' to ensure the internal sample system is fully equilibrated with the calibration gas before beginning to collect calibration data.

After the system has carried out the selected number of settling cycles, it begins the calibration cycles. During these cycles, the difference between the calibration reference gas and the dried gas is measured. As the moisture content of the calibration gas is known, the difference between this and the measured value is equal to the error in the system.

The QMA601 stores this correction factor and automatically compensates subsequent sample readings for any offset that may have occurred to the factory calibration.

## 4 MAINTENANCE

**The power to the enclosure must be turned off before any work is carried out in the measurement system enclosure.**

**Before commencement of the start-up procedure ensure that all power and signal connections to the QMA601 are fully isolated and if necessary observe the stipulated de-energization period of 45 minutes.**



**Gas line connections to the measurement system must be isolated and de-pressurized before any work commences.**

**Any loose or disturbed tubework or couplings must be leak tested.**

The design of the QMA601 and measurement system is such that no specific routine maintenance is required. However, if a fault does occur with the system that is not covered within this manual please contact Michell Instruments (see contact information at [www.michell.com](http://www.michell.com)) or your local representative.

The QMA601 is a certificated product for use in Zone 1 Hazardous Areas. Any maintenance of this product should only be conducted by suitably trained personnel and in accordance with locally applying regulations. Any unauthorized maintenance of this product could invalidate the product warranty.

In addition to general maintenance procedures which involve the cleaning of the analyzer's casing and display, there are a number of parts in the QMA601 which can be removed and replaced by the operator.

They are as follows:

- Power supply fuse (see Section 4.2)
- Optional contamination trap (see Section 4.3)
- Desiccant column (see Section 4.4)



## 4.1 Safety



This equipment operates from power supply voltages that can be lethal.

Ensure that any installation meets the standards described in Section 2 of this handbook.

Under NO circumstances should the analyzer's covers be removed while the analyzer is in operation or the air vents covered or in any way restricted.

Maintenance and repair must only be carried out by competent personnel or alternatively, returned to the manufacturer for this purpose.

## 4.2 Removal and Replacement of the Power Supply Fuse

This product is provided with an internally mounted fuse located beneath the power connector.

The fuses are rated at:

Mains 240 V AC -	3 A
24 V DC -	5 A

**NOTE: Only these types of fuses must be used.**

Replacement fuses can be obtained by contacting Michell Instruments' technical support.

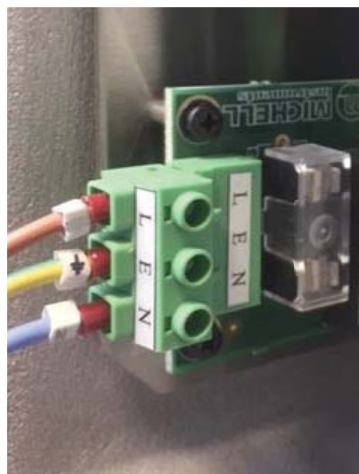

## 4.3 Replacing the Optional Contamination Trap

The contamination trap is part of the QMA601 additionally supplied sample system. Refer to the application specific sample system design requirements for the removal and fitting of this part.

F0131 Hazardous Area/Hazardous Location Product Servicing: Customer Report & Declaration is required before commencing any service work/exchange.

If the contamination trap is to be returned to Michell Instruments, or a Michell Instruments' approved service center form, the F0121 Decontamination Certificate must be completed and sent with the returned trap.

#### 4.4 Removal and Replacement of the Desiccant Column

##### Removal

1. Isolate the sample gas supply and de-pressurize the QMA601 sampling system. **NOTE: Goggles should be worn at all times when working with pressure.**
2. When the sample system has been depressurized, use the spanner/wrench sizes indicated below to disconnect the VCR fittings on the Desiccant Column.

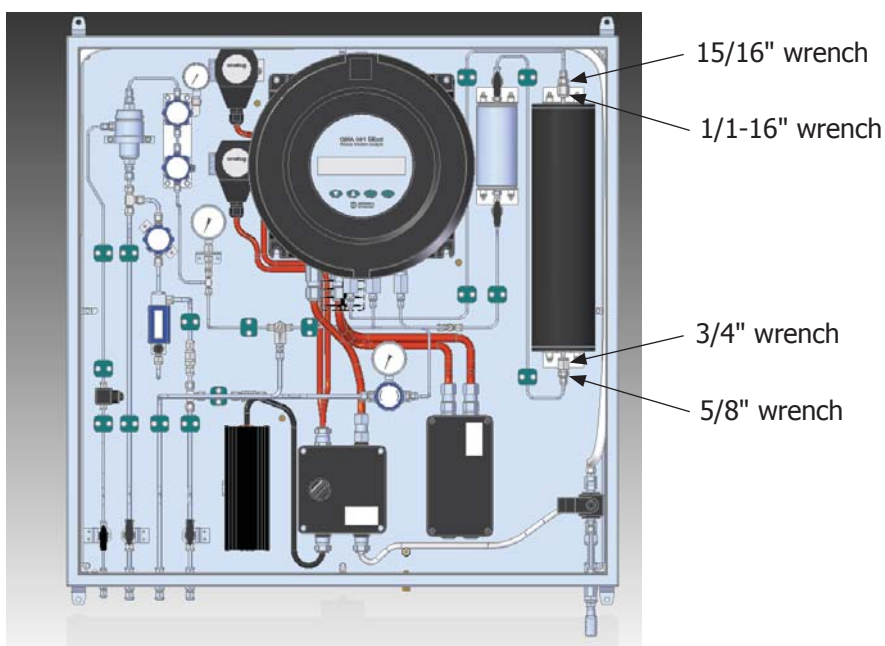

3. Pull and twist the index plungers to the unlock position.

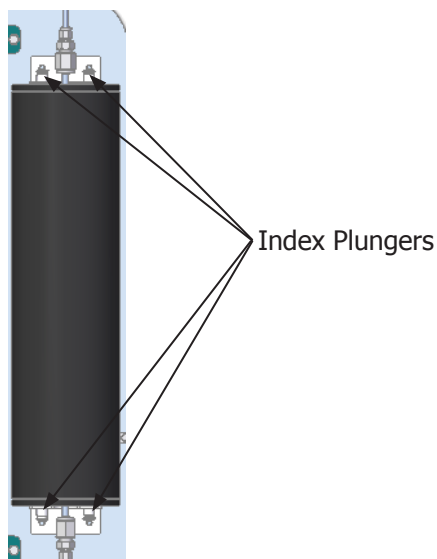

4. Lift out the Desiccant Column.

### Replacement

1. Before fitting the new Desiccant Column, push the new snubber on to the top VCR fitting, and fit a new VCR face seal to the bottom VCR fitting.  
**NOTE: Be careful when removing the snubber, as the desiccant will pour out of the VCR fitting if the dryer is tipped up.**



2. Install the Desiccant Column into the system, with the snubber at the top, and the VCR face seal at the bottom, as shown above. Twist the index plungers to the lock position.
3. Check that the Desiccant Column is secure and locked into the brackets. Tighten the VCR fittings using the spanner/wrench sizes indicated on the previous page, being careful not to over-tighten the fittings.

### Leak Check

1. After installation of the new Desiccant Column the system should be re-pressurized and leak checked.
2. Only the two connection points of the Desiccant Column should need leak checking. A foaming liquid leak detector such as Swagelok's Snoop should be used.

## 5 CALIBRATION

### 5.1 Traceability

The original factory calibration of this analyzer is traceable to national standards.

The analyzer is calibrated at a fixed pressure over the sensing crystals, and the analyzer's calibration is only valid while the inlet pressure and back pressures have been set correctly.

A calibration certificate bearing the calibration data points is issued with each analyzer. If required, an option is available to specify the number of required calibration points by contacting Michell Instruments. A list of worldwide Michell Instruments' offices is provided at [www.michell.com](http://www.michell.com).

*Figure 45* shows a typical calibration certificate.

## CERTIFICATE OF CALIBRATION

QMA 601



The under-mentioned item has been calibrated at the following points in the Michell Instruments' Humidity Calibration Laboratory against Test Equipment traceable to the NATIONAL PHYSICAL LABORATORY, Middlesex, United Kingdom and to the NATIONAL INSTITUTE OF STANDARDS & TECHNOLOGY, Gaithersburg, Maryland, USA.

<b>Certificate Number</b>	0	<b>Analyzer Serial Number</b>	0
<b>Acknowledgement Number</b>	0	<b>Oven Serial Number</b>	0
<b>Test Date</b>	17/07/15	<b>Beat Frequency (Hz)</b>	7827
<b>Test Equipment</b>	Q0433	<b>MG Moisture Level (ppm)</b>	54.37
<b>Calibration Temperature (°C)</b>	21 (+/-2)	<b>Inlet/Sensor Pressure (barg)</b>	3
<b>Work Instruction Number</b>	520	<b>Outlet/Back Pressure (barg)</b>	2

## Reference (ppm)

Measured Moisture  
Content (ppm)

0.130	0.128
0.291	0.289
1.401	1.469
5.371	5.728
17.51	18.62
58.26	59.96
111.4	108.7
204.7	198.6
616.3	591.6

Comments: N/A

Calibration PASS. The results are within specification of the analyzer at the measured points detailed.

Traceability to National Physical Laboratory is over the range -90°C to +90°C. (0.095 to 2253559 ppmV)

Traceability to National Institute of Standards and Technology is over the range -75°C to +20°C. (1.204 to 23632 ppmV)

**Approved Signatory:**

**Date of Issue:** 27/07/15

**Figure 45** Typical QMA601 Calibration Certificate

## 6 SHIPPING

### 6.1 Preparation for Shipping and Packing if Not Supplied as a Sample System

For shipping purposes, the analyzer should be packed into its original crate as this will provide the recommended degree of protection during transit.

To prepare the analyzer for shipping, proceed as follows:

1. Isolate the incoming sample line and depressurize the system. Remove the connections to the GAS IN and GAS OUT ports. Purge the gas lines with dry nitrogen to remove potentially corrosive gases.
2. Switch off the analyzer, isolate the power supply and remove the power supply cable.
3. Remove the analog connector and alarm output connectors.
4. Pack the analyzer in its original crate by first fitting the end packing, and lowering the analyzer into the crate. Place any accessories being returned in the accessories box and place in the crate last.
5. Create a packing list detailing all equipment contained in the crate, place it inside and seal the crate.

## 7 APPLICATION SOFTWARE OVERVIEW

With the QMA Application Software you can:

- Read and edit all main analyzer parameters
- Chart and log all main analyzer parameters
- Perform a field calibration
- Reset the analyzer to factory defaults

Communication between the application software and analyzer is via Modbus RTU over RS485, USB, or Ethernet where available.

### 7.1 System Requirements

For the best software performance, the host computer should meet the following minimum requirements:

O/S	Windows XP, Windows VISTA, Windows 7 (32-bit or 64-bit), Windows 8 (32-bit or 64-bit)
CPU	Intel Pentium III 500 MHz (recommended: Pentium 4 1.6 GHz or Pentium M 1.0 GHz, or Athlon 1.2 GHz or higher)
RAM	512 MB (recommended: 1.0 GB)
Disk space	Application = 10 MB

### 7.2 System Connection

RS485 and USB communications should be connected to an available port on a local computer using the appropriate cable. For Ethernet communications connect an Ethernet cable to a network access point.

For information the default communication settings are:

Baud	9600
Parity	NONE
Data bits	8
Stop bits	1

### 7.3 Getting Started

On launching the software the connection console will appear, allowing you to establish communications between the software and QMA analyzer.

Choose the Modbus slave address (default is 1). Select the Connection Method for the analyzer and associated options. For more information see Section 7.3.1.

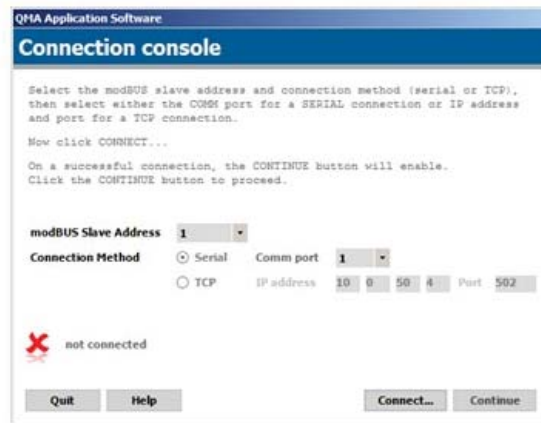

Click the 'Connect...' button.

After a few seconds the software will report a successful connection or not. If the connection is successful, the word 'Connected' and a green tick will appear.

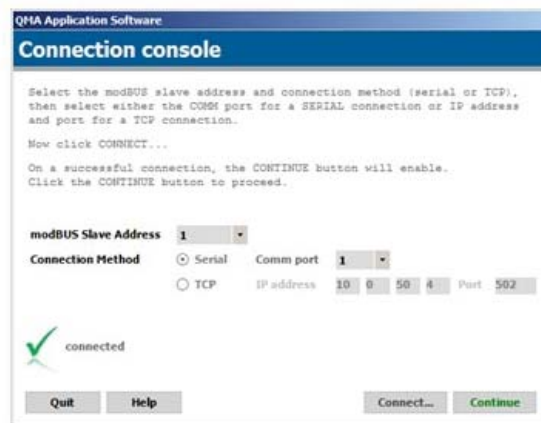

Click the 'Continue' button to continue onto the main acquisition window.



### 7.3.1 Connection Method (Serial Connection (RS485 or TCP))

Select the connection method for the analyzer.

#### 7.3.1.1 RS485 Connection

An RS485 to RS232 converter must be used when connecting to a computer's built in serial port, or when connecting to an RS232 to USB adaptor.

To find the COM port number assigned to a USB to RS232 adapter, open Windows 'device manager' and expand the 'Ports (COM & LPT)' branch.

The USB to RS232 adapter should be listed in this branch, together with its COM port number.

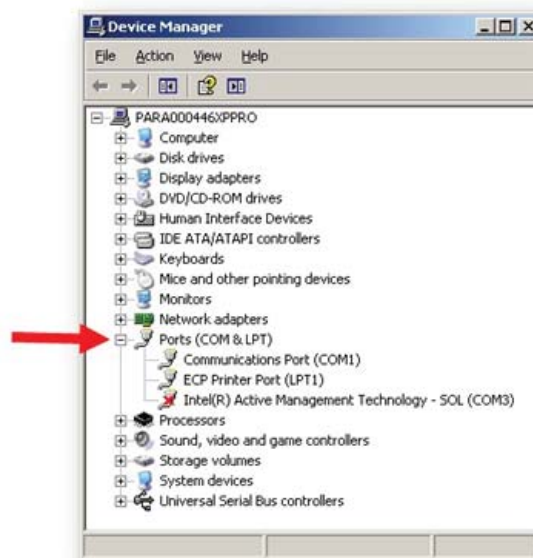

#### 7.3.1.2 Modbus TCP Connection (Ethernet)

Enter the IP address and port number of the analyzer. The instrument IP and port should be first configured in the Ethernet menu. See section 3.7.6 for further information.

## 7.4 Main Window

The application software will automatically begin acquiring, displaying and charting data from the analyzer once a connection has been established.

Data acquisition occurs approximately every 2 seconds. The chart update rate is 2 seconds but this may be changed by using the chart options window.

Data logging does not start automatically, this is indicated by the text 'NOT LOGGING' on the Main Screen. Click the 'Data Logging' button to launch the data logging setup window (See section 7.6).

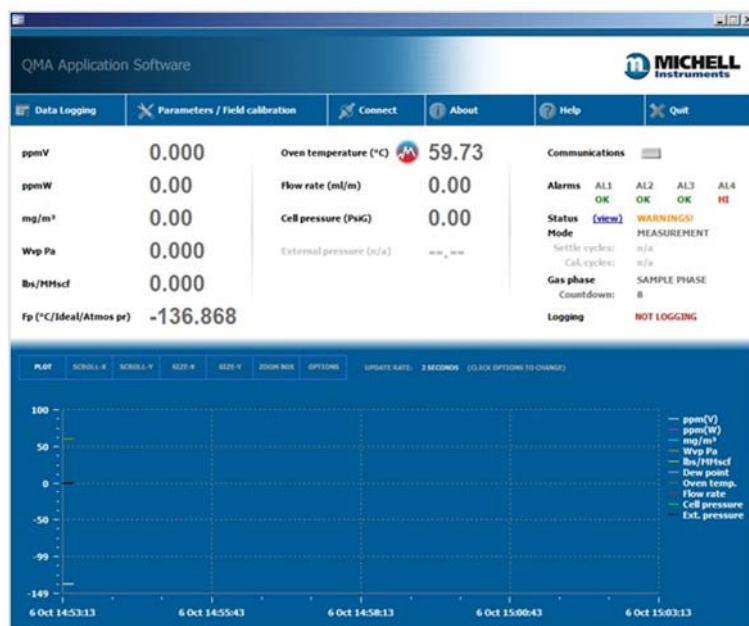

To configure analyzer parameters, click the 'Parameters / Field calibration' button to launch the parameters window (See section 7.7).

Click the 'Connect' button to re-connect with the analyzer or connect with a new analyzer.

## 7.5 Using the Chart

### Chart mode buttons

The chart defaults to plot mode.

To change the chart mode, click one of the buttons along the top of the chart, described below.

Function	Description
PLOT	Puts chart into live plot mode
SCROLL-X	Allows the user to scroll the X-axis left and right
SCROLL-Y	Allows the user to scroll the Y-axis up and down
SIZE-X	Allows the user to re-scale the X-axis
SIZE-Y	Allows the user to re-scale the Y-axis
ZOOM BOX	Allows the user to draw a box in the data area which will zoom in on the data within the box. The box is drawn from top-left to bottom-right
OPTIONS	Opens the chart options window

**Table 16** Using the Chart

After using the scroll, size or zoom modes, changing the chart back to plot mode resets the x and y axes. This functionality depends on the 'Restore on Plot Mode' option being selected in section 7.5.1.



### 7.5.1 Chart Options Window

The Chart Options Window allows the user to configure the following chart properties:

Function	Description
Show/hide series	Allows the user to show or hide data series from the chart. Tick to show, untick to hide
Update rate	Allows the user to change the update rate of the chart
Reset chart	Clears all chart data
Restore on plot mode	When ticked, selecting plot mode will restore the X and Y axis to the state before they were modified (after sizing, zooming or scrolling)
Y-axis scale	Select either 'autoscale all data' or 'manual scaling' of the Y-axis. Selecting manual scaling will show a min and max input text box

**Table 17** Chart Options



## 7.6 Data Logging

Click the 'Data Logging' button on the Main Window to launch the Data Logging Setup Window.



### Choosing a log file filename

Choose a log file manually by clicking the  button.

Click the 'Auto generate' button to generate a filename based on the current date and time.

An auto generated log file filename has the following format:

QMA dd-mm-yy hh:mm:ss.log

where dd = date, mm = month, yy = year, hh = hour (24 hr), mm = minutes and ss = seconds

#### Example:

QMA 15-12-14 13.41.55.log

which is 15th December 2014 at 1.41.55 pm

Auto generated log files are stored in the local My Documents folder.

### 7.6.1 Configuring Logging Start Time

Logging may be started immediately or at a user-defined time in the future.

To start logging immediately, select the 'Start when **START** is clicked' option.

To start logging at a user-defined time in the future, select the 'Start at this date/time:' option and enter the date and time when you wish to start logging.

### 7.6.2 Configuring Logging Stop Time

If the 'Stop when **STOP** is clicked' option is selected, then the software will continue logging indefinitely until either the 'STOP' button is clicked or the software is shut down.

If the 'Stop at this date/time:' option is selected then the software will continue logging until the selected date and time is reached or when the 'STOP' button is clicked or the software is shut down.

### 7.6.3 Starting the Log

After choosing a filename and configuring the logging start and stop times, click the 'START' button.

### 7.6.4 Viewing a Log

Click the 'view log file' button to view a log file within Windows notepad.

## 7.7 Parameters / Field Calibration

Analyzer parameters may be viewed and edited via this window. All of these options mirror the options available on the QMA601 HMI and to refer to the relevant pages for more information.

PARAMETER	Value now	Adjust	PARAMETER	Value now	Adjust
<b>SYSTEM CONFIGURATION</b>			<b>DATE</b>		
Temperature unit	°C	°C	Day	1	1
Pressure unit	bara	bara	Month	Jan	Jan
Dp calc. method	1GT		Year	12	12
Dp calc. pressure source	Ext. line pressure	Ext. line pressure	<b>TIME</b>		
Fixed pressure value	1	1	Hours	12:18:46	12
External pressure min.	0	0	Minutes		18
External pressure max.	160	160	Get PC date / time		
Gas type	Air	Air	<b>ALARMS</b>		
User gas 1 FCF	1.111	1.111	ALARM 1	ppmV, not latched	<input type="checkbox"/> Latch ppmV
User gas 1 molecular weight	12.22	12.22	Low setpoint	0	0
User gas 2 FCF	2.111	2.111	High setpoint	2000	2000
User gas 2 molecular weight	22.22	22.22	ALARM 2	Oven temp., not latched	<input type="checkbox"/> Latch Oven temp.
User gas 3 FCF	3.111	3.111	Low setpoint	59.9	59.9
User gas 3 molecular weight	32.22	32.22	High setpoint	60.1	60.1
<b>ANALOG OUTPUTS</b>			ALARM 3	Flow rate, not latched	<input type="checkbox"/> Latch Flow rate
Output 1 parameter	ppmV	ppmV	Low setpoint	90	90
Output 1 type	4-20mA	4-20mA	High setpoint	110	110
Output 1 zero	0	0	<b>WARNINGS</b>		
Output 1 span	2000	2000	Alarm triggers...	<input type="checkbox"/> Latch	<input type="checkbox"/> Latch
Output 2 parameter	Dew point	Dew point	<b>SIGNAL SMOOTHING</b>		
Output 2 type	4-20mA	4-20mA	Smoothing value	MEDIUM	MEDIUM
Output 2 zero	-100	-100			
Output 2 span	0	0			

RED = modified value

Buttons: Monitor..., Service..., Field Cal..., modBUS..., Cal. history..., Help, Copy to clipboard, Apply, Close

Current (live) values are shown in the 'Value now' column. New values may be entered in the 'Adjust' column. When a value is modified it will be shown in red and the 'Apply' button will enable.

Click the 'Apply' button to apply the modified values to the analyzer.

To write the PC date and time to the analyzer, first click the 'Get PC date/time' button to load the values into their respective positions on the screen, then click the 'Apply' button.

### 7.7.1 Field Calibration

This window allows manual analyzer calibrations to be performed, and settings for automatic calibrations configured. These options mirror the options in section 3.6.4.

PARAMETER	Value now	Adjust
<b>CALIBRATION GAS</b>		
Gas source	INTERNAL	INTERNAL
Ext. gas value ppm(V)	4.0000	4.0000
<b>ANALOG O/P HOLD</b>		
Data hold analog o/p's during & after cal.	OFF	OFF
Num. cycles to hold analog o/p's post cal.	12	12
<b>CALIBRATION TRIGGER</b>		
Manual or automatic	MANUAL	MANUAL
<b>AUTOMATIC CALIBRATION</b>		
Calibration interval (days)	7	7
Hour of day to start calibration (24 hour)	12	12
<b>NEXT CALIBRATION COUNTDOWN</b>		
Days	0	
Hours	0	
Minutes	0	
Seconds	0	
<b>CYCLES</b>		
Settling cycles	10	10
Calibration cycles	10	10

RED = modified value

Buttons: Help, Start..., Abort..., Close

# Appendix A

## Technical Specifications



## Appendix A Technical Specification

Performance	
Measurement technology	Fast Response Quartz Crystal Microbalance
Calibrated range*	0.1 to 700 ppm <sub>v</sub>
Measurement range	0.1 to 2000 ppm <sub>v</sub>
Accuracy	±10% of reading from 1 to 2000 ppm <sub>v</sub> ±0.1 ppm <sub>v</sub> between 0.1 & 1 ppm <sub>v</sub>
Repeatability	±5% of the reading from 1 to 2000 ppm <sub>v</sub> ±0.1 ppm <sub>v</sub> between 0.1 & 1 ppm <sub>v</sub>
Limit of Detection	0.1 ppm <sub>v</sub>
Available Units	ppm <sub>v</sub> , ppm <sub>w</sub> , mg/Nm <sup>3</sup> , vapor pressure (Pa), dew point (°C/°F), lbs/MMscf
Response Speed	T63 <2 mins to step change in either direction T95 <5 mins to step change in either direction
Automatic calibration	Internal moisture generator source calibrated traceable to NPL & NIST
Sensitivity	0.01ppm <sub>v</sub> or 1% of reading, whichever is greater
Electrical Specifications	
Supply Voltage	85 to 264 V AC, 47/63Hz or 24 V DC (ATEX / IECEx) 24 V DC only (cCSAus)
Alarms	1 x System Alarm, volt-free change-over (FORM C) 3 x process alarms, selectable for various parameters, volt free change-over (FORM C)
Analog signals	2 X 4-20mA or 1-5 V (selectable) Maximum load resistance 500 Ω for 4-20mA and minimum load of 1M Ω for 1-5 V
Digital communications	RS485 Modbus RTU Modbus TCP
Data logging	Available on analyzer (Limited number of values) or via Application Software
Local Interface	7" color LCD with intuitive HMI
Electrical Connections	M20 entries for cable glands
Operating Conditions	
Inlet Pressure	3 barg (43.5 psig)
Outlet Pressure	2 barg (29 psig)
Sample Flow	300ml/min total flow
Sample Gas Temperature	0 to +100°C (+32 to + 232°F)
Operating Environment	
<b>Analyzer only</b>	+5 to +45°C (+41 to +113°F) up to 90%RH
<b>Analyzer in sampling System</b>	-20 to +55°C (-4 to +131°F) up to 95%RH, (fitted with heater/thermostat and/or enclosure cooling as appropriate to maintain +5 to +45°C internal temperature)

<b>Mechanical Specifications</b>		
Type	GUB Flameproof Exd	
Enclosure	<b>Lid &amp; Body</b>	Cast copper-free aluminum LM25 (EN AC-42000), less than 0.6 magnesium
	<b>Glass Window</b>	Heat resistant, explosion proof, polyester coated, IP66, NEMA 4
Analyzer Gas Connections	1/8" NPT	
Weight	35kg (77lbs) without sampling system	
Sample System Enclosure	316L stainless steel	
<b>Hazardous Area Specifications</b>		
Hazardous Area Certification	<b>ATEX</b>	II 2 GD Ex d IIB+H2 T6 Gb, Ex tb IIIC T85°C Db, Tamb -40°C to +60°C
	<b>IECEX</b>	Ex d IIB+H2 T6 Gb, Ex tb IIIC T85°C Db, Tamb -40°C to +60°C
	<b>CSAc</b>	Class I, ZONES, Ex d IIB+H2 T6 Gb, Tamb -20°C to +55°C
	<b>CSAus</b>	Class I, Div 1, Group BCD T6, Tamb -25°C to +55°C
	<b>TC-TR</b>	1Ex d IIB+H2 T4 Gb X, 1Ex tb IIIC 130°C Db X 1Ex d IIB+H2 T3 Gb X, 1Ex tb IIIC 195°C Db X

**\*Applies only to standard 30-30 second cycle variant. Contact Michell Instruments for further details.**

# Appendix B

## Hazardous Area Certification

## Appendix B Hazardous Area Certification

The QMA601 is certified compliant to the ATEX Directive (2014/34/EU) and IECEx for use within Zone 1 and Zone 2 / Class I, Division 1 Hazardous Areas, and has been assessed so by TRaC Compliance (Notified Body 0891).

### B.1 Product Standards

This product conforms to the Standards:

EN60079-0:2012/A11:2013	IEC60079-0:2011
EN60079-1:2007	IEC60079-1:2007
EN60079-31:2014	IEC60079-31:2008
UL1203:2006	CSA C22.2 No.0
UL916	CSA C22.2 No.30

### B.2 Product Certification

This product is attributed with the product certification codes:

**ATEX & IECEx**  
**II 2 GD Ex d IIB+H2 T6 Gb Ex tb IIIC 85°C Db (-40 to +60°C)**

**CSAus**  
**Class I, Division 1, Groups B, C, & D, T6 (-25 to +55°C)**  
**CSAc**  
**Class I, Zones, Ex d IIB+H2 T6 Gb Tamb (-20 to 55°C)**

### B.3 Global Certificates/Approvals

ATEX	TRAC14ATEX0042X
IECEX	IECEX TRC14.0016X
cCSAus	70011747

These certificates can be viewed or downloaded from our website at:  
<http://www.michell.com>

### B.4 Special Conditions of Use

1. Clean only with a damp or anti-static cloth.
2. External cables shall be suitable for use at temperatures of 86°C.
3. Maximum combined process flow into enclosure must not exceed 5.0 l/min.
4. Only suitably certified cable glands, blanking elements and thread adapters must be used.
5. The enclosure must be earthed externally using the earth point provided.
6. Do not open when energized or when an explosive atmosphere may be present.

7. The flameproof joints of the flame arrestor and breather are not intended to be repaired.

### **B.5 Maintenance and Installation**

The QMA601 must only be installed by suitably qualified personnel and in accordance with the instructions provided and the terms of the applicable product Certificates.

Maintenance and servicing of the product must only be carried out by suitably trained personnel or returned to an approved Michell Instruments' Service Center.

Flame paths are not intended to be repaired.

# Appendix C

## Modbus Register Map

## Appendix C Modbus Holding Register Map

All the data values relating to the QMA601 are stored in holding registers. Each of these registers is two bytes (16-bits wide). Some of these registers contain instrument specific values e.g. its own unique system address, IP address values, etc. Others registers hold specific real time data such as temperature.

Each Modbus message has a two part address code, one for the low byte (bits 0 through 7) and one for the high byte (bits 8 through 15). The facility exists for multiple registers, specified by a high and low byte contained in the query message, to be addressed and read by the same message.

The table below describes the instruments' registers with their respective address locations, together with their relevant register configurations and register map definitions.

The register maps below the table define the data allocated to each bit/byte for each register type.

Address #	Function Description	Read/Write	Default	Register Config	Notes/ Real Value Range
0	ModBus Configuration	R/W		C	
1	System Configuration	R/W		D	
2	Alarm Configuration	R/W		E	
3	Analogue Output Configuration	R/W		F	
4	Internal Logging Configuration	R/W		U	
5	MFC Span in mlm / Gas Number for flow rate and mol weight correction	R/W		S	
6	PID – Proportional Value	R/W		A3	0.01-100.00%
7	PID – Integral Value	R/W		A3	0.01-1000.0%
8	PID – Derivative Value	R/W		A3	0.01-100.00%
9	Warning Relay Alarm warning selection mask	R/W		M	
10	Dryer Capacity (ppm) / Moist Gen Capacity (days)	R/W	255 / 103	V	
11	Signal Filter Settings	R/W		W	
12	Alarm1 – Low Set point	R/W		See App A	
13	Alarm1 – High Set point	R/W		See App A	
14	Alarm2 – Low Set point	R/W		See App A	
15	Alarm2 – High Set point	R/W		See App A	
16	Alarm3 – Low Set point	R/W		See App A	
17	Alarm3 – High Set point	R/W		See App A	
18	Analogue Out 1 – Low Set point	R/W		See App A	
19	Analogue Out 1 – High Set point	R/W		See App A	
20	Analogue Out 2 – Low Set point	R/W		See App A	
21	Analogue Out 2 – High Set point	R/W		See App A	
22	Fixed Pressure Input Value	R/W		See App A	
23	Next Calibration – Configuration	R/W		P1	
24	User low ppmV limit	R/W		A3	0.00 to 0.10
25	Next Calibration – Intervals between cal	R/W		P2	
26	Next Calibration – External Cal Val – Hi Word	R/W		I	0.01 to 2000.00 ppmv
27	Next Calibration – External Cal Val – Lo Word	R/W		I	0.01 to 2000 .00ppmv
28	Last Cal Day/Month/Year	R		J	
29	Last Cal Details	R/W		K	SCF can be set (for factory calibration)
30	Last Cal - 1 Day/Month/Year	R		J	

31	Last Cal - 1 Details	R		K	
32	Last Cal – 2 Day/Month/Year	R		J	
33	Last Cal – 2 Details	R		K	
34	Last Cal – 3 Day/Month/Year	R		J	
35	Last Cal – 3 Details		R		K
36	Last Cal – 4 Day/Month/Year	R		J	
37	Last Cal – 4 Details		R		K
38	User Gas Flow Correction Val1	R/W		A4	0.100 to 10.000
39	User Gas Flow Correction Val2	R/W		A4	0.100 to 10.000
40	User Gas Flow Correction Val3	R/W		A4	0.100 to 10.000
41	User Gas Mol Weight Val1	R/W		A3	0.100 to 500.00
42	User Gas Mol Weight Val2	R/W		A3	0.100 to 500.00
43	User Gas Mol Weight Val3	R/W		A3	0.100 to 500.00
44	Ext (line) Pressure Sensor Min	R/W		See App A	
45	Ext (line) Pressure Sensor Max	R/W		See App A	
46	Solenoid Hold Power in %	R/W		A1	
47	*Oven Temperature - Cal ADC Val	R/W		A1	0 to 4095
48	*Internal Pressure – ADC Val 4mA	R/W		A1	1 to 4095
49	*Internal Pressure – ADC Val 20mA	R/W		A1	1 to 4095
50	*Analogue Output 1 - DAC 4mA Value	R/W		A1	0-65535
51	*Analogue Output 1 - DAC 20mA Value	R/W		A1	0-65535
52	*Analogue Output 2 - DAC 4mA Value	R/W		A1	0-65535
53	*Analogue Output 2 - DAC 20mA Value	R/W		A1	0-65535
54	*External Pressure – ADC Val 4mA	R/W		A1	0 to 4095
55	*External Pressure – ADC Val 20mA	R/W		A1	0 to 4095
56	*RTC Cal Value – PPM error	R/W		A1	0-121
57	*Analyzer Serial Number HI WORD	R/W		32 bit Integer HI Word	1 to 4294967296
58	*Analyzer Serial Number LO WORD	R/W		32 bit Integer LO Word	"
59					
60	*Osc FW Version Hi Word	R		I	
61	*Osc FW Version Lo Word	R		I	
62	*Osc Table1 DeltaF 01 Hi Word	R/W		I	0.0001 to 2000.0000
63	*Osc Table1 DeltaF 01 Lo Word	R/W		I	"
64	*Osc Table1 DeltaF 02 Hi Word	R/W		I	0.0001 to 2000.0000
65	*Osc Table1 DeltaF 02 Lo Word	R/W		I	"
66	*Osc Table1 DeltaF 03 Hi Word	R/W		I	0.0001 to 2000.0000
67	*Osc Table1 DeltaF 03 Lo Word	R/W		I	"
68	*Osc Table1 DeltaF 04 Hi Word	R/W		I	0.0001 to 2000.0000
69	*Osc Table1 DeltaF 04 Lo Word	R/W		I	"
70	*Osc Table1 DeltaF 05 Hi Word	R/W		I	0.0001 to 2000.0000
71	*Osc Table1 DeltaF 05 Lo Word	R/W		I	"
72	*Osc Table1 DeltaF 06 Hi Word	R/W		I	0.0001 to 2000.0000
73	*Osc Table1 DeltaF 06 Lo Word	R/W		I	"
74	*Osc Table1 DeltaF 07 Hi Word	R/W		I	0.0001 to 2000.0000
75	*Osc Table1 DeltaF 07 Lo Word	R/W		I	"
76	*Osc Table1 DeltaF 08 Hi Word	R/W		I	0.0001 to 2000.0000
77	*Osc Table1 DeltaF 08 Lo Word	R/W		I	"
78	*Osc Table1 DeltaF 09 Hi Word	R/W		I	0.0001 to 2000.0000
79	*Osc Table1 DeltaF 09 Lo Word	R/W		I	"



80	*Osc Table1 DeltaF 10 Hi Word	R/W		I	0.0001 to 2000.0000
81	*Osc Table1 DeltaF 10 Lo Word	R/W		I	"
82	*Osc Table1 DeltaF 11 Hi Word	R/W		I	0.0001 to 2000.0000
83	*Osc Table1 DeltaF 11 Lo Word	R/W		I	"
84	*Osc Table1 DeltaF 12 Hi Word	R/W		I	0.0001 to 2000.0000
85	*Osc Table1 DeltaF 12 Lo Word	R/W		I	"
86	*Osc Table1 Ref 01 Hi Word	R/W		I	0.0001 to 10000.0000
87	*Osc Table1 Ref 01 Lo Word	R/W		I	"
88	*Osc Table1 Ref 02 Hi Word	R/W		I	0.0001 to 10000.0000
89	*Osc Table1 Ref 02 Lo Word	R/W		I	"
90	*Osc Table1 Ref 03 Hi Word	R/W		I	0.0001 to 10000.0000
91	*Osc Table1 Ref 03 Lo Word	R/W		I	"
92	*Osc Table1 Ref 04 Hi Word	R/W		I	0.0001 to 10000.0000
93	*Osc Table1 Ref 04 Lo Word	R/W		I	"
94	*Osc Table1 Ref 05 Hi Word	R/W		I	0.0001 to 10000.0000
95	*Osc Table1 Ref 05 Lo Word	R/W		I	"
96	*Osc Table1 Ref 06 Hi Word	R/W		I	0.0001 to 10000.0000
97	*Osc Table1 Ref 06 Lo Word	R/W		I	"
98	*Osc Table1 Ref 07 Hi Word	R/W		I	0.0001 to 10000.0000
99	*Osc Table1 Ref 07 Lo Word	R/W		I	"
100	*Osc Table1 Ref 08 Hi Word	R/W		I	0.0001 to 10000.0000
101	*Osc Table1 Ref 08 Lo Word	R/W		I	"
102	*Osc Table1 Ref 09 Hi Word	R/W		I	0.0001 to 10000.0000
103	*Osc Table1 Ref 09 Lo Word	R/W		I	"
104	*Osc Table1 Ref 10 Hi Word	R/W		I	0.0001 to 10000.0000
105	*Osc Table1 Ref 10 Lo Word	R/W		I	"
106	*Osc Table1 Ref 11 Hi Word	R/W		I	0.0001 to 10000.0000
107	*Osc Table1 Ref 11 Lo Word	R/W		I	"
108	*Osc Table1 Ref 12 Hi Word	R/W		I	0.0001 to 10000.0000
109	*Osc Table1 Ref 12 Lo Word	R/W		I	"
110	*BLANK3	R/W		Don't Care	
111	*Osc Table1 Cal Flow Rate ml/m	R/W		A2	10-2000 ml/m
112	*Osc Table1 Cal Int Moist Gen Val Hi Word	R/W		I	0.0001 to 10000.0000
113	*Osc Table1 Cal Int Moist Gen Val Lo Word	R/W		I	"
114	*Osc Table1 Cal Oven SP degC/ Cal Date DAY	R/W		Q	40 to 80 / 1 to 31
115	*Osc Table1 Cal Date MONTH / YEAR	R/W		Q	1 to 12 / 0 to 99
116	*Osc Table1 Cal Sample Phase Time	R/W		A1	10 to 65535 seconds
117	*Osc Table1 Cal Reference Phase Time	R/W		A1	10 to 65535 seconds
118	*Osc Table1 Cal Settling Cycles	R/W		A1	4 to 240 cycles
119	*Osc Table1 Cal Calibration Cycles	R/W		A1	4 to 60 cycles
120	*BLANK	R/W		Don't Care	
121	*Osc Table1 Cal Cell Pressure Reading	R/W		A3	0.00 to 10.00 barG
122	*Osc Table1 Cal Beat Freq of Ref	R/W		A1	1000 to 15000 (NOT USED)
123	*Osc Table1 Cal Beat Freq of Moist Gen	R/W		A1	1000 to 15000 (NOT USED)
124	*Osc Table2 DeltaF 01 Hi Word	R/W		I	0.0001 to 2000.0000
125	*Osc Table2 DeltaF 01 Lo Word	R/W		I	"
126	*Osc Table2 DeltaF 02 Hi Word	R/W		I	0.0001 to 2000.0000
127	*Osc Table2 DeltaF 02 Lo Word	R/W		I	"
128	*Osc Table2 DeltaF 03 Hi Word	R/W		I	0.0001 to 2000.0000

129	*Osc Table2 DeltaF 03 Lo Word	R/W		I	"
130	*Osc Table2 DeltaF 04 Hi Word	R/W		I	0.0001 to 2000.0000
131	*Osc Table2 DeltaF 04 Lo Word	R/W		I	"
132	*Osc Table2 DeltaF 05 Hi Word	R/W		I	0.0001 to 2000.0000
133	*Osc Table2 DeltaF 05 Lo Word	R/W		I	"
134	*Osc Table2 DeltaF 06 Hi Word	R/W		I	0.0001 to 2000.0000
135	*Osc Table2 DeltaF 06 Lo Word	R/W		I	"
136	*Osc Table2 DeltaF 07 Hi Word	R/W		I	0.0001 to 2000.0000
137	*Osc Table2 DeltaF 07 Lo Word	R/W		I	"
138	*Osc Table2 DeltaF 08 Hi Word	R/W		I	0.0001 to 2000.0000
139	*Osc Table2 DeltaF 08 Lo Word	R/W		I	"
140	*Osc Table2 DeltaF 09 Hi Word	R/W		I	0.0001 to 2000.0000
141	*Osc Table2 DeltaF 09 Lo Word	R/W		I	"
142	*Osc Table2 DeltaF 10 Hi Word	R/W		I	0.0001 to 2000.0000
143	*Osc Table2 DeltaF 10 Lo Word	R/W		I	"
144	*Osc Table2 DeltaF 11 Hi Word	R/W		I	0.0001 to 2000.0000
145	*Osc Table2 DeltaF 11 Lo Word	R/W		I	"
146	*Osc Table2 DeltaF 12 Hi Word	R/W		I	0.0001 to 2000.0000
147	*Osc Table2 DeltaF 12 Lo Word	R/W		I	"
148	*Osc Table2 Ref 01 Hi Word	R/W		I	0.0001 to 10000.0000
149	*Osc Table2 Ref 01 Lo Word	R/W		I	"
150	*Osc Table2 Ref 02 Hi Word	R/W		I	0.0001 to 10000.0000
151	*Osc Table2 Ref 02 Lo Word	R/W		I	"
152	*Osc Table2 Ref 03 Hi Word	R/W		I	0.0001 to 10000.0000
153	*Osc Table2 Ref 03 Lo Word	R/W		I	"
154	*Osc Table2 Ref 04 Hi Word	R/W		I	0.0001 to 10000.0000
155	*Osc Table2 Ref 04 Lo Word	R/W		I	"
156	*Osc Table2 Ref 05 Hi Word	R/W		I	0.0001 to 10000.0000
157	*Osc Table2 Ref 05 Lo Word	R/W		I	"
158	*Osc Table2 Ref 06 Hi Word	R/W		I	0.0001 to 10000.0000
159	*Osc Table2 Ref 06 Lo Word	R/W		I	"
160	*Osc Table2 Ref 07 Hi Word	R/W		I	0.0001 to 10000.0000
160	*Osc Table2 Ref 07 Lo Word	R/W		I	"
162	*Osc Table2 Ref 08 Hi Word	R/W		I	0.0001 to 10000.0000
163	*Osc Table2 Ref 08 Lo Word	R/W		I	"
164	*Osc Table2 Ref 09 Hi Word	R/W		I	0.0001 to 10000.0000
165	*Osc Table2 Ref 09 Lo Word	R/W		I	"
166	*Osc Table2 Ref 10 Hi Word	R/W		I	0.0001 to 10000.0000
167	*Osc Table2 Ref 10 Lo Word	R/W		I	"
168	*Osc Table2 Ref 11 Hi Word	R/W		I	0.0001 to 10000.0000
169	*Osc Table2 Ref 11 Lo Word	R/W		I	"
170	*Osc Table2 Ref 12 Hi Word	R/W		I	0.0001 to 10000.0000
171	*Osc Table2 Ref 12 Lo Word	R/W		I	"
172	*BLANK	R/W		Dont Care	
173	*Osc Table2 Cal Flow Rate ml/m	R/W		A2	10-2000 ml/m
174	*Osc Table2 Cal Int Moist Gen Val Hi Word	R/W		I	0.0001 to 10000.0000
175	*Osc Table2 Cal Int Moist Gen Val Lo Word	R/W		I	"
176	*Osc Table2 Cal Oven SP degC / Cal Date DD	R/W		Q	40 to 80 / 1 to 31
177	*Osc Table2 Cal Date MMY	R/W		Q	1 to 12 / 0 to 99
178	*Osc Table2 Cal Sample Phase Time	R/W		A1	10 to 240 seconds

179	*Osc Table2 Cal Reference Phase Time	R/W		A1	10 to 240 seconds
180	*Osc Table2 Cal Settling Cycles	R/W		A1	4 to 240 cycles
181	*Osc Table2 Cal Calibration Cycles	R/W		A1	4 to 60 cycles
182	*BLANK	R/W		Dont Care	
183	*Osc Table2 Cal Cell Pressure Reading LoW	R/W		A3	0.00 to 10.00 barG
184	*Osc Table2 Cal Beat Freq of Ref	R/W		A2	1000 to 15000 (NOT USED)
185	*Osc Table2 Cal Beat Freq of Moist Gen	R/W		A2	1000 to 15000 (NOT USED)
186	*Oven Serial Number HI WORD	R/W		32 bit Integer HI Word	1 to 4294967296
187	*Oven Serial Number LO WORD	R/W		32 bit Integer LO Word	"
188	*BLANK	R/W		Dont Care	
189	*BLANK	R/W		Dont Care	
190					
191					
192					
193					
194	User manual entry SCF value	W		A4	Write to set SCF value to use (0.2500 to 4.000)
195	Passcode for protected registers	W		A1	(NOT USED CURRENTLY)
196	RTC Set Hours/Mins	W		H	Write to set Time
197	RTC Set Day/Month/Year	W		J	Write to set Date
198	Instrument Command Register	W		T	
199					
200	Control Board f/w version	R		A3	
201	Moisture – PPMv – Hi Word	R		I	
202	Moisture – PPMv – Lo Word	R		I	
203	Moisture – PPMw – Hi Word	R		I	
204	Moisture – PPMw – Lo Word	R		I	
205	Moisture – mg/m3 – Hi Word	R		I	
206	Moisture – mg/m3 – Lo Word	R		I	
207	Moisture – Pa – Hi Word	R		I	
208	Moisture – Pa – Lo Word	R		I	
209	Moisture – lb/mmscf – Hi Word	R		I	
210	Moisture – lb/mmscf – Lo Word	R		I	
211	Dew point Hi Word in set unit	R		I	
212	Dew point Lo Word in set unit	R		I	
213	Enclosure Temperature in set unit	R		B2	
214	Ext Pressure Reading in set unit	R		See App A	
215	DeltaF Hi Word	R		I	
216	DeltaF Lo Word	R		I	
217	Beat Frequency Hi Word	R		I	
218	Beat Frequency Lo Word	R		I	
219	Oven Temperature in set unit	R		B3	
220	Flow Rate in ml/m	R		A2	
221	Heater Power in %	R		A2	
222	RTC Hours/Minutes	R		H	
223	RTC Seconds	R		A1	
224	RTC Day/Month/Year	R		J	

225	Ref Seconds Countdown	R		A1	
226	Pressure Reading of cell in set unit	R		See App A	
227	Sample Seconds Countdown	R		A1	
228	Cal Settling / Calibration Cycles Countdown	R		Q	
229	System Status Register	R		L	
230	Warning Flags Register	R		M	
231	Current Flow Correction value	R		A4	
232	Moist Gen Value Read After Cal – Hi Word	R		I	For cal use
233	Moist Gen Value Read After Cal – Lo Word	R		I	For cal use
234	Countdown to Next Cal HHDD	R		P2	
235	Countdown to Next Cal MMSS	R		Q	
236	10 Sample Averaged DeltaF Hi Word	R		I	Average of 10 deltaF Logs - For cal use
237	10 Sampled Averaged DeltaF Lo Word	R		I	"
238	10 Sample Averaged Ppmv Hi Word	R		I	Average of 10 ppmv Logs - For cal use
239	10 Sampled Averaged Ppmv Lo Word	R		I	"
240	Oven Temperature Live Averaged ADC Val	R		A1	
241	Internal Pressure Live Averaged ADC Val	R		A1	
242	External Pressure Live Averaged ADC Val	R		A1	
243	Dryer Capacity Used / Moist Gen Capacity Used	R		V	
244					
245	Ethernet Settings – IP Address – Upper Bytes	R/W		Q	Volatile – Cannot write via Modbus, only via display
246	Ethernet Settings – IP Address – Lower Bytes	R/W		Q	"
247	Ethernet Settings – Def Gateway – Upper Bytes	R/W		Q	"
248	Ethernet Settings – Def Gateway – Lower Bytes	R/W		Q	"
249	Ethernet Settings – Subnet Mask – Upper Bytes	R/W		Q	"
250	Ethernet Settings – Subnet Mask – Lower Bytes	R/W		Q	"
251					
252	DeltaF Log t0 Hi Word	R		I	For cal use
253	DeltaF Log t0 Lo Word	R		I	For cal use
254	DeltaF Log t1 Hi Word	R		I	For cal use
255	DeltaF Log t1 Lo Word	R		I	For cal use
256	DeltaF Log t2 Hi Word	R		I	For cal use
257	DeltaF Log t2 Lo Word	R		I	For cal use
258	DeltaF Log t3 Hi Word	R		I	For cal use
259	DeltaF Log t3 Lo Word	R		I	For cal use
260	DeltaF Log t4 Hi Word	R		I	For cal use
261	DeltaF Log t4 Lo Word	R		I	For cal use
262	DeltaF Log t5 Hi Word	R		I	For cal use
263	DeltaF Log t5 Lo Word	R		I	For cal use
264	DeltaF Log t6 Hi Word	R		I	For cal use
265	DeltaF Log t6 Lo Word	R		I	For cal use
266	DeltaF Log t7 Hi Word	R		I	For cal use
267	DeltaF Log t7 Lo Word	R		I	For cal use
268	DeltaF Log t8 Hi Word	R		I	For cal use

269	DeltaF Log t8 Lo Word	R		I	For cal use
270	DeltaF Log t9 Hi Word	R		I	For cal use
271	DeltaF Log t9 Lo Word	R		I	For cal use
272	Ppmv Log t0 Hi Word	R		I	For cal use
273	Ppmv Log t0 Lo Word	R		I	For cal use
274	Ppmv Log t1 Hi Word	R		I	For cal use
275	Ppmv Log t1 Lo Word	R		I	For cal use
276	Ppmv Log t2 Hi Word	R		I	For cal use
277	Ppmv Log t2 Lo Word	R		I	For cal use
278	Ppmv Log t3 Hi Word	R		I	For cal use
279	Ppmv Log t3 Lo Word	R		I	For cal use
280	Ppmv Log t4 Hi Word	R		I	For cal use
281	Ppmv Log t4 Lo Word	R		I	For cal use
282	Ppmv Log t5 Hi Word	R		I	For cal use
283	Ppmv Log t5 Lo Word	R		I	For cal use
284	Ppmv Log t6 Hi Word	R		I	For cal use
285	Ppmv Log t6 Lo Word	R		I	For cal use
286	Ppmv Log t7 Hi Word	R		I	For cal use
287	Ppmv Log t7 Lo Word	R		I	For cal use
288	Ppmv Log t8 Hi Word	R		I	For cal use
289	Ppmv Log t8 Lo Word	R		I	For cal use
290	Ppmv Log t9 Hi Word	R		I	For cal use
291	Ppmv Log t9 Lo Word	R		I	For cal use
292					
293					
294	Log Buffer Latest Log Pointer	R		A1	Points to start of latest log
295	Log Buffer Main Val Min – Hi_Word	R		I	
296	Log Buffer Main Val Min – Lo_Word	R		I	
297	Log Buffer Main Val Max – Hi_Word	R		I	
298	Log Buffer Main Val Max – Lo_Word	R		I	
299	Log1 - Hours/Minutes	R		H	
300	Log1 - Day/Month/Seconds	R		J	
301	Log1 - Main Value - Hi_Word	R		I	
302	Log1 - Main Value - Lo_Word	R		I	
303	Log1 - System Status Register	R		L	
304	Log1 - Warning Flags Register	R		M	
305	Log2 - Hours/Minutes	R		H	
306	Log2 - Day/Month/Seconds	R		J	
307	Log2 - Main Value - Hi_Word	R		I	
308	Log2 - Main Value - Lo_Word	R		I	
309	Log2 - System Status Register	R		L	
310	Log2 - Warning Flags Register	R		M	
>>>	>>> To log288	R		As above	

\* Factory Calibration Data

**Table 18** Modbus Register Map

**Register Configuration A**

15	14	13	12	11	10	9	8	7	6	5	4	3	2	1	0

A1 — Unsigned Short. Range = 0 to 65535

A2 — Unsigned Short/10. Range = 0 to 6553.5

A3 — Unsigned Short/100. Range = 0 to 655.35

A4 — Unsigned Short/1000. Range = 0 to 65.535

A5 — Unsigned Short/1000. Range = 0 to 65.535

Conversion: Float\*x = unsigned integer

Unsigned integer/x = float

Or cast:

Float value to read = ((float)(value))/x;

Unsigned short value to write = (unsigned short)(value\*x)

**Register Configuration B**

15	14	13	12	11	10	9	8	7	6	5	4	3	2	1	0

B1 — Signed Short. Range -32768 to +32767

B2 — Signed Short/10. Range -3276.8 to +3276.7

B3 — Signed Short/100. Range -327.68 to +327.67

B4 — Signed Short/1000. Range -32.768 to +32.767

B5 — Signed Short/10000. Range -3.2768 to +3.2767

Most languages will cast from one type to another

*Values to write into register manually:*

If value is a negative number: (value\*x)+65536

If value is 0 or a positive number: value\*x

E.g. for type B3:

$(-5.39*100)+65536 = 64997$

$(2.01*100) = 201$

Or cast:

(Unsigned short)(value\*x)

*Reading Values from register manually:*

If value in register is greater than 32767: (value-65536)/x

If value in register is less than or equal to 32767: value/x

E.g. for type B3:

$(64997-65536)/100 = -5.39$

$201/100 = 2.01$

Or cast:

((float)((signed short)value))/x;

## Register Configuration C — Modbus Configuration

15	14	13	12	11	10	9	8	7	6	5	4	3	2	1	0
						PT	PT	IA	IA	IA	IA	IA	IA	IA	IA

Instrument Address (IA)	Protocol Type (PT)
1 to 31 (1=def)	00=RS485 01=USB VCP 10= Ethernet

## Register Configuration D — System Configuration

15	14	13	12	11	10	9	8	7	6	5	4	3	2	1	0
DC	DC	CP	CP	CP	CP	PS	PS	PU	PU	PU	TU	TU			NE

Temperature/Dew Point units (TU)	Pressure for Dew-Point Calculations (PS)
00 = C (def) 01 = F	00= Atmospheric (def) 01 = Fixed pressure (User input value) 10 = External Line pressure (Ext sensor)
Pressure Units (PU)	Number of cal points to use (CP)
000 = Bar.G (def) 001 = Bar.A 010 = Psi.G 011 = Psi.A 100 = MPa.G 101 = mmHg 110 = MPa.A	Minimum 3 and maximum is 12. Any other value is also 12.
Dew-Point Calculation method to use (DC)	NAMUR Error level preference
00=IGT 01=ISO 10=Ideal Gas (def)	0 = low error (3.0mA) 1 = high error (22.0mA)

**Note:** when a pressure unit or temperature unit is changed then the user must manually change the values for the following to the value in the new selected unit (if relevant).

- Fixed pressure for dew-point calculation
- External line pressure sensor min and max
- Alarm set-points
- Analog output ranges (low and high)

Register Configuration E — Alarm Configuration

Note: Alarm 4 is a system fault/warning alarm and is configured in register 9 (Configuration M)

15	14	13	12	11	10	9	8	7	6	5	4	3	2	1	0
L4	L3	L2	L1	A3	A3	A3	A3	A2	A2	A2	A2	A1	A1	A1	A1

<b>Alarm1 Parameter (A1)</b>	<b>Alarm2 Parameter (A2)</b>
0000 = Moisture – PPMv (def) 0001= Moisture - PPMw 0010 = Moisture – MGM3 0011 = Moisture – PA (wvp) 0100 = Moisture - LBMMSCF 0101 = Dew point 0110 = Oven temperature 0111 = Flow rate 1000 = Cell Pressure 1001 = Ext Line Pressure	0000 = Moisture – PPMv 0001= Moisture - PPMw 0010 = Moisture – MGM3 0011 = Moisture – PA (wvp) 0100 = Moisture - LBMMSCF 0101 = Dew point 0110 = Oven temperature (def) 0111 = Flow rate 1000 = Cell Pressure 1001 = Ext Line Pressure
<b>Alarm3 Parameter (A3)</b>	<b>Alarm Latch Control (L1 to L4)</b>
0000 = Moisture – PPMv 0001= Moisture - PPMw 0010 = Moisture – MGM3 0011 = Moisture – PA (wvp) 0100 = Moisture - LBMMSCF 0101 = Dew point 0110 = Oven temperature 0111 = Flow rate (def) 1000 = Cell Pressure 1001 = Ext Line Pressure	L1 = 1 = Alarm1 latch L2 = 1 = Alarm2 latch L3 = 1 = Alarm3 latch L4 = 1 = Alarm4 latch L1 = 0 = Alarm1 don't latch L2 = 0 = Alarm2 don't latch L3 = 0 = Alarm3 don't latch L4 = 0 = Alarm4 don't latch

Register Configuration F — Analog Output Config

15	14	13	12	11	10	9	8	7	6	5	4	3	2	1	0
						T2	T1	O2	O2	O2	O2	O1	O1	O1	O1

<b>Output1 Parameter (O1)</b>	<b>Output2 Parameter (O2)</b>
0000 = Moisture – PPMv (def) 0001 = Moisture - PPMw 0010 = Moisture – MGM3 0011 = Moisture – PA 0100 = Moisture - LBMMSCF 0101 = Dew point 0110 = Oven temperature 0111 = Flow rate 1000 = Cell Pressure 1001 = Ext Line Pressure	0000 = Moisture – PPMv 0001= Moisture - PPMw 0010 = Moisture – MGM3 0011 = Moisture – PA 0100 = Moisture - LBMMSCF 0101 = Dew point (def) 0110 = Oven temperature 0111 = Flow rate 1000 = Cell Pressure 1001 = Ext Line Pressure
<b>Output Type – (T1 to T2)</b>	
0 = 4–20 mA 1 = 1–5V (Where T1 is CH1 and T2 is CH2)	



**Register Configuration H — Time (hours/minutes)**

15	14	13	12	11	10	9	8	7	6	5	4	3	2	1	0
HH	HH	HH	HH	HH	HH	HH	HH	MM	MM	MM	MM	MM	MM	MM	MM

<b>Hours Number (HH)</b>	<b>Minutes Number (MM)</b>
00 to 23	00 to 59

**Register Configuration I — 32 bit Precision Floating Point Representation**

IEEE-754 single precision floating point format. This format is 'Big Ended' which means that the high byte is at a lower address in memory than the Lo byte, and is represented as such in the register memory map. The IEEE-754 format is shown below.

Bit 31	Bits 30 to 23	Bits 22 to 0
Sign bit 0 = + 1 = -	Exponent Field Has a +127 bias value	mantissa Decimal representation of binary. Where $1.0 \leq \text{value} < 2.0$

Examples of floating point to HEX are shown below:

**1. +10.3**

sign bit = 0

Exponent = 3, therefore exponent field =  $127 + 3 = 130$ , and bits 30 to 23 = 1000 0010

The mantissa = 1.2875 which in binary representation = 1010 0100 1100 1100 1101

Adjusting the mantissa for the exponent moves the decimal point to the right if positive and to the left if negative.

As the exponent is = 3 then the mantissa becomes = 1010 0100 1100 1100 1101, therefore:

$1010 = (1 \times 2^3) + (0 \times 2^2) + (1 \times 2^1) + (0 \times 2^0) = 10$  and

$0100 1100 1100 1101 = (0 \times 2^{-1}) + (1 \times 2^{-2}) + \dots + (1 \times 2^{-20}) = 0.3$

Therefore the word value = 0100 0001 0010 0100 1100 1100 1100 1101  
= 4124CCCD

Consequently hi word= 4124 and lo word = CCCD

**2. - 0.0000045**

sign bit = 1

Exponent = -18, therefore exponent field =  $127 + (-18) = 109$ , and bits 30 to 23 = 0110 1101

The mantissa = 1.179648 which in binary representation = 1001 0110 1111 1110 1011 0101

i.e.  $(1 \times 2^{-18}) + (1 \times 2^{-21}) + (1 \times 2^{-23})$  etc. = 0.0000045

Therefore the word value = 1011 0110 1001 0110 1111 1110 1011 0101  
= B696FEB5

## Register Configuration J — Date

15	14	13	12	11	10	9	8	7	6	5	4	3	2	1	0
DD	DD	DD	DD	DD	MM	MM	MM	MM	YY	YY	YY	YY	YY	YY	YY

<b>Date Number (DD)</b>	<b>Month Number (MM)</b>
1 to 31	1 to 12
<b>Year Number (YY) or Seconds</b>	
00-99 for year or 00-59 for seconds	

## Register Configuration K — Historic Calibration Log — Details

15	14	13	12	11	10	9	8	7	6	5	4	3	2	1	0
MA	IE	UE		CF	CF	CF	CF	CF	CF	CF	CF	CF	CF	CF	CF

<b>Correction Factor (CF)</b>	<b>Manual or Auto (MA)</b>
1 to 4000 /1000.0 = 0.2500 to 4.000	0=Manual 1=Automatic
<b>Internal or External (IE)</b>	<b>User Entry (UE)</b>
0=Internal 1=External	1= CF manually written by user 0 = CF generated via calibration

## Register Configuration L — System Status Register — 229

15	14	13	12	11	10	9	8	7	6	5	4	3	2	1	0
A4	A4	A3	A3	A2	A2	A1	A1	SS	PS		DH	SM	SM	CP	CP

<b>Cycle Phase (CP)</b>	<b>System Mode (SM)</b>
00= Reference phase 01= Sample Phase 10 = Cal Phase (internal or external)	00= Standby 01= Measurement 10 = Calibration
<b>Relay Alarm Status flags (A1, A2, A3, A4)</b>	<b>Setup Status (SS)</b>
Example: A1 = 00=OK (relay de-energised) A1 = 01=High (or Fault)(relay energised) A1 = 10=Low (relay energised) A1 = 11= Latched (relay latched but condition now ok)	0 = Setup mode is OFF 1 = Setup mode is ON
<b>Purge Status (PS)</b>	<b>Current Data Hold Status</b>
0=Not purging 1=Purging (System in Setup mode and only REF solenoid is energised)	0 = Data is currently not held 1 = Data is currently held

### Register Configuration M — System Warning Flags (Register 230), Analyzer Status Alarm Relay Selection Mask (Register 9)

1=Warning or fault, 0=OK

15	14	13	12	11	10	9	8	7	6	5	4	3	2	1	0

Bit	HEX	Warning Condition
0	0001	<b>Oven temperature unstable.</b> Oven temperature has not been stable within $\pm 0.01^{\circ}\text{C}$ of setpoint for continuous 5 minutes. (Process alarms de-energized, both analog outputs at fault condition)
1	0002	<b>Enclosure temperature too high.</b> Enclosure (System) temperature too high. ( $>$ Oven temperature setpoint $-2^{\circ}\text{C}$ )
2	0004	<b>Flow control error.</b> MFC Flow control error (by $>5\text{ml/m}$ of flow target)
3	0008	<b>Cell pressure sensor error.</b> (under 4 mA, over 20 mA or no signal)
4	0010	<b>Ext Press sensor error.</b> (under 4 mA, over 20 mA or no signal)
5	0020	<b>Field cal error.</b> Internal moist generator drift, instrument excessive drift or desiccant dryer deterioration requiring very large corr. factor ( $<0.2500$ or $>4.000$ ). In this case the correction factor would be set to 1.0. (Checked after field calibration)
6	0040	<b>Beat freq. out of range.</b> Beat frequency Under/Over acceptable range ( $<1500\text{ Hz}$ , $>20000\text{ Hz}$ )
7	0080	<b>ppmV over range.</b> ppm <sub>v</sub> over instrument range ( $>2000\text{ppm}_v$ )
8	0100	<b>Oven temperature sensor fault.</b> Oven temperature sensor fault (Process Alarms de-energized, Fault Alarm Active, both Analog outputs at fault condition (ADC $<10$ , $>4000$ counts))
9	0200	<b>mA output 1 error.</b> (o/c or high resistance at output)
10	0400	<b>mA output 2 error.</b> (o/c or high resistance at output)
11	0800	<b>Oscillator board comms error.</b> Oscillator board comms. error or board not present (checked on startup)
12	1000	<b>Ethernet board comms. error.</b> Ethernet Board comms. error or board not fitted (checked on startup)
13	2000	<b>Dryer due for service.</b> Desiccant Dryer due for service or replacement ( $>5000000\text{ppm}_v$ )
14	4000	<b>Moisture generator due for service.</b> Internal Moisture Generator due for service or replacement ( $>1030\text{days}$ )
15	8000	Calibration Alarm In calibration mode or data held (or both)

Analyzer Status Alarm selection mask (in Register 9) allows user to set which condition(s) trigger status relay alarm 4.

**Register Configuration P1 — Next Calibration Configuration**

15	14	13	12	11	10	9	8	7	6	5	4	3	2	1	0
MA	IE	DH	MG					AC	AC	AC	AC	AC	AC	AC	AC

<b>Manual or Auto (MA)</b>	<b>Internal or External (IE)</b>
0 = Manual 1 = Auto	0 = Internal 1 = External
<b>Data Hold (DH)</b>	<b>Data Hold Additional Cycles (AC)</b>
0 = off 1 = on	0 to 240 cycles

**Register Configuration P2 — Next Calibration Configuration — Intervals between cal**

15	14	13	12	11	10	9	8	7	6	5	4	3	2	1	0
	IH	IH	IH	IH	IH	ID	ID	ID	ID	ID	ID	ID	ID	ID	ID

<b>Hour of Day (IH)</b>	<b>Interval Days (ID)</b>
0 to 23	1 day to 365 days

**Register Configuration Q — Various Parameters, High Byte and Low Byte**

15	14	13	12	11	10	9	8	7	6	5	4	3	2	1	0
MS	MS	MS	MS	MS	MS	MS	MS	MS	MS	MS	GN	GN	GN	GN	GN

<b>MFC Span in ml/m (MS)</b>	<b>Gas Number (GN)</b>
0 to 2000 ml/m	0 to 23 Gases (see Appendix D.1 for details).

**Register Configuration T — Instrument Setup and Command Register (Register 198)**

Writing relevant number to this register initiates associated setting, calibration or test function

\* Means only for Michell Factory use

\*\* Put in setup mode first and then after test put back into measurement mode

2 = Set Cell Pressure 4 mA ADC Value\*

3 = Set Cell Pressure 20 mA ADC Value\*

4 = Set Ext Pressure 4 mA ADC Value\*

5 = Set Ext Pressure 20 mA ADC Value\*

6 = Send Test String to Sensor Comms Channel\*

7 = Send Test String to Display Comms Channel\*

- 10 = Force Analog Output 1 to 4 mA\*\*
- 11 = Force Analog Output 1 to 20 mA\*\*
- 12 = Force Analog Output 2 to 4 mA\*\*
- 13 = Force Analog Output 2 to 20 mA\*\*
- 14 = Force Analog Output 1 to 12 mA\*\*
- 15 = Force Analog Output 2 to 12 mA\*\*
- 19 = All Alarm Relays de-energised
- 20 = Set Alarm Relay1\*\*
- 21 = Set Alarm Relay2\*\*
- 22 = Set Alarm Relay3\*\*
- 23 = Set Alarm Relay4\*\*
- 25 = Set REF Solenoid\* (uses 100% power to solenoid)\*\*
- 26 = Set SAMPLE Solenoid\* (uses 100% power to solenoid)\*\*
- 27 = Set CAL Solenoid\* (uses 100% power to solenoid)\*\*
- 28 = All Solenoids Off\* (uses 100% power to solenoid)\*\*
- 30 = Set RTC Calibration ppm error value\*
- 35 = Set Defaults Osc Board\*
- 36 = Set Defaults Main Board\* (Does not default the main board calibration values).
- 50 = Set System Mode to Standby (all solenoids off and no phase countdown)\*
- 51 = Set System Mode to Measurement if in Cal mode (i.e. Abort Cal) OR Set to Manual Cal if in Auto cal countdown mode
- 52 = Set System Mode to Calibration if manual cal option set OR Start Auto Cal countdown mode if Auto Cal option set. (Only if oven temperature has become stable).
- 60 = Start on board SD Logging (Open log file)\*
- 61 = Stop on board SD logging (Close log file)\*
- 65 = Enter Board Setup Mode\* (Normal measurement cycle and output/alarm updates are stopped)
- 66 = Exit Board Setup Mode\*(Normal measurement cycle and output/alarm updates are re-started)
- 67 = Reset Ram Log Buffer and Stats to zeros
- 68 = Set Ethernet Settings (to values in Registers 245 to 250) – (Command not allowed via modbus)
- 70 = Reset Dryer Service flag and ppm sum register to 0.0ppm
- 71 = Reset Moist Generator Service flag and hours used counter to 0hr
- 74 = Clear Alarm1 Latch
- 75 = Clear Alarm2 Latch
- 76 = Clear Alarm3 Latch
- 77 = Clear Alarm4 (Fault) Latch
- 78 = Start Purge (Ref solenoid energised, all others de-energised. System in Setup mode)
- 79 = Stop Purge (System reverts to normal measurement mode)

**Register Configuration U – Internal Logging Configuration/Service Interval Days**

15	14	13	12	11	10	9	8	7	6	5	4	3	2	1	0
								RL	RL	RL	RL	DP	DP	DP	DP

DeltaF and ppm <sub>v</sub> Log Interval in cycles (DP)	Ram Buffer Log parameter (RL)
Range is 1 to 15 cycles. (for CAL use, def = 1)	0000 = Moisture – PPMv (def) 0001= Moisture - PPMw 0010 = Moisture – MGM3 0011 = Moisture – PA (wvp) 0100 = Moisture - LBMMSCF 0101 = Dew point 1111 = No logging

**Register Configuration V – Internal Logging Configuration/Service Interval Days**

15	14	13	12	11	10	9	8	7	6	5	4	3	2	1	0
DC	DC	DC	DC	DC	DC	DC	DC	ML	ML	ML	ML	ML	ML	ML	ML

Dryer Capacity or Used (DC) – in ppm	Moisture Gen Capacity or Used (ML) – in Days
0 to 255 x 100,000 represents 0 to 25,500,000 in 100,000 steps.	0 to 255 x 10 Represents 0 to 2,550 days (61200 hours) in 10 day steps

**Register Configuration W – Signal Filter Settings**

15	14	13	12	11	10	9	8	7	6	5	4	3	2	1	0
									BF	BF	DF	DF	DF	DF	DF

BeatF Median Filter (BF) Setting	DeltaF Median Filter (DF) Sample size
5 sample Median filter to remove spikes  1=Median of 1 (middle value) 3=Median of 3, averaged (default)  Any other value = OFF	4-24 = Sample size of filter to smooth signal (default=12)  < 4 or >24 = OFF

### C.1 Set Points and Ranges

Set points and ranges for Analog Outputs, Alarms, Fixed User Pressure, Cell Pressure and External (line) Pressure sensor.

Unit	Adjustment Range/Res.	Default Values	Register Range	Register Type
ppm <sub>v</sub>	0.0 to 3000.0	0.0 to 2000.0	0-30000	A2 (unsigned short/10)
ppm <sub>w</sub>	0 to 40000	0 to 40000	0 to 40000	A1 (unsigned short)
mgm <sup>3</sup>	0 to 20000	0 to 20000	0 to 20000	A1 (unsigned short)
Pa	0.0 to 3000.0	0.0 to 3000.0	0 to 30000	A2 (unsigned short/10)
dew point degC	-120.0 to +20.0	-100.0 to 0.0	-1200 to 200	B2 (signed short/10)
dew point degF	-184.0 to +68	-148.0 to 32.0	-1840 to 680	B2 (signed short/10)
lbmmscf	0 to 60000	0 to 60000	0 to 60000	A1 (unsigned short)
Oven T degC	-50.0 to +100.0	59.9 to 60.1	-500 to 1000	B2 (signed short/10)
Oven T degF	-58.0 to +212.0	139.8 to 140.2	-580 to +2120	B2 (signed short/10)
Flow, ml/m	0.0 to 300.0	90.0 to 110.0	0 to 3000	A2 (unsigned short/10)
Pressure, Psi.G	0.0 to 3000.0	0.0 to 3000.0	0 to 30000	A2 (unsigned short/10)
Pressure, Psi.A	14.7-3014.7	15.0-3015.0	147 to 30147	A2 (unsigned short/10)
Pressure, Bar.G	0.00 to 204.08	0.00 to 204.00	0 to 20408	A3 (unsigned short/100)
Pressure, Bar.A	1.00 to 205.08	1.00 to 205.00	1 to 20508	A3 (unsigned short/100)
Pressure, MPa.G	0.01 to 20.78	0.01 to 21.00	1 to 2078	A3 (unsigned short/100)
Pressure, mmHg	750 to 65535 (limited)	750 to 65000	0 to 65535 (limited)	A1 (unsigned short)
Pressure, MPa.A	0.01 to 20.78	0.01 to 21.00	1 to 2078	A3 (unsigned short/100)
Pressure MPa.A	0.01 to 20.78	0.01 to 21.00	1 to 2078	A3 (unsigned short/100)

## C.2 Gases for Gas Correction Values

Gases for gas correction values, indexed 0 to 23. If a USER gas is selected then the instrument will use the gas correction values that are set in the respective registers 38, 39 and 40 for the Flow correction and at registers 41, 42 and 43 for the molecular weights.

0 = Air - Mixture	12 = He - Helium
1 = Ar - Argon	13 = Kr - Krypton
2 = CH <sub>4</sub> - Methane	14 = N <sub>2</sub> - Nitrogen
3 = C <sub>2</sub> H <sub>2</sub> - Ethyne	15 = Ne - Neon
4 = C <sub>2</sub> H <sub>4</sub> - Ethylene	16 = NH <sub>3</sub> - Ammonia
5 = C <sub>2</sub> H <sub>6</sub> - Ethane	17 = NO - Nitrogen Oxide
6 = C <sub>3</sub> H <sub>6</sub> - Propylene	18 = N <sub>2</sub> O - Nitrous Oxide
7 = C <sub>3</sub> H <sub>8</sub> - Propane	19 = O <sub>2</sub> - Oxygen
8 = C <sub>4</sub> H <sub>10</sub> - Butane	20 = Xe - Xenon
9 = CO - Carbon Monoxide	21 = UserGas1
10 = CO <sub>2</sub> - Carbon Dioxide	22 = UserGas2
11 = H <sub>2</sub> - Hydrogen	23 = UserGas3



# Appendix D

## Quality, Recycling, Compliance & Warranty Information

## Appendix D    Quality, Recycling, Compliance & Warranty Information

Michell Instruments is dedicated to complying to all relevant legislation and directives. Full information can be found on our website at:

**[www.michell.com/compliance](http://www.michell.com/compliance)**

This page contains information on the following directives:

- ATEX Directive
- Calibration Facilities
- Conflict Minerals
- FCC Statement
- Manufacturing Quality
- Modern Slavery Statement
- Pressure Equipment Directive
- REACH
- RoHS2
- WEEE2
- Recycling Policy
- Warranty and Returns

This information is also available in pdf format.

# Appendix E

## Return Document & Decontamination Declaration

## Appendix E Return Document &amp; Decontamination Declaration

## Decontamination Certificate

**IMPORTANT NOTE:** Please complete this form prior to this instrument, or any components, leaving your site and being returned to us, or, where applicable, prior to any work being carried out by a Michell engineer at your site.

Instrument			Serial Number	
Warranty Repair?	YES	NO	Original PO #	
Company Name			Contact Name	
Address				
Telephone #		E-mail address		
Reason for Return /Description of Fault:				
Has this equipment been exposed (internally or externally) to any of the following? Please circle (YES/NO) as applicable and provide details below				
Biohazards	YES		NO	
Biological agents	YES		NO	
Hazardous chemicals	YES		NO	
Radioactive substances	YES		NO	
Other hazards	YES		NO	
Please provide details of any hazardous materials used with this equipment as indicated above (use continuation sheet if necessary)				
Your method of cleaning/decontamination				
Has the equipment been cleaned and decontaminated?	YES		NOT NECESSARY	
Michell Instruments will not accept instruments that have been exposed to toxins, radio-activity or bio-hazardous materials. For most applications involving solvents, acidic, basic, flammable or toxic gases a simple purge with dry gas (dew point <-30°C) over 24 hours should be sufficient to decontaminate the unit prior to return. <b>Work will not be carried out on any unit that does not have a completed decontamination declaration.</b>				
<b>Decontamination Declaration</b>				
I declare that the information above is true and complete to the best of my knowledge, and it is safe for Michell personnel to service or repair the returned instrument.				
Name (Print)			Position	
Signature			Date	

# Appendix F

## Calculating Conversion Factors for Gas Mixes

## Appendix F Calculating Conversion Factors for Gas Mixes

Setting the correct flow rate is crucial to correct operation of the QMA601. If the gas being sampled contains multiple components, then the conversion factor must be calculated and entered as a 'user' carrier gas.

The conversion factor will be altered for gas mixtures as follows:

$$\frac{1}{C_{mix}} = \frac{V_1}{C_1} + \frac{V_2}{C_2} + \frac{V_n}{C_n}$$

$C_{mix}$  = Conversion factor for the gas mix

$C_n$  = Conversion factor for the gas 'n'

$V_n$  = Conversion factor for the gas 'n' in the mix

For example, if the gas mixture contains:

10% N<sub>2</sub>       $C_1 = 1.000$

30% Ar       $C_2 = 1.395$

50% CH<sub>4</sub>       $C_3 = 0.7419$

10% CO<sub>2</sub>       $C_4 = 0.7186$

$$\frac{1}{C_{mix}} = \frac{0.1}{1} + \frac{0.3}{1.395} + \frac{0.5}{0.7419} + \frac{0.1}{0.7186} \quad C_{mix} = 0.8865$$

Below are the conversion factors for some common gases. If the gas you are measuring contains a component that is not on this list, please contact your Michell representative.

1.000	Air
1.395	Ar - Argon
0.742	CH <sub>4</sub> - Methane
0.594	C <sub>2</sub> H <sub>2</sub> - Ethyne
0.568	C <sub>2</sub> H <sub>4</sub> - Ethylene
0.466	C <sub>2</sub> H <sub>6</sub> - Ethane
0.377	C <sub>3</sub> H <sub>6</sub> - Propylene
0.320	C <sub>3</sub> H <sub>8</sub> - Propane
0.238	C <sub>4</sub> H <sub>10</sub> - Butane
0.999	CO - Carbon Monoxide
0.718	CO <sub>2</sub> - Carbon Dioxide
1.019	H <sub>2</sub> - Hydrogen
1.422	He - Helium
1.446	Kr - Krypton
1.002	N <sub>2</sub> - Nitrogen
1.415	Ne - Neon
0.757	NH <sub>3</sub> - Ammonia
0.971	NO - Nitrogen Oxide
0.694	N <sub>2</sub> O - Nitrous Oxide
0.978	O <sub>2</sub> - Oxygen
1.339	XE - Xenon

# EU Declaration of Conformity



Manufacturer: Michell Instruments Limited  
Address: 48 Lancaster Way Business Park  
Ely, Cambridgeshire  
CB6 3NW. UK.



Equipment Type: **QMA 601Ex\* Series Process Moisture Analyser:**

## 2014/34/EU ATEX Directive

Provisions of the Directive fulfilled by the Equipment:

**Group II Category 2GD**      **Ex d IIB+H2 T6 Gb**  
**Ex tb IIIC 85°C Db IP66**  
**Tamb -40°C to +60°C**

Notified Body for Production (QAN & QAR):

**SGS Fimko OY, Helsinki, Finland. Notified Body No. 0598**

EU-Type Examination Certificate:

**TRAC 14ATEX0042X**

Standards used:

**EN 60079-1:2007**

On 1<sup>st</sup> August 2017 this standard will cease to have harmonised status. **EN60079-1:2014** has now superseded.

**EN 60079-0:2012**

On 7<sup>th</sup> October 2016 this standard will cease to have harmonised status. **EN60079-0:2012/A11:2013** has now superseded.

**EN60079-31:2009**

On 1<sup>st</sup> January 2017 this standard will cease to have harmonised status. **EN60079-31:2014** has now superseded.

A technical review of these standards against the old standards showed that the equipment remains in conformance with all relevant clauses and that the State of the Art is maintained. The Essential Health & Safety Requirements of the Directive is still maintained with no changes necessary for the safe and reliable functioning and operation of the product with respect to the risks of explosion).

## IECEX

Certificate of Conformity No.

**IECEX TRC 14.0016X**      **Ex d IIB+H2 T6 Gb**  
**Ex tb IIIC 85°C Db IP66**  
**Tamb -40°C to +60°C**

Standards used:

**IEC60079-0:2011**

**IEC60079-1:2007**

**IEC60079-31:2008**

## Other Directives

### **2014/30/EU EMC Directive**

Is in conformity with the following Standard(s) or Normative Document(s):

EN61326-1:2006 *Electrical equipment for measurement, control and laboratory use - EMC requirements. Class B (emissions) and Industrial Locations (immunity).*

### **2011/65/EU Restriction of Hazardous Substances Directive (RoHS2)**

RoHS2 EU Directive 2011/65/EU (Article 3, [24]) states, "industrial monitoring and control instruments means monitoring and control instruments designed exclusively for industrial or professional use".

**EN61010-1:2010** Safety Requirements for Electrical Equipment for Measurement, Control, and Laboratory Use - Part 1: General Requirements.

### **2014/68/EU PE Directive**

This product and sample systems & accessories that may be supplied with it does not bear CE marking for the Pressure Equipment Directive, and are supplied in accordance with Article 4, paragraph 3 of 2014/68/EU by using SEP (sound engineering practice) in the design and manufacturer and are provided with adequate instructions for use.

On behalf of the above named company, we the manufacturer declare under our sole responsibility that, on the date the equipment accompanied by this declaration is placed on the market, the equipment conforms with all technical and regulatory requirements of the above listed directives.

Andrew M.V. Stokes, Technical Director.

March 2019

Ely, UK

ECD QMA601 Issue 06A



<http://www.michell.com>