

Operating Instructions

Proline Prosonic Flow B 200

HART

Ultrasonic transit time flowmeter

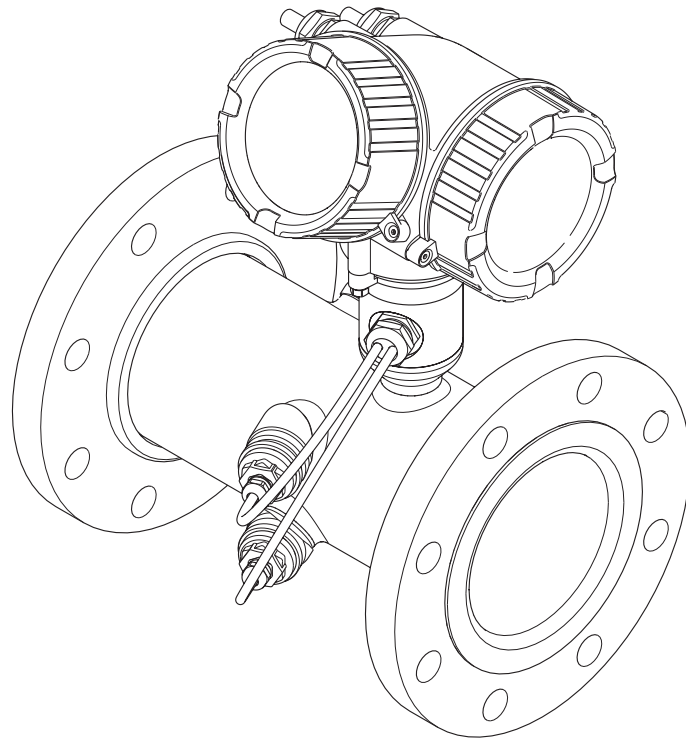

- Make sure the document is stored in a safe place such that it is always available when working on or with the device.
- To avoid danger to individuals or the facility, read the "Basic safety instructions" section carefully, as well as all other safety instructions in the document that are specific to working procedures.
- The manufacturer reserves the right to modify technical data without prior notice. Your Endress+Hauser Sales Center will supply you with current information and updates to these instructions.

Table of contents

1	Document information	6		
1.1	Document function	6		
1.2	Symbols used	6		
1.2.1	Safety symbols	6		
1.2.2	Electrical symbols	6		
1.2.3	Tool symbols	6		
1.2.4	Symbols for certain types of information	7		
1.2.5	Symbols in graphics	7		
1.3	Documentation	7		
1.3.1	Standard documentation	8		
1.3.2	Supplementary device-dependent documentation	8		
1.4	Registered trademarks	8		
2	Basic safety instructions	9		
2.1	Requirements for the personnel	9		
2.2	Designated use	9		
2.3	Workplace safety	10		
2.4	Operational safety	10		
2.5	Product safety	10		
2.6	IT security	11		
3	Product description	12		
3.1	Product design	12		
4	Incoming acceptance and product identification	13		
4.1	Incoming acceptance	13		
4.2	Product identification	13		
4.2.1	Transmitter nameplate	14		
4.2.2	Sensor nameplate	15		
5	Storage and transport	16		
5.1	Storage conditions	16		
5.2	Transporting the product	16		
5.2.1	Measuring devices without lifting lugs	16		
5.2.2	Measuring devices with lifting lugs	17		
5.2.3	Transporting with a fork lift	17		
5.3	Packaging disposal	17		
6	Installation	18		
6.1	Installation conditions	18		
6.1.1	Mounting position	18		
6.1.2	Requirements from environment and process	20		
6.2	Mounting the measuring device	21		
6.2.1	Required tools	21		
6.2.2	Preparing the measuring device	21		
6.2.3	Mounting the measuring device	21		
6.2.4	Turning the transmitter housing	21		
6.2.5	Turning the display module	22		
6.3	Post-mounting check	23		
7	Electrical connection	24		
7.1	Connection conditions	24		
7.1.1	Required tools	24		
7.1.2	Connecting cable requirements	24		
7.1.3	Terminal assignment	25		
7.1.4	Requirements for the supply unit	25		
7.1.5	Preparing the measuring device	26		
7.2	Connecting the measuring device	27		
7.2.1	Connecting the transmitter	27		
7.2.2	Ensuring potential equalization	28		
7.3	Special connection instructions	29		
7.3.1	Connection examples	29		
7.4	Ensuring the degree of protection	31		
7.5	Post-connection check	32		
8	Operation options	33		
8.1	Overview of operation options	33		
8.2	Structure and function of the operating menu	34		
8.2.1	Structure of the operating menu	34		
8.2.2	Operating philosophy	35		
8.3	Access to the operating menu via the local display	36		
8.3.1	Operational display	36		
8.3.2	Navigation view	37		
8.3.3	Editing view	39		
8.3.4	Operating elements	41		
8.3.5	Opening the context menu	41		
8.3.6	Navigating and selecting from list	43		
8.3.7	Calling the parameter directly	43		
8.3.8	Calling up help text	44		
8.3.9	Changing the parameters	45		
8.3.10	User roles and related access authorization	46		
8.3.11	Disabling write protection via access code	46		
8.3.12	Enabling and disabling the keypad lock	46		
8.4	Access to the operating menu via the operating tool	47		
8.4.1	Connecting the operating tool	48		
8.4.2	Field Xpert SFX350, SFX370	49		
8.4.3	FieldCare	49		
8.4.4	AMS Device Manager	50		
8.4.5	SIMATIC PDM	50		
8.4.6	Field Communicator 475	51		
9	System integration	52		
9.1	Overview of device description files	52		
9.1.1	Current version data for the device	52		

9.1.2	Operating tools	52	12.3	Diagnostic information in FieldCare	110
9.2	Measured variables via HART protocol	52	12.3.1	Diagnostic options	110
9.3	Other settings	53	12.3.2	Calling up remedy information	111
9.3.1	Burst mode functionality in accordance with HART 7 Specification	53	12.4	Adapting the diagnostic information	111
10	Commissioning	57	12.4.1	Adapting the diagnostic behavior	111
10.1	Function check	57	12.4.2	Adapting the status signal	111
10.2	Switching on the measuring device	57	12.5	Overview of diagnostic information	112
10.3	Setting the operating language	57	12.6	Pending diagnostic events	115
10.4	Configuring the measuring device	58	12.7	Diagnostic list	116
10.4.1	Defining the tag name	58	12.8	Event logbook	116
10.4.2	Setting the system units	59	12.8.1	Event history	116
10.4.3	Selecting and setting the medium	62	12.8.2	Filtering the event logbook	117
10.4.4	Configuring the current input	63	12.8.3	Overview of information events	117
10.4.5	Configuring the current output	65	12.9	Resetting the measuring device	118
10.4.6	Configuring the pulse/frequency/ switch output	68	12.9.1	Function scope of the "Device reset" parameter	119
10.4.7	Configuring the local display	78	12.10	Device information	119
10.4.8	Configuring the output conditioning	80	12.11	Firmware history	122
10.4.9	Configuring the low flow cut off	82	13	Maintenance	123
10.5	Advanced settings	84	13.1	Maintenance tasks	123
10.5.1	Configuring the totalizer	85	13.1.1	Exterior cleaning	123
10.5.2	Carrying out additional display configurations	87	13.2	Measuring and test equipment	123
10.5.3	Administration configuration	89	13.3	Endress+Hauser services	123
10.6	Configuration management	90	14	Repair	124
10.6.1	Function scope of the "Configuration management" parameter	91	14.1	General notes	124
10.7	Simulation	91	14.2	Spare parts	124
10.8	Protecting settings from unauthorized access	94	14.3	Endress+Hauser services	125
10.8.1	Write protection via access code	94	14.4	Return	125
10.8.2	Write protection via write protection switch	95	14.5	Disposal	125
11	Operation	97	14.5.1	Removing the measuring device	125
11.1	Adjusting the operating language	97	14.5.2	Disposing of the measuring device	126
11.2	Configuring the display	97	15	Accessories	127
11.3	Reading measured values	97	15.1	Device-specific accessories	127
11.3.1	Process variables	97	15.1.1	For the transmitter	127
11.3.2	System values	99	15.1.2	For the sensor	128
11.3.3	Totalizer	99	15.2	Communication-specific accessories	128
11.3.4	Output values	100	15.3	Service-specific accessories	129
11.4	Adapting the measuring device to the process conditions	101	15.4	System components	129
11.5	Performing a totalizer reset	101	16	Technical data	130
11.6	Showing data logging	102	16.1	Application	130
12	Diagnostics and troubleshooting	105	16.2	Function and system design	130
12.1	General troubleshooting	105	16.3	Input	130
12.2	Diagnostic information on local display	107	16.4	Output	132
12.2.1	Diagnostic message	107	16.5	Power supply	134
12.2.2	Calling up remedial measures	109	16.6	Performance characteristics	136
			16.7	Installation	138
			16.8	Environment	138
			16.9	Process	139
			16.10	Mechanical construction	139
			16.11	Operability	144
			16.12	Certificates and approvals	146
			16.13	Application packages	147

16.14 Accessories 147
16.15 Documentation 148
Index 150





1 Document information

1.1 Document function







These Operating Instructions contain all the information that is required in various phases of the life cycle of the device: from product identification, incoming acceptance and storage, to mounting, connection, operation and commissioning through to troubleshooting, maintenance and disposal.

1.2 Symbols used



1.2.1 Safety symbols

Symbol	Meaning
	DANGER! This symbol alerts you to a dangerous situation. Failure to avoid this situation will result in serious or fatal injury.
	WARNING! This symbol alerts you to a dangerous situation. Failure to avoid this situation can result in serious or fatal injury.
	CAUTION! This symbol alerts you to a dangerous situation. Failure to avoid this situation can result in minor or medium injury.
	NOTE! This symbol contains information on procedures and other facts which do not result in personal injury.





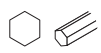





1.2.2 Electrical symbols

Symbol	Meaning	Symbol	Meaning
	Direct current		Alternating current
	Direct current and alternating current		Ground connection A grounded terminal which, as far as the operator is concerned, is grounded via a grounding system.
	Protective ground connection A terminal which must be connected to ground prior to establishing any other connections.		Equipotential connection A connection that has to be connected to the plant grounding system: This may be a potential equalization line or a star grounding system depending on national or company codes of practice.





1.2.3 Tool symbols

Symbol	Meaning
	Flat blade screwdriver
	Allen key
	Open-ended wrench



1.2.4 Symbols for certain types of information

Symbol	Meaning
	Permitted Procedures, processes or actions that are permitted.
	Preferred Procedures, processes or actions that are preferred.
	Forbidden Procedures, processes or actions that are forbidden.
	Tip Indicates additional information.
	Reference to documentation
	Reference to page
	Reference to graphic
	Series of steps
	Result of a sequence of actions
	Help in the event of a problem
	Visual inspection

1.2.5 Symbols in graphics

Symbol	Meaning	Symbol	Meaning
1, 2, 3,...	Item numbers		Series of steps
A, B, C, ...	Views	A-A, B-B, C-C, ...	Sections
	Hazardous area		Safe area (non-hazardous area)
	Flow direction		

1.3 Documentation

-  For an overview of the scope of the associated Technical Documentation, refer to the following:
 - The CD-ROM provided for the device (depending on the device version, the CD-ROM might not be part of the delivery!)
 - The *W@M Device Viewer* : Enter the serial number from the nameplate (www.endress.com/deviceviewer)
 - The *Endress+Hauser Operations App*: Enter the serial number from the nameplate or scan the 2-D matrix code (QR code) on the nameplate.
-  For a detailed list of the individual documents along with the documentation code
→  148

1.3.1 Standard documentation

Document type	Purpose and content of the document
Technical Information	Planning aid for your device The document contains all the technical data on the device and provides an overview of the accessories and other products that can be ordered for the device.
Brief Operating Instructions	Guide that takes you quickly to the 1st measured value The Brief Operating Instructions contain all the essential information from incoming acceptance to initial commissioning.
Description of Device Parameters	Reference for your parameters The document provides a detailed explanation of each individual parameter in the operating menu. The description is aimed at those who work with the device over the entire life cycle and perform specific configurations.

1.3.2 Supplementary device-dependent documentation

Additional documents are supplied depending on the device version ordered: Always comply strictly with the instructions in the supplementary documentation. The supplementary documentation is an integral part of the device documentation.

1.4 Registered trademarks

HART®

Registered trademark of the HART Communication Foundation, Austin, USA

Applicator®, FieldCare®, Field Xpert™, HistoROM®, Heartbeat Technology™

Registered or registration-pending trademarks of the Endress+Hauser Group

2 Basic safety instructions

2.1 Requirements for the personnel

The personnel for installation, commissioning, diagnostics and maintenance must fulfill the following requirements:

- ▶ Trained, qualified specialists must have a relevant qualification for this specific function and task
- ▶ Are authorized by the plant owner/operator
- ▶ Are familiar with federal/national regulations
- ▶ Before beginning work, the specialist staff must have read and understood the instructions in the Operating Instructions and supplementary documentation as well as in the certificates (depending on the application)
- ▶ Following instructions and basic conditions

The operating personnel must fulfill the following requirements:

- ▶ Being instructed and authorized according to the requirements of the task by the facility's owner-operator
- ▶ Following the instructions in these Operating Instructions

2.2 Designated use

Application and media

The measuring device described in these Instructions is intended only for flow measurement of gases.

Depending on the version ordered, the measuring device can also measure potentially explosive, flammable, poisonous and oxidizing media.

Measuring devices for use in hazardous areas, in hygienic applications or in applications where there is an increased risk due to process pressure, are labeled accordingly on the nameplate.

To ensure that the measuring device remains in proper condition for the operation time:

- ▶ Only use the measuring device in full compliance with the data on the nameplate and the general conditions listed in the Operating Instructions and supplementary documentation.
- ▶ Check the nameplate to verify if the device ordered can be put to its intended use in the approval-related area (e.g. explosion protection, pressure vessel safety).
- ▶ Use the measuring device only for media against which the process-wetted materials are adequately resistant.
- ▶ If the measuring device is not operated at atmospheric temperature, compliance with the relevant basic conditions specified in the associated device documentation is absolutely essential: "Documentation" section →  7.
- ▶ Protect the measuring device permanently against corrosion from environmental influences.

Incorrect use

Non-designated use can compromise safety. The manufacturer is not liable for damage caused by improper or non-designated use.

WARNING

Danger of breakage of the sensor due to corrosive or abrasive fluids or from environmental conditions!

- ▶ Verify the compatibility of the process fluid with the sensor material.
- ▶ Ensure the resistance of all fluid-wetted materials in the process.
- ▶ Keep within the specified pressure and temperature range.

Verification for borderline cases:

- ▶ For special fluids and fluids for cleaning, Endress+Hauser is glad to provide assistance in verifying the corrosion resistance of fluid-wetted materials, but does not accept any warranty or liability as minute changes in the temperature, concentration or level of contamination in the process can alter the corrosion resistance properties.

Residual risks

The external surface temperature of the housing can increase by max. 20 K due to the power consumption of the electronic components. Hot process fluids passing through the measuring device will further increase the surface temperature of the housing. The surface of the sensor, in particular, can reach temperatures which are close to the fluid temperature.

Possible burn hazard due to fluid temperatures!

- ▶ For elevated fluid temperature, ensure protection against contact to prevent burns.

2.3 Workplace safety

For work on and with the device:

- ▶ Wear the required personal protective equipment according to federal/national regulations.

For welding work on the piping:

- ▶ Do not ground the welding unit via the measuring device.

If working on and with the device with wet hands:

- ▶ It is recommended to wear gloves on account of the higher risk of electric shock.

2.4 Operational safety

Risk of injury.

- ▶ Operate the device in proper technical condition and fail-safe condition only.
- ▶ The operator is responsible for interference-free operation of the device.

Conversions to the device

Unauthorized modifications to the device are not permitted and can lead to unforeseeable dangers.

- ▶ If, despite this, modifications are required, consult with Endress+Hauser.

Repair

To ensure continued operational safety and reliability,

- ▶ Carry out repairs on the device only if they are expressly permitted.
- ▶ Observe federal/national regulations pertaining to repair of an electrical device.
- ▶ Use original spare parts and accessories from Endress+Hauser only.

2.5 Product safety

This measuring device is designed in accordance with good engineering practice to meet state-of-the-art safety requirements, has been tested, and left the factory in a condition in which it is safe to operate.

It meets general safety standards and legal requirements. It also complies with the EC directives listed in the device-specific EC Declaration of Conformity. Endress+Hauser confirms this by affixing the CE mark to the device.

2.6 IT security

We only provide a warranty if the device is installed and used as described in the Operating Instructions. The device is equipped with security mechanisms to protect it against any inadvertent changes to the device settings.

IT security measures in line with operators' security standards and designed to provide additional protection for the device and device data transfer must be implemented by the operators themselves.

3 Product description

The device consists of a transmitter and a sensor.

The device is available as a compact version:

The transmitter and sensor form a mechanical unit.

3.1 Product design

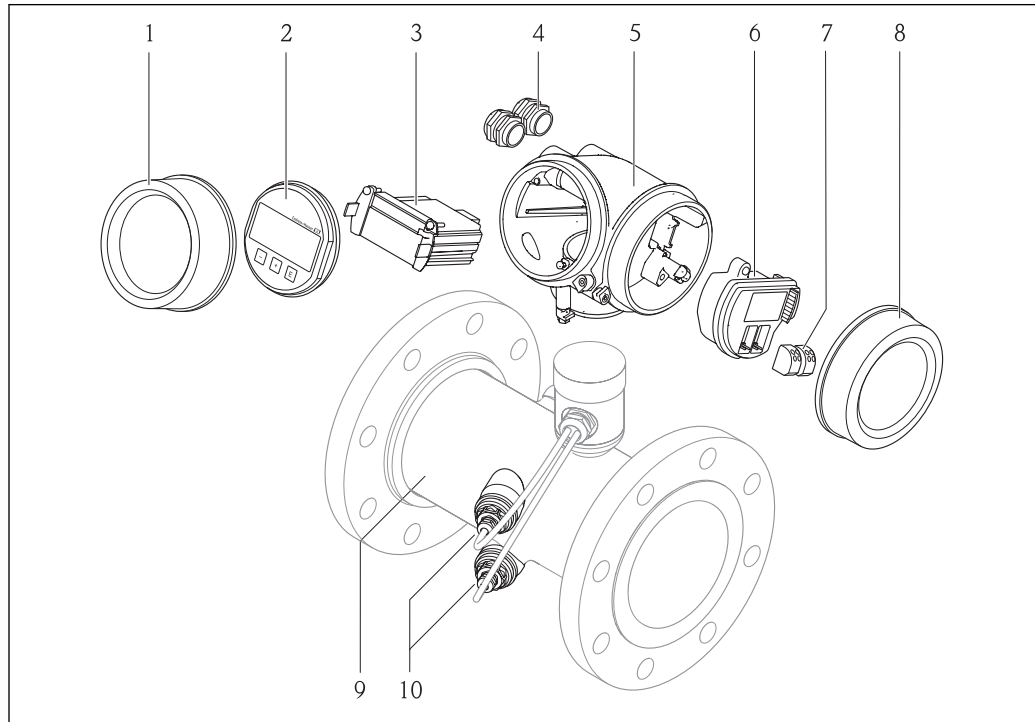

A0016199

1 Important components of a measuring device

- 1 Electronics compartment cover
- 2 Display module
- 3 Main electronics module
- 4 Cable glands
- 5 Transmitter housing
- 6 I/O electronics module
- 7 Terminals (spring loaded terminals, pluggable)
- 8 Connection compartment cover
- 9 Sensor
- 10 Transducer

4 Incoming acceptance and product identification

4.1 Incoming acceptance

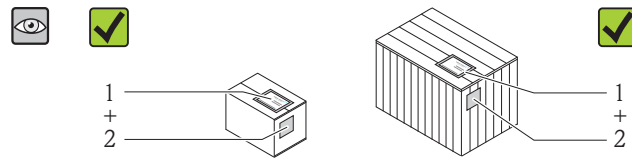

Are the order codes on the delivery note (1) and the product sticker (2) identical?

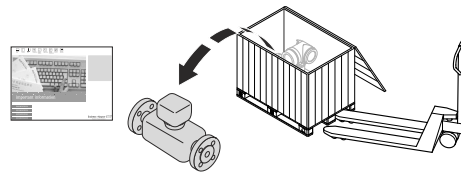



Are the goods undamaged?

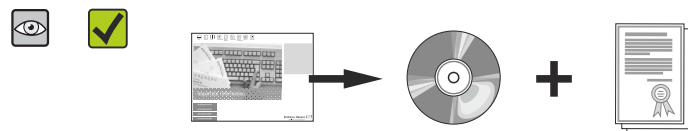

Do the nameplate data match the ordering information on the delivery note?



Is the CD-ROM with the Technical Documentation (depends on device version) and documents present?



-  If one of the conditions is not satisfied, contact your Endress+Hauser Sales Center.
- Depending on the device version, the CD-ROM might not be part of the delivery! The Technical Documentation is available via the Internet or via the *Endress+Hauser Operations App*, see the "Product identification" section →  14.

4.2 Product identification

The following options are available for identification of the measuring device:

- Nameplate specifications
- Order code with breakdown of the device features on the delivery note
- Enter serial numbers from nameplates in *W@M Device Viewer* (www.endress.com/deviceviewer): All information about the measuring device is displayed.
- Enter the serial number from the nameplates into the *Endress+Hauser Operations App* or scan the 2-D matrix code (QR code) on the nameplate with the *Endress+Hauser Operations App*: all the information for the measuring device is displayed.

For an overview of the scope of the associated Technical Documentation, refer to the following:

- The chapters "Additional standard documentation on the device" →  8 and "Supplementary device-dependent documentation" →  8
- The *W@M Device Viewer*: Enter the serial number from the nameplate (www.endress.com/deviceviewer)
- The *Endress+Hauser Operations App*: Enter the serial number from the nameplate or scan the 2-D matrix code (QR code) on the nameplate.

4.2.1 Transmitter nameplate

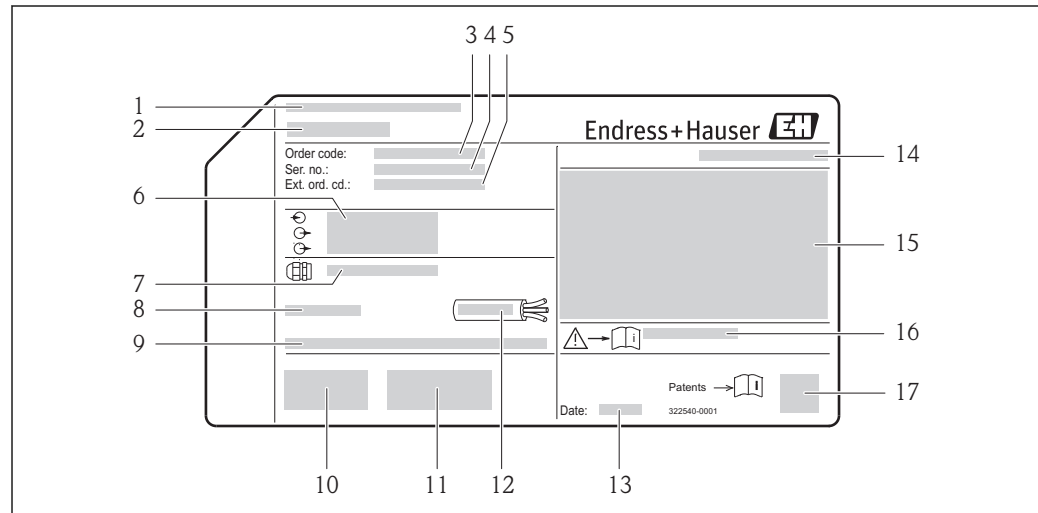

A0013906

 2 Example of a transmitter nameplate

- 1 Manufacturing location
- 2 Name of the transmitter
- 3 Order code
- 4 Serial number (Ser. no.)
- 5 Extended order code (Ext. ord. cd.)
- 6 Electrical connection data, e.g. available inputs and outputs, supply voltage
- 7 Type of cable glands
- 8 Permitted ambient temperature (T_a)
- 9 Firmware version (FW) and device revision (Dev.Rev.) from the factory
- 10 CE mark, C-Tick
- 11 Additional information on version: certificates, approvals
- 12 Permitted temperature range for cable
- 13 Manufacturing date: year-month
- 14 Degree of protection
- 15 Approval information for explosion protection
- 16 Document number of safety-related supplementary documentation
- 17 2-D matrix code

4.2.2 Sensor nameplate

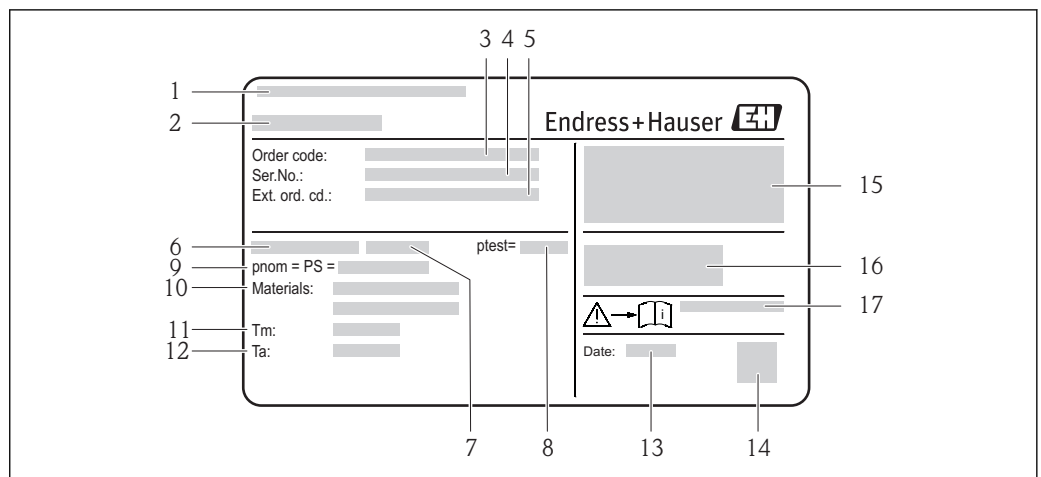

A0016420

 3 Example of 1st sensor nameplate

- 1 Manufacturing location
- 2 Name of the sensor
- 3 Order code
- 4 Serial number
- 5 Extended order code
- 6 Nominal diameter of the sensor
- 7 Flange type
- 8 Test pressure of the sensor
- 9 Nominal pressure of the sensor (max. permitted pressure)
- 10 Material of measuring tube and seal
- 11 Medium temperature range
- 12 Ambient temperature range
- 13 Manufacturing date: year-month
- 14 2-D matrix code
- 15 Degree of protection, approval information for explosion protection and Pressure Equipment Directive
- 16 CE mark, C-Tick
- 17 Document number of safety-related supplementary documentation

Order code

The measuring device is reordered using the order code.

Extended order code

- The device type (product root) and basic specifications (mandatory features) are always listed.
- Of the optional specifications (optional features), only the safety and approval-related specifications are listed (e.g. LA). If other optional specifications are also ordered, these are indicated collectively using the # placeholder symbol (e.g. #LA#).
- If the ordered optional specifications do not include any safety and approval-related specifications, they are indicated by the + placeholder symbol (e.g. XXXXXX-ABCDE+).

5 Storage and transport

5.1 Storage conditions

Observe the following notes for storage:

- Store in the original packaging to ensure protection from shock.
- Do not remove protective covers or protective caps installed on process connections. They prevent mechanical damage to the sealing surfaces and contamination in the measuring tube.
- Protect from direct sunlight to avoid unacceptably high surface temperatures.
- Store in a dry and dust-free place.
- Do not store outdoors.

Storage temperature: -40 to $+80$ °C (-40 to $+176$ °F), preferably at $+20$ °C ($+68$ °F)

5.2 Transporting the product

Transport the measuring device to the measuring point in the original packaging.

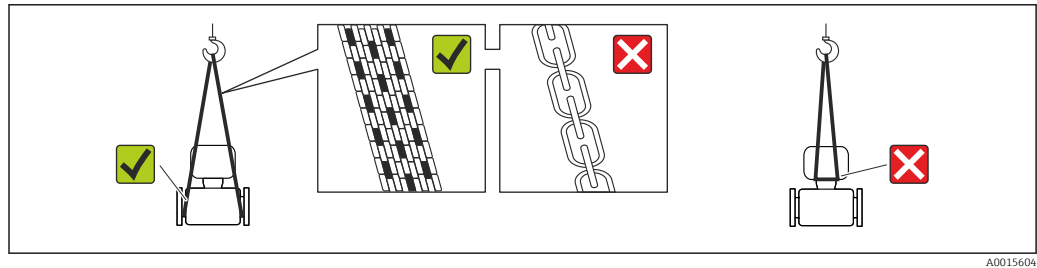

A0015604

- i** Do not remove protective covers or caps installed on process connections. They prevent mechanical damage to the sealing surfaces and contamination in the measuring tube.

5.2.1 Measuring devices without lifting lugs

⚠ WARNING

Center of gravity of the measuring device is higher than the suspension points of the webbing slings.

Risk of injury if the measuring device slips.

- ▶ Secure the measuring device against slipping or turning.
- ▶ Observe the weight specified on the packaging (stick-on label).

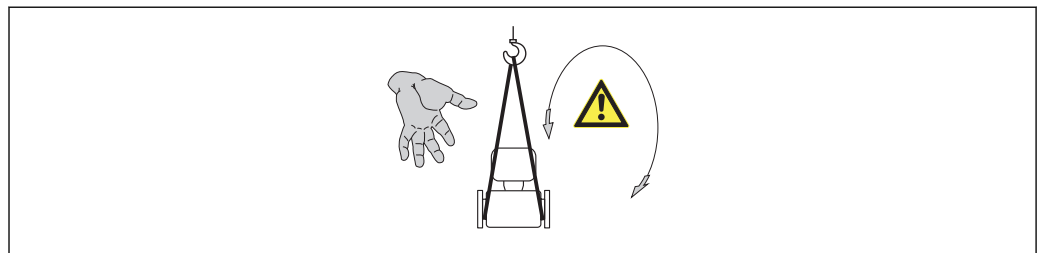

A0015606

5.2.2 Measuring devices with lifting lugs

⚠ CAUTION

Special transportation instructions for devices with lifting lugs

- ▶ Only use the lifting lugs fitted on the device or flanges to transport the device.
- ▶ The device must always be secured at two lifting lugs at least.

5.2.3 Transporting with a fork lift

If transporting in wood crates, the floor structure enables the crates to be lifted lengthwise or at both sides using a forklift.

5.3 Packaging disposal

All packaging materials are environmentally friendly and 100% recyclable:

- Measuring device secondary packaging: polymer stretch film that conforms to EC Directive 2002/95/EC (RoHS).
- Packaging:
 - Wood crate, treated in accordance with ISPM 15 standard, which is confirmed by the affixed IPPC logo.
 - or
 - Carton in accordance with European Packaging Directive 94/62EC; recyclability is confirmed by the affixed RESY symbol.
- Seaworthy packaging (optional): Wood crate, treated in accordance with ISPM 15 standard, which is confirmed by the affixed IPPC logo.
- Carrying and mounting hardware:
 - Disposable plastic pallet
 - Plastic straps
 - Plastic adhesive strips
- Dunnage: Paper cushion

6 Installation

6.1 Installation conditions

No special measures such as supports are necessary. External forces are absorbed by the construction of the device.

6.1.1 Mounting position

Mounting location

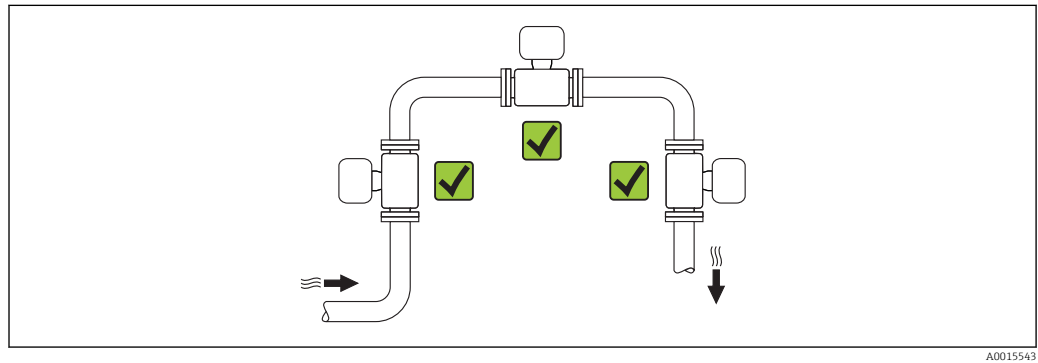

A0015543





Orientation

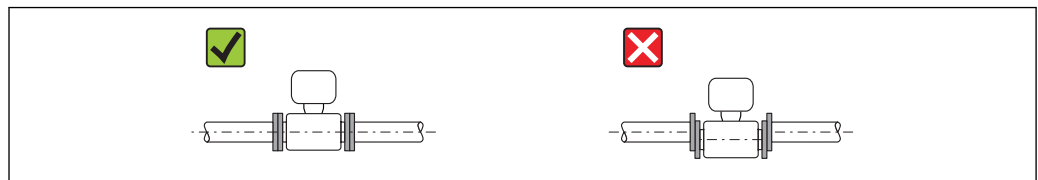

The direction of the arrow on the sensor helps you to install the sensor according to the flow direction (direction of medium flow through the piping).

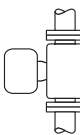
- i ■ Install the measuring device in a parallel plane free of external mechanical stress.
- The internal diameter of the pipe must match the internal diameter of the sensor: see the "Technical Information" device document, "Design and dimensions" section.

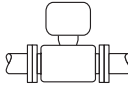

A0015895

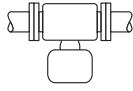
Orientation		Compact version	
A	Vertical orientation	 <small>A0015545</small>	
B	Horizontal orientation, transmitter head up *	 <small>A0015589</small>	

Orientation		Compact version
C	Horizontal orientation, transmitter head down *	 A0015590
D	Horizontal orientation, transmitter head at side	 A0015592

i * A maximum deviation of only $\pm 3^\circ$ is permitted for the horizontal alignment of the converters.

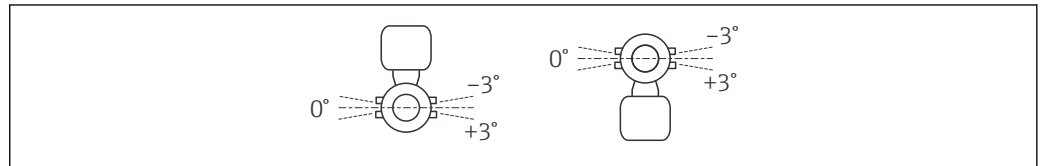

A0015534

Inlet and outlet runs

If possible, the sensor should be installed upstream from valves, T-pieces, elbows etc. To attain the specified level of accuracy of the measuring device, the below mentioned inlet and outlet runs must be maintained at minimum. If there are several flow disturbances present, the longest specified inlet run must be maintained.

Single-path version: DN 50 (2"), DN 80 (3")

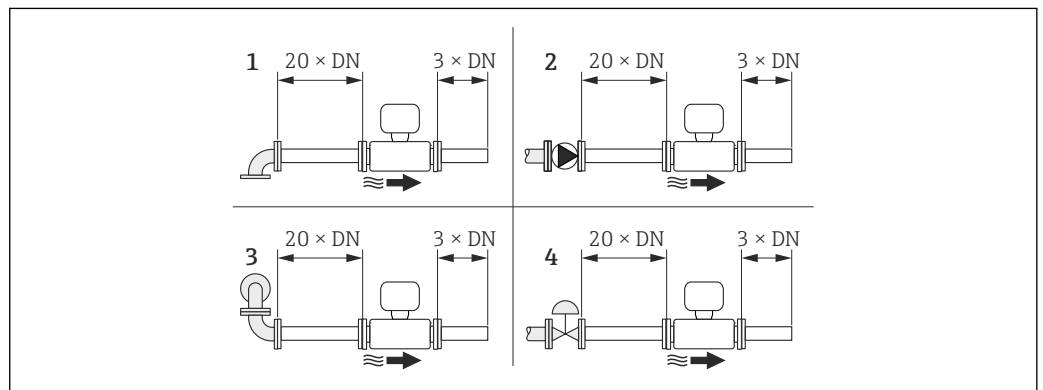

A0015453

4 Single-path version: minimum inlet and outlet runs with various flow obstructions

- 1 90° elbow or T-section
- 2 Pump
- 3 2 × 90° elbow, 3-dimensional
- 4 Control valve

Two-path version: DN 100 to 200 (4 to 8")

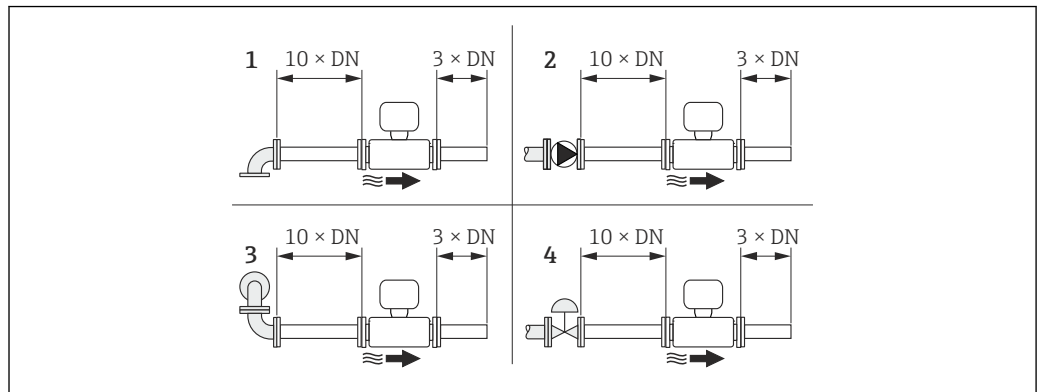

A0015553

5 Two-path version: minimum inlet and outlet runs with various flow obstructions

- 1 90 ° elbow or T-section
- 2 Pump
- 3 2 × 90 ° elbow, 3-dimensional
- 4 Control valve

Outlet runs when installing external devices

If installing an external device, observe the specified distance.

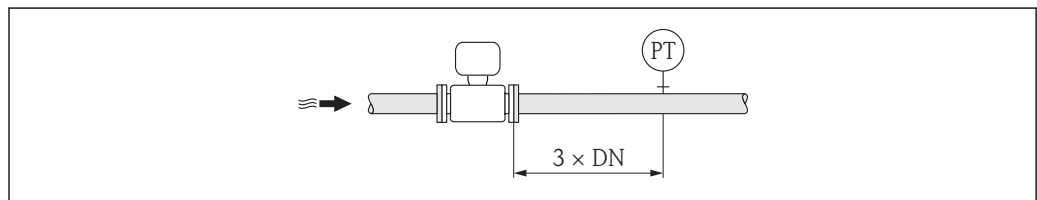

A0015901

PT Pressure transmitter

Installation dimensions

For the dimensions and installation lengths of the device, see the "Technical Information" document, "Mechanical construction" section

6.1.2 Requirements from environment and process

Ambient temperature range

Transmitter	-40 to +60 °C (-40 to +140 °F)
Local display	-20 to +60 °C (-4 to +140 °F), the readability of the display may be impaired at temperatures outside the temperature range.
Sensor	<ul style="list-style-type: none"> ■ Flange material carbon steel: -10 to +60 °C (+14 to +140 °F) ■ Flange material stainless steel: -40 to +60 °C (-40 to +140 °F) ■ Version without flange: -40 to +60 °C (-40 to +140 °F)

- ▶ If operating outdoors:
Avoid direct sunlight, particularly in warm climatic regions.

System pressure

Sensor

Max. 10 bar (145 psi)

Thermal insulation

For optimum temperature and methane fraction measurement (order characteristic for "Sensor version", option 2 "Volume flow + Biogas analysis"), make sure that heat is neither lost nor applied to the sensor. Thermal insulation can ensure that such heat transfer does not take place.

Thermal insulation is particularly recommended in situations where there is a large difference between the process temperature and the ambient temperature. This can result in heat convection errors during temperature measurement. A further factor which can lead to measurement errors due to heat convection is a low flow velocity.

6.2 Mounting the measuring device

6.2.1 Required tools

For transmitter

- For turning the transmitter housing: Open-ended wrench 8 mm
- For opening the securing clamps: Allen key 3 mm

For sensor

For flanges and other process connections: Corresponding mounting tools

6.2.2 Preparing the measuring device

1. Remove all remaining transport packaging.
2. Remove any protective covers or protective caps present from the sensor.
3. Remove stick-on label on the electronics compartment cover.

6.2.3 Mounting the measuring device

⚠ WARNING

Danger due to improper process sealing!

- ▶ Ensure that the inside diameters of the gaskets are greater than or equal to that of the process connections and piping.
- ▶ Ensure that the gaskets are clean and undamaged.
- ▶ Install the gaskets correctly.

1. Ensure that the direction of the arrow on the sensor matches the flow direction of the medium.
2. Install the measuring device or turn the transmitter housing so that the cable entries do not point upwards.

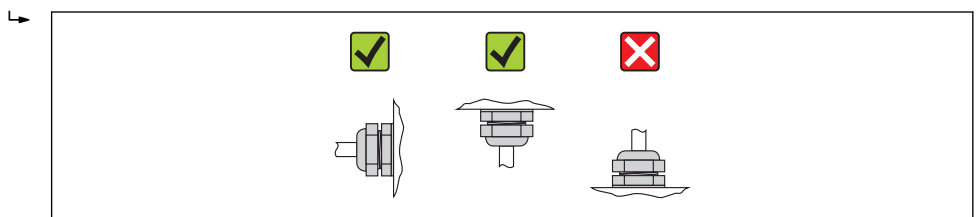

A0013964

6.2.4 Turning the transmitter housing

To provide easier access to the connection compartment or display module, the transmitter housing can be turned.

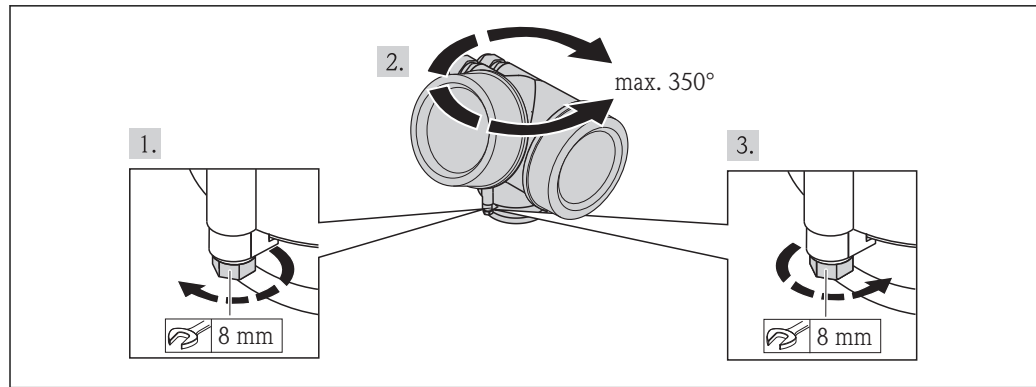

A0013713

1. Release the fixing screw.
2. Turn the housing to the desired position.
3. Firmly tighten the securing screw.

6.2.5 Turning the display module

The display module can be turned to optimize display readability and operability.

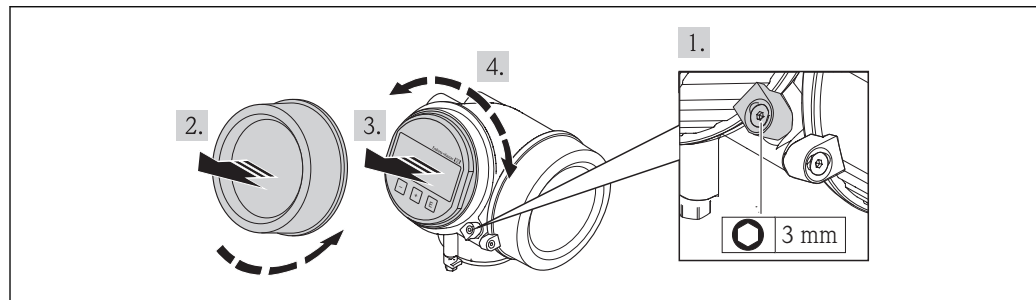

A0013905

1. Loosen the securing clamp of the electronics compartment cover using an Allen key.
2. Unscrew cover of the electronics compartment from the transmitter housing.
3. Optional: pull out the display module with a gentle rotational movement.
4. Rotate the display module into the desired position: Max. $8 \times 45^\circ$ in each direction.
5. Without display module pulled out:
Allow display module to engage at desired position.
6. With display module pulled out:
Feed the cable into the gap between the housing and main electronics module and plug the display module into the electronics compartment until it engages.
7. Reverse the removal procedure to reassemble the transmitter.

6.3 Post-mounting check

Is the device undamaged (visual inspection)?	<input type="checkbox"/>
Does the measuring device conform to the measuring point specifications? For example: <ul style="list-style-type: none"> ▪ Process temperature → 139 ▪ Process pressure (refer to the section on "Pressure-temperature ratings" in the "Technical Information" document) ▪ Ambient temperature range → 20 ▪ Measuring range → 130 	<input type="checkbox"/>
Has the correct orientation for the sensor been selected → 18 ? <ul style="list-style-type: none"> ▪ According to sensor type ▪ According to medium temperature ▪ According to medium properties (outgassing, with entrained solids) 	<input type="checkbox"/>
Does the arrow on the sensor match the direction of flow of the medium through the piping → 18 ?	<input type="checkbox"/>
Are the measuring point identification and labeling correct (visual inspection)?	<input type="checkbox"/>
Is the device adequately protected from precipitation and direct sunlight?	<input type="checkbox"/>
Are the securing screw and securing clamp tightened securely?	<input type="checkbox"/>

7 Electrical connection

i The measuring device does not have an internal circuit breaker. For this reason, assign the measuring device a switch or power-circuit breaker so that the power supply line can be easily disconnected from the mains.

7.1 Connection conditions

7.1.1 Required tools

- For cable entries: Use corresponding tools
- For securing clamp: Allen key 3 mm
- Wire stripper
- When using stranded cables: crimping tool for ferrule
- For removing cables from terminal: flat blade screwdriver ≤ 3 mm (0.12 in)

7.1.2 Connecting cable requirements

The connecting cables provided by the customer must fulfill the following requirements.

Electrical safety

In accordance with applicable federal/national regulations.

Permitted temperature range

- -40 °C (-40 °F) to $+80$ °C ($+176$ °F)
- Minimum requirement: cable temperature range \geq ambient temperature $+20$ K

Signal cable

Current output

- For 4-20 mA: standard installation cable is sufficient.
- For 4-20 mA HART: Shielded cable recommended. Observe grounding concept of the plant.

Pulse/frequency/switch output

Standard installation cable is sufficient.

Current input

Standard installation cable is sufficient.

Cable diameter

- Cable glands supplied:
M20 \times 1.5 with cable ϕ 6 to 12 mm (0.24 to 0.47 in)
- Plug-in spring terminals for device version without integrated overvoltage protection:
wire cross-sections 0.5 to 2.5 mm² (20 to 14 AWG)
- Screw terminals for device version with integrated overvoltage protection: wire cross-sections 0.2 to 2.5 mm² (24 to 14 AWG)

7.1.3 Terminal assignment

Transmitter

4-20 mA HART connection version with additional inputs and outputs

A0020738	A0020739
<p>Maximum number of terminals Terminals 1 to 6: Without integrated overvoltage protection</p>	<p>Maximum number of terminals for order code for "Accessory mounted", option NA "Overvoltage protection"</p> <ul style="list-style-type: none"> ▪ Terminals 1 to 4: With integrated overvoltage protection ▪ Terminals 5 to 6: Without integrated overvoltage protection
<p>1 Output 1 (passive): supply voltage and signal transmission 2 Output 2 (passive): supply voltage and signal transmission 3 Input (passive): supply voltage and signal transmission 4 Ground terminal for cable shield</p>	

Order code for "Output"	Terminal numbers					
	Output 1		Output 2		Input	
	1 (+)	2 (-)	3 (+)	4 (-)	5 (+)	6 (-)
Option A	4-20 mA HART (passive)		-		-	
Option B ¹⁾	4-20 mA HART (passive)		Pulse/frequency/switch output (passive)		-	
Option C ¹⁾	4-20 mA HART (passive)		4-20 mA analog (passive)		-	
Option D ^{1) 2)}	4-20 mA HART (passive)		Pulse/frequency/switch output (passive)		4-20 mA current input (passive)	

- 1) Output 1 must always be used; output 2 is optional.
- 2) The integrated overvoltage protection is not used with option D: Terminals 5 and 6 (current input) are not protected against overvoltage.

7.1.4 Requirements for the supply unit

Supply voltage

Transmitter

An external power supply is required for each output.

The following supply voltage values apply for the outputs available:

Order code for "Output"	Minimum terminal voltage	Maximum terminal voltage
Option A ^{1) 2)} : 4-20 mA HART	<ul style="list-style-type: none"> ▪ For 4 mA: ≥ DC 16 V ▪ For 20 mA: ≥ DC 12 V 	DC 35 V
Option B : 4-20 mA HART, pulse/frequency/switch output	<ul style="list-style-type: none"> ▪ For 4 mA: ≥ DC 16 V ▪ For 20 mA: ≥ DC 12 V 	DC 35 V

Order code for "Output"	Minimum terminal voltage	Maximum terminal voltage
Option C : 4-20 mA HART + 4-20 mA analog	<ul style="list-style-type: none"> ■ For 4 mA: \geq DC 16 V ■ For 20 mA: \geq DC 12 V 	DC 30 V
Option D: 4-20 mA HART, pulse/frequency/switch output, 4-20 mA current input ³⁾	\geq DC 12 V	DC 35 V

- 1) External supply voltage of the power supply unit with load.
- 2) For device versions with SD03 local display: The terminal voltage must be increased by DC 2 V if backlighting is used.
- 3) Voltage drop 2.2 to 3 V for 3.59 to 22 mA

Load

Load for current output: 0 to 500 Ω , depending on the external supply voltage of the power supply unit

Calculation of the maximum load

Depending on the supply voltage of the power supply unit (U_S), the maximum load (R_B) including line resistance must be observed to ensure adequate terminal voltage at the device. In doing so, observe the minimum terminal voltage

- For $U_S = 16.0$ to 16.8 V: $R_B \leq (U_S - 16.0$ V): 0.0036 A
- For $U_S = 16.8$ to 23.0 V: $R_B \leq (U_S - 12.0$ V): 0.022 A
- For $U_S = 23.0$ to 30.0 V: $R_B \leq 500$ Ω

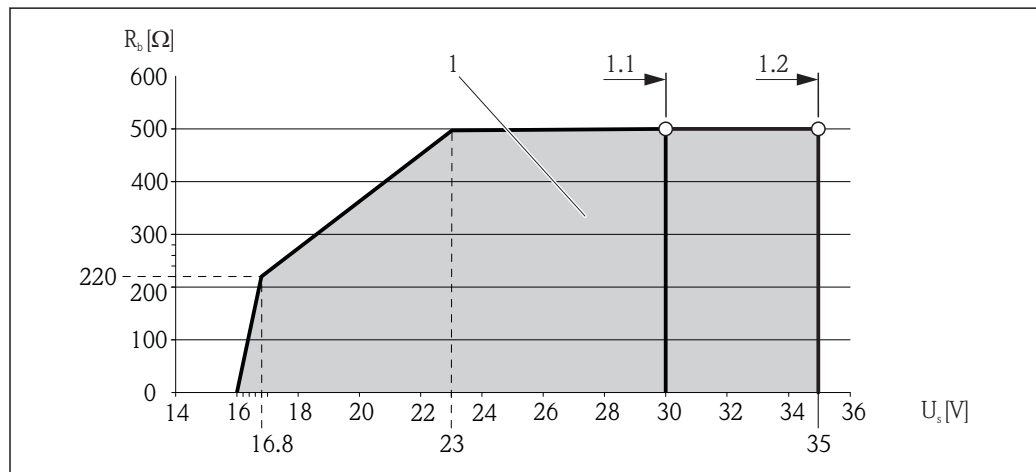

A0018972

- 1 Operating range
- 1.1 For order code for "Output", option A "4-20 mA HART"/option B "4-20 mA HART, pulse/frequency/switch output" with Ex i and option C "4-20 mA HART + 4-20 mA analog"
- 1.2 For order code for "Output", option A "4-20 mA HART"/option B "4-20 mA HART, pulse/frequency/switch output" with non-Ex and Ex d

Sample calculation

Supply voltage of the power supply unit: $U_S = 17.5$ V

Maximum load: $R_B \leq (17.5$ V - 12.0 V): 0.022 A = 250 Ω

7.1.5 Preparing the measuring device

1. Remove dummy plug if present.

2. NOTICE**Insufficient sealing of the housing!**

Operational reliability of the measuring device could be compromised.

- ▶ Use suitable cable glands corresponding to the degree of protection.

If measuring device is delivered without cable glands:

Provide suitable cable gland for corresponding connecting cable .

3. If measuring device is delivered with cable glands:

Observe cable specification .

7.2 Connecting the measuring device

NOTICE**Limitation of electrical safety due to incorrect connection!**

- ▶ Have electrical connection work carried out by correspondingly trained specialists only.
- ▶ Observe applicable federal/national installation codes and regulations.
- ▶ Comply with local workplace safety regulations.
- ▶ For use in potentially explosive atmospheres, observe the information in the device-specific Ex documentation.

7.2.1 Connecting the transmitter

Connection via terminals

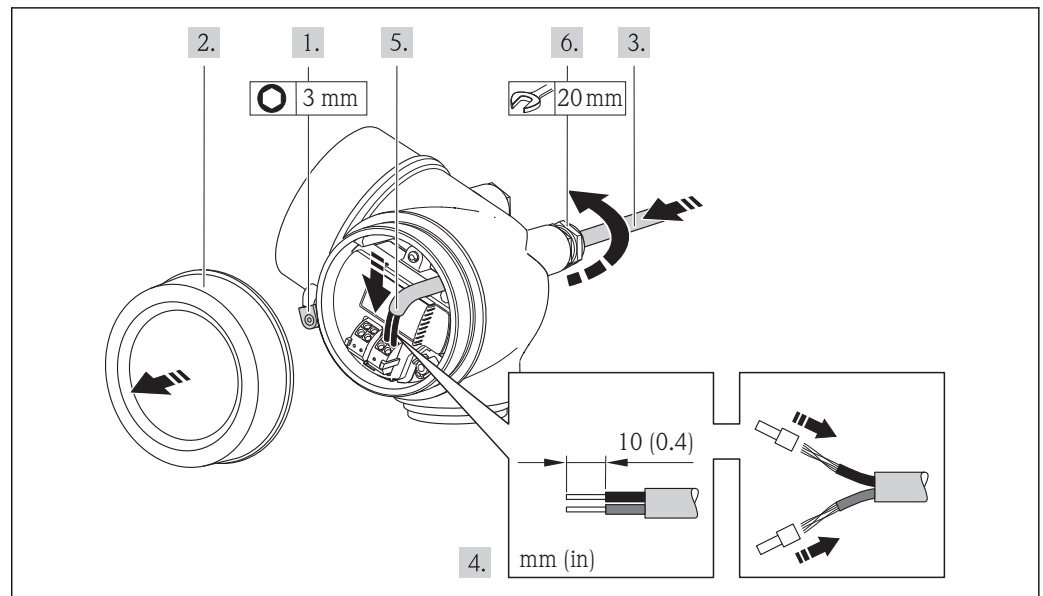

A0013836

1. Loosen the securing clamp of the connection compartment cover.
2. Unscrew the connection compartment cover.
3. Push the cable through the cable entry . To ensure tight sealing, do not remove the sealing ring from the cable entry.
4. Strip the cable and cable ends. In the case of stranded cables, also fit ferrules.
5. Connect the cable in accordance with the terminal assignment . For HART communication: when connecting the cable shielding to the ground terminal, observe the grounding concept of the facility.
6. Firmly tighten the cable glands.

7. **⚠ WARNING**

Housing degree of protection may be voided due to insufficient sealing of the housing.

- ▶ Screw in the screw without using any lubricant. The threads on the cover are coated with a dry lubricant.

Reverse the removal procedure to reassemble the transmitter.

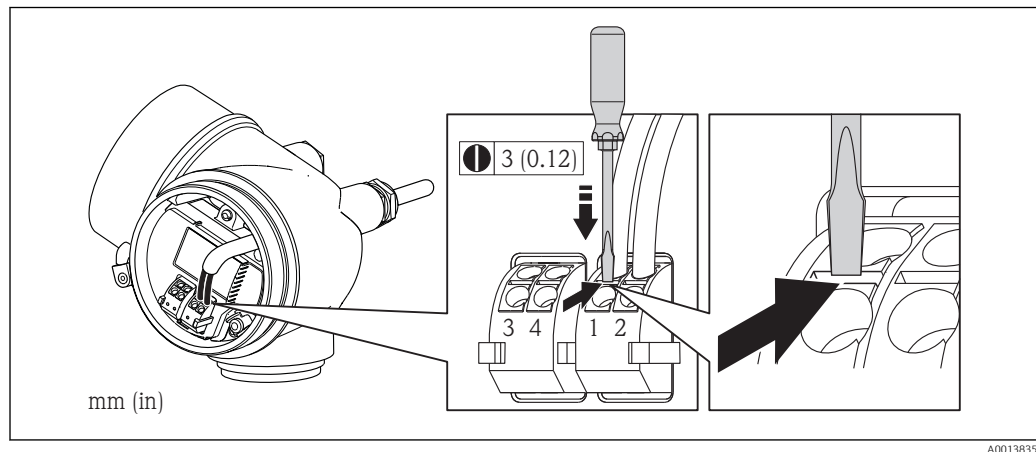
Removing a cable

- ▶ To remove a cable from the terminal, use a flat-blade screwdriver to push the slot between the two terminal holes while simultaneously pulling the cable end out of the terminal.

7.2.2 Ensuring potential equalization**Requirements**

No special measures for potential equalization are required.

- 📖 For devices intended for use in hazardous locations, please observe the guidelines in the Ex documentation (XA).

7.3 Special connection instructions

7.3.1 Connection examples

Current output 4-20 mA HART

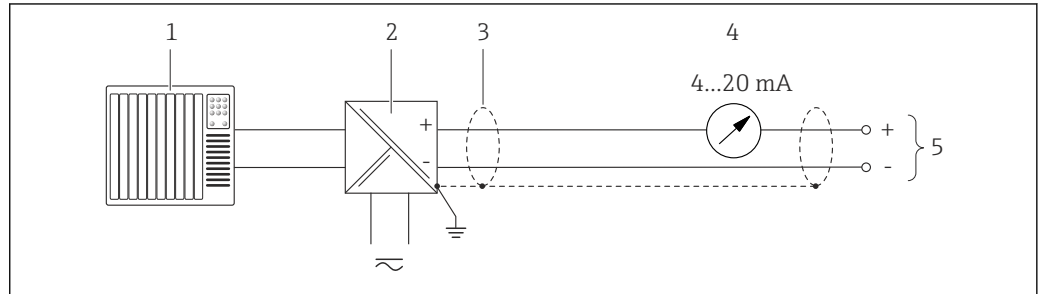

A0015511

6 Connection example for 4-20 mA HART current output (passive)

- 1 Automation system with current input (e.g. PLC)
- 2 Active barrier for power supply with integrated resistor for HART communication ($\geq 250 \Omega$) (e.g. RN221N)
Connection for HART operating devices → 145
Observe the maximum load → 26
- 3 Cable shield, observe cable specifications
- 4 Analog display unit: observe maximum load → 26
- 5 Transmitter

Current output 4-20 mA

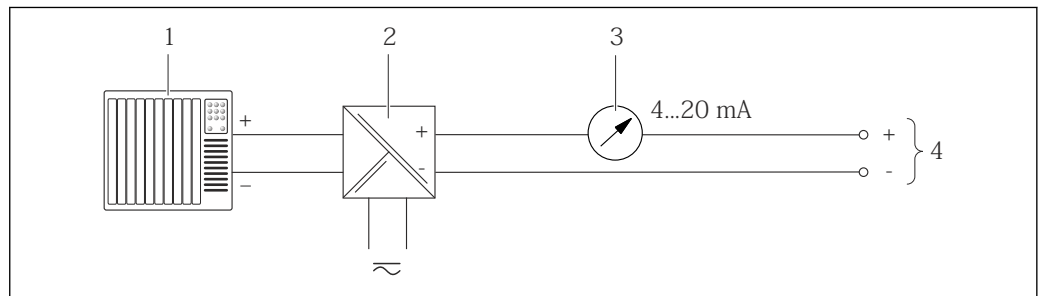

A0015512

7 Connection example for 4-20 mA current output (passive)

- 1 Automation system with current input (e.g. PLC)
- 2 Active barrier for power supply (e.g. RN221N)
- 3 Analog display unit: observe maximum load → 26
- 4 Transmitter

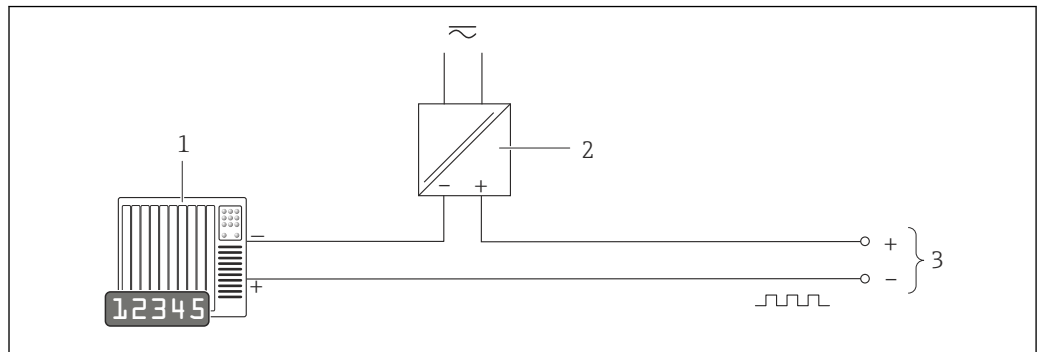
Pulse/frequency output

A0016801

8 Connection example for pulse/frequency output (passive)

- 1 Automation system with pulse/frequency input (e.g. PLC)
- 2 Power supply
- 3 Transmitter: observe input values

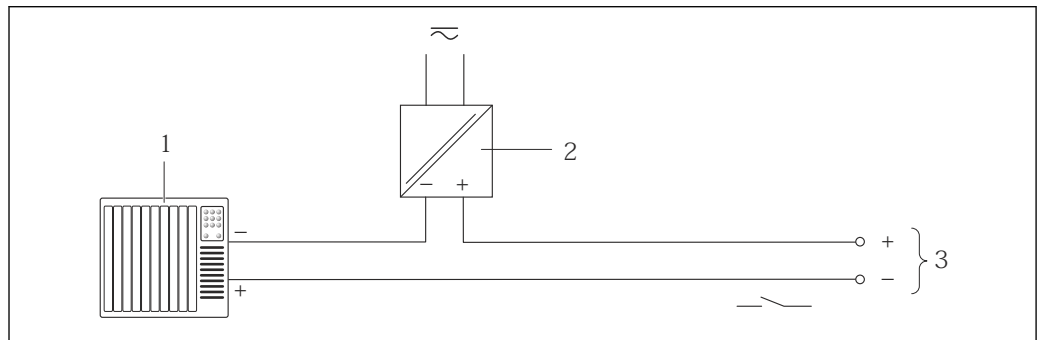
Switch output

A0016802

9 Connection example for switch output (passive)

- 1 Automation system with switch input (e.g. PLC)
- 2 Power supply
- 3 Transmitter: observe input values

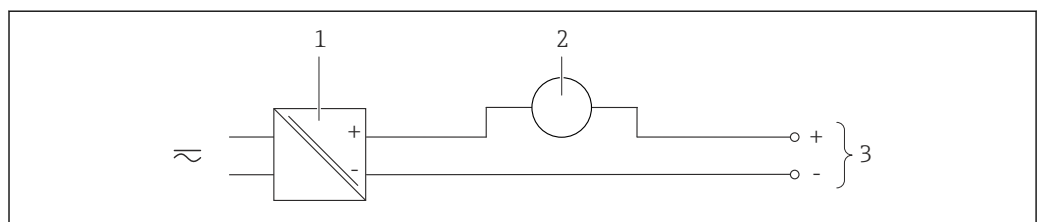
Current input

A0020741

10 Connection example for 4-20 mA current input

- 1 Power supply
- 2 External measuring device (for capturing the pressure)
- 3 Transmitter: observe input values → 131

HART input

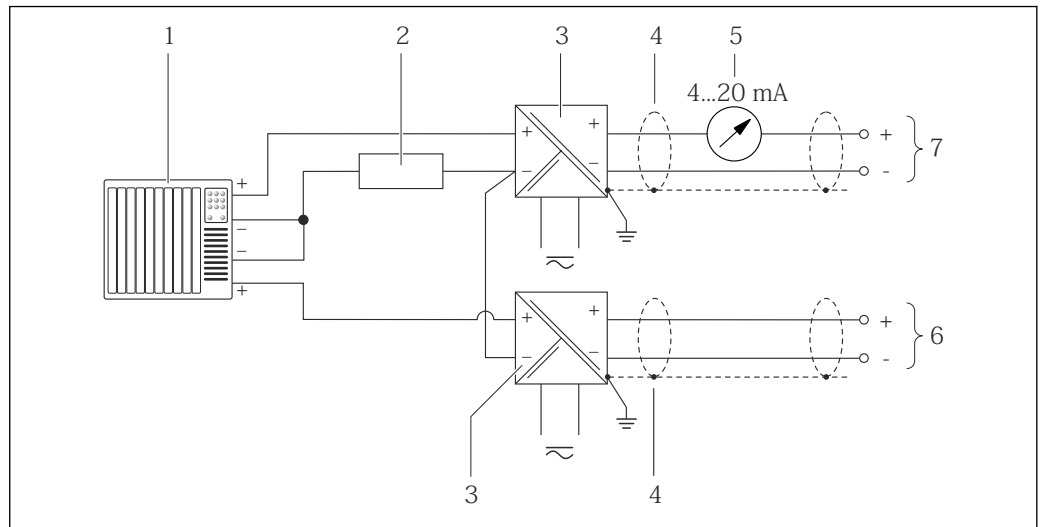

11 Connection example for HART input with a common negative

- 1 Automation system with HART output (e.g. PLC)
- 2 Resistor for HART communication ($\geq 250 \Omega$): observe maximum load → 26
- 3 Active barrier for power supply (e.g. RN221N)
- 4 Cable shield, observe cable specifications
- 5 Analog display unit: observe maximum load → 26
- 6 Pressure transmitter (e.g. Cerabar M, Cerabar S): see requirements
- 7 Transmitter

7.4 Ensuring the degree of protection

The measuring device fulfills all the requirements for the IP66/67 degree of protection, Type 4X enclosure.

To guarantee IP66/67 degree of protection, Type 4X enclosure, carry out the following steps after the electrical connection:

1. Check that the housing seals are clean and fitted correctly. Dry, clean or replace the seals if necessary.
2. Tighten all housing screws and screw covers.
3. Firmly tighten the cable glands.
4. To ensure that moisture does not enter the cable entry, route the cable so that it loops down before the cable entry ("water trap").

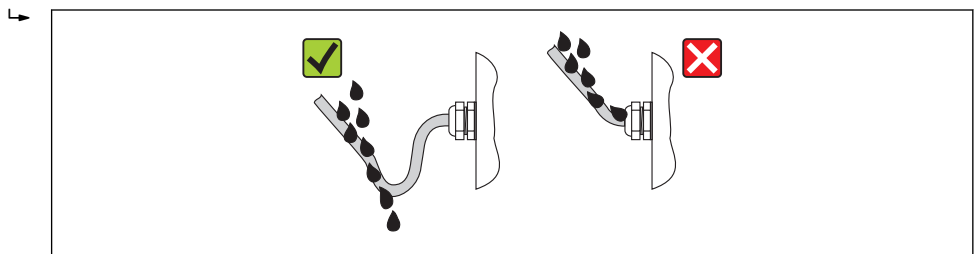

5. Insert dummy plugs into unused cable entries.

7.5 Post-connection check

Are cables or the device undamaged (visual inspection)?	<input type="checkbox"/>
Do the cables comply with the requirements ?	<input type="checkbox"/>
Do the cables have adequate strain relief?	<input type="checkbox"/>
Are all the cable glands installed, firmly tightened and leak-tight? Cable run with "water trap" →  31 ?	<input type="checkbox"/>
Depending on the device version: are all the device plugs firmly tightened ?	<input type="checkbox"/>
Does the supply voltage match the specifications on the transmitter nameplate ?	<input type="checkbox"/>
Is the terminal assignment correct ?	<input type="checkbox"/>
If supply voltage is present, do values appear on the display module?	<input type="checkbox"/>
Are all housing covers installed and firmly tightened?	<input type="checkbox"/>
Is the securing clamp tightened correctly?	<input type="checkbox"/>

8 Operation options

8.1 Overview of operation options

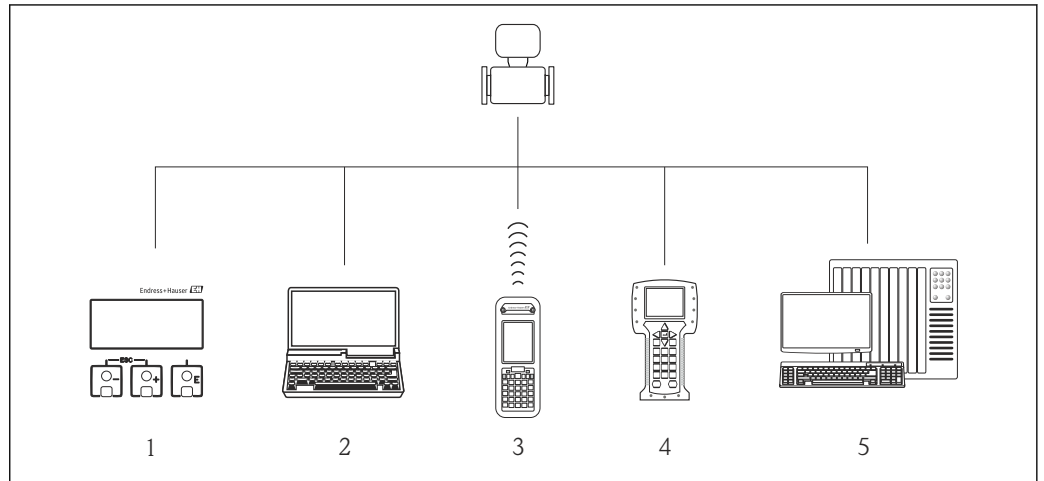

A0015607

- 1 Local operation via display module
- 2 Computer with operating tool (e.g. FieldCare, AMS Device Manager, SIMATIC PDM)
- 3 Field Xpert SFX350 or SFX370
- 4 Field Communicator 475
- 5 Control system (e.g. PLC)

8.2 Structure and function of the operating menu

8.2.1 Structure of the operating menu

i For an overview of the operating menu with menus and parameters

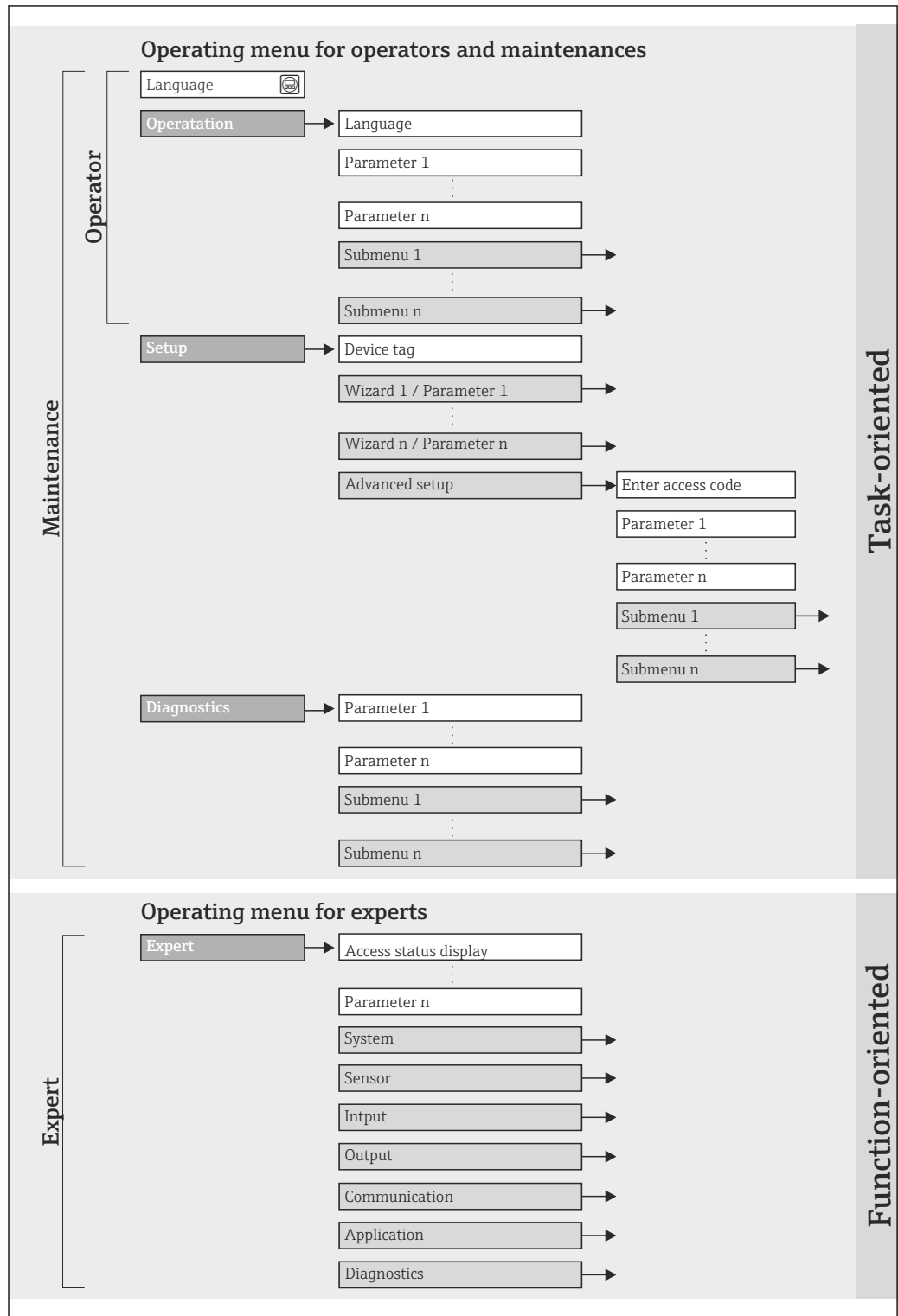

12 Schematic structure of the operating menu

A0018237-EN

8.2.2 Operating philosophy

The individual parts of the operating menu are assigned to certain user roles (operator, maintenance etc.). Each user role contains typical tasks within the device lifecycle.

Menu/parameter		User role and tasks	Content/meaning
Language	task-oriented	Role "Operator", "Maintenance" Tasks during operation: <ul style="list-style-type: none"> Configuring the operational display Reading measured values 	Defining the operating language
Operation			<ul style="list-style-type: none"> Configuring the operational display (e.g. display format, display contrast) Resetting and controlling totalizers
Setup		"Maintenance" role Commissioning: <ul style="list-style-type: none"> Configuration of the measurement Configuration of the inputs and outputs 	Wizards for fast commissioning: <ul style="list-style-type: none"> Defining the medium Configuring the outputs Configuring the operational display Configuring the HART input Defining the output conditioning Configuring the low flow cut off Advanced setup <ul style="list-style-type: none"> For more customized configuration of the measurement (adaptation to special measuring conditions) Configuration of totalizers Administration (define access code, reset measuring device)
Diagnostics		"Maintenance" role Fault elimination: <ul style="list-style-type: none"> Diagnostics and elimination of process and device errors Measured value simulation 	Contains all parameters for error detection and analyzing process and device errors: <ul style="list-style-type: none"> Diagnostics list Contains up to 5 currently pending diagnostic messages. Event logbook Contains up to 20 or 100 (order option "Extended HistoROM") event messages that have occurred. Device information Contains information for identifying the device. Measured values Contains all current measured values. Data logging (Order option "Extended HistoROM") Storage and visualization of up to 1000 measured values Heartbeat The functionality of the device is checked on demand and the verification results are documented. Simulation Is used to simulate measured values or output values.
Expert	function-oriented	Tasks that require detailed knowledge of the function of the device: <ul style="list-style-type: none"> Commissioning measurements under difficult conditions Optimal adaptation of the measurement to difficult conditions Detailed configuration of the communication interface Error diagnostics in difficult cases 	Contains all the parameters of the device and makes it possible to access these parameters directly using an access code. The structure of this menu is based on the function blocks of the device: <ul style="list-style-type: none"> System Contains all higher-order device parameters that do not pertain either to measurement or the measured value communication. Sensor Configuration of the measurement. Input Configuration of the input. Output Configuration of the outputs. Communication Configuration of the digital communication interface. Application Configuration of the functions that go beyond the actual measurement (e.g. totalizer). Diagnostics Error detection and analysis of process and device errors and for device simulation and Heartbeat Technology.

8.3 Access to the operating menu via the local display

8.3.1 Operational display

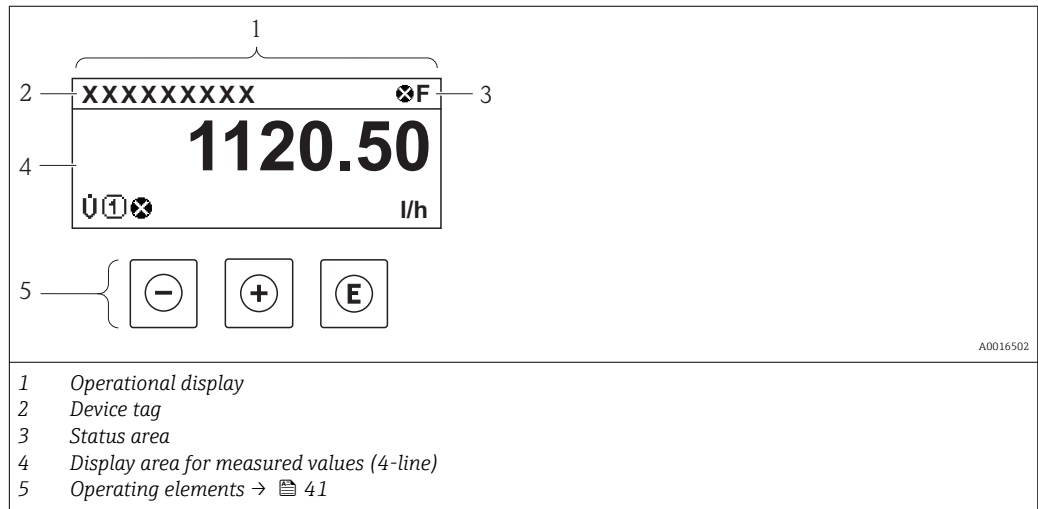

Status area

The following symbols appear in the status area of the operational display at the top right:

- Status signals → 107
 - **F**: Failure
 - **C**: Function check
 - **S**: Out of specification
 - **M**: Maintenance required
- Diagnostic behavior → 108
 - : Alarm
 - : Warning
- : Locking (the device is locked via the hardware)
- : Communication (communication via remote operation is active)

Display area

In the display area, each measured value is prefaced by certain symbol types for further description:

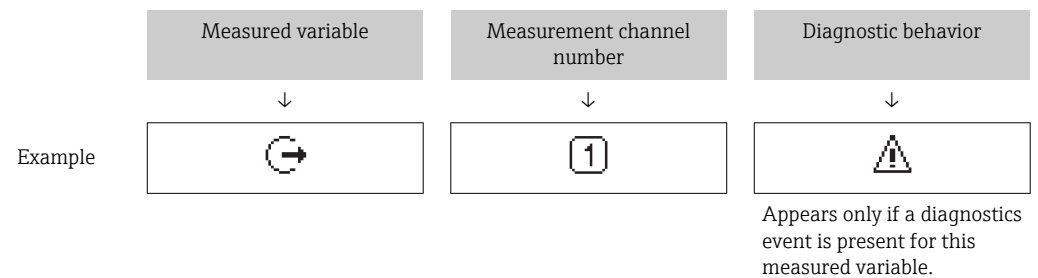

Measured variables

Symbol	Meaning
U	<ul style="list-style-type: none"> ▪ Volume flow ▪ Corrected volume flow
P	Energy flow

	Methane fraction
	Mass flow
	Calorific value
	Wobbe index
	Temperature
	Totalizer The measurement channel number indicates which of the three totalizers is displayed.
	Output The measurement channel number indicates which of the two current outputs is displayed.

Measurement channel numbers

Symbol	Meaning
	Measurement channel 1 to 4

The measurement channel number is displayed only if more than one channel is present for the same measured variable type (e.g. totalizer 1-3).

Diagnostic behavior

The diagnostic behavior pertains to a diagnostic event that is relevant to the displayed measured variable. For information on the symbols → 108



The number and display format of the measured values can be configured via the **"Format display" parameter** → 78. "Operation" menu → Display → Format display



8.3.2 Navigation view

In the submenu	In the wizard
<p>Diagram of the navigation view submenu. It shows a menu structure with a navigation path (1) at the top, a status area (3) containing 'Access stat. disp' and 'Operator', and a display area (4) with 'Locking status' and 'Display'. Operating elements (5) include minus, plus, and 'E' buttons.</p>	<p>Diagram of the navigation view wizard. It shows a menu structure with a navigation path (1) at the top, a status area (3) containing 'Assign curr.' and 'Volume flow', and a display area (4) with navigation buttons. Operating elements (5) include minus, plus, and 'E' buttons.</p>
<p>1 Navigation view 2 Navigation path to current position 3 Status area 4 Display area for navigation 5 Operating elements → 41</p>	

Navigation path

The navigation path - displayed at the top left in the navigation view - consists of the following elements:



	<ul style="list-style-type: none"> In the submenu: Display symbol for menu In the wizard: Display symbol for wizard 	Omission symbol for operating menu levels in between	Name of current <ul style="list-style-type: none"> Submenu Wizard Parameter
Examples	↓	↓	↓
		/ .. /	Display
		/ .. /	Display

 For more information about the menu icons, refer to the "Display area" section →  38

Status area





The following appears in the status area of the navigation view in the top right corner:

- Of the submenu
 - The direct access code for the parameter you are navigating to (e.g. 0022-1)
 - If a diagnostic event is present, the diagnostic behavior and status signal
- In the wizard
 - If a diagnostic event is present, the diagnostic behavior and status signal





-  For information on the diagnostic behavior and status signal →  107
-  For information on the function and entry of the direct access code →  43

Display area

Menus

Symbol	Meaning
	Operation Appears: <ul style="list-style-type: none"> In the menu next to the "Operation" selection At the left in the navigation path in the "Operation" menu
	Setup Appears: <ul style="list-style-type: none"> In the menu next to the "Setup" selection At the left in the navigation path in the "Setup" menu
	Diagnostics Appears: <ul style="list-style-type: none"> In the menu next to the "Diagnostics" selection At the left in the navigation path in the "Diagnostics" menu
	Expert Appears: <ul style="list-style-type: none"> In the menu next to the "Expert" selection At the left in the navigation path in the "Expert" menu



Submenus, wizards, parameters

Symbol	Meaning
	Submenu
	Wizard
	Parameters within a wizard  No display symbol exists for parameters in submenus.

Locking

Symbol	Meaning
	Parameter locked When displayed in front of a parameter name, indicates that the parameter is locked. <ul style="list-style-type: none"> By a user-specific access code By the hardware write protection switch

Wizard operation

Symbol	Meaning
	Switches to the previous parameter.
	Confirms the parameter value and switches to the next parameter.
	Opens the editing view of the parameter.



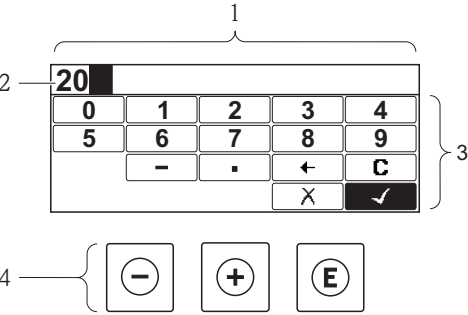
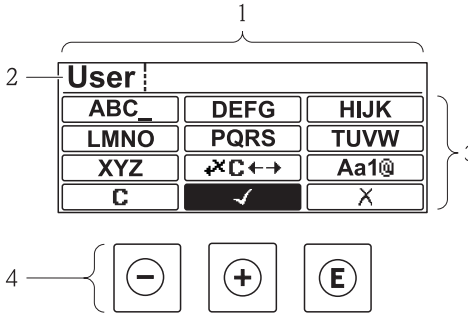

8.3.3 Editing view

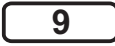

Numeric editor	Text editor
	
<p>1 Editing view 2 Display area of the entered values 3 Input mask 4 Operating elements → 41</p>	

Input mask



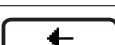







The following input symbols are available in the input mask of the numeric and text editor:

Numeric editor





Symbol	Meaning
	Selection of numbers from 0 to 9.
	
	Inserts decimal separator at the input position.
	Inserts minus sign at the input position.
	Confirms selection.
	Moves the input position one position to the left.

	Exits the input without applying the changes.
	Clears all entered characters.

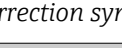





Text editor

Symbol	Meaning
	Toggle <ul style="list-style-type: none"> ▪ Between upper-case and lower-case letters ▪ For entering numbers ▪ For entering special characters
 ... 	Selection of letters from A to Z.
 ... 	Selection of letters from a to z.
 ... 	Selection of special characters.
	Confirms selection.
	Switches to the selection of the correction tools.
	Exits the input without applying the changes.
	Clears all entered characters.

Correction symbols under 

Symbol	Meaning
	Clears all entered characters.
	Moves the input position one position to the right.
	Moves the input position one position to the left.
	Deletes one character immediately to the left of the input position.

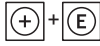
8.3.4 Operating elements

Key	Meaning
	<p>Minus key</p> <p><i>In a menu, submenu</i> Moves the selection bar upwards in a choose list.</p> <p><i>With a Wizard</i> Confirms the parameter value and goes to the previous parameter.</p> <p><i>With a text and numeric editor</i> In the input mask, moves the selection bar to the left (backwards).</p>
	<p>Plus key</p> <p><i>In a menu, submenu</i> Moves the selection bar downwards in a choose list.</p> <p><i>With a Wizard</i> Confirms the parameter value and goes to the next parameter.</p> <p><i>With a text and numeric editor</i> Moves the selection bar to the right (forwards) in an input screen.</p>
	<p>Enter key</p> <p><i>For operational display</i></p> <ul style="list-style-type: none"> ▪ Pressing the key briefly opens the operating menu. ▪ Pressing the key for 2 s opens the context menu. <p><i>In a menu, submenu</i></p> <ul style="list-style-type: none"> ▪ Pressing the key briefly: <ul style="list-style-type: none"> - Opens the selected menu, submenu or parameter. - Starts the wizard. - If help text is open, closes the help text of the parameter. ▪ Pressing the key for 2 s for parameter: <ul style="list-style-type: none"> - If present, opens the help text for the function of the parameter. <p><i>With a Wizard</i> Opens the editing view of the parameter.</p> <p><i>With a text and numeric editor</i></p> <ul style="list-style-type: none"> ▪ Pressing the key briefly: <ul style="list-style-type: none"> - Opens the selected group. - Carries out the selected action. ▪ Pressing the key for 2 s confirms the edited parameter value.
	<p>Escape key combination (press keys simultaneously)</p> <p><i>In a menu, submenu</i></p> <ul style="list-style-type: none"> ▪ Pressing the key briefly: <ul style="list-style-type: none"> - Exits the current menu level and takes you to the next higher level. - If help text is open, closes the help text of the parameter. ▪ Pressing the key for 2 s returns you to the operational display ("home position"). <p><i>With a Wizard</i> Exits the wizard and takes you to the next higher level.</p> <p><i>With a text and numeric editor</i> Closes the text or numeric editor without applying changes.</p>
	<p>Minus/Enter key combination (press the keys simultaneously)</p> <p>Reduces the contrast (brighter setting).</p>
	<p>Plus/Enter key combination (press and hold down the keys simultaneously)</p> <p>Increases the contrast (darker setting).</p>
	<p>Minus/Plus/Enter key combination (press the keys simultaneously)</p> <p><i>For operational display</i> Enables or disables the keypad lock (only SD02 display module).</p>

8.3.5 Opening the context menu

Using the context menu, the user can call up the following menus quickly and directly from the operational display:

- Setup
- Conf. backup disp.
- Simulation

Calling up and closing the context menu

The user is in the operational display.

1. Press \square for 2 s.
 - ↳ The context menu opens.

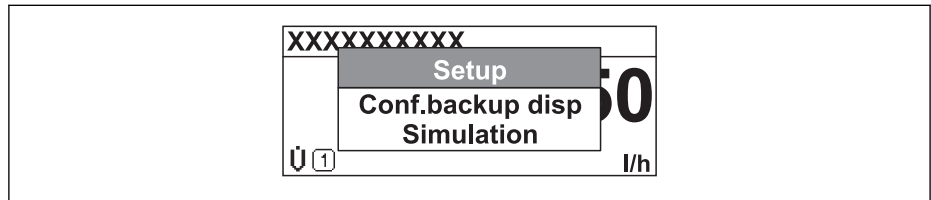

A0016326-EN

2. Press \square + \oplus simultaneously.
 - ↳ The context menu is closed and the operational display appears.

Calling up the menu via the context menu

1. Open the context menu.
2. Press \oplus to navigate to the desired menu.
3. Press \square to confirm the selection.
 - ↳ The selected menu opens.

8.3.6 Navigating and selecting from list

Different operating elements are used to navigate through the operating menu. The navigation path is displayed on the left in the header. Icons are displayed in front of the individual menus. These icons are also shown in the header during navigation.

i For an explanation of the navigation view with symbols and operating elements → 37

Example: Setting the number of displayed measured values to "2 values"

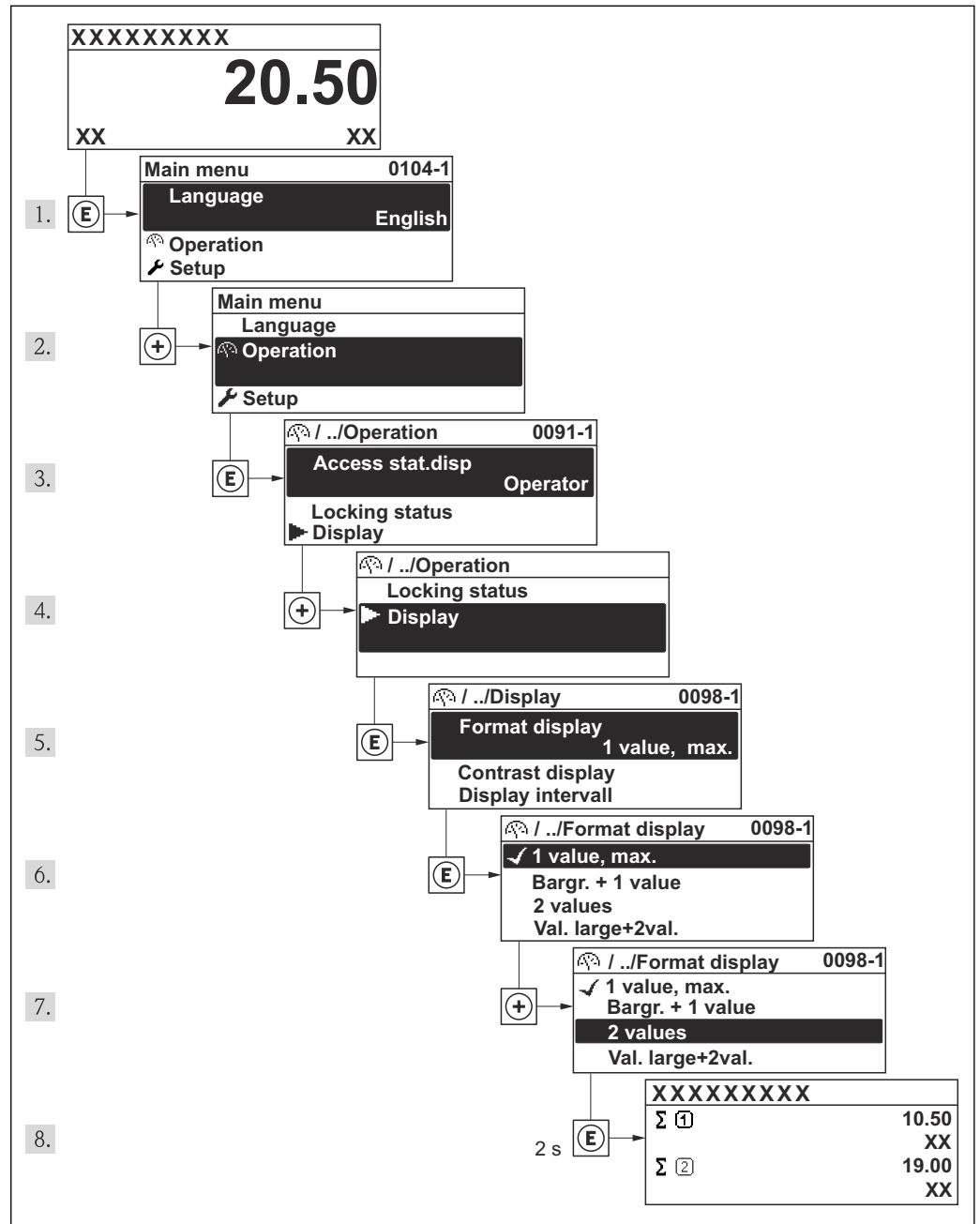

A0014010-EN

8.3.7 Calling the parameter directly

A parameter number is assigned to every parameter to be able to access a parameter directly via the onsite display. Entering this access code in the **Direct access** parameter calls up the desired parameter directly.

Navigation path

"Expert" menu → Direct access

The direct access code consists of a 4-digit number and the channel number, which identifies the channel of a process variable: e.g. 0914-1. In the navigation view, this appears on the right-hand side in the header of the selected parameter.

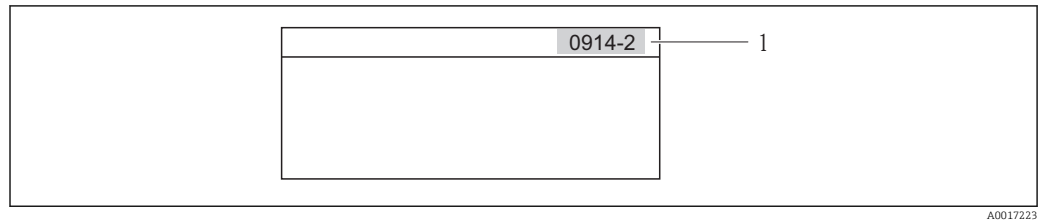

A0017223

1 Direct access code

Note the following when entering the direct access code:

- The leading zeros in the direct access code do not have to be entered.
Example: Input of "914" instead of "0914"
- If no channel number is entered, channel 1 is jumped to automatically.
Example: Input of "0914" → Parameter **Totalizer 1**
- If a different channel is jumped to: Enter the direct access code with the corresponding channel number.
Example: Input of "0914-2" → Parameter **Totalizer 2**

8.3.8 Calling up help text

For some parameters, help texts exist, which the user can call up from the navigation view. These briefly describe the function of the parameter and thus support fast and reliable commissioning.

Calling up and closing the help text

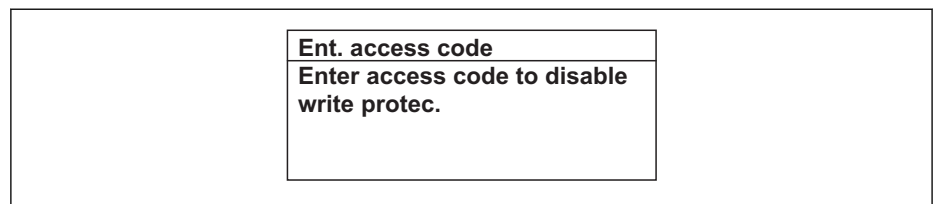

The user is in the navigation view and the selection bar is on a parameter.

1. Press  for 2 s.
 - ↳ The help text for the selected parameter opens.





A0014002-EN

 13 Example: Help text for parameter "Enter access code"

2. Press  +  simultaneously.
 - ↳ The help text is closed.

8.3.9 Changing the parameters

 For a description of the editing display - consisting of text editor and numeric editor - with symbols →  39, for a description of the operating elements →  41

Example: Changing the tag name in the "Tag description" parameter from 001-FT-101 to 001-FT-102

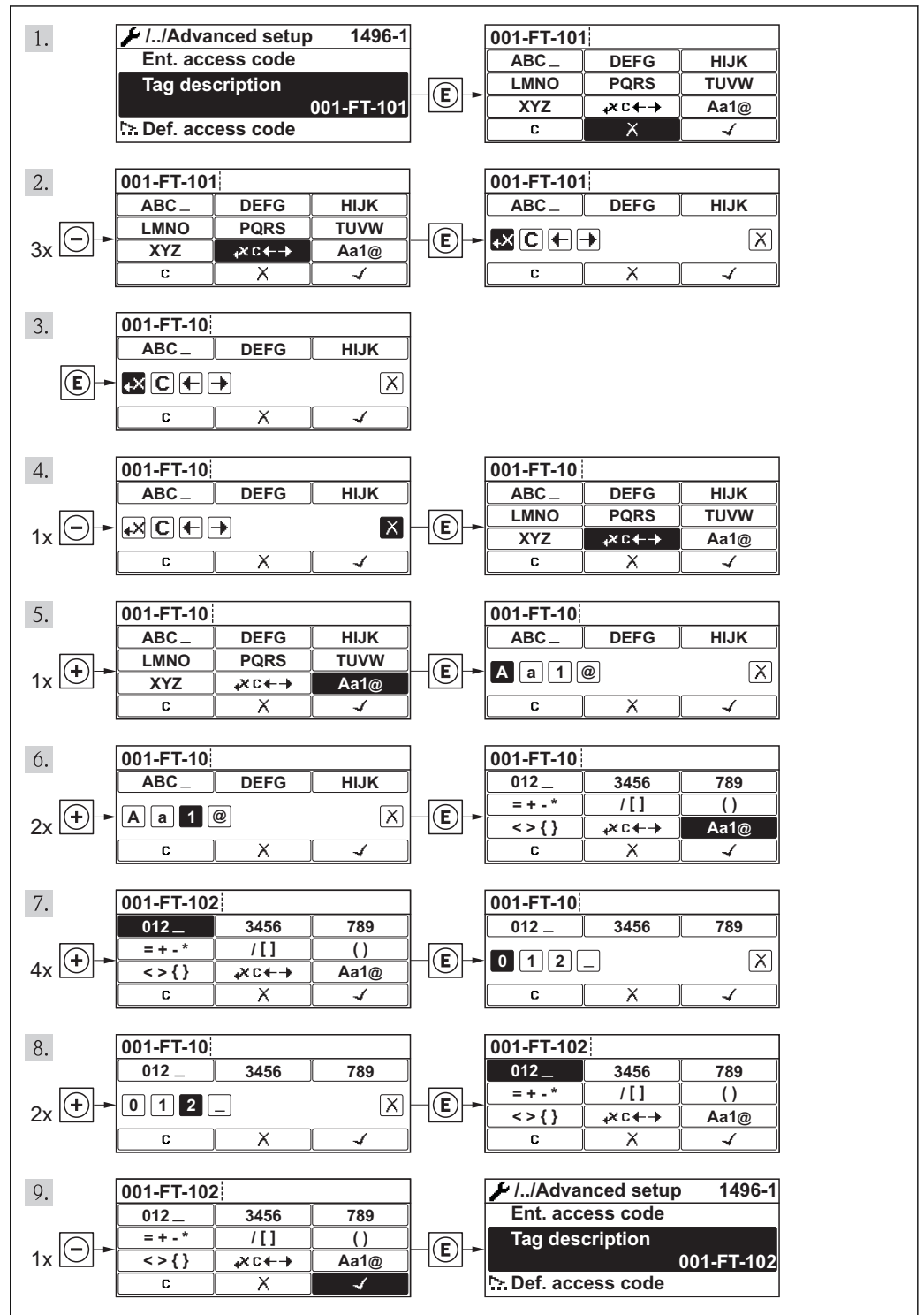

A0014020-EN

A message is displayed if the value entered is outside the permitted value range.

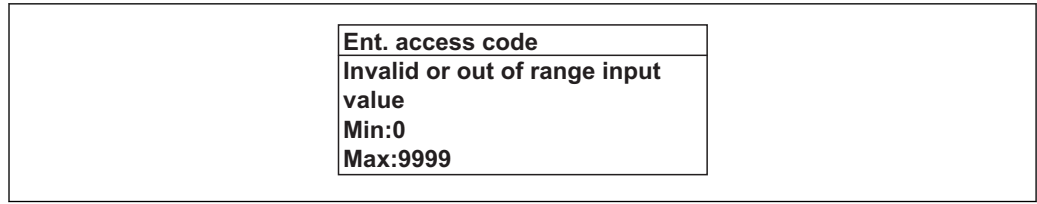

A0014049-EN

8.3.10 User roles and related access authorization

The two user roles "Operator" and "Maintenance" have different write access to the parameters if the customer defines a user-specific access code. This protects the device configuration via the local display from unauthorized access .

Access authorization to parameters

User role	Read access		Write access	
	Without access code (from the factory)	With access code	Without access code (from the factory)	With access code
Operator	✓	✓	✓	-- 1)
Maintenance	✓	✓	✓	✓

- 1) Despite the defined access code, certain parameters can always be modified and thus are excepted from the write protection, as they do not affect the measurement. Refer to the "Write protection via access code" section



If an incorrect access code is entered, the user obtains the access rights of the "Operator" role.

 The user role with which the user is currently logged on is indicated by the **Access status display** parameter. Navigation path: Operation → Access status display

8.3.11 Disabling write protection via access code

If the -symbol appears on the local display in front of a parameter, the parameter is write-protected by a user-specific access code and its value cannot be changed at the moment using the local display .

The locking of the write access via local operation can be disabled by entering the customer-defined access code via the respective access option.

1. After you press , the input prompt for the access code appears.
2. Enter the access code.
 - ↳ The -symbol in front of the parameters disappears; all previously write-protected parameters are now re-enabled.

8.3.12 Enabling and disabling the keypad lock



The keypad lock makes it possible to block access to the entire operating menu via local operation. As a result, it is no longer possible to navigate through the operating menu or change the values of individual parameters. Users can only read the measured values on the operational display.

Local operation with mechanical push buttons (display module SD02)

 Display module SD02: order characteristic "Display; Operation", option C



The keypad lock is switched on and off in the same way:

Switching on the keypad lock

- ▶ The device is in the measured value display.
Press the  +  +  keys simultaneously.
 - ↳ The message **Keylock on** appears on the display: The keypad lock is switched on.

 If the user attempts to access the operating menu while the keypad lock is active, the message **Keylock on** appears.

Switching off the keypad lock

- ▶ The keypad lock is switched on.
Press the  +  +  keys simultaneously.
 - ↳ The message **Keylock off** appears on the display: The keypad lock is switched off.

Local operation with touch control (display module SD03)

 Display module SD03: Order characteristic "Display; Operation", option **E**

The keypad lock is switched on and off via the context menu.

Switching on the keypad lock

The keypad lock is switched on automatically:

- Each time the device is restarted.
- If the device has not been operated for longer than one minute in the measured value display.

1. The device is in the measured value display.
Press the  key for longer than 2 seconds.
 - ↳ A context menu appears.
2. In the context menu, select the **Keylock on** option.
 - ↳ The keypad lock is switched on.

 If the user attempts to access the operating menu while the keypad lock is active, the message **Keylock on** appears.

Switching off the keypad lock

1. The keypad lock is switched on.
Press the  key for longer than 2 seconds.
 - ↳ A context menu appears.
2. In the context menu, select the **Keylock off** option.
 - ↳ The keypad lock is switched off.

8.4 Access to the operating menu via the operating tool

The structure of the operating menu in the operating tools is the same as for operation via the local display.

8.4.1 Connecting the operating tool

Via HART protocol

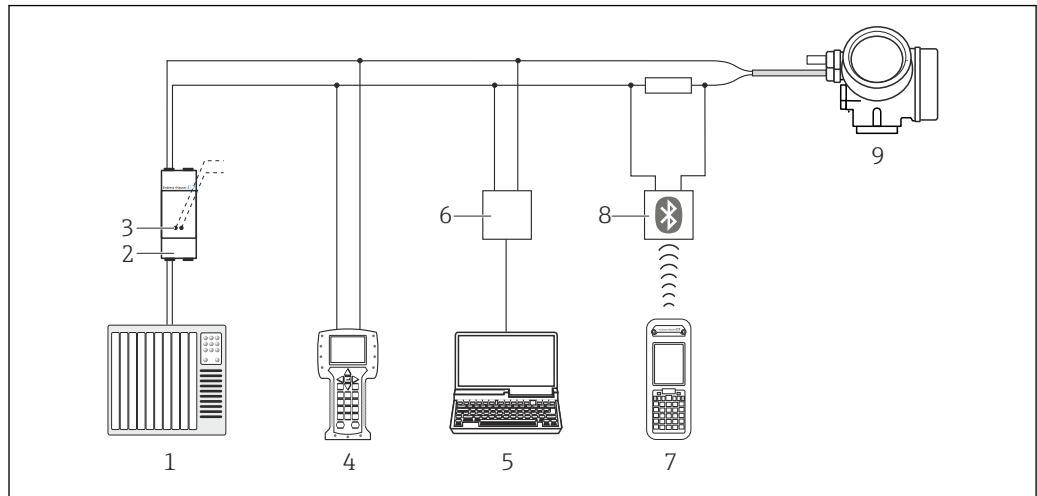

A0013764

14 Options for remote operation via HART protocol

- 1 Control system (e.g. PLC)
- 2 Transmitter power supply unit, e.g. RN221N (with communication resistor)
- 3 Connection for Commubox FXA195 and Field Communicator 475
- 4 Field Communicator 475
- 5 Computer with operating tool (e.g. FieldCare, AMS Device Manager, SIMATIC PDM)
- 6 Commubox FXA195 (USB)
- 7 Field Xpert SFX350 or SFX370
- 8 VIATOR Bluetooth modem with connecting cable
- 9 Transmitter

Via service interface (CDI)

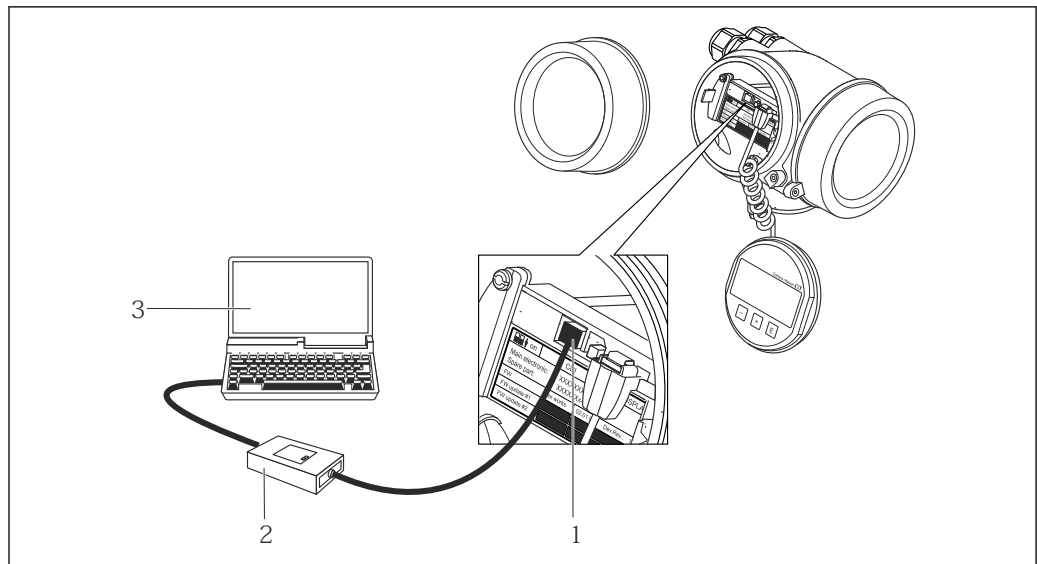

A0014019

- 1 Service interface (CDI = Endress+Hauser Common Data Interface) of the measuring device
- 2 Commubox FXA291
- 3 Computer with "FieldCare" operating tool with COM DTM "CDI Communication FXA291"

8.4.2 Field Xpert SFX350, SFX370

Function scope

Field Xpert SFX350 and Field Xpert SFX370 are mobile computers for commissioning and maintenance. They enable efficient device configuration and diagnostics for HART and FOUNDATION fieldbus devices in the **non-Ex area** (SFX350, SFX370) and the **Ex area** (SFX370).



For details, see Operating Instructions BA01202S

Source for device description files



See data →  52

8.4.3 FieldCare

Function scope

FDT-based plant asset management tool from Endress+Hauser. It can configure all smart field devices in a system and helps you manage them. By using the status information, it is also a simple but effective way of checking their status and condition.

Access takes place via:

- HART protocol →  48
- Service interface CDI →  48

Typical functions:

- Configuring parameters of transmitters
- Loading and saving device data (upload/download)
- Documentation of the measuring point
- Visualization of the measured value memory (line recorder) and event logbook



For details, see Operating Instructions BA00027S and BA00059S

Source for device description files

See data →  52

User interface

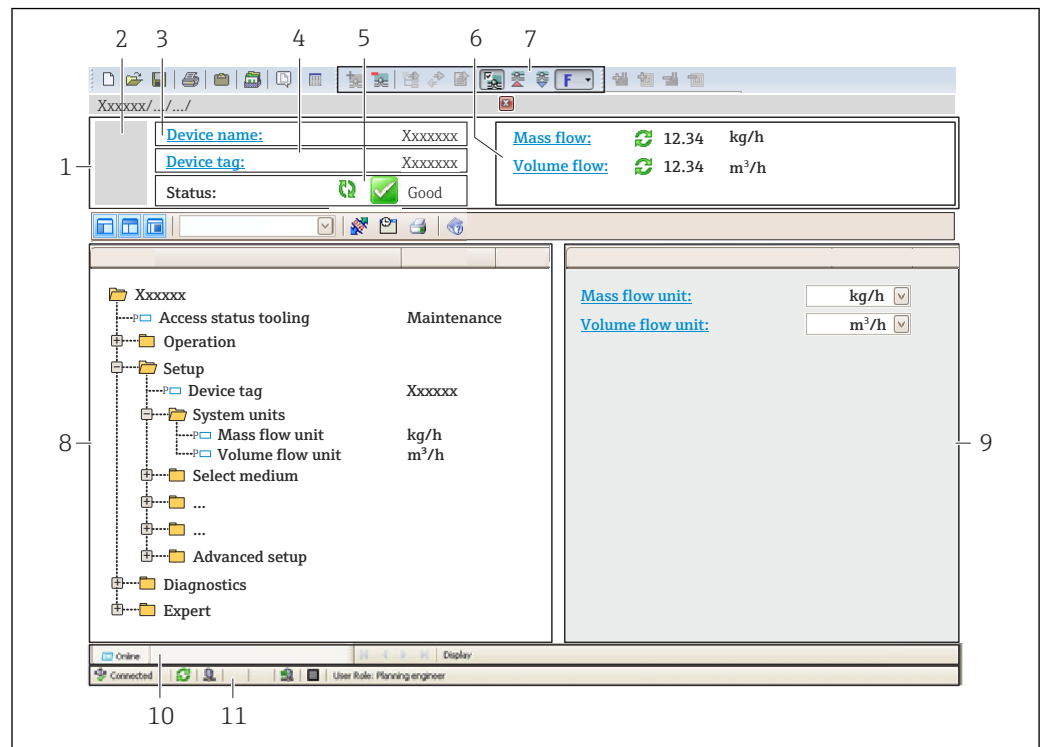

A0021051-EN

- 1 Header
- 2 Picture of device
- 3 Device name
- 4 Device tag
- 5 Status area with status signal
- 6 Display area for current measured values
- 7 Event list with additional functions such as save/load, events list and document creation
- 8 Navigation area with operating menu structure
- 9 Operating range
- 10 Range of action
- 11 Status area

8.4.4 AMS Device Manager

Function scope

Program from Emerson Process Management for operating and configuring measuring devices via HART protocol.

Source for device description files

See data → 52

8.4.5 SIMATIC PDM

Function scope

SIMATIC PDM is a standardized, manufacturer-independent program from Siemens for the operation, configuration, maintenance and diagnosis of intelligent field devices via HART protocol.

Source for device description files

See data → 52

8.4.6 Field Communicator 475

Function scope

Industrial handheld terminal from Emerson Process Management for remote configuration and measured value display via HART protocol.

Source for device description files

See data →  52

9 System integration

9.1 Overview of device description files

9.1.1 Current version data for the device

Firmware version	01.02.zz	<ul style="list-style-type: none"> ▪ On the title page of the Operating instructions ▪ On transmitter nameplate ▪ Firmware version parameter parameter "Diagnostics" menu → Device information → Firmware version
Release date of firmware version	07.2015	---
Manufacturer ID	0x11	Manufacturer ID parameter parameter "Diagnostics" menu → Device information → Manufacturer ID
Device type ID	0x5A	Device type parameter parameter "Diagnostics" menu → Device information → Device type
HART protocol revision	7	---
Device revision	2	<ul style="list-style-type: none"> ▪ On transmitter nameplate ▪ Device revision parameter parameter "Diagnostics" menu → Device information → Device revision

9.1.2 Operating tools

Operating tool via HART protocol	Sources for obtaining device descriptions
<ul style="list-style-type: none"> ▪ Field Xpert SFX350 ▪ Field Xpert SFX370 	Use update function of handheld terminal
FieldCare	<ul style="list-style-type: none"> ▪ www.endress.com → Download Area ▪ CD-ROM (contact Endress+Hauser) ▪ DVD (contact Endress+Hauser)
AMS Device Manager (Emerson Process Management)	www.endress.com → Download Area
SIMATIC PDM (Siemens)	www.endress.com → Download Area
Field Communicator 475 (Emerson Process Management)	Use update function of handheld terminal

9.2 Measured variables via HART protocol

The following measured variables (HART device variables) are assigned to the dynamic variables at the factory:

Dynamic variables	Measured variables (HART device variables)
Primary dynamic variable (PV)	Volume flow
Secondary dynamic variable (SV)	Totalizer 1
Tertiary dynamic variable (TV)	None
Quaternary dynamic variable (QV)	None

The assignment of the measured variables to the dynamic variables can be modified and assigned as desired via local operation and the operating tool using the following parameters:

- Expert → Communication → HART output → Output → Assign PV
- Expert → Communication → HART output → Output → Assign SV
- Expert → Communication → HART output → Output → Assign TV
- Expert → Communication → HART output → Output → Assign QV

The following measured variables can be assigned to the dynamic variables:

Measured variables for PV (primary dynamic variable)

- Volume flow
- Corrected volume flow
- Corrected methane volume flow
- Energy flow
- Mass flow
- Methane fraction
- Gross calorific value
- Wobbe index
- Temperature

Measured variables for SV, TV, QV (secondary, tertiary and quaternary dynamic variable)

- Volume flow
- Corrected volume flow
- Corrected methane volume flow
- Energy flow
- Mass flow
- Methane fraction
- Gross calorific value
- Wobbe index
- Temperature
- Totalizer 1
- Totalizer 2
- Totalizer 3

9.3 Other settings

9.3.1 Burst mode functionality in accordance with HART 7 Specification

Navigation

"Expert" menu → Communication → HART output → Burst configuration → Burst configuration 1 to 3

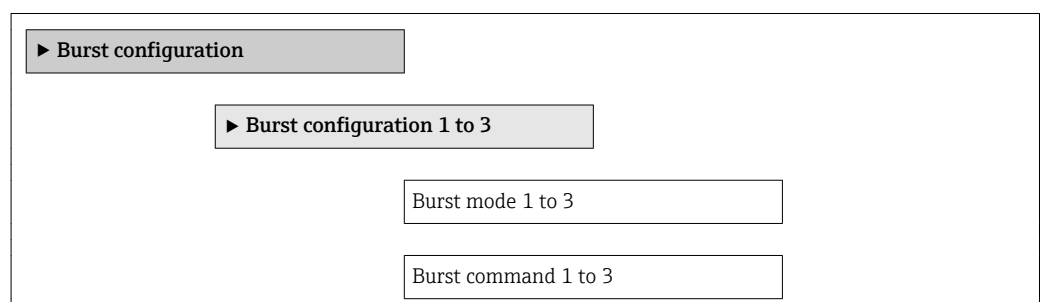

Burst variable 0
Burst variable 1
Burst variable 2
Burst variable 3
Burst variable 4
Burst variable 5
Burst variable 6
Burst variable 7
Burst trigger mode
Burst trigger level
Min. update period
Max. update period

Parameter overview with brief description

Parameter	Description	Selection / User entry	Factory setting
Burst mode 1 to 3	Activate the HART burst mode for burst message X.	<ul style="list-style-type: none"> ▪ Off ▪ On 	Off
Burst command 1 to 3	Select the HART command that is sent to the HART master.	<ul style="list-style-type: none"> ▪ Command 1 ▪ Command 2 ▪ Command 3 ▪ Command 9 ▪ Command 33 ▪ Command 48 	Command 2

Parameter	Description	Selection / User entry	Factory setting
Burst variable 0	For HART command 9 and 33, assign a HART device variable or process variable to burst variable.	<ul style="list-style-type: none"> ■ Volume flow ■ Mass flow ■ Energy flow ■ Methane fraction ■ Calorific value ■ Wobbe index ■ Corrected volume flow ■ Corrected methane volume flow ■ Temperature ■ Totalizer 1 ■ Totalizer 2 ■ Totalizer 3 ■ Pressure ■ Sound velocity ■ Flow velocity ■ Signal asymmetry * ■ Acceptance rate * ■ Turbulence * ■ Signal strength * ■ Signal to noise ratio * ■ Percent Of Range ■ Measured current ■ Primary variable (PV) ■ Secondary variable (SV) ■ Tertiary variable (TV) ■ Quaternary variable (QV) ■ Not used 	Volume flow
Burst variable 1	For HART command 9 and 33, assign a HART device variable or process variable to burst variable.	See Burst variable 0 parameter.	Not used
Burst variable 2	For HART command 9 and 33, assign a HART device variable or process variable to burst variable.	See Burst variable 0 parameter.	Not used
Burst variable 3	For HART command 9 and 33, assign a HART device variable or process variable to burst variable.	See Burst variable 0 parameter.	Not used
Burst variable 4	For HART command 33, assign a HART device variable or process variable to burst variable.	See Burst variable 0 parameter.	Not used
Burst variable 5	For HART command 33, assign a HART device variable or process variable to burst variable.	See Burst variable 0 parameter.	Not used
Burst variable 6	For HART command 33, assign a HART device variable or process variable to burst variable.	See Burst variable 0 parameter.	Not used
Burst variable 7	For HART command 33, assign a HART device variable or process variable to burst variable.	See Burst variable 0 parameter.	Not used
Burst trigger mode	Select the event that triggers burst message X.	<ul style="list-style-type: none"> ■ Continuous ■ Window ■ Rising ■ Falling ■ On change 	Continuous
Burst trigger level	Enter the burst trigger value. Together with the option selected in the Burst trigger mode parameter the burst trigger value determines the time of burst message X.	Positive floating-point number	–

Parameter	Description	Selection / User entry	Factory setting
Min. update period	Enter the minimum time span between two burst responses of one burst message.	Positive integer	1 000 ms
Max. update period	Enter the maximum time span between two burst responses of one burst message.	Positive integer	2 000 ms

* Visibility depends on order options or device settings

10 Commissioning

10.1 Function check

Before commissioning the measuring device:

- ▶ Make sure that the post-installation and post-connection checks have been performed.
- "Post-installation check" checklist → 23
- "Post-connection check" checklist → 32

10.2 Switching on the measuring device

- ▶ After a successful function check, switch on the measuring device.
 - ↳ After a successful startup, the local display switches automatically from the startup display to the operational display.

If nothing appears on the local display or a diagnostic message is displayed, refer to the section on "Diagnostics and troubleshooting" → 105.

10.3 Setting the operating language

Factory setting: English or ordered local language

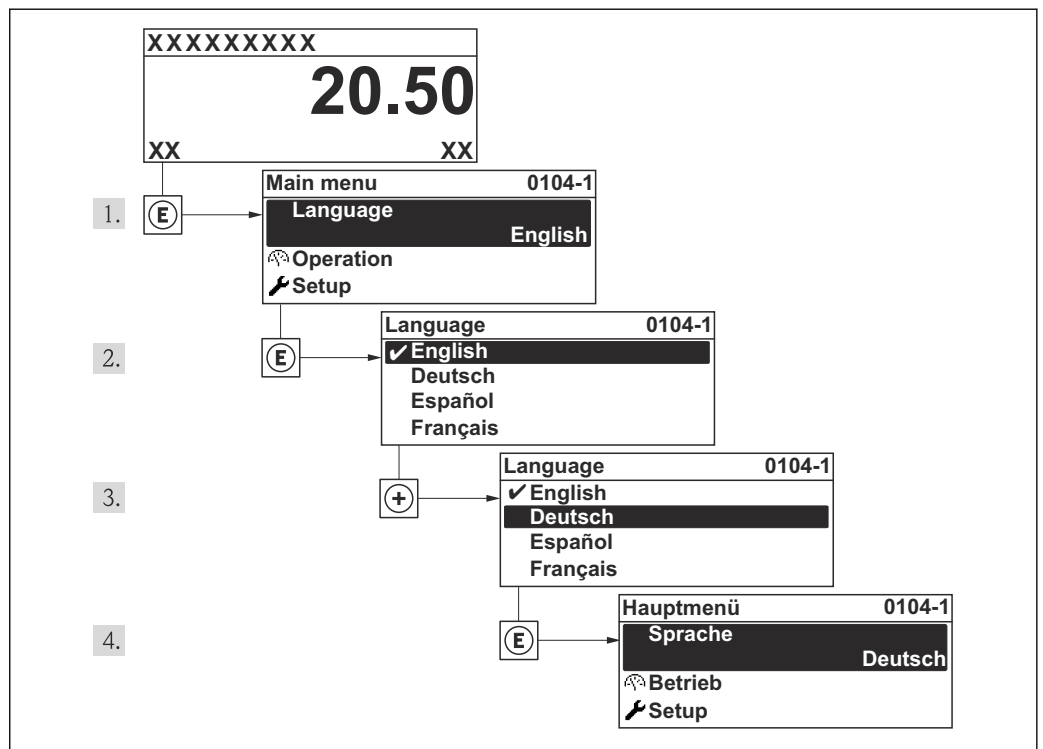

15 Taking the example of the local display

A0013996

10.4 Configuring the measuring device

The **Setup** menu with its guided wizards contains all the parameters needed for standard operation.

Navigation to the **Setup** menu

Overview of the wizards in the "Setup" menu

Setup	
Device tag (0215)	→ 59
▶ System units	→ 59
▶ Medium selection	→ 62
▶ Current input	→ 63
▶ Current output 1 to 2	→ 65
▶ Pulse/frequency/switch output	→ 69
▶ Display	→ 78
▶ Output conditioning	→ 80
▶ Low flow cut off	→ 82
▶ Advanced setup	→ 84

10.4.1 Defining the tag name

To enable fast identification of the measuring point within the system, you can enter a unique designation using the **Device tag** parameter and thus change the factory setting.

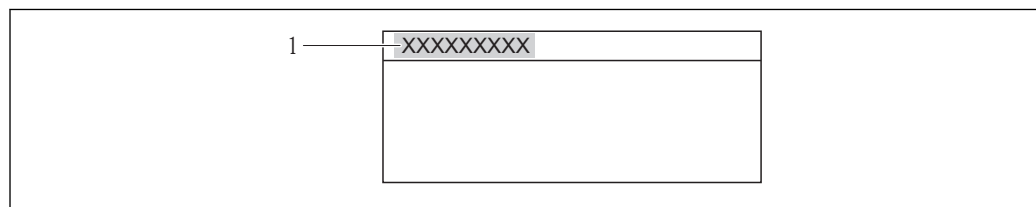

16 Header of the operational display with tag name

1 Device tag

i The number of characters displayed depends on the characters used.

Entry of the tag name in the "FieldCare" operating tool → 50

Navigation

"Setup" menu → Device tag

Parameter overview with brief description

Parameter	Description	User entry	Factory setting
Device tag	Enter the name for the measuring point.	Max. 32 characters such as letters, numbers or special characters (e.g. @, %, /).	Prosonic Flow

10.4.2 Setting the system units

In the **System units** submenu the units of all the measured values can be set.

Navigation

"Setup" menu → Advanced setup → System units

▶ System units

Parameter overview with brief description

Parameter	Prerequisite	Description	Selection	Factory setting
Volume flow unit	–	Select volume flow unit. <i>Result</i> The selected unit applies for: <ul style="list-style-type: none"> ▪ Output ▪ Low flow cut off ▪ Simulation process variable 	Unit choose list	Country-specific: <ul style="list-style-type: none"> ▪ m³/h ▪ ft³/min
Volume unit	–	Select volume unit.	Unit choose list	Country-specific: <ul style="list-style-type: none"> ▪ m³ ▪ ft³
Corrected volume flow unit	–	Select corrected volume flow unit. <i>Result</i> The selected unit applies for: <ul style="list-style-type: none"> ▪ Corrected volume flow ▪ Corrected methane volume flow 	Unit choose list	Country-specific: <ul style="list-style-type: none"> ▪ Nm³/h ▪ Sft³/h
Corrected volume unit	–	Select corrected volume unit.	Unit choose list	Country-specific: <ul style="list-style-type: none"> ▪ Nm³ ▪ Sft³
Mass flow unit	–	Select mass flow unit. <i>Result</i> The selected unit applies for: <ul style="list-style-type: none"> ▪ Output ▪ Low flow cut off ▪ Simulation process variable 	Unit choose list	Country-specific: <ul style="list-style-type: none"> ▪ kg/h ▪ lb/min
Mass unit	–	Select mass unit.	Unit choose list	Country-specific: <ul style="list-style-type: none"> ▪ kg ▪ lb
Temperature unit	–	Select temperature unit. <i>Result</i> The selected unit applies for: <ul style="list-style-type: none"> ▪ Temperature ▪ Maximum value ▪ Minimum value ▪ Average value ▪ Maximum value ▪ Minimum value ▪ Process temperature ▪ Maximum value ▪ Minimum value 	Unit choose list	Country-specific: <ul style="list-style-type: none"> ▪ °C ▪ °F
Pressure unit	–	Select process pressure unit. <i>Result</i> The unit is taken from: <ul style="list-style-type: none"> ▪ Failure value ▪ Measured values ▪ 4 mA value ▪ 20 mA value ▪ Failure value ▪ Maximum value ▪ Atmospheric pressure ▪ Pressure value ▪ Process pressure (5640) 	Unit choose list	Country-specific: <ul style="list-style-type: none"> ▪ mbar a ▪ psi a
Energy flow unit	–	Select energy flow unit. <i>Result</i> The selected unit applies for: <ul style="list-style-type: none"> ▪ Outputs ▪ Low flow cut off 	Unit choose list	Country-specific: <ul style="list-style-type: none"> ▪ kW ▪ Btu/h

Parameter	Prerequisite	Description	Selection	Factory setting
Energy unit	–	Select energy unit.	Unit choose list	Country-specific: <ul style="list-style-type: none"> ▪ kWh ▪ Btu
Calorific value unit	For the following order code: "Sensor version", option 2 "Volume flow + biogas analysis"	Select calorific value unit. <i>Result</i> The selected unit applies for: <ul style="list-style-type: none"> ▪ Calorific value ▪ Wobbe index 	Unit choose list	Country-specific: <ul style="list-style-type: none"> ▪ kWh/Nm³ ▪ Btu/Sft³
Velocity unit	–	Select velocity unit. <i>Result</i> The selected unit applies for: <ul style="list-style-type: none"> ▪ Flow velocity ▪ Sound velocity ▪ Flow velocity ▪ Sound velocity ▪ Maximum value ▪ Minimum value 	Unit choose list	Country-specific: <ul style="list-style-type: none"> ▪ m/s ▪ ft/s

10.4.3 Selecting and setting the medium

The **Medium selection** wizard guides you systematically through all the parameters that have to be configured for selecting and setting the medium.

Navigation

"Setup" menu → Medium selection

Structure of the wizard

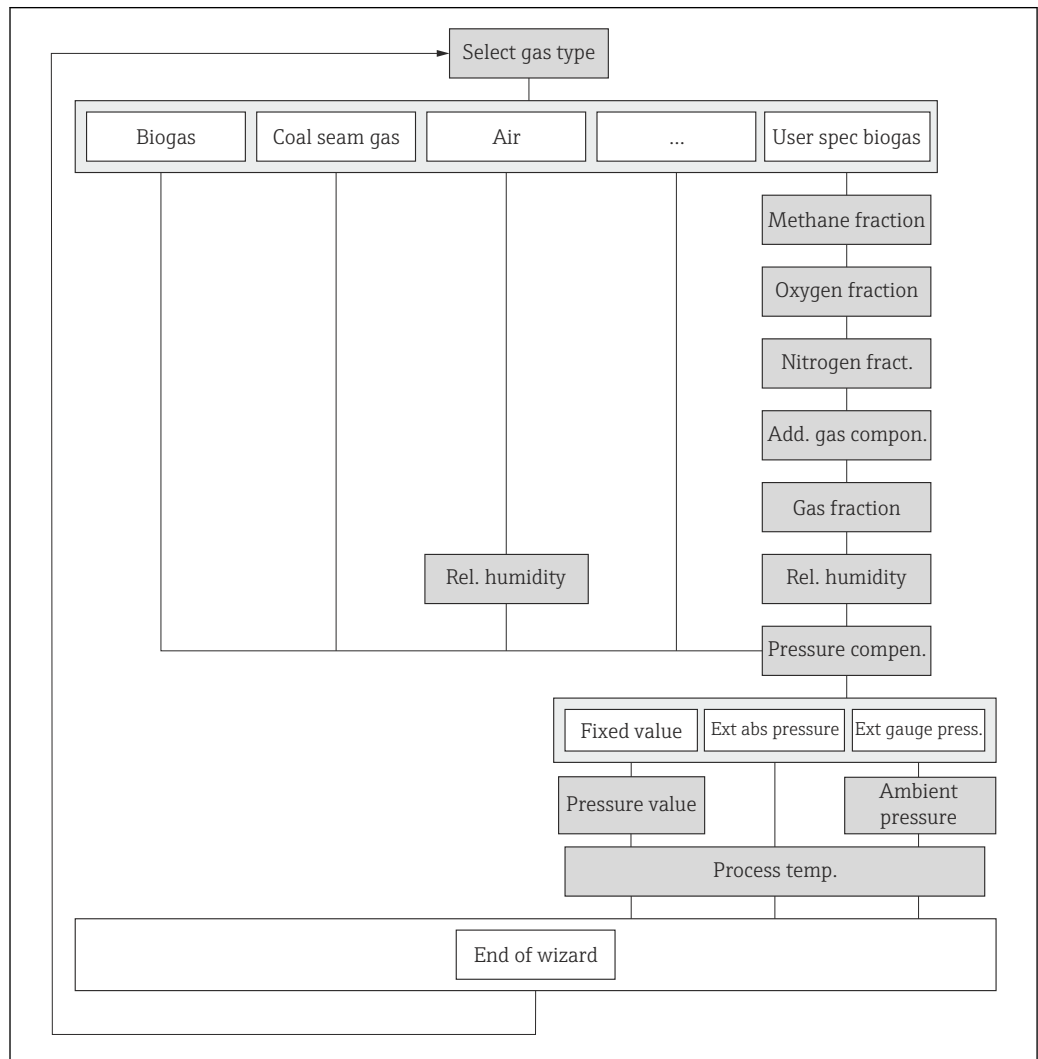

A0015980-EN

17 "Medium selection" wizard in the "Setup" menu

Parameter overview with brief description

Parameter	Prerequisite	Description	Selection / User entry	Factory setting
Select gas type	–	Select measured gas type.	<ul style="list-style-type: none"> ■ Biogas ■ Coal seam gas ■ Air ■ Nitrogen N2 ■ Natural gas ■ User-specific biogas 	Biogas
Methane fraction	The following conditions are met: <ul style="list-style-type: none"> ■ Order code for "Sensor version", option 1 "Volume flow" ■ In the Select gas type parameter, the User-specific biogas option is selected. 	If ordered without biogas analysis feature, enter the methane content of biogas.	Positive floating-point number	55 %
Oxygen fraction	In the Select gas type parameter, the User-specific biogas option is selected.	Enter O2 content of biogas to reduce CH4 analysis uncertainty.	Positive floating-point number	0 %
Nitrogen fraction	In the Select gas type parameter, the User-specific biogas option is selected.	Enter N2 content of biogas to reduce CH4 analysis uncertainty.	Positive floating-point number	0 %
Additional gas component	In the Select gas type parameter, the User-specific biogas option is selected.	Select additional gas component of biogas to reduce CH4 analysis uncertainty.	<ul style="list-style-type: none"> ■ None ■ Hydrogen H2 ■ Ammonia NH3 ■ Hydrogen sulfide H2S 	None
Relative humidity	In the Select gas type parameter, the User-specific biogas option is selected.	Enter humidity content of biogas in %.	0 to 100 %	100 %
Relative humidity	In the Select gas type parameter, the Air option is selected.	Enter humidity content of air in %.	0 to 100 %	50 %
Pressure compensation	–	Select pressure compensation type.	<ul style="list-style-type: none"> ■ Fixed value ■ External absolute pressure ■ External gauge pressure 	Fixed value
Absolute pressure value	In the Pressure compensation parameter, the Fixed value option is selected.	Enter process pressure to be used for pressure correction.	700 to 11 000 mbar	Country-specific: <ul style="list-style-type: none"> ■ 1 043 mbar a ■ 15.1 psi a
Atmospheric pressure	In the Pressure compensation parameter, the External gauge pressure option is selected.	Enter atmospheric pressure value to be used for pressure correction. <i>Dependency</i>  The unit is taken from the Pressure unit parameter	700 to 1 100 mbar	Country-specific: <ul style="list-style-type: none"> ■ 1 013.25 mbar a ■ 14.696 psi a
Process temperature	For the following order code: "Sensor version", option 1 "Volume flow"	Enter a fixed temperature value for corrected volume flow calculation.	0 to 80 °C	Country-specific: <ul style="list-style-type: none"> ■ 50 °C ■ 122 °F

10.4.4 Configuring the current input

The "**Current input**" submenu guides you systematically through all the parameters that have to be set for configuring the current input.

Navigation

"Setup" menu → Current input

▶ Current input

Parameter overview with brief description

Parameter	Prerequisite	Description	Selection / User entry	Factory setting
Current span	–	Select current range for process value output and upper/lower level for alarm signal.	<ul style="list-style-type: none"> ▪ 4...20 mA ▪ 4...20 mA NAMUR ▪ 4...20 mA US 	Country-specific: <ul style="list-style-type: none"> ▪ 4...20 mA NAMUR ▪ 4...20 mA US
4 mA value	–	Enter 4 mA value.	Positive floating-point number	700 mbar
20 mA value	–	Enter 20 mA value.	Positive floating-point number	Depends on country and nominal diameter
Failure mode	–	Define input behavior in alarm condition.	<ul style="list-style-type: none"> ▪ Alarm ▪ Last valid value ▪ Defined value 	Alarm
Failure value	In the Failure mode parameter, the Defined value option is selected.	Enter value to be used by the device if input value from external device is missing.	Signed floating-point number	0 mbar

10.4.5 Configuring the current output

The "Current output 1 to 2" wizard guides you systematically through all the parameters that have to be set for configuring the specific current output.

Navigation

"Setup" menu → Current output 1 to 2

Structure of the wizard

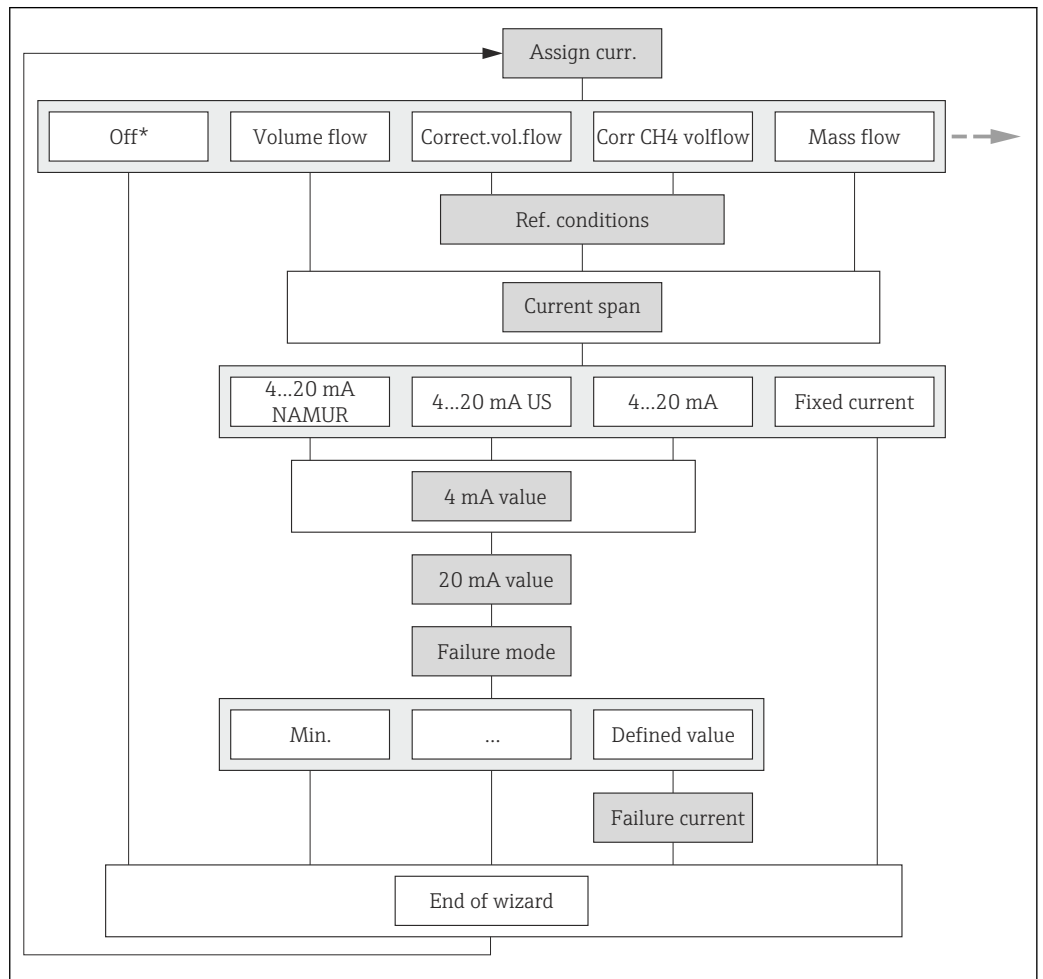

18 "Current output 1 to 2" wizard in the "Setup" menu (part 1)

Off* = Option only for current output 2

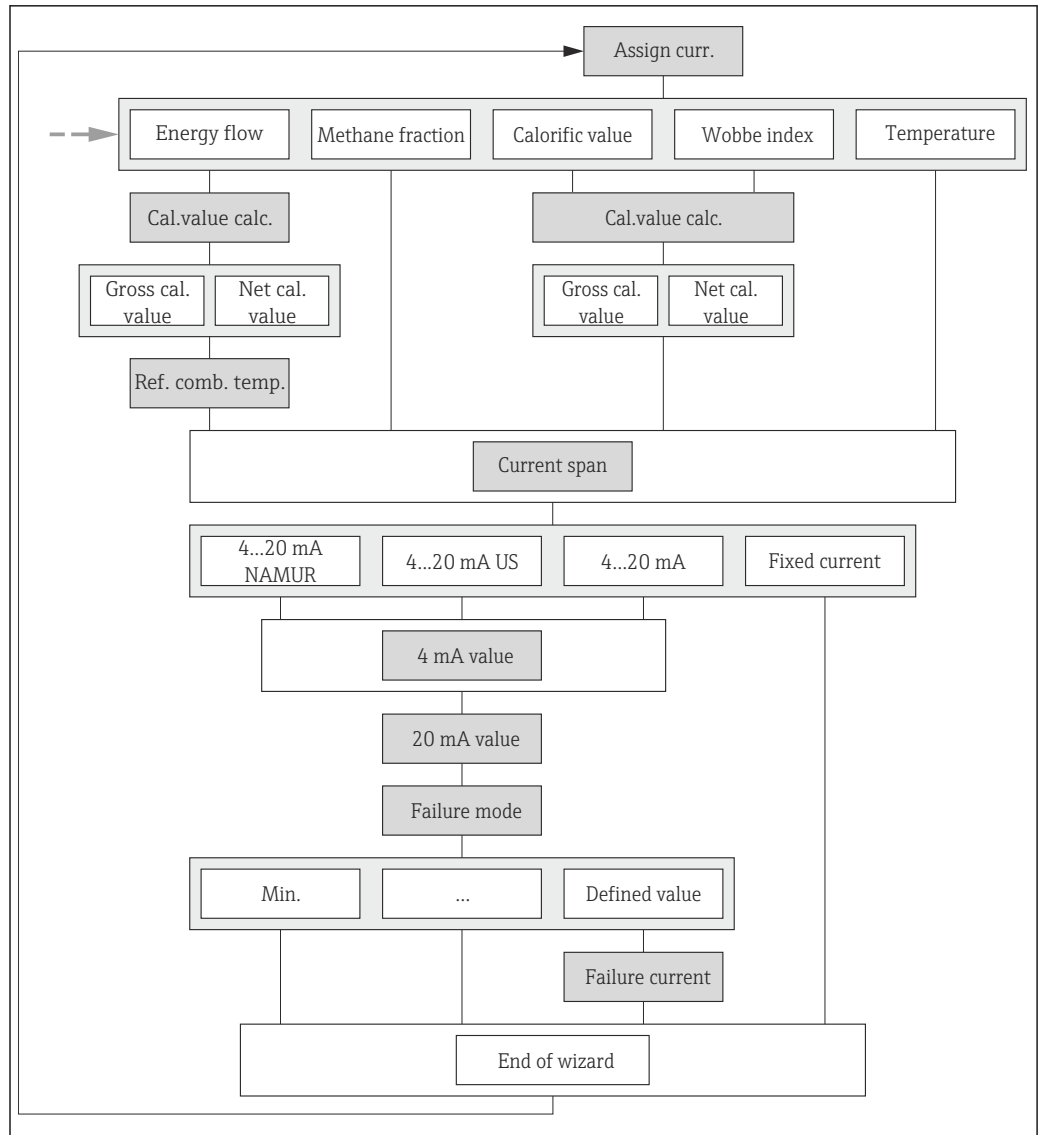

A0015990-EN

19 "Current output 1 to 2" wizard in the "Setup" menu (part 2)

Parameter overview with brief description

Parameter	Prerequisite	Description	Selection / User entry	Factory setting
Assign current output	–	Select process variable for current output.	<ul style="list-style-type: none"> ■ Off ■ Mass flow ■ Volume flow ■ Corrected volume flow ■ Corrected methane volume flow[*] ■ Temperature[*] ■ Energy flow[*] ■ Methane fraction[*] ■ Calorific value[*] ■ Wobbe index[*] ■ Sound velocity ■ Flow velocity ■ Acceptance rate ■ Signal asymmetry ■ Turbulence ■ Signal strength ■ Signal to noise ratio 	Volume flow
Current span	–	Select current range for process value output and upper/lower level for alarm signal.	<ul style="list-style-type: none"> ■ 4...20 mA NAMUR ■ 4...20 mA US ■ 4...20 mA ■ Fixed current 	Country-specific: <ul style="list-style-type: none"> ■ 4...20 mA NAMUR ■ 4...20 mA US
4 mA value	One of the following options is selected in the Current span parameter (→ 67): <ul style="list-style-type: none"> ■ 4...20 mA NAMUR ■ 4...20 mA US ■ 4...20 mA 	Enter 4 mA value.	Signed floating-point number	Country-specific: <ul style="list-style-type: none"> ■ 0 m³/h ■ 0 ft³/min
20 mA value	One of the following options is selected in the Current span parameter (→ 67): <ul style="list-style-type: none"> ■ 4...20 mA NAMUR ■ 4...20 mA US ■ 4...20 mA 	Enter 20 mA value.	Signed floating-point number	Depends on country and nominal diameter
Fixed current	The Fixed current option is selected in the Current span parameter (→ 67).		3.59 to 22.5 mA	4 mA

Parameter	Prerequisite	Description	Selection / User entry	Factory setting
Failure mode	<p>One of the following options is selected in the Assign current output parameter (→ 67):</p> <ul style="list-style-type: none"> ▪ Mass flow ▪ Volume flow ▪ Corrected volume flow ▪ Corrected methane volume flow * ▪ Temperature ▪ Energy flow * ▪ Methane fraction * ▪ Calorific value * ▪ Wobbe index * ▪ Sound velocity ▪ Flow velocity ▪ Acceptance rate * ▪ Signal asymmetry * ▪ Turbulence * ▪ Signal strength * ▪ Signal to noise ratio * <p>One of the following options is selected in the Current span parameter (→ 67):</p> <ul style="list-style-type: none"> ▪ 4...20 mA NAMUR ▪ 4...20 mA US ▪ 4...20 mA 	Define output behavior in alarm condition.	<ul style="list-style-type: none"> ▪ Min. ▪ Max. ▪ Last valid value ▪ Actual value ▪ Defined value 	Max.
Failure current	The Defined value option is selected in the Failure mode parameter.	Enter current output value in alarm condition.	3.59 to 22.5 mA	22.5 mA

* Visibility depends on order options or device settings

10.4.6 Configuring the pulse/frequency/switch output

The **Pulse/frequency/switch output** wizard guides you systematically through all the parameters that can be set for configuring the selected output type.

Configuring the pulse output

Navigation

"Setup" menu → Pulse/frequency/switch output

Structure of the wizard for the pulse output

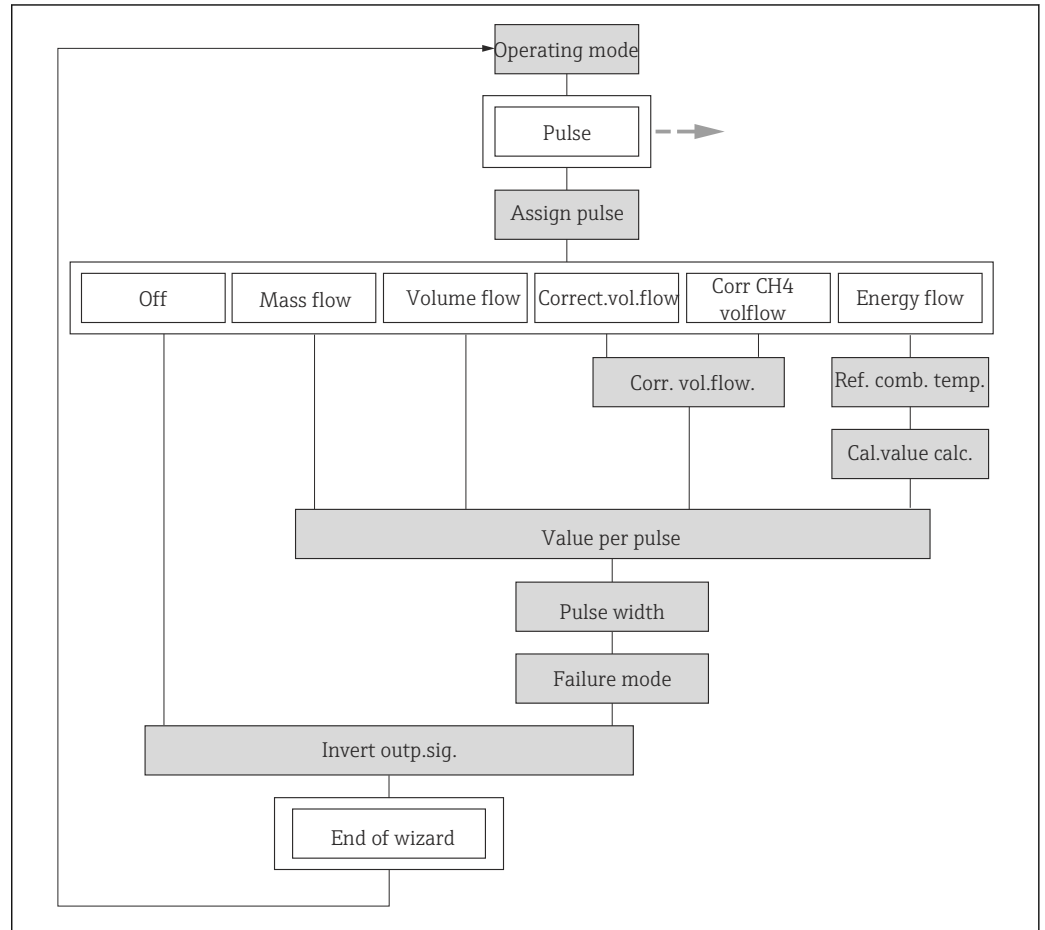

A0019210-EN

20 "Pulse/frequency/switch output" wizard in the "Setup" menu: "Operating mode" parameter "Pulse" option

Parameter overview with brief description

Parameter	Prerequisite	Description	Selection / User entry	Factory setting
Operating mode	–	Define the output as a pulse, frequency or switch output.	<ul style="list-style-type: none"> ■ Pulse ■ Frequency ■ Switch 	Pulse
Assign pulse output	In the Operating mode parameter the Pulse option is selected.	Select process variable for pulse output.	<ul style="list-style-type: none"> ■ Off ■ Volume flow ■ Corrected volume flow ■ Corrected methane volume flow * ■ Mass flow ■ Energy flow * 	Off

Parameter	Prerequisite	Description	Selection / User entry	Factory setting
Value per pulse	One of the following options is selected in the Assign pulse output parameter (→ 69): <ul style="list-style-type: none"> ▪ Volume flow ▪ Corrected volume flow ▪ Corrected methane volume flow[*] ▪ Mass flow ▪ Energy flow[*] 	Enter measured value at which a pulse is output.	Signed floating-point number	Depends on country and nominal diameter
Pulse width	One of the following options is selected in the Assign pulse output parameter (→ 69): <ul style="list-style-type: none"> ▪ Volume flow ▪ Corrected volume flow ▪ Corrected methane volume flow[*] ▪ Mass flow ▪ Energy flow[*] 	Define time width of the output pulse.	5 to 2 000 ms	100 ms
Failure mode	One of the following options is selected in the Assign pulse output parameter (→ 69): <ul style="list-style-type: none"> ▪ Volume flow ▪ Corrected volume flow ▪ Corrected methane volume flow[*] ▪ Mass flow ▪ Energy flow[*] 	Define output behavior in alarm condition.	<ul style="list-style-type: none"> ▪ Actual value ▪ No pulses 	No pulses
Invert output signal	–	Invert the output signal.	<ul style="list-style-type: none"> ▪ No ▪ Yes 	No

* Visibility depends on order options or device settings

Configuring the frequency output

Navigation

"Setup" menu → Pulse/frequency/switch output

Structure of the wizard for the frequency output

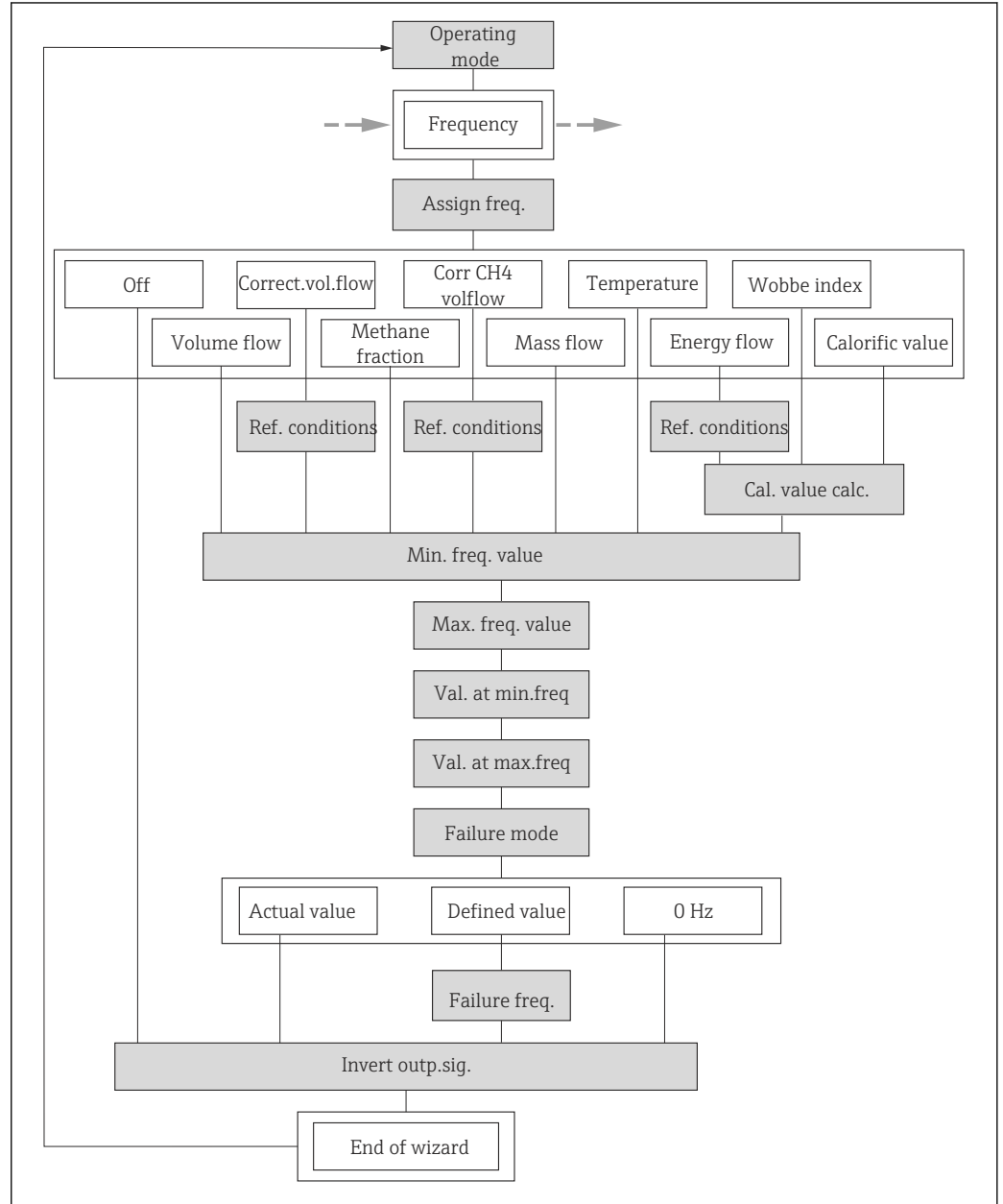

A0019213-EN

21 "Pulse/frequency/switch output" wizard in the "Setup" menu: "Operating mode" parameter "Frequency" option

Parameter overview with brief description

Parameter	Prerequisite	Description	Selection / User entry	Factory setting
Operating mode	–	Define the output as a pulse, frequency or switch output.	<ul style="list-style-type: none"> ■ Pulse ■ Frequency ■ Switch 	Pulse
Assign frequency output	The Frequency option is selected in the Operating mode parameter (→ 69).	Select process variable for frequency output.	<ul style="list-style-type: none"> ■ Off ■ Volume flow ■ Corrected volume flow ■ Corrected methane volume flow[*] ■ Mass flow ■ Energy flow[*] ■ Methane fraction[*] ■ Wobbe index[*] ■ Calorific value[*] ■ Temperature[*] ■ Sound velocity ■ Flow velocity ■ Acceptance rate[*] ■ Signal asymmetry[*] ■ Turbulence[*] ■ Signal strength[*] ■ Signal to noise ratio[*] 	Off
Minimum frequency value	One of the following options is selected in the Assign frequency output parameter (→ 72): <ul style="list-style-type: none"> ■ Volume flow ■ Corrected volume flow ■ Corrected methane volume flow[*] ■ Mass flow ■ Energy flow[*] ■ Methane fraction[*] ■ Wobbe index[*] ■ Calorific value[*] ■ Temperature[*] ■ Sound velocity ■ Flow velocity ■ Acceptance rate[*] ■ Signal asymmetry[*] ■ Turbulence[*] ■ Signal strength[*] ■ Signal to noise ratio[*] 	Enter minimum frequency.	0 to 1000 Hz	0 Hz

Parameter	Prerequisite	Description	Selection / User entry	Factory setting
Maximum frequency value	<p>One of the following options is selected in the Assign frequency output parameter (→ 72):</p> <ul style="list-style-type: none"> ▪ Volume flow ▪ Corrected volume flow ▪ Corrected methane volume flow * ▪ Mass flow ▪ Energy flow * ▪ Methane fraction * ▪ Wobbe index * ▪ Calorific value * ▪ Temperature * ▪ Sound velocity ▪ Flow velocity ▪ Acceptance rate * ▪ Signal asymmetry * ▪ Turbulence * ▪ Signal strength * ▪ Signal to noise ratio * 	Enter maximum frequency.	0 to 1000 Hz	1000 Hz
Measuring value at minimum frequency	<p>One of the following options is selected in the Assign frequency output parameter (→ 72):</p> <ul style="list-style-type: none"> ▪ Volume flow ▪ Corrected volume flow ▪ Corrected methane volume flow * ▪ Mass flow ▪ Energy flow * ▪ Methane fraction * ▪ Wobbe index * ▪ Calorific value * ▪ Temperature * ▪ Sound velocity ▪ Flow velocity ▪ Acceptance rate * ▪ Signal asymmetry * ▪ Turbulence * ▪ Signal strength * ▪ Signal to noise ratio * 	Enter measured value for minimum frequency.	Signed floating-point number	Depends on country and nominal diameter
Measuring value at maximum frequency	<p>One of the following options is selected in the Assign frequency output parameter (→ 72):</p> <ul style="list-style-type: none"> ▪ Volume flow ▪ Corrected volume flow ▪ Corrected methane volume flow * ▪ Mass flow ▪ Energy flow * ▪ Methane fraction * ▪ Wobbe index * ▪ Calorific value * ▪ Temperature * ▪ Sound velocity ▪ Flow velocity ▪ Acceptance rate * ▪ Signal asymmetry * ▪ Turbulence * ▪ Signal strength * ▪ Signal to noise ratio * 	Enter measured value for maximum frequency.	Signed floating-point number	Depends on country and nominal diameter

Parameter	Prerequisite	Description	Selection / User entry	Factory setting
Failure mode	One of the following options is selected in the Assign frequency output parameter (-> 72): <ul style="list-style-type: none"> ▪ Volume flow ▪ Corrected volume flow ▪ Corrected methane volume flow * ▪ Mass flow ▪ Energy flow * ▪ Methane fraction * ▪ Wobbe index * ▪ Calorific value * ▪ Temperature * ▪ Sound velocity ▪ Flow velocity ▪ Acceptance rate * ▪ Signal asymmetry * ▪ Turbulence * ▪ Signal strength * ▪ Signal to noise ratio * 	Define output behavior in alarm condition.	<ul style="list-style-type: none"> ▪ Actual value ▪ Defined value ▪ 0 Hz 	0 Hz
Failure frequency	One of the following options is selected in the Assign frequency output parameter (-> 72): <ul style="list-style-type: none"> ▪ Volume flow ▪ Corrected volume flow ▪ Corrected methane volume flow * ▪ Mass flow ▪ Energy flow * ▪ Methane fraction * ▪ Wobbe index * ▪ Calorific value * ▪ Temperature * ▪ Sound velocity ▪ Flow velocity ▪ Acceptance rate * ▪ Signal asymmetry * ▪ Turbulence * ▪ Signal strength * ▪ Signal to noise ratio * 	Enter frequency output value in alarm condition.	0.0 to 1 250.0 Hz	0.0 Hz
Invert output signal	–	Invert the output signal.	<ul style="list-style-type: none"> ▪ No ▪ Yes 	No

* Visibility depends on order options or device settings

Configuring the switch output

Navigation

"Setup" menu → Pulse/frequency/switch output

Structure of the wizard for the switch output

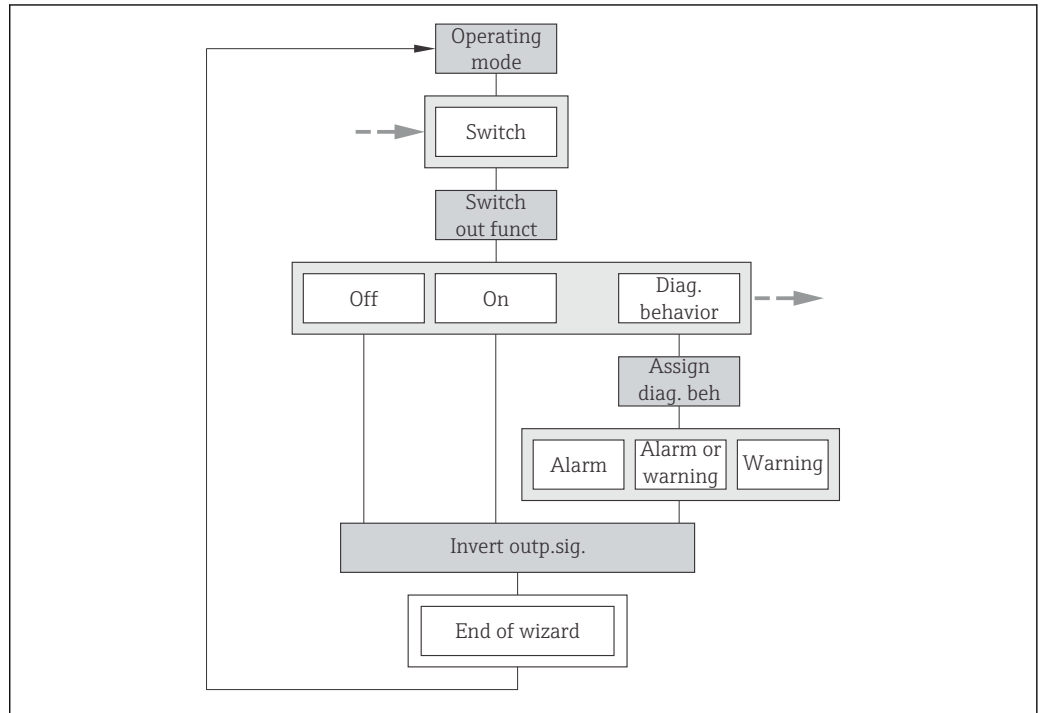

A0018575-EN

22 "Pulse/frequency/switch output" wizard in the "Setup" menu: "Operating mode" parameter "Switch" option (part 1)

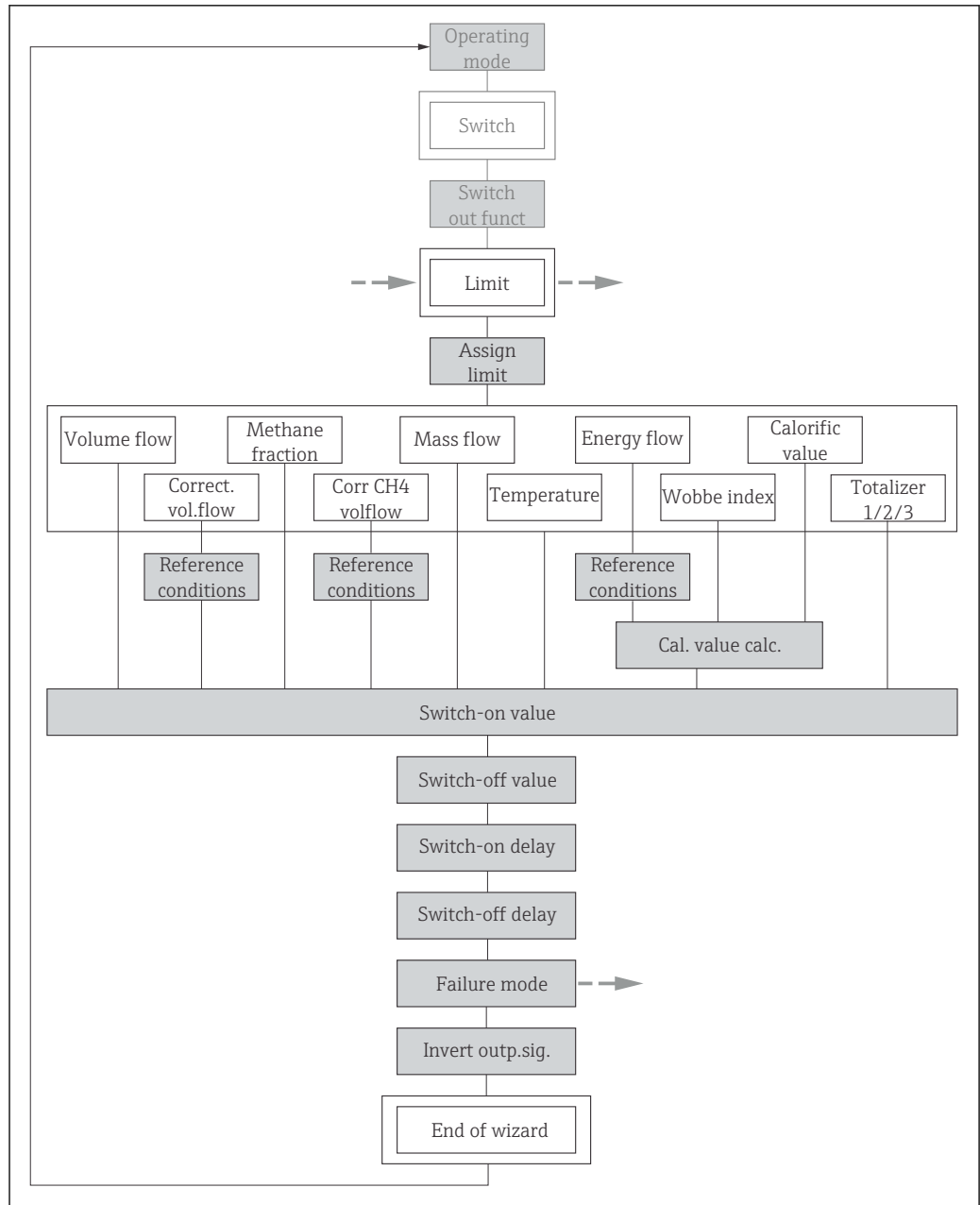

A0019226-EN

23 "Pulse/frequency/switch output" wizard in the "Setup" menu: "Operating mode" parameter "Switch" option (part 2)

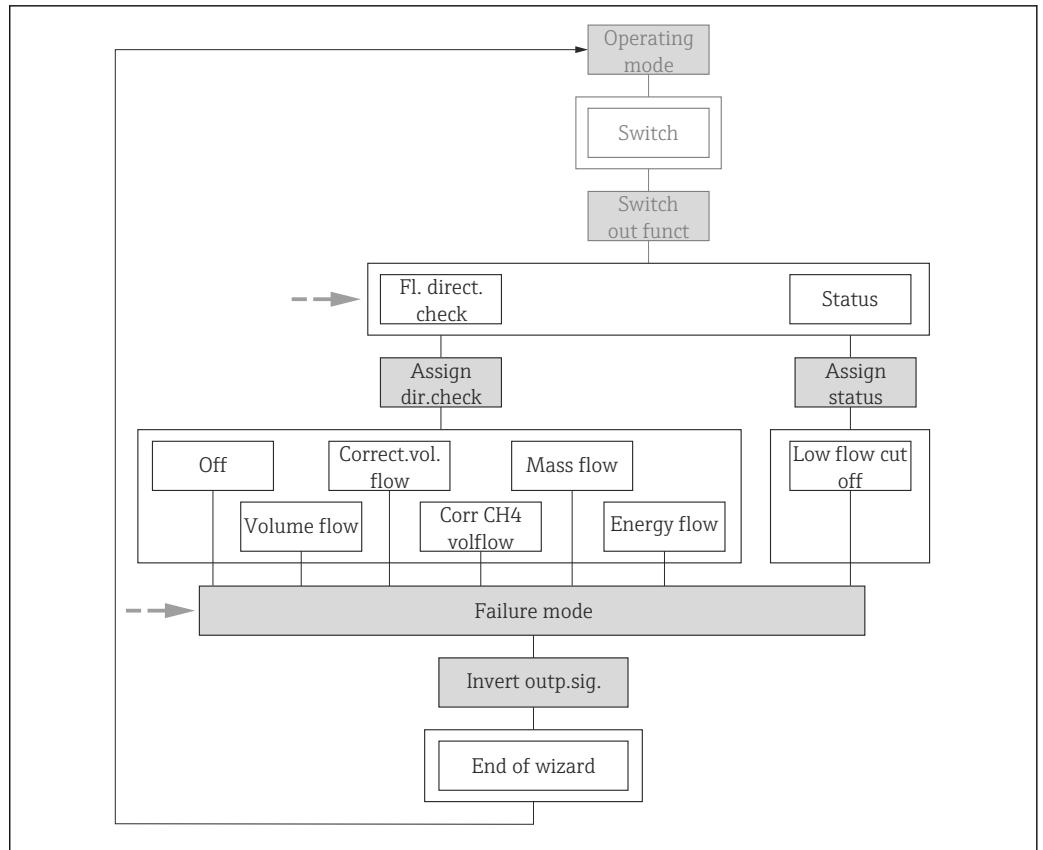

A0019227-EN

24 "Pulse/frequency/switch output" wizard in the "Setup" menu: "Operating mode" parameter "Switch" option (part 3)

Parameter overview with brief description

Parameter	Prerequisite	Description	Selection / User entry	Factory setting
Operating mode	-	Define the output as a pulse, frequency or switch output.	<ul style="list-style-type: none"> ▪ Pulse ▪ Frequency ▪ Switch 	Pulse
Switch output function	The Switch option is selected in the Operating mode parameter.	Select function for switch output.	<ul style="list-style-type: none"> ▪ Off ▪ On ▪ Diagnostic behavior ▪ Limit ▪ Flow direction check ▪ Status 	Off
Assign diagnostic behavior	The Diagnostic behavior option is selected in the Switch output function parameter.	Select diagnostic behavior for switch output.	<ul style="list-style-type: none"> ▪ Alarm ▪ Alarm or warning ▪ Warning 	Alarm

Parameter	Prerequisite	Description	Selection / User entry	Factory setting
Assign limit	In the Switch output function parameter the Limit option is selected.	Select process variable for limit function.	<ul style="list-style-type: none"> ■ Volume flow ■ Corrected volume flow ■ Corrected methane volume flow * ■ Mass flow ■ Energy flow * ■ Methane fraction * ■ Wobbe index * ■ Calorific value * ■ Temperature * ■ Totalizer 1 ■ Totalizer 2 ■ Totalizer 3 ■ Sound velocity ■ Flow velocity ■ Acceptance rate * ■ Signal asymmetry * ■ Turbulence * ■ Signal strength * ■ Signal to noise ratio * 	Volume flow
Assign flow direction check	The Flow direction check option is selected in the Switch output function parameter.	Select process variable for flow direction monitoring.	<ul style="list-style-type: none"> ■ Off ■ Volume flow ■ Corrected volume flow ■ Corrected methane volume flow ■ Mass flow ■ Energy flow 	Volume flow
Assign status	The Status option is selected in the Switch output function parameter.	Select device status for switch output.	Low flow cut off	Low flow cut off
Switch-on value	In the Switch output function parameter the Limit option is selected.	Enter measured value for the switch-on point.	Signed floating-point number	Country-specific: <ul style="list-style-type: none"> ■ 0 m³/h ■ 0 ft³/h
Switch-off value	In the Switch output function parameter the Limit option is selected.	Enter measured value for the switch-off point.	Signed floating-point number	Country-specific: <ul style="list-style-type: none"> ■ 0 m³/h ■ 0 ft³/h
Switch-on delay	The Limit option is selected in the Switch output function parameter.	Define delay for the switch-on of status output.	0.0 to 100.0 s	0.0 s
Switch-off delay	The Limit option is selected in the Switch output function parameter.	Define delay for the switch-off of status output.	0.0 to 100.0 s	0.0 s
Failure mode	–	Define output behavior in alarm condition.	<ul style="list-style-type: none"> ■ Actual status ■ Open ■ Closed 	Open
Invert output signal	–	Invert the output signal.	<ul style="list-style-type: none"> ■ No ■ Yes 	No

* Visibility depends on order options or device settings

10.4.7 Configuring the local display

The **Display** wizard guides you systematically through all the parameters that can be configured for configuring the local display.

Navigation

"Setup" menu → Display

Structure of the wizard

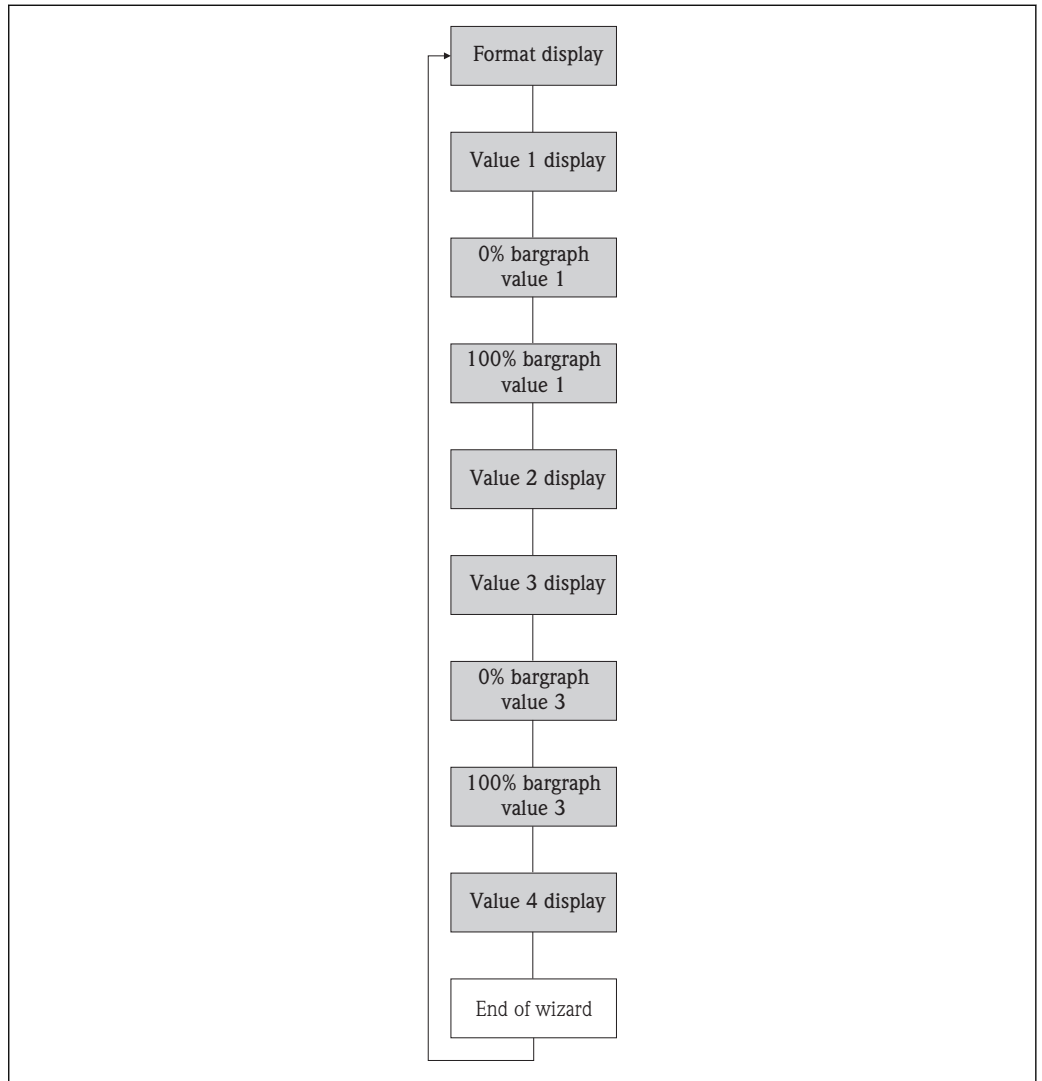

25 "Display" wizard in the "Setup" menu

A0013797-EN

Parameter overview with brief description

Parameter	Prerequisite	Description	Selection / User entry	Factory setting
Format display	A local display is provided.	Select how measured values are shown on the display.	<ul style="list-style-type: none"> ■ 1 value, max. size ■ 1 bargraph + 1 value ■ 2 values ■ 1 value large + 2 values ■ 4 values 	1 value, max. size
Value 1 display	A local display is provided.	Select the measured value that is shown on the local display.	<ul style="list-style-type: none"> ■ Volume flow ■ Corrected volume flow ■ Corrected methane volume flow * ■ Mass flow ■ Energy flow * ■ Methane fraction * ■ Calorific value * ■ Wobbe index * ■ Temperature * ■ Totalizer 1 ■ Totalizer 2 ■ Totalizer 3 ■ Current output 1 ■ Current output 2 * ■ Sound velocity ■ Flow velocity ■ Acceptance rate * ■ Signal asymmetry * ■ Turbulence * ■ Signal strength * ■ Signal to noise ratio * 	Volume flow
0% bargraph value 1	A local display is provided.	Enter 0% value for bar graph display.	Signed floating-point number	Country-specific: <ul style="list-style-type: none"> ■ 0 m³/h ■ 0 ft³/h
100% bargraph value 1	A local display is provided.	Enter 100% value for bar graph display.	Signed floating-point number	Depends on country and nominal diameter
Value 2 display	A local display is provided.	Select the measured value that is shown on the local display.	Picklist see Value 1 display parameter	None
Value 3 display	A local display is provided.	Select the measured value that is shown on the local display.	Picklist see Value 1 display parameter	None
0% bargraph value 3	A selection has been made in the Value 3 display parameter.	Enter 0% value for bar graph display.	Signed floating-point number	Country-specific: <ul style="list-style-type: none"> ■ 0 m³/h ■ 0 ft³/h
100% bargraph value 3	An option was selected in the Value 3 display parameter.	Enter 100% value for bar graph display.	Signed floating-point number	Depends on country and nominal diameter
Value 4 display	A local display is provided.	Select the measured value that is shown on the local display.	Picklist see Value 1 display parameter	None

* Visibility depends on order options or device settings

10.4.8 Configuring the output conditioning

The **Output conditioning** wizard guides you systematically through all the parameters that have to be set for configuring the output conditioning.

Navigation

"Setup" menu → Output conditioning

Structure of the "Output conditioning" wizard

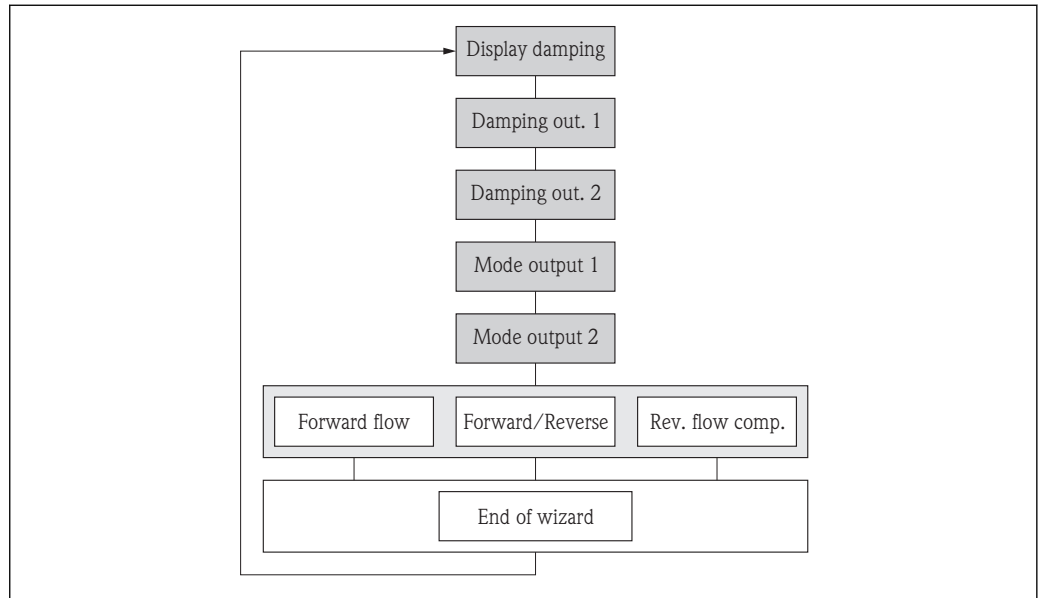

A0015993-EN

26 "Output conditioning" wizard in the "Setup" menu

Parameter overview with brief description

Parameter	Prerequisite	Description	User entry / Selection	Factory setting
Display damping	–	Set display reaction time to fluctuations in the measured value.	0.0 to 999.9 s	3.0 s
Damping output 1	–	Set the reaction time of the output signal of the current output to fluctuations in the measured value.	0 to 999.9 s	1 s
Damping output 2	The measuring device has a second current output.	Set the reaction time of the output signal of the second current output to fluctuations in the measured value.	0 to 999 s	1 s
Damping output 2	The measuring device has a pulse/frequency/switch output.	Set the reaction time of the output signal of the frequency output to fluctuations in the measured value.	0 to 999 s	1 s
Measuring mode output 1	–	Select measuring mode for output.	<ul style="list-style-type: none"> ■ Forward flow ■ Forward/Reverse flow ■ Reverse flow compensation 	Forward flow
Measuring mode output 2	–	Select measuring mode for output.	<ul style="list-style-type: none"> ■ Forward flow ■ Forward/Reverse flow ■ Reverse flow compensation 	Forward flow

Parameter	Prerequisite	Description	User entry / Selection	Factory setting
Measuring mode output 2	-	Select measuring mode for output.	<ul style="list-style-type: none"> ■ Forward flow ■ Forward/Reverse flow ■ Reverse flow ■ Reverse flow compensation 	Forward flow
Measuring mode output 2	-	Select measuring mode for output.	<ul style="list-style-type: none"> ■ Forward flow ■ Forward/Reverse flow ■ Reverse flow ■ Reverse flow compensation 	Forward flow

10.4.9 Configuring the low flow cut off

The **Low flow cut off** wizard guides you systematically through all the parameters that have to be set for configuring the low flow cut off.

Structure of the wizard

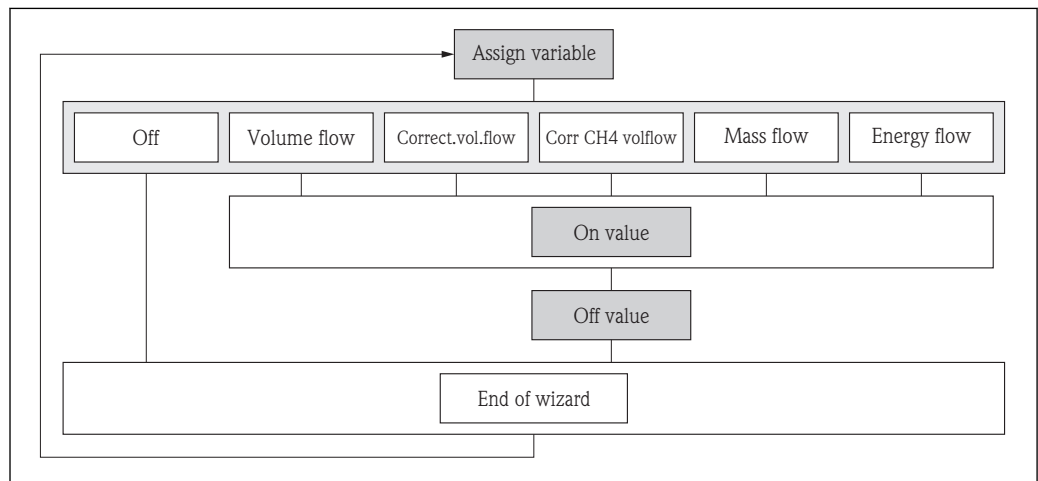

27 "Low flow cutoff" wizard in the "Setup" menu

Navigation

"Setup" menu → Low flow cut off

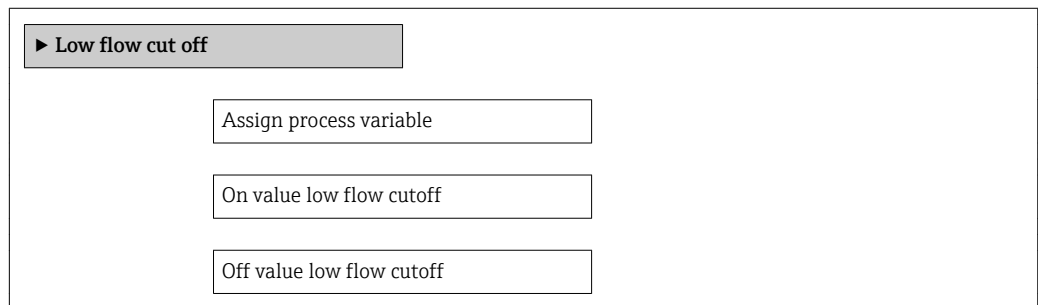

Parameter overview with brief description

Parameter	Prerequisite	Description	Selection / User entry	Factory setting
Assign process variable	–	Select process variable for low flow cut off.	<ul style="list-style-type: none"> ■ Off ■ Volume flow ■ Corrected volume flow ■ Corrected methane volume flow[*] ■ Mass flow ■ Energy flow[*] ■ Flow velocity 	Off
On value low flow cutoff	One of the following options is selected in the Assign process variable parameter (→ 83): <ul style="list-style-type: none"> ■ Volume flow ■ Corrected volume flow ■ Corrected methane volume flow[*] ■ Mass flow ■ Energy flow[*] ■ Flow velocity 	Enter on value for low flow cut off.	Positive floating-point number	Depends on country and nominal diameter
Off value low flow cutoff	One of the following options is selected in the Assign process variable parameter (→ 83): <ul style="list-style-type: none"> ■ Volume flow ■ Corrected volume flow ■ Corrected methane volume flow[*] ■ Mass flow ■ Energy flow[*] ■ Flow velocity 	Enter off value for low flow cut off.	0 to 100.0 %	50 %

* Visibility depends on order options or device settings

10.5 Advanced settings

The **Advanced setup** submenu with its submenus contains parameters for specific settings.

Navigation to the "Advanced setup" submenu

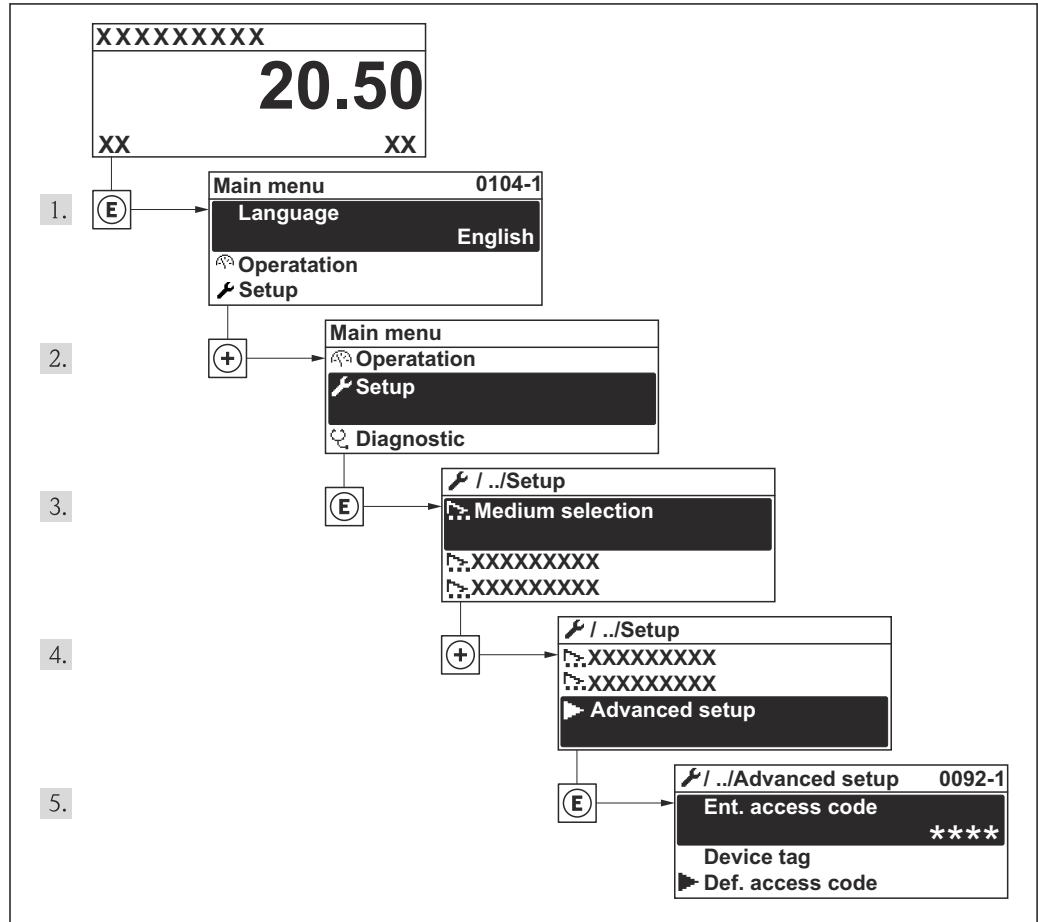

A0014009-EN

28 Taking the example of the local display

Navigation

"Setup" menu → Advanced setup

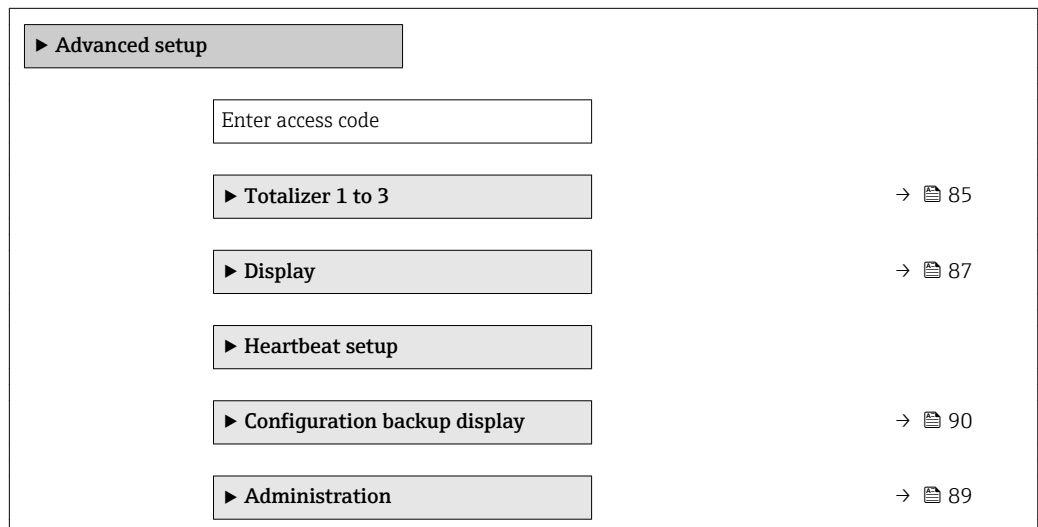

10.5.1 Configuring the totalizer

In the "Totalizer 1 to 3" submenu the individual totalizer can be configured.

Navigation

"Setup" menu → Advanced setup → Totalizer 1 to 3

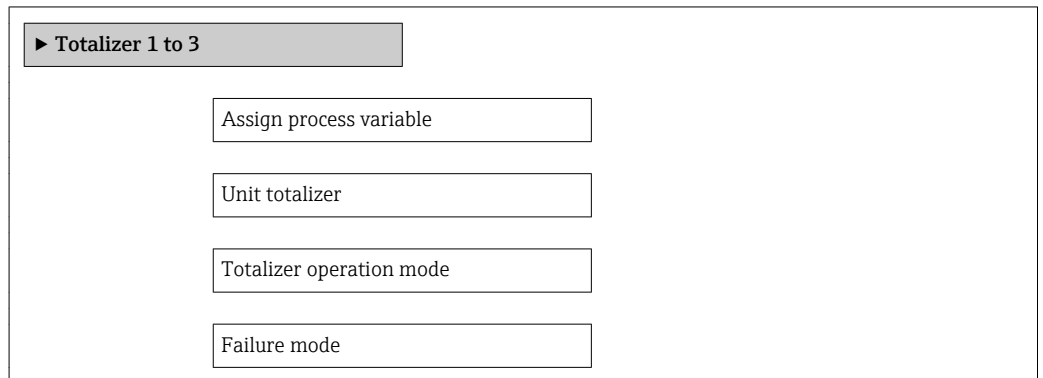

Parameter overview with brief description

Parameter	Prerequisite	Description	Selection	Factory setting
Assign process variable	–	Select process variable for totalizer.	<ul style="list-style-type: none"> ■ Off ■ Volume flow ■ Corrected volume flow ■ Corrected methane volume flow * ■ Mass flow ■ Energy flow * ■ Off ■ Volume flow ■ Corrected volume flow ■ Corrected methane volume flow ■ Mass flow ■ Energy flow 	Volume flow
Unit totalizer	One of the following options is selected in the Assign process variable parameter (→ 85) of the Totalizer 1 to 3 submenu: <ul style="list-style-type: none"> ■ Volume flow ■ Corrected volume flow ■ Corrected methane volume flow * ■ Mass flow ■ Energy flow * 	Select process variable totalizer unit.	Unit choose list	Country-specific: <ul style="list-style-type: none"> ■ m³ ■ ft³

Parameter	Prerequisite	Description	Selection	Factory setting
Totalizer operation mode	One of the following options is selected in the Assign process variable parameter (→ 85) of the Totalizer 1 to 3 submenu: <ul style="list-style-type: none"> ▪ Volume flow ▪ Corrected volume flow ▪ Corrected methane volume flow * ▪ Mass flow ▪ Energy flow * 	Select totalizer calculation mode.	<ul style="list-style-type: none"> ▪ Net flow total ▪ Forward flow total ▪ Reverse flow total 	Net flow total
Failure mode	One of the following options is selected in the Assign process variable parameter (→ 85) of the Totalizer 1 to 3 submenu: <ul style="list-style-type: none"> ▪ Volume flow ▪ Corrected volume flow ▪ Corrected methane volume flow * ▪ Mass flow ▪ Energy flow * 	Define totalizer behavior in alarm condition.	<ul style="list-style-type: none"> ▪ Stop ▪ Actual value ▪ Last valid value 	Stop

* Visibility depends on order options or device settings

10.5.2 Carrying out additional display configurations

In the **Display** submenu you can set all the parameters associated with the configuration of the local display.

Navigation

"Setup" menu → Advanced setup → Display

► Display

- Format display
- Value 1 display
- 0% bargraph value 1
- 100% bargraph value 1
- Decimal places 1
- Value 2 display
- Decimal places 2
- Value 3 display
- 0% bargraph value 3
- 100% bargraph value 3
- Decimal places 3
- Value 4 display
- Decimal places 4
- Language
- Display interval
- Display damping
- Header
- Header text
- Separator
- Backlight

Parameter overview with brief description

Parameter	Prerequisite	Description	Selection / User entry	Factory setting
Format display	A local display is provided.	Select how measured values are shown on the display.	<ul style="list-style-type: none"> ■ 1 value, max. size ■ 1 bargraph + 1 value ■ 2 values ■ 1 value large + 2 values ■ 4 values 	1 value, max. size
Value 1 display	A local display is provided.	Select the measured value that is shown on the local display.	<ul style="list-style-type: none"> ■ Volume flow ■ Corrected volume flow ■ Corrected methane volume flow * ■ Mass flow ■ Energy flow * ■ Methane fraction * ■ Calorific value * ■ Wobbe index * ■ Temperature * ■ Totalizer 1 ■ Totalizer 2 ■ Totalizer 3 ■ Current output 1 ■ Current output 2 * ■ Sound velocity ■ Flow velocity ■ Acceptance rate * ■ Signal asymmetry * ■ Turbulence * ■ Signal strength * ■ Signal to noise ratio * 	Volume flow
0% bargraph value 1	A local display is provided.	Enter 0% value for bar graph display.	Signed floating-point number	Country-specific: <ul style="list-style-type: none"> ■ 0 m³/h ■ 0 ft³/h
100% bargraph value 1	A local display is provided.	Enter 100% value for bar graph display.	Signed floating-point number	Depends on country and nominal diameter
Decimal places 1	A measured value is specified in the Value 1 display parameter.	Select the number of decimal places for the display value.	<ul style="list-style-type: none"> ■ x ■ x.x ■ x.xx ■ x.xxx ■ x.xxxx 	x.xx
Value 2 display	A local display is provided.	Select the measured value that is shown on the local display.	Picklist see Value 1 display parameter	None
Decimal places 2	A measured value is specified in the Value 2 display parameter.	Select the number of decimal places for the display value.	<ul style="list-style-type: none"> ■ x ■ x.x ■ x.xx ■ x.xxx ■ x.xxxx 	x.xx
Value 3 display	A local display is provided.	Select the measured value that is shown on the local display.	Picklist see Value 1 display parameter	None
0% bargraph value 3	A selection has been made in the Value 3 display parameter.	Enter 0% value for bar graph display.	Signed floating-point number	Country-specific: <ul style="list-style-type: none"> ■ 0 m³/h ■ 0 ft³/h
100% bargraph value 3	An option was selected in the Value 3 display parameter.	Enter 100% value for bar graph display.	Signed floating-point number	Depends on country and nominal diameter

Parameter	Prerequisite	Description	Selection / User entry	Factory setting
Decimal places 3	A measured value is specified in the Value 3 display parameter.	Select the number of decimal places for the display value.	<ul style="list-style-type: none"> ■ x ■ x.x ■ x.xx ■ x.xxx ■ x.xxxx 	x.xx
Value 4 display	A local display is provided.	Select the measured value that is shown on the local display.	Picklist see Value 1 display parameter	None
Decimal places 4	A measured value is specified in the Value 4 display parameter.	Select the number of decimal places for the display value.	<ul style="list-style-type: none"> ■ x ■ x.x ■ x.xx ■ x.xxx ■ x.xxxx 	x.xx
Language	A local display is provided.	Set display language.	<ul style="list-style-type: none"> ■ English ■ Deutsch * ■ Français * ■ Español * ■ Italiano * ■ Nederlands * ■ Portuguesa * ■ Polski * ■ русский язык (Russian) * ■ Svenska * ■ Türkçe * ■ 中文 (Chinese) * ■ 日本語 (Japanese) * ■ 한국어 (Korean) * ■ العربية (Arabic) * ■ Bahasa Indonesia * ■ ภาษาไทย (Thai) * ■ tiếng Việt (Vietnamese) * ■ čeština (Czech) * 	English (alternatively, the ordered language is preset in the device)
Display interval	A local display is provided.	Set time measured values are shown on display if display alternates between values.	1 to 10 s	5 s
Display damping	A local display is provided.	Set display reaction time to fluctuations in the measured value.	0.0 to 999.9 s	3.0 s
Header	A local display is provided.	Select header contents on local display.	<ul style="list-style-type: none"> ■ Device tag ■ Free text 	Device tag
Header text	The Free text option is selected in the Header parameter.	Enter display header text.	Max. 12 characters such as letters, numbers or special characters (e.g. @, %, /)	-----
Separator	A local display is provided.	Select decimal separator for displaying numerical values.	<ul style="list-style-type: none"> ■ . (point) ■ , (comma) 	. (point)
Backlight	–	Switch the local display backlight on and off.  Only for device version with local display SD03 (touch control)	<ul style="list-style-type: none"> ■ Disable ■ Enable 	Disable

* Visibility depends on order options or device settings

10.5.3 Administration configuration

The **Administration** submenu contains administrative parameters.

Navigation

"Setup" menu → Advanced setup → Administration

▶ Administration

Parameter overview with brief description

Parameter	Description	User entry / Selection	Factory setting
Define access code	Restrict write-access to parameters to protect the configuration of the device against unintentional changes via the local display.	0 to 9 999	0
Device reset	Reset the device configuration - either entirely or in part - to a defined state.	<ul style="list-style-type: none"> ▪ Cancel ▪ To factory defaults ▪ To delivery settings ▪ Restart device 	Cancel

10.6 Configuration management

After commissioning, you can save the current device configuration, copy it to another measuring point or restore the previous device configuration.

You can do so using the **Configuration management** parameter and the related options found in the **Configuration backup display** submenu.

Navigation

"Setup" menu → Advanced setup → Configuration backup display

▶ Configuration backup display

Parameter overview with brief description

Parameter	Prerequisite	Description	User interface / Selection	Factory setting
Operating time	–	Indicates how long the device has been in operation.	Days (d), hours (h), minutes (m) and seconds (s)	–
Last backup	A local display is provided.	Indicates when the last data backup was saved to the display module.	Days (d), hours (h), minutes (m) and seconds (s)	–
Configuration management	A local display is provided.	Select action for managing the device data in the display module.	<ul style="list-style-type: none"> ■ Cancel ■ Execute backup ■ Restore ■ Duplicate ■ Compare ■ Clear backup data 	Cancel
Comparison result	A local display is provided.	Comparison between present device data and display backup.	<ul style="list-style-type: none"> ■ Settings identical ■ Settings not identical ■ No backup available ■ Backup settings corrupt ■ Check not done ■ Dataset incompatible 	Check not done

10.6.1 Function scope of the "Configuration management" parameter

Options	Description
Execute backup	The current device configuration is backed up from the integrated HistoROM to the device's display module. The backup copy includes the transmitter data of the device.
Restore	The last backup copy of the device configuration is restored from the display module to the device's integrated HistoROM. The backup copy includes the transmitter data of the device.
Duplicate	The transmitter configuration from another device is duplicated to the device using the display module.
Compare	The device configuration saved in the display module is compared with the current device configuration of the integrated HistoROM.
Clear backup data	The backup copy of the device configuration is deleted from the display module of the device.



Integrated HistoROM

A HistoROM is a "non-volatile" device memory in the form of an EEPROM.



While this action is in progress, the configuration cannot be edited via the local display and a message on the processing status appears on the display.

10.7 Simulation

The **Simulation** submenu enables you to simulate, without a real flow situation, various process variables in the process and the device alarm mode and to verify downstream signal chains (switching valves or closed-control loops).

Navigation

"Diagnostics" menu → Simulation

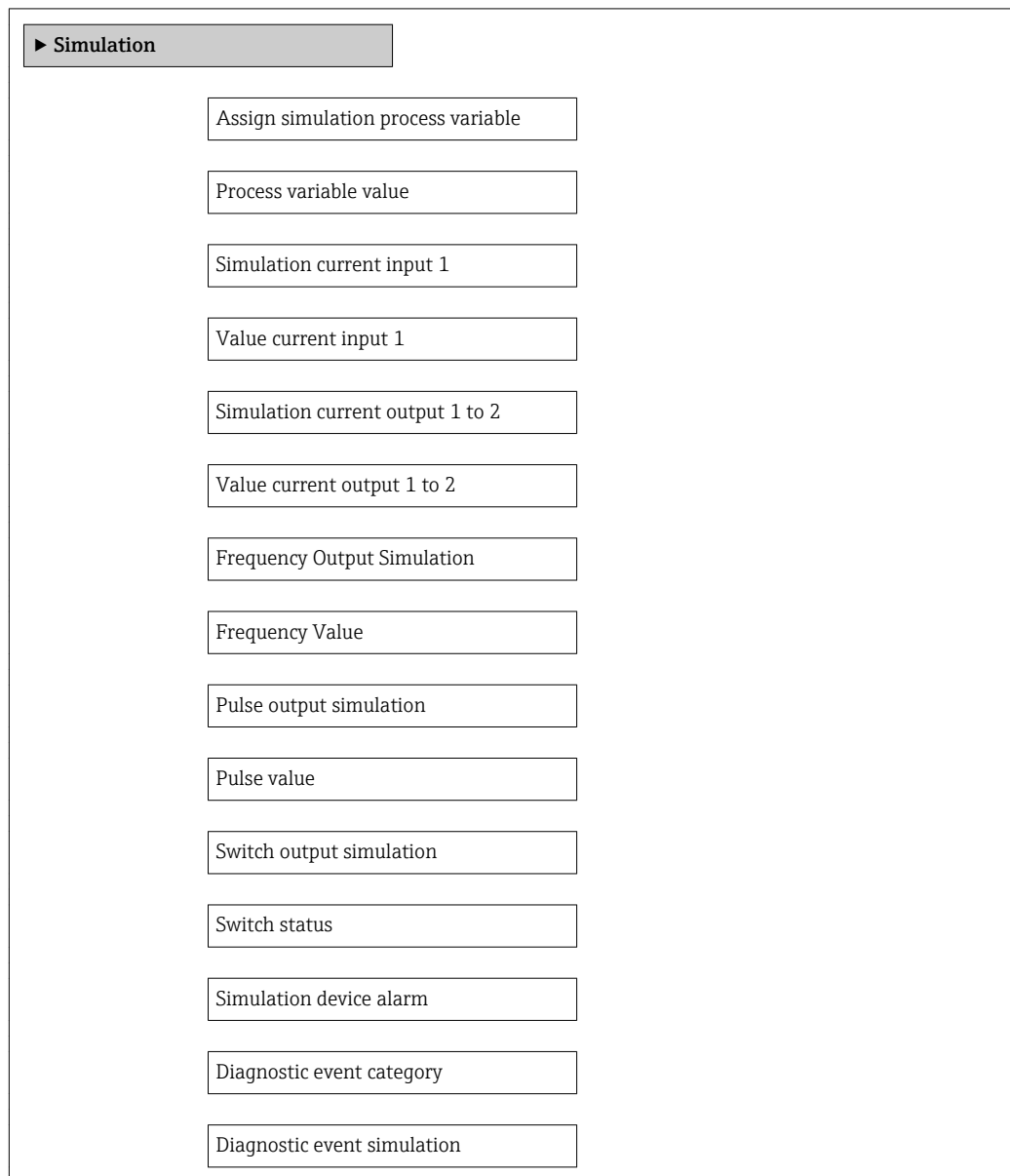

Parameter overview with brief description

Parameter	Prerequisite	Description	Selection / User entry	Factory setting
Assign simulation process variable	–	Select a process variable for the simulation process that is activated.	<ul style="list-style-type: none"> ▪ Off ▪ Volume flow ▪ Corrected volume flow ▪ Methane fraction ▪ Corrected methane volume flow ▪ Mass flow ▪ Temperature ▪ Energy flow ▪ Wobbe index ▪ Calorific value ▪ Flow velocity ▪ Sound velocity 	Off
Process variable value	One of the following options is selected in the Assign simulation process variable parameter (→ 93): <ul style="list-style-type: none"> ▪ Volume flow ▪ Corrected volume flow ▪ Methane fraction* ▪ Corrected methane volume flow* ▪ Mass flow ▪ Temperature* ▪ Energy flow* ▪ Wobbe index* ▪ Calorific value* ▪ Flow velocity ▪ Sound velocity 	Enter the simulation value for the selected process variable.	Depends on the process variable selected	0
Simulation current input 1	–	Switch simulation of the current input on and off.	<ul style="list-style-type: none"> ▪ Off ▪ On 	Off
Value current input 1	In the Simulation current input parameter the On option is selected.	Enter the current value for simulation.	3.59 to 22.5 mA	3.59 mA
Simulation current output 1 to 2	–	Switch the simulation of the current output on and off.	<ul style="list-style-type: none"> ▪ Off ▪ On 	Off
Value current output 1 to 2	In the Simulation current output 1 to 2 parameter, the On option is selected.	Enter the current value for simulation.	3.59 to 22.5 mA	3.59 mA
Frequency Output Simulation	The Frequency option is selected in the Operating mode parameter.	Switch the simulation of the frequency output on and off.	<ul style="list-style-type: none"> ▪ Off ▪ On 	Off
Frequency Value	The On option is selected in the Frequency Output Simulation parameter.	Enter the frequency value for the simulation.	0.0 to 1250.0 Hz	0.0 Hz
Pulse output simulation	The Pulse option is selected in the Operating mode parameter.	Set and switch off the pulse output simulation.  For Fixed value option: Pulse width parameter (→ 70) defines the pulse width of the pulses output.	<ul style="list-style-type: none"> ▪ Off ▪ Fixed value ▪ Down-counting value 	Off
Pulse value	In the Pulse output simulation parameter (→ 93), the Down-counting value option is selected.	Enter the number of pulses for simulation.	0 to 65535	0

Parameter	Prerequisite	Description	Selection / User entry	Factory setting
Switch output simulation	The Switch option is selected in the Operating mode parameter.	Switch the simulation of the switch output on and off.	<ul style="list-style-type: none"> ▪ Off ▪ On 	Off
Switch status	The On option is selected in the Switch output simulation parameter (→ 94).	Select the status of the status output for the simulation.	<ul style="list-style-type: none"> ▪ Open ▪ Closed 	Open
Simulation device alarm	–	Switch the device alarm on and off.	<ul style="list-style-type: none"> ▪ Off ▪ On 	Off
Diagnostic event category	–	Select a diagnostic event category.	<ul style="list-style-type: none"> ▪ Sensor ▪ Electronics ▪ Configuration ▪ Process 	Process
Diagnostic event simulation	–	Select a diagnostic event to simulate this event.	<ul style="list-style-type: none"> ▪ Off ▪ Diagnostic event picklist (depends on the category selected) 	Off

* Visibility depends on order options or device settings

10.8 Protecting settings from unauthorized access

The following options exist for protecting the configuration of the measuring device from unintentional modification after commissioning:

- Write protection via access code
- Write protection via write protection switch
- Write protection via keypad lock → 46

10.8.1 Write protection via access code

With the customer-specific access code, the parameters for the measuring device configuration are write-protected and their values can no longer be changed via local operation.

Navigation

"Setup" menu → Advanced setup → Administration → Define access code

▶ Define access code

Define access code

Confirm access code

Defining the access code via local display

1. Navigate to the **Enter access code** parameter.
2. Max. Define a max. 4-digit numeric code as an access code.
3. Enter the access code again to confirm the code.
 - ↳ The -symbol appears in front of all write-protected parameters.

The device automatically locks the write-protected parameters again if a key is not pressed for 10 minutes in the navigation and editing view. The device locks the write-protected

parameters automatically after 60 s if the user skips back to the operational display mode from the navigation and editing view.

- i
 - If write access is activated via access code, it can be also be deactivated only via the access code → 46.
 - The user role with which the user is currently logged on via the local display → 46 is indicated by the **Access status display** parameter. Navigation path: "Operation" menu → Access status display

Parameters which can always be modified via the local display

Certain parameters that do not affect the measurement are excepted from write protection via the local display. Despite the defined access code, these parameters can always be modified even if the other parameters are locked.

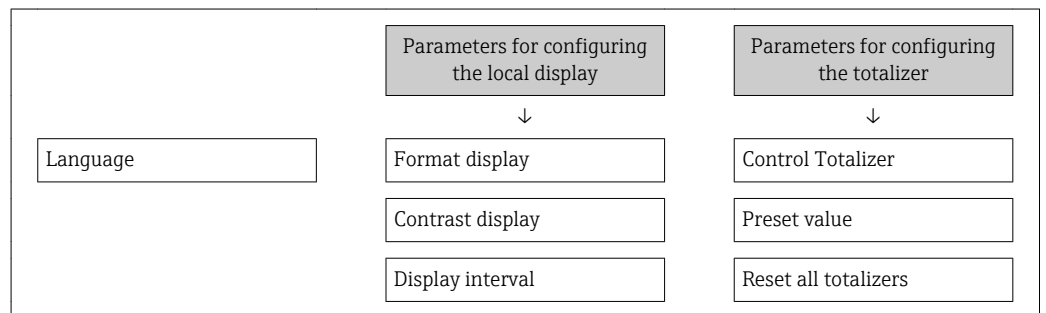

10.8.2 Write protection via write protection switch

Unlike write protection via a user-specific access code, this allows write access to the entire operating menu - other than the **"Contrast display" parameter** - to be locked.

The parameter values are now read only and cannot be edited any more (exception **"Contrast display" parameter**):

- Via local display
- Via service interface (CDI)
- Via HART protocol

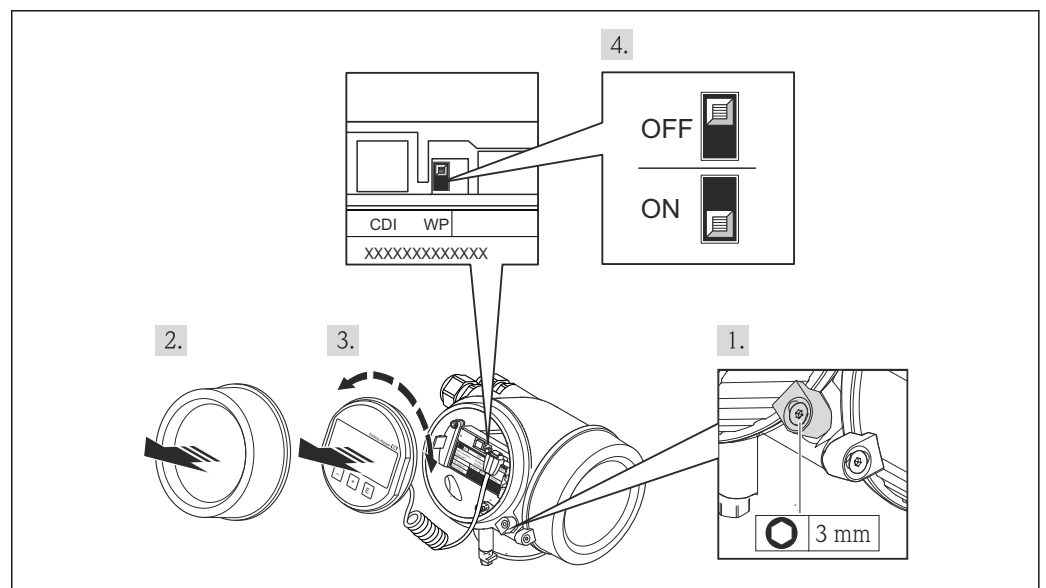

1. Loosen the securing clamp.
2. Unscrew the electronics compartment cover.

3. Pull out the display module with a gentle rotational movement. To make it easier to access the write protection switch, attach the display module to the edge of the electronics compartment.
 - ↳ Display module is attached to the edge of the electronics compartment.

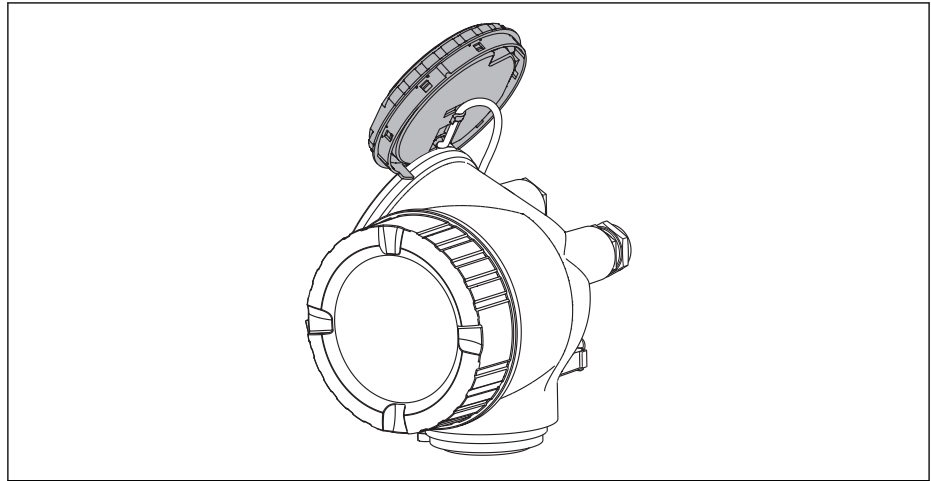

A0013909

4. Setting the write protection switch (WP) on the main electronics module to the **ON** position enables hardware write protection. Setting the write protection switch (WP) on the main electronics module to the **OFF** position (factory setting) disables hardware write protection.
 - ↳ If hardware write protection is enabled, the **Locking status** parameter displays the **Hardware locked** option . In addition, on the local display the -symbol appears in front of the parameters in the header of the operational display and in the navigation view.

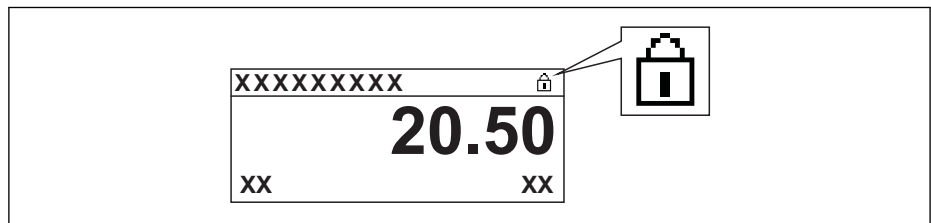

A0015870



If hardware write protection is disabled, no option is displayed in the **Locking status** parameter . On the local display, the -symbol disappears from in front of the parameters in the header of the operational display and in the navigation view.

5. Feed the cable into the gap between the housing and main electronics module and plug the display module into the electronics compartment in the desired direction until it engages.
6. Reverse the removal procedure to reassemble the transmitter.



11 Operation

11.1 Adjusting the operating language

Information →  57

 For information on the operating languages supported by the measuring device
→  146

11.2 Configuring the display

- Basic settings for local display →  78
- Advanced settings for local display →  87

11.3 Reading measured values

With the **Measured values** submenu, it is possible to read all the measured values.

11.3.1 Process variables

The **Process variables** submenu contains all the parameters needed to display the current measured values for every process variable.

Navigation

"Diagnostics" menu → Measured values → Process variables

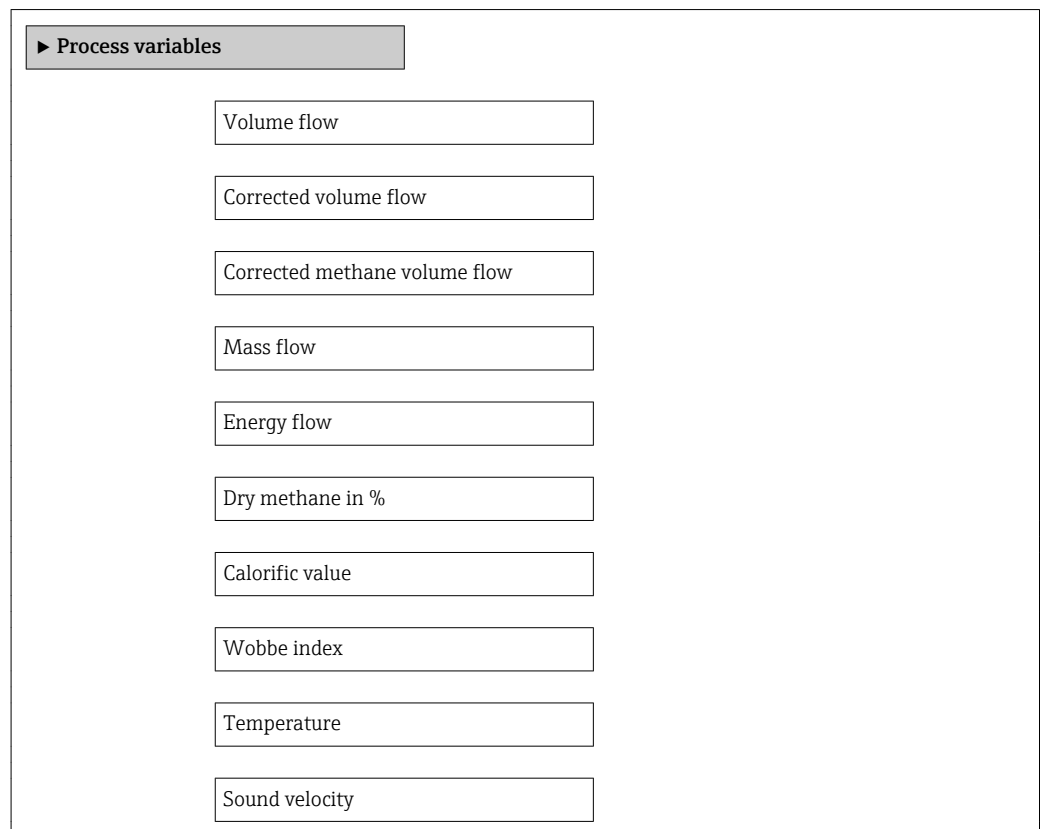

Flow velocity
Process pressure

Parameter overview with brief description

Parameter	Prerequisite	Description	User interface
Volume flow	–	Displays the volume flow currently measured. <i>Dependency</i> The unit is taken from the Volume flow unit parameter	Signed floating-point number
Corrected volume flow	–	Displays the corrected volume flow currently calculated. <i>Dependency</i> The unit is taken from the Corrected volume flow unit parameter	Signed floating-point number
Corrected methane volume flow	For the following order code: "Sensor version", option 2 "Volume flow + biogas analysis"	Displays the methane corrected volume flow currently calculated. <i>Dependency</i> The unit is taken from the Corrected volume flow unit parameter	Signed floating-point number
Mass flow	–	Displays the mass flow currently calculated. <i>Dependency</i> The unit is taken from the Mass flow unit parameter	Signed floating-point number
Energy flow	For the following order code: "Sensor version", option 2 "Volume flow + biogas analysis"	Displays the energy flow currently calculated. <i>Dependency</i> The unit is taken from the Energy flow unit parameter	Signed floating-point number
Dry methane in %	For the following order code: "Sensor version", option 2 "Volume flow + biogas analysis"	Displays the methane fraction of the dry gas currently measured.	Signed floating-point number
Calorific value	For the following order code: "Sensor version", option 2 "Volume flow + biogas analysis"	Displays the calorific value currently calculated. <i>Dependency</i> The unit is taken from the Calorific value unit parameter	Signed floating-point number
Wobbe index	For the following order code: "Sensor version", option 2 "Volume flow + biogas analysis"	Displays the Wobbe index currently calculated. <i>Dependency</i> The unit is taken from the Calorific value unit parameter	Signed floating-point number
Temperature	For the following order code: "Sensor version", option 2 "Volume flow + biogas analysis"	Displays the temperature currently calculated. <i>Dependency</i> The unit is taken from the Temperature unit parameter	Signed floating-point number
Sound velocity	–	Displays the sound velocity currently measured. <i>Dependency</i> The unit is taken from the Velocity unit parameter	Signed floating-point number

Parameter	Prerequisite	Description	User interface
Flow velocity	–	Displays the flow velocity currently calculated. <i>Dependency</i> The unit is taken from the Velocity unit parameter	Signed floating-point number
Process pressure	In the Pressure compensation parameter, the External absolute pressure option or the External gauge pressure option is selected.	Displays the current process pressure.	Positive floating-point number

11.3.2 System values

The **System values** submenu contains all the parameters needed to display the current measured values for every system value.

Navigation path

"Diagnostics" menu → Measured values → System values

Navigation

"Diagnostics" menu → Measured values → System values

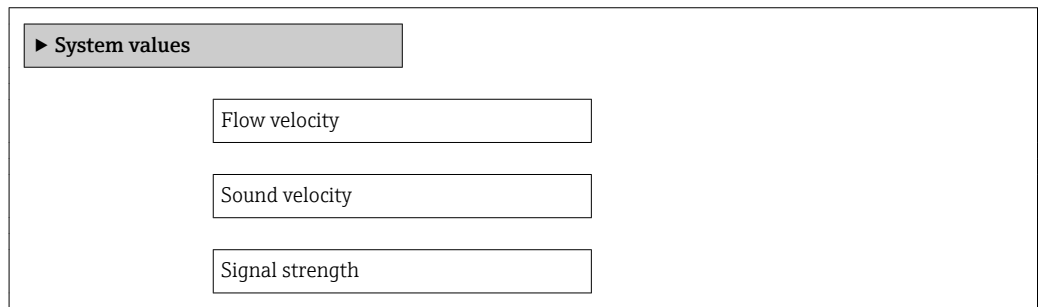

Parameter overview with brief description

Parameter	Description	User interface
Flow velocity	Displays the flow velocity currently calculated. <i>Dependency</i> The unit is taken from the Velocity unit parameter	Signed floating-point number
Sound velocity	Displays the sound velocity currently measured. <i>Dependency</i> The unit is taken from the Velocity unit parameter	Signed floating-point number
Signal strength	Displays the current signal strength.	Signed floating-point number

11.3.3 Totalizer

The **Totalizer** submenu contains all the parameters needed to display the current measured values for every totalizer.

Navigation

"Diagnostics" menu → Measured values → Totalizer

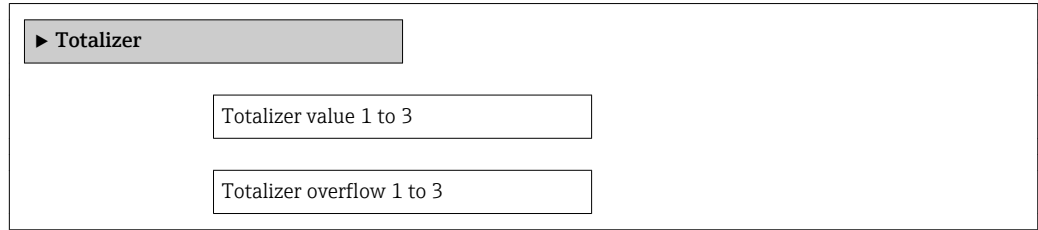

Parameter overview with brief description

Parameter	Prerequisite	Description	User interface
Totalizer value 1 to 3	One of the following options is selected in the Assign process variable parameter (→ ⓘ 85) of the Totalizer 1 to 3 submenu: <ul style="list-style-type: none"> ■ Volume flow ■ Corrected volume flow ■ Corrected methane volume flow * ■ Mass flow ■ Energy flow * 	Displays the current totalizer counter value.	Signed floating-point number
Totalizer overflow 1 to 3	One of the following options is selected in the Assign process variable parameter (→ ⓘ 85) of the Totalizer 1 to 3 submenu: <ul style="list-style-type: none"> ■ Volume flow ■ Corrected volume flow ■ Corrected methane volume flow * ■ Mass flow ■ Energy flow * 	Displays the current totalizer overflow.	Integer with sign

* Visibility depends on order options or device settings

11.3.4 Output values

The **Output values** submenu contains all the parameters needed to display the current measured values for every output.

Navigation

"Diagnostics" menu → Measured values → Output values

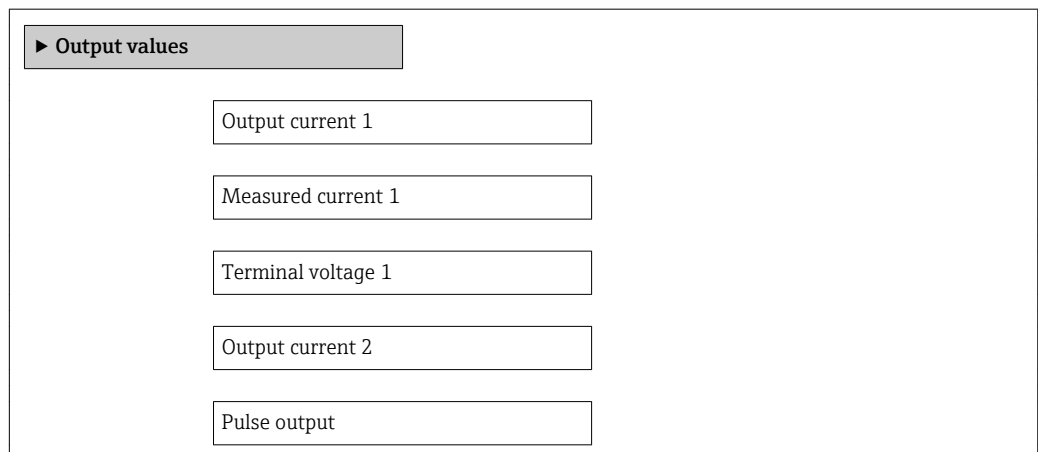

Output frequency
Switch status

Parameter overview with brief description

Parameter	Prerequisite	Description	User interface
Output current 1	–	Displays the current value currently calculated for the current output.	3.59 to 22.5 mA
Measured current 1	–	Displays the current value currently measured for the current output.	0 to 30 mA
Terminal voltage 1	–	Displays the current terminal voltage that is applied at the current output.	0.0 to 50.0 V
Output current 2	–	Displays the current value currently calculated for the current output.	3.59 to 22.5 mA
Pulse output	The Pulse option is selected in the Operating mode parameter.	Displays the pulse frequency currently output.	Positive floating-point number
Output frequency	The Frequency option is selected in the Operating mode parameter.	Displays the value currently measured for the frequency output.	0 to 1250 Hz
Switch status	The Switch option is selected in the Operating mode parameter.	Displays the current switch output status.	<ul style="list-style-type: none"> ▪ Open ▪ Closed

11.4 Adapting the measuring device to the process conditions

The following are available for this purpose:

- Basic settings using the **Setup** menu
→  58
- Advanced settings using the **Advanced setup** submenu →  84

11.5 Performing a totalizer reset

In the **Operation** submenu the totalizers are reset:

- Control Totalizer
- Reset all totalizers

Function scope of the "Control Totalizer" parameter

Options	Description
Totalize	The totalizer is started.
Reset + hold	The totaling process is stopped and the totalizer is reset to 0.
Preset + hold	The totaling process is stopped and the totalizer is set to its defined start value from the Preset value parameter.
Reset + totalize	The totalizer is reset to 0 and the totaling process is restarted.
Preset + totalize	The totalizer is set to the defined start value in the Preset value parameter and the totaling process is restarted.
Hold	The totaling process is stopped.

Function scope of the "Reset all totalizers" parameter

Options	Description
Reset + totalize	Resets all totalizers to 0 and restarts the totaling process. This deletes all the flow values previously totalized.

Navigation

"Operation" menu → Operation

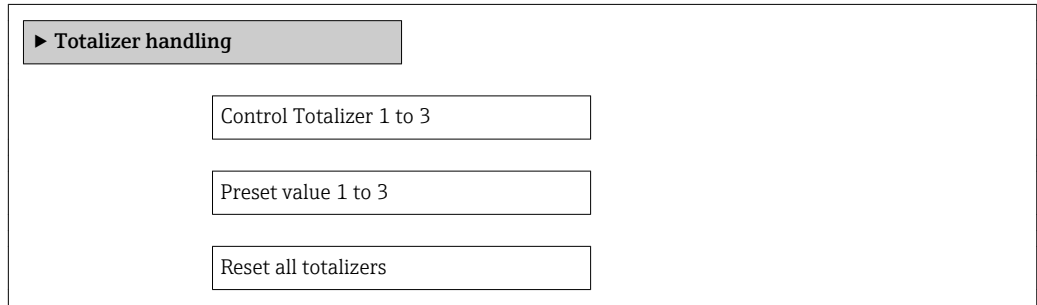

Parameter overview with brief description

Parameter	Prerequisite	Description	Selection / User entry	Factory setting
Control Totalizer	One of the following options is selected in the Assign process variable parameter (→ 85) of the Totalizer 1 to 3 submenu: <ul style="list-style-type: none"> ▪ Volume flow ▪ Corrected volume flow ▪ Corrected methane volume flow* ▪ Mass flow ▪ Energy flow* 	Control totalizer value.	<ul style="list-style-type: none"> ▪ Totalize ▪ Reset + hold ▪ Preset + hold ▪ Reset + totalize ▪ Preset + totalize ▪ Hold 	Totalize
Preset value	One of the following options is selected in the Assign process variable parameter (→ 85) of the Totalizer 1 to 3 submenu: <ul style="list-style-type: none"> ▪ Volume flow ▪ Corrected volume flow ▪ Corrected methane volume flow* ▪ Mass flow ▪ Energy flow* 	Specify start value for totalizer. <i>Dependency</i>  The unit of the selected process variable is specified for the totalizer in the Unit totalizer parameter (→ 85).	Signed floating-point number	Country-specific: <ul style="list-style-type: none"> ▪ 0 m³ ▪ 0 ft³
Reset all totalizers	–	Reset all totalizers to 0 and start.	<ul style="list-style-type: none"> ▪ Cancel ▪ Reset + totalize 	Cancel

* Visibility depends on order options or device settings

11.6 Showing data logging

The **Extended HistoROM** application package must be enabled in the device (order option) for the **Data logging** submenu to appear. This contains all the parameters for the measured value history.

 The measured value history is also accessible via the FieldCare plant asset management tool → 49.

Function scope

- A total of 1000 measured values can be stored
- 4 logging channels
- Adjustable logging interval for data logging
- Display of the measured value trend for each logging channel in the form of a chart

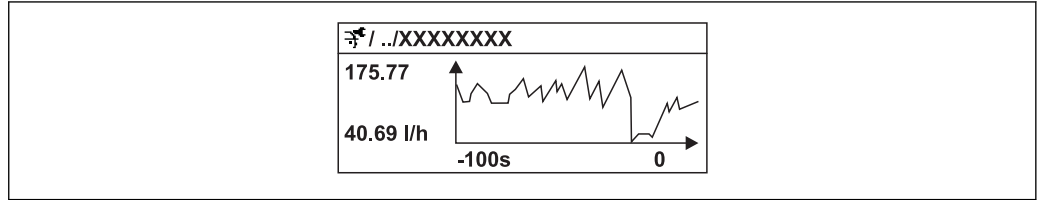

A0016222

29 Chart of a measured value trend

- x-axis: depending on the number of channels selected displays 250 to 1000 measured values of a process variable.
- y-axis: displays the approximate measured value span and constantly adapts this to the ongoing measurement.

i If the length of the logging interval or the assignment of the process variables to the channels is changed, the content of the data logging is deleted.

Navigation

"Diagnostics" menu → Data logging

"Data logging" submenu

▶ Data logging

Assign channel 1

Assign channel 2

Assign channel 3

Assign channel 4

Logging interval

Clear logging data



▶ Display channel 1

▶ Display channel 2

▶ Display channel 3

▶ Display channel 4

Parameter overview with brief description

Parameter	Prerequisite	Description	Selection / User entry	Factory setting
Assign channel 1 to 4	<p>The Extended HistoROM application package is available.</p> <p> The software options currently enabled are displayed in the Software option overview parameter.</p>	Assign process variable to logging channel.	<ul style="list-style-type: none"> ▪ Off ▪ Volume flow ▪ Corrected volume flow ▪ Corrected methane volume flow ▪ Mass flow ▪ Energy flow ▪ Methane fraction ▪ Calorific value ▪ Wobbe index ▪ Temperature ▪ Sound velocity ▪ Flow velocity ▪ Acceptance rate ▪ Signal asymmetry ▪ Turbulence ▪ Signal strength ▪ Signal to noise ratio ▪ Current output 1 	Off
Logging interval	<p>The Extended HistoROM application package is available.</p> <p> The software options currently enabled are displayed in the Software option overview parameter.</p>	Define the logging interval for data logging. This value defines the time interval between the individual data points in the memory.	1.0 to 3 600.0 s	10.0 s
Clear logging data	<p>The Extended HistoROM application package is available.</p> <p> The software options currently enabled are displayed in the Software option overview parameter.</p>	Clear the entire logging data.	<ul style="list-style-type: none"> ▪ Cancel ▪ Clear data 	Cancel

12 Diagnostics and troubleshooting

12.1 General troubleshooting





For local display

Problem	Possible causes	Remedial action
Local display dark and no output signals	Supply voltage does not match that specified on the nameplate.	Apply the correct supply voltage .
Local display dark and no output signals	Supply voltage has incorrect polarity.	Reverse polarity of supply voltage.
Local display dark and no output signals	No contact between connecting cables and terminals.	Check the connection of the cables and correct if necessary.
Local display dark and no output signals	Terminals are not plugged into the I/O electronics module correctly.	Check terminals.
Local display dark and no output signals	I/O electronics module is defective.	Order spare part → 124.
Local display is dark, but signal output is within the valid range	Display is set too bright or too dark.	<ul style="list-style-type: none"> ▪ Set the display brighter by simultaneously pressing + . ▪ Set the display darker by simultaneously pressing + .
Local display is dark, but signal output is within the valid range	The cable of the display module is not plugged in correctly.	Insert the plug correctly into the main electronics module and display module.
Local display is dark, but signal output is within the valid range	Display module is defective.	Order spare part → 124.
Backlighting of local display is red	Diagnostic event with "Alarm" diagnostic behavior has occurred.	Take remedial measures → 112
Text on local display appears in a foreign language and cannot be understood.	Incorrect operating language is configured.	<ol style="list-style-type: none"> 1. Press + for 2 s ("home position"). 2. Press . 3. Set the desired language in the Language parameter.
Message on local display: "Communication Error" "Check Electronics"	Communication between the display module and the electronics is interrupted.	<ul style="list-style-type: none"> ▪ Check the cable and the connector between the main electronics module and display module. ▪ Order spare part → 124.

For output signals

Problem	Possible causes	Remedial action
Signal output outside the valid range	Main electronics module is defective.	Order spare part → 124.
Signal output outside the valid current range (< 3.6 mA or > 22 mA)	I/O electronics module is defective.	Order spare part → 124.
Device shows correct value on local display, but signal output is incorrect, though in the valid range.	Configuration error	Check and correct parameter configuration.
Device measures incorrectly.	Configuration error or device is operated outside the application.	<ol style="list-style-type: none"> 1. Check and correct parameter configuration. 2. Observe limit values specified in the "Technical Data".

For access

Problem	Possible causes	Remedial action
No write access to parameters	Hardware write protection enabled	Set the write protection switch on the main electronics module to the OFF position .
No write access to parameters	Current user role has limited access authorization	1. Check user role →  46. 2. Enter correct customer-specific access code →  46.
No connection via HART protocol	Missing or incorrectly installed communication resistor.	Install the communication resistor (250 Ω) correctly. Observe the maximum load →  26.
No connection via HART protocol	Commubox <ul style="list-style-type: none"> ▪ Connected incorrectly ▪ Configured incorrectly ▪ Drivers not installed correctly ▪ USB interface on computer configured incorrectly 	Observe the documentation for the Commubox.  FXA195 HART: Document "Technical Information" TI00404F
No connection via service interface	Incorrect configuration of USB interface on PC or driver not installed correctly.	Observe the documentation for the Commubox.  FXA291: Document "Technical Information" TI00405C

12.2 Diagnostic information on local display

12.2.1 Diagnostic message

Faults detected by the self-monitoring system of the measuring device are displayed as a diagnostic message in alternation with the operational display.

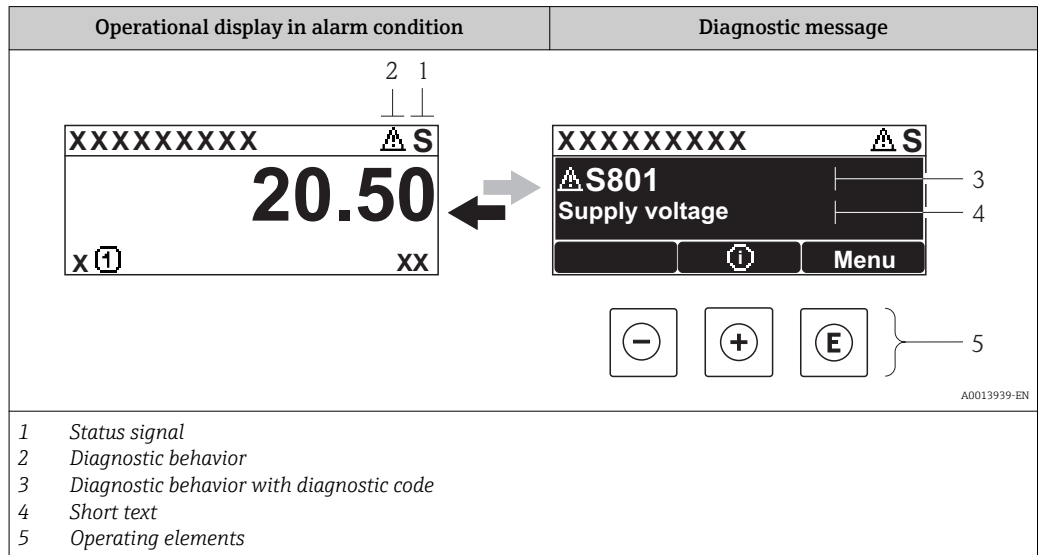

If two or more diagnostic events are pending simultaneously, only the message of the diagnostic event with the highest priority is shown.

- i** Other diagnostic events that have occurred can be called up in the **Diagnostics** menu:
 - Via parameters → 115
 - Via submenus → 116



Status signals

The status signals provide information on the state and reliability of the device by categorizing the cause of the diagnostic information (diagnostic event).

- i** The status signals are categorized according to VDI/VDE 2650 and NAMUR Recommendation NE 107: F = Failure, C = Function Check, S = Out of Specification, M = Maintenance Required

Symbol	Meaning
F <small>A0013956</small>	Failure A device error has occurred. The measured value is no longer valid.
C <small>A0013959</small>	Function check The device is in service mode (e.g. during a simulation).
S <small>A0013958</small>	Out of specification The device is operated: <ul style="list-style-type: none"> ▪ Outside its technical specification limits (e.g. outside the process temperature range) ▪ Outside of the configuration carried out by the user (e.g. maximum flow in parameter 20 mA value)
M <small>A0013957</small>	Maintenance required Maintenance is required. The measured value remains valid.

Diagnostic behavior



Symbol	Meaning
 <small>A0013961</small>	Alarm <ul style="list-style-type: none"> ▪ Measurement is interrupted. ▪ Signal outputs and totalizers assume the defined alarm condition. ▪ A diagnostic message is generated. ▪ For local display with touch control: the background lighting changes to red.
 <small>A0013962</small>	Warning Measurement is resumed. The signal outputs and totalizers are not affected. A diagnostic message is generated.

Diagnostic information

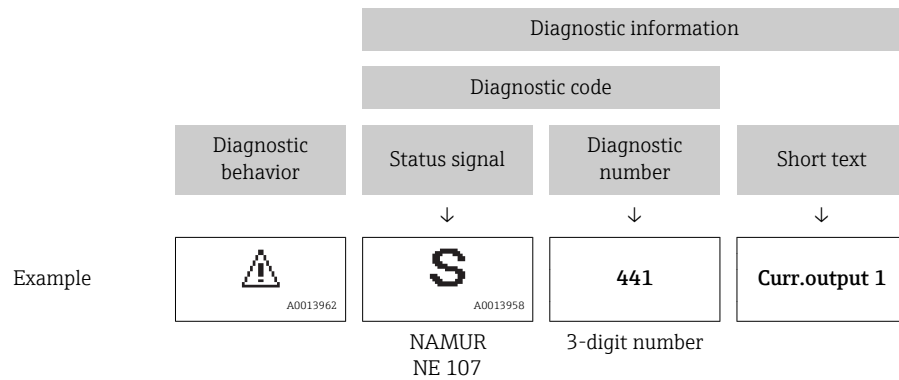
The fault can be identified using the diagnostic information. The short text helps you by providing information about the fault. In addition, the corresponding symbol for the diagnostic behavior is displayed in front of the diagnostic information on the local display.



Operating elements

Key	Meaning
 <small>A0013970</small>	Plus key <i>In a menu, submenu</i> Opens the message about the remedial measures.
 <small>A0013952</small>	Enter key <i>In a menu, submenu</i> Opens the operating menu.

12.2.2 Calling up remedial measures

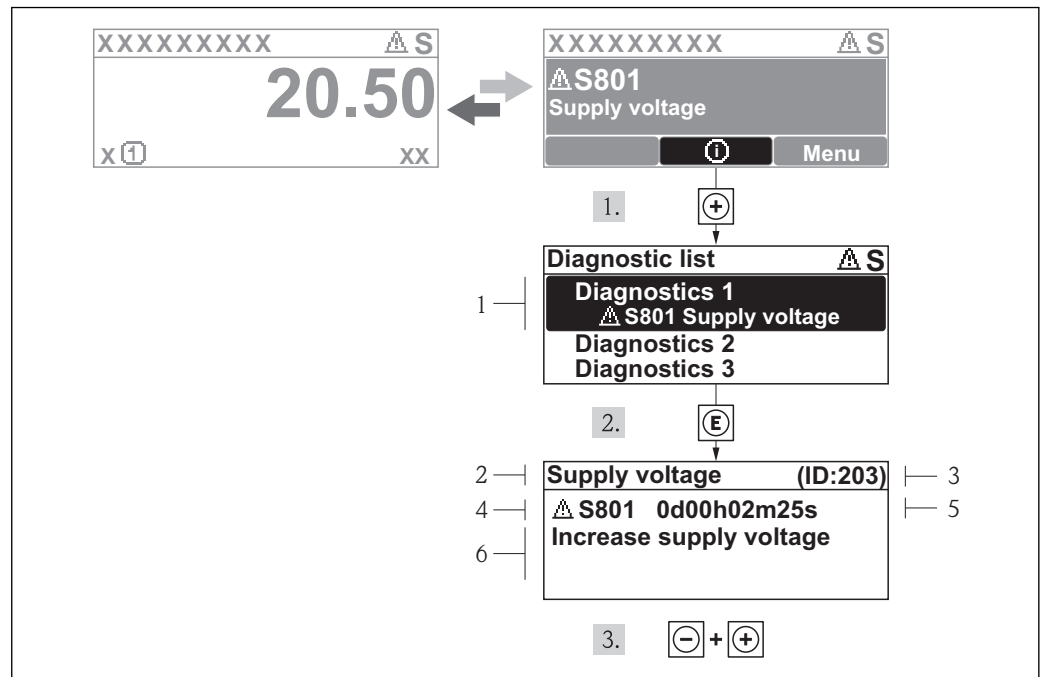

A0013940-EN

30 Message for remedial measures

- 1 Diagnostic information
- 2 Short text
- 3 Service ID
- 4 Diagnostic behavior with diagnostic code
- 5 Operation time of occurrence
- 6 Remedial measures

The user is in the diagnostic message.

1. Press \oplus (ⓘ symbol).
 - ↳ The **Diagnostic list** submenu opens.
2. Select the desired diagnostic event with \oplus or \ominus and press ⏎ .
 - ↳ The message for the remedial measures for the selected diagnostic event opens.
3. Press $\ominus + \oplus$ simultaneously.
 - ↳ The message for the remedial measures closes.

The user is in the **Diagnostics** menu at an entry for a diagnostics event, e.g. in the **Diagnostic list** submenu or the **Previous diagnostics** parameter.

1. Press ⏎ .
 - ↳ The message for the remedial measures for the selected diagnostic event opens.
2. Press $\ominus + \oplus$ simultaneously.
 - ↳ The message for the remedial measures closes.

12.3 Diagnostic information in FieldCare

12.3.1 Diagnostic options

Any faults detected by the measuring device are displayed on the home page of the operating tool once the connection has been established.

1 Status area with status signal
 2 Diagnostic information → 108
 3 Remedial measures with Service ID

- i** Furthermore, diagnostic events that have occurred can be viewed in the **Diagnostics** menu:
- Via parameters → 115
 - Via submenu → 116

Diagnostic information

The fault can be identified using the diagnostic information. The short text helps you by providing information about the fault. In addition, the corresponding symbol for the diagnostic behavior is displayed in front of the diagnostic information on the local display.

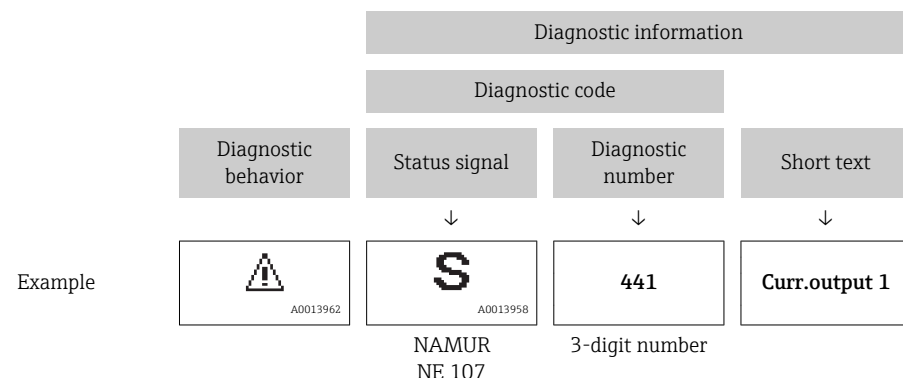

12.3.2 Calling up remedy information

Remedy information is provided for every diagnostic event to ensure that problems can be rectified quickly:

- On the home page
Remedy information is displayed in a separate field below the diagnostics information.
- In the **Diagnostics** menu
Remedy information can be called up in the working area of the user interface.

The user is in the **Diagnostics** menu.

1. Call up the desired parameter.
2. On the right in the working area, mouse over the parameter.
 - ↳ A tool tip with remedy information for the diagnostic event appears.

12.4 Adapting the diagnostic information

12.4.1 Adapting the diagnostic behavior

Each item of diagnostic information is assigned a specific diagnostic behavior at the factory. The user can change this assignment for certain diagnostic information in the **Diagnostic behavior** submenu .

"Expert" menu → System → Diagnostic handling → Diagnostic behavior

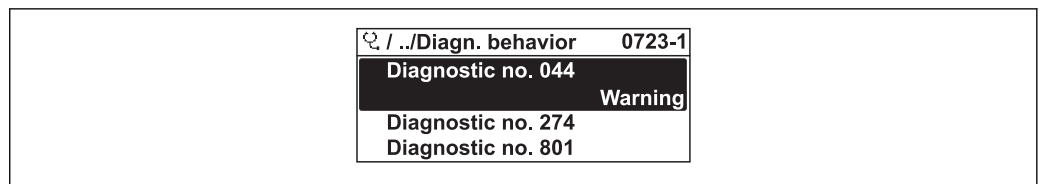

A0014048-EN

31 Using the example of the local display

You can assign the following options to the diagnostic number as the diagnostic behavior:

Options	Description
Alarm	Measurement is interrupted. Signal outputs and totalizers assume the defined alarm condition. A diagnostic message is generated. For local display with touch control: the background lighting changes to red.
Warning	Measurement is resumed. The signal outputs and totalizers are not affected. A diagnostics message is generated.
Logbook entry only	The device continues to measure. The diagnostic message is entered in the Event logbook (events list) submenu only and is not displayed in alternation with the measured value display.
Off	The diagnostic event is ignored, and no diagnostic message is generated or entered.

12.4.2 Adapting the status signal

Each item of diagnostic information is assigned a specific status signal at the factory. The user can change this assignment for certain diagnostic information in the **Diagnostic event category** submenu .

"Expert" menu → Communication → Diagnostic event category



Available status signals

Configuration as per HART 7 Specification (Condensed Status), in accordance with NAMUR NE107.

Symbol	Meaning
F <small>A0013956</small>	Failure A device error has occurred. The measured value is no longer valid.
C <small>A0013959</small>	Function check The device is in service mode (e.g. during a simulation).
S <small>A0013958</small>	Out of specification The device is operated: <ul style="list-style-type: none"> ▪ Outside its technical specification limits (e.g. outside the process temperature range) ▪ Outside of the configuration carried out by the user (e.g. maximum flow in parameter 20 mA value)
M <small>A0013957</small>	Maintenance required Maintenance is required. The measured value remains valid.
N <small>A0023076</small>	Has no effect on the condensed status.

12.5 Overview of diagnostic information

 The amount of diagnostic information and the number of measured variables affected increase if the measuring device has one or more application packages.

 In the case of some items of diagnostic information, the status signal and the diagnostic behavior can be changed. Change the diagnostic information →  111

Diagnostic number	Short text	Remedy instructions	Status signal [from the factory]	Diagnostic behavior [from the factory]
Diagnostic of sensor				
022	Temperature sensor	1. Check temperature sensor cable 2. Change main electronic module 3. Change sensor	F	Alarm
082	Data storage	1. Change main electronic module 2. Change sensor	F	Alarm
083	Memory content	1. Restart device 2. Restore S-Dat data 3. Change sensor	F	Alarm
104	Sensor signal path 1 to 2	1. Check process conditions 2. Clean transducer 3. Change transducer	F	Alarm
105	Transducer	1. Check transducer 2 cable 2. Change transducer 2	F	Alarm
105	Transducer	1. Check transducer 3 cable 2. Change transducer 3	F	Alarm
105	Transducer	1. Check transducer 4 cable 2. Change transducer 4	F	Alarm
105	Transducer	1. Check transducer 1 cable 2. Change transducer 1	F	Alarm

Diagnostic number	Short text	Remedy instructions	Status signal [from the factory]	Diagnostic behavior [from the factory]
123	Predicted signal strength	1. Check parameterization in the 'Medium' menu 2. Check process conditions 3. Clean the transducer 4. Replace the transducer	M	Warning ¹⁾
124	Relative signal strength	1. Clean the transducer 2. Replace the transducer	M	Warning ¹⁾
125	Relative sound velocity	1. Clean the transducer 2. Replace the transducer	M	Warning ¹⁾
160	Signal path switched off	Contact service	M	Warning
Diagnostic of electronic				
242	Software incompatible	1. Check software 2. Flash or change main electronics module	F	Alarm
252	Modules incompatible	1. Check electronic modules 2. Change I/O or main electronic module	F	Alarm ¹⁾
261	Electronic modules	1. Restart device 2. Check electronic modules 3. Change I/O Modul or main electronics	F	Alarm
262	Module connection	1. Check module connections 2. Change electronic modules	F	Alarm
270	Main electronic failure	Change main electronic module	F	Alarm
271	Main electronic failure	1. Restart device 2. Change main electronic module	F	Alarm
272	Main electronic failure	1. Restart device 2. Contact service	F	Alarm
273	Main electronic failure	1. Emergency operation via display 2. Change main electronics	F	Alarm
275	I/O module failure	Change I/O module	F	Alarm
276	I/O module failure	1. Restart device 2. Change I/O module	F	Alarm
282	Data storage	1. Restart device 2. Contact service	F	Alarm
283	Memory content	1. Transfer data or reset device 2. Contact service	F	Alarm
302	Device verification active	Device verification active, please wait.	C	Warning
311	Electronic failure	1. Transfer data or reset device 2. Contact service	F	Alarm
311	Electronic failure	Maintenance required! 1. Do not perform reset 2. Contact service	M	Warning
384	Transmitter circuit	Change main electronic module	F	Alarm
385	Amplifier circuit	Change main electronic module	F	Alarm
386	Time of flight	Change main electronic module	F	Alarm
Diagnostic of configuration				
410	Data transfer	1. Check connection 2. Retry data transfer	F	Alarm

Diagnostic number	Short text	Remedy instructions	Status signal [from the factory]	Diagnostic behavior [from the factory]
412	Processing download	Download active, please wait	C	Warning
431	Trim 1 to 2	Carry out trim	C	Warning
437	Configuration incompatible	1. Restart device 2. Contact service	F	Alarm
438	Dataset	1. Check data set file 2. Check device configuration 3. Up- and download new configuration	M	Warning
441	Current output 1 to 2	1. Check process 2. Check current output settings	S	Warning ¹⁾
442	Frequency output	1. Check process 2. Check frequency output settings	S	Warning ¹⁾
443	Pulse output	1. Check process 2. Check pulse output settings	S	Warning ¹⁾
444	Current input 1	1. Check process 2. Check current input settings	S	Warning ¹⁾
452	Calculation error	1. Check device configuration 2. Check process conditions	S	Alarm ¹⁾
453	Flow override	Deactivate flow override	C	Warning
484	Simulation Failure Mode	Deactivate simulation	C	Alarm
485	Simulation measured variable	Deactivate simulation	C	Warning
486	Simulation current input 1	Deactivate simulation	C	Warning
491	Simulation current output 1 to 2	Deactivate simulation	C	Warning
492	Simulation frequency output	Deactivate simulation frequency output	C	Warning
493	Simulation pulse output	Deactivate simulation pulse output	C	Warning
494	Switch output simulation	Deactivate simulation switch output	C	Warning
495	Diagnostic event simulation	Deactivate simulation	C	Warning
Diagnostic of process				
801	Supply voltage too low	Increase supply voltage	S	Warning ¹⁾
803	Current loop	1. Check wiring 2. Change I/O module	F	Alarm
832	Electronic temperature too high	Reduce ambient temperature	S	Warning ¹⁾
833	Electronic temperature too low	Increase ambient temperature	S	Warning ¹⁾
834	Process temperature too high	Reduce process temperature	S	Warning ¹⁾
835	Process temperature too low	Increase process temperature	S	Warning ¹⁾
836	Process pressure	Reduce process pressure	S	Alarm
837	Process pressure	Increase process pressure	S	Warning ¹⁾



Diagnostic number	Short text	Remedy instructions	Status signal [from the factory]	Diagnostic behavior [from the factory]
841	Sensor range	Check flow velocity	S	Warning ¹⁾
842	Process limit	Low flow cut off active! 1. Check low flow cut off configuration	S	Warning
881	Sensor signal path 1 to 2	1. Check process conditions 2. Clean transducer 3. Change transducer	M	Warning ¹⁾
882	Input signal	1. Check input configuration 2. Check external device or process conditions	F	Alarm
930	Process fluid	Sound velocity too high! Check process conditions	S	Warning
931	Process fluid	Sound velocity too low! Check process conditions	S	Warning



1) Diagnostic behavior can be changed.

12.6 Pending diagnostic events

The **Diagnostics** menu allows the user to view the current diagnostic event and the previous diagnostic event separately.

 To call up the measures to rectify a diagnostic event:

- Via local display →  109
- Via "FieldCare" operating tool →  111

 Other pending diagnostic events can be displayed in the **Diagnostic list** submenu →  116

Navigation

"Diagnostics" menu

Structure of the submenu

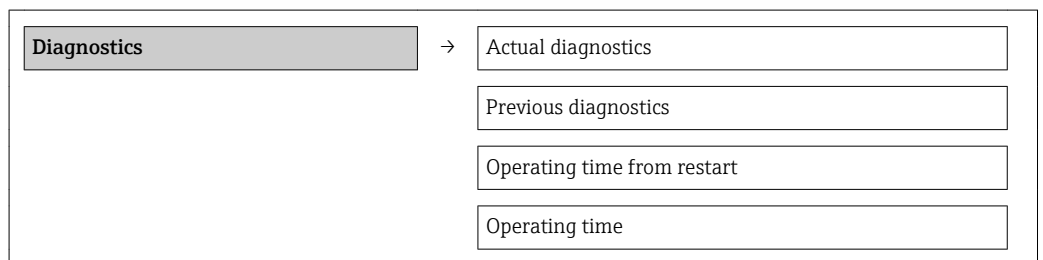

Parameter overview with brief description

Parameter	Prerequisite	Description	User interface
Actual diagnostics	A diagnostic event has occurred.	Shows the current occurred diagnostic event along with its diagnostic information.  If two or more messages occur simultaneously, the message with the highest priority is shown on the display.	Symbol for diagnostic behavior, diagnostic code and short message.
Previous diagnostics	Two diagnostic events have already occurred.	Shows the diagnostic event that occurred prior to the current diagnostic event along with its diagnostic information.	Symbol for diagnostic behavior, diagnostic code and short message.
Operating time from restart	–	Shows the time the device has been in operation since the last device restart.	Days (d), hours (h), minutes (m) and seconds (s)
Operating time	–	Indicates how long the device has been in operation.	Days (d), hours (h), minutes (m) and seconds (s)

12.7 Diagnostic list

In the **Diagnostic list** submenu, up to 5 currently pending diagnostic events can be displayed along with the related diagnostic information. If more than 5 diagnostic events are pending, the events with the highest priority are shown on the display.

Navigation path

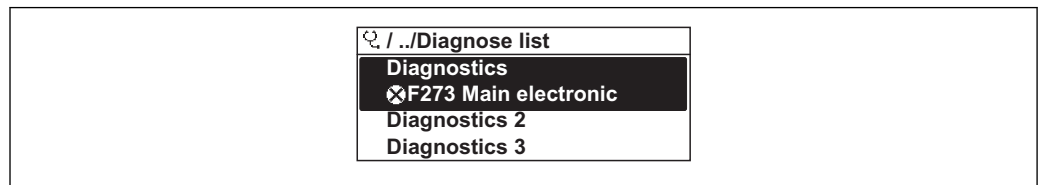

Diagnostics menu → **Diagnostic list** submenu



A0014006-EN

 32 Illustrated using the example of the local display

 To call up the measures to rectify a diagnostic event:

- Via local display →  109
- Via "FieldCare" operating tool →  111

12.8 Event logbook

12.8.1 Event history

A chronological overview of the event messages that have occurred is provided in the **Events list** submenu.

Navigation path

"Diagnostics" menu → Event logbook → Events list

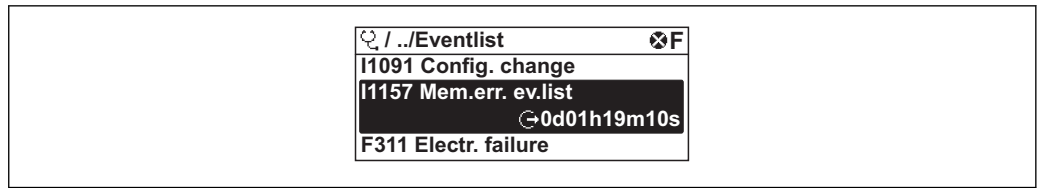

A0014008-EN

33 Illustrated using the example of the local display

A maximum of 20 event messages can be displayed in chronological order. If the advanced HistoROM function is enabled in the device (order option), up to 100 entries can be displayed.

The event history includes entries for:

- Diagnostic events → 112
- Information events → 117

In addition to the operation time of its occurrence, each event is also assigned a symbol that indicates whether the event has occurred or is ended:

- Diagnostic event
 - ⌚: Event has occurred
 - ⌚: Event has ended
- Information event
 - ⌚: Event has occurred

i To call up the measures to rectify a diagnostic event:

- Via local display → 109
- Via "FieldCare" operating tool → 111

i For filtering the displayed event messages → 117

12.8.2 Filtering the event logbook

Using the **Filter options** parameter, you can define which category of event messages is displayed in the **Events list** submenu.

Navigation path

"Diagnostics" menu → Event logbook → Filter options

Filter categories

- All
- Failure (F)
- Function check (C)
- Out of specification (S)
- Maintenance required (M)
- Information (I)

12.8.3 Overview of information events

Unlike a diagnostic event, an information event is displayed in the event logbook only and not in the diagnostic list.

Info number	Info name
I1000	----- (Device ok)
I1079	Sensor changed
I1089	Power on
I1090	Configuration reset
I1091	Configuration changed
I1092	Trend data deleted

Info number	Info name
I1110	Write protection switch changed
I1137	Electronic changed
I1151	History reset
I1154	Reset terminal voltage min/max
I1155	Reset electronic temperature
I1156	Memory error trend
I1157	Memory error event list
I1185	Display backup done
I1186	Restore via display done
I1187	Settings downloaded with display
I1188	Display data cleared
I1189	Backup compared
I1222	Zero point adjustment ok
I1227	Sensor emergency mode activated
I1228	Sensor emergency mode failed
I1256	Display: access status changed
I1264	Safety sequence aborted
I1327	Zero point adjust failed signal path
I1335	Firmware changed
I1397	Fieldbus: access status changed
I1398	CDI: access status changed
I1440	Main electronic module changed
I1442	I/O module changed
I1444	Device verification passed
I1445	Device verification failed
I1457	Measured error verification failed
I1459	I/O module verification failed
I1461	Sensor verification failed
I1462	Sensor electronic module verific. failed
I1512	Download started
I1513	Download finished
I1514	Upload started
I1515	Upload finished
I1552	Failed: Main electronic verification
I1554	Safety sequence started
I1555	Safety sequence confirmed
I1556	Safety mode off
I1647	Device verification not executable

12.9 Resetting the measuring device

Using the **Device reset** parameter it is possible to reset the entire device configuration or some of the configuration to a defined state.

Navigation

"Setup" menu → Advanced setup → Administration → Device reset

The screenshot shows a menu structure starting with 'Administration'. Under 'Administration', there is an option 'Define access code'. Below this, there are two input fields labeled 'Define access code' and 'Confirm access code'. At the bottom of the menu, there is an option 'Device reset'.

Parameter overview with brief description

Parameter	Description	Selection	Factory setting
Device reset	Reset the device configuration - either entirely or in part - to a defined state.	<ul style="list-style-type: none"> ▪ Cancel ▪ To factory defaults ▪ To delivery settings ▪ Restart device 	Cancel

12.9.1 Function scope of the "Device reset" parameter

Options	Description
Cancel	No action is executed and the user exits the parameter.
To delivery settings	Every parameter for which a customer-specific default setting was ordered is reset to this customer-specific value. All other parameters are reset to the factory setting.
Restart device	The restart resets every parameter whose data are in the volatile memory (RAM) to the factory setting (e.g. measured value data). The device configuration remains unchanged.
History reset	Every parameter is reset to its factory setting.

12.10 Device information

The **Device information** submenu contains all the parameters that display different information for identifying the device.





Navigation

"Diagnostics" menu → Device information

The screenshot shows a menu starting with 'Device information'. Below this, there are three options: 'Device tag', 'Serial number', and 'Firmware version'.

Device name
Order code
Extended order code 1
Extended order code 2
Extended order code 3
ENP version
Device revision
Device ID
Device type
Manufacturer ID

Parameter overview with brief description

Parameter	Description	User interface	Factory setting
Device tag	Enter the name for the measuring point.	Max. 32 characters such as letters, numbers or special characters (e.g. @, %, /)	Prosonic Flow
Serial number	Shows the serial number of the measuring device.	Max. 11-digit character string comprising letters and numbers.	–
Firmware version	Shows the device firmware version installed.	Character string with the following format: xx.yy.zz	01.02
Device name	Shows the name of the transmitter.  The name can be found on the nameplate of the transmitter.	Pros. Flow B 200	–
Order code	Shows the device order code.  The order code can be found on the nameplate of the sensor and transmitter in the "Order code" field.	Character string composed of letters, numbers and certain punctuation marks (e.g. /).	–
Extended order code 1	Shows the 1st part of the extended order code.  The extended order code can also be found on the nameplate of the sensor and transmitter in the "Ext. ord. cd." field.	Character string	–
Extended order code 2	Shows the 2nd part of the extended order code.  The extended order code can also be found on the nameplate of the sensor and transmitter in the "Ext. ord. cd." field.	Character string	–

Parameter	Description	User interface	Factory setting
Extended order code 3	Shows the 3rd part of the extended order code.  The extended order code can also be found on the nameplate of the sensor and transmitter in the "Ext. ord. cd." field.	Character string	–
ENP version	Shows the version of the electronic nameplate (ENP).		2.02.00
Device revision	Shows the device revision with which the device is registered with the HART Communication Foundation.	2-digit hexadecimal number	0x03
Device ID	Shows the device ID for identifying the device in a HART network.	6-digit hexadecimal number	–
Device type	Displays the device type with which the measuring device is registered with the HART Communication Foundation.	0 to 255	0x5A
Manufacturer ID	Displays the manufacturer ID with which the measuring device is registered with the HART Communication Foundation.	0 to 255	0x11

12.11 Firmware history

Release date	Firmware version	Order code for "Firmware version"	Firmware changes	Documentation type	Documentation
07.2015	01.02.zz	Option 75	In accordance with HART 7 Specification	Operating Instructions	BA01031D/06/EN/03.15
11.2012	01.01.zz	Option 76	<ul style="list-style-type: none"> ▪ Local display with backlighting. ▪ Integrated additional operating languages: Russian, Swedish ▪ New options for order code for "Output": <ul style="list-style-type: none"> – 4-20 mA HART – 4-20 mA HART, pulse/frequency/switch output ▪ New wizard: Pulse/frequency/switch output ▪ Extension for Medium selection: In the Pressure compensation parameter, the "External gauge pressure" option has been added to the list of options available for selection. ▪ Extension for HART input: New "Failure mode" parameter. ▪ Additional measured variable: Mass flow 	Operating Instructions	BA01031D/06/EN/02.12
01.2011	01.00.zz	Option 78	Original firmware	Operating Instructions	BA01031D/06/EN/01.11

 Flashing the firmware to the current version or to the previous version is possible via the service interface (CDI) .

 For the compatibility of the firmware version with the previous version, the installed device description files and operating tools, observe the information about the device in the "Manufacturer's information" document.

 The manufacturer's information is available:

- In the Download Area of the Endress+Hauser Internet site: www.endress.com → Download
- Specify the following details:
 - Product root: e.g. 9B2B
 - Text search: Manufacturer's information
 - Search range: documentation

13 Maintenance

13.1 Maintenance tasks

No special maintenance work is required.

13.1.1 Exterior cleaning

When cleaning the exterior of measuring devices, always use cleaning agents that do not attack the surface of the housing or the seals.

13.2 Measuring and test equipment

Endress+Hauser offers a wide variety of measuring and test equipment, such as W@M or device tests.

 Your Endress+Hauser Sales Center can provide detailed information on the services.

 For a list of some of the measuring and test equipment, refer to the "Accessories" chapter of the "Technical Information" document for the device.

13.3 Endress+Hauser services

Endress+Hauser offers a wide variety of services for maintenance such as recalibration, maintenance service or device tests.

 Your Endress+Hauser Sales Center can provide detailed information on the services.

14 Repair

14.1 General notes

Repair and conversion concept

The Endress+Hauser repair and conversion concept provides for the following:

- The measuring devices have a modular design.
- Spare parts are grouped into logical kits with the associated Installation Instructions.
- Repairs are carried out by Endress+Hauser Service or by correspondingly trained customers.
- Certified devices can be converted into other certified devices by Endress+Hauser Service or at the factory only.

Notes for repair and conversion

For repair and modification of a measuring device, observe the following notes:

- Use only original Endress+Hauser spare parts.
- Carry out the repair according to the Installation Instructions.
- Observe the applicable standards, federal/national regulations, Ex documentation (XA) and certificates.
- Document every repair and each conversion and enter them into the *W@M* life cycle management database.

14.2 Spare parts

Some interchangeable measuring device components are listed on an overview sign in the connection compartment cover.

The spare part overview sign contains the following information:

- A list of the most important spare parts for the measuring device, including their ordering information.
- The URL for the *W@M Device Viewer* (www.endress.com/deviceviewer):
All the spare parts for the measuring device, along with the order code, are listed here and can be ordered. If available, users can also download the associated Installation Instructions.

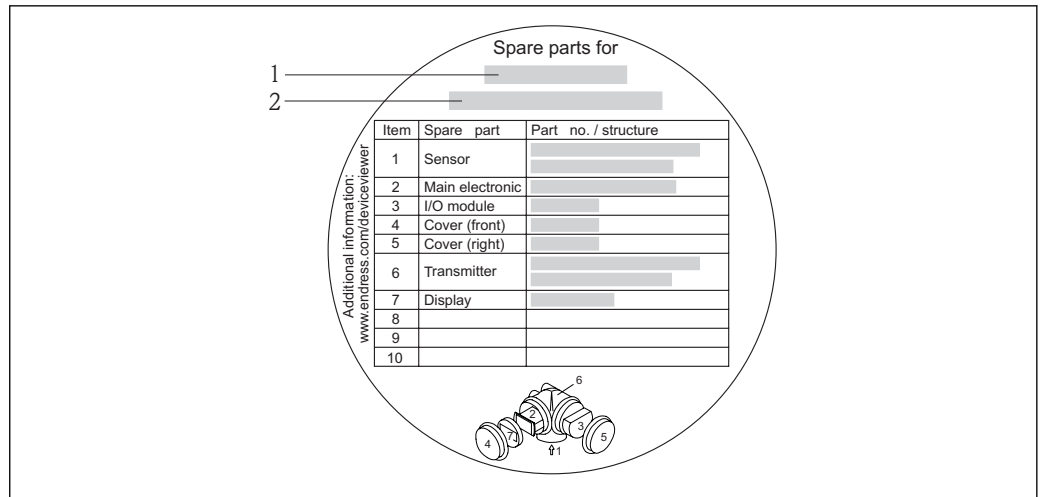

34 Example for "Spare part overview sign" in connection compartment cover

- 1 Measuring device name
- 2 Measuring device serial number

- i** Measuring device serial number:
- Is located on the device nameplate and the spare part overview sign.
 - Can be read out via the **Serial number** parameter in the **Device information** submenu → 119.

14.3 Endress+Hauser services

- i** Contact your Endress+Hauser Sales Center for information on services and spare parts.

14.4 Return

The measuring device must be returned if it is need of repair or a factory calibration, or if the wrong measuring device has been delivered or ordered. Legal specifications require Endress+Hauser, as an ISO-certified company, to follow certain procedures when handling products that are in contact with the medium.

To ensure safe, swift and professional device returns, please refer to the procedure and conditions for returning devices provided on the Endress+Hauser website at <http://www.endress.com/support/return-material>

14.5 Disposal

14.5.1 Removing the measuring device

1. Switch off the device.
2. **⚠ WARNING**

Danger to persons from process conditions.

- ▶ Beware of hazardous process conditions such as pressure in the measuring device, high temperatures or aggressive fluids.

Carry out the mounting and connection steps from the chapters "Mounting the measuring device" and "Connecting the measuring device" in the logically reverse sequence. Observe the safety instructions.

14.5.2 Disposing of the measuring device

⚠ WARNING

Danger to personnel and environment from fluids that are hazardous to health.

- ▶ Ensure that the measuring device and all cavities are free of fluid residues that are hazardous to health or the environment, e.g. substances that have permeated into crevices or diffused through plastic.

Observe the following notes during disposal:





- Observe valid federal/national regulations.
- Ensure proper separation and reuse of the device components.

15 Accessories

Various accessories, which can be ordered with the device or subsequently from Endress+Hauser, are available for the device. Detailed information on the order code in question is available from your local Endress+Hauser sales center or on the product page of the Endress+Hauser website: www.endress.com.

15.1 Device-specific accessories









15.1.1 For the transmitter

Accessories	Description
Prosonic Flow 200 transmitter	<p>Transmitter for replacement or storage. Use the order code to define the following specifications:</p> <ul style="list-style-type: none"> ▪ Approvals ▪ Output ▪ Display / operation ▪ Housing ▪ Software <p> For details, see Installation Instructions EA00104D</p>
Remote display FHX50	<p>FHX50 housing to accommodate a display module →  145.</p> <ul style="list-style-type: none"> ▪ FHX50 housing suitable for: <ul style="list-style-type: none"> – SD02 display module (push buttons) – SD03 display module (touch control) ▪ Housing material: <ul style="list-style-type: none"> – Plastic PBT – Stainless steel CF-3M (316L, 1.4404) ▪ Length of connecting cable: up to max. 60 m (196 ft) (cable lengths available for order: 5 m (16 ft), 10 m (32 ft), 20 m (65 ft), 30 m (98 ft)) <p>The measuring device can be ordered with the FHX50 housing and a display module. The following options must be selected in the separate order codes:</p> <ul style="list-style-type: none"> ▪ Order code for measuring device, feature 030: <ul style="list-style-type: none"> Option L or M "Prepared for FHX50 display" ▪ Order code for FHX50 housing, feature 050 (device version): <ul style="list-style-type: none"> Option A "Prepared for FHX50 display" ▪ Order code for FHX50 housing, depends on the desired display module in feature 020 (display, operation): <ul style="list-style-type: none"> – Option C: for an SD02 display module (push buttons) – Option E: for an SD03 display module (touch control) <p>The FHX50 housing can also be ordered as a retrofit kit. The measuring device display module is used in the FHX50 housing. The following options must be selected in the order code for the FHX50 housing:</p> <ul style="list-style-type: none"> ▪ Feature 050 (measuring device version): option B "Not prepared for FHX50 display" ▪ Feature 020 (display, operation): option A "None, existing displayed used" <p> For details, see Special Documentation SD01007F</p>
Overvoltage protection for 2-wire devices	<p>Ideally, the overvoltage protection module should be ordered directly with the device. See product structure, characteristic 610 "Accessory mounted", option NA "Overvoltage protection". Separate order necessary only if retrofitting.</p> <ul style="list-style-type: none"> ▪ OVP10: For 1-channel devices (characteristic 020, option A): ▪ OVP20: For 2-channel devices (characteristic 020, options B, C, E or G) <p> For details, see Special Documentation SD01090F.</p>
Weather protection cover	<p>Is used to protect the measuring device from the effects of the weather: e.g. rainwater, excess heating from direct sunlight or extreme cold in winter.</p> <p> For details, see Special Documentation SD00333F</p>

15.1.2 For the sensor

Accessories	Description
Replacement tool	Is used to remove the converters on the fly for cleaning or replacement purposes.  For details, see Installation Instructions EA00108D
Flow conditioner	Is used to shorten the necessary inlet run.





15.2 Communication-specific accessories

Accessories	Description
Commubox FXA195 HART	For intrinsically safe HART communication with FieldCare via the USB interface.  For details, see "Technical Information" TI00404F
Commubox FXA291	Connects Endress+Hauser field devices with a CDI interface (= Endress+Hauser Common Data Interface) and the USB port of a computer or laptop.  For details, see the "Technical Information" document TI405C/07
HART Loop Converter HMX50	Is used to evaluate and convert dynamic HART process variables to analog current signals or limit values.  For details, see "Technical Information" TI00429F and Operating Instructions BA00371F
Wireless HART adapter SWA70	Is used for the wireless connection of field devices. The WirelessHART adapter can be easily integrated into field devices and existing infrastructures, offers data protection and transmission safety and can be operated in parallel with other wireless networks with minimum cabling complexity.  For details, see Operating Instructions BA00061S
Fieldgate FXA320	Gateway for the remote monitoring of connected 4-20 mA measuring devices via a Web browser.  For details, see "Technical Information" TI00025S and Operating Instructions BA00053S
Fieldgate FXA520	Gateway for the remote diagnostics and remote configuration of connected HART measuring devices via a Web browser.  For details, see "Technical Information" TI00025S and Operating Instructions BA00051S
Field Xpert SFX350	Field Xpert SFX350 is a mobile computer for commissioning and maintenance. It enables efficient device configuration and diagnostics for HART and FOUNDATION Fieldbus devices in the non-Ex area .  For details, see Operating Instructions BA01202S
Field Xpert SFX370	Field Xpert SFX370 is a mobile computer for commissioning and maintenance. It enables efficient device configuration and diagnostics for HART and FOUNDATION Fieldbus devices in the non-Ex area and the Ex area .  For details, see Operating Instructions BA01202S

15.3 Service-specific accessories

Accessories	Description
Applicator	<p>Software for selecting and sizing Endress+Hauser measuring devices:</p> <ul style="list-style-type: none"> Calculation of all the necessary data for identifying the optimum flowmeter: e.g. nominal diameter, pressure loss, accuracy or process connections. Graphic illustration of the calculation results <p>Administration, documentation and access to all project-related data and parameters throughout the entire life cycle of a project.</p> <p>Applicator is available:</p> <ul style="list-style-type: none"> Via the Internet: https://wapps.endress.com/applicator On CD-ROM for local PC installation.
W@M	<p>Life cycle management for your plant</p> <p>W@M supports you with a wide range of software applications over the entire process: from planning and procurement, to the installation, commissioning and operation of the measuring devices. All the relevant device information, such as the device status, spare parts and device-specific documentation, is available for every device over the entire life cycle.</p> <p>The application already contains the data of your Endress+Hauser device. Endress+Hauser also takes care of maintaining and updating the data records.</p> <p>W@M is available:</p> <ul style="list-style-type: none"> Via the Internet: www.endress.com/lifecyclemanagement On CD-ROM for local PC installation.
FieldCare	<p>FDT-based plant asset management tool from Endress+Hauser.</p> <p>It can configure all smart field units in your system and helps you manage them. By using the status information, it is also a simple but effective way of checking their status and condition.</p> <p> For details, see Operating Instructions BA00027S and BA00059S</p>

15.4 System components

Accessories	Description
Memograph M graphic display recorder	<p>The Memograph M graphic display recorder provides information on all relevant measured variables. Measured values are recorded correctly, limit values are monitored and measuring points analyzed. The data are stored in the 256 MB internal memory and also on a SD card or USB stick.</p> <p> For details, see "Technical Information" TI00133R and Operating Instructions BA00247R</p>
RN221N	<p>Active barrier with power supply for safe separation of 4-20 mA standard signal circuits. Offers bidirectional HART transmission.</p> <p> For details, see "Technical Information" TI00073R and Operating Instructions BA00202R</p>
RNS221	<p>Supply unit for powering two 2-wire measuring devices solely in the non-Ex area. Bidirectional communication is possible via the HART communication jacks.</p> <p> For details, see "Technical Information" TI00081R and Brief Operating Instructions KA00110R</p>
Cerabar M	<p>The pressure transmitter for measuring the absolute and gauge pressure of gases, steam and liquids. It can be used to read in the operating pressure value.</p> <p> For details, see "Technical Information" TI00426P, TI00436P and Operating Instructions BA00200P, BA00382P</p>
Cerabar S	<p>The pressure transmitter for measuring the absolute and gauge pressure of gases, steam and liquids. It can be used to read in the operating pressure value.</p> <p> For details, see "Technical Information" TI00383P and Operating Instructions BA00271P</p>

16 Technical data

16.1 Application

The measuring device is suitable for flow measurement of gases only.

Depending on the version ordered, the measuring device can also measure potentially explosive, flammable, poisonous and oxidizing media.

To ensure that the device remains in proper operating condition for its service life, use the measuring device only for media against which the process-wetted materials are adequately resistant.

16.2 Function and system design

Measuring principle Proline Prosonic Flow uses a measurement method based on the transit time difference.

Measuring system The device consists of a transmitter and a sensor.
 The device is available as a compact version:
 The transmitter and sensor form a mechanical unit.
 For information on the structure of the device →  12

16.3 Input

Measured variable **Direct measured variables**
 Volume flow

Calculated measured variables

- Corrected volume flow
- Mass flow

Optional measured variables (can be ordered)

Order code for "Sensor version", option 2 "Volume flow + Biogas analysis"

- Corrected methane volume flow
- Energy flow
- Methane fraction
- Gross calorific value
- Wobbe index
- Temperature

Measuring range *Standard (order code for "Calibration flow", option 1 "Operable flow range 30 : 1")*

Nominal diameter		Velocity		Effective volume flow	
[mm]	[in]	[m/s]	[ft/s]	[m ³ /h]	[ft ³ /h]
50	2	1 to 30	3.28 to 98.4	9 to 269	316 to 9495
80	3	1 to 30	3.28 to 98.4	20 to 611	720 to 21 592
100	4	1 to 30	3.28 to 98.4	34 to 1032	1215 to 36 443

Nominal diameter		Velocity		Effective volume flow	
[mm]	[in]	[m/s]	[ft/s]	[m ³ /h]	[ft ³ /h]
150	6	1 to 30	3.28 to 98.4	76 to 2 290	2 695 to 80 862
200	8	1 to 30	3.28 to 98.4	131 to 3 925	4 620 to 138 596

Optional (order code for "Calibration flow", option 2 "Operable flow range 100 : 1")

Nominal diameter		Velocity		Effective volume flow	
[mm]	[in]	[m/s]	[ft/s]	[m ³ /h]	[ft ³ /h]
50	2	0.3 to 30	0.98 to 98.4	3 to 269	95 to 9 495
80	3	0.3 to 30	0.98 to 98.4	6 to 611	215 to 21 592
100	4	0.3 to 30	0.98 to 98.4	11 to 1 032	363 to 36 443
150	6	0.3 to 30	0.98 to 98.4	25 to 2 290	805 to 80 862
200	8	0.3 to 30	0.98 to 98.4	43 to 3 925	1 365 to 138 596

The values in the table should be regarded as reference values.

Recommended measuring range

"Flow limit" section →  139

Operable flow range

- 30 : 1 (standard; order code for "Calibration Flow", option 1 "Operable flow range 30 : 1")
- 100 : 1 (optional; order code for "Calibration Flow", option 2 "Operable flow range 100 : 1")

Flow rates above the preset full scale value do not overload the amplifier so the totalized values are registered correctly.



Input signal

Current input

Current input	4-20 mA (passive)
Resolution	1 µA
Voltage drop	Typically: 2.2 to 3 V for 3.6 to 22 mA
Maximum voltage	≤35 V
Possible input variables	Pressure

External measured values

To increase the accuracy of certain measured variables, the automation system can continuously write the operating pressure to the measuring device. Endress+Hauser recommends the use of a pressure measuring device for absolute pressure, e.g. Cerabar M or Cerabar S

 Various pressure transmitters can be ordered from Endress+Hauser: see "Accessories" section →  129

It is recommended to read in external measured values to calculate the following measured variables:

- Energy flow
- Mass flow
- Corrected volume flow
- Corrected methane volume flow

Current input

The measured values are written from the automation system to the measuring device via the current input → 131.

HART protocol

The measured values are written from the automation system to the measuring device via the HART protocol. The pressure transmitter must support the following protocol-specific functions:

- HART protocol
- Burst mode

16.4 Output

Output signal

Current output

Current output 1	4-20 mA HART (passive)
Current output 2	4-20 mA (passive)
Resolution	< 1 µA
Damping	Adjustable: 0.0 to 999.9 s
Assignable measured variables	<ul style="list-style-type: none"> ▪ Volume flow ▪ Corrected volume flow ▪ Corrected methane volume flow ▪ Mass flow ▪ Energy flow ▪ Methane fraction ▪ Calorific value ▪ Wobbe index ▪ Temperature

Pulse/frequency/switch output

Function	Can be set to pulse, frequency or switch output
Version	Passive, open collector
Maximum input values	<ul style="list-style-type: none"> ▪ DC 35 V ▪ 50 mA
Voltage drop	<ul style="list-style-type: none"> ▪ For ≤ 2 mA: 2 V ▪ For 10 mA: 8 V
Residual current	≤ 0.05 mA
Pulse output	
Pulse width	Adjustable: 5 to 2 000 ms
Maximum pulse rate	100 Impulse/s
Pulse value	Adjustable
Assignable measured variables	<ul style="list-style-type: none"> ▪ Volume flow ▪ Corrected volume flow ▪ Corrected methane volume flow ▪ Mass flow ▪ Energy flow
Frequency output	
Output frequency	Adjustable: 0 to 1 000 Hz
Damping	Adjustable: 0 to 999 s
Pulse/pause ratio	1:1

Assignable measured variables	<ul style="list-style-type: none"> ■ Volume flow ■ Corrected volume flow ■ Corrected methane volume flow ■ Mass flow ■ Energy flow ■ Methane fraction ■ Calorific value ■ Wobbe index ■ Temperature
Switch output	
Switching behavior	Binary, conductive or non-conductive
Switching delay	Adjustable: 0 to 100 s
Number of switching cycles	Unlimited
Assignable functions	<ul style="list-style-type: none"> ■ Off ■ On ■ Diagnostic behavior ■ Limit value <ul style="list-style-type: none"> - Volume flow - Corrected volume flow - Corrected methane volume flow - Mass flow - Energy flow - Methane fraction - Calorific value - Wobbe index - Temperature - Totalizer 1 to 3 ■ Flow direction monitoring ■ Status <ul style="list-style-type: none"> Low flow cut off

Signal on alarm

Depending on the interface, failure information is displayed as follows:

Current output

4-20 mA

Failure mode	Selectable (as per NAMUR recommendation NE 43): <ul style="list-style-type: none"> ■ Minimum value: 3.6 mA ■ Maximum value: 22 mA ■ Defined value: 3.59 to 22.5 mA ■ Actual value ■ Last valid value
---------------------	---

HART

Device diagnostics	Device condition can be read out via HART Command 48
---------------------------	--

Pulse/frequency/switch output

Pulse output

Failure mode	Choose from: <ul style="list-style-type: none"> ■ Actual value ■ No pulses
---------------------	--

Frequency output

Failure mode	Choose from: <ul style="list-style-type: none"> ■ Actual value ■ 0 Hz ■ Defined value: 0 to 1250 Hz
---------------------	--

Switch output

Failure mode	Choose from: <ul style="list-style-type: none"> ■ Current status ■ Open ■ Closed
---------------------	---

Local display

Plain text display	With information on cause and remedial measures
Backlight	Additionally for device version with SD03 local display: red lighting indicates a device error.

 Status signal as per NAMUR recommendation NE 107

Operating tool

- Via digital communication:
 - HART protocol
- Via service interface



Plain text display	With information on cause and remedial measures
---------------------------	---

Load →  26

Low flow cut off The switch points for low flow cut off are user-selectable.

Galvanic isolation All outputs are galvanically isolated from one another.

Protocol-specific data **HART**

- For information on the device description files →  52
- For information on the dynamic variables and measured variables (HART device variables) →  52

16.5 Power supply

Terminal assignment →  25

Supply voltage **Transmitter**

An external power supply is required for each output.

The following supply voltage values apply for the outputs available:

Order code for "Output"	Minimum terminal voltage	Maximum terminal voltage
Option A ^{1) 2)} : 4-20 mA HART	<ul style="list-style-type: none"> ■ For 4 mA: ≥ DC 16 V ■ For 20 mA: ≥ DC 12 V 	DC 35 V
Option B : 4-20 mA HART, pulse/frequency/switch output	<ul style="list-style-type: none"> ■ For 4 mA: ≥ DC 16 V ■ For 20 mA: ≥ DC 12 V 	DC 35 V
Option C : 4-20 mA HART + 4-20 mA analog	<ul style="list-style-type: none"> ■ For 4 mA: ≥ DC 16 V ■ For 20 mA: ≥ DC 12 V 	DC 30 V
Option D : 4-20 mA HART, pulse/frequency/switch output, 4-20 mA current input ³⁾	≥ DC 12 V	DC 35 V

- 1) External supply voltage of the power supply unit with load.
- 2) For device versions with SD03 local display: The terminal voltage must be increased by DC 2 V if backlighting is used.
- 3) Voltage drop 2.2 to 3 V for 3.59 to 22 mA

Power consumption

Transmitter

Order code for "Output"	Maximum power consumption
Option A : 4-20 mA HART	770 mW
Option B : 4-20 mA HART, pulse/frequency/switch output	<ul style="list-style-type: none"> ■ Operation with output 1: 770 mW ■ Operation with output 1 and 2: 2 770 mW
Option C : 4-20 mA HART + 4-20 mA analog	<ul style="list-style-type: none"> ■ Operation with output 1: 660 mW ■ Operation with output 1 and 2: 1 320 mW
Option D : 4-20 mA HART, pulse/frequency/switch output, 4-20 mA current input	<ul style="list-style-type: none"> ■ Operation with output 1: 770 mW ■ Operation with output 1 and 2: 2770 mW ■ Operation with output 1 and input: 840 mW ■ Operation with output 1, 2 and input: 2840 mW

Current consumption

Current output

For every 4-20 mA or 4-20 mA HART current output: 3.6 to 22.5 mA

 If the option **Defined value** is selected in the **Failure mode** parameter : 3.59 to 22.5 mA

Current input

3.59 to 22.5 mA

 Internal current limiting: max. 26 mA

Power supply failure

- Totalizers stop at the last value measured.
- Configuration is retained in the device memory (HistoROM).
- Error messages (incl. total operated hours) are stored.

Electrical connection

→  27

Terminals

- For device version without integrated overvoltage protection: plug-in spring terminals for wire cross-sections 0.5 to 2.5 mm² (20 to 14 AWG)
- For device version with integrated overvoltage protection: screw terminals for wire cross-sections 0.2 to 2.5 mm² (24 to 14 AWG)

- Cable entries
- Cable gland: M20 × 1.5 with cable ϕ 6 to 12 mm (0.24 to 0.47 in)
 - Thread for cable entry:
 - NPT 1/2"
 - G 1/2"

Cable specification →  24

Overvoltage protection The device can be ordered with integrated overvoltage protection for diverse approvals:
Order code for "Accessory mounted", option NA "Overvoltage protection"

Input voltage range	Values correspond to supply voltage specifications ¹⁾
Resistance per channel	2 · 0.5 Ω max
DC sparkover voltage	400 to 700 V
Trip surge voltage	< 800 V
Capacitance at 1 MHz	< 1.5 pF
Nominal discharge current (8/20 μs)	10 kA
Temperature range	–40 to +85 °C (–40 to +185 °F)

1) The voltage is reduced by the amount of the internal resistance $I_{min} \cdot R_i$

 Depending on the temperature class, restrictions apply to the ambient temperature for device versions with overvoltage protection .

 For detailed information on the temperature tables, see the separate document entitled "Safety Instructions" (XA) for the device.

16.6 Performance characteristics

- Reference operating conditions
- Error limits following ISO/DIS 11631
 - Calibration gas: air
 - Temperature regulated to 24 ± 0.5 °C (75.2 ± 0.9 °F) under atmospheric pressure
 - Humidity regulated to <40% RH
 - Accuracy based on accredited calibration rigs that are traced to ISO 17025.

Maximum measured error o.r. = of reading; o.f.s. = of full scale value; abs. = absolute; T = medium temperature

Volume flow

Standard Order code for "Calibration flow", option 1 "Operable flow range 30 : 1"	<ul style="list-style-type: none"> ■ ± 1.5 % o.r. for 3 to 30 m/s (9.84 to 98.4 ft/s) ■ ± 3 % o.r. for 1 to 3 m/s (3.28 to 9.84 ft/s)
Optional Order code for "Calibration flow", option 2 "Operable flow range 100 : 1"	<ul style="list-style-type: none"> ■ ± 0.1 % o.f.s. for 0.3 to 1 m/s (0.98 to 3.28 ft/s) ■ ± 1.5 % o.r. for 1 to 30 m/s (3.28 to 98.4 ft/s)

Methane

± 2 % o.f.s. = ± 2 % abs.

Temperature

± 0.6 % $\pm 0.005 \cdot T$ °C (± 0.9 °F $\pm 0.005 \cdot (T - 32)$ °F)

Example for max. measured error (volume flow)

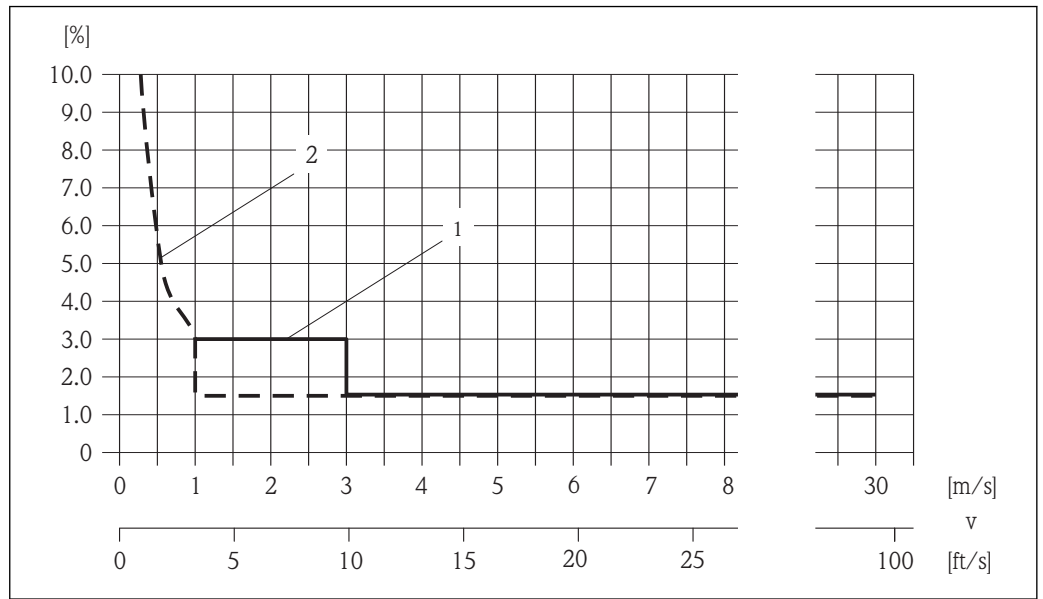

35 Example for max. measured error (volume flow) in % o.r.

- 1 Standard (order code for "Calibration flow", option 1 "Operable flow range 30 : 1")
- 2 Optional (order code for "Calibration flow", option 2 "Operable flow range 100 : 1")

Accuracy of outputs

o.r. = of reading

The outputs have the following base accuracy specifications.

Current output

Accuracy	±10 µA
-----------------	--------

Pulse/frequency output

Accuracy	Max. ±100 ppm o.r.
-----------------	--------------------

Repeatability o.r. = of reading; o.f.s. = of full scale value; abs. = absolute; T = medium temperature

Volume flow

±0.5 % o.r.

Methane

±0.5 % o.f.s. = ±0.5 % abs.

Temperature

±0.3 °C ± 0.0025 × T °C (±0.45 °F ± 0.0025 × (T - 32) °F)

Response time

- The response time depends on the configuration (damping).
- Response time in the event of erratic changes in the flow: after 1 000 ms 95% of the full scale value.

Influence of ambient temperature o.r. = of reading

Current output

Additional error, in relation to the span of 16 mA:

Temperature coefficient at zero point (4 mA)	0.02 %/10 K
Temperature coefficient with span (20 mA)	0.05 %/10 K

Pulse/frequency output

Temperature coefficient	Max. ±100 ppm o.r.
-------------------------	--------------------

16.7 Installation

"Mounting requirements" →  18

16.8 Environment

Ambient temperature range	Transmitter	-40 to +60 °C (-40 to +140 °F)
	Local display	-20 to +60 °C (-4 to +140 °F), the readability of the display may be impaired at temperatures outside the temperature range.
	Sensor	<ul style="list-style-type: none"> ■ Flange material carbon steel: -10 to +60 °C (+14 to +140 °F) ■ Flange material stainless steel: -40 to +60 °C (-40 to +140 °F) ■ Version without flange: -40 to +60 °C (-40 to +140 °F)

- ▶ If operating outdoors:
Avoid direct sunlight, particularly in warm climatic regions.

Storage temperature	All components apart from the display modules: -40 to +80 °C (-40 to +176 °F), preferably at +20 °C (+68 °F)
---------------------	---

Display modules
-40 to +80 °C (-40 to +176 °F)

Degree of protection	<p>Transmitter</p> <ul style="list-style-type: none"> ■ As standard: IP66/67, type 4X enclosure ■ When housing is open: IP20, type 1 enclosure ■ Display module: IP20, type 1 enclosure <p>Sensor IP66/67, type 4X enclosure</p>
----------------------	---

Shock resistance	In accordance with EN 60721-3-4
------------------	---------------------------------



Vibration resistance	Class 4M4, in accordance with EN 60721-3-4
----------------------	--

Electromagnetic compatibility (EMC)	<ul style="list-style-type: none"> ■ As per IEC/EN 61326 and NAMUR Recommendation 21 (NE 21) ■ Complies with emission limits for industry as per EN 55011 <p> For details, refer to the Declaration of Conformity.</p>
-------------------------------------	---

16.9 Process

Medium temperature range	<p>Sensor 0 to +80 °C (+32 to +176 °F)</p>
--------------------------	---

Pressure-temperature ratings	<p> An overview of the pressure-temperature ratings for the process connections is provided in the "Technical Information" document</p>
------------------------------	--

Flow limit	<p>Select the nominal diameter by optimizing between the required flow range and permissible pressure loss.</p> <p> For an overview of the measuring range full scale values, see the "Measuring range" section →  130</p> <ul style="list-style-type: none"> ■ The minimum recommended full scale value is approx. 1/20 of the maximum full scale value. ■ In most applications, 10 to 50 % of the maximum full scale value can be considered ideal.
------------	---

Pressure loss	There is no pressure loss.
---------------	----------------------------

System pressure	<p>Sensor Max. 10 bar (145 psi)</p>
-----------------	--

Thermal insulation	<p>For optimum temperature and methane fraction measurement (order characteristic for "Sensor version", option 2 "Volume flow + Biogas analysis"), make sure that heat is neither lost nor applied to the sensor. Thermal insulation can ensure that such heat transfer does not take place.</p> <p>Thermal insulation is particularly recommended in situations where there is a large difference between the process temperature and the ambient temperature. This can result in heat convection errors during temperature measurement. A further factor which can lead to measurement errors due to heat convection is a low flow velocity.</p>
--------------------	--

16.10 Mechanical construction

Design, dimensions	<p> For the dimensions and installation lengths of the device, see the "Technical Information" document, "Mechanical construction" section</p>
--------------------	---

Weight

Weight in SI units

Compact version

All values (weight) refer to devices with EN (DIN) PN 10/16 flanges. Weight information in [kg].

Order code for "Housing", option C "GT20 two-chamber, aluminum coated"

Nominal diameter [mm]	Lap joint flange		Lap joint flange, stamped plate	
	1.4306	S235JR	1.4301	S235JR
50	9.5		5.9	
80	11.8		7.5	
100	14.0		9.1	
150	20.9		12.3	
200	27.9		19.1	

Order code for "Housing", option S, "GT18 two-chamber, stainless steel"

Nominal diameter [mm]	Lap joint flange		Lap joint flange, stamped plate	
	1.4306	S235JR	1.4301	S235JR
50	12.4		8.7	
80	14.7		10.3	
100	16.9		12.0	
150	23.7		15.2	
200	30.7		22.0	

Weight in US units

Compact version

All values (weight) refer to devices with ASME B16.5, Class 150 flanges. Weight information in [lbs].

Order code for "Housing", option C "GT20 two-chamber, aluminum coated"

Nominal diameter [in]	Lap joint flange	
	316L	A105
2	18.8	
3	28.6	
4	38.0	
6	49.8	
8	77.4	

Order code for "Housing", option S "GT18 two-chamber, stainless steel"

Nominal diameter [in]	Lap joint flange	
	316L	A105
2	25.1	
3	34.9	
4	44.3	

Nominal diameter [in]	Lap joint flange	
	316L	A105
6	56.1	
8	83.7	

Accessories

Replacement tool

Weight [kg]	Weight [lbs]
3.66	8.07

Flow conditioner

Weight in SI units

DN [mm]	Pressure rating	Weight [kg]
50	PN 10/16	0.5
	Class 150	0.5
80	PN 10/16	1.4
	Class 150	1.2
100	PN 10/16	2.4
	Class 150	2.7
150	PN 10/16	6.3
	Class 150	6.3
200	PN 10	11.5
	Class 150	12.3

Weight in US units

DN [in]	Pressure rating	Weight [lbs]
2	Class 150	1.1
3	Class 150	2.6
4	Class 150	6.0
6	Class 150	14.0
8	Class 150	27.0

Materials

Transmitter housing

- Order code for "Housing", option **C** "Compact, aluminum coated":
Aluminum, AlSi10Mg, coated
- Order code for "Housing", option **S**: stainless steel 1.4404 (316L)
- Window material: glass

Cable entries/cable glands

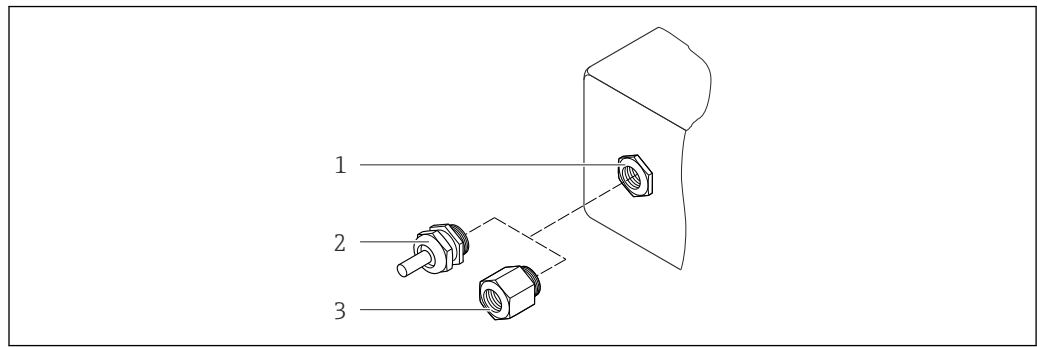

A0020640

36 Possible cable entries/cable glands

- 1 Cable entry in transmitter housing or connection housing with internal thread M20 x 1.5
- 2 Cable gland M20 x 1.5
- 3 Adapter for cable entry with internal thread G 1/2" or NPT 1/2"

Order code for "Housing", option C "GT20 two-chamber, aluminum coated"

Transmitter		
Cable entry/cable gland	Type of protection	Material
Cable gland M20 x 1.5	<ul style="list-style-type: none"> ■ Non-Ex ■ Ex ia 	Plastic
Adapter for cable entry with internal thread G 1/2"	For non-Ex and Ex (except for CSA Ex d/XP)	Nickel-plated brass
Adapter for cable entry with internal thread NPT 1/2"	For non-Ex and Ex	

Transmitter neck		
Cable gland	Measuring path	Material
Cable gland M20 x 1.5	Two-path	Nickel-plated brass
Cable gland M12 x 1.5	Single-path	

Sensor	
Cable gland	Material
Cable gland M12 x 1.5	Nickel-plated brass

Order code for "Housing", option S, "GT18 two-chamber, stainless steel"

Transmitter		
Cable entry/cable gland	Type of protection	Material
Cable gland M20 x 1.5	<ul style="list-style-type: none"> ■ Non-Ex ■ Ex ia 	Stainless steel ,1.4404
Adapter for cable entry with internal thread G 1/2"	For non-Ex and Ex (except for CSA Ex d/XP)	Stainless steel, 1.4404 (316L)
Adapter for cable entry with internal thread NPT 1/2"	For non-Ex and Ex	

Transmitter neck		
Cable gland	Sensor version	Material
Cable gland M20 × 1.5	Two-path	Stainless steel ,1.4305
Cable gland M12 × 1.5	Single-path	

Sensor		
Cable gland	Sensor version	Material
Cable gland M20 × 1.5	Two-path	Stainless steel ,1.4305
Cable gland M12 × 1.5	Single-path	

Sensor housing

Stainless steel (cold worked):

- 1.4404 (316L)
- 1.4435 (316L)

Process connections

- Stainless steel:
 - 1.4301 (304)
 - 1.4306 (304L)
 - 1.4404 (316L)
- Steel S235JR
- Carbon steel A105

 List of all available process connections →  143

Seals

- Converter: HNBR
- Temperature sensor: AFM 34

Accessories

Replacement tool

- Knurled handle: aluminum
- Stop cock: nickel-plated brass
- Shaft: brass
- Tensioning element: tempered steel

Flow conditioner

Stainless steel 1.4404 (316L) (in compliance with NACE MR0175-2003 and MR0103-2003)

Weather protection cover

Stainless steel 1.4404 (316L)

Process connections

Flanges:

- EN 1092-1 (DIN 2501)
- ASME B16.5

 For information on the materials of the process connections →  143

16.11 Operability

Local operation



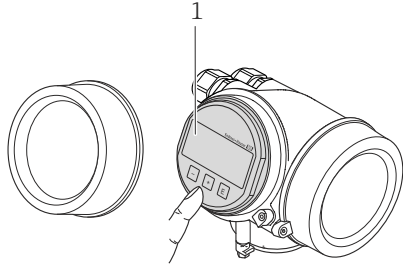
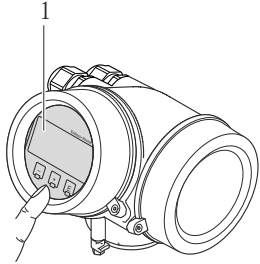



Via display module

Order code for "Display; Operation", option C "SD02"	Order code for "Display; Operation", option E "SD03"
 <p style="text-align: right; font-size: small;">A0015544</p>	 <p style="text-align: right; font-size: small;">A0015546</p>
<p>1 <i>Operation with pushbuttons</i></p>	<p>1 <i>Operation with touch control</i></p>

Display elements

- 4-line display
- With order code for "Display; operation", option **E**:
White background lighting; switches to red in event of device errors
- Format for displaying measured variables and status variables can be individually configured
- Permitted ambient temperature for the display: -20 to +60 °C (-4 to +140 °F)
The readability of the display may be impaired at temperatures outside the temperature range.

Operating elements

- With order code for "Display; operation", option **C**:
Local operation with 3 push buttons: , , 
- With order code for "Display; operation", option **E**:
External operation via touch control; 3 optical keys: , , 
- Operating elements also accessible in various hazardous areas

Additional functionality

- Data backup function
The device configuration can be saved in the display module.
- Data comparison function
The device configuration saved in the display module can be compared to the current device configuration.
- Data transfer function
The transmitter configuration can be transmitted to another device using the display module.

Via remote display and operating module FHX50

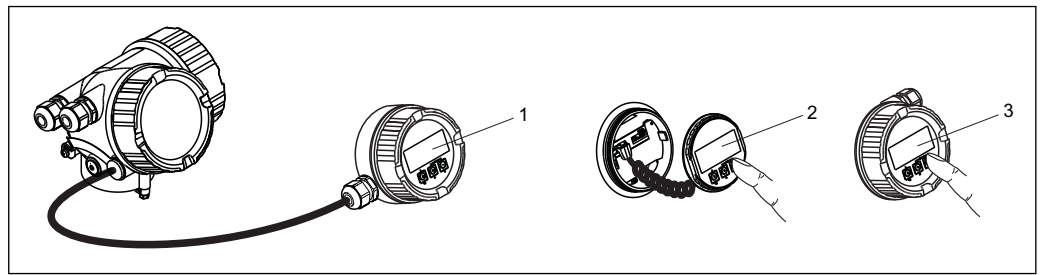

A0013137

37 Operating options via FHX50

- 1 Housing of remote display and operating module FHX50
- 2 SD02 display and operating module, push buttons: cover must be opened for operation
- 3 SD03 display and operating module, optical buttons: operation possible through cover glass

Remote operation

Via HART protocol

This communication interface is available in device versions with a HART output.

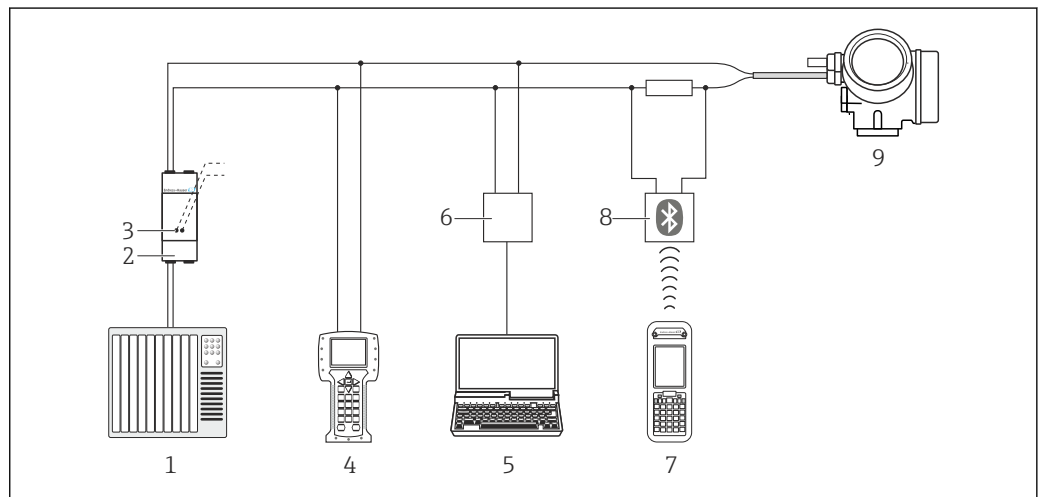

A0013764

38 Options for remote operation via HART protocol

- 1 Control system (e.g. PLC)
- 2 Transmitter power supply unit, e.g. RN221N (with communication resistor)
- 3 Connection for Commubox FXA195 and Field Communicator 475
- 4 Field Communicator 475
- 5 Computer with operating tool (e.g. FieldCare, AMS Device Manager, SIMATIC PDM)
- 6 Commubox FXA195 (USB)
- 7 Field Xpert SFX350 or SFX370
- 8 VIATOR Bluetooth modem with connecting cable
- 9 Transmitter

Service interface

Via service interface (CDI)

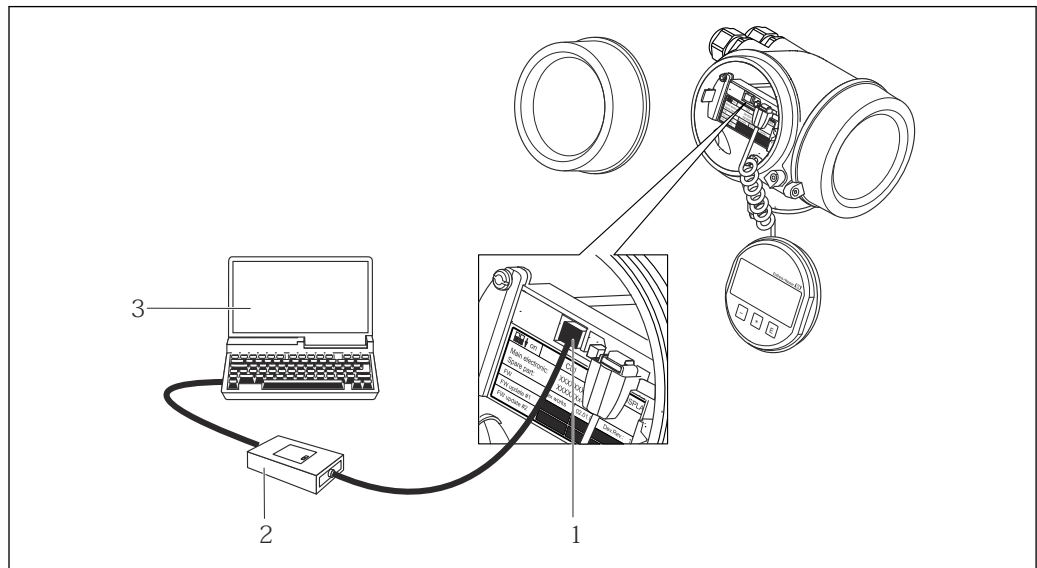

- 1 Service interface (CDI = Endress+Hauser Common Data Interface) of the measuring device
 2 Commubox FXA291
 3 Computer with "FieldCare" operating tool with COM DTM "CDI Communication FXA291"

A0014019

Languages

Can be operated in the following languages:

- Via local display:
 English, German, French, Spanish, Italian, Dutch, Portuguese, Polish, Russian, Turkish, Chinese, Japanese, Korean, Bahasa (Indonesian), Vietnamese, Czech, Swedish
- Via "FieldCare" operating tool:
 English, German, French, Spanish, Italian, Chinese, Japanese

16.12 Certificates and approvals

CE mark

The measuring system is in conformity with the statutory requirements of the applicable EC Directives. These are listed in the corresponding EC Declaration of Conformity along with the standards applied.

Endress+Hauser confirms successful testing of the device by affixing to it the CE mark.

C-Tick symbol

The measuring system meets the EMC requirements of the "Australian Communications and Media Authority (ACMA)".

Ex approval

The devices are certified for use in hazardous areas and the relevant safety instructions are provided in the separate "Safety Instructions" (XA) document. Reference is made to this document on the nameplate.

HART certification

HART interface

The measuring device is certified and registered by the HCF (HART Communication Foundation). The measuring system meets all the requirements of the following specifications:



- Certified according to HART 7
- The device can also be operated with certified devices of other manufacturers (interoperability)

Pressure Equipment Directive	<ul style="list-style-type: none"> ■ With the PED/G1/x (x = category) marking on the sensor nameplate, Endress+Hauser confirms compliance with the "Essential Safety Requirements" specified in Annex I of the Pressure Equipment Directive 97/23/EC. ■ Devices not bearing this marking (PED) are designed and manufactured according to good engineering practice. They meet the requirements of Art.3 Section 3 of the Pressure Equipment Directive 97/23/EC. The range of application is indicated in tables 6 to 9 in Annex II of the Pressure Equipment Directive.
Other standards and guidelines	<ul style="list-style-type: none"> ■ EN 60529 Degrees of protection provided by enclosures (IP code) ■ EN 61010-1 Safety requirements for electrical equipment for measurement, control and laboratory use ■ IEC/EN 61326 Emission in accordance with Class A requirements. Electromagnetic compatibility (EMC requirements). ■ NAMUR NE 21 Electromagnetic compatibility (EMC) of industrial process and laboratory control equipment ■ NAMUR NE 32 Data retention in the event of a power failure in field and control instruments with microprocessors ■ NAMUR NE 43 Standardization of the signal level for the breakdown information of digital transmitters with analog output signal. ■ NAMUR NE 53 Software of field devices and signal-processing devices with digital electronics ■ NAMUR NE 80 The application of the pressure equipment directive to process control devices ■ NAMUR NE 105 Specifications for integrating fieldbus devices in engineering tools for field devices ■ NAMUR NE 107 Self-monitoring and diagnosis of field devices ■ NAMUR NE 131 Requirements for field devices for standard applications



16.13 Application packages

Many different application packages are available to enhance the functionality of the device. Such packages might be needed to address safety aspects or specific application requirements.

The application packages can be ordered with the device or subsequently from Endress+Hauser. Detailed information on the order code in question is available from your local Endress+Hauser sales center or on the product page of the Endress+Hauser website: www.endress.com.

 Detailed information on the application packages:
Special Documentation for the device →  148

16.14 Accessories

 Overview of accessories available for order →  127

16.15 Documentation

-  For an overview of the scope of the associated Technical Documentation, refer to the following:
- The CD-ROM provided for the device (depending on the device version, the CD-ROM might not be part of the delivery!)
 - The *W@M Device Viewer* : Enter the serial number from the nameplate (www.endress.com/deviceviewer)
 - The *Endress+Hauser Operations App*: Enter the serial number from the nameplate or scan the 2-D matrix code (QR code) on the nameplate.

Standard documentation

Brief Operating Instructions

Measuring device	Documentation code
Prosonic Flow B 200	KA01096D

Description of Device Parameters

Measuring device	Documentation code
	HART
Prosonic Flow B 200	GP01012D

Technical Information

Measuring device	Documentation code
Prosonic Flow B 200	TI01018D

Supplementary device-dependent documentation



Safety Instructions

Contents	Documentation code
ATEX/IECEX Ex d	XA01008D
ATEX/IECEX Ex i	XA01009D
^c CSA _{US} XP	XA01010D
^c CSA _{US} IS	XA01011D
INMETRO Ex d	XA01307D
INMETRO Ex i	XA01308D
NEPSI Ex d	XA01068D
NEPSI Ex i	XA01069D

Special Documentation

Contents	Documentation code
Information on the Pressure Equipment Directive	SD00152D
Heartbeat Technology	SD01470D

Installation Instructions

Contents	Documentation code
Installation Instructions for spare part sets	 Overview of accessories available for order →  127

Index

A

Access authorization to parameters	
Read access	46
Write access	46
Access code	46
Incorrect input	46
Adapting the diagnostic behavior	111
Adapting the status signal	111
Ambient temperature	
Influence	137
Ambient temperature range	20, 138
AMS Device Manager	50
Function	50
Application	9, 130
Applicator	130
Approvals	146

B

Burst mode	53
----------------------	----

C

C-Tick symbol	146
Cable entries	
Technical data	136
Cable entry	
Degree of protection	31
CE mark	10, 146
Certificates	146
Check	
Post-mounting	23
Checklist	
Post-connection check	32
Post-mounting check	23
Cleaning	
Exterior cleaning	123
Commissioning	57
Advanced settings	84
Configuring the measuring device	58
Communication-specific data	52
Connecting cable	24
Connecting the measuring device	27
Connection	
see Electrical connection	
Connection preparations	26
Connection tools	24
Context menu	
Closing	41
Explanation	41
Opening	41
Current consumption	135

D

Declaration of Conformity	10
Define access code	94
Degree of protection	31, 138

Design

Measuring device	12
Designated use	9
Device components	12
Device description files	52
Device documentation	
Supplementary documentation	8
Device name	
Sensor	15
Transmitter	14
Device repair	124
Device revision	52
Device type ID	52
Diagnostic behavior	
Explanation	108
Symbols	108
Diagnostic information	
Design, description	108, 110
FieldCare	110
Local display	107
Overview	112
Remedial measures	112
Diagnostic list	116
Diagnostic message	107
Diagnostics	
Symbols	107
DIP switches	
see Write protection switch	
Direct access	43
Direct access code	38
Disabling write protection	94
Display	
Current diagnostic event	115
Previous diagnostic event	115
see Local display	
Display area	
For operational display	36
In the navigation view	38
Disposal	125
Document	
Function	6
Symbols used	6
Document function	6

E

Electrical connection	
Commubox FXA195	48
Commubox FXA195 (USB)	145
Commubox FXA291	48, 146
Degree of protection	31
Field Communicator	48
Field Communicator 475	145
Field Xpert SFX350/SFX370	145
Handheld terminals	48
Measuring device	24

- Operating tool (e.g. FieldCare, AMS Device Manager, SIMATIC PDM) 145
- Operating tools 48
 - Via HART protocol 48, 145
 - Via service interface (CDI) 48, 146
- Transmitter power supply unit 145
- VIATOR Bluetooth modem 145
- Electromagnetic compatibility 139
- Enabling write protection 94
- Endress+Hauser services
 - Maintenance 123
 - Repair 125
- Environment
 - Storage temperature 138
- Error messages
 - see Diagnostic messages
- Event history 116
- Events list 116
- Ex approval 146
- Extended order code
 - Sensor 15
 - Transmitter 14
- Exterior cleaning 123
- F**
- Field Communicator
 - Function 51
- Field Communicator 475 51
- Field of application
 - Residual risks 10
- Field Xpert
 - Function 49
- Field Xpert SFX350 49
- FieldCare 49
 - Device description file 52
 - Function 49
 - User interface 50
- Filtering the event logbook 117
- Firmware
 - Release date 52
 - Version 52
- Firmware history 122
- Flow direction 18, 21
- Flow limit 139
- Function check 57
- Function scope
 - AMS Device Manager 50
 - Field Communicator 51
 - Field Communicator 475 51
 - Field Xpert 49
 - SIMATIC PDM 50
- Functions
 - see Parameters
- G**
- Galvanic isolation 134
- H**
- Hardware write protection 95
- HART certification 146
- HART protocol
 - Device variables 52
 - Measured variables 52
 - Revision 52
- Help text
 - Calling up 44
 - Close 44
 - Explanation 44
- HistoROM 90
- I**
- I/O electronics module 12, 27
- Identifying the measuring device 13
- Incoming acceptance 13
- Influence
 - Ambient temperature 137
- Information on the document 6
- Inlet runs 19
- Input 130
- Input mask 39
- Inspection
 - Received goods 13
- Inspection check
 - Connection 32
- Installation 18
- Installation conditions
 - Inlet and outlet runs 19
 - Mounting location 18
 - Orientation 18
 - System pressure 20, 139
 - Thermal insulation 21, 139
- Installation dimensions 20
- K**
- Keypad lock
 - Disabling 46
 - Enabling 46
- L**
- Languages, operation options 146
- Line recorder 102
- Load 26
- Local display 144
 - Editing view 39
 - Navigation view 37
 - see Diagnostic message
 - see In alarm condition
 - see Operational display
- Low flow cut off 134
- M**
- Main electronics module 12
- Maintenance 123
- Maintenance tasks 123
- Managing the device configuration 90
- Manufacturer ID 52
- Manufacturing date 14, 15
- Materials 141
- Maximum measured error 136

- Measured variables
 - Calculated 130
 - Direct 130
 - Optional 130
 - see Process variables
- Measuring and test equipment 123
- Measuring device
 - Configuring 58
 - Conversion 124
 - Design 12
 - Disposal 126
 - Integrating via HART protocol 52
 - Mounting the sensor 21
 - Preparing for electrical connection 26
 - Preparing for mounting 21
 - Removing 125
 - Repair 124
 - Switch-on 57
- Measuring principle 130
- Measuring range 130
- Measuring range, recommended 139
- Measuring system 130
- Media 9
- Menu
 - Diagnostics 115
 - Setup 58
- Menus
 - For measuring device configuration 58
 - For specific settings 84
- Mounting dimensions
 - see Installation dimensions
- Mounting location 18
- Mounting preparations 21
- Mounting requirements
 - Installation dimensions 20
- Mounting tools 21
- N**
- Nameplate
 - Sensor 15
 - Transmitter 14
- Navigation path (navigation view) 37
- Navigation view
 - In the submenu 37
 - In the wizard 37
- Numeric editor 39
- O**
- Operable flow range 131
- Operating elements 41, 108
- Operating keys
 - see Operating elements
- Operating menu
 - Menus, submenus 34
 - Structure 34
 - Submenus and user roles 35
- Operating philosophy 35
- Operation 97
- Operation options 33
- Operational display 36
- Operational safety 10
- Order code 13, 14, 15
- Orientation (vertical, horizontal) 18
- Outlet runs 19
- Output 132
- Output signal 132
- P**
- Packaging disposal 17
- Parameter
 - Changing 45
 - Enter a value 45
- Parameter settings
 - Administration (Submenu) 89, 118
 - Burst configuration 1 to 3 (Submenu) 53
 - Configuration backup display (Submenu) 90
 - Current input (Wizard) 63
 - Current output 1 to 2 (Wizard) 65
 - Data logging (Submenu) 102
 - Device information (Submenu) 119
 - Diagnostics (Menu) 115
 - Display (Submenu) 87
 - Display (Wizard) 78
 - Low flow cut off (Submenu) 82
 - Medium selection (Submenu) 62
 - Operation (Submenu) 101
 - Output conditioning (Wizard) 80
 - Output values (Submenu) 100
 - Process variables (Submenu) 97
 - Pulse/frequency/switch output (Wizard) 69, 71, 75
 - Setup (Menu) 58
 - Simulation (Submenu) 91
 - System units (Submenu) 59
 - System values (Submenu) 99
 - Totalizer (Submenu) 99
 - Totalizer 1 to 3 (Submenu) 85
- Performance characteristics 136
- Post-connection check (checklist) 32
- Post-installation check 57
- Post-mounting check (checklist) 23
- Potential equalization 28
- Power consumption 135
- Power supply failure 135
- Pressure Equipment Directive 147
- Pressure loss 139
- Pressure-temperature ratings 139
- Process connections 143
- Product safety 10
- Protecting parameter settings 94
- R**
- Read access 46
- Reading measured values 97
- Recalibration 123
- Reference operating conditions 136
- Registered trademarks 8
- Remedial measures
 - Calling up 109

- Closing 109
- Remote operation 145
- Repair 124
 - Notes 124
- Repair of a device 124
- Repeatability 137
- Replacement
 - Device components 124
- Requirements for personnel 9
- Response time 137
- Return 125
- S**
- Safety 9
- Sensor
 - Medium temperature range 139
 - Mounting 21
 - System pressure 20, 139
- Serial number 14, 15
- Setting the operating language 57
- Settings
 - Adapting the measuring device to the process conditions 101
 - Administration 89
 - Advanced display configurations 87
 - Current input 63
 - Current output 65
 - Device reset 118
 - Device tag 58
 - Local display 78
 - Low flow cut off 82
 - Managing the device configuration 90
 - Medium 62
 - Operating language 57
 - Output conditioning 80
 - Pulse output 69
 - Pulse/frequency/switch output 68, 71
 - Resetting the totalizer 101
 - Simulation 91
 - Switch output 75
 - System units 59
 - Totalizer 85
 - Totalizer reset 101
- Shock resistance 138
- Showing data logging 102
- Signal on alarm 133
- SIMATIC PDM 50
 - Function 50
- Software release 52
- Spare part 124
- Spare parts 124
- Special connection instructions 29
- Standards and guidelines 147
- Status area
 - For operational display 36
 - In the navigation view 38
- Status signals 107
- Storage conditions 16
- Storage temperature 16
- Storage temperature range 138
- Structure
 - Operating menu 34
- Submenu
 - Administration 89, 118
 - Advanced setup 84
 - Burst configuration 1 to 3 53
 - Configuration backup display 90
 - Data logging 102
 - Device information 119
 - Display 87
 - Events list 116
 - Low flow cut off 82
 - Medium selection 62
 - Operation 101
 - Output values 100
 - Overview 35
 - Process variables 97
 - Simulation 91
 - System units 59
 - System values 99
 - Totalizer 99
 - Totalizer 1 to 3 85
- Supply unit
 - Requirements 25
- Supply voltage 25, 134
- Symbols
 - For communication 36
 - For correction 39
 - For diagnostic behavior 36
 - For locking 36
 - For measured variable 36
 - For measurement channel number 36
 - For menus 38
 - For parameters 38
 - For status signal 36
 - For submenu 38
 - For wizard 38
 - In the status area of the local display 36
 - In the text and numeric editor 39
- System design
 - Measuring system 130
 - see Measuring device design
- System integration 52
- System pressure 20, 139
- T**
- Technical data, overview 130
- Temperature range
 - Ambient temperature 20, 138
 - Ambient temperature range for display 144
 - Medium temperature 139
 - Storage temperature 16
- Terminal assignment 25, 27
- terminal voltage 26
- Terminals 135
- Text editor 39
- Thermal insulation 21, 139

- Tool tip
 - see Help text
 - Tools
 - Electrical connection 24
 - Installation 21
 - Transport 16
 - Transmitter
 - Connecting the signal cables 27
 - Turning the display module 22
 - Turning the housing 21
 - Transporting the measuring device 16
 - Troubleshooting
 - General 105
 - Turning the display module 22
 - Turning the electronics housing
 - see Turning the transmitter housing
 - Turning the transmitter housing 21
- U**
- Use of the measuring device
 - Borderline cases 9
 - Incorrect use 9
 - see Designated use
 - User roles 35
- V**
- Version data for the device 52
 - Vibration resistance 138
- W**
- W@M 123, 124
 - W@M Device Viewer 13, 124
 - Weight
 - Flow conditioner 141
 - Replacement tool 141
 - SI units 140
 - Transport (notes) 16
 - US units 140
 - Wizard
 - Current input 63
 - Current output 1 to 2 65
 - Define access code 94
 - Display 78
 - Low flow cut off 82
 - Output conditioning 80
 - Pulse/frequency/switch output 69, 71, 75
 - Workplace safety 10
 - Write access 46
 - Write protection
 - Via access code 94
 - Via write protection switch 95
 - Write protection switch 95

www.addresses.endress.com
