

# Operating Instructions

## Proline Promass A 200

### HART

Coriolis flowmeter

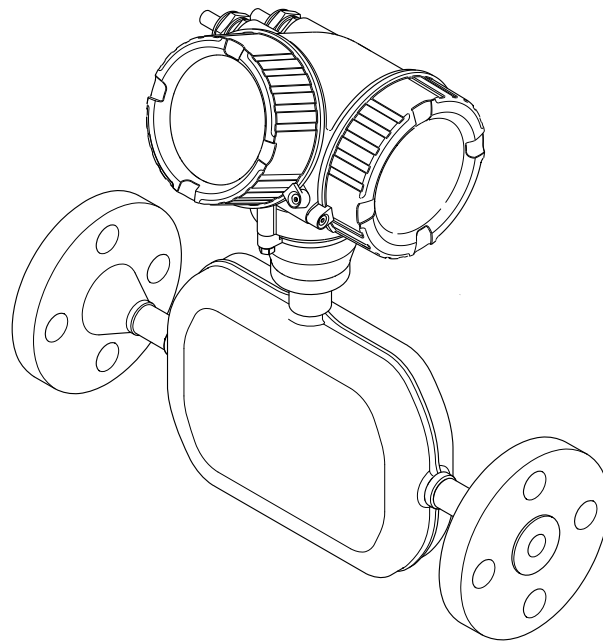

- Make sure the document is stored in a safe place such that it is always available when working on or with the device.
- To avoid danger to individuals or the facility, read the "Basic safety instructions" section carefully, as well as all other safety instructions in the document that are specific to working procedures.
- The manufacturer reserves the right to modify technical data without prior notice. Your Endress+Hauser Sales Center will supply you with current information and updates to these instructions.

# Table of contents

|          |   |           |          |  |           |
|----------|---|-----------|----------|--|-----------|
| <b>1</b> | <b>About this document</b> . . . . .                            | <b>6</b>  | <b>6</b> | <b>Installation</b> . . . . .                                | <b>20</b> |
| 1.1      | Document function . . . . .                                     | 6         | 6.1      | Installation conditions . . . . .                            | 20        |
| 1.2      | Symbols . . . . .   | 6         | 6.1.1    | Mounting position . . . . .                                  | 20        |
| 1.2.1    | Safety symbols . . . . .  | 6         | 6.1.2    | Environmental and process requirements . . . . .             | 22        |
| 1.2.2    | Electrical symbols . . . . .                                    | 6         | 6.1.3    | Special mounting instructions . . . . .                      | 23        |
| 1.2.3    | Communication symbols . . . . .                                 | 6         | 6.2      | Mounting the measuring device . . . . .                      | 26        |
| 1.2.4    | Tool symbols . . . . .  | 7         | 6.2.1    | Required tools . . . . .                                     | 26        |
| 1.2.5    | Symbols for certain types of information . . . . .              | 7         | 6.2.2    | Preparing the measuring device . . . . .                     | 26        |
| 1.2.6    | Symbols in graphics . . . . .                                   | 7         | 6.2.3    | Mounting the measuring device . . . . .                      | 26        |
| 1.3      | Documentation . . . . .   | 8         | 6.2.4    | Turning the transmitter housing . . . . .                    | 27        |
| 1.3.1    | Standard documentation . . . . .                                | 8         | 6.2.5    | Turning the display module . . . . .                         | 27        |
| 1.3.2    | Supplementary device-dependent documentation . . . . .          | 8         | 6.3      | Post-installation check . . . . .                            | 28        |
| 1.4      | Registered trademarks . . . . .                                 | 8         | <b>7</b> | <b>Electrical connection</b> . . . . .                       | <b>29</b> |
| <b>2</b> | <b>Safety instructions</b> . . . . .                            | <b>9</b>  | 7.1      | Connection conditions . . . . .                              | 29        |
| 2.1      | Requirements for the personnel . . . . .                        | 9         | 7.1.1    | Required tools . . . . .                                     | 29        |
| 2.2      | Designated use . . . . .  | 9         | 7.1.2    | Connecting cable requirements . . . . .                      | 29        |
| 2.3      | Workplace safety . . . . .                                      | 10        | 7.1.3    | Terminal assignment . . . . .                                | 30        |
| 2.4      | Operational safety . . . . .                                    | 10        | 7.1.4    | Requirements for the supply unit . . . . .                   | 30        |
| 2.5      | Product safety . . . . .  | 11        | 7.1.5    | Preparing the measuring device . . . . .                     | 31        |
| 2.6      | IT security . . . . .   | 11        | 7.2      | Connecting the measuring device . . . . .                    | 31        |
| 2.7      | Device-specific IT security . . . . .                           | 11        | 7.2.1    | Connecting the transmitter . . . . .                         | 32        |
| 2.7.1    | Protecting access via hardware write protection . . . . .       | 11        | 7.2.2    | Ensuring potential equalization . . . . .                    | 33        |
| 2.7.2    | Protecting access via a password . . . . .                      | 11        | 7.3      | Special connection instructions . . . . .                    | 33        |
| 2.7.3    | Access via fieldbus . . . . .                                   | 12        | 7.3.1    | Connection examples . . . . .                                | 33        |
| <b>3</b> | <b>Product description</b> . . . . .                            | <b>13</b> | 7.4      | Ensuring the degree of protection . . . . .                  | 35        |
| 3.1      | Product design . . . . .  | 13        | 7.5      | Post-connection check . . . . .                              | 36        |
| <b>4</b> | <b>Incoming acceptance and product identification</b> . . . . . | <b>14</b> | <b>8</b> | <b>Operation options</b> . . . . .                           | <b>37</b> |
| 4.1      | Incoming acceptance . . . . .                                   | 14        | 8.1      | Overview of operation options . . . . .                      | 37        |
| 4.2      | Product identification . . . . .                                | 14        | 8.2      | Structure and function of the operating menu . . . . .       | 38        |
| 4.2.1    | Transmitter nameplate . . . . .                                 | 15        | 8.2.1    | Structure of the operating menu . . . . .                    | 38        |
| 4.2.2    | Sensor nameplate . . . . .                                      | 16        | 8.2.2    | Operating philosophy . . . . .                               | 39        |
| 4.2.3    | Symbols on measuring device . . . . .                           | 17        | 8.3      | Access to the operating menu via the local display . . . . . | 40        |
| <b>5</b> | <b>Storage and transport</b> . . . . .                          | <b>18</b> | 8.3.1    | Operational display . . . . .                                | 40        |
| 5.1      | Storage conditions . . . . .                                    | 18        | 8.3.2    | Navigation view . . . . .                                    | 41        |
| 5.2      | Transporting the product . . . . .                              | 18        | 8.3.3    | Editing view . . . . .                                       | 43        |
| 5.2.1    | Measuring devices without lifting lugs . . . . .                | 18        | 8.3.4    | Operating elements . . . . .                                 | 45        |
| 5.2.2    | Measuring devices with lifting lugs . . . . .                   | 19        | 8.3.5    | Opening the context menu . . . . .                           | 45        |
| 5.2.3    | Transporting with a fork lift . . . . .                         | 19        | 8.3.6    | Navigating and selecting from list . . . . .                 | 47        |
| 5.3      | Packaging disposal . . . . .                                    | 19        | 8.3.7    | Calling the parameter directly . . . . .                     | 47        |
|          |   |           | 8.3.8    | Calling up help text . . . . .                               | 48        |
|          |   |           | 8.3.9    | Changing the parameters . . . . .                            | 49        |
|          |   |           | 8.3.10   | User roles and related access authorization . . . . .        | 50        |
|          |   |           | 8.3.11   | Disabling write protection via access code . . . . .         | 50        |
|          |   |           | 8.3.12   | Enabling and disabling the keypad lock . . . . .             | 51        |

|           |  |           |           |   |            |
|-----------|--|-----------|-----------|---|------------|
| 8.4       | Access to the operating menu via the operating tool . . . . .        | 51        | 11.4      | Reading measured values . . . . .                                 | 93         |
| 8.4.1     | Connecting the operating tool . . . . .                              | 51        | 11.4.1    | Process variables . . . . .                                       | 94         |
| 8.4.2     | Field Xpert SFX350, SFX370 . . . . .                                 | 52        | 11.4.2    | "Totalizer" submenu . . . . .                                     | 95         |
| 8.4.3     | FieldCare . . . . .  | 53        | 11.4.3    | Output values . . . . .   | 96         |
| 8.4.4     | DeviceCare . . . . .   | 54        | 11.5      | Adapting the measuring device to the process conditions . . . . . | 97         |
| 8.4.5     | AMS Device Manager . . . . .   | 54        | 11.6      | Performing a totalizer reset . . . . .                            | 97         |
| 8.4.6     | SIMATIC PDM . . . . .  | 55        | 11.6.1    | Function scope of the "Control Totalizer" parameter . . . . .     | 98         |
| 8.4.7     | Field Communicator 475 . . . . .                                     | 55        | 11.6.2    | Function scope of the "Reset all totalizers" parameter . . . . .  | 98         |
| <b>9</b>  | <b>System integration . . . . .</b>                                  | <b>56</b> | 11.7      | Showing data logging . . . . .                                    | 98         |
| 9.1       | Overview of device description files . . . . .                       | 56        | <b>12</b> | <b>Diagnostics and troubleshooting . . . . .</b>                  | <b>101</b> |
| 9.1.1     | Current version data for the device . . . . .                        | 56        | 12.1      | General troubleshooting . . . . .                                 | 101        |
| 9.1.2     | Operating tools . . . . .  | 56        | 12.2      | Diagnostic information on local display . . . . .                 | 103        |
| 9.2       | Measured variables via HART protocol . . . . .                       | 56        | 12.2.1    | Diagnostic message . . . . .                                      | 103        |
| 9.2.1     | Device variables . . . . .   | 57        | 12.2.2    | Calling up remedial measures . . . . .                            | 105        |
| 9.3       | Other settings . . . . .   | 58        | 12.3      | Diagnostic information in FieldCare or DeviceCare . . . . .       | 105        |
| <b>10</b> | <b>Commissioning . . . . .</b>                                       | <b>61</b> | 12.3.1    | Diagnostic options . . . . .                                      | 105        |
| 10.1      | Function check . . . . .   | 61        | 12.3.2    | Calling up remedy information . . . . .                           | 107        |
| 10.2      | Switching on the measuring device . . . . .                          | 61        | 12.4      | Adapting the diagnostic information . . . . .                     | 107        |
| 10.3      | Setting the operating language . . . . .                             | 61        | 12.4.1    | Adapting the diagnostic behavior . . . . .                        | 107        |
| 10.4      | Configuring the measuring device . . . . .                           | 61        | 12.4.2    | Adapting the status signal . . . . .                              | 108        |
| 10.4.1    | Defining the tag name . . . . .                                      | 62        | 12.5      | Overview of diagnostic information . . . . .                      | 109        |
| 10.4.2    | Selecting and setting the medium . . . . .                           | 64        | 12.6      | Pending diagnostic events . . . . .                               | 112        |
| 10.4.3    | Setting the system units . . . . .                                   | 64        | 12.7      | Diagnostic list . . . . .   | 112        |
| 10.4.4    | Configuring the current output . . . . .                             | 67        | 12.8      | Event logbook . . . . .   | 113        |
| 10.4.5    | Configuring the pulse/frequency/switch output . . . . .              | 68        | 12.8.1    | Reading out the event logbook . . . . .                           | 113        |
| 10.4.6    | Configuring the local display . . . . .                              | 74        | 12.8.2    | Filtering the event logbook . . . . .                             | 113        |
| 10.4.7    | Configuring the output conditioning . . . . .                        | 75        | 12.8.3    | Overview of information events . . . . .                          | 114        |
| 10.4.8    | Configuring the low flow cut off . . . . .                           | 78        | 12.9      | Resetting the measuring device . . . . .                          | 115        |
| 10.4.9    | Configuring the partial filled pipe detection . . . . .              | 79        | 12.9.1    | Function scope of the "Device reset" parameter . . . . .          | 115        |
| 10.5      | Advanced settings . . . . .  | 80        | 12.10     | Device information . . . . .                                      | 115        |
| 10.5.1    | Carrying out a sensor adjustment . . . . .                           | 81        | 12.11     | Firmware history . . . . .  | 117        |
| 10.5.2    | Configuring the totalizer . . . . .                                  | 82        | <b>13</b> | <b>Maintenance . . . . .</b>                                      | <b>118</b> |
| 10.5.3    | Carrying out additional display configurations . . . . .             | 83        | 13.1      | Maintenance tasks . . . . .                                       | 118        |
| 10.5.4    | Using parameters for device administration . . . . .                 | 85        | 13.1.1    | Exterior cleaning . . . . .                                       | 118        |
| 10.6      | Configuration management . . . . .                                   | 86        | 13.1.2    | Interior cleaning . . . . .                                       | 118        |
| 10.6.1    | Function scope of the "Configuration management" parameter . . . . . | 87        | 13.2      | Measuring and test equipment . . . . .                            | 118        |
| 10.7      | Simulation . . . . .   | 87        | 13.3      | Endress+Hauser services . . . . .                                 | 118        |
| 10.8      | Protecting settings from unauthorized access . . . . .               | 89        | <b>14</b> | <b>Repair . . . . .</b>   | <b>119</b> |
| 10.8.1    | Write protection via access code . . . . .                           | 89        | 14.1      | General notes . . . . .   | 119        |
| 10.8.2    | Write protection via write protection switch . . . . .               | 90        | 14.1.1    | Repair and conversion concept . . . . .                           | 119        |
| <b>11</b> | <b>Operation . . . . .</b>   | <b>93</b> | 14.1.2    | Notes for repair and conversion . . . . .                         | 119        |
| 11.1      | Reading the device locking status . . . . .                          | 93        | 14.2      | Spare parts . . . . .   | 119        |
| 11.2      | Adjusting the operating language . . . . .                           | 93        | 14.3      | Endress+Hauser services . . . . .                                 | 120        |
| 11.3      | Configuring the display . . . . .                                    | 93        | 14.4      | Return . . . . .  | 120        |
|           |  |           | 14.5      | Disposal . . . . .  | 120        |
|           |  |           | 14.5.1    | Removing the measuring device . . . . .                           | 120        |
|           |  |           | 14.5.2    | Disposing of the measuring device . . . . .                       | 121        |

---

|                    |  |            |
|--------------------|--|------------|
| <b>15</b>          | <b>Accessories</b> .....                 | <b>122</b> |
| 15.1               | Device-specific accessories .....        | 122        |
| 15.1.1             | For the transmitter .....                | 122        |
| 15.1.2             | For the sensor .....                     | 123        |
| 15.2               | Communication-specific accessories ..... | 123        |
| 15.3               | Service-specific accessories .....       | 124        |
| 15.4               | System components .....                  | 125        |
| <br>               |  |            |
| <b>16</b>          | <b>Technical data</b> .....              | <b>126</b> |
| 16.1               | Application .....                        | 126        |
| 16.2               | Function and system design .....         | 126        |
| 16.3               | Input .....                              | 127        |
| 16.4               | Output .....                             | 128        |
| 16.5               | Power supply .....                       | 131        |
| 16.6               | Performance characteristics .....        | 133        |
| 16.7               | Installation .....                       | 137        |
| 16.8               | Environment .....                        | 137        |
| 16.9               | Process .....                            | 138        |
| 16.10              | Mechanical construction .....            | 139        |
| 16.11              | Operability .....                        | 143        |
| 16.12              | Certificates and approvals .....         | 145        |
| 16.13              | Application packages .....               | 147        |
| 16.14              | Accessories .....                        | 147        |
| 16.15              | Supplementary documentation .....        | 148        |
| <br>               |  |            |
| <b>Index</b> ..... |  | <b>150</b> |

# 1 About this document

## 1.1 Document function

These Operating Instructions contain all the information that is required in various phases of the life cycle of the device: from product identification, incoming acceptance and storage, to mounting, connection, operation and commissioning through to troubleshooting, maintenance and disposal.

## 1.2 Symbols

### 1.2.1 Safety symbols

#### **DANGER**

This symbol alerts you to a dangerous situation. Failure to avoid this situation will result in serious or fatal injury.

#### **WARNING**

This symbol alerts you to a dangerous situation. Failure to avoid this situation can result in serious or fatal injury.





#### **CAUTION**

This symbol alerts you to a dangerous situation. Failure to avoid this situation can result in minor or medium injury.

#### **NOTICE**

This symbol contains information on procedures and other facts which do not result in personal injury.



### 1.2.2 Electrical symbols

| Symbol  | Meaning   |
|---|---|
|  | Direct current  |
|  | Alternating current   |
|  | Direct current and alternating current  |
|  | <b>Ground connection</b><br>A grounded terminal which, as far as the operator is concerned, is grounded via a grounding system.   |
|  | <b>Protective Earth (PE)</b><br>A terminal which must be connected to ground prior to establishing any other connections.<br><br>The ground terminals are situated inside and outside the device: <ul style="list-style-type: none"> <li>▪ Inner ground terminal: Connects the protectiv earth to the mains supply.</li> <li>▪ Outer ground terminal: Connects the device to the plant grounding system.</li> </ul> |













### 1.2.3 Communication symbols

| Symbol  | Meaning   |
|---|---|
|  | <b>Wireless Local Area Network (WLAN)</b><br>Communication via a wireless, local network. |





### 1.2.4 Tool symbols

| Symbol  | Meaning                |
|---|------------------------|
|  | Flat blade screwdriver |
|  | Allen key              |
|  | Open-ended wrench      |

### 1.2.5 Symbols for certain types of information

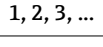
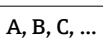
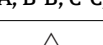
| Symbol  | Meaning  |
|---|--|
|    | <b>Permitted</b><br>Procedures, processes or actions that are permitted. |
|    | <b>Preferred</b><br>Procedures, processes or actions that are preferred. |
|    | <b>Forbidden</b><br>Procedures, processes or actions that are forbidden. |
|    | <b>Tip</b><br>Indicates additional information.                          |
|   | Reference to documentation.  |
|  | Reference to page.   |
|  | Reference to graphic.  |
|  | Notice or individual step to be observed.                                |
|  | Series of steps.   |
|  | Result of a step.  |
|  | Help in the event of a problem.  |
|  | Visual inspection.   |

### 1.2.6 Symbols in graphics

| Symbol  | Meaning                        |
|---|--------------------------------|
|  | Item numbers                   |
|  | Series of steps                |
|  | Views                          |
|  | Sections                       |
|  | Hazardous area                 |
|  | Safe area (non-hazardous area) |
|  | Flow direction                 |

## 1.3 Documentation

 For an overview of the scope of the associated Technical Documentation, refer to the following:

- *W@M Device Viewer* ([www.endress.com/deviceviewer](http://www.endress.com/deviceviewer)): Enter the serial number from nameplate
- *Endress+Hauser Operations App*: Enter the serial number from the nameplate or scan the 2D matrix code (QR code) on the nameplate

 Detailed list of the individual documents along with the documentation code  
→  148

### 1.3.1 Standard documentation

| Document type                            | Purpose and content of the document   |
|--|---|
| Technical Information                    | <b>Planning aid for your device</b><br>The document contains all the technical data on the device and provides an overview of the accessories and other products that can be ordered for the device.  |
| Sensor Brief Operating Instructions      | <b>Guides you quickly to the 1st measured value - Part 1</b><br>The Sensor Brief Operating Instructions are aimed at specialists with responsibility for installing the measuring device. <ul style="list-style-type: none"> <li>▪ Incoming acceptance and product identification</li> <li>▪ Storage and transport</li> <li>▪ Installation</li> </ul>   |
| Transmitter Brief Operating Instructions | <b>Guides you quickly to the 1st measured value - Part 2</b><br>The Transmitter Brief Operating Instructions are aimed at specialists with responsibility for commissioning, configuring and parameterizing the measuring device (until the first measured value). <ul style="list-style-type: none"> <li>▪ Product description</li> <li>▪ Installation</li> <li>▪ Electrical connection</li> <li>▪ Operation options</li> <li>▪ System integration</li> <li>▪ Commissioning</li> <li>▪ Diagnostic information</li> </ul> |
| Description of Device Parameters         | <b>Reference for your parameters</b><br>The document provides a detailed explanation of each individual parameter in the Expert operating menu. The description is aimed at those who work with the device over the entire life cycle and perform specific configurations.  |

### 1.3.2 Supplementary device-dependent documentation

Additional documents are supplied depending on the device version ordered: Always comply strictly with the instructions in the supplementary documentation. The supplementary documentation is an integral part of the device documentation.

## 1.4 Registered trademarks

**HART®**

Registered trademark of the FieldComm Group, Austin, Texas, USA

**TRI-CLAMP®**

Registered trademark of Ladish & Co., Inc., Kenosha, USA



## 2 Safety instructions

### 2.1 Requirements for the personnel

The personnel for installation, commissioning, diagnostics and maintenance must fulfill the following requirements:

- ▶ Trained, qualified specialists must have a relevant qualification for this specific function and task.
- ▶ Are authorized by the plant owner/operator.
- ▶ Are familiar with federal/national regulations.
- ▶ Before starting work, read and understand the instructions in the manual and supplementary documentation as well as the certificates (depending on the application).
- ▶ Follow instructions and comply with basic conditions.

The operating personnel must fulfill the following requirements:

- ▶ Are instructed and authorized according to the requirements of the task by the facility's owner-operator.
- ▶ Follow the instructions in this manual.

### 2.2 Designated use

#### Application and media

- The measuring device described in this manual is intended only for the flow measurement of liquids and gases.
- The measuring device described in this manual is intended only for flow measurement of liquids with a minimum conductivity of 20  $\mu\text{S}/\text{cm}$ .

Depending on the version ordered, the measuring device can also measure potentially explosive, flammable, poisonous and oxidizing media.

Measuring devices for use in hazardous areas, in hygienic applications or where there is an increased risk due to process pressure, are labeled accordingly on the nameplate.

To ensure that the measuring device remains in proper condition for the operation time:

- ▶ Keep within the specified pressure and temperature range.
- ▶ Only use the measuring device in full compliance with the data on the nameplate and the general conditions listed in the Operating Instructions and supplementary documentation.
- ▶ Based on the nameplate, check whether the ordered device is permitted for the intended use in the hazardous area (e.g. explosion protection, pressure vessel safety).
- ▶ Use the measuring device only for media to which the process-wetted materials are sufficiently resistant.
- ▶ If the ambient temperature of the measuring device is outside the atmospheric temperature, it is absolutely essential to comply with the relevant basic conditions as specified in the device documentation →  8.
- ▶ Protect the measuring device permanently against corrosion from environmental influences.

#### Incorrect use

Non-designated use can compromise safety. The manufacturer is not liable for damage caused by improper or non-designated use.

#### WARNING

#### Danger of breakage due to corrosive or abrasive fluids and ambient conditions!

- ▶ Verify the compatibility of the process fluid with the sensor material.
- ▶ Ensure the resistance of all fluid-wetted materials in the process.
- ▶ Keep within the specified pressure and temperature range.

**NOTICE****Verification for borderline cases:**

- ▶ For special fluids and fluids for cleaning, Endress+Hauser is glad to provide assistance in verifying the corrosion resistance of fluid-wetted materials, but does not accept any warranty or liability as minute changes in the temperature, concentration or level of contamination in the process can alter the corrosion resistance properties.

**Residual risks****⚠ WARNING**

**The electronics and the medium may cause the surfaces to heat up. This presents a burn hazard!**

- ▶ For elevated fluid temperatures, ensure protection against contact to prevent burns.

**⚠ WARNING**

**Danger of housing breaking due to measuring tube breakage!**

If a measuring tube ruptures, the pressure inside the sensor housing will rise according to the operating process pressure.

- ▶ Use a rupture disk.

**⚠ WARNING**

**Danger from medium escaping!**

For device versions with a rupture disk: medium escaping under pressure can cause injury or material damage.

- ▶ Take precautions to prevent injury and material damage if the rupture disk is actuated.

## 2.3 Workplace safety

For work on and with the device:

- ▶ Wear the required personal protective equipment according to federal/national regulations.

For welding work on the piping:

- ▶ Do not ground the welding unit via the measuring device.

If working on and with the device with wet hands:

- ▶ Due to the increased risk of electric shock, gloves must be worn.

## 2.4 Operational safety

Risk of injury.

- ▶ Operate the device in proper technical condition and fail-safe condition only.
- ▶ The operator is responsible for interference-free operation of the device.

**Conversions to the device**

Unauthorized modifications to the device are not permitted and can lead to unforeseeable dangers.

- ▶ If, despite this, modifications are required, consult with Endress+Hauser.

**Repair**

To ensure continued operational safety and reliability,

- ▶ Carry out repairs on the device only if they are expressly permitted.
- ▶ Observe federal/national regulations pertaining to repair of an electrical device.
- ▶ Use original spare parts and accessories from Endress+Hauser only.

## 2.5 Product safety

This measuring device is designed in accordance with good engineering practice to meet state-of-the-art safety requirements, has been tested, and left the factory in a condition in which it is safe to operate.

It meets general safety standards and legal requirements. It also complies with the EU directives listed in the device-specific EU Declaration of Conformity. Endress+Hauser confirms this by affixing the CE mark to the device.

## 2.6 IT security

Our warranty is valid only if the device is installed and used as described in the Operating Instructions. The device is equipped with security mechanisms to protect it against any inadvertent changes to the settings.

IT security measures, which provide additional protection for the device and associated data transfer, must be implemented by the operators themselves in line with their security standards.

## 2.7 Device-specific IT security

The device offers a range of specific functions to support protective measures on the operator's side. These functions can be configured by the user and guarantee greater in-operation safety if used correctly. An overview of the most important functions is provided in the following section.

### 2.7.1 Protecting access via hardware write protection

Write access to the device parameters via the local display or operating tool (e.g. FieldCare, DeviceCare) can be disabled via a write protection switch (DIP switch on the motherboard). When hardware write protection is enabled, only read access to the parameters is possible.

### 2.7.2 Protecting access via a password

A password can be used to protect against write access to the device parameters.

This password locks write access to the device parameters via the local display or another operating tool (e.g. FieldCare, DeviceCare) and, in terms of functionality, is equivalent to hardware write protection. If the service interface CDI RJ-45 is used, read access is only possible if the password is entered.

#### User-specific access code

Write access to the device parameters via the local display or operating tool (e.g. FieldCare, DeviceCare) can be protected by the modifiable, user-specific access code (→  89).

When the device is delivered, the device does not have an access code and is equivalent to 0000 (open).

#### General notes on the use of passwords

- The access code and network key supplied with the device should be changed during commissioning.
- Follow the general rules for generating a secure password when defining and managing the access code or network key.
- The user is responsible for the management and careful handling of the access code and network key.
- For information on configuring the access code or on what to do if you lose the password, see the "Write protection via access code" section →  89

### **2.7.3 Access via fieldbus**

Cyclic fieldbus communication (read and write, e.g. measured value transmission) with a higher-order system is not affected by the restrictions mentioned above.

### 3 Product description

The device consists of a transmitter and a sensor.

The device is available as a compact version:

The transmitter and sensor form a mechanical unit.

#### 3.1 Product design

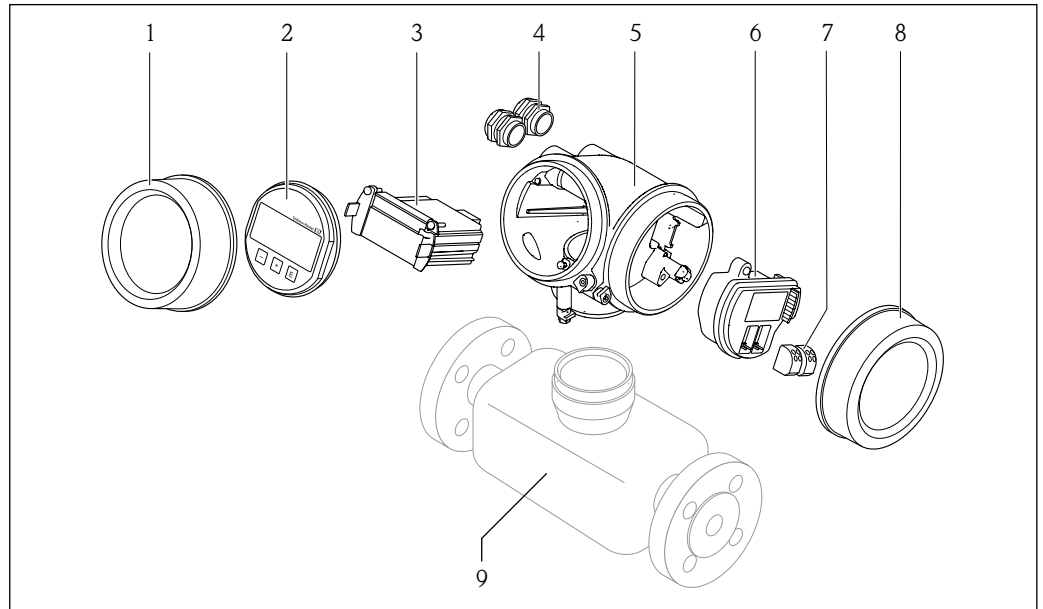

A0014056

##### 1 Important components of a measuring device

- 1 Electronics compartment cover
- 2 Display module
- 3 Main electronics module
- 4 Cable glands
- 5 Transmitter housing (incl. integrated HistoROM)
- 6 I/O electronics module
- 7 Terminals (pluggable spring terminals)
- 8 Connection compartment cover
- 9 Sensor

## 4 Incoming acceptance and product identification

### 4.1 Incoming acceptance

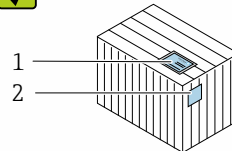
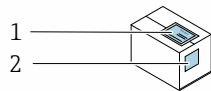

Are the order codes on the delivery note (1) and the product sticker (2) identical?

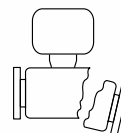
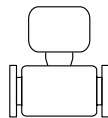
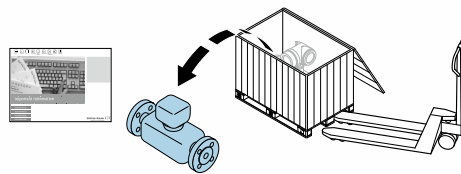

Are the goods undamaged?

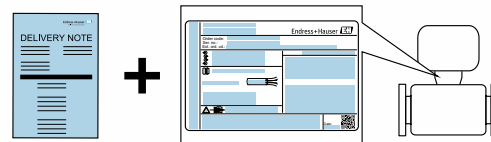

Do the nameplate data match the ordering information on the delivery note?



Is the envelope present with accompanying documents?



- If one of the conditions is not satisfied, contact your Endress+Hauser Sales Center.
- Depending on the device version, the CD-ROM might not be part of the delivery! The Technical Documentation is available via the Internet or via the *Endress+Hauser Operations App*, see the "Product identification" section → 15.

### 4.2 Product identification

The following options are available for identification of the device:

- Nameplate specifications
- Order code with breakdown of the device features on the delivery note
- Enter serial numbers from nameplates in the *W@M Device Viewer* ([www.endress.com/deviceviewer](http://www.endress.com/deviceviewer)): All information about the device is displayed.
- Enter the serial number from nameplates in the *Endress+Hauser Operations App* or scan the 2-D matrix code (QR code) on the nameplate using the *Endress+Hauser Operations App*: All information about the device is displayed.

For an overview of the scope of the associated Technical Documentation, refer to the following:

- The "Additional standard documentation on the device" → 8 and "Supplementary device-dependent documentation" → 8 sections
- The *W@M Device Viewer*: enter the serial number from the nameplate ([www.endress.com/deviceviewer](http://www.endress.com/deviceviewer))
- The *Endress+Hauser Operations App*: Enter the serial number from the nameplate or scan the 2-D matrix code (QR code) on the nameplate.

#### 4.2.1 Transmitter nameplate

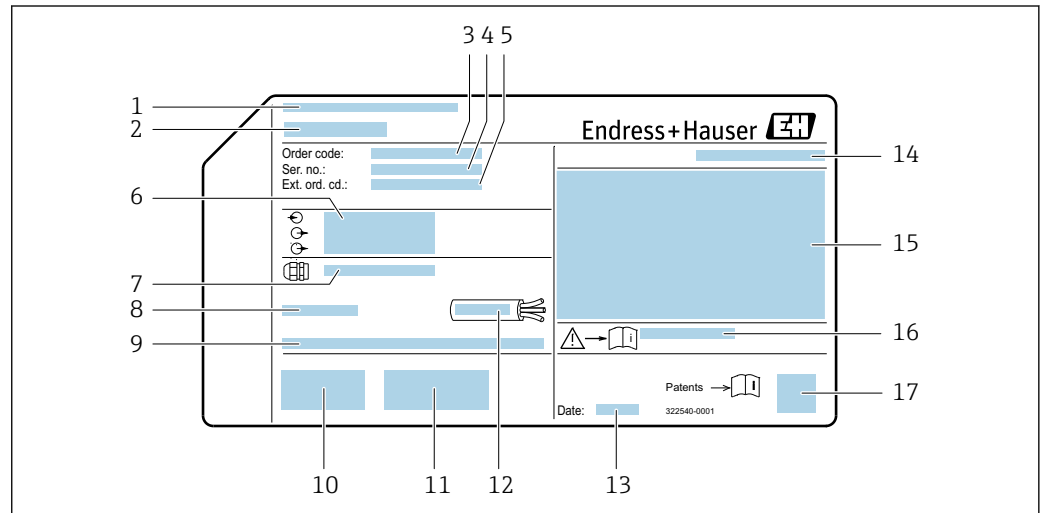

A0032237

2 Example of a transmitter nameplate

- 1 Manufacturing location
- 2 Name of the transmitter
- 3 Order code
- 4 Serial number (ser. no.)
- 5 Extended order code (Ext. ord. cd.)
- 6 Electrical connection data, e.g. available inputs and outputs, supply voltage
- 7 Type of cable glands
- 8 Permitted ambient temperature ( $T_a$ )
- 9 Firmware version (FW) and device revision (Dev.Rev.) from the factory
- 10 CE mark, C-Tick
- 11 Additional information on version: certificates, approvals
- 12 Permitted temperature range for cable
- 13 Manufacturing date: year-month
- 14 Degree of protection
- 15 Approval information for explosion protection
- 16 Document number of safety-related supplementary documentation → 148
- 17 2-D matrix code

## 4.2.2 Sensor nameplate

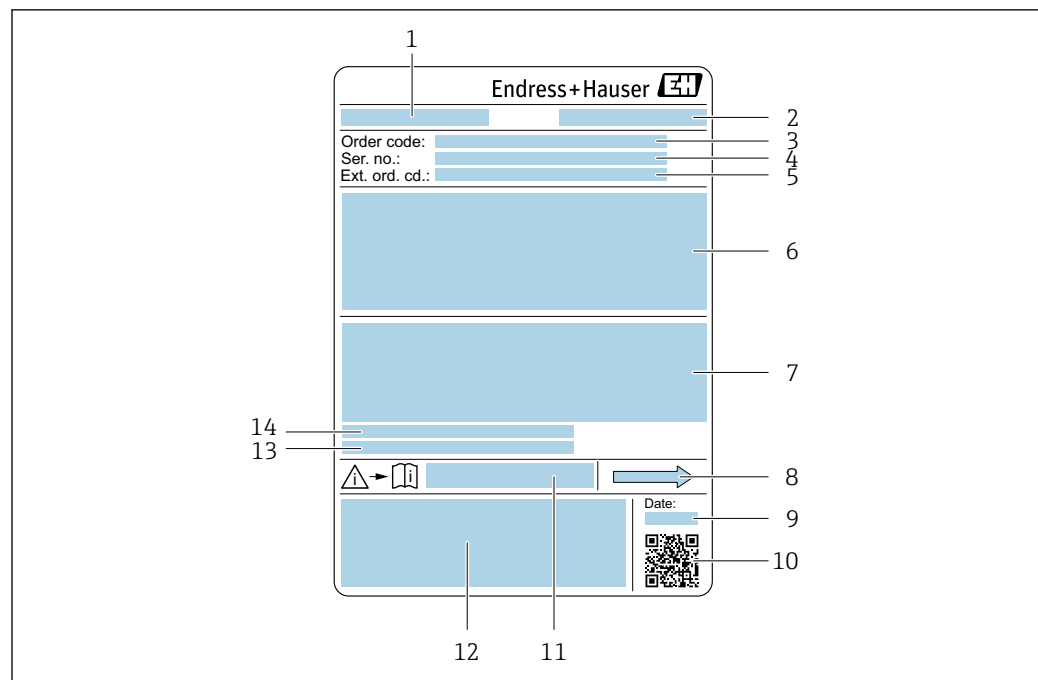

A0029199

 3 Example of a sensor nameplate

- 1 Name of the sensor
- 2 Manufacturing location
- 3 Order code
- 4 Serial number (ser. no.)
- 5 Extended order code (Ext. ord. cd.)
- 6 Nominal diameter of the sensor; flange nominal diameter/nominal pressure; sensor test pressure; medium temperature range; material of measuring tube and manifold; sensor-specific information: e.g. pressure range of sensor housing, wide-range density specification (special density calibration)
- 7 Approval information for explosion protection, Pressure Equipment Directive and degree of protection
- 8 Flow direction
- 9 Manufacturing date: year-month
- 10 2-D matrix code
- 11 Document number of safety-related supplementary documentation
- 12 CE mark, C-Tick
- 13 Surface roughness
- 14 Permitted ambient temperature ( $T_a$ )

### Order code



The measuring device is reordered using the order code.

#### Extended order code

- The device type (product root) and basic specifications (mandatory features) are always listed.
- Of the optional specifications (optional features), only the safety and approval-related specifications are listed (e.g. LA). If other optional specifications are also ordered, these are indicated collectively using the # placeholder symbol (e.g. #LA#).
- If the ordered optional specifications do not include any safety and approval-related specifications, they are indicated by the + placeholder symbol (e.g. XXXXXX-ABCDE+).



### 4.2.3 Symbols on measuring device

| Symbol  | Meaning  |
|---|--|
|  | <b>WARNING!</b><br>This symbol alerts you to a dangerous situation. Failure to avoid this situation can result in serious or fatal injury. |
|  | <b>Reference to documentation</b><br>Refers to the corresponding device documentation.   |
|  | <b>Protective ground connection</b><br>A terminal which must be connected to ground prior to establishing any other connections.           |

## 5 Storage and transport

### 5.1 Storage conditions

Observe the following notes for storage:

- ▶ Store in the original packaging to ensure protection from shock.
- ▶ Do not remove protective covers or protective caps installed on process connections. They prevent mechanical damage to the sealing surfaces and contamination in the measuring tube.
- ▶ Protect from direct sunlight to avoid unacceptably high surface temperatures.
- ▶ Store in a dry and dust-free place.
- ▶ Do not store outdoors.

Storage temperature →  137

### 5.2 Transporting the product

Transport the measuring device to the measuring point in the original packaging.

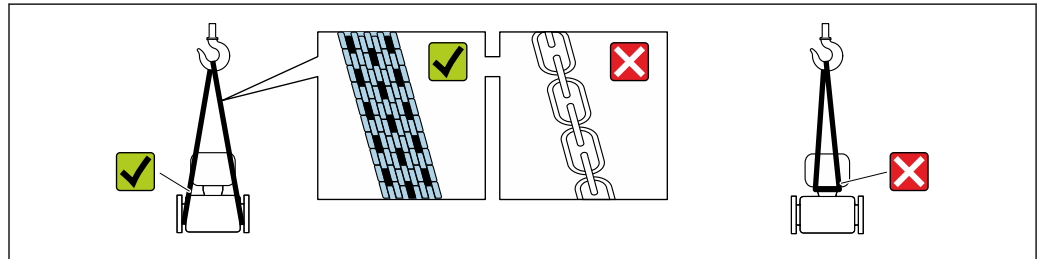

A0029252

-  Do not remove protective covers or caps installed on process connections. They prevent mechanical damage to the sealing surfaces and contamination in the measuring tube.

#### 5.2.1 Measuring devices without lifting lugs

##### WARNING

**Center of gravity of the measuring device is higher than the suspension points of the webbing slings.**

Risk of injury if the measuring device slips.

- ▶ Secure the measuring device against slipping or turning.
- ▶ Observe the weight specified on the packaging (stick-on label).

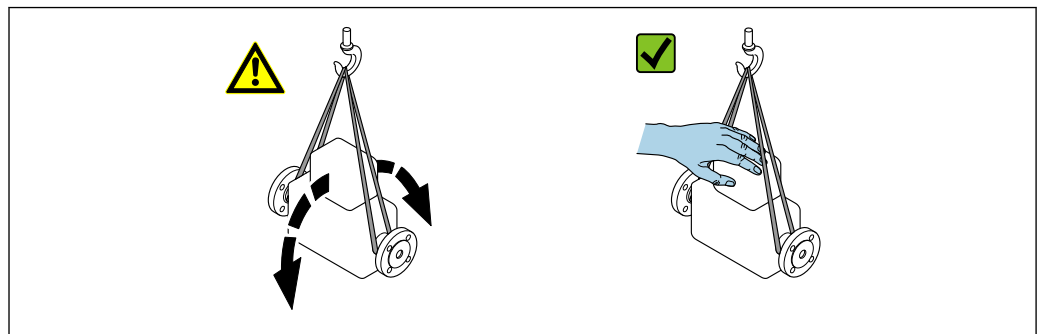

A0029214

### 5.2.2 Measuring devices with lifting lugs

**⚠ CAUTION**

**Special transportation instructions for devices with lifting lugs**

- ▶ Only use the lifting lugs fitted on the device or flanges to transport the device.
- ▶ The device must always be secured at two lifting lugs at least.

### 5.2.3 Transporting with a fork lift

If transporting in wood crates, the floor structure enables the crates to be lifted lengthwise or at both sides using a forklift.

## 5.3 Packaging disposal

All packaging materials are environmentally friendly and 100 % recyclable:

- Outer packaging of device
  - Polymer stretch wrap that complies with EU Directive 2002/95/EC (RoHS)
- Packaging
  - Wooden crate treated in accordance with ISPM 15 standard, confirmed by IPPC logo
  - Cardboard box in accordance with European packaging guideline 94/62EC, recyclability confirmed by Resy symbol
- Carrying and securing materials
  - Disposable plastic pallet
  - Plastic straps
  - Plastic adhesive strips
- Filler material
  - Paper pads

## 6 Installation

### 6.1 Installation conditions

#### 6.1.1 Mounting position

##### Mounting location

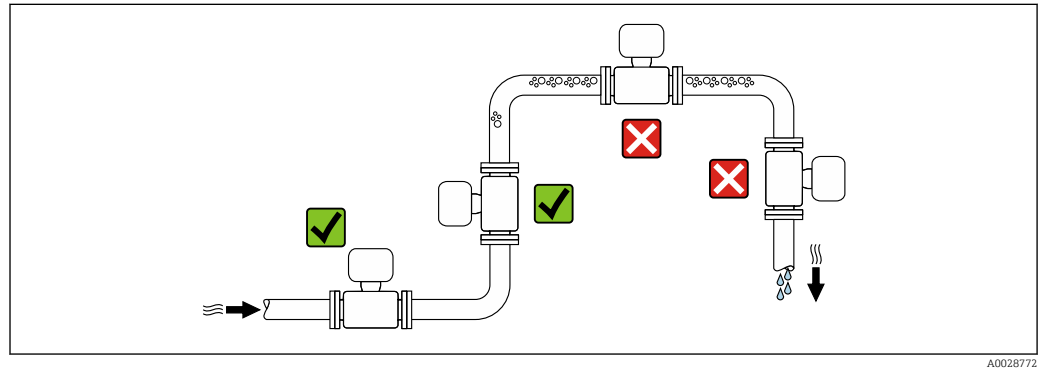



To prevent measuring errors arising from accumulation of gas bubbles in the measuring tube, avoid the following mounting locations in the pipe:

- Highest point of a pipeline.
- Directly upstream of a free pipe outlet in a down pipe.

##### Installation in down pipes

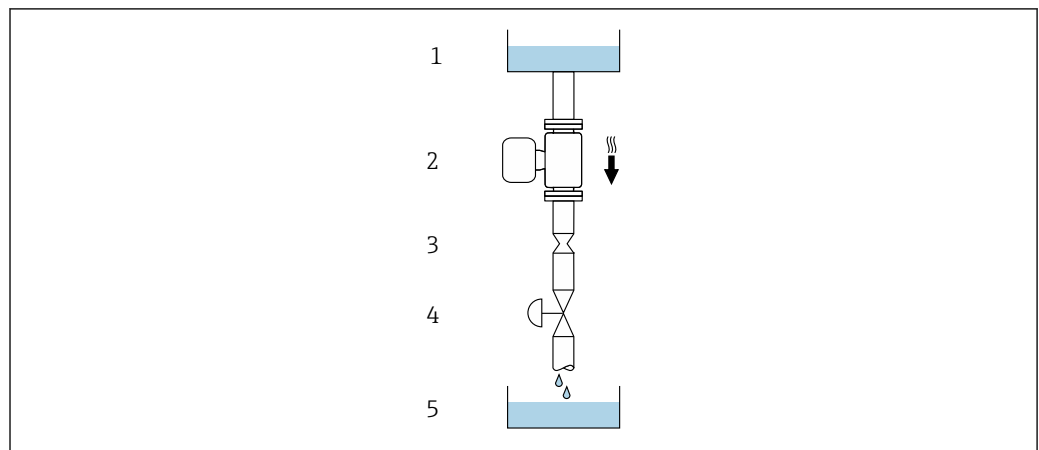
However, the following installation suggestion allows for installation in an open vertical pipeline. Pipe restrictions or the use of an orifice with a smaller cross-section than the nominal diameter prevent the sensor running empty while measurement is in progress.





 4 Installation in a down pipe (e.g. for batching applications)

- 1 Supply tank
- 2 Sensor
- 3 Orifice plate, pipe restriction
- 4 Valve
- 5 Batching tank

| DN   |      | Ø orifice plate, pipe restriction |      |
|------|------|-----------------------------------|------|
| [mm] | [in] | [mm]                              | [in] |
| 1    | 1/24 | 0.8                               | 0.03 |
| 2    | 1/12 | 1.5                               | 0.06 |
| 4    | 1/6  | 3.0                               | 0.12 |

**Orientation**

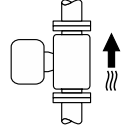
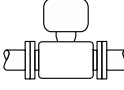
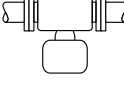
The direction of the arrow on the sensor nameplate helps you to install the sensor according to the flow direction (direction of medium flow through the piping).

| Orientation |   | Recommendation  |                  |
|-------------|---|---|------------------|
| <b>A</b>    | Vertical orientation                          | <br>A0015591   | ☑☑ <sup>1)</sup> |
| <b>B</b>    | Horizontal orientation, transmitter at top    | <br>A0015589   | ☑ <sup>2)</sup>  |
| <b>C</b>    | Horizontal orientation, transmitter at bottom | <br>A0015590  | ☑ <sup>3)</sup>  |
| <b>D</b>    | Horizontal orientation, transmitter at side   | <br>A0015592 | ☑                |

- 1) This orientation is recommended to ensure self-draining.
- 2) Applications with low process temperatures may decrease the ambient temperature. To maintain the minimum ambient temperature for the transmitter, this orientation is recommended.
- 3) Applications with high process temperatures may increase the ambient temperature. To maintain the maximum ambient temperature for the transmitter, this orientation is recommended.

If a sensor is installed horizontally with a curved measuring tube, match the position of the sensor to the fluid properties.

**Inlet and outlet runs**

No special precautions need to be taken for fittings which create turbulence, such as valves, elbows or T-pieces, as long as no cavitation occurs → 22.

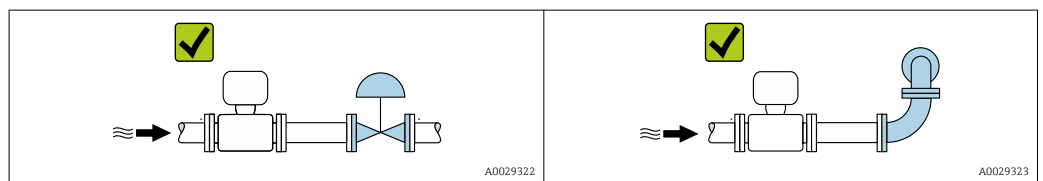

*Installation dimensions*

 For the dimensions and installation lengths of the device, see the "Technical Information" document, "Mechanical construction" section.

## 6.1.2 Environmental and process requirements

### Ambient temperature range

|                                  |  |
|----------------------------------|--|
| Measuring device                 | -40 to +60 °C (-40 to +140 °F)   |
| Readability of the local display | -20 to +60 °C (-4 to +140 °F)<br>The readability of the display may be impaired at temperatures outside the temperature range. |

- ▶ If operating outdoors:  
Avoid direct sunlight, particularly in warm climatic regions.

**i** You can order a weather protection cover from Endress+Hauser. →  122.

### System pressure

It is important that cavitation does not occur, or that gases entrained in the liquids do not outgas.

Cavitation is caused if the pressure drops below the vapor pressure:

- In liquids that have a low boiling point (e.g. hydrocarbons, solvents, liquefied gases)
- In suction lines

- ▶ Ensure the system pressure is sufficiently high to prevent cavitation and outgassing.

For this reason, the following mounting locations are recommended:

- At the lowest point in a vertical pipe
- Downstream from pumps (no danger of vacuum)

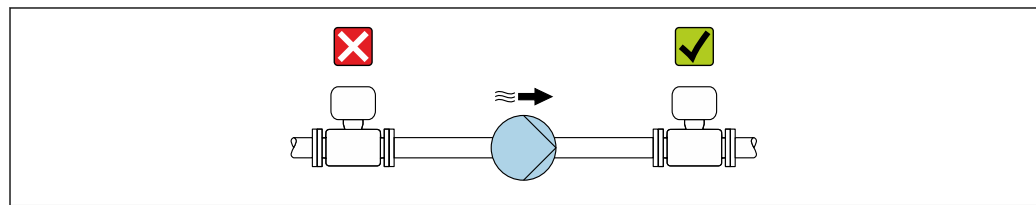

A0028777

### Thermal insulation

In the case of some fluids, it is important to keep the heat radiated from the sensor to the transmitter to a low level. A wide range of materials can be used for the required insulation.

#### NOTICE

#### Electronics overheating on account of thermal insulation!

- ▶ Recommended orientation: horizontal orientation, transmitter housing pointing downwards.
- ▶ Do not insulate the transmitter housing.
- ▶ Maximum permissible temperature at the lower end of the transmitter housing: 80 °C (176 °F)
- ▶ Thermal insulation with extended neck free: We recommend that you do not insulate the extended neck in order to ensure optimum dissipation of heat.

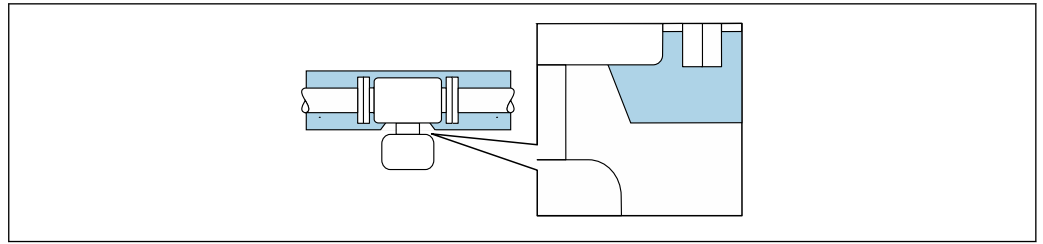

5 Thermal insulation with extended neck free

A0034391

## Heating

### NOTICE

#### Electronics can overheat due to elevated ambient temperature!

- ▶ Observe maximum permitted ambient temperature for the transmitter .
- ▶ Depending on the fluid temperature, take the device orientation requirements into account .

### NOTICE

#### Danger of overheating when heating

- ▶ Ensure that the temperature at the lower end of the transmitter housing does not exceed 80 °C (176 °F).
- ▶ Ensure that sufficient convection takes place at the transmitter neck.
- ▶ Ensure that a sufficiently large area of the transmitter neck remains exposed. The uncovered part serves as a radiator and protects the electronics from overheating and excessive cooling.
- ▶ When using in potentially explosive atmospheres, observe the information in the device-specific Ex documentation. For detailed information on the temperature tables, see the separate document entitled "Safety Instructions" (XA) for the device.

#### Heating options

If a fluid requires that no heat loss should occur at the sensor, users can avail of the following heating options:

- Electrical heating, e.g. with electric band heaters
- Via pipes carrying hot water or steam
- Via heating jackets

## Vibrations

The high oscillation frequency of the measuring tubes ensures that the correct operation of the measuring system is not influenced by plant vibrations.

### 6.1.3 Special mounting instructions

#### Drainability

When the device is installed in a vertical position, the measuring tube can be drained completely and protected against deposit buildup if the properties of the measured liquid allow this. Furthermore, as only one measuring tube is used the flow is not impeded and the risk of product being retained in the measuring device is reduced to a minimum. The larger internal diameter of the measuring tube <sup>1)</sup> also reduces the risk of particles getting trapped in the measuring system. Due to the larger cross-section of the individual measuring tube, the tube is also generally less susceptible to clogging.

1) Compared with the double-tube design with a similar flow capacity and measuring tubes with a smaller internal diameter

### Sanitary compatibility

**i** When installing in hygienic applications, please refer to the information in the "Certificates and approvals/hygienic compatibility" section →  145

### Rupture disk

Information that is relevant to the process: →  139.

#### **⚠ WARNING**

#### **Danger from medium escaping!**

Medium escaping under pressure can cause injury or material damage.

- ▶ Take precautions to prevent danger to persons and damage if the rupture disk is actuated.
- ▶ Observe information on the rupture disk sticker.
- ▶ Make sure that the function and operation of the rupture disk is not impeded through the installation of the device.
- ▶ Do not remove or damage the rupture disk, drain connection and warning signs.

The position of the rupture disk is indicated by an affixed sticker. In versions without a drain connection (order option CU), the sticker is destroyed if the rupture disk is triggered. The disk can therefore be visually monitored.

To allow any escaping medium to drain in a controlled manner, a drain connection is available for the rupture disk integrated in the sensor: order code for "Sensor option", option CU "Drain connection for rupture disk". This connection is intended for a pipe connection with a 1/4" NPT thread and sealed with a grip plug for protection. To guarantee the function of the rupture disk with a drain connection, the drain connection must be connected to the drain system in a hermetically tight manner.

**i** The drain connection is firmly mounted in place by the manufacturer and may not be removed.

**i** It is not possible to use the holder with a measuring device with a drain connection for a rupture disk: order code for "Sensor option", option CU "Drain connection for rupture disk"

**i** It is not possible to use a heating jacket if the drain connection is used: order code for "Sensor option", option CU "Drain connection for rupture disk"

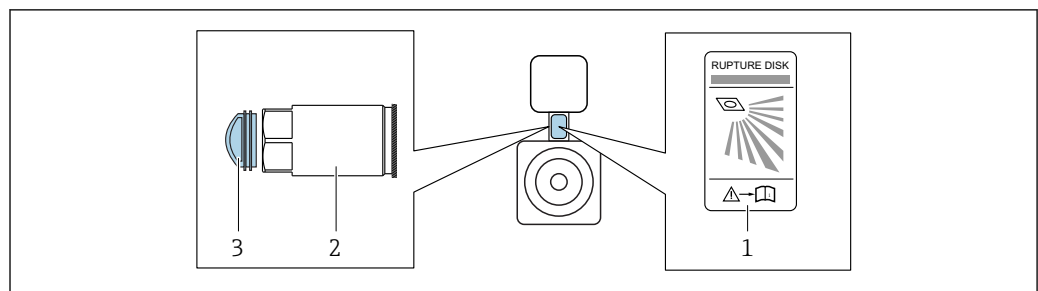

A0042344

- 1 Rupture disk label
- 2 Drain connection for rupture disk with 1/4" NPT female thread and 17mm width across flats (AF): order code for "Sensor option", option CU, drain connection for rupture disk
- 3 Transportation guard

**i** For information on the dimensions: see the "Mechanical construction" section of the "Technical Information" document

### Sensor holder

The sensor holder is used to secure the device to a wall, tabletop or pipe (order code for "Accessory enclosed", option PR).



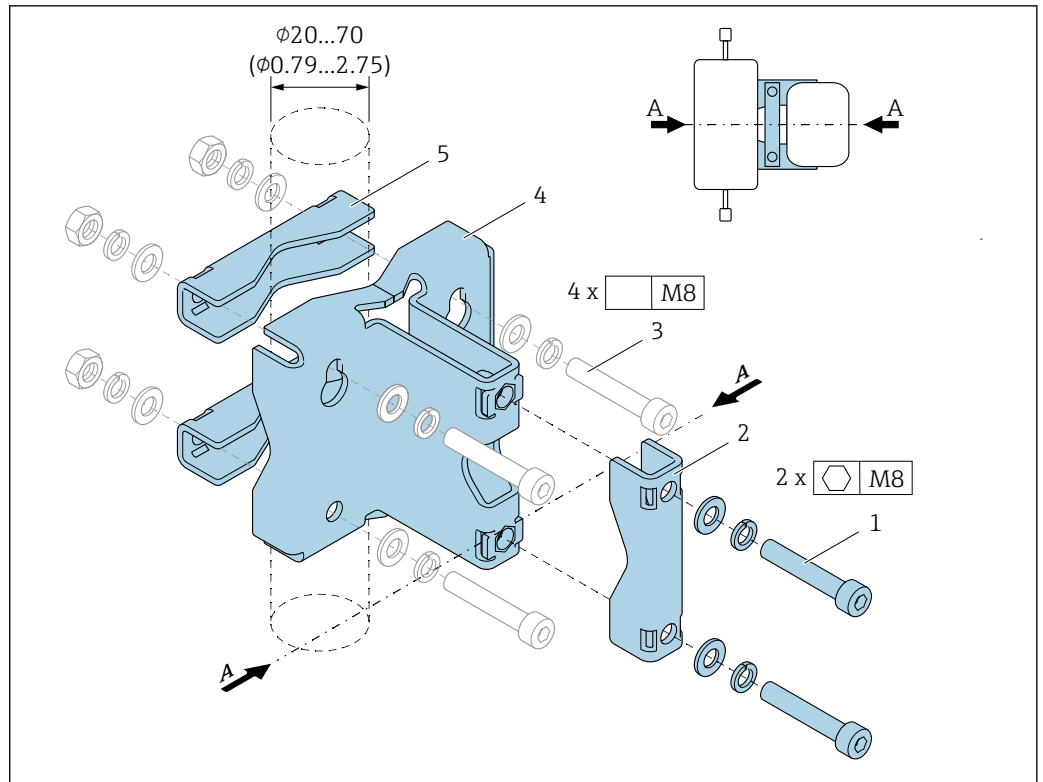

- 1 2 x Allen screw M8 x 50, washer and spring washer A4
- 2 1 x clamp (measuring device neck)
- 3 4 x securing screw for wall, tabletop or pipe mounting (not supplied)
- 4 1 x base profile
- 5 2 x clamp (pipe mounting)
- A Measuring device central line

If the holder is used with a measuring device fitted with a rupture disk, it is important to ensure that the rupture disk in the neck is not covered over and that the cover of the rupture disk is not damaged.

**i** Lubricate all threaded joints prior to mounting. The screws for wall, tabletop or pipe mounting are not supplied with the device and must be chosen to suit the individual installation position.

**⚠ WARNING**

**Strain on pipes!**

Excessive strain on an unsupported pipe can cause the pipe to break.

- Install the sensor in a pipe that is adequately supported.

The following mounting versions are recommended for the installation:

Use of the sensor holder.

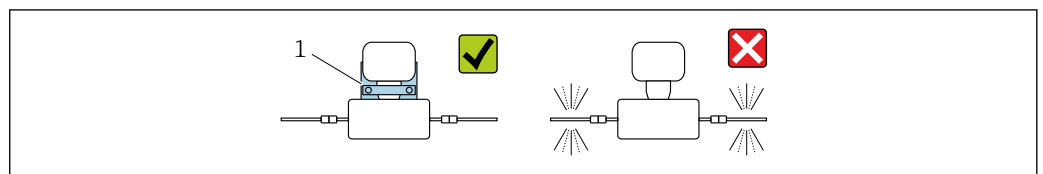

- 1 Sensor holder (order code for "Accessory enclosed", option PR)

### *Mounting on a wall*

Screw the sensor holder to the wall with four screws. Two of the four holes to secure the holder are designed to hook into the screws.

### *Mounting on a table*

Screw the sensor holder onto the tabletop with four screws.

### *Mounting on a pipe*

Secure the sensor holder to the pipe with two clamps.

## **Zero point adjustment**

All measuring devices are calibrated in accordance with state-of-the-art technology. Calibration takes place under reference conditions →  133. Therefore, a zero point adjustment in the field is generally not required.

Experience shows that zero point adjustment is advisable only in special cases:

- To achieve maximum measuring accuracy even with low flow rates.
- Under extreme process or operating conditions (e.g. very high process temperatures or very high-viscosity fluids).

## **6.2 Mounting the measuring device**

### **6.2.1 Required tools**

#### **For transmitter**

- For turning the transmitter housing: Open-ended wrench 8 mm
- For opening the securing clamps: Allen key 3 mm

#### **For sensor**

For flanges and other process connections: Corresponding mounting tools

### **6.2.2 Preparing the measuring device**

1. Remove all remaining transport packaging.
2. Remove any protective covers or protective caps present from the sensor.
3. Remove stick-on label on the electronics compartment cover.

### **6.2.3 Mounting the measuring device**

#### **WARNING**

#### **Danger due to improper process sealing!**

- ▶ Ensure that the inside diameters of the gaskets are greater than or equal to that of the process connections and piping.
  - ▶ Ensure that the seals are clean and undamaged.
  - ▶ Secure the seals correctly.
1. Ensure that the direction of the arrow on the nameplate of the sensor matches the flow direction of the fluid.

2. Install the measuring device or turn the transmitter housing so that the cable entries do not point upwards.

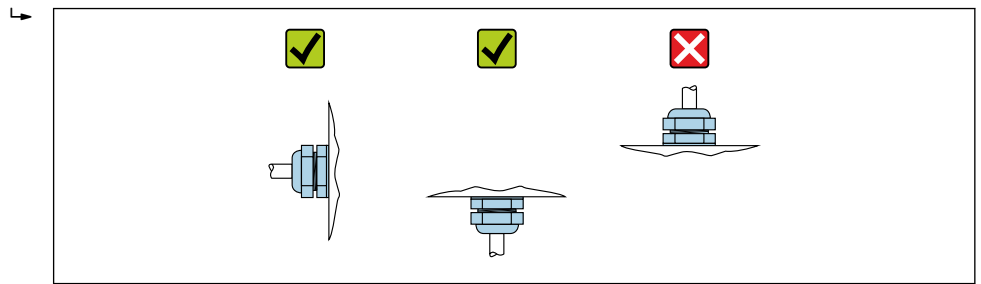

A0029263

### 6.2.4 Turning the transmitter housing

To provide easier access to the connection compartment or display module, the transmitter housing can be turned.

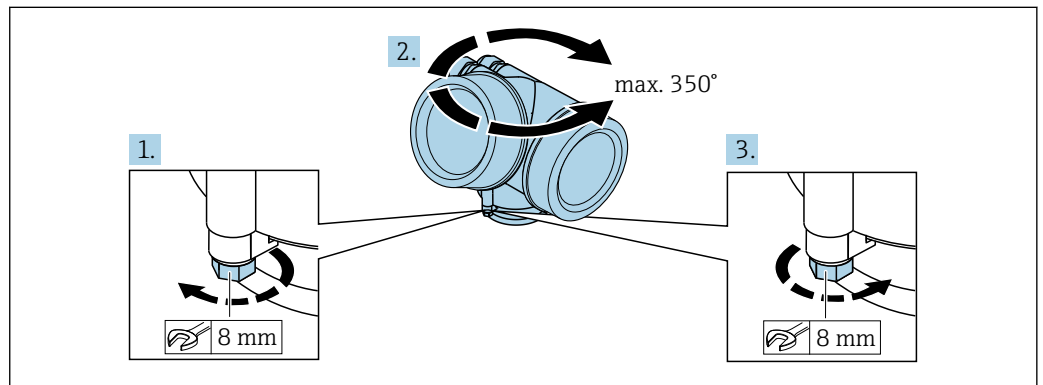

A0032242

1. Release the fixing screw.
2. Turn the housing to the desired position.
3. Firmly tighten the securing screw.

### 6.2.5 Turning the display module

The display module can be turned to optimize display readability and operability.

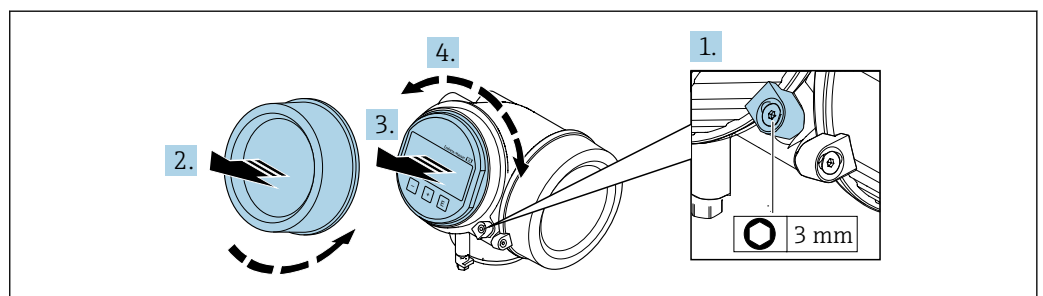



A0032238

1. Loosen the securing clamp of the electronics compartment cover using an Allen key.
2. Unscrew cover of the electronics compartment from the transmitter housing.
3. Optional: pull out the display module with a gentle rotational movement.
4. Turn the display module to the desired position: max.  $8 \times 45^\circ$  in every direction.
5. Without display module pulled out:  
Allow display module to engage at desired position.

6. With display module pulled out:  
Feed the cable into the gap between the housing and main electronics module and plug the display module into the electronics compartment until it engages.
7. Reverse the removal procedure to reassemble the transmitter.

### 6.3 Post-installation check

|  |                          |
|--|--------------------------|
| Is the device undamaged (visual inspection)?   | <input type="checkbox"/> |
| Does the measuring device conform to the measuring point specifications?<br>For example:<br><ul style="list-style-type: none"> <li>▪ Process temperature →  138</li> <li>▪ Process pressure (refer to the section on "Pressure-temperature ratings" in the "Technical Information" document)</li> <li>▪ Ambient temperature</li> <li>▪ Measuring range</li> </ul> | <input type="checkbox"/> |
| Has the correct orientation for the sensor been selected ?<br><ul style="list-style-type: none"> <li>▪ According to sensor type</li> <li>▪ According to medium temperature</li> <li>▪ According to medium properties (outgassing, with entrained solids)</li> </ul>  | <input type="checkbox"/> |
| Does the arrow on the sensor nameplate match the direction of flow of the fluid through the piping →  21?   | <input type="checkbox"/> |
| Are the measuring point identification and labeling correct (visual inspection)?   | <input type="checkbox"/> |
| Is the device adequately protected from precipitation and direct sunlight?   | <input type="checkbox"/> |
| Are the securing screw and securing clamp tightened securely?  | <input type="checkbox"/> |

## 7 Electrical connection

-  The measuring device does not have an internal circuit breaker. For this reason, assign the measuring device a switch or power-circuit breaker so that the power supply line can be easily disconnected from the mains.

### 7.1 Connection conditions

#### 7.1.1 Required tools

- For cable entries: Use corresponding tools
- For securing clamp: Allen key 3 mm
- Wire stripper
- When using stranded cables: Crimper for wire end ferrule
- For removing cables from terminal: Flat blade screwdriver  $\leq 3$  mm (0.12 in)

#### 7.1.2 Connecting cable requirements

The connecting cables provided by the customer must fulfill the following requirements.

##### Electrical safety

In accordance with applicable federal/national regulations.

##### Permitted temperature range

- The installation guidelines that apply in the country of installation must be observed.
- The cables must be suitable for the minimum and maximum temperatures to be expected.

##### Signal cable

*Current output 4 to 20 mA HART*

A shielded cable is recommended. Observe grounding concept of the plant.

*Current output 4 to 20 mA*

Standard installation cable is sufficient.

*Pulse/frequency/switch output*

Standard installation cable is sufficient.

##### Cable diameter

- Cable glands supplied:  
M20  $\times$  1.5 with cable  $\phi$  6 to 12 mm (0.24 to 0.47 in)
- Plug-in spring terminals for device version without integrated overvoltage protection:  
wire cross-sections 0.5 to 2.5 mm<sup>2</sup> (20 to 14 AWG)
- Screw terminals for device version with integrated overvoltage protection: wire cross-sections 0.2 to 2.5 mm<sup>2</sup> (24 to 14 AWG)

### 7.1.3 Terminal assignment

#### Transmitter

4-20 mA HART connection version with additional outputs

|   |  |
|---|--|
|   |  |
| <small>A0013570</small>   | <small>A0018161</small>  |
| <i>Maximum number of terminals, without integrated overvoltage protection</i>   | <i>Maximum number of terminals, with integrated overvoltage protection</i> |
| <p>1 Output 1 (passive): supply voltage and signal transmission<br/>                 2 Output 2 (passive): supply voltage and signal transmission<br/>                 3 Ground terminal for cable shield</p> |  |

| Order code for "Output" | Terminal numbers       |       |   |       |
|-------------------------|------------------------|-------|---|-------|
|                         | Output 1               |       | Output 2                                |       |
|                         | 1 (+)                  | 2 (-) | 3 (+)                                   | 4 (-) |
| Option A                | 4-20 mA HART (passive) |       | -                                       |       |
| Option B <sup>1)</sup>  | 4-20 mA HART (passive) |       | Pulse/frequency/switch output (passive) |       |
| Option C <sup>1)</sup>  | 4-20 mA HART (passive) |       | 4-20 mA analog (passive)                |       |

1) Output 1 must always be used; output 2 is optional.

### 7.1.4 Requirements for the supply unit

#### Supply voltage

##### Transmitter

An external power supply is required for each output.

The following supply voltage values apply for the outputs available:

| Order code for "Output"   | Minimum terminal voltage  | Maximum terminal voltage |
|---|---|--------------------------|
| Option A <sup>1) 2)</sup> : 4-20 mA HART                                | <ul style="list-style-type: none"> <li>■ For 4 mA: ≥ DC 17.9 V</li> <li>■ For 20 mA: ≥ DC 13.5 V</li> </ul> | DC 35 V                  |
| Option B <sup>1) 2)</sup> : 4-20 mA HART, pulse/frequency/switch output | <ul style="list-style-type: none"> <li>■ For 4 mA: ≥ DC 17.9 V</li> <li>■ For 20 mA: ≥ DC 13.5 V</li> </ul> | DC 35 V                  |
| Option C <sup>1) 2)</sup> : 4-20 mA HART + 4-20 mA analog               | <ul style="list-style-type: none"> <li>■ For 4 mA: ≥ DC 17.9 V</li> <li>■ For 20 mA: ≥ DC 13.5 V</li> </ul> | DC 30 V                  |

1) External supply voltage of the power supply unit with load.

2) For device versions with SD03 local display: The terminal voltage must be increased by DC 2 V if backlighting is used.

#### Load

Load for current output: 0 to 500 Ω, depending on the external supply voltage of the power supply unit

### Calculation of the maximum load

Depending on the supply voltage of the power supply unit ( $U_S$ ), the maximum load ( $R_B$ ) including line resistance must be observed to ensure adequate terminal voltage at the device. In doing so, observe the minimum terminal voltage

- For  $U_S = 17.9$  to  $18.9$  V:  $R_B \leq (U_S - 17.9 \text{ V}): 0.0036 \text{ A}$
- For  $U_S = 18.9$  to  $24$  V:  $R_B \leq (U_S - 13 \text{ V}): 0.022 \text{ A}$
- For  $U_S = \geq 24$  V:  $R_B \leq 500 \Omega$

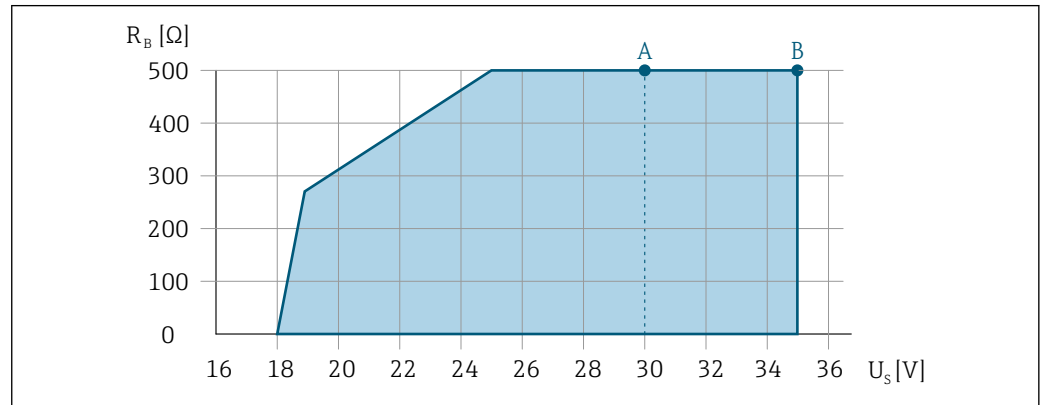

- A Operating range for order code for "Output", option A "4-20 mA HART"/option B "4-20 mA HART, pulse/frequency/switch output" with Ex i and option C "4-20 mA HART + 4-20 mA analog"
- B Operating range for order code for "Output", option A "4-20 mA HART"/option B "4-20 mA HART, pulse/frequency/switch output" with non-Ex and Ex d

### Sample calculation

Supply voltage of power supply unit:  $U_S = 19 \text{ V}$

Maximum load:  $R_B \leq (19 \text{ V} - 13 \text{ V}): 0.022 \text{ A} = 273 \Omega$

## 7.1.5 Preparing the measuring device

### NOTICE

#### Insufficient sealing of the housing!

Operational reliability of the measuring device could be compromised.

- Use suitable cable glands corresponding to the degree of protection.

1. Remove dummy plug if present.
2. If the measuring device is supplied without cable glands:  
Provide suitable cable gland for corresponding connecting cable.
3. If the measuring device is supplied with cable glands:  
Observe requirements for connecting cables → 29.

## 7.2 Connecting the measuring device

### NOTICE

#### Limitation of electrical safety due to incorrect connection!

- Have electrical connection work carried out by appropriately trained specialists only.
- Observe applicable federal/national installation codes and regulations.
- Comply with local workplace safety regulations.
- Always connect the protective ground cable  $\ominus$  before connecting additional cables.
- For use in potentially explosive atmospheres, observe the information in the device-specific Ex documentation.

## 7.2.1 Connecting the transmitter

### Connection via terminals

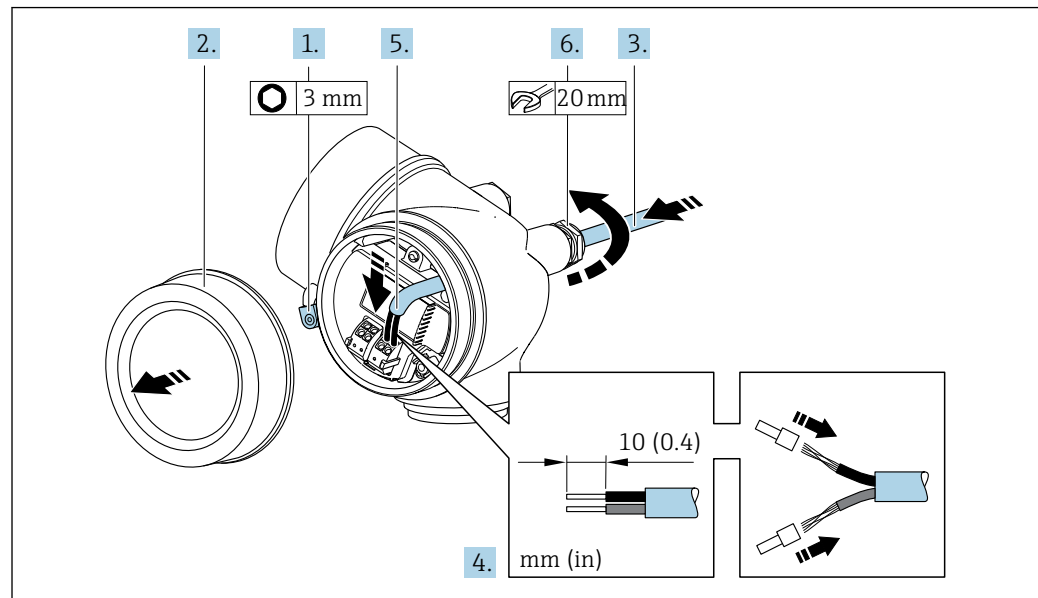

A0032239

1. Loosen the securing clamp of the connection compartment cover.
2. Unscrew the connection compartment cover.
3. Push the cable through the cable entry . To ensure tight sealing, do not remove the sealing ring from the cable entry.
4. Strip the cable and cable ends. In the case of stranded cables, also fit ferrules.
5. Connect cable in accordance with terminal assignment . For HART communication: when connecting the cable shielding to the ground clamp, observe the grounding concept of the facility.

6. **⚠ WARNING**

**Housing degree of protection may be voided due to insufficient sealing of the housing.**

- ▶ Screw in the screw without using any lubricant. The threads on the cover are coated with a dry lubricant.

Firmly tighten the cable glands.

7. Reverse the removal procedure to reassemble the transmitter.



### Removing a cable

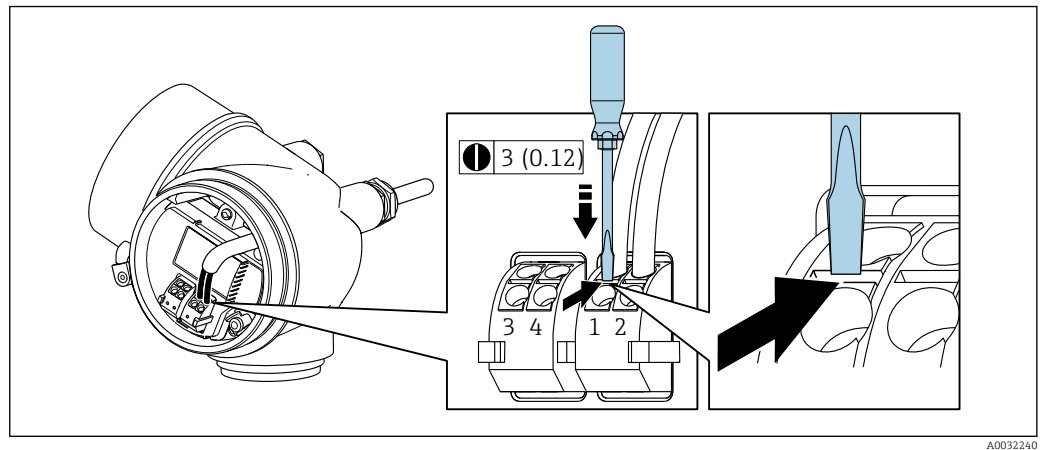

- ▶ To remove a cable from the terminal, use a flat-blade screwdriver to push the slot between the two terminal holes while simultaneously pulling the cable end out of the terminal.

## 7.2.2 Ensuring potential equalization

### Requirements

No special measures for potential equalization are required.



For devices intended for use in hazardous locations, please observe the guidelines in the Ex documentation (XA).

## 7.3 Special connection instructions

### 7.3.1 Connection examples

#### Current output 4-20 mA HART

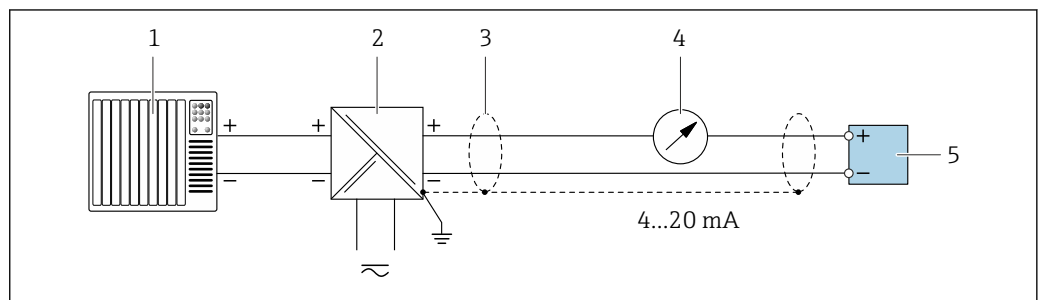

6 Connection example for 4 to 20 mA HART current output (passive)

- 1 Automation system with current input (e.g. PLC)
- 2 Power supply
- 3 Cable shield: the cable shield must be grounded at both ends to comply with EMC requirements; observe cable specifications
- 4 Analog display unit: observe maximum load
- 5 Transmitter

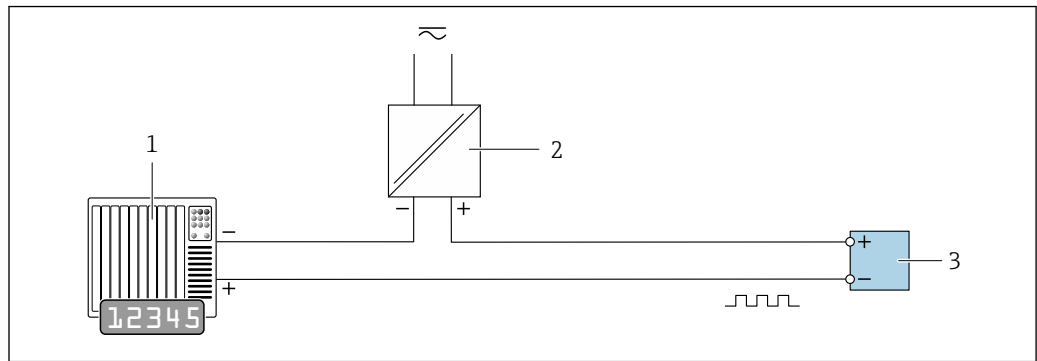
**Pulse/frequency output**

A0028761

7 Connection example for pulse/frequency output (passive)

- 1 Automation system with pulse/frequency input (e.g. PLC)
- 2 Power supply
- 3 Transmitter: Observe input values

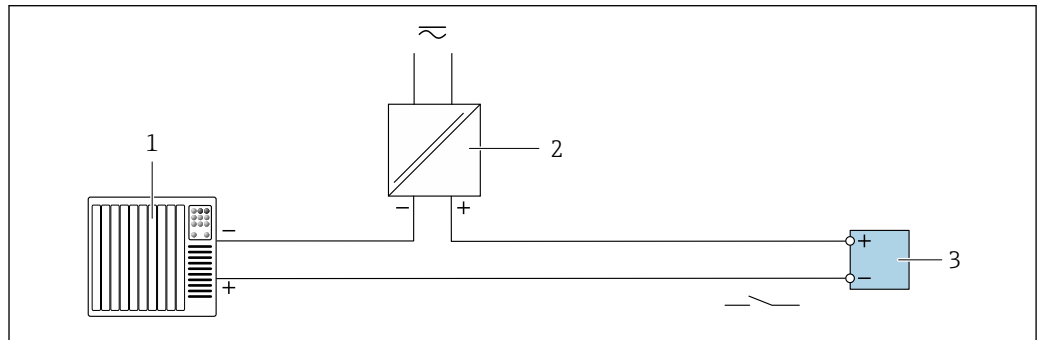
**Switch output**

A0028760

8 Connection example for switch output (passive)

- 1 Automation system with switch input (e.g. PLC)
- 2 Power supply
- 3 Transmitter: Observe input values

**HART input**

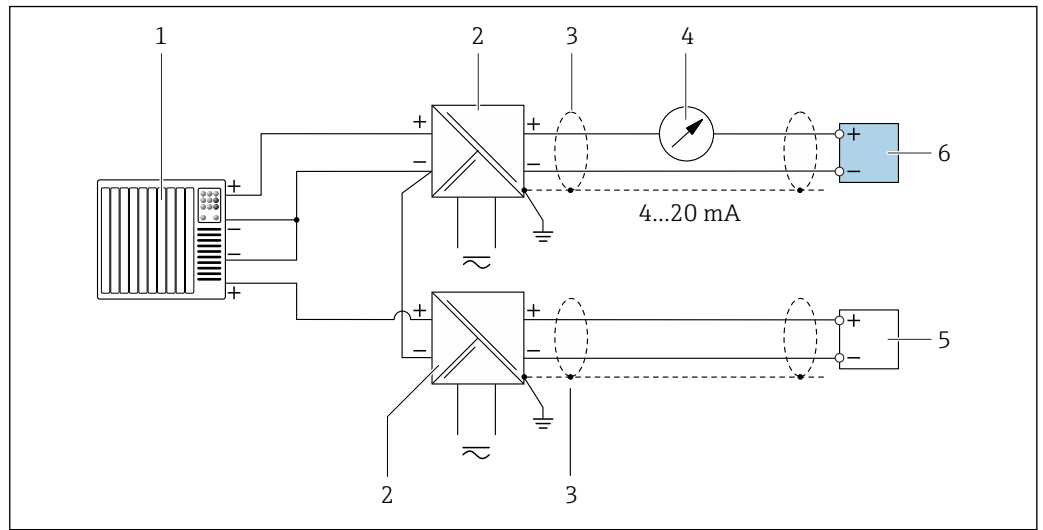

9 Connection example for HART input with a common negative (passive)

- 1 Automation system with HART output (e.g. PLC)
- 2 Active barrier for power supply (e.g. RN221N)
- 3 Cable shield: the cable shield must be grounded at both ends to comply with EMC requirements; observe cable specifications
- 4 Analog display unit: observe maximum load
- 5 Pressure measuring device (e.g. Cerabar M, Cerabar S): see requirements
- 6 Transmitter

**7.4 Ensuring the degree of protection**

The measuring device fulfills all the requirements for the IP66/67 degree of protection, Type 4X enclosure.

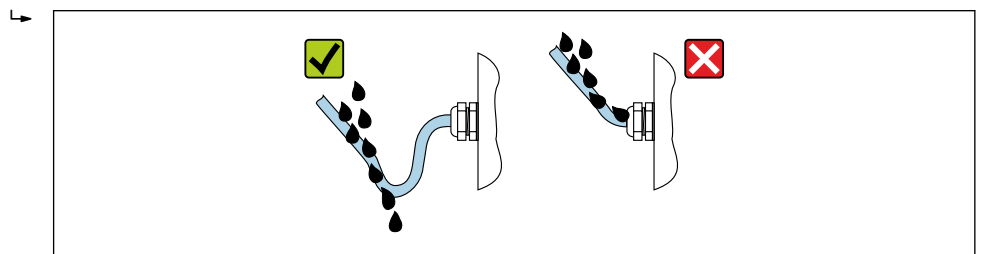

To guarantee IP66/67 degree of protection, Type 4X enclosure, carry out the following steps after the electrical connection:

1. Check that the housing seals are clean and fitted correctly.
2. Dry, clean or replace the seals if necessary.
3. Tighten all housing screws and screw covers.
4. Firmly tighten the cable glands.
5. To ensure that moisture does not enter the cable entry:  
Route the cable so that it loops down before the cable entry ("water trap").



6. Insert dummy plugs into unused cable entries.

## 7.5 Post-connection check

|  |                          |
|--|--------------------------|
| Are cables or the device undamaged (visual inspection)?  | <input type="checkbox"/> |
| Do the cables used meet the requirements →  29?   | <input type="checkbox"/> |
| Do the cables have adequate strain relief?   | <input type="checkbox"/> |
| Are all the cable glands installed, firmly tightened and leak-tight? Cable run with "water trap" →  35? | <input type="checkbox"/> |
| Depending on the device version: are all the device plugs firmly tightened →  32?                     | <input type="checkbox"/> |
| Does the supply voltage match the specifications on the transmitter nameplate ?  | <input type="checkbox"/> |
| Is the terminal assignment correct ?   | <input type="checkbox"/> |
| If supply voltage is present, do values appear on the display module?  | <input type="checkbox"/> |
| Are all housing covers installed and firmly tightened?   | <input type="checkbox"/> |
| Is the securing clamp tightened correctly?   | <input type="checkbox"/> |

## 8 Operation options

### 8.1 Overview of operation options

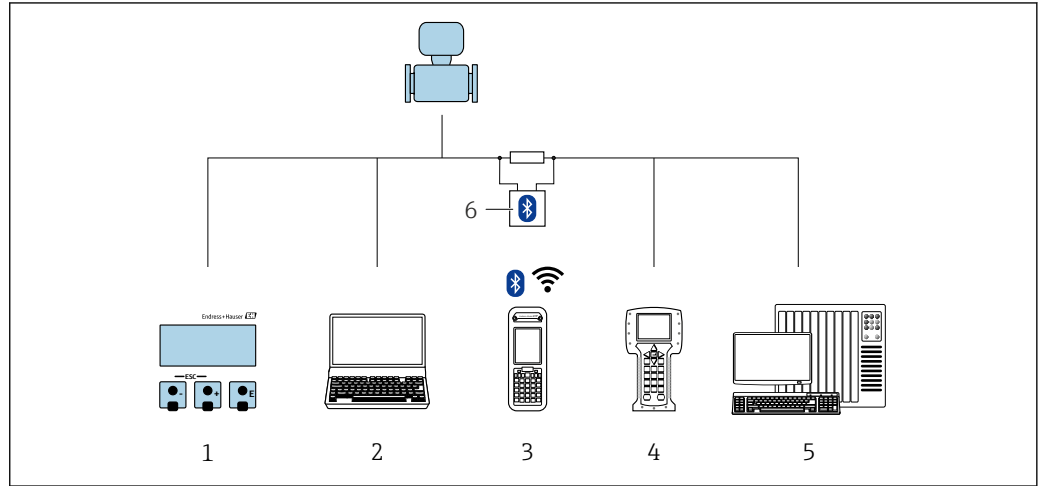

A0032226

- 1 Local operation via display module
- 2 Computer with operating tool (e.g. FieldCare, DeviceCare, AMS Device Manager, SIMATIC PDM)
- 3 Field Xpert SFX350 or SFX370
- 4 Field Communicator 475
- 5 Control system (e.g. PLC)
- 6 VIATOR Bluetooth modem with connecting cable

## 8.2 Structure and function of the operating menu

### 8.2.1 Structure of the operating menu

 For an overview of the operating menu for experts: "Description of Device Parameters" document supplied with the device

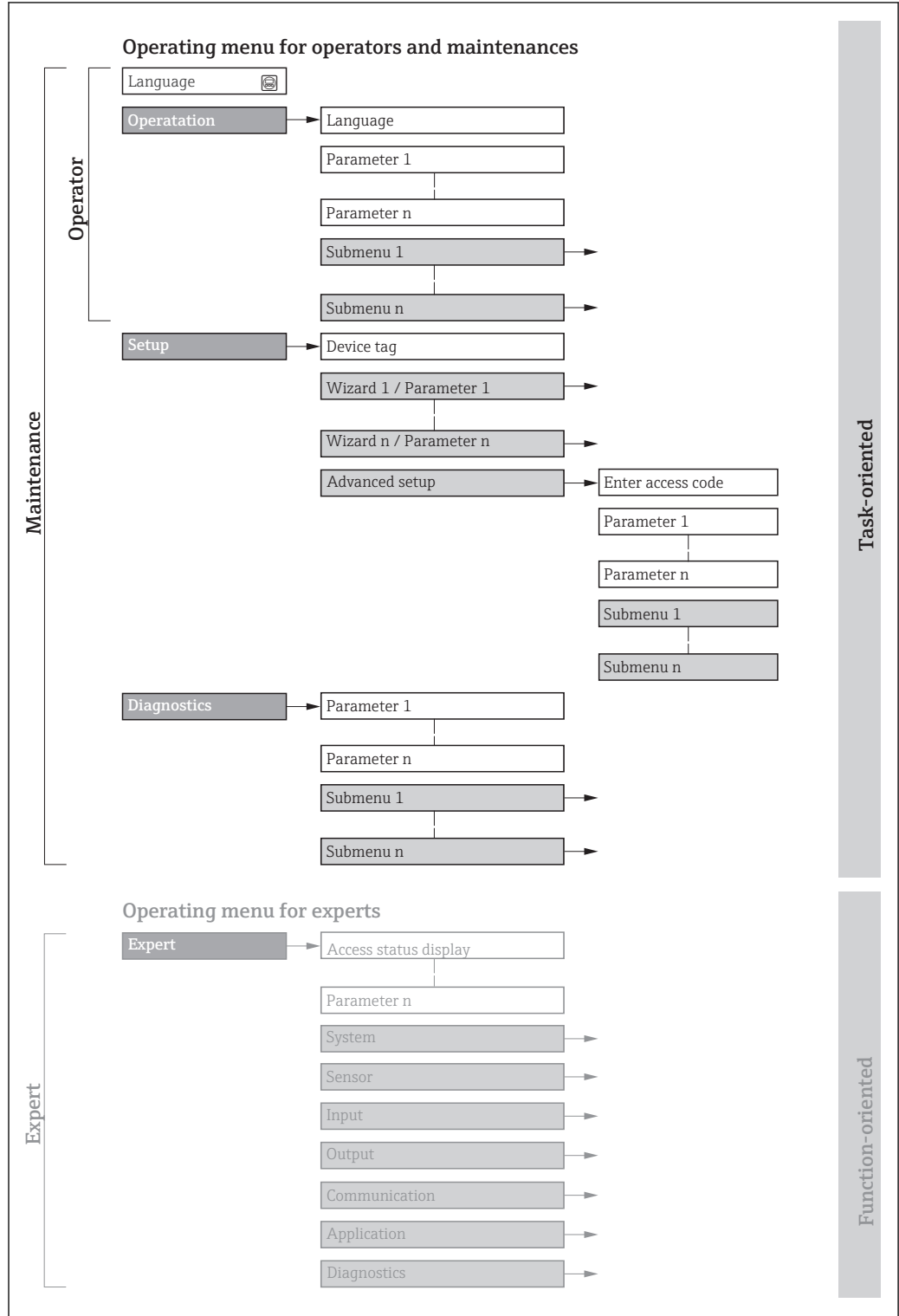

A0018237-EN

 10 Schematic structure of the operating menu

### 8.2.2 Operating philosophy

The individual parts of the operating menu are assigned to certain user roles (operator, maintenance etc.). Each user role contains typical tasks within the device lifecycle.

| Menu/parameter |   | User role and tasks  | Content/meaning   |
|----------------|---|--|---|
| Language       | task-oriented   | <b>Role "Operator", "Maintenance"</b><br>Tasks during operation: <ul style="list-style-type: none"> <li>▪ Configuring the operational display</li> <li>▪ Reading measured values</li> </ul>  | <ul style="list-style-type: none"> <li>▪ Defining the operating language</li> <li>▪ Resetting and controlling totalizers</li> </ul>   |
| Operation      |   |  | <ul style="list-style-type: none"> <li>▪ Configuring the operational display (e.g. display format, display contrast)</li> <li>▪ Resetting and controlling totalizers</li> </ul>   |
| Setup          |   | <b>"Maintenance" role</b><br>Commissioning: <ul style="list-style-type: none"> <li>▪ Configuration of the measurement</li> <li>▪ Configuration of the inputs and outputs</li> </ul>  | Wizards for fast commissioning: <ul style="list-style-type: none"> <li>▪ Set the system units</li> <li>▪ Define the medium</li> <li>▪ Configure the outputs</li> <li>▪ Configuring the operational display</li> <li>▪ Define the output conditioning</li> <li>▪ Set the low flow cut off</li> <li>▪ Configure partial and empty pipe detection</li> </ul> Advanced setup <ul style="list-style-type: none"> <li>▪ For more customized configuration of the measurement (adaptation to special measuring conditions)</li> <li>▪ Configuration of totalizers</li> <li>▪ Configure the WLAN settings</li> <li>▪ Administration (define access code, reset measuring device)</li> </ul>   |
| Diagnostics    | <b>"Maintenance" role</b><br>Fault elimination: <ul style="list-style-type: none"> <li>▪ Diagnostics and elimination of process and device errors</li> <li>▪ Measured value simulation</li> </ul> | Contains all parameters for error detection and analyzing process and device errors: <ul style="list-style-type: none"> <li>▪ Diagnostic list<br/>Contains up to 5 currently pending diagnostic messages.</li> <li>▪ Event logbook<br/>Contains event messages that have occurred.</li> <li>▪ Device information<br/>Contains information for identifying the device.</li> <li>▪ Measured values<br/>Contains all current measured values.</li> <li>▪ <b>Data logging</b> submenu with "Extended HistoROM" order option<br/>Storage and visualization of measured values</li> <li>▪ Heartbeat<br/>The functionality of the device is checked on demand and the verification results are documented.</li> <li>▪ Simulation<br/>Is used to simulate measured values or output values.</li> </ul> |   |
| Expert         | function-oriented   | Tasks that require detailed knowledge of the function of the device: <ul style="list-style-type: none"> <li>▪ Commissioning measurements under difficult conditions</li> <li>▪ Optimal adaptation of the measurement to difficult conditions</li> <li>▪ Detailed configuration of the communication interface</li> <li>▪ Error diagnostics in difficult cases</li> </ul>   | Contains all the parameters of the device and makes it possible to access these parameters directly using an access code. The structure of this menu is based on the function blocks of the device: <ul style="list-style-type: none"> <li>▪ System<br/>Contains all higher-order device parameters which do not concern the measurement or the communication interface.</li> <li>▪ Sensor<br/>Configuration of the measurement.</li> <li>▪ Input<br/>Configuration of the input.</li> <li>▪ Output<br/>Configuration of the outputs.</li> <li>▪ Communication<br/>Configuration of the digital communication interface.</li> <li>▪ Application<br/>Configure the functions that go beyond the actual measurement (e.g. totalizer).</li> <li>▪ Diagnostics<br/>Error detection and analysis of process and device errors and for device simulation and Heartbeat Technology.</li> </ul> |

## 8.3 Access to the operating menu via the local display

### 8.3.1 Operational display

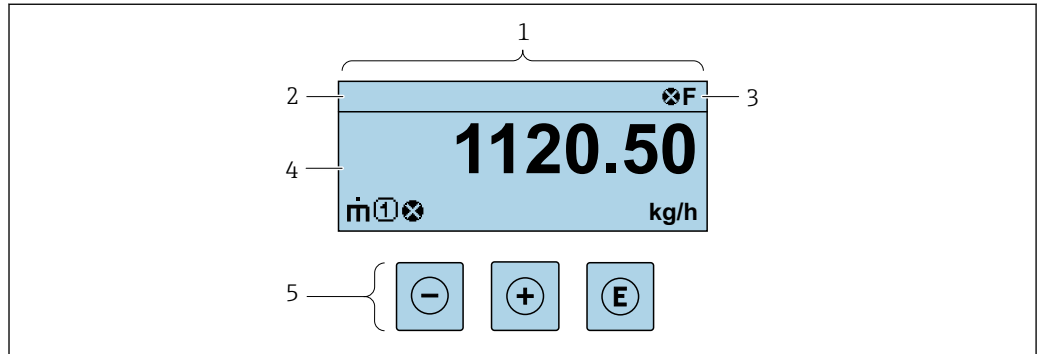

A0029348

- 1 Operational display
- 2 Device tag
- 3 Status area
- 4 Display area for measured values (4-line)
- 5 Operating elements → 45

#### Status area

The following symbols appear in the status area of the operational display at the top right:

- Status signals → 103
  - **F**: Failure
  - **C**: Function check
  - **S**: Out of specification
  - **M**: Maintenance required
- Diagnostic behavior → 104
  - : Alarm
  - : Warning
  - : Locking (the device is locked via the hardware )
  - : Communication (communication via remote operation is active)

#### Display area

In the display area, each measured value is prefaced by certain symbol types for further description:

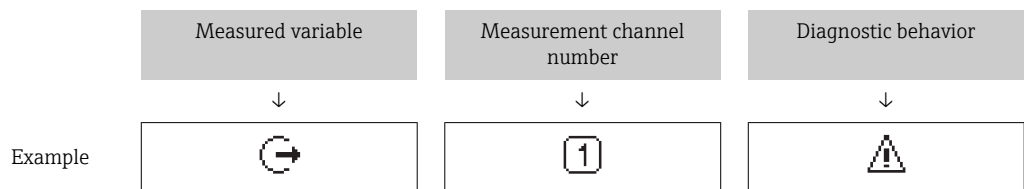

Appears only if a diagnostics event is present for this measured variable.

#### Measured values

| Symbol | Meaning  |
|--------|--|
|        | Mass flow  |
|        | <ul style="list-style-type: none"> <li>▪ Volume flow</li> <li>▪ Corrected volume flow</li> </ul> |



|  |   |
|--|---|
|  | <ul style="list-style-type: none"> <li>Density</li> <li>Reference density</li> </ul>              |
|  | Temperature   |
|  | Totalizer<br>The measurement channel number indicates which of the three totalizers is displayed. |
|  | Output<br>The measurement channel number indicates which of the two current outputs is displayed. |

Measurement channel numbers

| Symbol  | Meaning                    |
|---|----------------------------|
|   | Measurement channel 1 to 4 |
| The measurement channel number is displayed only if more than one channel is present for the same measured variable type (e.g. Totalizer 1 to 3). |                            |

Diagnostic behavior

The diagnostic behavior pertains to a diagnostic event that is relevant to the displayed measured variable. For information on the symbols → 104

The number and display format of the measured values can be configured via the **Format display** parameter (→ 75).

### 8.3.2 Navigation view



| In the submenu  | In the wizard   |
|---|---|
| <p>1: Navigation view<br/>2: Navigation path to current position<br/>3: Status area<br/>4: Display area for navigation<br/>5: Operating elements →  45</p> <p>A0013993-EN</p> | <p>1: Navigation view<br/>2: Navigation path to current position<br/>3: Status area<br/>4: Display area for navigation<br/>5: Operating elements →  45</p> <p>A0013995-EN</p> |
| <p>1 Navigation view<br/>2 Navigation path to current position<br/>3 Status area<br/>4 Display area for navigation<br/>5 Operating elements →  45</p>                         |   |

#### Navigation path

The navigation path - displayed at the top left in the navigation view - consists of the following elements:

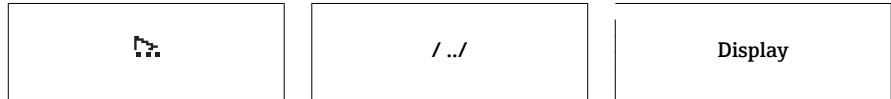
|          |   |  |   |
|----------|---|--|---|
|          | <ul style="list-style-type: none"> <li>In the submenu:<br/>Display symbol for menu</li> <li>In the wizard:<br/>Display symbol for wizard</li> </ul> | Omission symbol for operating menu levels in between | Name of current <ul style="list-style-type: none"> <li>Submenu</li> <li>Wizard</li> <li>Parameters</li> </ul> |
|          | ↓   | ↓  | ↓   |
| Examples |   | / .. /   | Display   |





 For more information about the icons in the menu, refer to the "Display area" section →  42

**Status area**





The following appears in the status area of the navigation view in the top right corner:

- In the submenu
  - The direct access code for the parameter you are navigating to (e.g. 0022-1)
  - If a diagnostic event is present, the diagnostic behavior and status signal
- In the wizard
  - If a diagnostic event is present, the diagnostic behavior and status signal





- 
  - For information on the diagnostic behavior and status signal →  103
  - For information on the function and entry of the direct access code →  47

**Display area**

*Menus*

| Symbol  | Meaning   |
|---|---|
|  | <b>Operation</b><br>Appears: <ul style="list-style-type: none"> <li>▪ In the menu next to the "Operation" selection</li> <li>▪ At the left in the navigation path in the <b>Operation</b> menu</li> </ul>       |
|  | <b>Setup</b><br>Appears: <ul style="list-style-type: none"> <li>▪ In the menu next to the "Setup" selection</li> <li>▪ At the left in the navigation path in the <b>Setup</b> menu</li> </ul>                   |
|  | <b>Diagnostics</b><br>Appears: <ul style="list-style-type: none"> <li>▪ In the menu next to the "Diagnostics" selection</li> <li>▪ At the left in the navigation path in the <b>Diagnostics</b> menu</li> </ul> |
|  | <b>Expert</b><br>Appears: <ul style="list-style-type: none"> <li>▪ In the menu next to the "Expert" selection</li> <li>▪ At the left in the navigation path in the <b>Expert</b> menu</li> </ul>                |



*Submenus, wizards, parameters*

| Symbol  | Meaning  |
|---|--|
|  | Submenu  |
|  | Wizard   |
|  | Parameters within a wizard<br> No display symbol exists for parameters in submenus. |

*Locking*

| Symbol  | Meaning   |
|---|---|
|  | <b>Parameter locked</b><br>When displayed in front of a parameter name, indicates that the parameter is locked. <ul style="list-style-type: none"> <li>▪ By a user-specific access code</li> <li>▪ By the hardware write protection switch</li> </ul> |

Wizard operation

| Symbol  | Meaning  |
|---|--|
|  | Switches to the previous parameter.                              |
|  | Confirms the parameter value and switches to the next parameter. |
|  | Opens the editing view of the parameter.                         |



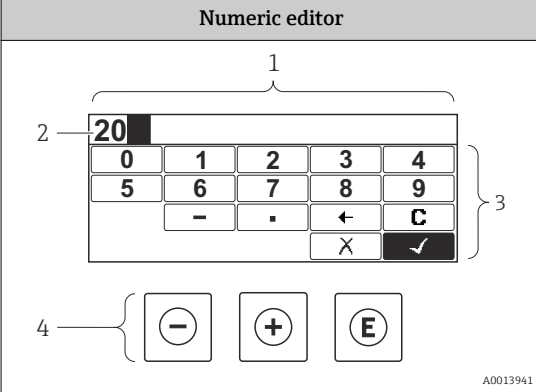
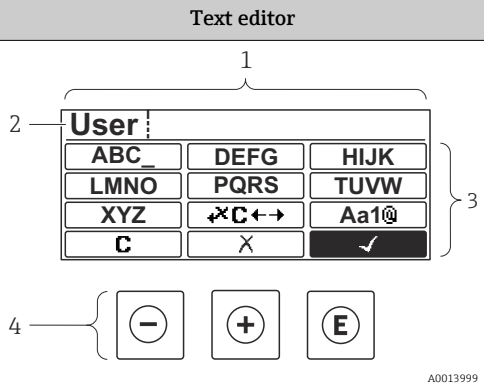



8.3.3 Editing view

| Numeric editor   | Text editor   |
|--|---|
|    |  |
| <p>1 Editing view<br/>                 2 Display area of the entered values<br/>                 3 Input mask<br/>                 4 Operating elements → 45</p> |   |

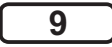
Input mask

The following input symbols are available in the input mask of the numeric and text editor:

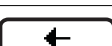
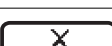
Numeric editor

| Symbol  | Meaning  |
|---|--|
|  | Selection of numbers from 0 to 9.                  |
|  |  |
|  | Inserts decimal separator at the input position.   |
|  | Inserts minus sign at the input position.          |
|  | Confirms selection.                                |
|  | Moves the input position one position to the left. |
|  | Exits the input without applying the changes.      |
|  | Clears all entered characters.                     |







*Text editor*

| Symbol      | Meaning   |
|-------------|---|
|             | Toggle <ul style="list-style-type: none"> <li>▪ Between upper-case and lower-case letters</li> <li>▪ For entering numbers</li> <li>▪ For entering special characters</li> </ul> |
| <br>...<br> | Selection of letters from A to Z.   |
| <br>...<br> | Selection of letters from a to z.   |
| <br>...<br> | Selection of special characters.  |
|             | Confirms selection.   |
|             | Switches to the selection of the correction tools.  |
|             | Exits the input without applying the changes.   |
|             | Clears all entered characters.  |

*Correction symbols under*

| Symbol | Meaning  |
|--------|--|
|        | Clears all entered characters.                                       |
|        | Moves the input position one position to the right.                  |
|        | Moves the input position one position to the left.                   |
|        | Deletes one character immediately to the left of the input position. |

### 8.3.4 Operating elements

| Operating key(s)  | Meaning  |
|---|--|
|    | <p><b>Minus key</b></p> <p><i>In a menu, submenu</i><br/>Moves the selection bar upwards in a choose list.</p> <p><i>With a Wizard</i><br/>Confirms the parameter value and goes to the previous parameter.</p> <p><i>With a text and numeric editor</i><br/>In the input screen, moves the selection bar to the left (backwards).</p>   |
|    | <p><b>Plus key</b></p> <p><i>In a menu, submenu</i><br/>Moves the selection bar downwards in a choose list.</p> <p><i>With a Wizard</i><br/>Confirms the parameter value and goes to the next parameter.</p> <p><i>With a text and numeric editor</i><br/>Moves the selection bar to the right (forwards) in an input screen.</p>  |
|  | <p><b>Enter key</b></p> <p><i>For operational display</i></p> <ul style="list-style-type: none"> <li>▪ Pressing the key briefly opens the operating menu.</li> <li>▪ Pressing the key for 2 s opens the context menu.</li> </ul> <p><i>In a menu, submenu</i></p> <ul style="list-style-type: none"> <li>▪ Pressing the key briefly: <ul style="list-style-type: none"> <li>▪ Opens the selected menu, submenu or parameter.</li> <li>▪ Starts the wizard.</li> <li>▪ If help text is open, closes the help text of the parameter.</li> </ul> </li> <li>▪ Pressing the key for 2 s for parameter: <ul style="list-style-type: none"> <li>▪ If present, opens the help text for the function of the parameter.</li> </ul> </li> </ul> <p><i>With a Wizard</i><br/>Opens the editing view of the parameter.</p> <p><i>With a text and numeric editor</i></p> <ul style="list-style-type: none"> <li>▪ Pressing the key briefly: <ul style="list-style-type: none"> <li>▪ Opens the selected group.</li> <li>▪ Carries out the selected action.</li> </ul> </li> <li>▪ Pressing the key for 2 s confirms the edited parameter value.</li> </ul> |
|  | <p><b>Escape key combination (press keys simultaneously)</b></p> <p><i>In a menu, submenu</i></p> <ul style="list-style-type: none"> <li>▪ Pressing the key briefly: <ul style="list-style-type: none"> <li>▪ Exits the current menu level and takes you to the next higher level.</li> <li>▪ If help text is open, closes the help text of the parameter.</li> </ul> </li> <li>▪ Pressing the key for 2 s returns you to the operational display ("home position").</li> </ul> <p><i>With a Wizard</i><br/>Exits the wizard and takes you to the next higher level.</p> <p><i>With a text and numeric editor</i><br/>Closes the text or numeric editor without applying changes.</p>  |
|  | <p><b>Minus/Enter key combination (press the keys simultaneously)</b></p> <p>Reduces the contrast (brighter setting).</p>  |
|  | <p><b>Plus/Enter key combination (press and hold down the keys simultaneously)</b></p> <p>Increases the contrast (darker setting).</p>   |
|  | <p><b>Minus/Plus/Enter key combination (press the keys simultaneously)</b></p> <p><i>For operational display</i><br/>Enables or disables the keypad lock (only SD02 display module).</p>   |

### 8.3.5 Opening the context menu

Using the context menu, the user can call up the following menus quickly and directly from the operational display:

- Setup
- Configuration backup display
- Simulation

### Calling up and closing the context menu

The user is in the operational display.

1. Press  $\square$  for 2 s.
  - ↳ The context menu opens.

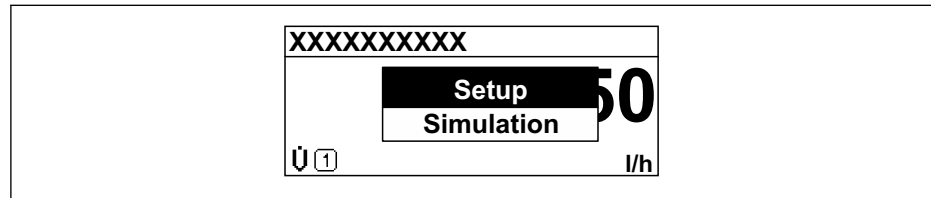

A0017421-EN

2. Press  $\square$  +  $\oplus$  simultaneously.
  - ↳ The context menu is closed and the operational display appears.

### Calling up the menu via the context menu

1. Open the context menu.
2. Press  $\oplus$  to navigate to the desired menu.
3. Press  $\square$  to confirm the selection.
  - ↳ The selected menu opens.

### 8.3.6 Navigating and selecting from list

Different operating elements are used to navigate through the operating menu. The navigation path is displayed on the left in the header. Icons are displayed in front of the individual menus. These icons are also shown in the header during navigation.

**i** For an explanation of the navigation view with symbols and operating elements → 41

**Example: Setting the number of displayed measured values to "2 values"**

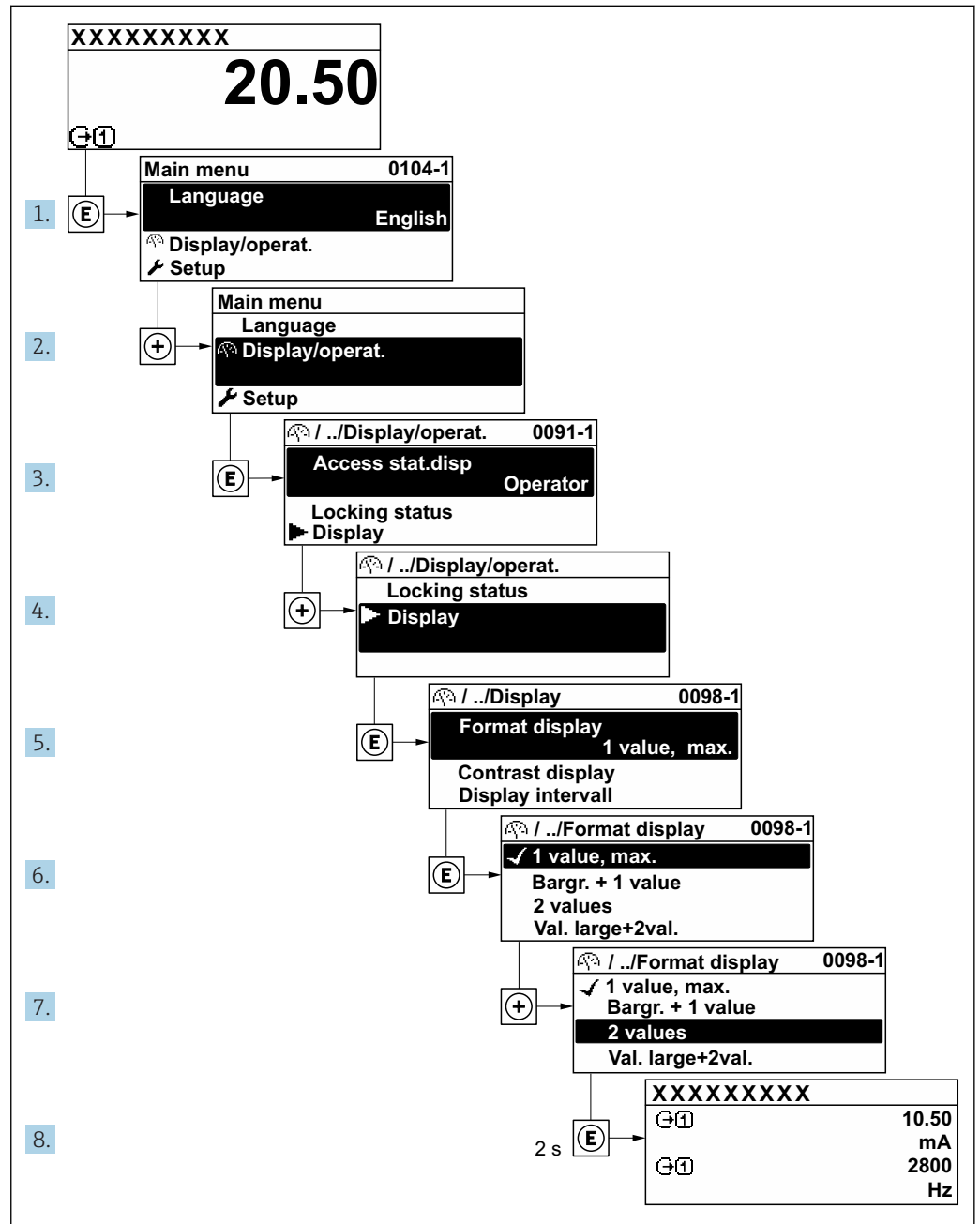

A0029562-EN

### 8.3.7 Calling the parameter directly

A parameter number is assigned to every parameter to be able to access a parameter directly via the onsite display. Entering this access code in the **Direct access** parameter calls up the desired parameter directly.

#### Navigation path

Expert → Direct access

The direct access code consists of a 5-digit number (at maximum) and the channel number, which identifies the channel of a process variable: e.g. 00914-2. In the navigation view, this appears on the right-hand side in the header of the selected parameter.

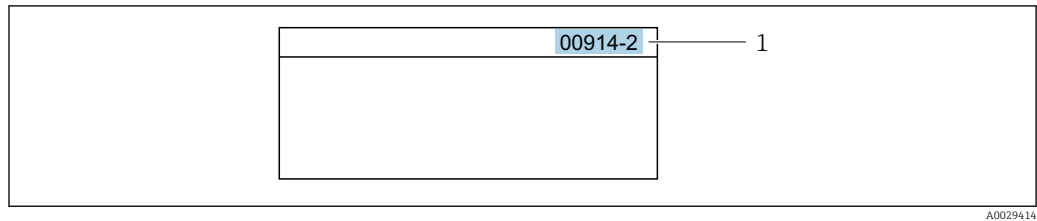

1 Direct access code

Note the following when entering the direct access code:

- The leading zeros in the direct access code do not have to be entered.  
Example: Enter "914" instead of "00914"
- If no channel number is entered, channel 1 is accessed automatically.  
Example: Enter 00914 → **Assign process variable** parameter
- If a different channel is accessed: Enter the direct access code with the corresponding channel number.  
Example: Enter 00914-2 → **Assign process variable** parameter



For the direct access codes of the individual parameters, see the "Description of Device Parameters" document for the device

### 8.3.8 Calling up help text

Help text is available for some parameters and can be called up from the navigation view. The help text provides a brief explanation of the parameter function and thereby supports swift and safe commissioning.

#### Calling up and closing the help text

The user is in the navigation view and the selection bar is on a parameter.

1. Press for 2 s.  
↳ The help text for the selected parameter opens.

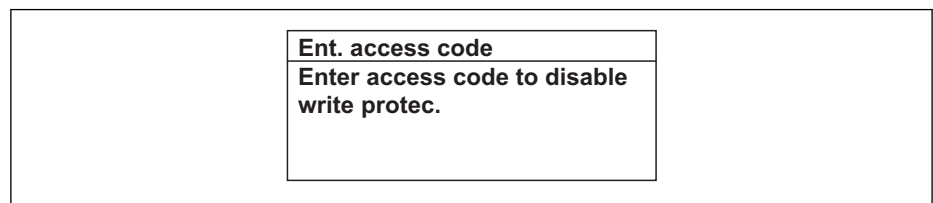

11 Example: Help text for parameter "Enter access code"

2. Press + simultaneously.  
↳ The help text is closed.



### 8.3.9 Changing the parameters

**i** For a description of the editing view - consisting of the text editor and numeric editor - with symbols → 43, for a description of the operating elements → 45

**Example:** Changing the tag name in the "Tag description" parameter from 001-FT-101 to 001-FT-102

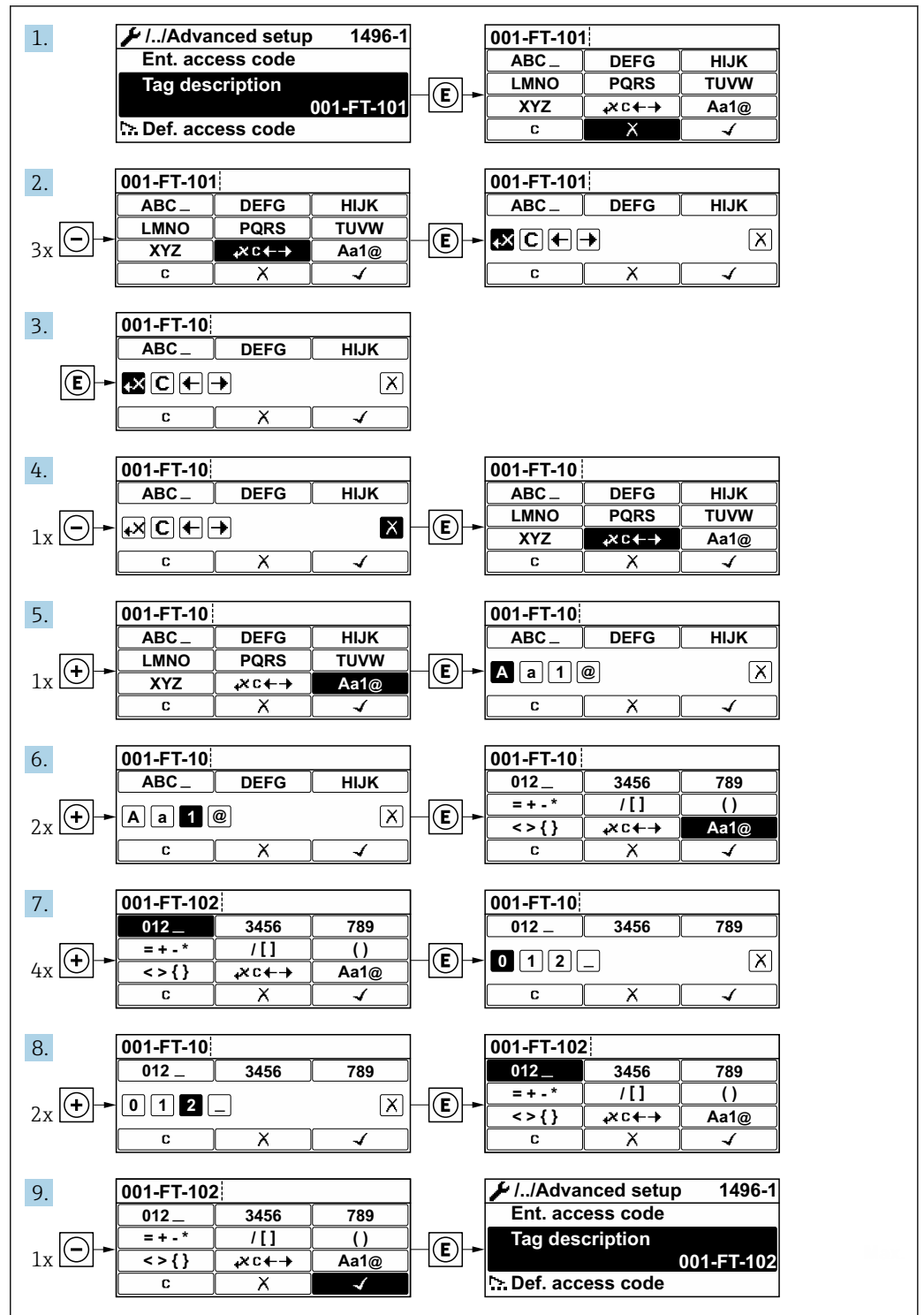

A message is displayed if the value entered is outside the permitted value range.

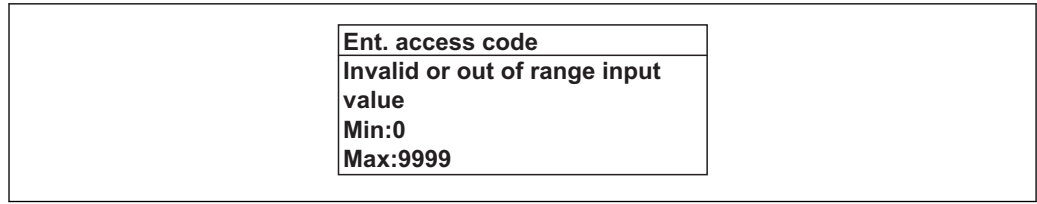

A0014049-EN

### 8.3.10 User roles and related access authorization

The two user roles "Operator" and "Maintenance" have different write access to the parameters if the customer defines a user-specific access code. This protects the device configuration via the local display from unauthorized access .

#### Defining access authorization for user roles

An access code is not yet defined when the device is delivered from the factory. Access authorization (read and write access) to the device is not restricted and corresponds to the "Maintenance" user role.

- ▶ Define the access code.
  - ↳ The "Operator" user role is redefined in addition to the "Maintenance" user role. Access authorization differs for the two user roles.

#### Access authorization to parameters: "Maintenance" user role

| Access code status   | Read access | Write access    |
|--|-------------|-----------------|
| An access code has not yet been defined (factory setting). | ✓           | ✓               |
| After an access code has been defined.                     | ✓           | ✓ <sup>1)</sup> |

1) The user only has write access after entering the access code.



#### Access authorization to parameters: "Operator" user role

| Access code status                     | Read access | Write access     |
|--|-------------|------------------|
| After an access code has been defined. | ✓           | -- <sup>1)</sup> |



1) Despite the defined access code, certain parameters can always be modified and thus are excepted from the write protection, as they do not affect the measurement. Refer to the "Write protection via access code" section

 The user role with which the user is currently logged on is indicated by the **Access status display** parameter. Navigation path: Operation → Access status display

### 8.3.11 Disabling write protection via access code

If the -symbol appears on the local display in front of a parameter, the parameter is write-protected by a user-specific access code and its value cannot be changed at the moment using local operation →  89.

Parameter write protection via local operation can be disabled by entering the user-specific access code in the **Enter access code** parameter via the respective access option.

1. After you press , the input prompt for the access code appears.
2. Enter the access code.
  - ↳ The -symbol in front of the parameters disappears; all previously write-protected parameters are now re-enabled.

### 8.3.12 Enabling and disabling the keypad lock

The keypad lock makes it possible to block access to the entire operating menu via local operation. As a result, it is no longer possible to navigate through the operating menu or change the values of individual parameters. Users can only read the measured values on the operational display.

The keypad lock is switched on and off via the context menu.

#### Switching on the keypad lock

##### For the SD03 display only

The keypad lock is switched on automatically:

- If the device has not been operated via the display for > 1 minute.
- Each time the device is restarted.

#### To activate the keylock manually:

1. The device is in the measured value display.  
Press  for at least 2 seconds.  
↳ A context menu appears.
2. In the context menu select the **Keylock on** option.  
↳ The keypad lock is switched on.

 If the user attempts to access the operating menu while the keypad lock is active, the **Keylock on** message appears.

#### Switching off the keypad lock

1. The keypad lock is switched on.  
Press  for at least 2 seconds.  
↳ A context menu appears.
2. In the context menu select the **Keylock off** option.  
↳ The keypad lock is switched off.

## 8.4 Access to the operating menu via the operating tool

The structure of the operating menu in the operating tools is the same as for operation via the local display.

### 8.4.1 Connecting the operating tool

#### Via HART protocol

This communication interface is available in device versions with a HART output.

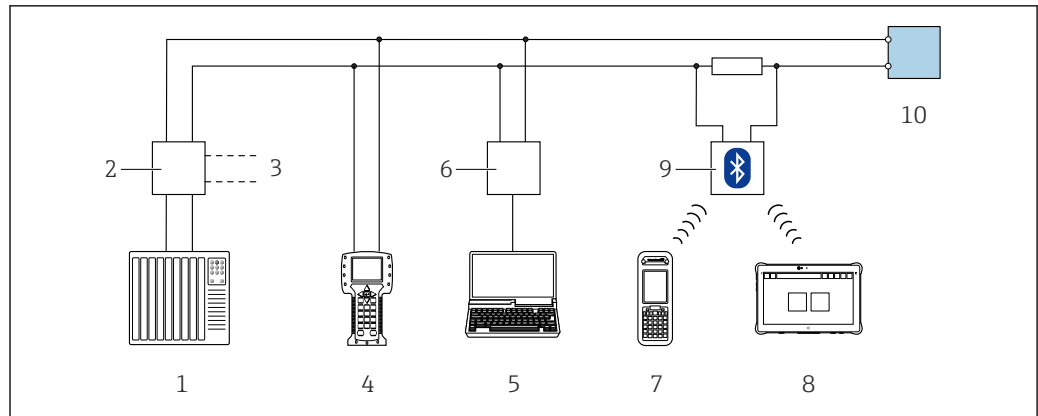

A0028746

12 Options for remote operation via HART protocol (passive)

- 1 Control system (e.g. PLC)
- 2 Transmitter power supply unit, e.g. RN221N (with communication resistor)
- 3 Connection for Commubox FXA195 and Field Communicator 475
- 4 Field Communicator 475
- 5 Computer with web browser (e.g. Internet Explorer) for accessing computers with operating tool (e.g. FieldCare, DeviceCare, AMS Device Manager, SIMATIC PDM) with COM DTM "CDI Communication TCP/IP"
- 6 Commubox FXA195 (USB)
- 7 Field Xpert SFX350 or SFX370
- 8 VIATOR Bluetooth modem with connecting cable
- 9 Transmitter

### Via service interface (CDI)

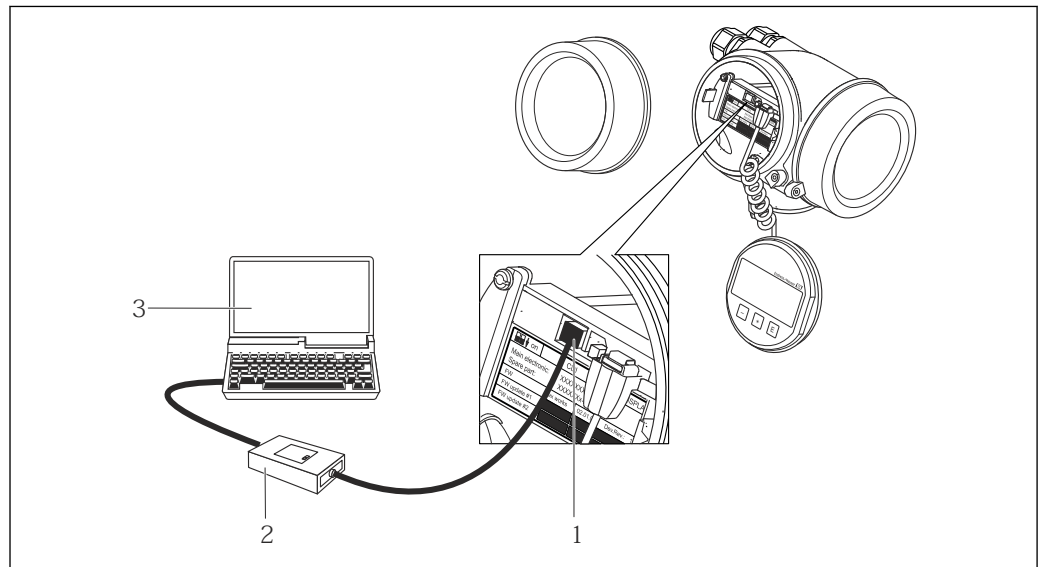

A0014019

- 1 Service interface (CDI = Endress+Hauser Common Data Interface) of the measuring device
- 2 Commubox FXA291
- 3 Computer with FieldCare operating tool with COM DTM CDI Communication FXA291

## 8.4.2 Field Xpert SFX350, SFX370

### Function range

Field Xpert SFX350 and Field Xpert SFX370 are mobile computers for commissioning and maintenance. They enable efficient device configuration and diagnostics for HART and

FOUNDATION Fieldbus devices in the **non-hazardous area** (SFX350, SFX370) and **hazardous area** (SFX370).



For details, see Operating Instructions BA01202S

#### Source for device description files

See information →  56

### 8.4.3 FieldCare

#### Function scope

FDT-based plant asset management tool from Endress+Hauser. It can configure all smart field devices in a system and helps you manage them. By using the status information, it is also a simple but effective way of checking their status and condition.

Access is via:

- HART protocol
- CDI service interface →  52

Typical functions:

- Configuring parameters of transmitters
- Loading and saving device data (upload/download)
- Documentation of the measuring point
- Visualization of the measured value memory (line recorder) and event logbook



For additional information about FieldCare, see Operating Instructions BA00027S and BA00059S

#### Source for device description files

See information →  56

#### Establishing a connection



For additional information, see Operating Instructions BA00027S and BA00059S

User interface

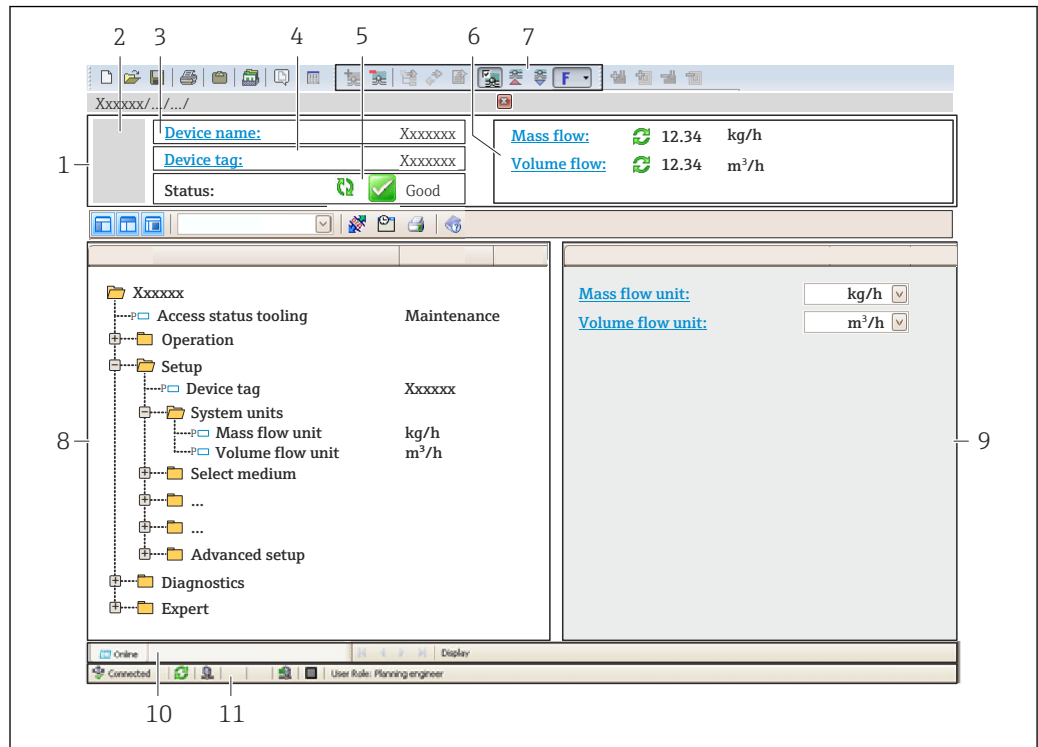

A0021051-EN

- 1 Header
- 2 Picture of device
- 3 Device name
- 4 Tag name
- 5 Status area with status signal → 106
- 6 Display area for current measured values
- 7 Edit toolbar with additional functions such as save/restore, event list and create documentation
- 8 Navigation area with operating menu structure
- 9 Working area
- 10 Range of action
- 11 Status area

### 8.4.4 DeviceCare

**Function scope**

Tool to connect and configure Endress+Hauser field devices.

The fastest way to configure Endress+Hauser field devices is with the dedicated "DeviceCare" tool. Together with the device type managers (DTMs) it presents a convenient, comprehensive solution.

 For details, see Innovation Brochure IN01047S

**Source for device description files**

See information →  56

### 8.4.5 AMS Device Manager

**Function scope**

Program from Emerson Process Management for operating and configuring measuring devices via HART protocol.

**Source for device description files**

See data →  56

**8.4.6 SIMATIC PDM****Function scope**

SIMATIC PDM is a standardized, manufacturer-independent program from Siemens for the operation, configuration, maintenance and diagnosis of intelligent field devices via HART protocol.

**Source for device description files**

See data →  56

**8.4.7 Field Communicator 475****Function scope**

Industrial handheld terminal from Emerson Process Management for remote configuration and measured value display via HART protocol.

**Source for device description files**

See data →  56

## 9 System integration

### 9.1 Overview of device description files

#### 9.1.1 Current version data for the device

|                                  |          |   |
|----------------------------------|----------|---|
| Firmware version                 | 01.04.zz | <ul style="list-style-type: none"> <li>▪ On the title page of the Operating instructions</li> <li>▪ On the transmitter nameplate</li> <li>▪ Firmware version<br/>Diagnostics → Device information → Firmware version</li> </ul> |
| Release date of firmware version | 06.2015  | ---   |
| Manufacturer ID                  | 0x11     | Manufacturer ID<br>Diagnostics → Device information → Manufacturer ID   |
| Device type ID                   | 0x54     | Device type<br>Diagnostics → Device information → Device type   |
| HART protocol revision           | 7        | ---   |
| Device revision                  | 5        | <ul style="list-style-type: none"> <li>▪ On the transmitter nameplate</li> <li>▪ Device revision<br/>Diagnostics → Device information → Device revision</li> </ul>  |

 For an overview of the different firmware versions for the device →  117

#### 9.1.2 Operating tools

The suitable device description file for the individual operating tools is listed in the table below, along with information on where the file can be acquired.

| Operating tool via HART protocol   | Sources for obtaining device descriptions   |
|--|---|
| FieldCare  | <ul style="list-style-type: none"> <li>▪ <a href="http://www.endress.com">www.endress.com</a> → Download Area</li> <li>▪ CD-ROM (contact Endress+Hauser)</li> <li>▪ DVD (contact Endress+Hauser)</li> </ul> |
| DeviceCare   | <ul style="list-style-type: none"> <li>▪ <a href="http://www.endress.com">www.endress.com</a> → Download Area</li> <li>▪ CD-ROM (contact Endress+Hauser)</li> <li>▪ DVD (contact Endress+Hauser)</li> </ul> |
| <ul style="list-style-type: none"> <li>▪ Field Xpert SFX350</li> <li>▪ Field Xpert SFX370</li> </ul> | Use update function of handheld terminal  |
| AMS Device Manager<br>(Emerson Process Management)   | <a href="http://www.endress.com">www.endress.com</a> → Download Area  |
| SIMATIC PDM<br>(Siemens)   | <a href="http://www.endress.com">www.endress.com</a> → Download Area  |
| Field Communicator 475<br>(Emerson Process Management)   | Use update function of handheld terminal  |

## 9.2 Measured variables via HART protocol

The following measured variables (HART device variables) are assigned to the dynamic variables at the factory:

| Dynamic variables               | Measured variables (HART device variables) |
|---------------------------------|--|
| Primary dynamic variable (PV)   | Mass flow                                  |
| Secondary dynamic variable (SV) | Totalizer 1                                |



| Dynamic variables                | Measured variables (HART device variables) |
|----------------------------------|--|
| Tertiary dynamic variable (TV)   | Density                                    |
| Quaternary dynamic variable (QV) | Temperature                                |

The assignment of the measured variables to the dynamic variables can be modified and assigned as desired via local operation and the operating tool using the following parameters:

- Expert → Communication → HART output → Output → Assign PV
- Expert → Communication → HART output → Output → Assign SV
- Expert → Communication → HART output → Output → Assign TV
- Expert → Communication → HART output → Output → Assign QV

The following measured variables can be assigned to the dynamic variables:

#### Measured variables for PV (primary dynamic variable)

- Off
- Mass flow
- Volume flow
- Corrected volume flow
- Density
- Reference density
- Temperature
- Electronic temperature
- Oscillation frequency
- Oscillation amplitude
- Oscillation damping
- Signal asymmetry

#### Measured variables for SV, TV, QV (secondary, tertiary and quaternary dynamic variable)

- Mass flow
- Volume flow
- Corrected volume flow
- Density
- Reference density
- Temperature
- Electronic temperature
- Oscillation frequency
- Oscillation amplitude
- Oscillation damping
- Signal asymmetry
- External pressure
- Totalizer 1...3

### 9.2.1 Device variables

Device variables are permanently assigned. A maximum of eight device variables can be transmitted.

| Assignment | Device variables      |
|------------|-----------------------|
| 0          | Mass flow             |
| 1          | Volume flow           |
| 2          | Corrected volume flow |
| 3          | Density               |
| 4          | Reference density     |
| 5          | Temperature           |

| Assignment | Device variables                       |
|------------|--|
| 6          | Totalizer 1                            |
| 7          | Totalizer 2                            |
| 8          | Totalizer 3                            |
| 9          | Carrier pipe temperature <sup>1)</sup> |
| 10         | Electronic temperature                 |
| 11         | Oscillation damping 0                  |
| 12         | Oscillation frequency 0                |
| 13         | Oscillation amplitude <sup>1)</sup>    |
| 14         | Signal asymmetry                       |
| 15         | Pressure <sup>1)</sup>                 |

1) Visible depending on the order options or device settings

### 9.3 Other settings

Burst mode functionality in accordance with HART 7 Specification:

#### Navigation

"Expert" menu → Communication → HART output → Burst configuration → Burst configuration 1 to n

|                              |      |
|------------------------------|------|
| ► Burst configuration        |      |
| ► Burst configuration 1 to n |      |
| Burst mode 1 to n            | → 59 |
| Burst command 1 to n         | → 59 |
| Burst variable 0             | → 59 |
| Burst variable 1             | → 59 |
| Burst variable 2             | → 59 |
| Burst variable 3             | → 59 |
| Burst variable 4             | → 59 |
| Burst variable 5             | → 59 |
| Burst variable 6             | → 59 |
| Burst variable 7             | → 59 |
| Burst trigger mode           | → 59 |

|                     |      |
|---------------------|------|
| Burst trigger level | → 60 |
| Min. update period  | → 60 |
| Max. update period  | → 60 |

**Parameter overview with brief description**

| Parameter            | Description   | Selection / User entry  | Factory setting |
|----------------------|---|---|-----------------|
| Burst mode 1 to n    | Activate the HART burst mode for burst message X.                                   | <ul style="list-style-type: none"> <li>■ Off</li> <li>■ On</li> </ul>   | Off             |
| Burst command 1 to n | Select the HART command that is sent to the HART master.                            | <ul style="list-style-type: none"> <li>■ Command 1</li> <li>■ Command 2</li> <li>■ Command 3</li> <li>■ Command 9</li> <li>■ Command 33</li> <li>■ Command 48</li> </ul>  | Command 2       |
| Burst variable 0     | For HART command 9 and 33: select the HART device variable or the process variable. | <ul style="list-style-type: none"> <li>■ Mass flow</li> <li>■ Volume flow</li> <li>■ Corrected volume flow</li> <li>■ Density</li> <li>■ Reference density</li> <li>■ Temperature</li> <li>■ Electronic temperature</li> <li>■ Oscillation damping</li> <li>■ Oscillation frequency</li> <li>■ Oscillation amplitude 0</li> <li>■ Signal asymmetry</li> <li>■ Totalizer 1</li> <li>■ Totalizer 2</li> <li>■ Totalizer 3</li> <li>■ External pressure</li> <li>■ Percent Of Range</li> <li>■ Measured current</li> <li>■ Primary variable (PV)</li> <li>■ Secondary variable (SV)</li> <li>■ Tertiary variable (TV)</li> <li>■ Quaternary variable (QV)</li> <li>■ Not used</li> </ul> | Mass flow       |
| Burst variable 1     | For HART command 9 and 33: select the HART device variable or the process variable. | See the <b>Burst variable 0</b> parameter.  | Not used        |
| Burst variable 2     | For HART command 9 and 33: select the HART device variable or the process variable. | See the <b>Burst variable 0</b> parameter.  | Not used        |
| Burst variable 3     | For HART command 9 and 33: select the HART device variable or the process variable. | See the <b>Burst variable 0</b> parameter.  | Not used        |
| Burst variable 4     | For HART command 9: select the HART device variable or the process variable.        | See the <b>Burst variable 0</b> parameter.  | Not used        |
| Burst variable 5     | For HART command 9: select the HART device variable or the process variable.        | See the <b>Burst variable 0</b> parameter.  | Not used        |
| Burst variable 6     | For HART command 9: select the HART device variable or the process variable.        | See the <b>Burst variable 0</b> parameter.  | Not used        |
| Burst variable 7     | For HART command 9: select the HART device variable or the process variable.        | See the <b>Burst variable 0</b> parameter.  | Not used        |
| Burst trigger mode   | Select the event that triggers burst message X.                                     | <ul style="list-style-type: none"> <li>■ Continuous</li> <li>■ Window</li> <li>■ Rising</li> <li>■ Falling</li> <li>■ On change</li> </ul>  | Continuous      |

| Parameter           | Description  | Selection / User entry         | Factory setting |
|---------------------|--|--------------------------------|-----------------|
| Burst trigger level | Enter the burst trigger value.<br>Together with the option selected in the <b>Burst trigger mode</b> parameter the burst trigger value determines the time of burst message X. | Positive floating-point number | –               |
| Min. update period  | Enter the minimum time span between two burst commands of burst message X.   | Positive integer               | 1 000 ms        |
| Max. update period  | Enter the maximum time span between two burst commands of burst message X.   | Positive integer               | 2 000 ms        |

## 10 Commissioning

### 10.1 Function check

Before commissioning the measuring device:

- ▶ Make sure that the post-installation and post-connection checks have been performed.
- "Post-installation check" checklist → 📄 28
- "Post-connection check" checklist → 📄 36

### 10.2 Switching on the measuring device

- ▶ After a successful function check, switch on the measuring device.
  - ↳ After a successful startup, the local display switches automatically from the startup display to the operational display.

**i** If nothing appears on the local display or a diagnostic message is displayed, refer to the section on "Diagnostics and troubleshooting" → 📄 101.

### 10.3 Setting the operating language

Factory setting: English or ordered local language

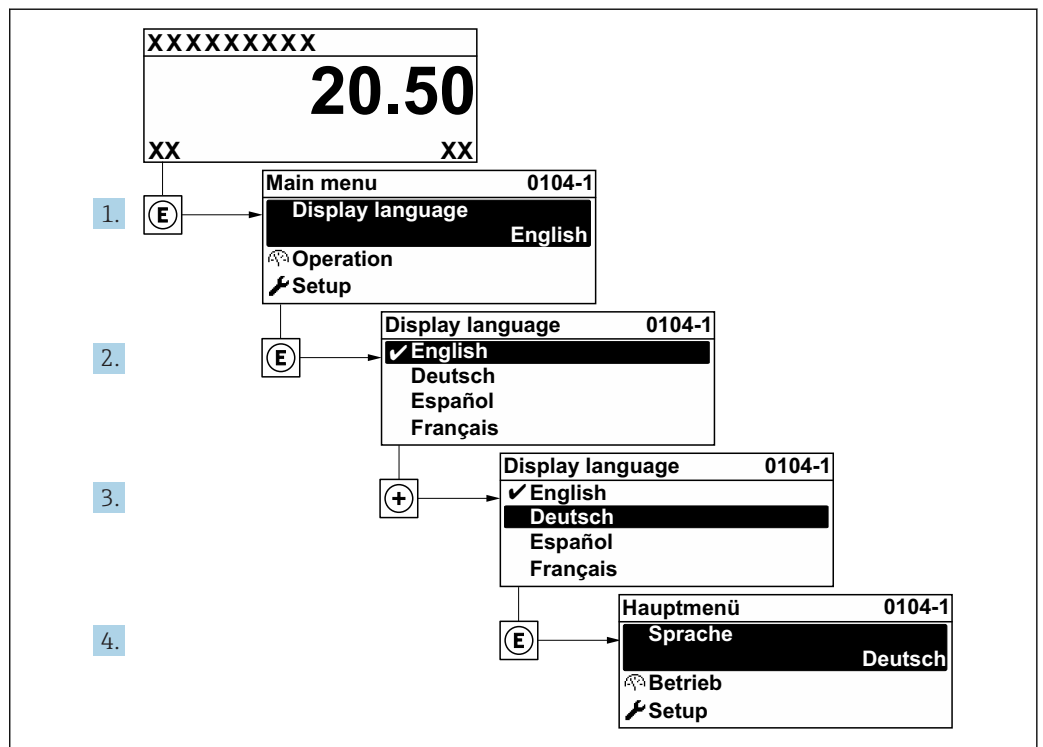

📄 13 Taking the example of the local display

### 10.4 Configuring the measuring device

- The **Setup** menu with its guided wizards contains all the parameters needed for standard operation.
- Navigation to the **Setup** menu

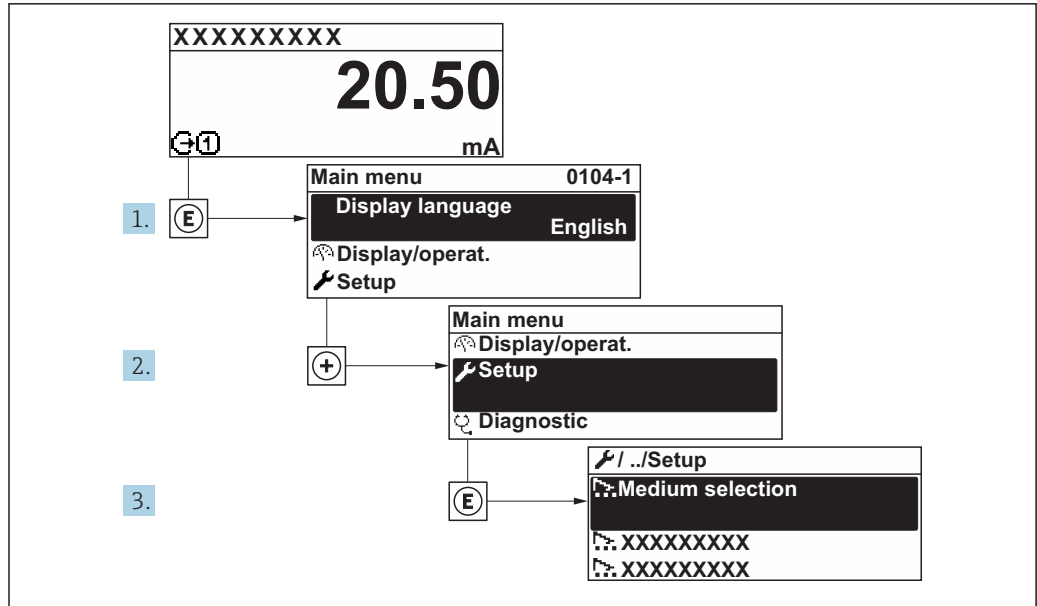

A0032222-EN

14 Taking the example of the local display

| 🔧 Setup                           |      |
|-----------------------------------|------|
| Device tag                        | → 63 |
| ▶ Select medium                   |      |
| ▶ System units                    | → 64 |
| ▶ Current output 1 to n           | → 67 |
| ▶ Pulse/frequency/switch output   | → 68 |
| ▶ Display                         | → 74 |
| ▶ Output conditioning             | → 75 |
| ▶ Low flow cut off                | → 78 |
| ▶ Partially filled pipe detection | → 79 |
| ▶ Advanced setup                  | → 80 |

### 10.4.1 Defining the tag name

To enable fast identification of the measuring point within the system, you can enter a unique designation using the **Device tag** parameter and thus change the factory setting.

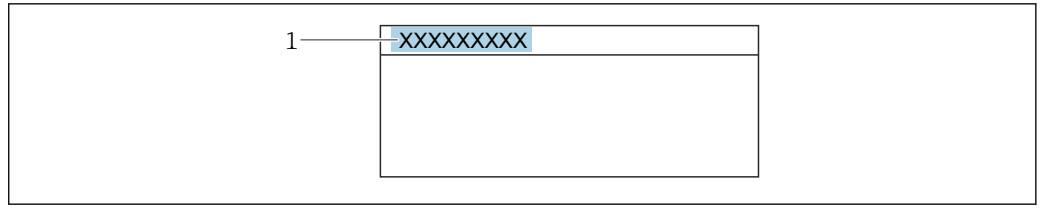

A0029422

 15 Header of the operational display with tag name

1 Tag name

 Enter the tag name in the "FieldCare" operating tool →  54

### Navigation

"Setup" menu → Device tag

### Parameter overview with brief description

| Parameter  | Description                             | User entry   | Factory setting |
|------------|---|--|-----------------|
| Device tag | Enter the name for the measuring point. | Max. 32 characters, such as letters, numbers or special characters (e.g. @, %, /). | Promass         |

## 10.4.2 Selecting and setting the medium

The **Medium selection** wizard systematically guides the user through all the parameters that must be configured in order to select and set the medium.

### Navigation

"Setup" menu → Medium selection

| ► Select medium                        |      |
|--|------|
| Select medium                          | → 64 |
| Select gas type                        | → 64 |
| Reference sound velocity               | → 64 |
| Temperature coefficient sound velocity | → 64 |
| Pressure compensation                  | → 64 |
| Pressure value                         | → 64 |

### Parameter overview with brief description

| Parameter                              | Prerequisite   | Description  | Selection / User entry   | Factory setting  |
|--|--|--|--|--|
| Select medium                          | –  | Select medium type.  | <ul style="list-style-type: none"> <li>▪ Liquid</li> <li>▪ Gas</li> </ul>                                | Liquid   |
| Select gas type                        | In the <b>Select medium</b> parameter the <b>Gas</b> option is selected.                 | Select measured gas type.                                  | Gas type choose list   | Air  |
| Reference sound velocity               | In the <b>Select gas type</b> parameter the <b>Others</b> option is selected.            | Enter sound velocity of gas at 0 °C (32 °F).               | 1 to 99999.9999 m/s  | 331.5 m/s  |
| Temperature coefficient sound velocity | In the <b>Select gas type</b> parameter the <b>Others</b> option is selected.            | Enter temperature coefficient for the gas sound velocity.  | Positive floating-point number   | 0.61 (m/s)/K   |
| Pressure compensation                  | –  | Select pressure compensation type.                         | <ul style="list-style-type: none"> <li>▪ Off</li> <li>▪ Fixed value</li> <li>▪ External value</li> </ul> | Off  |
| Pressure value                         | In the <b>Pressure compensation</b> parameter the <b>Fixed value</b> option is selected. | Enter process pressure to be used for pressure correction. | Positive floating-point number   | Country-specific: <ul style="list-style-type: none"> <li>▪ 1.01 bar a</li> <li>▪ 14.7 psi a</li> </ul> |

## 10.4.3 Setting the system units

In the **System units** submenu the units of all the measured values can be set.

 Depending on the device version, not all submenus and parameters are available in every device. The selection can vary depending on the order code.





**Navigation**

"Setup" menu → System units

| ► System units             |   |    |
|----------------------------|---|----|
| Mass flow unit             | → | 65 |
| Mass unit                  | → | 65 |
| Volume flow unit           | → | 65 |
| Volume unit                | → | 65 |
| Corrected volume flow unit | → | 66 |
| Corrected volume unit      | → | 66 |
| Density unit               | → | 66 |
| Reference density unit     | → | 66 |
| Temperature unit           | → | 66 |
| Length unit                | → | 66 |
| Pressure unit              | → | 66 |

**Parameter overview with brief description**

| Parameter        | Description  | Selection        | Factory setting  |
|------------------|--|------------------|--|
| Mass flow unit   | Select mass flow unit.<br><i>Result</i><br>The selected unit applies for:<br><ul style="list-style-type: none"> <li>▪ Output</li> <li>▪ Low flow cut off</li> <li>▪ Simulation process variable</li> </ul>   | Unit choose list | Country-specific:<br><ul style="list-style-type: none"> <li>▪ kg/h</li> <li>▪ lb/min</li> </ul>      |
| Mass unit        | Select mass unit.  | Unit choose list | Country-specific:<br><ul style="list-style-type: none"> <li>▪ kg</li> <li>▪ lb</li> </ul>            |
| Volume flow unit | Select volume flow unit.<br><i>Result</i><br>The selected unit applies for:<br><ul style="list-style-type: none"> <li>▪ Output</li> <li>▪ Low flow cut off</li> <li>▪ Simulation process variable</li> </ul> | Unit choose list | Country-specific:<br><ul style="list-style-type: none"> <li>▪ l/h</li> <li>▪ gal/min (us)</li> </ul> |
| Volume unit      | Select volume unit.  | Unit choose list | Country-specific:<br><ul style="list-style-type: none"> <li>▪ l</li> <li>▪ gal (us)</li> </ul>       |

| Parameter                  | Description   | Selection        | Factory setting  |
|----------------------------|---|------------------|--|
| Corrected volume flow unit | Select corrected volume flow unit.<br><i>Result</i><br>The selected unit applies for:<br><b>Corrected volume flow</b> parameter<br>(→  95)   | Unit choose list | Country-specific:<br><ul style="list-style-type: none"> <li>▪ NI/h</li> <li>▪ Sft<sup>3</sup>/min</li> </ul> |
| Corrected volume unit      | Select corrected volume unit.   | Unit choose list | Country-specific:<br><ul style="list-style-type: none"> <li>▪ NI</li> <li>▪ Sft<sup>3</sup></li> </ul>       |
| Density unit               | Select density unit.<br><i>Result</i><br>The selected unit applies for:<br><ul style="list-style-type: none"> <li>▪ Output</li> <li>▪ Simulation process variable</li> <li>▪ Density adjustment (<b>Expert</b> menu)</li> </ul>   | Unit choose list | Country-specific:<br><ul style="list-style-type: none"> <li>▪ kg/l</li> <li>▪ lb/ft<sup>3</sup></li> </ul>   |
| Reference density unit     | Select reference density unit.  | Unit choose list | Country-dependent<br><ul style="list-style-type: none"> <li>▪ kg/NI</li> <li>▪ lb/Sft<sup>3</sup></li> </ul> |
| Temperature unit           | Select temperature unit.<br><i>Result</i><br>The selected unit applies for:<br><ul style="list-style-type: none"> <li>▪ Minimum value</li> <li>▪ Maximum value</li> <li>▪ Maximum value</li> <li>▪ Minimum value</li> <li>▪ Average value</li> <li>▪ Minimum value</li> <li>▪ Maximum value</li> <li>▪ Minimum value</li> <li>▪ Maximum value</li> <li>▪ Reference temperature</li> </ul> | Unit choose list | Country-specific:<br><ul style="list-style-type: none"> <li>▪ °C</li> <li>▪ °F</li> </ul>                    |
| Length unit                | Select length unit for nominal diameter.  | Unit choose list | Country-specific:<br><ul style="list-style-type: none"> <li>▪ mm</li> <li>▪ in</li> </ul>                    |
| Pressure unit              | Select process pressure unit.<br><i>Result</i><br>The unit is taken from:<br><ul style="list-style-type: none"> <li>▪ <b>Pressure value</b> parameter (→  64)</li> <li>▪ <b>External pressure</b> parameter</li> </ul>   | Unit choose list | Country-specific:<br><ul style="list-style-type: none"> <li>▪ bar a</li> <li>▪ psi a</li> </ul>              |

### 10.4.4 Configuring the current output

The **Current output** wizard guides you systematically through all the parameters that have to be set for configuring the current output.



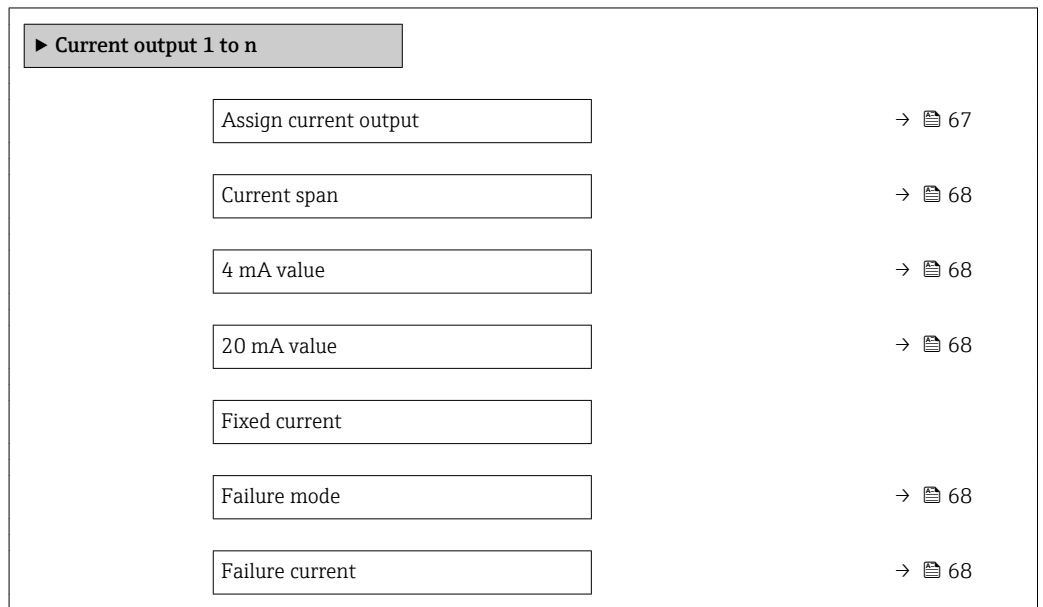

#### Navigation

"Setup" menu → Current output 1 to n



#### Parameter overview with brief description

| Parameter                         | Prerequisite   | Description   | Selection / User entry   | Factory setting              |
|-----------------------------------|--|---|--|------------------------------|
| Assign current output             | –  | Select process variable for current output.                         | <ul style="list-style-type: none"> <li>▪ Off</li> <li>▪ Mass flow</li> <li>▪ Volume flow</li> <li>▪ Corrected volume flow</li> <li>▪ Density</li> <li>▪ Reference density</li> <li>▪ Temperature</li> <li>▪ Electronic temperature</li> <li>▪ Oscillation frequency</li> <li>▪ Oscillation amplitude</li> <li>▪ Oscillation damping</li> <li>▪ Signal asymmetry</li> </ul> | Mass flow                    |
| Corrected volume flow calculation | –  | Select reference density for calculating the corrected volume flow. | <ul style="list-style-type: none"> <li>▪ Fixed reference density</li> <li>▪ Calculated reference density</li> </ul>  | Calculated reference density |
| Fixed reference density           | The <b>Fixed reference density</b> option is selected in the <b>Corrected volume flow calculation</b> parameter parameter. | Enter fixed value for reference density.                            | Positive floating-point number   | 1 kg/Nl                      |

| Parameter                    | Prerequisite  | Description  | Selection / User entry  | Factory setting  |
|------------------------------|---|--|---|--|
| Linear expansion coefficient | The <b>Calculated reference density</b> option is selected in the <b>Corrected volume flow calculation</b> parameter.   | Enter linear, medium-specific expansion coefficient for calculating the reference density.   | Signed floating-point number  | 0.0  |
| Square expansion coefficient | The <b>Calculated reference density</b> option is selected in the <b>Corrected volume flow calculation</b> parameter.   | For media with a non-linear expansion pattern: enter the quadratic, medium-specific expansion coefficient for calculating the reference density. | Signed floating-point number  | 0.0  |
| Reference temperature        | The <b>Calculated reference density</b> option is selected in the <b>Corrected volume flow calculation</b> parameter.   | Enter reference temperature for calculating the reference density.   | -273.15 to 99 999 °C  | Country-specific:<br><ul style="list-style-type: none"> <li>■ +20 °C</li> <li>■ +68 °F</li> </ul>                |
| Current span                 | -   | Select current range for process value output and upper/lower level for alarm signal.  | <ul style="list-style-type: none"> <li>■ 4...20 mA NAMUR</li> <li>■ 4...20 mA US</li> <li>■ 4...20 mA</li> <li>■ Fixed current</li> </ul>             | Country-specific:<br><ul style="list-style-type: none"> <li>■ 4...20 mA NAMUR</li> <li>■ 4...20 mA US</li> </ul> |
| 4 mA value                   | One of the following options is selected in the <b>Current span</b> parameter (→  68):<br><ul style="list-style-type: none"> <li>■ 4...20 mA NAMUR</li> <li>■ 4...20 mA US</li> <li>■ 4...20 mA</li> </ul>   | Enter 4 mA value.  | Signed floating-point number  | Country-specific:<br><ul style="list-style-type: none"> <li>■ 0 kg/h</li> <li>■ 0 lb/min</li> </ul>              |
| 20 mA value                  | One of the following options is selected in the <b>Current span</b> parameter (→  68):<br><ul style="list-style-type: none"> <li>■ 4...20 mA NAMUR</li> <li>■ 4...20 mA US</li> <li>■ 4...20 mA</li> </ul>   | Enter 20 mA value.   | Signed floating-point number  | Depends on country and nominal diameter  |
| Failure mode                 | A process variable is selected in the <b>Assign current output</b> parameter (→  67) and one of the following options is selected in the <b>Current span</b> parameter (→  68):<br><ul style="list-style-type: none"> <li>■ 4...20 mA NAMUR</li> <li>■ 4...20 mA US</li> <li>■ 4...20 mA</li> </ul> | Define output behavior in alarm condition.   | <ul style="list-style-type: none"> <li>■ Min.</li> <li>■ Max.</li> <li>■ Last valid value</li> <li>■ Actual value</li> <li>■ Defined value</li> </ul> | Max.   |
| Failure current              | The <b>Defined value</b> option is selected in the <b>Failure mode</b> parameter.   | Enter current output value in alarm condition.   | 3.59 to 22.5 mA   | 22.5 mA  |

### 10.4.5 Configuring the pulse/frequency/switch output

The **Pulse/frequency/switch output** wizard guides you systematically through all the parameters that can be set for configuring the selected output type.

#### Navigation

"Setup" menu → Pulse/frequency/switch output

▶ Pulse/frequency/switch output

Operating mode

→  69

**Parameter overview with brief description**

| Parameter      | Description   | Selection  | Factory setting |
|----------------|---|--|-----------------|
| Operating mode | Define the output as a pulse, frequency or switch output. | <ul style="list-style-type: none"> <li>■ Pulse</li> <li>■ Frequency</li> <li>■ Switch</li> </ul> | Pulse           |

**Configuring the pulse output**

**Navigation**

"Setup" menu → Pulse/frequency/switch output

▶ Pulse/frequency/switch output

|                      |        |
|----------------------|--------|
| Operating mode       | → ⓘ 69 |
| Assign pulse output  | → ⓘ 69 |
| Value per pulse      | → ⓘ 69 |
| Pulse width          | → ⓘ 69 |
| Failure mode         | → ⓘ 70 |
| Invert output signal | → ⓘ 70 |

**Parameter overview with brief description**

| Parameter           | Prerequisite   | Description   | Selection / User entry   | Factory setting                         |
|---------------------|--|---|--|---|
| Operating mode      | –  | Define the output as a pulse, frequency or switch output. | <ul style="list-style-type: none"> <li>■ Pulse</li> <li>■ Frequency</li> <li>■ Switch</li> </ul>                                     | Pulse                                   |
| Assign pulse output | The <b>Pulse</b> option is selected in the <b>Operating mode</b> parameter parameter.  | Select process variable for pulse output.                 | <ul style="list-style-type: none"> <li>■ Off</li> <li>■ Mass flow</li> <li>■ Volume flow</li> <li>■ Corrected volume flow</li> </ul> | Off                                     |
| Value per pulse     | The <b>Pulse</b> option is selected in the <b>Operating mode</b> parameter (→ ⓘ 69) and a process variable is selected in the <b>Assign pulse output</b> parameter (→ ⓘ 69). | Enter measured value at which a pulse is output.          | Signed floating-point number   | Depends on country and nominal diameter |
| Pulse width         | The <b>Pulse</b> option is selected in the <b>Operating mode</b> parameter (→ ⓘ 69) and a process variable is selected in the <b>Assign pulse output</b> parameter (→ ⓘ 69). | Define time width of the output pulse.                    | 5 to 2 000 ms  | 100 ms                                  |

| Parameter            | Prerequisite   | Description                                | Selection / User entry  | Factory setting |
|----------------------|--|--|---|-----------------|
| Failure mode         | The <b>Pulse</b> option is selected in the <b>Operating mode</b> parameter (→ 69) and a process variable is selected in the <b>Assign pulse output</b> parameter (→ 69). | Define output behavior in alarm condition. | <ul style="list-style-type: none"> <li>▪ Actual value</li> <li>▪ No pulses</li> </ul> | No pulses       |
| Invert output signal | –  | Invert the output signal.                  | <ul style="list-style-type: none"> <li>▪ No</li> <li>▪ Yes</li> </ul>                 | No              |

## Configuring the frequency output



### Navigation

"Setup" menu → Pulse/frequency/switch output

| ► Pulse/frequency/switch output      |      |
|--------------------------------------|------|
| Operating mode                       | → 71 |
| Assign frequency output              | → 71 |
| Minimum frequency value              | → 71 |
| Maximum frequency value              | → 71 |
| Measuring value at minimum frequency | → 71 |
| Measuring value at maximum frequency | → 71 |
| Failure mode                         | → 71 |
| Failure frequency                    | → 72 |
| Invert output signal                 | → 72 |

## Parameter overview with brief description













| Parameter                            | Prerequisite   | Description   | Selection / User entry   | Factory setting                         |
|--------------------------------------|--|---|--|---|
| Operating mode                       | –  | Define the output as a pulse, frequency or switch output. | <ul style="list-style-type: none"> <li>■ Pulse</li> <li>■ Frequency</li> <li>■ Switch</li> </ul>   | Pulse                                   |
| Assign frequency output              | The <b>Frequency</b> option is selected in the <b>Operating mode</b> parameter (→ 69) parameter.   | Select process variable for frequency output.             | <ul style="list-style-type: none"> <li>■ Off</li> <li>■ Mass flow</li> <li>■ Volume flow</li> <li>■ Corrected volume flow</li> <li>■ Density</li> <li>■ Reference density</li> <li>■ Temperature</li> <li>■ Electronic temperature</li> <li>■ Oscillation frequency</li> <li>■ Oscillation amplitude</li> <li>■ Oscillation damping</li> <li>■ Signal asymmetry</li> </ul> | Off                                     |
| Minimum frequency value              | The <b>Frequency</b> option is selected in the <b>Operating mode</b> parameter (→ 69) and a process variable is selected in the <b>Assign frequency output</b> parameter (→ 71). | Enter minimum frequency.                                  | 0 to 1000 Hz   | 0 Hz                                    |
| Maximum frequency value              | The <b>Frequency</b> option is selected in the <b>Operating mode</b> parameter (→ 69) and a process variable is selected in the <b>Assign frequency output</b> parameter (→ 71). | Enter maximum frequency.                                  | 0 to 1000 Hz   | 1000 Hz                                 |
| Measuring value at minimum frequency | The <b>Frequency</b> option is selected in the <b>Operating mode</b> parameter (→ 69) and a process variable is selected in the <b>Assign frequency output</b> parameter (→ 71). | Enter measured value for minimum frequency.               | Signed floating-point number   | Depends on country and nominal diameter |
| Measuring value at maximum frequency | The <b>Frequency</b> option is selected in the <b>Operating mode</b> parameter (→ 69) and a process variable is selected in the <b>Assign frequency output</b> parameter (→ 71). | Enter measured value for maximum frequency.               | Signed floating-point number   | Depends on country and nominal diameter |
| Failure mode                         | The <b>Frequency</b> option is selected in the <b>Operating mode</b> parameter (→ 69) and a process variable is selected in the <b>Assign frequency output</b> parameter (→ 71). | Define output behavior in alarm condition.                | <ul style="list-style-type: none"> <li>■ Actual value</li> <li>■ Defined value</li> <li>■ 0 Hz</li> </ul>  | 0 Hz                                    |

| Parameter            | Prerequisite   | Description                                      | Selection / User entry  | Factory setting |
|----------------------|--|--|---|-----------------|
| Failure frequency    | The <b>Frequency</b> option is selected in the <b>Operating mode</b> parameter (→  69) and a process variable is selected in the <b>Assign frequency output</b> parameter (→  71). | Enter frequency output value in alarm condition. | 0.0 to 1 250.0 Hz   | 0.0 Hz          |
| Invert output signal | –  | Invert the output signal.                        | <ul style="list-style-type: none"> <li>▪ No</li> <li>▪ Yes</li> </ul> | No              |

### Configuring the switch output

#### Navigation

"Setup" menu → Pulse/frequency/switch output

| ► Pulse/frequency/switch output |  |
|---------------------------------|--|
| Operating mode                  | →  73   |
| Switch output function          | →  73   |
| Assign diagnostic behavior      | →  73 |
| Assign limit                    | →  73 |
| Assign flow direction check     | →  73 |
| Assign status                   | →  73 |
| Switch-on value                 | →  73 |
| Switch-off value                | →  73 |
| Switch-on delay                 | →  73 |
| Switch-off delay                | →  74 |
| Failure mode                    | →  74 |
| Invert output signal            | →  74 |



## Parameter overview with brief description

| Parameter                   | Prerequisite  | Description   | Selection / User entry  | Factory setting  |
|-----------------------------|---|---|---|--|
| Operating mode              | –   | Define the output as a pulse, frequency or switch output. | <ul style="list-style-type: none"> <li>■ Pulse</li> <li>■ Frequency</li> <li>■ Switch</li> </ul>  | Pulse  |
| Switch output function      | The <b>Switch</b> option is selected in the <b>Operating mode</b> parameter.  | Select function for switch output.                        | <ul style="list-style-type: none"> <li>■ Off</li> <li>■ On</li> <li>■ Diagnostic behavior</li> <li>■ Limit</li> <li>■ Flow direction check</li> <li>■ Status</li> </ul>   | Off  |
| Assign diagnostic behavior  | <ul style="list-style-type: none"> <li>■ In the <b>Operating mode</b> parameter, the <b>Switch</b> option is selected.</li> <li>■ In the <b>Switch output function</b> parameter, the <b>Diagnostic behavior</b> option is selected.</li> </ul> | Select diagnostic behavior for switch output.             | <ul style="list-style-type: none"> <li>■ Alarm</li> <li>■ Alarm or warning</li> <li>■ Warning</li> </ul>  | Alarm  |
| Assign limit                | <ul style="list-style-type: none"> <li>■ The <b>Switch</b> option is selected in the <b>Operating mode</b> parameter.</li> <li>■ The <b>Limit</b> option is selected in the <b>Switch output function</b> parameter.</li> </ul>                 | Select process variable for limit function.               | <ul style="list-style-type: none"> <li>■ Mass flow</li> <li>■ Volume flow</li> <li>■ Corrected volume flow</li> <li>■ Density</li> <li>■ Reference density</li> <li>■ Temperature</li> <li>■ Totalizer 1</li> <li>■ Totalizer 2</li> <li>■ Totalizer 3</li> </ul> | Mass flow  |
| Assign flow direction check | <ul style="list-style-type: none"> <li>■ The <b>Switch</b> option is selected in the <b>Operating mode</b> parameter.</li> <li>■ The <b>Flow direction check</b> option is selected in the <b>Switch output function</b> parameter.</li> </ul>  | Select process variable for flow direction monitoring.    | <ul style="list-style-type: none"> <li>■ Mass flow</li> <li>■ Volume flow</li> <li>■ Corrected volume flow</li> </ul>   | Mass flow  |
| Assign status               | <ul style="list-style-type: none"> <li>■ The <b>Switch</b> option is selected in the <b>Operating mode</b> parameter.</li> <li>■ The <b>Status</b> option is selected in the <b>Switch output function</b> parameter.</li> </ul>                | Select device status for switch output.                   | <ul style="list-style-type: none"> <li>■ Partially filled pipe detection</li> <li>■ Low flow cut off</li> </ul>   | Partially filled pipe detection  |
| Switch-on value             | <ul style="list-style-type: none"> <li>■ In the <b>Operating mode</b> parameter, the <b>Switch</b> option is selected.</li> <li>■ In the <b>Switch output function</b> parameter, the <b>Limit</b> option is selected.</li> </ul>               | Enter measured value for the switch-on point.             | Signed floating-point number  | Country-specific: <ul style="list-style-type: none"> <li>■ 0 kg/h</li> <li>■ 0 lb/min</li> </ul> |
| Switch-off value            | <ul style="list-style-type: none"> <li>■ In the <b>Operating mode</b> parameter, the <b>Switch</b> option is selected.</li> <li>■ In the <b>Switch output function</b> parameter, the <b>Limit</b> option is selected.</li> </ul>               | Enter measured value for the switch-off point.            | Signed floating-point number  | Country-specific: <ul style="list-style-type: none"> <li>■ 0 kg/h</li> <li>■ 0 lb/min</li> </ul> |
| Switch-on delay             | <ul style="list-style-type: none"> <li>■ The <b>Switch</b> option is selected in the <b>Operating mode</b> parameter.</li> <li>■ The <b>Limit</b> option is selected in the <b>Switch output function</b> parameter.</li> </ul>                 | Define delay for the switch-on of status output.          | 0.0 to 100.0 s  | 0.0 s  |

| Parameter            | Prerequisite  | Description                                       | Selection / User entry  | Factory setting |
|----------------------|---|---|---|-----------------|
| Switch-off delay     | <ul style="list-style-type: none"> <li>▪ The <b>Switch</b> option is selected in the <b>Operating mode</b> parameter.</li> <li>▪ The <b>Limit</b> option is selected in the <b>Switch output function</b> parameter.</li> </ul> | Define delay for the switch-off of status output. | 0.0 to 100.0 s  | 0.0 s           |
| Failure mode         | –   | Define output behavior in alarm condition.        | <ul style="list-style-type: none"> <li>▪ Actual status</li> <li>▪ Open</li> <li>▪ Closed</li> </ul> | Open            |
| Invert output signal | –   | Invert the output signal.                         | <ul style="list-style-type: none"> <li>▪ No</li> <li>▪ Yes</li> </ul>                               | No              |

### 10.4.6 Configuring the local display

The **Display** wizard guides you systematically through all the parameters that can be configured for configuring the local display.

#### Navigation

"Setup" menu → Display

| ► Display             |      |
|-----------------------|------|
| Format display        | → 75 |
| Value 1 display       | → 75 |
| 0% bargraph value 1   | → 75 |
| 100% bargraph value 1 | → 75 |
| Value 2 display       | → 75 |
| Value 3 display       | → 75 |
| 0% bargraph value 3   | → 75 |
| 100% bargraph value 3 | → 75 |
| Value 4 display       | → 75 |

**Parameter overview with brief description**

| Parameter             | Prerequisite  | Description   | Selection / User entry  | Factory setting  |
|-----------------------|---|---|---|--|
| Format display        | A local display is provided.                                  | Select how measured values are shown on the display.          | <ul style="list-style-type: none"> <li>■ 1 value, max. size</li> <li>■ 1 bargraph + 1 value</li> <li>■ 2 values</li> <li>■ 1 value large + 2 values</li> <li>■ 4 values</li> </ul>  | 1 value, max. size   |
| Value 1 display       | A local display is provided.                                  | Select the measured value that is shown on the local display. | <ul style="list-style-type: none"> <li>■ None</li> <li>■ Mass flow</li> <li>■ Volume flow</li> <li>■ Corrected volume flow</li> <li>■ Density</li> <li>■ Reference density</li> <li>■ Temperature</li> <li>■ Totalizer 1</li> <li>■ Totalizer 2</li> <li>■ Totalizer 3</li> <li>■ Current output 1</li> <li>■ Current output 2 *</li> </ul> | Mass flow  |
| 0% bargraph value 1   | A local display is provided.                                  | Enter 0% value for bar graph display.                         | Signed floating-point number  | Country-specific: <ul style="list-style-type: none"> <li>■ 0 kg/h</li> <li>■ 0 lb/min</li> </ul> |
| 100% bargraph value 1 | A local display is provided.                                  | Enter 100% value for bar graph display.                       | Signed floating-point number  | Depends on country and nominal diameter  |
| Value 2 display       | A local display is provided.                                  | Select the measured value that is shown on the local display. | For the picklist, see the <b>Value 1 display</b> parameter  | None   |
| Value 3 display       | A local display is provided.                                  | Select the measured value that is shown on the local display. | For the picklist, see the <b>Value 1 display</b> parameter (→ 75)   | None   |
| 0% bargraph value 3   | A selection was made in the <b>Value 3 display</b> parameter. | Enter 0% value for bar graph display.                         | Signed floating-point number  | Country-specific: <ul style="list-style-type: none"> <li>■ 0 kg/h</li> <li>■ 0 lb/min</li> </ul> |
| 100% bargraph value 3 | A selection was made in the <b>Value 3 display</b> parameter. | Enter 100% value for bar graph display.                       | Signed floating-point number  | 0  |
| Value 4 display       | A local display is provided.                                  | Select the measured value that is shown on the local display. | For the picklist, see the <b>Value 1 display</b> parameter (→ 75)   | None   |

\* Visibility depends on order options or device settings









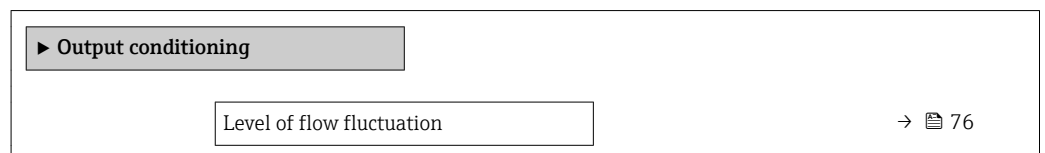





**10.4.7 Configuring the output conditioning**

The **Output conditioning** wizard guides you systematically through all the parameters that have to be set for configuring the output conditioning.

**Navigation**

"Setup" menu → Output conditioning



|                            |  |
|----------------------------|--|
| Display damping            | →  76   |
| Damping output 1           | →  76   |
| Damping output 2           | →  76   |
| Damping output 2           | →  76   |
| Measuring mode output 1    | →  77   |
| Measuring mode output 2    | →  77   |
| Measuring mode output 2    | →  77   |
| Measuring mode output 2    | →  77   |
| Operating mode totalizer 1 | →  77   |
| Operating mode totalizer 2 | →  77   |
| Operating mode totalizer 3 | →  77 |
| Assign process variable    | →  77 |
| On value low flow cutoff   | →  77 |
| Off value low flow cutoff  | →  77 |
| Pressure shock suppression | →  77 |

### Parameter overview with brief description

| Parameter                 | Prerequisite  | Description  | Selection / User entry   | Factory setting |
|---------------------------|---|--|--|-----------------|
| Level of flow fluctuation | –   | Select fluctuation level of measured value.  | <ul style="list-style-type: none"> <li>▪ Slight</li> <li>▪ Moderate</li> <li>▪ Strong</li> </ul> | Moderate        |
| Display damping           | –   | Set display reaction time to fluctuations in the measured value.   | 0.0 to 999.9 s   | 0.0 s           |
| Damping output 1          | –   | Set the reaction time of the output signal of the current output to fluctuations in the measured value.        | 0 to 999.9 s   | 1 s             |
| Damping output 2          | The measuring device has a second current output.         | Set the reaction time of the output signal of the second current output to fluctuations in the measured value. | 0 to 999.9 s   | 1 s             |
| Damping output 2          | The measuring device has a pulse/frequency/switch output. | Set the reaction time of the output signal of the frequency output to fluctuations in the measured value.      | 0 to 999.9 s   | 1 s             |

| Parameter                  | Prerequisite   | Description  | Selection / User entry  | Factory setting                         |
|----------------------------|--|--|---|---|
| Measuring mode output 1    | –  | Select measuring mode for output.  | <ul style="list-style-type: none"> <li>■ Forward flow</li> <li>■ Forward/Reverse flow</li> <li>■ Reverse flow compensation</li> </ul>                         | Forward flow                            |
| Measuring mode output 2    | –  | Select measuring mode for output.  | <ul style="list-style-type: none"> <li>■ Forward flow</li> <li>■ Forward/Reverse flow</li> <li>■ Reverse flow compensation</li> </ul>                         | Forward flow                            |
| Measuring mode output 2    | –  | Select measuring mode for output.  | <ul style="list-style-type: none"> <li>■ Forward flow</li> <li>■ Forward/Reverse flow</li> <li>■ Reverse flow</li> <li>■ Reverse flow compensation</li> </ul> | Forward flow                            |
| Measuring mode output 2    | –  | Select measuring mode for output.  | <ul style="list-style-type: none"> <li>■ Forward flow</li> <li>■ Forward/Reverse flow</li> <li>■ Reverse flow</li> <li>■ Reverse flow compensation</li> </ul> | Forward flow                            |
| Operating mode totalizer 1 | –  | Select totalizer calculation mode.   | <ul style="list-style-type: none"> <li>■ Net flow total</li> <li>■ Forward flow total</li> <li>■ Reverse flow total</li> </ul>                                | Net flow total                          |
| Operating mode totalizer 2 | –  | Select totalizer calculation mode.   | <ul style="list-style-type: none"> <li>■ Net flow total</li> <li>■ Forward flow total</li> <li>■ Reverse flow total</li> </ul>                                | Net flow total                          |
| Operating mode totalizer 3 | –  | Select totalizer calculation mode.   | <ul style="list-style-type: none"> <li>■ Net flow total</li> <li>■ Forward flow total</li> <li>■ Reverse flow total</li> </ul>                                | Net flow total                          |
| Assign process variable    | –  | Select process variable for low flow cut off.                                  | <ul style="list-style-type: none"> <li>■ Off</li> <li>■ Mass flow</li> <li>■ Volume flow</li> <li>■ Corrected volume flow</li> </ul>                          | Mass flow                               |
| On value low flow cutoff   | A process variable is selected in the <b>Assign process variable</b> parameter (→ 77). | Enter on value for low flow cut off.   | Positive floating-point number  | Depends on country and nominal diameter |
| Off value low flow cutoff  | A process variable is selected in the <b>Assign process variable</b> parameter (→ 77). | Enter off value for low flow cut off.  | 0 to 100.0 %  | 50 %                                    |
| Pressure shock suppression | A process variable is selected in the <b>Assign process variable</b> parameter (→ 77). | Enter time frame for signal suppression (= active pressure shock suppression). | 0 to 100 s  | 0 s                                     |

## 10.4.8 Configuring the low flow cut off

The **Low flow cut off** wizard systematically guides the user through all the parameters that must be set to configure low flow cut off.

### Navigation

"Setup" menu → Low flow cut off

| ► Low flow cut off         |      |
|----------------------------|------|
| Assign process variable    | → 78 |
| On value low flow cutoff   | → 78 |
| Off value low flow cutoff  | → 78 |
| Pressure shock suppression | → 78 |

### Parameter overview with brief description

| Parameter                  | Prerequisite   | Description  | Selection / User entry   | Factory setting                         |
|----------------------------|--|--|--|---|
| Assign process variable    | –  | Select process variable for low flow cut off.                                  | <ul style="list-style-type: none"> <li>▪ Off</li> <li>▪ Mass flow</li> <li>▪ Volume flow</li> <li>▪ Corrected volume flow</li> </ul> | Mass flow                               |
| On value low flow cutoff   | A process variable is selected in the <b>Assign process variable</b> parameter (→ 77). | Enter on value for low flow cut off.   | Positive floating-point number   | Depends on country and nominal diameter |
| Off value low flow cutoff  | A process variable is selected in the <b>Assign process variable</b> parameter (→ 77). | Enter off value for low flow cut off.  | 0 to 100.0 %   | 50 %                                    |
| Pressure shock suppression | A process variable is selected in the <b>Assign process variable</b> parameter (→ 77). | Enter time frame for signal suppression (= active pressure shock suppression). | 0 to 100 s   | 0 s                                     |

### 10.4.9 Configuring the partial filled pipe detection

The **Partial filled pipe detection** wizard guides you systematically through all parameters that have to be set for configuring the monitoring of the pipe filling.

#### Navigation

"Setup" menu → Partially filled pipe detection

▶ Partially filled pipe detection

|  |       |
|--|-------|
| Assign process variable                  | →  79 |
| Low value partial filled pipe detection  | →  79 |
| High value partial filled pipe detection | →  79 |
| Response time part. filled pipe detect.  | →  79 |

#### Parameter overview with brief description

| Parameter                                | Prerequisite   | Description  | Selection / User entry  | Factory setting |
|--|--|--|---|-----------------|
| Assign process variable                  | –  | Select process variable for partially filled pipe detection.                           | <ul style="list-style-type: none"> <li>■ Off</li> <li>■ Density</li> <li>■ Reference density</li> </ul> | Off             |
| Low value partial filled pipe detection  | One of the following options is selected in the <b>Assign process variable</b> parameter: <ul style="list-style-type: none"> <li>■ Density</li> <li>■ Reference density</li> </ul> | Enter lower limit value for deactivating partialy filled pipe detection.               | Positive floating-point number  | 200             |
| High value partial filled pipe detection | One of the following options is selected in the <b>Assign process variable</b> parameter: <ul style="list-style-type: none"> <li>■ Density</li> <li>■ Reference density</li> </ul> | Enter upper limit value for deactivating partialy filled pipe detection.               | Signed floating-point number  | 6 000           |
| Response time part. filled pipe detect.  | One of the following options is selected in the <b>Assign process variable</b> parameter: <ul style="list-style-type: none"> <li>■ Density</li> <li>■ Reference density</li> </ul> | Enter time before diagnostic message is displayed for partially filled pipe detection. | 0 to 100 s  | 1 s             |

## 10.5 Advanced settings

The **Advanced setup** submenu together with its submenus contains parameters for specific settings.

*Navigation to the "Advanced setup" submenu*

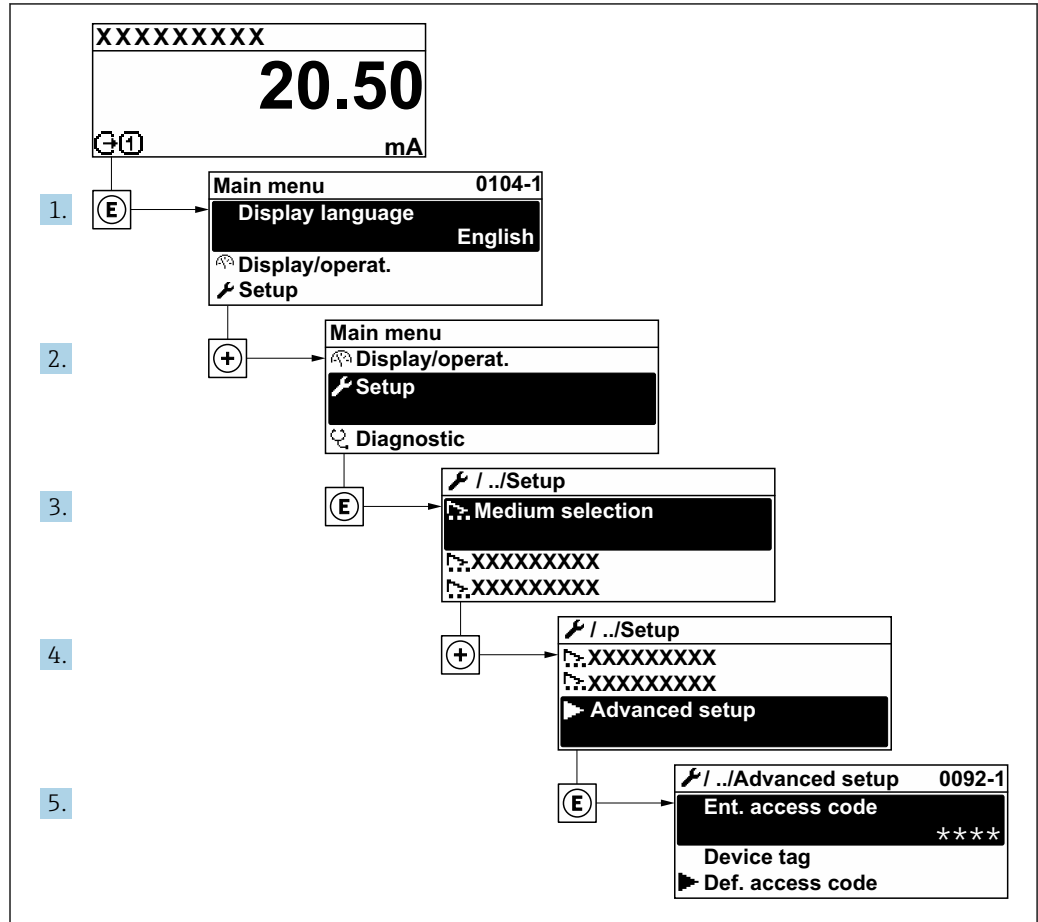

A0032223-EN

### Navigation

"Setup" menu → Advanced setup

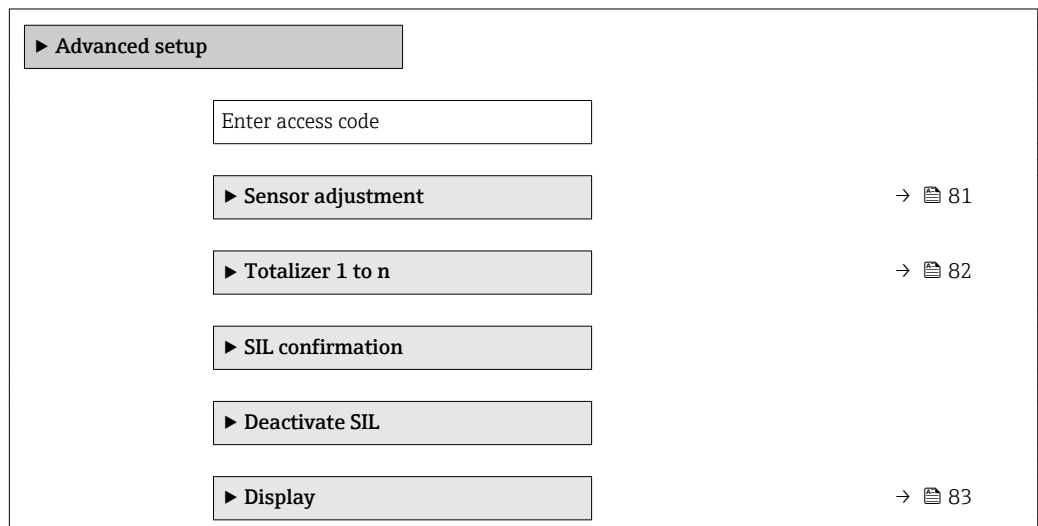



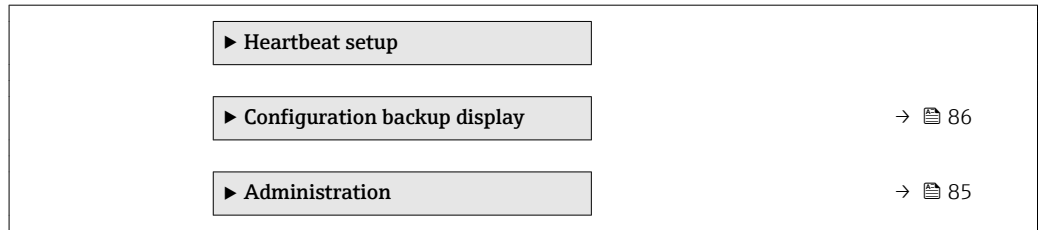

### 10.5.1 Carrying out a sensor adjustment

The **Sensor adjustment** submenu contains parameters that pertain to the functionality of the sensor.

#### Navigation

"Setup" menu → Advanced setup → Sensor adjustment

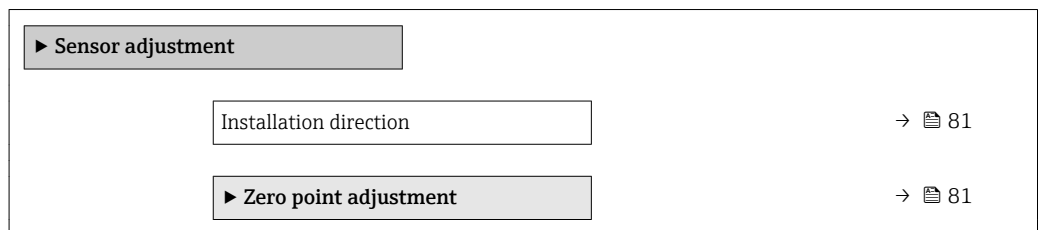

#### Parameter overview with brief description

| Parameter              | Description   | Selection   | Factory setting         |
|------------------------|---|---|-------------------------|
| Installation direction | Set sign of flow direction to match the direction of the arrow on the sensor. | <ul style="list-style-type: none"> <li>▪ Flow in arrow direction</li> <li>▪ Flow against arrow direction</li> </ul> | Flow in arrow direction |

#### Zero point adjustment

All measuring devices are calibrated in accordance with state-of-the-art technology. Calibration takes place under reference conditions → 133. Therefore, a zero point adjustment in the field is generally not required.

Experience shows that zero point adjustment is advisable only in special cases:

- To achieve maximum measuring accuracy even with low flow rates.
- Under extreme process or operating conditions (e.g. very high process temperatures or very high-viscosity fluids).

#### Navigation

"Setup" menu → Advanced setup → Sensor adjustment → Zero point adjustment

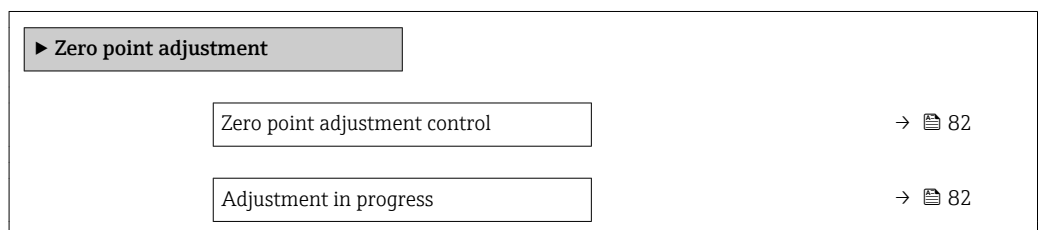

### Parameter overview with brief description

| Parameter                     | Prerequisite   | Description                  | Selection / User interface   | Factory setting |
|-------------------------------|--|------------------------------|--|-----------------|
| Zero point adjustment control | –  | Start zero point adjustment. | <ul style="list-style-type: none"> <li>▪ Cancel</li> <li>▪ Busy</li> <li>▪ Zero point adjust failure</li> <li>▪ Start</li> </ul> | Cancel          |
| Adjustment in progress        | The <b>Start</b> option is selected in the <b>Zero point adjustment control</b> parameter. |                              | 0 to 100 %   | –               |

## 10.5.2 Configuring the totalizer

In the "**Totalizer 1 to n**" submenu the individual totalizer can be configured.

### Navigation

"Setup" menu → Advanced setup → Totalizer 1 to n

|                           |      |
|---------------------------|------|
| ▶ <b>Totalizer 1 to n</b> |      |
| Assign process variable   | → 82 |
| Unit totalizer            | → 82 |
| Totalizer operation mode  | → 82 |
| Failure mode              | → 82 |

### Parameter overview with brief description

| Parameter                | Prerequisite  | Description                                   | Selection  | Factory setting   |
|--------------------------|---|---|--|---|
| Assign process variable  | –   | Select process variable for totalizer.        | <ul style="list-style-type: none"> <li>▪ Off</li> <li>▪ Volume flow</li> <li>▪ Mass flow</li> <li>▪ Corrected volume flow</li> </ul> | Mass flow   |
| Unit totalizer           | A process variable is selected in the <b>Assign process variable</b> parameter (→ 82) of the <b>Totalizer 1 to n</b> submenu. | Select process variable totalizer unit.       | Unit choose list   | Country-specific: <ul style="list-style-type: none"> <li>▪ l</li> <li>▪ gal (us)</li> </ul> |
| Totalizer operation mode | A process variable is selected in the <b>Assign process variable</b> parameter (→ 82) of the <b>Totalizer 1 to n</b> submenu. | Select totalizer calculation mode.            | <ul style="list-style-type: none"> <li>▪ Net flow total</li> <li>▪ Forward flow total</li> <li>▪ Reverse flow total</li> </ul>       | Net flow total  |
| Failure mode             | A process variable is selected in the <b>Assign process variable</b> parameter (→ 82) of the <b>Totalizer 1 to n</b> submenu. | Define totalizer behavior in alarm condition. | <ul style="list-style-type: none"> <li>▪ Stop</li> <li>▪ Actual value</li> <li>▪ Last valid value</li> </ul>                         | Stop  |

### 10.5.3 Carrying out additional display configurations

In the **Display** submenu you can set all the parameters associated with the configuration of the local display.

#### Navigation

"Setup" menu → Advanced setup → Display

| ► Display             |      |
|-----------------------|------|
| Format display        | → 84 |
| Value 1 display       | → 84 |
| 0% bargraph value 1   | → 84 |
| 100% bargraph value 1 | → 84 |
| Decimal places 1      | → 84 |
| Value 2 display       | → 84 |
| Decimal places 2      | → 84 |
| Value 3 display       | → 84 |
| 0% bargraph value 3   | → 84 |
| 100% bargraph value 3 | → 84 |
| Decimal places 3      | → 84 |
| Value 4 display       | → 84 |
| Decimal places 4      | → 85 |
| Language              | → 85 |
| Display interval      | → 85 |
| Display damping       | → 85 |
| Header                | → 85 |
| Header text           | → 85 |
| Separator             | → 85 |
| Backlight             | → 85 |

## Parameter overview with brief description

| Parameter             | Prerequisite   | Description   | Selection / User entry  | Factory setting  |
|-----------------------|--|---|---|--|
| Format display        | A local display is provided.   | Select how measured values are shown on the display.          | <ul style="list-style-type: none"> <li>▪ 1 value, max. size</li> <li>▪ 1 bargraph + 1 value</li> <li>▪ 2 values</li> <li>▪ 1 value large + 2 values</li> <li>▪ 4 values</li> </ul>  | 1 value, max. size   |
| Value 1 display       | A local display is provided.   | Select the measured value that is shown on the local display. | <ul style="list-style-type: none"> <li>▪ None</li> <li>▪ Mass flow</li> <li>▪ Volume flow</li> <li>▪ Corrected volume flow</li> <li>▪ Density</li> <li>▪ Reference density</li> <li>▪ Temperature</li> <li>▪ Totalizer 1</li> <li>▪ Totalizer 2</li> <li>▪ Totalizer 3</li> <li>▪ Current output 1</li> <li>▪ Current output 2 *</li> </ul> | Mass flow  |
| 0% bargraph value 1   | A local display is provided.   | Enter 0% value for bar graph display.                         | Signed floating-point number  | Country-specific: <ul style="list-style-type: none"> <li>▪ 0 kg/h</li> <li>▪ 0 lb/min</li> </ul> |
| 100% bargraph value 1 | A local display is provided.   | Enter 100% value for bar graph display.                       | Signed floating-point number  | Depends on country and nominal diameter  |
| Decimal places 1      | A measured value is specified in the <b>Value 1 display</b> parameter. | Select the number of decimal places for the display value.    | <ul style="list-style-type: none"> <li>▪ x</li> <li>▪ x.x</li> <li>▪ x.xx</li> <li>▪ x.xxx</li> <li>▪ x.xxxx</li> </ul>   | x.xx   |
| Value 2 display       | A local display is provided.   | Select the measured value that is shown on the local display. | For the picklist, see the <b>Value 1 display</b> parameter  | None   |
| Decimal places 2      | A measured value is specified in the <b>Value 2 display</b> parameter. | Select the number of decimal places for the display value.    | <ul style="list-style-type: none"> <li>▪ x</li> <li>▪ x.x</li> <li>▪ x.xx</li> <li>▪ x.xxx</li> <li>▪ x.xxxx</li> </ul>   | x.xx   |
| Value 3 display       | A local display is provided.   | Select the measured value that is shown on the local display. | For the picklist, see the <b>Value 1 display</b> parameter (→ 75)   | None   |
| 0% bargraph value 3   | A selection was made in the <b>Value 3 display</b> parameter.          | Enter 0% value for bar graph display.                         | Signed floating-point number  | Country-specific: <ul style="list-style-type: none"> <li>▪ 0 kg/h</li> <li>▪ 0 lb/min</li> </ul> |
| 100% bargraph value 3 | A selection was made in the <b>Value 3 display</b> parameter.          | Enter 100% value for bar graph display.                       | Signed floating-point number  | 0  |
| Decimal places 3      | A measured value is specified in the <b>Value 3 display</b> parameter. | Select the number of decimal places for the display value.    | <ul style="list-style-type: none"> <li>▪ x</li> <li>▪ x.x</li> <li>▪ x.xx</li> <li>▪ x.xxx</li> <li>▪ x.xxxx</li> </ul>   | x.xx   |
| Value 4 display       | A local display is provided.   | Select the measured value that is shown on the local display. | For the picklist, see the <b>Value 1 display</b> parameter (→ 75)   | None   |

| Parameter        | Prerequisite   | Description   | Selection / User entry   | Factory setting  |
|------------------|--|---|--|--|
| Decimal places 4 | A measured value is specified in the <b>Value 4 display</b> parameter.   | Select the number of decimal places for the display value.                          | <ul style="list-style-type: none"> <li>■ x</li> <li>■ x.x</li> <li>■ x.xx</li> <li>■ x.xxx</li> <li>■ x.xxxx</li> </ul>  | x.xx   |
| Language         | A local display is provided.   | Set display language.   | <ul style="list-style-type: none"> <li>■ English</li> <li>■ Deutsch *</li> <li>■ Français *</li> <li>■ Español *</li> <li>■ Italiano *</li> <li>■ Nederlands *</li> <li>■ Portuguesa *</li> <li>■ Polski *</li> <li>■ русский язык (Russian) *</li> <li>■ Svenska *</li> <li>■ Türkçe *</li> <li>■ 中文 (Chinese) *</li> <li>■ 日本語 (Japanese) *</li> <li>■ 한국어 (Korean) *</li> <li>■ Bahasa Indonesia *</li> <li>■ tiếng Việt (Vietnamese) *</li> <li>■ čeština (Czech) *</li> </ul> | English<br>(alternatively, the ordered language is preset in the device) |
| Display interval | A local display is provided.   | Set time measured values are shown on display if display alternates between values. | 1 to 10 s  | 5 s  |
| Display damping  | A local display is provided.   | Set display reaction time to fluctuations in the measured value.                    | 0.0 to 999.9 s   | 0.0 s  |
| Header           | A local display is provided.   | Select header contents on local display.  | <ul style="list-style-type: none"> <li>■ Device tag</li> <li>■ Free text</li> </ul>  | Device tag   |
| Header text      | In the <b>Header</b> parameter, the <b>Free text</b> option is selected.   | Enter display header text.  | Max. 12 characters such as letters, numbers or special characters (e.g. @, %, /)   | -----  |
| Separator        | A local display is provided.   | Select decimal separator for displaying numerical values.                           | <ul style="list-style-type: none"> <li>■ . (point)</li> <li>■ , (comma)</li> </ul>   | . (point)  |
| Backlight        | Order code for "Display; operation", option <b>E</b> "SD03 4-line, illum.; touch control + data backup function" | Switch the local display backlight on and off.                                      | <ul style="list-style-type: none"> <li>■ Disable</li> <li>■ Enable</li> </ul>  | Disable  |

\* Visibility depends on order options or device settings

#### 10.5.4 Using parameters for device administration

The **Administration** submenu systematically guides the user through all the parameters that can be used for device administration purposes.

**Navigation**

"Setup" menu → Advanced setup → Administration

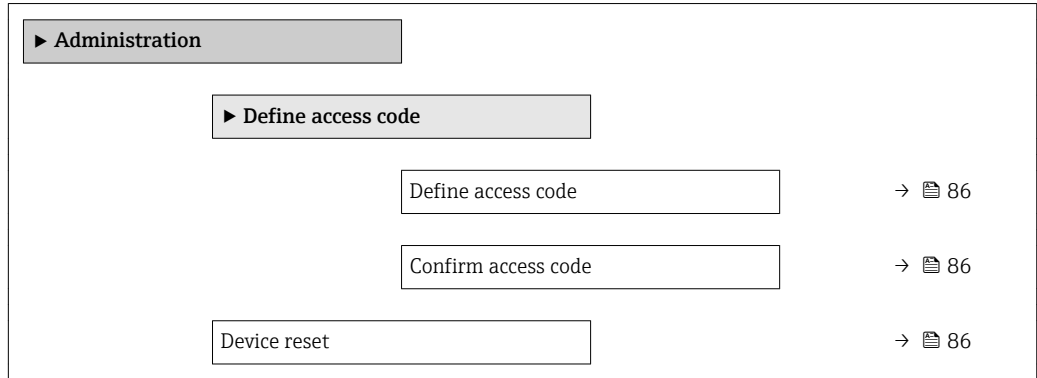

**Parameter overview with brief description**

| Parameter           | Description   | User entry / Selection  | Factory setting |
|---------------------|---|---|-----------------|
| Define access code  | Restrict write-access to parameters to protect the configuration of the device against unintentional changes via the local display. | 0 to 9 999  | 0               |
| Confirm access code | Confirm the entered access code.  | 0 to 9 999  | 0               |
| Device reset        | Reset the device configuration - either entirely or in part - to a defined state.   | <ul style="list-style-type: none"> <li>▪ Cancel</li> <li>▪ To factory defaults</li> <li>▪ To delivery settings</li> <li>▪ Restart device</li> </ul> | Cancel          |

**10.6 Configuration management**

After commissioning, you can save the current device configuration, copy it to another measuring point or restore the previous device configuration.

You can do so using the **Configuration management** parameter and the related options found in the **Configuration backup display** submenu.

**Navigation**

"Setup" menu → Advanced setup → Configuration backup display

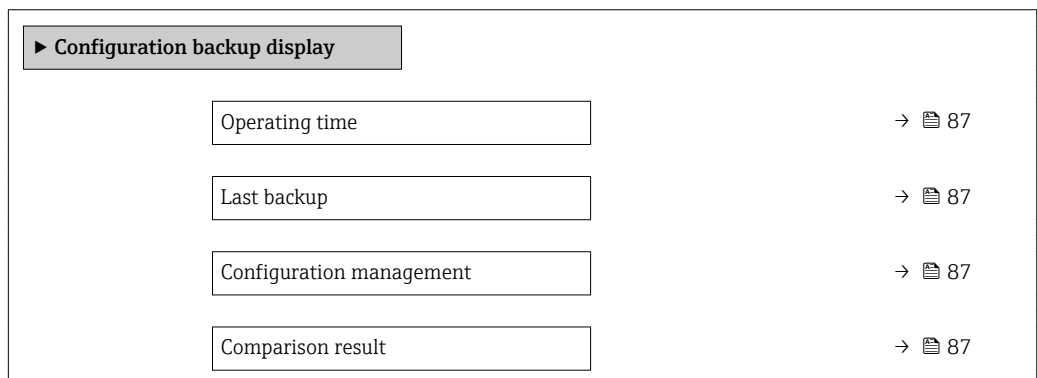

### Parameter overview with brief description

| Parameter                | Prerequisite                 | Description  | User interface / Selection   | Factory setting |
|--------------------------|------------------------------|--|--|-----------------|
| Operating time           | –                            | Indicates how long the device has been in operation.                 | Days (d), hours (h), minutes (m) and seconds (s)   | –               |
| Last backup              | A local display is provided. | Indicates when the last data backup was saved to the display module. | Days (d), hours (h), minutes (m) and seconds (s)   | –               |
| Configuration management | A local display is provided. | Select action for managing the device data in the display module.    | <ul style="list-style-type: none"> <li>■ Cancel</li> <li>■ Execute backup</li> <li>■ Restore</li> <li>■ Duplicate</li> <li>■ Compare</li> <li>■ Clear backup data</li> </ul>   | Cancel          |
| Comparison result        | A local display is provided. | Comparison between present device data and display backup.           | <ul style="list-style-type: none"> <li>■ Settings identical</li> <li>■ Settings not identical</li> <li>■ No backup available</li> <li>■ Backup settings corrupt</li> <li>■ Check not done</li> <li>■ Dataset incompatible</li> </ul> | Check not done  |

#### 10.6.1 Function scope of the "Configuration management" parameter

| Options           | Description   |
|-------------------|---|
| Cancel            | No action is executed and the user exits the parameter.   |
| Execute backup    | A backup copy of the current device configuration is saved from the HistoROM backup to the display module of the device. The backup copy includes the transmitter data of the device. |
| Restore           | The last backup copy of the device configuration is restored from the display module to the device's HistoROM backup. The backup copy includes the transmitter data of the device.    |
| Compare           | The device configuration saved in the display module is compared with the current device configuration of the HistoROM backup.  |
| Duplicate         | The transmitter configuration from another device is duplicated to the device using the display module.   |
| Clear backup data | The backup copy of the device configuration is deleted from the display module of the device.   |



#### *HistoROM backup*

A HistoROM is a "non-volatile" device memory in the form of an EEPROM.



While this action is in progress, the configuration cannot be edited via the local display and a message on the processing status appears on the display.

## 10.7 Simulation

The **Simulation** submenu enables you to simulate, without a real flow situation, various process variables in the process and the device alarm mode and to verify downstream signal chains (switching valves or closed-control loops).

**Navigation**

"Diagnostics" menu → Simulation

| Simulation                         |   |      |
|------------------------------------|---|------|
| Assign simulation process variable | → | ☰ 88 |
| Process variable value             | → | ☰ 88 |
| Simulation current output 1 to n   | → | ☰ 88 |
| Value current output 1 to n        | → | ☰ 88 |
| Frequency output simulation        | → | ☰ 89 |
| Frequency value                    | → | ☰ 89 |
| Pulse output simulation            | → | ☰ 89 |
| Pulse value                        | → | ☰ 89 |
| Switch output simulation           | → | ☰ 89 |
| Switch status                      | → | ☰ 89 |
| Simulation device alarm            | → | ☰ 89 |
| Diagnostic event category          | → | ☰ 89 |
| Diagnostic event simulation        | → | ☰ 89 |

**Parameter overview with brief description**

| Parameter                          | Prerequisite  | Description   | Selection / User entry  | Factory setting |
|------------------------------------|---|---|---|-----------------|
| Assign simulation process variable | –   | Select a process variable for the simulation process that is activated. | <ul style="list-style-type: none"> <li>▪ Off</li> <li>▪ Mass flow</li> <li>▪ Volume flow</li> <li>▪ Corrected volume flow</li> <li>▪ Density</li> <li>▪ Reference density</li> <li>▪ Temperature</li> </ul> | Off             |
| Process variable value             | A process variable is selected in the <b>Assign simulation process variable</b> parameter (→ ☰ 88). | Enter the simulation value for the selected process variable.           | Depends on the process variable selected  | 0               |
| Simulation current output 1 to n   | –   | Switch the simulation of the current output on and off.                 | <ul style="list-style-type: none"> <li>▪ Off</li> <li>▪ On</li> </ul>   | Off             |
| Value current output 1 to n        | In the <b>Simulation current output 1 to n</b> parameter, the <b>On</b> option is selected.         | Enter the current value for simulation.                                 | 3.59 to 22.5 mA   | 3.59 mA         |



| Parameter                   | Prerequisite   | Description   | Selection / User entry  | Factory setting |
|-----------------------------|--|---|---|-----------------|
| Frequency output simulation | In the <b>Operating mode</b> parameter, the <b>Frequency</b> option is selected.   | Switch the simulation of the frequency output on and off.   | <ul style="list-style-type: none"> <li>▪ Off</li> <li>▪ On</li> </ul>   | Off             |
| Frequency value             | In the <b>Frequency output simulation</b> parameter, the <b>On</b> option is selected.   | Enter the frequency value for the simulation.   | 0.0 to 1 250.0 Hz   | 0.0 Hz          |
| Pulse output simulation     | In the <b>Operating mode</b> parameter, the <b>Pulse</b> option is selected.   | Set and switch off the pulse output simulation.<br> For <b>Fixed value</b> option: <b>Pulse width</b> parameter (→ 69) defines the pulse width of the pulses output. | <ul style="list-style-type: none"> <li>▪ Off</li> <li>▪ Fixed value</li> <li>▪ Down-counting value</li> </ul>                   | Off             |
| Pulse value                 | In the <b>Pulse output simulation</b> parameter (→ 89), the <b>Down-counting value</b> option is selected.   | Enter the number of pulses for simulation.  | 0 to 65 535   | 0               |
| Switch output simulation    | In the <b>Operating mode</b> parameter, the <b>Switch</b> option is selected.  | Switch the simulation of the switch output on and off.  | <ul style="list-style-type: none"> <li>▪ Off</li> <li>▪ On</li> </ul>   | Off             |
| Switch status               | In the <b>Switch output simulation</b> parameter (→ 89) <b>Switch output simulation 1 to n</b> parameter <b>Switch output simulation 1 to n</b> parameter, the <b>On</b> option is selected. | Select the status of the status output for the simulation.  | <ul style="list-style-type: none"> <li>▪ Open</li> <li>▪ Closed</li> </ul>  | Open            |
| Simulation device alarm     | –  | Switch the device alarm on and off.   | <ul style="list-style-type: none"> <li>▪ Off</li> <li>▪ On</li> </ul>   | Off             |
| Diagnostic event category   | –  | Select a diagnostic event category.   | <ul style="list-style-type: none"> <li>▪ Sensor</li> <li>▪ Electronics</li> <li>▪ Configuration</li> <li>▪ Process</li> </ul>   | Process         |
| Diagnostic event simulation | –  | Select a diagnostic event to simulate this event.   | <ul style="list-style-type: none"> <li>▪ Off</li> <li>▪ Diagnostic event picklist (depends on the category selected)</li> </ul> | Off             |

## 10.8 Protecting settings from unauthorized access

The following options exist for protecting the configuration of the measuring device from unintentional modification after commissioning:

- Write protection via access code
- Write protection via write protection switch
- Write protection via keypad lock

### 10.8.1 Write protection via access code



The effects of the user-specific access code are as follows:

- Via local operation, the parameters for the measuring device configuration are write-protected and their values can no longer be changed.
- Device access is protected via the Web browser, as are the parameters for the measuring device configuration.

### Defining the access code via local display

1. Navigate to the **Enter access code** parameter.
2. Define a max. 16-digit character string comprising numbers, letters and special characters as the access code.
3. Enter the access code again in the to confirm the code.
  - ↳ The -symbol appears in front of all write-protected parameters.

The device automatically locks the write-protected parameters again if a key is not pressed for 10 minutes in the navigation and editing view. The device locks the write-protected parameters automatically after 60 s if the user skips back to the operational display mode from the navigation and editing view.

-  If parameter write protection is activated via an access code, it can also only be deactivated via this access code →  50.
- The user role with which the user is currently logged on via the local display is indicated by the →  50 **Access status display** parameter. Navigation path: Operation → Access status display

### Parameters which can always be modified via the local display

Certain parameters that do not affect the measurement are excepted from parameter write protection via the local display. Despite the user-specific access code, they can always be modified, even if the other parameters are locked.

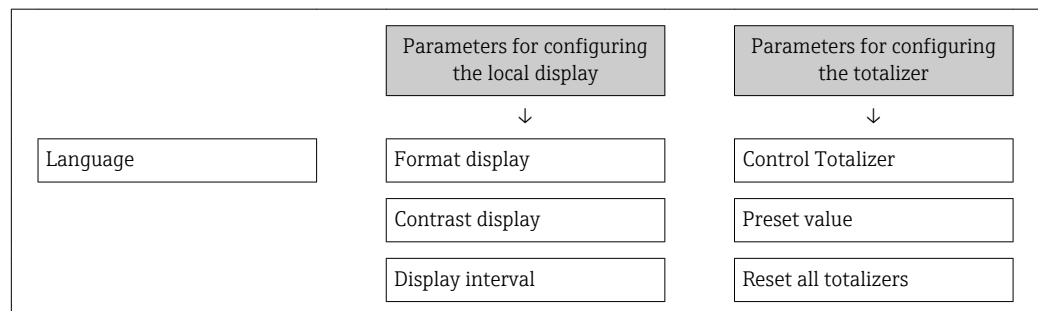

### 10.8.2 Write protection via write protection switch

Unlike parameter write protection via a user-specific access code, this allows write access to the entire operating menu - except for the **"Contrast display" parameter** - to be locked.

The parameter values are now read only and cannot be edited any more (exception **"Contrast display" parameter**):

- Via local display
- Via service interface (CDI)
- Via HART protocol

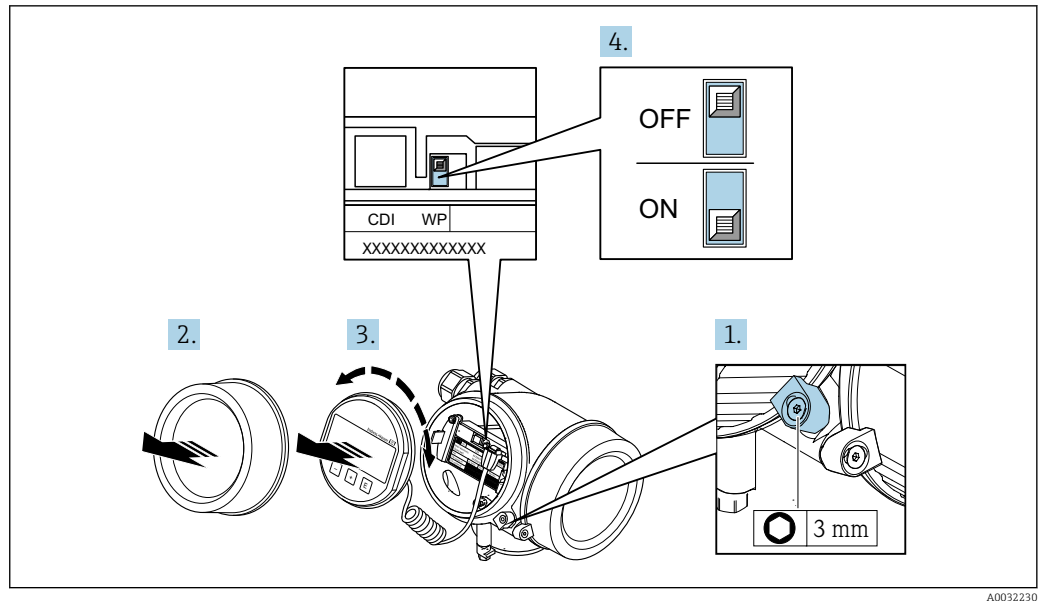

A0032230

1. Loosen the securing clamp.
2. Unscrew the electronics compartment cover.
3. Pull out the display module with a gentle rotational movement. To make it easier to access the write protection switch, attach the display module to the edge of the electronics compartment.
  - ↳ Display module is attached to the edge of the electronics compartment.

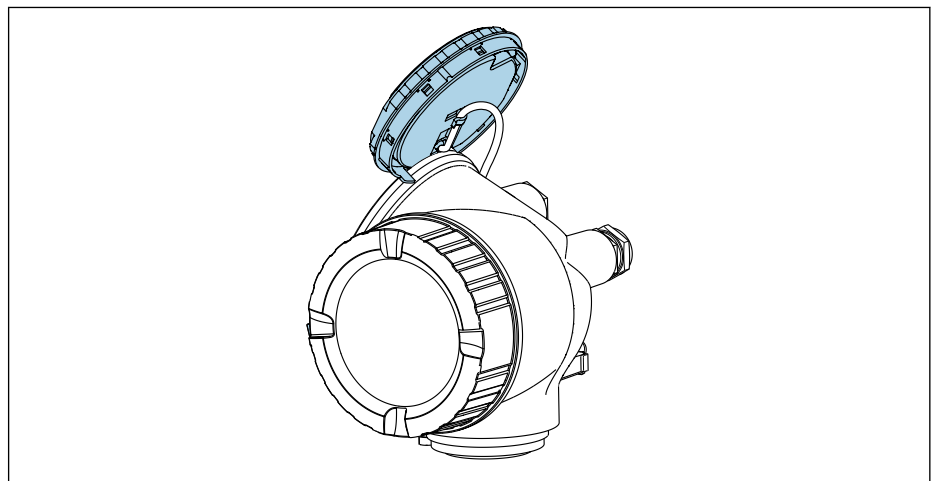

A0032236

4. Setting the write protection switch (WP) on the main electronics module to the **ON** position enables hardware write protection. Setting the write protection switch (WP) on the main electronics module to the **OFF** position (factory setting) disables hardware write protection.
  - ↳ If the hardware write protection is enabled: The **Hardware locked** option is displayed in the **Locking status** parameter . In addition, on the local display the -symbol appears in front of the parameters in the header of the operational display and in the navigation view.

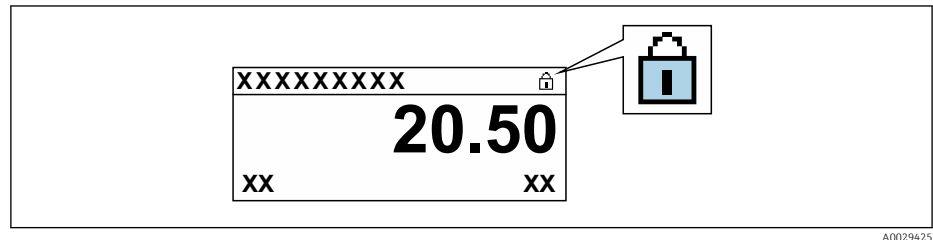

If the hardware write protection is disabled: No option is displayed in the **Locking status** parameter . On the local display, the -symbol disappears from in front of the parameters in the header of the operational display and in the navigation view.

5. Feed the cable into the gap between the housing and main electronics module and plug the display module into the electronics compartment in the desired direction until it engages.
6. Reverse the removal procedure to reassemble the transmitter.

## 11 Operation

### 11.1 Reading the device locking status

Device active write protection: **Locking status** parameter



Operation → Locking status

*Function scope of the "Locking status" parameter*

| Options            | Description   |
|--------------------|---|
| None               | The access status displayed in the <b>Access status display</b> parameter applies →  50. Only appears on local display.  |
| Hardware locked    | The DIP switch for hardware locking is activated on the main electronics module. This locks write access to the parameters (e.g. via local display or operating tool) .   |
| SIL locked         | The SIL mode is enabled. This locks write access to the parameters (e.g. via local display or operating tool).  |
| Temporarily locked | Write access to the parameters is temporarily locked on account of internal processes running in the device (e.g. data upload/download, reset etc.). Once the internal processing has been completed, the parameters can be changed once again. |



### 11.2 Adjusting the operating language

 Detailed information:

- To configure the operating language →  61
- For information on the operating languages supported by the measuring device →  143

### 11.3 Configuring the display

Detailed information:

- On the basic settings for the local display →  74
- On the advanced settings for the local display →  83

### 11.4 Reading measured values

With the **Measured values** submenu, it is possible to read all the measured values.

#### Navigation

"Diagnostics" menu → Measured values

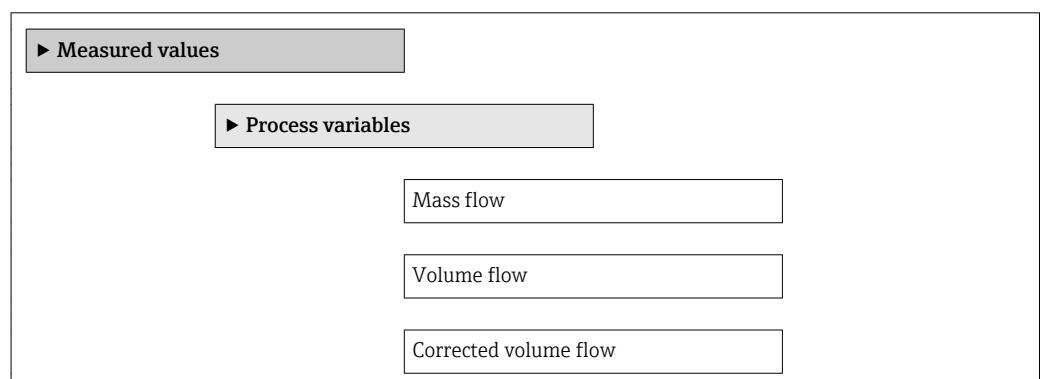

|                           |
|---------------------------|
| Density                   |
| Reference density         |
| Temperature               |
| ► Totalizer               |
| Totalizer value 1 to n    |
| Totalizer overflow 1 to n |
| ► Input values            |
| Measured current 1        |
| Measured values 1         |
| ► Output values           |
| Output current 1          |
| Measured current 1        |
| Terminal voltage 1        |
| Output current 2          |
| Pulse output              |
| Output frequency          |
| Switch status             |

### 11.4.1 Process variables

The **Process variables** submenu contains all the parameters needed to display the current measured values for each process variable.

#### Navigation

"Diagnostics" menu → Measured values → Process variables

|                       |        |
|-----------------------|--------|
| ► Process variables   |        |
| Mass flow             | → ⓘ 95 |
| Volume flow           | → ⓘ 95 |
| Corrected volume flow | → ⓘ 95 |

|                   |      |
|-------------------|------|
| Density           | → 95 |
| Reference density | → 95 |
| Temperature       | → 95 |

### Parameter overview with brief description

| Parameter             | Description   | User interface                 |
|-----------------------|---|--------------------------------|
| Mass flow             | Displays the mass flow currently measured.<br><i>Dependency</i><br>The unit is taken from the <b>Mass flow unit</b> parameter                           | Signed floating-point number   |
| Volume flow           | Displays the volume flow currently measured.<br><i>Dependency</i><br>The unit is taken from the <b>Volume flow unit</b> parameter                       | Signed floating-point number   |
| Corrected volume flow | Displays the corrected volume flow currently calculated.<br><i>Dependency</i><br>The unit is taken from the <b>Corrected volume flow unit</b> parameter | Signed floating-point number   |
| Density               | Displays the density or specific density currently measured.<br><i>Dependency</i><br>The unit is taken from the <b>Density unit</b> parameter           | Positive floating-point number |
| Reference density     | Displays the density at the reference temperature.<br><i>Dependency</i><br>The unit is taken from the <b>Reference density unit</b> parameter           | Positive floating-point number |
| Temperature           | Displays the temperature currently measured.<br><i>Dependency</i><br>The unit is taken from the <b>Temperature unit</b> parameter                       | Positive floating-point number |

### 11.4.2 "Totalizer" submenu

The **Totalizer** submenu contains all the parameters needed to display the current measured values for every totalizer.

#### Navigation

"Diagnostics" menu → Measured values → Totalizer

|                           |      |
|---------------------------|------|
| ▶ Totalizer               |      |
| Totalizer value 1 to n    | → 96 |
| Totalizer overflow 1 to n | → 96 |

**Parameter overview with brief description**

| Parameter                 | Prerequisite  | Description                                   | User interface               |
|---------------------------|---|---|------------------------------|
| Totalizer value 1 to n    | One of the following options is selected in the <b>Assign process variable</b> parameter (→ 82) of the <b>Totalizer 1 to n</b> submenu: <ul style="list-style-type: none"> <li>■ Volume flow</li> <li>■ Mass flow</li> <li>■ Corrected volume flow</li> </ul> | Displays the current totalizer counter value. | Signed floating-point number |
| Totalizer overflow 1 to n | One of the following options is selected in the <b>Assign process variable</b> parameter (→ 82) of the <b>Totalizer 1 to n</b> submenu: <ul style="list-style-type: none"> <li>■ Volume flow</li> <li>■ Mass flow</li> <li>■ Corrected volume flow</li> </ul> | Displays the current totalizer overflow.      | Integer with sign            |

**11.4.3 Output values**

The **Output values** submenu contains all the parameters needed to display the current measured values for every output.

**Navigation**

"Diagnostics" menu → Measured values → Output values

▶ **Output values**

- Output current 1
- Measured current 1 → 96
- Terminal voltage 1 → 96
- Output current 2
- Pulse output → 97
- Output frequency → 97
- Switch status → 97

**Parameter overview with brief description**

| Parameter          | Prerequisite | Description   | User interface  |
|--------------------|--------------|---|-----------------|
| Output current 1   | -            | Displays the current value currently calculated for the current output. | 3.59 to 22.5 mA |
| Measured current 1 | -            | Displays the current value currently measured for the current output.   | 0 to 30 mA      |
| Terminal voltage 1 | -            | Displays the current terminal voltage that is applied at the output.    | 0.0 to 50.0 V   |
| Output current 2   | -            | Displays the current value currently calculated for the current output. | 3.59 to 22.5 mA |



| Parameter        | Prerequisite  | Description   | User interface   |
|------------------|---|---|--|
| Pulse output     | The <b>Pulse</b> option is selected in the <b>Operating mode</b> parameter parameter. | Displays the pulse frequency currently output.                  | Positive floating-point number   |
| Output frequency | In the <b>Operating mode</b> parameter, the <b>Frequency</b> option is selected.      | Displays the value currently measured for the frequency output. | 0 to 1250 Hz   |
| Switch status    | The <b>Switch</b> option is selected in the <b>Operating mode</b> parameter.          | Displays the current switch output status.                      | <ul style="list-style-type: none"> <li>■ Open</li> <li>■ Closed</li> </ul> |

## 11.5 Adapting the measuring device to the process conditions

The following are available for this purpose:

- Basic settings using the **Setup** menu (→ 61)
- Advanced settings using the **Advanced setup** submenu (→ 80)

## 11.6 Performing a totalizer reset

The totalizers are reset in the **Operation** submenu:

- Control Totalizer
- Reset all totalizers

### Navigation

"Operation" menu → Totalizer handling

|                          |      |
|--------------------------|------|
| ▶ Totalizer handling     |      |
| Control Totalizer 1 to n | → 97 |
| Preset value 1 to n      | → 97 |
| Reset all totalizers     | → 97 |

### Parameter overview with brief description

| Parameter                | Prerequisite  | Description  | Selection / User entry   | Factory setting   |
|--------------------------|---|--|--|---|
| Control Totalizer 1 to n | A process variable is selected in the <b>Assign process variable</b> parameter (→ 82) of the <b>Totalizer 1 to n</b> submenu. | Control totalizer value.   | <ul style="list-style-type: none"> <li>■ Totalize</li> <li>■ Reset + hold</li> <li>■ Preset + hold</li> <li>■ Reset + totalize</li> <li>■ Preset + totalize</li> <li>■ Hold</li> </ul> | Totalize  |
| Preset value 1 to n      | A process variable is selected in the <b>Assign process variable</b> parameter (→ 82) of the <b>Totalizer 1 to n</b> submenu. | Specify start value for totalizer.<br><i>Dependency</i><br> The unit of the selected process variable is specified for the totalizer in the <b>Unit totalizer</b> parameter (→ 82). | Signed floating-point number   | Country-specific: <ul style="list-style-type: none"> <li>■ 0 l</li> <li>■ 0 gal (us)</li> </ul> |
| Reset all totalizers     | –   | Reset all totalizers to 0 and start.   | <ul style="list-style-type: none"> <li>■ Cancel</li> <li>■ Reset + totalize</li> </ul>   | Cancel  |

### 11.6.1 Function scope of the "Control Totalizer" parameter



| Options           | Description   |
|-------------------|---|
| Totalize          | The totalizer is started or continues running.  |
| Reset + hold      | The totaling process is stopped and the totalizer is reset to 0.  |
| Preset + hold     | The totaling process is stopped and the totalizer is set to its defined start value from the <b>Preset value</b> parameter.   |
| Reset + totalize  | The totalizer is reset to 0 and the totaling process is restarted.  |
| Preset + totalize | The totalizer is set to the defined start value from the <b>Preset value</b> parameter and the totaling process is restarted. |
| Hold              | Totalizing is stopped.  |

### 11.6.2 Function scope of the "Reset all totalizers" parameter

| Options          | Description  |
|------------------|--|
| Cancel           | No action is executed and the user exits the parameter.  |
| Reset + totalize | Resets all totalizers to 0 and restarts the totaling process. This deletes all the flow values previously totalized. |

## 11.7 Showing data logging

The **Extended HistoROM** application package must be enabled in the device (order option) for the **Data logging** submenu to appear. This contains all the parameters for the measured value history.

 Data logging is also available via:  
Plant Asset Management Tool FieldCare →  53.

#### Function range

- A total of 1000 measured values can be stored
- 4 logging channels
- Adjustable logging interval for data logging
- Display of the measured value trend for each logging channel in the form of a chart

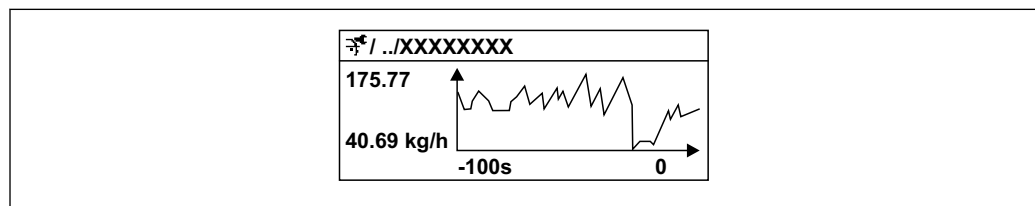

A0016357

 16 Chart of a measured value trend

- x-axis: depending on the number of channels selected displays 250 to 1000 measured values of a process variable.
- y-axis: displays the approximate measured value span and constantly adapts this to the ongoing measurement.

 If the length of the logging interval or the assignment of the process variables to the channels is changed, the content of the data logging is deleted.

**Navigation**  
 "Diagnostics" menu → Data logging

▶ **Data logging**

Assign channel 1 → 99

Assign channel 2 → 99

Assign channel 3 → 100

Assign channel 4 → 100

Logging interval → 100

Clear logging data → 100

▶ **Display channel 1**





▶ **Display channel 2**

▶ **Display channel 3**

▶ **Display channel 4**

**Parameter overview with brief description**

| Parameter        | Prerequisite   | Description                                 | Selection / User entry   | Factory setting |
|------------------|--|---|--|-----------------|
| Assign channel 1 | The <b>Extended HistoROM</b> application package is available.   | Assign process variable to logging channel. | <ul style="list-style-type: none"> <li>▪ Off</li> <li>▪ Mass flow</li> <li>▪ Volume flow</li> <li>▪ Corrected volume flow</li> <li>▪ Density</li> <li>▪ Reference density</li> <li>▪ Temperature</li> <li>▪ Electronic temperature</li> <li>▪ Oscillation frequency</li> <li>▪ Oscillation amplitude</li> <li>▪ Oscillation damping</li> <li>▪ Signal asymmetry</li> <li>▪ Current output 1</li> </ul> | Off             |
| Assign channel 2 | The <b>Extended HistoROM</b> application package is available.<br>The software options currently enabled are displayed in the <b>Software option overview</b> parameter. | Assign process variable to logging channel. | Picklist, see <b>Assign channel 1</b> parameter (→  99)  | Off             |

| Parameter          | Prerequisite   | Description  | Selection / User entry   | Factory setting |
|--------------------|--|--|--|-----------------|
| Assign channel 3   | The <b>Extended HistoROM</b> application package is available.<br> The software options currently enabled are displayed in the <b>Software option overview</b> parameter. | Assign process variable to logging channel.  | Picklist, see <b>Assign channel 1</b> parameter (→  99) | Off             |
| Assign channel 4   | The <b>Extended HistoROM</b> application package is available.<br> The software options currently enabled are displayed in the <b>Software option overview</b> parameter. | Assign process variable to logging channel.  | Picklist, see <b>Assign channel 1</b> parameter (→  99) | Off             |
| Logging interval   | The <b>Extended HistoROM</b> application package is available.   | Define the logging interval for data logging. This value defines the time interval between the individual data points in the memory. | 1.0 to 3 600.0 s   | 10.0 s          |
| Clear logging data | The <b>Extended HistoROM</b> application package is available.   | Clear the entire logging data.   | <ul style="list-style-type: none"> <li>■ Cancel</li> <li>■ Clear data</li> </ul>   | Cancel          |

## 12 Diagnostics and troubleshooting

### 12.1 General troubleshooting





*For local display*

| Error   | Possible causes  | Solution  |
|---|--|---|
| Local display dark and no output signals                                      | Supply voltage does not match the value indicated on the nameplate.          | Apply the correct supply voltage → 32.  |
| Local display dark and no output signals                                      | The polarity of the supply voltage is wrong.                                 | Correct the polarity.   |
| Local display dark and no output signals                                      | No contact between connecting cables and terminals.                          | Check the connection of the cables and correct if necessary.  |
| Local display dark and no output signals                                      | Terminals are not plugged into the I/O electronics module correctly.         | Check terminals.  |
| Local display dark and no output signals                                      | I/O electronics module is defective.   | Order spare part → 119.   |
| Local display is dark, but signal output is within the valid range            | Display is set too bright or too dark.                                       | <ul style="list-style-type: none"> <li>▪ Set the display brighter by simultaneously pressing <math>\square + \boxplus</math>.</li> <li>▪ Set the display darker by simultaneously pressing <math>\square + \boxminus</math>.</li> </ul>               |
| Local display is dark, but signal output is within the valid range            | The cable of the display module is not plugged in correctly.                 | Insert the plug correctly into the main electronics module and display module.  |
| Local display is dark, but signal output is within the valid range            | Display module is defective.   | Order spare part → 119.   |
| Backlighting of local display is red  | Diagnostic event with "Alarm" diagnostic behavior has occurred.              | Take remedial measures  |
| Text on local display appears in a foreign language and cannot be understood. | Incorrect operating language is configured.                                  | <ol style="list-style-type: none"> <li>1. Press <math>\square + \boxplus</math> for 2 s ("home position").</li> <li>2. Press <math>\boxminus</math>.</li> <li>3. Set the desired language in the <b>Display language</b> parameter (→ 85).</li> </ol> |
| Message on local display: "Communication Error" "Check Electronics"           | Communication between the display module and the electronics is interrupted. | <ul style="list-style-type: none"> <li>▪ Check the cable and the connector between the main electronics module and display module.</li> <li>▪ Order spare part → 119.</li> </ul>  |

*For output signals*

| Error   | Possible causes  | Solution  |
|---|--|---|
| Signal output outside the valid range   | Main electronics module is defective.                              | Order spare part → 119.   |
| Signal output outside the valid current range (< 3.6 mA or > 22 mA)                                     | I/O electronics module is defective.                               | Order spare part → 119.   |
| Device shows correct value on local display, but signal output is incorrect, though in the valid range. | Configuration error  | Check and correct the parameter configuration.  |
| Device measures incorrectly.  | Configuration error or device is operated outside the application. | <ol style="list-style-type: none"> <li>1. Check and correct parameter configuration.</li> <li>2. Observe limit values specified in the "Technical Data".</li> </ol> |

*For access*

| Error                               | Possible causes   | Solution   |
|-------------------------------------|---|--|
| No write access to parameters       | Hardware write protection enabled   | Set the write protection switch on main electronics module to the <b>OFF</b> position →  90.  |
| No write access to parameters       | Current user role has limited access authorization  | 1. Check user role →  50.<br>2. Enter correct customer-specific access code →  50. |
| No connection via HART protocol     | Communication resistor missing or incorrectly installed.  | Install the communication resistor (250 Ω) correctly. Observe the maximum load .   |
| No connection via HART protocol     | Commubox <ul style="list-style-type: none"> <li>▪ Connected incorrectly</li> <li>▪ Configured incorrectly</li> <li>▪ Drivers not installed correctly</li> <li>▪ USB interface on computer configured incorrectly</li> </ul> | Observe the documentation for the Commubox.<br> FXA195 HART: Document "Technical Information" TI00404F  |
| No connection via service interface | Incorrect configuration of USB interface on PC or driver not installed correctly.   | Observe the documentation for the Commubox.<br> FXA291: Document "Technical Information" TI00405C   |

## 12.2 Diagnostic information on local display

### 12.2.1 Diagnostic message

Faults detected by the self-monitoring system of the measuring device are displayed as a diagnostic message in alternation with the operational display.

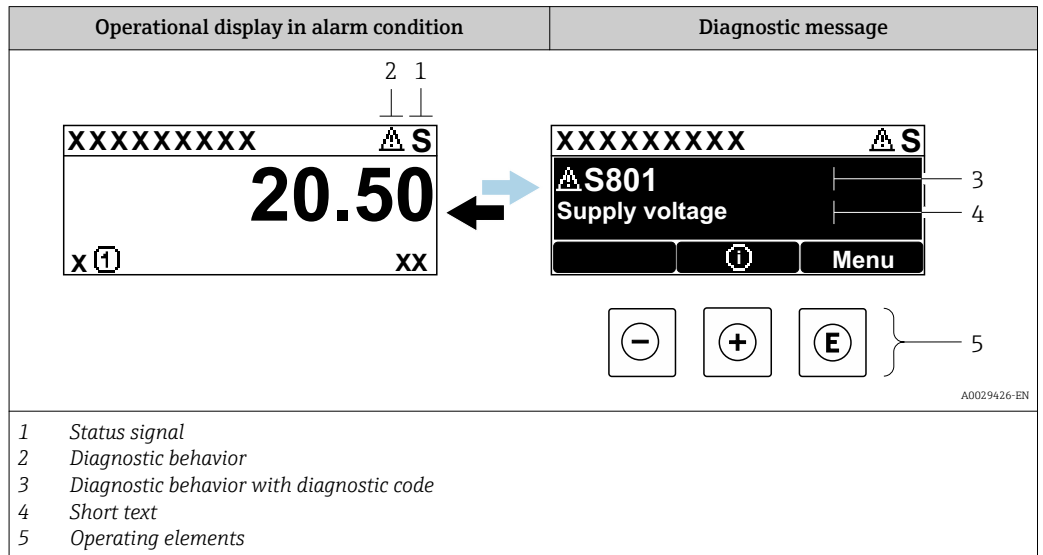

If two or more diagnostic events are pending simultaneously, only the message of the diagnostic event with the highest priority is shown.

- i** Other diagnostic events that have occurred can be displayed in the **Diagnostics** menu:
  - Via parameter
  - Via submenus → 112



#### Status signals

The status signals provide information on the state and reliability of the device by categorizing the cause of the diagnostic information (diagnostic event).

- i** The status signals are categorized according to VDI/VDE 2650 and NAMUR Recommendation NE 107: F = Failure, C = Function Check, S = Out of Specification, M = Maintenance Required

| Symbol   | Meaning   |
|----------|---|
| <b>F</b> | <b>Failure</b><br>A device error has occurred. The measured value is no longer valid.   |
| <b>C</b> | <b>Function check</b><br>The device is in service mode (e.g. during a simulation).  |
| <b>S</b> | <b>Out of specification</b><br>The device is operated: <ul style="list-style-type: none"> <li>▪ Outside its technical specification limits (e.g. outside the process temperature range)</li> <li>▪ Outside of the configuration carried out by the user (e.g. maximum flow in parameter 20 mA value)</li> </ul> |
| <b>M</b> | <b>Maintenance required</b><br>Maintenance is required. The measured value remains valid.   |

### Diagnostic behavior



| Symbol  | Meaning  |
|---|--|
|  | <b>Alarm</b> <ul style="list-style-type: none"> <li>Measurement is interrupted.</li> <li>Signal outputs and totalizers assume the defined alarm condition.</li> <li>A diagnostic message is generated.</li> <li>For local display with touch control: the background lighting changes to red.</li> </ul> |
|  | <b>Warning</b><br>Measurement is resumed. The signal outputs and totalizers are not affected. A diagnostic message is generated.   |

### Diagnostic information

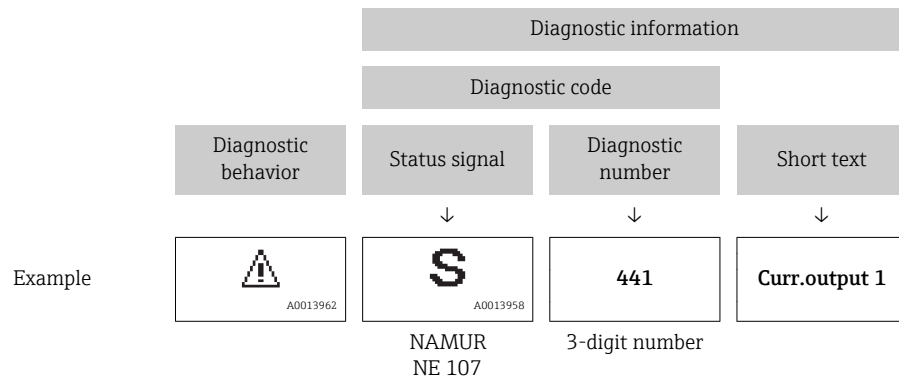
The fault can be identified using the diagnostic information. The short text helps you by providing information about the fault. In addition, the corresponding symbol for the diagnostic behavior is displayed in front of the diagnostic information on the local display.



### Operating elements

| Key   | Meaning   |
|---|---|
|  | <b>Plus key</b><br><i>In a menu, submenu</i><br>Opens the message about remedy information. |
|  | <b>Enter key</b><br><i>In a menu, submenu</i><br>Opens the operating menu.                  |



## 12.2.2 Calling up remedial measures

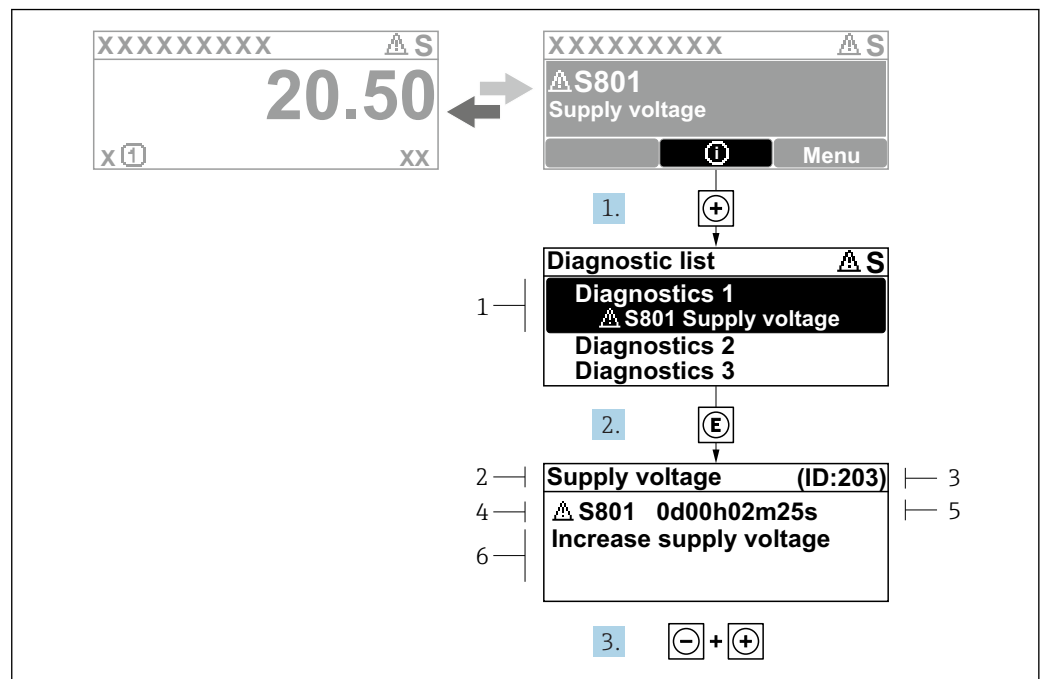

17 Message about remedial measures

- 1 Diagnostic information
- 2 Short text
- 3 Service ID
- 4 Diagnostic behavior with diagnostic code
- 5 Operation time of occurrence
- 6 Remedial measures

1. The user is in the diagnostic message.  
Press  $\oplus$  ( $\text{\textcircled{1}}$  symbol).  
↳ The **Diagnostic list** submenu opens.
2. Select the desired diagnostic event with  $\oplus$  or  $\ominus$  and press  $\text{\textcircled{E}}$ .  
↳ The message about the remedial measures opens.
3. Press  $\ominus$  +  $\oplus$  simultaneously.  
↳ The message about the remedial measures closes.

The user is in the **Diagnostics** menu at an entry for a diagnostics event, e.g. in the **Diagnostic list** submenu or **Previous diagnostics** parameter.

1. Press  $\text{\textcircled{E}}$ .  
↳ The message for the remedial measures for the selected diagnostic event opens.
2. Press  $\ominus$  +  $\oplus$  simultaneously.  
↳ The message for the remedial measures closes.

## 12.3 Diagnostic information in FieldCare or DeviceCare

### 12.3.1 Diagnostic options

Any faults detected by the measuring device are displayed on the home page of the operating tool once the connection has been established.

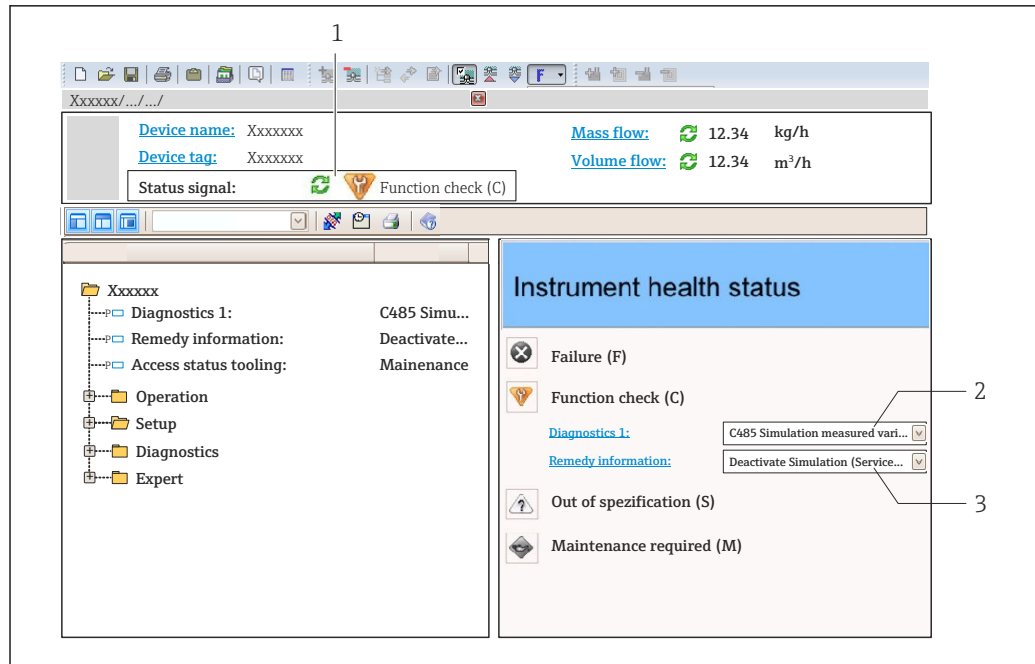

- 1 Status area with status signal → 103
- 2 Diagnostic information → 104
- 3 Remedy information with Service ID

**i** In addition, diagnostic events which have occurred can be shown in the **Diagnostics** menu:

- Via parameter
- Via submenu → 112

### Status signals

The status signals provide information on the state and reliability of the device by categorizing the cause of the diagnostic information (diagnostic event).

| Symbol | Meaning   |
|--------|---|
|        | <b>Failure</b><br>A device error has occurred. The measured value is no longer valid.   |
|        | <b>Function check</b><br>The device is in service mode (e.g. during a simulation).  |
|        | <b>Out of specification</b><br>The device is operated: <ul style="list-style-type: none"> <li>▪ Outside its technical specification limits (e.g. outside the process temperature range)</li> <li>▪ Outside of the configuration carried out by the user (e.g. maximum flow in parameter 20 mA value)</li> </ul> |
|        | <b>Maintenance required</b><br>Maintenance is required. The measured value is still valid.  |

**i** The status signals are categorized in accordance with VDI/VDE 2650 and NAMUR Recommendation NE 107.

### Diagnostic information

The fault can be identified using the diagnostic information. The short text helps you by providing information about the fault. In addition, the corresponding symbol for the diagnostic behavior is displayed in front of the diagnostic information on the local display.

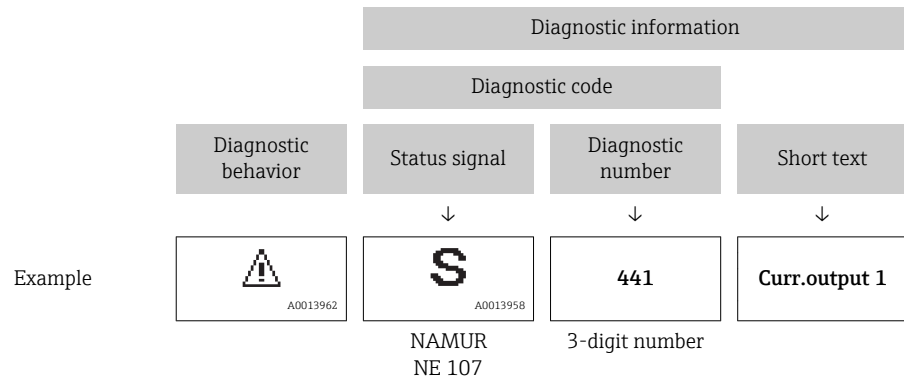

### 12.3.2 Calling up remedy information

Remedy information is provided for every diagnostic event to ensure that problems can be rectified quickly:

- On the home page  
Remedy information is displayed in a separate field below the diagnostics information.
- In the **Diagnostics** menu  
Remedy information can be called up in the working area of the user interface.

The user is in the **Diagnostics** menu.

1. Call up the desired parameter.
2. On the right in the working area, mouse over the parameter.  
↳ A tool tip with remedy information for the diagnostic event appears.

## 12.4 Adapting the diagnostic information

### 12.4.1 Adapting the diagnostic behavior

Each item of diagnostic information is assigned a specific diagnostic behavior at the factory. The user can change this assignment for specific diagnostic information in the **Diagnostic behavior** submenu.

Expert → System → Diagnostic handling → Diagnostic behavior

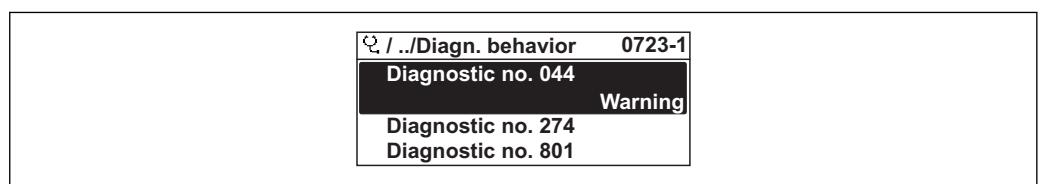

18 Taking the example of the local display

You can assign the following options to the diagnostic number as the diagnostic behavior:

| Options | Description   |
|---------|---|
| Alarm   | The device stops measurement. The signal outputs and totalizers assume the defined alarm condition. A diagnostic message is generated.<br>For local display with touch control: the background lighting changes to red. |
| Warning | The device continues to measure. The signal outputs and totalizers are not affected. A diagnostic message is generated.   |

| Options            | Description  |
|--------------------|--|
| Logbook entry only | The device continues to measure. The diagnostic message is displayed only in the <b>Event logbook</b> submenu ( <b>Event list</b> submenu) and is not displayed in alternation with the operational display. |
| Off                | The diagnostic event is ignored, and no diagnostic message is generated or entered.  |

### 12.4.2 Adapting the status signal

Each item of diagnostic information is assigned a specific status signal at the factory. The user can change this assignment for specific diagnostic information in the **Diagnostic event category** submenu.





Expert → Communication → Diagnostic event category

#### Available status signals

Configuration as per HART 7 Specification (Condensed Status), in accordance with NAMUR NE107.

| Symbol               | Meaning  |
|----------------------|--|
| <b>F</b><br>A0013956 | <b>Failure</b><br>A device error is present. The measured value is no longer valid.  |
| <b>C</b><br>A0013959 | <b>Function check</b><br>The device is in service mode (e.g. during a simulation).   |
| <b>S</b><br>A0013958 | <b>Out of specification</b><br>The device is being operated: <ul style="list-style-type: none"> <li>▪ Outside its technical specification limits (e.g. outside the process temperature range)</li> <li>▪ Outside of the configuration carried out by the user (e.g. maximum flow in parameter <b>20 mA value</b>)</li> </ul> |
| <b>M</b><br>A0013957 | <b>Maintenance required</b><br>Maintenance is required. The measured value is still valid.   |
| <b>N</b><br>A0023076 | Has no effect on the condensed status.   |

## 12.5 Overview of diagnostic information

-  The amount of diagnostic information and the number of measured variables affected increase if the measuring device has one or more application packages.
-  In the case of some items of diagnostic information, the status signal and the diagnostic behavior can be changed. Change the diagnostic information →  107
-  The diagnostic behavior and the diagnostic category can be changed in the event of the following diagnostic information:

### Diagnostics for the sensor

- $\Delta$ S046 Sensor limit exceeded
- $\Delta$ S140 Sensor signal

### Diagnostics for the electronics

- $\Delta$ S274 Main electronic failure

### Diagnostics for the configuration

- $\Delta$ S441 Current output 1 to n
- $\Delta$ S442 Frequency output
- $\Delta$ S443 Pulse output

### Diagnostics for the process

- $\Delta$ S801 Supply voltage too low
- $\Delta$ S830 Sensor temperature too high
- $\Delta$ S831 Sensor temperature too low
- $\Delta$ S832 Ambient temperature too high
- $\Delta$ S833 Ambient temperature too low
- $\Delta$ S834 Process temperature too high
- $\Delta$ S835 Process temperature too low
- $\Delta$ S862 Partly filled pipe
- $\Delta$ S912 Medium inhomogeneous
- $\Delta$ S913 Medium unsuitable

| Diagnostic number               | Short text            | Remedy instructions  | Status signal [from the factory] | Diagnostic behavior [from the factory] |
|---------------------------------|-----------------------|--|----------------------------------|--|
| <b>Diagnostic of sensor</b>     |                       |  |                                  |  |
| 022                             | Sensor temperature    | 1. Change main electronic module<br>2. Change sensor                   | F                                | Alarm                                  |
| 046                             | Sensor limit exceeded | 1. Inspect sensor<br>2. Check process condition                        | S                                | Warning <sup>1)</sup>                  |
| 062                             | Sensor connection     | 1. Change main electronic module<br>2. Change sensor                   | F                                | Alarm                                  |
| 082                             | Data storage          | 1. Change main electronic module<br>2. Change sensor                   | F                                | Alarm                                  |
| 083                             | Memory content        | 1. Restart device<br>2. Restore S-Dat data<br>3. Change sensor         | F                                | Alarm                                  |
| 140                             | Sensor signal         | 1. Check or change main electronics<br>2. Change sensor                | S                                | Warning <sup>1)</sup>                  |
| <b>Diagnostic of electronic</b> |                       |  |                                  |  |
| 242                             | Software incompatible | 1. Check software<br>2. Flash or change main electronics module        | F                                | Alarm                                  |
| 252                             | Modules incompatible  | 1. Check electronic modules<br>2. Change I/O or main electronic module | F                                | Alarm <sup>1)</sup>                    |

| Diagnostic number                  | Short text                 | Remedy instructions  | Status signal [from the factory] | Diagnostic behavior [from the factory] |
|------------------------------------|----------------------------|--|----------------------------------|--|
| 261                                | Electronic modules         | 1. Restart device<br>2. Check electronic modules<br>3. Change I/O Modul or main electronics      | F                                | Alarm                                  |
| 262                                | Module connection          | 1. Check module connections<br>2. Change electronic modules                                      | F                                | Alarm                                  |
| 270                                | Main electronic failure    | Change main electronic module  | F                                | Alarm                                  |
| 271                                | Main electronic failure    | 1. Restart device<br>2. Change main electronic module  | F                                | Alarm                                  |
| 272                                | Main electronic failure    | 1. Restart device<br>2. Contact service  | F                                | Alarm                                  |
| 273                                | Main electronic failure    | 1. Emergency operation via display<br>2. Change main electronics                                 | F                                | Alarm                                  |
| 274                                | Main electronic failure    | Unstable measurement<br>1. Change main electronics   | S                                | Warning <sup>1)</sup>                  |
| 275                                | I/O module failure         | Change I/O module  | F                                | Alarm                                  |
| 276                                | I/O module failure         | 1. Restart device<br>2. Change I/O module  | F                                | Alarm                                  |
| 282                                | Data storage               | 1. Restart device<br>2. Contact service  | F                                | Alarm                                  |
| 283                                | Memory content             | 1. Transfer data or reset device<br>2. Contact service   | F                                | Alarm                                  |
| 302                                | Device verification active | Device verification active, please wait.   | C                                | Warning                                |
| 311                                | Electronic failure         | 1. Transfer data or reset device<br>2. Contact service   | F                                | Alarm                                  |
| 311                                | Electronic failure         | Maintenance required!<br>1. Do not perform reset<br>2. Contact service                           | M                                | Warning                                |
| 362                                | Main electronic failure    | 1. Change main electronic module<br>2. Change sensor   | F                                | Alarm                                  |
| <b>Diagnostic of configuration</b> |                            |  |                                  |  |
| 410                                | Data transfer              | 1. Check connection<br>2. Retry data transfer  | F                                | Alarm                                  |
| 411                                | Up-/download active        | Up-/download active, please wait   | C                                | Warning                                |
| 412                                | Processing Download        | Download active, please wait   | C                                | Warning                                |
| 431                                | Trim 1 to n                | Carry out trim   | C                                | Warning                                |
| 437                                | Configuration incompatible | 1. Restart device<br>2. Contact service  | F                                | Alarm                                  |
| 438                                | Dataset                    | 1. Check data set file<br>2. Check device configuration<br>3. Up- and download new configuration | M                                | Warning                                |
| 441                                | Current output 1 to n      | 1. Check process<br>2. Check current output settings   | S                                | Warning <sup>1)</sup>                  |
| 442                                | Frequency output           | 1. Check process<br>2. Check frequency output settings   | S                                | Warning <sup>1)</sup>                  |
| 443                                | Pulse output               | 1. Check process<br>2. Check pulse output settings   | S                                | Warning <sup>1)</sup>                  |



| Diagnostic number            | Short text                       | Remedy instructions   | Status signal [from the factory] | Diagnostic behavior [from the factory] |
|------------------------------|----------------------------------|---|----------------------------------|--|
| 444                          | Current input 1                  | 1. Check process<br>2. Check current input settings                                     | S                                | Warning <sup>1)</sup>                  |
| 453                          | Flow override                    | Deactivate flow override  | C                                | Warning                                |
| 484                          | Simulation failure mode          | Deactivate simulation   | C                                | Alarm                                  |
| 485                          | Simulation measured variable     | Deactivate simulation   | C                                | Warning                                |
| 486                          | Simulation current input 1       | Deactivate simulation   | C                                | Warning                                |
| 491                          | Simulation current output 1 to n | Deactivate simulation   | C                                | Warning                                |
| 492                          | Simulation frequency output      | Deactivate simulation frequency output  | C                                | Warning                                |
| 493                          | Simulation pulse output          | Deactivate simulation pulse output  | C                                | Warning                                |
| 494                          | Switch output simulation         | Deactivate simulation switch output   | C                                | Warning                                |
| 495                          | Diagnostic event simulation      | Deactivate simulation   | C                                | Warning                                |
| <b>Diagnostic of process</b> |                                  |   |                                  |  |
| 801                          | Supply voltage too low           | Increase supply voltage   | S                                | Warning <sup>1)</sup>                  |
| 803                          | Current loop                     | 1. Check wiring<br>2. Change I/O module   | F                                | Alarm                                  |
| 830                          | Sensor temperature too high      | Reduce ambient temp. around the sensor housing  | S                                | Warning <sup>1)</sup>                  |
| 831                          | Sensor temperature too low       | Increase ambient temp. around the sensor housing  | S                                | Warning <sup>1)</sup>                  |
| 832                          | Electronic temperature too high  | Reduce ambient temperature  | S                                | Warning <sup>1)</sup>                  |
| 833                          | Electronic temperature too low   | Increase ambient temperature  | S                                | Warning <sup>1)</sup>                  |
| 834                          | Process temperature too high     | Reduce process temperature  | S                                | Warning <sup>1)</sup>                  |
| 835                          | Process temperature too low      | Increase process temperature  | S                                | Warning <sup>1)</sup>                  |
| 842                          | Process limit                    | Low flow cut off active!<br>1. Check low flow cut off configuration                     | S                                | Warning                                |
| 862                          | Partly filled pipe               | 1. Check for gas in process<br>2. Adjust detection limits                               | S                                | Warning <sup>1)</sup>                  |
| 882                          | Input signal                     | 1. Check input configuration<br>2. Check external device or process conditions          | F                                | Alarm                                  |
| 910                          | Tubes not oscillating            | 1. Check process conditions<br>2. Increase supply<br>3. Check main electronic or sensor | F                                | Alarm                                  |
| 912                          | Medium inhomogeneous             | 1. Check process cond.<br>2. Increase system pressure                                   | S                                | Warning <sup>1)</sup>                  |
| 913                          | Medium unsuitable                | 1. Check process conditions<br>2. Increase supply<br>3. Check main electronic or sensor | S                                | Warning <sup>1)</sup>                  |



1) Diagnostic behavior can be changed.

## 12.6 Pending diagnostic events

The **Diagnostics** menu allows the user to view the current diagnostic event and the previous diagnostic event separately.





 To call up the measures to rectify a diagnostic event:

- Via local display →  105
- Via "FieldCare" operating tool →  107
- Via "DeviceCare" operating tool →  107

 Other pending diagnostic events can be displayed in the **Diagnostic list** submenu →  112

### Navigation

"Diagnostics" menu

|  |   |
|--|---|
|  <b>Diagnostics</b> |   |
| Actual diagnostics   | →  112   |
| Previous diagnostics   | →  112   |
| Operating time from restart  | →  112   |
| Operating time   | →  112 |

### Parameter overview with brief description

| Parameter                   | Prerequisite                                 | Description  | User interface   |
|-----------------------------|--|--|--|
| Actual diagnostics          | A diagnostic event has occurred.             | Shows the current occurred diagnostic event along with its diagnostic information.<br> If two or more messages occur simultaneously, the message with the highest priority is shown on the display. | Symbol for diagnostic behavior, diagnostic code and short message. |
| Previous diagnostics        | Two diagnostic events have already occurred. | Shows the diagnostic event that occurred prior to the current diagnostic event along with its diagnostic information.  | Symbol for diagnostic behavior, diagnostic code and short message. |
| Operating time from restart | -  | Shows the time the device has been in operation since the last device restart.   | Days (d), hours (h), minutes (m) and seconds (s)                   |
| Operating time              | -  | Indicates how long the device has been in operation.   | Days (d), hours (h), minutes (m) and seconds (s)                   |

## 12.7 Diagnostic list

Up to 5 currently pending diagnostic events can be displayed in the **Diagnostic list** submenu along with the associated diagnostic information. If more than 5 diagnostic events are pending, the events with the highest priority are shown on the display.

### Navigation path

Diagnostics → Diagnostic list



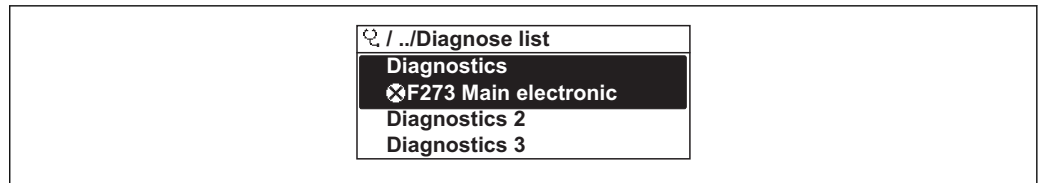

A0014006-EN

19 Taking the example of the local display

- i** To call up the measures to rectify a diagnostic event:
- Via local display → 105
  - Via "FieldCare" operating tool → 107
  - Via "DeviceCare" operating tool → 107

## 12.8 Event logbook

### 12.8.1 Reading out the event logbook

A chronological overview of the event messages that have occurred is provided in the **Events list** submenu.

#### Navigation path

**Diagnostics** menu → **Event logbook** submenu → Event list

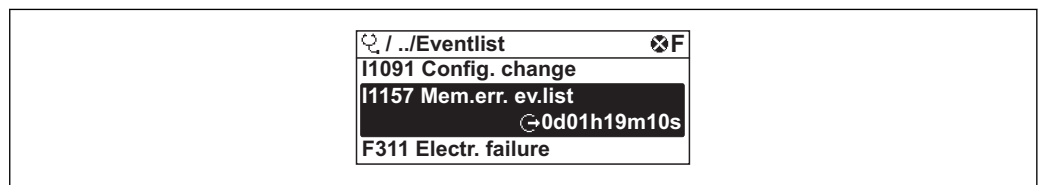

A0014008-EN

20 Taking the example of the local display

- A maximum of 20 event messages can be displayed in chronological order.
- If the **Extended HistoROM** application package (order option) is enabled in the device, the event list can contain up to 100 entries .

The event history includes entries for:

- Diagnostic events → 109
- Information events → 114

In addition to the operation time of its occurrence, each event is also assigned a symbol that indicates whether the event has occurred or is ended:

- Diagnostic event
  - ☺: Occurrence of the event
  - ☹: End of the event
- Information event
  - ☺: Occurrence of the event

- i** To call up the measures to rectify a diagnostic event:
- Via local display → 105
  - Via "FieldCare" operating tool → 107
  - Via "DeviceCare" operating tool → 107

- i** For filtering the displayed event messages → 113

### 12.8.2 Filtering the event logbook

Using the **Filter options** parameter you can define which category of event message is displayed in the **Events list** submenu.

**Navigation path**

Diagnostics → Event logbook → Filter options

**Filter categories**

- All
- Failure (F)
- Function check (C)
- Out of specification (S)
- Maintenance required (M)
- Information (I)

**12.8.3 Overview of information events**

Unlike a diagnostic event, an information event is displayed in the event logbook only and not in the diagnostic list.

| Info number | Info name                        |
|-------------|----------------------------------|
| I1000       | ----- (Device ok)                |
| I1079       | Sensor changed                   |
| I1089       | Power on                         |
| I1090       | Configuration reset              |
| I1091       | Configuration changed            |
| I1092       | Trend data deleted               |
| I1110       | Write protection switch changed  |
| I1111       | Density adjust failure           |
| I1137       | Electronic changed               |
| I1151       | History reset                    |
| I1154       | Reset terminal voltage min/max   |
| I1155       | Reset electronic temperature     |
| I1156       | Memory error trend               |
| I1157       | Memory error event list          |
| I1185       | Display backup done              |
| I1186       | Restore via display done         |
| I1187       | Settings downloaded with display |
| I1188       | Display data cleared             |
| I1189       | Backup compared                  |
| I1209       | Density adjustment ok            |
| I1221       | Zero point adjust failure        |
| I1222       | Zero point adjustment ok         |
| I1227       | Sensor emergency mode activated  |
| I1228       | Sensor emergency mode failed     |
| I1256       | Display: access status changed   |
| I1264       | Safety sequence aborted          |
| I1335       | Firmware changed                 |
| I1397       | Fieldbus: access status changed  |
| I1398       | CDI: access status changed       |
| I1440       | Main electronic module changed   |
| I1442       | I/O module changed               |

| Info number | Info name                            |
|-------------|--------------------------------------|
| I1444       | Device verification passed           |
| I1445       | Device verification failed           |
| I1450       | Monitoring off                       |
| I1451       | Monitoring on                        |
| I1459       | Failed: I/O module verification      |
| I1461       | Failed: Sensor verification          |
| I1512       | Download started                     |
| I1513       | Download finished                    |
| I1514       | Upload started                       |
| I1515       | Upload finished                      |
| I1552       | Failed: Main electronic verification |
| I1554       | Safety sequence started              |
| I1555       | Safety sequence confirmed            |
| I1556       | Safety mode off                      |

## 12.9 Resetting the measuring device

Using the **Device reset** parameter (→  86) it is possible to reset the entire device configuration or some of the configuration to a defined state.

### 12.9.1 Function scope of the "Device reset" parameter



| Options              | Description  |
|----------------------|--|
| Cancel               | No action is executed and the user exits the parameter.  |
| To factory defaults  | Every parameter is reset to its factory setting.   |
| To delivery settings | Every parameter for which a customer-specific default setting was ordered is reset to this customer-specific value. All other parameters are reset to the factory setting.<br> This option is not visible if no customer-specific settings have been ordered. |
| Restart device       | The restart resets every parameter whose data are in the volatile memory (RAM) to the factory setting (e.g. measured value data). The device configuration remains unchanged.  |

## 12.10 Device information

The **Device information** submenu contains all parameters that display different information for device identification.





### Navigation

"Diagnostics" menu → Device information

|                      |   |
|----------------------|---|
| ▶ Device information |   |
| Device tag           | →  116 |
| Serial number        | →  116 |

|                       |         |
|-----------------------|---------|
| Firmware version      | → ⓘ 116 |
| Device name           | → ⓘ 116 |
| Order code            | → ⓘ 116 |
| Extended order code 1 | → ⓘ 116 |
| Extended order code 2 | → ⓘ 116 |
| Extended order code 3 | → ⓘ 117 |
| ENP version           | → ⓘ 117 |
| Device revision       | → ⓘ 117 |
| Device ID             | → ⓘ 117 |
| Device type           | → ⓘ 117 |
| Manufacturer ID       | → ⓘ 117 |



### Parameter overview with brief description

| Parameter             | Description  | User interface  | Factory setting |
|-----------------------|--|---|-----------------|
| Device tag            | Shows name of measuring point.   | Max. 32 characters, such as letters, numbers or special characters (e.g. @, %, /).    | Promass         |
| Serial number         | Shows the serial number of the measuring device.   | Max. 11-digit character string comprising letters and numbers.                        | –               |
| Firmware version      | Shows the device firmware version installed.   | Character string in the format xx.yy.zz   | –               |
| Device name           | Shows the name of the transmitter.<br> The name can be found on the nameplate of the transmitter.   | Max. 32 characters such as letters or numbers.  | Promass 200     |
| Order code            | Shows the device order code.<br> The order code can be found on the nameplate of the sensor and transmitter in the "Order code" field.                                    | Character string composed of letters, numbers and certain punctuation marks (e.g. /). | –               |
| Extended order code 1 | Shows the 1st part of the extended order code.<br> The extended order code can also be found on the nameplate of the sensor and transmitter in the "Ext. ord. cd." field. | Character string  | –               |
| Extended order code 2 | Shows the 2nd part of the extended order code.<br> The extended order code can also be found on the nameplate of the sensor and transmitter in the "Ext. ord. cd." field. | Character string  | –               |

| Parameter             | Description  | User interface             | Factory setting           |
|-----------------------|--|----------------------------|---------------------------|
| Extended order code 3 | Shows the 3rd part of the extended order code.<br> The extended order code can also be found on the nameplate of the sensor and transmitter in the "Ext. ord. cd." field. | Character string           | –                         |
| ENP version           | Shows the version of the electronic nameplate (ENP).   | Character string           | 2.02.00                   |
| Device revision       | Shows the device revision with which the device is registered with the HART Communication Foundation.  | 2-digit hexadecimal number | 0x05                      |
| Device ID             | Enter device ID of external device.  | 6-digit hexadecimal number | –                         |
| Device type           | Displays the device type with which the measuring device is registered with the HART Communication Foundation.   | 2-digit hexadecimal number | 0x54                      |
| Manufacturer ID       | Displays the manufacturer ID with which the measuring device is registered with the HART Communication Foundation.   | 2-digit hexadecimal number | 0x11 (for Endress+Hauser) |

## 12.11 Firmware history

| Release date | Firmware version | Order code for "Firmware version" | Firmware changes  | Documentation type     | Documentation        |
|--------------|------------------|-----------------------------------|-------------------|------------------------|----------------------|
| 05.2018      | 01.04.zz         | Option 72                         | Original firmware | Operating Instructions | BA01821D/06/EN/01.18 |

-  It is possible to flash the firmware to the current version or the previous version using the service interface.
-  For the compatibility of the firmware version with the previous version, the installed device description files and operating tools, observe the information about the device in the "Manufacturer's information" document.
-  The manufacturer's information is available:
  - In the Download Area of the Endress+Hauser web site: [www.endress.com](http://www.endress.com) → Downloads
  - Specify the following details:
    - Product root: e.g. 8A2B  
The product root is the first part of the order code: see the nameplate on the device.
    - Text search: Manufacturer's information
    - Media type: Documentation – Technical Documentation

## 13 Maintenance

### 13.1 Maintenance tasks

No special maintenance work is required.

#### 13.1.1 Exterior cleaning

When cleaning the exterior of measuring devices, always use cleaning agents that do not attack the surface of the housing or the seals.

#### 13.1.2 Interior cleaning

Observe the following points for CIP and SIP cleaning:

- Use only cleaning agents to which the process-wetted materials are adequately resistant.
- Observe the maximum permitted medium temperature for the measuring device  
→  138.

### 13.2 Measuring and test equipment

Endress+Hauser offers a wide variety of measuring and test equipment, such as W@M or device tests.

 Your Endress+Hauser Sales Center can provide detailed information on the services.

List of some of the measuring and testing equipment: →  122 →  124

### 13.3 Endress+Hauser services

Endress+Hauser offers a wide variety of services for maintenance such as recalibration, maintenance service or device tests.

 Your Endress+Hauser Sales Center can provide detailed information on the services.

## 14 Repair

### 14.1 General notes

#### 14.1.1 Repair and conversion concept

The Endress+Hauser repair and conversion concept provides for the following:

- The measuring devices have a modular design.
- Spare parts are grouped into logical kits with the associated Installation Instructions.
- Repairs are carried out by Endress+Hauser Service or by appropriately trained customers.
- Certified devices can only be converted to other certified devices by Endress+Hauser Service or at the factory.

#### 14.1.2 Notes for repair and conversion

For repair and modification of a measuring device, observe the following notes:

- ▶ Use only original Endress+Hauser spare parts.
- ▶ Carry out the repair according to the Installation Instructions.
- ▶ Observe the applicable standards, federal/national regulations, Ex documentation (XA) and certificates.
- ▶ Document every repair and each conversion and enter them into the *W@M* life cycle management database.

### 14.2 Spare parts

Some interchangeable measuring device components are listed on an overview sign in the connection compartment cover.

The spare part overview sign contains the following information:

- A list of the most important spare parts for the measuring device, including their ordering information.
- The URL for the *W@M Device Viewer* ([www.endress.com/deviceviewer](http://www.endress.com/deviceviewer)):  
All the spare parts for the measuring device, along with the order code, are listed here and can be ordered. If available, users can also download the associated Installation Instructions.

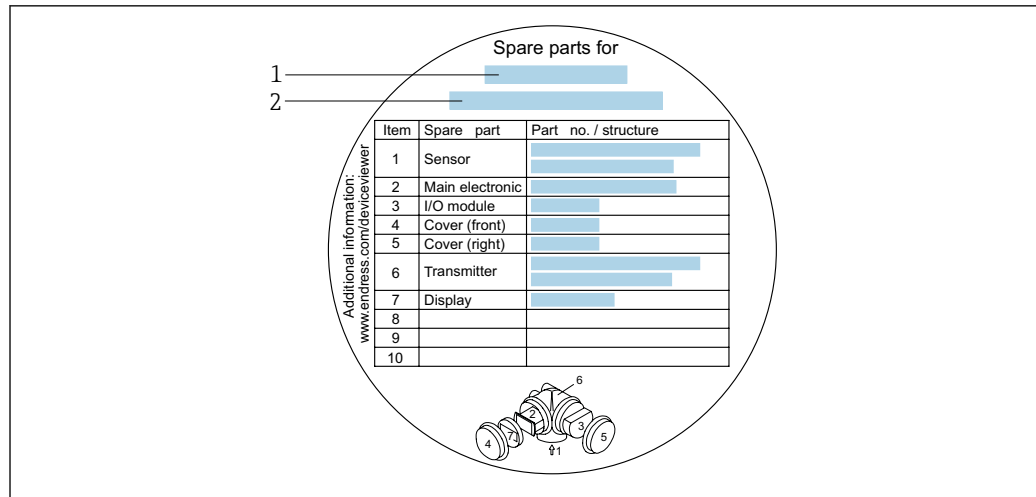

A0032235

21 Example for "Spare part overview sign" in connection compartment cover

- 1 Measuring device name
- 2 Measuring device serial number

- Measuring device serial number:
- Is located on the device nameplate and the spare part overview sign.
  - Can be read out via the **Serial number** parameter (→ 116) in the **Device information** submenu.

## 14.3 Endress+Hauser services

Endress+Hauser offers a wide range of services.

- Your Endress+Hauser Sales Center can provide detailed information on the services.

## 14.4 Return

The requirements for safe device return can vary depending on the device type and national legislation.

1. Refer to the website for more information:  
<http://www.endress.com/support/return-material>
2. Return the device if repairs or a factory calibration are required, or if the wrong device was ordered or delivered.

## 14.5 Disposal



If required by the Directive 2012/19/EU on waste electrical and electronic equipment (WEEE), the product is marked with the depicted symbol in order to minimize the disposal of WEEE as unsorted municipal waste. Do not dispose of products bearing this marking as unsorted municipal waste. Instead, return them to Endress+Hauser for disposal under the applicable conditions.

### 14.5.1 Removing the measuring device

1. Switch off the device.



**⚠ WARNING****Danger to persons from process conditions.**

- ▶ Beware of hazardous process conditions such as pressure in the measuring device, high temperatures or aggressive fluids.
2. Carry out the mounting and connection steps from the "Mounting the measuring device" and "Connecting the measuring device" sections in reverse order. Observe the safety instructions.

### 14.5.2 Disposing of the measuring device

**⚠ WARNING****Danger to personnel and environment from fluids that are hazardous to health.**

- ▶ Ensure that the measuring device and all cavities are free of fluid residues that are hazardous to health or the environment, e.g. substances that have permeated into crevices or diffused through plastic.

Observe the following notes during disposal:



- ▶ Observe valid federal/national regulations.
- ▶ Ensure proper separation and reuse of the device components.



## 15 Accessories

Various accessories, which can be ordered with the device or subsequently from Endress+Hauser, are available for the device. Detailed information on the order code in question is available from your local Endress+Hauser sales center or on the product page of the Endress+Hauser website: [www.endress.com](http://www.endress.com).



### 15.1 Device-specific accessories

#### 15.1.1 For the transmitter



| Accessories             | Description   |
|-------------------------|---|
| Promass 200 transmitter | <p>Transmitter for replacement or storage. Use the order code to define the following specifications:</p> <ul style="list-style-type: none"> <li>▪ Approvals</li> <li>▪ Output</li> <li>▪ Display/operation</li> <li>▪ Housing</li> <li>▪ Software</li> </ul> <p> Installation Instructions EA00104D</p> <p> (Order number: 8X2CXX)</p>   |
| Remote display FHX50    | <p>FHX50 housing for accommodating a display module .</p> <ul style="list-style-type: none"> <li>▪ FHX50 housing suitable for: <ul style="list-style-type: none"> <li>▪ SD02 display module (push buttons)</li> <li>▪ SD03 display module (touch control)</li> </ul> </li> <li>▪ Length of connecting cable: up to max. 60 m (196 ft)<br/>(cable lengths available for order: 5 m (16 ft), 10 m (32 ft), 20 m (65 ft), 30 m (98 ft))</li> </ul> <p>The measuring device can be ordered with the FHX50 housing and a display module. The following options must be selected in the separate order codes:</p> <ul style="list-style-type: none"> <li>▪ Order code for measuring device, feature 030:<br/>Option L or M "Prepared for FHX50 display"</li> <li>▪ Order code for FHX50 housing, feature 050 (device version):<br/>Option A "Prepared for FHX50 display"</li> <li>▪ Order code for FHX50 housing, depends on the desired display module in feature 020 (display, operation): <ul style="list-style-type: none"> <li>▪ Option C: for an SD02 display module (push buttons)</li> <li>▪ Option E: for an SD03 display module (touch control)</li> </ul> </li> </ul> <p>The FHX50 housing can also be ordered as a retrofit kit. The measuring device display module is used in the FHX50 housing. The following options must be selected in the order code for the FHX50 housing:</p> <ul style="list-style-type: none"> <li>▪ Feature 050 (measuring device version): option B "Not prepared for FHX50 display"</li> <li>▪ Feature 020 (display, operation): option A "None, existing displayed used"</li> </ul> <p> Special Documentation SD01007F</p> <p>(Order number: FHX50)</p> |









| Accessories                               | Description   |
|---|---|
| Overvoltage protection for 2-wire devices | <p>Ideally, the overvoltage protection module should be ordered directly with the device. See product structure, feature 610 "Accessory mounted", option NA "Overvoltage protection". Separate order necessary only if retrofitting.</p> <ul style="list-style-type: none"> <li>▪ OVP10: For 1-channel devices (feature 020, option A):</li> <li>▪ OVP20: For 2-channel devices (feature 020, options B, C, E or G)</li> </ul> <p> Special Documentation SD01090F</p> <p>(Order number OVP10: 71128617)<br/>(Order number OVP20: 71128619)</p> |
| Protective cover                          | <p>Is used to protect the measuring device from the effects of the weather: e.g. rainwater, excess heating from direct sunlight or extreme cold in winter.</p> <p> Special Documentation SD00333F</p> <p>(Order number: 71162242)</p>  |

### 15.1.2 For the sensor



| Accessories    | Description   |
|----------------|---|
| Heating jacket | <p>Is used to stabilize the temperature of the fluids in the sensor. Water, water vapor and other non-corrosive liquids are permitted for use as fluids.</p> <p> If using oil as a heating medium, please consult with Endress+Hauser.</p> <ul style="list-style-type: none"> <li>▪ If ordered together with the measuring device: <ul style="list-style-type: none"> <li>order code for "Enclosed accessories"</li> <li>▪ Option RB "heating jacket, G 1/2" internal thread"</li> <li>▪ Option RD "Heating jacket, NPT 1/2" internal thread"</li> </ul> </li> <li>▪ If ordered subsequently: <ul style="list-style-type: none"> <li>Use the order code with the product root DK8003.</li> </ul> </li> </ul> <p> Special Documentation SD02173D</p> |
| Sensor holder  | <p>For wall, tabletop and pipe mounting.</p> <p> Order number: 71392563</p>  |

## 15.2 Communication-specific accessories











| Accessories                 | Description   |
|-----------------------------|---|
| Commubox FXA195 HART        | <p>For intrinsically safe HART communication with FieldCare via the USB interface.</p> <p> Technical Information TI00404F</p>  |
| Commubox FXA291             | <p>Connects Endress+Hauser field devices with a CDI interface (= Endress+Hauser Common Data Interface) and the USB port of a computer or laptop.</p> <p> Technical Information TI405C/07</p>   |
| HART Loop Converter HMX50   | <p>Is used to evaluate and convert dynamic HART process variables to analog current signals or limit values.</p> <ul style="list-style-type: none"> <li>▪ Technical Information TI00429F</li> <li>▪ Operating Instructions BA00371F</li> </ul>  |
| Wireless HART adapter SWA70 | <p>Is used for the wireless connection of field devices. The WirelessHART adapter can be easily integrated into field devices and existing infrastructures, offers data protection and transmission safety and can be operated in parallel with other wireless networks with minimum cabling complexity.</p> <p> Operating Instructions BA00061S</p> |

|                   |  |
|-------------------|--|
| Fieldgate FXA42   | <p>Is used to transmit the measured values of connected 4 to 20 mA analog measuring devices, as well as digital measuring devices</p> <ul style="list-style-type: none"> <li> Technical Information TI01297S</li> <li> Operating Instructions BA01778S</li> <li> Product page: <a href="http://www.endress.com/fxa42">www.endress.com/fxa42</a></li> </ul>  |
| Field Xpert SMT70 | <p>The Field Xpert SMT70 tablet PC for device configuration enables mobile plant asset management in hazardous and non-hazardous areas. It is suitable for commissioning and maintenance staff to manage field instruments with a digital communication interface and to record progress.</p> <p>This tablet PC is designed as an all-in-one solution with a preinstalled driver library and is an easy-to-use, touch-sensitive tool which can be used to manage field instruments throughout their entire life cycle.</p> <ul style="list-style-type: none"> <li> Technical Information TI01342S</li> <li> Operating Instructions BA01709S</li> <li> Product page: <a href="http://www.endress.com/smt70">www.endress.com/smt70</a></li> </ul> |
| Field Xpert SMT77 | <p>The Field Xpert SMT77 tablet PC for device configuration enables mobile plant asset management in areas categorized as Ex Zone 1.</p> <ul style="list-style-type: none"> <li> Technical Information TI01418S</li> <li> Operating Instructions BA01923S</li> <li> Product page: <a href="http://www.endress.com/smt77">www.endress.com/smt77</a></li> </ul>   |

### 15.3 Service-specific accessories

| Accessories | Description  |
|-------------|--|
| Applicator  | <p>Software for selecting and sizing Endress+Hauser measuring devices:</p> <ul style="list-style-type: none"> <li>▪ Choice of measuring devices for industrial requirements</li> <li>▪ Calculation of all the necessary data for identifying the optimum flowmeter: e.g. nominal diameter, pressure loss, flow velocity and accuracy.</li> <li>▪ Graphic illustration of the calculation results</li> <li>▪ Determination of the partial order code, administration, documentation and access to all project-related data and parameters over the entire life cycle of a project.</li> </ul> <p>Applicator is available:</p> <ul style="list-style-type: none"> <li>▪ Via the Internet: <a href="https://portal.endress.com/webapp/applicator">https://portal.endress.com/webapp/applicator</a></li> <li>▪ As a downloadable DVD for local PC installation.</li> </ul> |
| W@M         | <p>W@M Life Cycle Management</p> <p>Improved productivity with information at your fingertips. Data relevant to a plant and its components is generated from the first stages of planning and during the asset's complete life cycle.</p> <p>W@M Life Cycle Management is an open and flexible information platform with online and on-site tools. Instant access for your staff to current, in-depth data shortens your plant's engineering time, speeds up procurement processes and increases plant uptime.</p> <p>Combined with the right services, W@M Life Cycle Management boosts productivity in every phase. For more information, visit <a href="http://www.endress.com/lifecyclemanagement">www.endress.com/lifecyclemanagement</a></p>   |
| FieldCare   | <p>FDT-based plant asset management tool from Endress+Hauser.</p> <p>It can configure all smart field units in your system and helps you manage them. By using the status information, it is also a simple but effective way of checking their status and condition.</p> <ul style="list-style-type: none"> <li> Operating Instructions BA00027S and BA00059S</li> </ul>  |
| DeviceCare  | <p>Tool to connect and configure Endress+Hauser field devices.</p> <ul style="list-style-type: none"> <li> Innovation brochure IN01047S</li> </ul>  |

## 15.4 System components

| Accessories                      | Description  |
|----------------------------------|--|
| Memograph M graphic data manager | <p>The Memograph M graphic data manager provides information on all the relevant measured variables. Measured values are recorded correctly, limit values are monitored and measuring points analyzed. The data are stored in the 256 MB internal memory and also on a SD card or USB stick.</p> <ul style="list-style-type: none"> <li> Technical Information TI00133R</li> <li> Operating Instructions BA00247R</li> </ul> |
| RN221N                           | <p>Active barrier with power supply for safe separation of 4-20 mA standard signal circuits. Offers bidirectional HART transmission.</p> <ul style="list-style-type: none"> <li> Technical Information TI00073R</li> <li> Operating Instructions BA00202R</li> </ul>   |
| RNS221                           | <p>Supply unit for powering two 2-wire measuring devices solely in the non-hazardous area. Bidirectional communication is possible via the HART communication jacks.</p> <ul style="list-style-type: none"> <li> Technical Information TI00081R</li> <li> Brief Operating Instructions KA00110R</li> </ul>   |
| Cerabar M                        | <p>The pressure transmitter for measuring the absolute and gauge pressure of gases, steam and liquids. It can be used to read in the operating pressure value.</p> <ul style="list-style-type: none"> <li> Technical Information TI00426P and TI00436P</li> <li> Operating Instructions BA00200P and BA00382P</li> </ul>   |
| Cerabar S                        | <p>The pressure transmitter for measuring the absolute and gauge pressure of gases, steam and liquids. It can be used to read in the operating pressure value.</p> <ul style="list-style-type: none"> <li> Technical Information TI00383P</li> <li> Operating Instructions BA00271P</li> </ul>   |

## 16 Technical data

### 16.1 Application

- The measuring device is intended only for the flow measurement of liquids and gases.
- The measuring device is intended only for the flow measurement of liquids with a minimum conductivity of 20  $\mu\text{S}/\text{cm}$ .

Depending on the version ordered, the measuring device can also measure potentially explosive, flammable, poisonous and oxidizing media.

To ensure that the device remains in proper operating condition for its service life, use the measuring device only for media against which the process-wetted materials are sufficiently resistant.

### 16.2 Function and system design

---

|                     |  |
|---------------------|--|
| Measuring principle | Mass flow measurement based on the Coriolis measuring principle  |
| Measuring system    | <p>The device consists of a transmitter and a sensor.</p> <p>The device is available as a compact version:<br/>The transmitter and sensor form a mechanical unit.</p> <p>For information on the structure of the device →  13</p> |

---

## 16.3 Input

Measured variable

### Direct measured variables

- Mass flow
- Density
- Temperature

### Calculated measured variables

- Volume flow
- Corrected volume flow
- Reference density

Measuring range

### Measuring range for liquids

| DN   |      | Measuring range full scale values $\dot{m}_{\min(F)}$ to $\dot{m}_{\max(F)}$ |            |
|------|------|--|------------|
| [mm] | [in] | [kg/h]   | [lb/min]   |
| 1    | 1/24 | 0 to 20  | 0 to 0.735 |
| 2    | 1/12 | 0 to 100   | 0 to 3.675 |
| 4    | 1/6  | 0 to 450   | 0 to 16.54 |

### Measuring range for gases

The full scale value depends on the density and the sound velocity of the gas used and can be calculated with the formula below:

$$\dot{m}_{\max(G)} = \text{minimum} (\dot{m}_{\max(F)} \cdot \rho_G : x ; \rho_G \cdot c_G \cdot \pi/2 \cdot (d_i)^2 \cdot 3600)$$

|   |   |
|---|---|
| $\dot{m}_{\max(G)}$                     | Maximum full scale value for gas [kg/h]                           |
| $\dot{m}_{\max(F)}$                     | Maximum full scale value for liquid [kg/h]                        |
| $\dot{m}_{\max(G)} < \dot{m}_{\max(F)}$ | $\dot{m}_{\max(G)}$ can never be greater than $\dot{m}_{\max(F)}$ |
| $\rho_G$                                | Gas density in [kg/m <sup>3</sup> ] at operating conditions       |
| x                                       | Constant dependent on nominal diameter                            |
| $c_G$                                   | Sound velocity (gas) [m/s]  |
| $d_i$                                   | Measuring tube internal diameter [m]                              |

| DN   |      | x                    |
|------|------|----------------------|
| [mm] | [in] | [kg/m <sup>3</sup> ] |
| 1    | 1/24 | 32                   |
| 2    | 1/12 | 32                   |
| 4    | 1/6  | 32                   |



### Calculation example for gas

- Sensor: Promass A, DN 2
- Gas: Air with a density of 11.9 kg/m<sup>3</sup> (at 20 °C and 10 bar)
- Measuring range (liquid): 100 kg/h
- x = 32 kg/m<sup>3</sup> (for Promass A DN 2)

Maximum possible full scale value:

$$\dot{m}_{\max(G)} = \dot{m}_{\max(F)} \cdot \rho_G : x = 100 \text{ kg/h} \cdot 11.9 \text{ kg/m}^3 : 32 \text{ kg/m}^3 = 37.2 \text{ kg/h}$$

**Recommended measuring range**

 Flow limit →  139

Operable flow range



Over 1000 : 1.

Flow rates above the preset full scale value do not override the electronics unit, with the result that the totalizer values are registered correctly.

Input signal

**External measured values**

To increase the accuracy of certain measured variables or to calculate the corrected volume flow for gases, the automation system can continuously write the operating pressure to the measuring device. Endress+Hauser recommends the use of a pressure measuring device for absolute pressure, e.g. Cerabar M or Cerabar S.

 Various pressure transmitters and temperature measuring devices can be ordered from Endress+Hauser: see "Accessories" section →  125

It is recommended to read in external measured values to calculate the following measured variables:

- Mass flow
- Corrected volume flow

*HART protocol*

The measured values are written from the automation system to the measuring device via the HART protocol. The pressure transmitter must support the following protocol-specific functions:

- HART protocol
- Burst mode

## 16.4 Output

Output signal

**Current output**

|                                      |  |
|--------------------------------------|--|
| <b>Current output 1</b>              | 4-20 mA HART (passive)   |
| <b>Current output 2</b>              | 4-20 mA (passive)  |
| <b>Resolution</b>                    | < 1 µA   |
| <b>Damping</b>                       | Adjustable: 0.0 to 999.9 s   |
| <b>Assignable measured variables</b> | <ul style="list-style-type: none"> <li>▪ Mass flow</li> <li>▪ Volume flow</li> <li>▪ Corrected volume flow</li> <li>▪ Density</li> <li>▪ Reference density</li> <li>▪ Temperature</li> </ul> |

**Pulse/frequency/switch output**

|                             |   |
|-----------------------------|---|
| <b>Function</b>             | Can be set to pulse, frequency or switch output   |
| <b>Version</b>              | Passive, open collector   |
| <b>Maximum input values</b> | <ul style="list-style-type: none"> <li>▪ DC 35 V</li> <li>▪ 50 mA</li> </ul>                  |
| <b>Voltage drop</b>         | <ul style="list-style-type: none"> <li>▪ For ≤ 2 mA: 2 V</li> <li>▪ For 10 mA: 8 V</li> </ul> |



|                                      |  |
|--------------------------------------|--|
| <b>Residual current</b>              | ≤ 0.05 mA  |
| <b>Pulse output</b>                  |  |
| <b>Pulse width</b>                   | Adjustable: 5 to 2 000 ms  |
| <b>Maximum pulse rate</b>            | 100 Impulse/s  |
| <b>Pulse value</b>                   | Adjustable   |
| <b>Assignable measured variables</b> | <ul style="list-style-type: none"> <li>▪ Mass flow</li> <li>▪ Volume flow</li> <li>▪ Corrected volume flow</li> </ul>  |
| <b>Frequency output</b>              |  |
| <b>Output frequency</b>              | Adjustable: 0 to 1 000 Hz  |
| <b>Damping</b>                       | Adjustable: 0 to 999 s   |
| <b>Pulse/pause ratio</b>             | 1:1  |
| <b>Assignable measured variables</b> | <ul style="list-style-type: none"> <li>▪ Mass flow</li> <li>▪ Volume flow</li> <li>▪ Corrected volume flow</li> <li>▪ Density</li> <li>▪ Reference density</li> <li>▪ Temperature</li> </ul>   |
| <b>Switch output</b>                 |  |
| <b>Switching behavior</b>            | Binary, conductive or non-conductive   |
| <b>Switching delay</b>               | Adjustable: 0 to 100 s   |
| <b>Number of switching cycles</b>    | Unlimited  |
| <b>Assignable functions</b>          | <ul style="list-style-type: none"> <li>▪ Off</li> <li>▪ On</li> <li>▪ Diagnostic behavior</li> <li>▪ Limit value <ul style="list-style-type: none"> <li>▪ Mass flow</li> <li>▪ Volume flow</li> <li>▪ Corrected volume flow</li> </ul> </li> <li>▪ Density</li> <li>▪ Reference density</li> <li>▪ Temperature</li> <li>▪ Totalizer 1-3</li> <li>▪ Flow direction monitoring</li> <li>▪ Status <ul style="list-style-type: none"> <li>▪ Partially filled pipe detection</li> <li>▪ Low flow cut off</li> </ul> </li> </ul> |

Signal on alarm

Depending on the interface, failure information is displayed as follows:

**Current output 4 to 20 mA***4 to 20 mA*

|                     |  |
|---------------------|--|
| <b>Failure mode</b> | Choose from: <ul style="list-style-type: none"> <li>▪ 4 to 20 mA in accordance with NAMUR recommendation NE 43</li> <li>▪ 4 to 20 mA in accordance with US</li> <li>▪ Min. value: 3.59 mA</li> <li>▪ Max. value: 22.5 mA</li> <li>▪ Freely definable value between: 3.59 to 22.5 mA</li> <li>▪ Actual value</li> <li>▪ Last valid value</li> </ul> |
|---------------------|--|

**Pulse/frequency/switch output**

| Pulse output     |  |
|------------------|--|
| Failure mode     | Choose from: <ul style="list-style-type: none"> <li>■ Actual value</li> <li>■ No pulses</li> </ul>                                   |
| Frequency output |  |
| Failure mode     | Choose from: <ul style="list-style-type: none"> <li>■ Actual value</li> <li>■ 0 Hz</li> <li>■ Defined value: 0 to 1250 Hz</li> </ul> |
| Switch output    |  |
| Failure mode     | Choose from: <ul style="list-style-type: none"> <li>■ Current status</li> <li>■ Open</li> <li>■ Closed</li> </ul>                    |

**Local display**

|                    |   |
|--------------------|---|
| Plain text display | With information on cause and remedial measures   |
| Backlight          | Additionally for device version with SD03 local display: red lighting indicates a device error. |

 Status signal as per NAMUR recommendation NE 107

**Interface/protocol**

- Via digital communication:
  - HART protocol
- Via service interface
  - CDI service interface

|                    |   |
|--------------------|---|
| Plain text display | With information on cause and remedial measures |
|--------------------|---|

Load →  30

Low flow cut off      The switch points for low flow cut off are user-selectable.

Galvanic isolation      All outputs are galvanically isolated from one another.

**Protocol-specific data**

|                                    |   |
|------------------------------------|---|
| Manufacturer ID                    | 0x11  |
| Device type ID                     | 0x54  |
| HART protocol revision             | 7   |
| Device description files (DTM, DD) | Information and files under: <a href="http://www.endress.com">www.endress.com</a>   |
| HART load                          | <ul style="list-style-type: none"> <li>■ Min. 250 Ω</li> <li>■ Max. 500 Ω</li> </ul>  |
| System integration                 | For information on system integration, see .→  56 <ul style="list-style-type: none"> <li>■ Measured variables via HART protocol</li> <li>■ Burst Mode functionality</li> </ul> |

## 16.5 Power supply

### Terminal assignment

#### Transmitter

4-20 mA HART connection version with additional outputs

|   |  |
|---|--|
| <p>A0013570</p>   | <p>A0018161</p>  |
| <p>Maximum number of terminals, without integrated overvoltage protection</p>   | <p>Maximum number of terminals, with integrated overvoltage protection</p> |
| <p>1 Output 1 (passive): supply voltage and signal transmission<br/>                 2 Output 2 (passive): supply voltage and signal transmission<br/>                 3 Ground terminal for cable shield</p> |  |

| Order code for "Output" | Terminal numbers       |       |   |       |
|-------------------------|------------------------|-------|---|-------|
|                         | Output 1               |       | Output 2                                |       |
|                         | 1 (+)                  | 2 (-) | 3 (+)                                   | 4 (-) |
| Option A                | 4-20 mA HART (passive) |       | -                                       |       |
| Option B <sup>1)</sup>  | 4-20 mA HART (passive) |       | Pulse/frequency/switch output (passive) |       |
| Option C <sup>1)</sup>  | 4-20 mA HART (passive) |       | 4-20 mA analog (passive)                |       |

1) Output 1 must always be used; output 2 is optional.

### Supply voltage

#### Transmitter

An external power supply is required for each output.

The following supply voltage values apply for the outputs available:

| Order code for "Output"   | Minimum terminal voltage  | Maximum terminal voltage |
|---|---|--------------------------|
| Option A <sup>1) 2)</sup> : 4-20 mA HART                                | <ul style="list-style-type: none"> <li>■ For 4 mA: ≥ DC 17.9 V</li> <li>■ For 20 mA: ≥ DC 13.5 V</li> </ul> | DC 35 V                  |
| Option B <sup>1) 2)</sup> : 4-20 mA HART, pulse/frequency/switch output | <ul style="list-style-type: none"> <li>■ For 4 mA: ≥ DC 17.9 V</li> <li>■ For 20 mA: ≥ DC 13.5 V</li> </ul> | DC 35 V                  |
| Option C <sup>1) 2)</sup> : 4-20 mA HART + 4-20 mA analog               | <ul style="list-style-type: none"> <li>■ For 4 mA: ≥ DC 17.9 V</li> <li>■ For 20 mA: ≥ DC 13.5 V</li> </ul> | DC 30 V                  |

- 1) External supply voltage of the power supply unit with load.
- 2) For device versions with SD03 local display: The terminal voltage must be increased by DC 2 V if backlighting is used.

Power consumption

**Transmitter**

| Order code for "Output; input"                        | Maximum power consumption  |
|---|--|
| Option A: 4-20 mA HART                                | 770 mW   |
| Option B: 4-20 mA HART, pulse/frequency/switch output | <ul style="list-style-type: none"> <li>▪ Operation with output 1: 770 mW</li> <li>▪ Operation with output 1 and 2: 2 770 mW</li> </ul> |
| Option C: 4-20 mA HART + 4-20 mA analog               | <ul style="list-style-type: none"> <li>▪ Operation with output 1: 660 mW</li> <li>▪ Operation with output 1 and 2: 1 320 mW</li> </ul> |

Current consumption

**Current output**

For every 4-20 mA or 4-20 mA HART current output: 3.6 to 22.5 mA

 If the option **Defined value** is selected in the **Failure mode** parameter : 3.59 to 22.5 mA

Power supply failure

- Totalizers stop at the last value measured.
- Depending on the device version, the configuration is retained in the device memory or in the pluggable data memory (HistoROM DAT).
- Error messages (incl. total operated hours) are stored.

Electrical connection

→  31

Potential equalization

→  33

Terminals

- For device version without integrated overvoltage protection: plug-in spring terminals for wire cross-sections 0.5 to 2.5 mm<sup>2</sup> (20 to 14 AWG)
- For device version with integrated overvoltage protection: screw terminals for wire cross-sections 0.2 to 2.5 mm<sup>2</sup> (24 to 14 AWG)

Cable entries

- Cable gland: M20 × 1.5 with cable Ø 6 to 12 mm (0.24 to 0.47 in)
- Thread for cable entry:
  - NPT ½"
  - G ½"

Cable specification

→  29

Overvoltage protection

The device can be ordered with integrated overvoltage protection for diverse approvals: *Order code for "Accessory mounted", option NA "Overvoltage protection"*

|                               |   |
|-------------------------------|---|
| <b>Input voltage range</b>    | Values correspond to supply voltage specifications →  30 <sup>1)</sup> |
| <b>Resistance per channel</b> | 2 · 0.5 Ω max.  |
| <b>DC sparkover voltage</b>   | 400 to 700 V  |
| <b>Trip surge voltage</b>     | < 800 V   |
| <b>Capacitance at 1 MHz</b>   | < 1.5 pF  |

|   |                                |
|---|--------------------------------|
| <b>Nominal discharge current<br/>(8/20 <math>\mu</math>s)</b> | 10 kA                          |
| <b>Temperature range</b>                                      | -40 to +85 °C (-40 to +185 °F) |

1) The voltage is reduced by the amount of the internal resistance  $I_{min} \cdot R_i$



 Depending on the temperature class, restrictions apply to the ambient temperature for device versions with overvoltage protection .

 For detailed information on the temperature tables, see the "Safety Instructions" (XA) for the device.

## 16.6 Performance characteristics

Reference operating conditions

- Error limits based on ISO 11631
- Water with +15 to +45 °C (+59 to +113 °F) at 2 to 6 bar (29 to 87 psi)
- Specifications as per calibration protocol
- Accuracy based on accredited calibration rigs that are traced to ISO 17025.

 To obtain measured errors, use the *Applicator* sizing tool →  124

Maximum measured error

o.r. = of reading; 1 g/cm<sup>3</sup> = 1 kg/l; T = medium temperature

### Base accuracy

 Design fundamentals →  136

*Mass flow and volume flow (liquids)*

±0.10 % o.r.

*Mass flow (gases)*

±0.35 % o.r.

*Density (liquids)*

| Under reference conditions | Standard density calibration <sup>1)</sup> | Wide-range Density specification <sup>2) 3)</sup> |
|----------------------------|--|---|
| [g/cm <sup>3</sup> ]       | [g/cm <sup>3</sup> ]                       | [g/cm <sup>3</sup> ]                              |
| ±0.0005                    | ±0.02                                      | ±0.002  |

1) Valid over the entire temperature and density range

2) Valid range for special density calibration: 0 to 2 g/cm<sup>3</sup>, +5 to +80 °C (+41 to +176 °F)

3) Order code for "Application package", option EE "Special density"

*Temperature*

±0.5 °C ± 0.005 · T °C (±0.9 °F ± 0.003 · (T - 32) °F)

**Zero point stability**

Standard version: order code for "Measuring tube mat., wetted surface", option BB, BF, HA, SA

| DN   |      | Zero point stability |          |
|------|------|----------------------|----------|
| [mm] | [in] | [kg/h]               | [lb/min] |
| 1    | 1/24 | 0.0010               | 0.000036 |
| 2    | 1/12 | 0.0050               | 0.00018  |
| 4    | 1/8  | 0.0200               | 0.00072  |

High-pressure version: order code for "Measuring tube mat., wetted surface", option HB

| DN   |      | Zero point stability |           |
|------|------|----------------------|-----------|
| [mm] | [in] | [kg/h]               | [lb/min]  |
| 1    | 1/24 | 0.0016               | 0.0000576 |
| 2    | 1/12 | 0.0080               | 0.000288  |
| 4    | 1/8  | 0.0320               | 0.001152  |

**Flow values**

Flow values as turndown parameter depending on nominal diameter.

SI units

| DN<br>[mm] | 1:1    | 1:10   | 1:20   | 1:50   | 1:100  | 1:500  |
|------------|--------|--------|--------|--------|--------|--------|
|            | [kg/h] | [kg/h] | [kg/h] | [kg/h] | [kg/h] | [kg/h] |
| 1          | 20     | 2      | 1      | 0.4    | 0.2    | 0.04   |
| 2          | 100    | 10     | 5      | 2      | 1      | 0.2    |
| 4          | 450    | 45     | 22.5   | 9      | 4.5    | 0.9    |

US units

| DN<br>[inch] | 1:1      | 1:10     | 1:20     | 1:50     | 1:100    | 1:500    |
|--------------|----------|----------|----------|----------|----------|----------|
|              | [lb/min] | [lb/min] | [lb/min] | [lb/min] | [lb/min] | [lb/min] |
| 1/24         | 0.735    | 0.074    | 0.037    | 0.015    | 0.007    | 0.001    |
| 1/12         | 3.675    | 0.368    | 0.184    | 0.074    | 0.037    | 0.007    |
| 1/8          | 16.54    | 1.654    | 0.827    | 0.331    | 0.165    | 0.033    |

**Accuracy of outputs**

The outputs have the following base accuracy specifications.

Current output

|          |        |
|----------|--------|
| Accuracy | ±10 µA |
|----------|--------|

Pulse/frequency output



o.r. = of reading

|                 |                         |
|-----------------|-------------------------|
| <b>Accuracy</b> | Max. $\pm 100$ ppm o.r. |
|-----------------|-------------------------|

## Repeatability

o.r. = of reading;  $1 \text{ g/cm}^3 = 1 \text{ kg/l}$ ; T = medium temperature

**Base repeatability**

 Design fundamentals →  136

*Mass flow and volume flow (liquids)*

$\pm 0.05$  % o.r.

*Mass flow (gases)*

$\pm 0.15$  % o.r.

*Density (liquids)*

$\pm 0.00025 \text{ g/cm}^3$

*Temperature*

$\pm 0.25 \text{ }^\circ\text{C} \pm 0.0025 \cdot T \text{ }^\circ\text{C}$  ( $\pm 0.45 \text{ }^\circ\text{F} \pm 0.0015 \cdot (T-32) \text{ }^\circ\text{F}$ )

## Response time

- The response time depends on the configuration (damping).
- Response time in the event of erratic changes in the measured variable: After 500 ms → 95 % of full scale value

## Influence of ambient temperature

**Current output**

o.r. = of reading

Additional error, in relation to the span of 16 mA:

|   |             |
|---|-------------|
| <b>Temperature coefficient at zero point (4 mA)</b> | 0.02 %/10 K |
| <b>Temperature coefficient with span (20 mA)</b>    | 0.05 %/10 K |

**Pulse/frequency output**

o.r. = of reading

|                                |                         |
|--------------------------------|-------------------------|
| <b>Temperature coefficient</b> | Max. $\pm 100$ ppm o.r. |
|--------------------------------|-------------------------|

## Influence of medium temperature

**Mass flow and volume flow**

o.f.s. = of full scale value

When there is a difference between the temperature for zero point adjustment and the process temperature, the additional measured error of the sensor is typically  $\pm 0.0002$  % o.f.s./ $^\circ\text{C}$  ( $\pm 0.0001$  % o. f.s./ $^\circ\text{F}$ ).

The effect is reduced if zero point adjustment is performed at process temperature.

**Density**

When there is a difference between the density calibration temperature and the process temperature, the typical measured error of the sensor is  $\pm 0.00005 \text{ g/cm}^3 \text{ }^\circ\text{C}$  ( $\pm 0.000025 \text{ g/cm}^3 \text{ }^\circ\text{F}$ ). Field density calibration is possible.

**Wide-range density specification (special density calibration)**

If the process temperature is outside the valid range (→  133) the measured error is  $\pm 0.00005 \text{ g/cm}^3 / ^\circ\text{C}$  ( $\pm 0.000025 \text{ g/cm}^3 / ^\circ\text{F}$ )

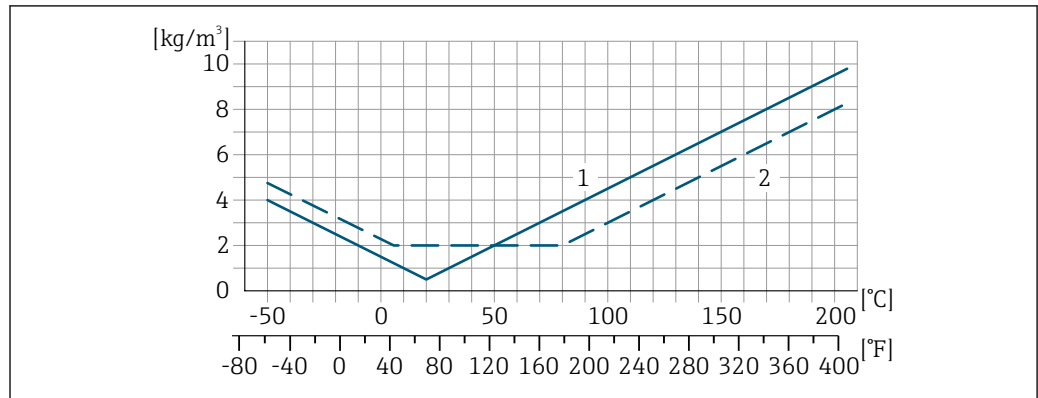

A0016616

- 1 Field density calibration, for example at +20 °C (+68 °F)
- 2 Special density calibration

Influence of medium pressure

A difference between the calibration pressure and process pressure does not affect accuracy.

Design fundamentals

o.r. = of reading, o.f.s. = of full scale value  
 BaseAccu = base accuracy in % o.r., BaseRepeat = base repeatability in % o.r.  
 MeasValue = measured value; ZeroPoint = zero point stability

*Calculation of the maximum measured error as a function of the flow rate*

| Flow rate  | Maximum measured error in % o.r.   |
|--|--|
| $\geq \frac{\text{ZeroPoint}}{\text{BaseAccu}} \cdot 100$<br><small>A0021332</small> | $\pm \text{BaseAccu}$<br><small>A0021339</small>                                     |
| $< \frac{\text{ZeroPoint}}{\text{BaseAccu}} \cdot 100$<br><small>A0021333</small>    | $\pm \frac{\text{ZeroPoint}}{\text{MeasValue}} \cdot 100$<br><small>A0021334</small> |

*Calculation of the maximum repeatability as a function of the flow rate*

| Flow rate  | Maximum repeatability in % o.r.  |
|--|--|
| $\geq \frac{4/3 \cdot \text{ZeroPoint}}{\text{BaseAccu}} \cdot 100$<br><small>A0021341</small> | $\pm 1/2 \cdot \text{BaseAccu}$<br><small>A0021343</small>                                     |
| $< \frac{4/3 \cdot \text{ZeroPoint}}{\text{BaseAccu}} \cdot 100$<br><small>A0021342</small>    | $\pm 2/3 \cdot \frac{\text{ZeroPoint}}{\text{MeasValue}} \cdot 100$<br><small>A0021344</small> |



**Example for maximum measured error**

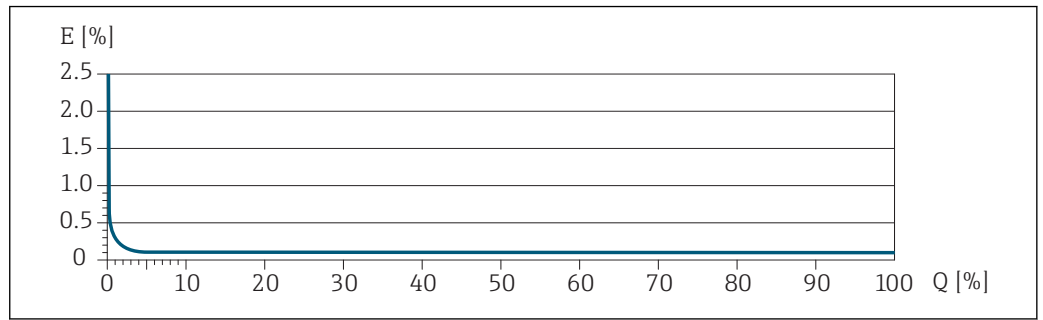

E Maximum measured error in % o.r. (example)  
 Q Flow rate in % of maximum full scale value

**16.7 Installation**

Installation conditions → 20

**16.8 Environment**

Ambient temperature range → 22 → 22

**Temperature tables**

- Observe the interdependencies between the permitted ambient and fluid temperatures when operating the device in hazardous areas.
- For detailed information on the temperature tables, see the separate document entitled "Safety Instructions" (XA) for the device.

Storage temperature -40 to +80 °C (-40 to +176 °F), preferably at +20 °C (+68 °F)

Climate class DIN EN 60068-2-38 (test Z/AD)

Degree of protection **Transmitter**

- As standard: IP66/67, type 4X enclosure
- When housing is open: IP20, type 1 enclosure
- Display module: IP20, type 1 enclosure

**Sensor**  
 IP66/67, type 4X enclosure



Vibration resistance

- Oscillation, sinusoidal, following IEC 60068-2-6
  - 2 to 8.4 Hz, 3.5 mm peak
  - 8.4 to 2 000 Hz, 1 g peak
- Oscillation, broadband noise following IEC 60068-2-64
  - 10 to 200 Hz, 0.003 g<sup>2</sup>/Hz
  - 200 to 2 000 Hz, 0.001 g<sup>2</sup>/Hz
  - Total: 1.54 g rms

|                                     |  |
|-------------------------------------|--|
| Shock resistance                    | Shock, half-sine according to IEC 60068-2-27<br>6 ms 30 g  |
| Shock resistance                    | Shock due to rough handling following IEC 60068-2-31   |
| Interior cleaning                   | <ul style="list-style-type: none"> <li>■ Cleaning in place (CIP)</li> <li>■ Sterilization in place (SIP)</li> </ul> <p><b>Options</b><br/>Oil- and grease-free version for wetted parts, without declaration<br/>Order code for "Service", option HA</p> |
| Electromagnetic compatibility (EMC) | <p>As per IEC/EN 61326 and NAMUR Recommendation 21 (NE 21)</p> <p> Details are provided in the Declaration of Conformity.</p>   |

## 16.9 Process

|                              |  |
|------------------------------|--|
| Medium temperature range     | -50 to +205 °C (-58 to +401 °F)  |
| Density                      | 0 to 2 000 kg/m <sup>3</sup> (0 to 125 lb/cf)  |
| Pressure-temperature ratings | <p> An overview of the pressure-temperature ratings for the process connections is provided in the "Technical Information" document</p> |

|                |  |
|----------------|--|
| Sensor housing | <p>The sensor housing is filled with dry nitrogen gas and protects the electronics and mechanics inside.</p> <p> If a measuring tube fails (e.g. due to process characteristics like corrosive or abrasive fluids), the fluid will initially be contained by the sensor housing.</p> <p>In the event of a tube failure, the pressure level inside the sensor housing will rise according to the operating process pressure. If the user judges that the sensor housing burst pressure does not provide an adequate safety margin, the device can be fitted with a rupture disk. This prevents excessively high pressure from forming inside the sensor housing. Therefore, the use of a rupture disk is strongly recommended in applications involving high gas pressures, and particularly in applications in which the process pressure is greater than 2/3 of the sensor housing burst pressure.</p> <p> High-pressure devices are always fitted with a rupture disk: order code for "Measuring tube mat., wetted surface", option HB</p> |
|----------------|--|

### Burst pressure of the sensor housing

If the device is fitted with a rupture disk (order code for "Sensor option", option CA "Rupture disk"), the rupture disk trigger pressure is decisive .

The sensor housing burst pressure refers to a typical internal pressure which is reached prior to mechanical failure of the sensor housing and which was determined during type

testing. The corresponding type test declaration can be ordered with the device (order code for "Additional approval", option LN "Sensor housing burst pressure, type test").

| DN   |                | Sensor housing burst pressure |       |
|------|----------------|-------------------------------|-------|
| [mm] | [in]           | [bar]                         | [psi] |
| 1    | $\frac{1}{24}$ | 220                           | 3 190 |
| 2    | $\frac{1}{12}$ | 140                           | 2 030 |
| 4    | $\frac{1}{6}$  | 105                           | 1 520 |



For information on the dimensions: see the "Mechanical construction" section of the "Technical Information" document

#### Rupture disk

To increase the level of safety, a device version with a rupture disk with a trigger pressure of 10 to 15 bar (145 to 217.5 psi) can be used (order code for "Sensor option", option CA "rupture disk").

#### Drain connection for rupture disk

To allow any escaping medium to drain in a controlled manner in the event of an error, an optional drain connection can be ordered in addition to the rupture disk.



The function of the rupture disk is not compromised in any way.

#### Flow limit

Select the nominal diameter by optimizing between the required flow range and permissible pressure loss.



For an overview of the full scale values for the measuring range, see the "Measuring range" section → 127

- The minimum recommended full scale value is approx. 1/20 of the maximum full scale value
- In most applications, 20 to 50 % of the maximum full scale value can be considered ideal
- A low full scale value must be selected for abrasive media (such as liquids with entrained solids): flow velocity < 1 m/s (< 3 ft/s).
- For gas measurement the following rules apply:
  - The flow velocity in the measuring tubes should not exceed half the sound velocity (0.5 Mach).
  - The maximum mass flow depends on the density of the gas: formula → 127



To calculate the flow limit, use the *Applicator* sizing tool → 124

#### Pressure loss



To calculate the pressure loss, use the *Applicator* sizing tool → 124

#### System pressure

→ 22

## 16.10 Mechanical construction

#### Design, dimensions



For the dimensions and installation lengths of the device, see the "Technical Information" document, "Mechanical construction" section.

Weight All values (weight exclusive of packaging material) refer to devices with EN/DIN PN 40 flanges.

**Weight in SI units**

| DN [mm] | Weight [kg]   |   |
|---------|---|---|
|         | Order code for "Housing", option C "GT20 dual compartment, aluminum, coated, compact" | Order code for "Housing", option B "GT18 dual compartment, 316L, compact" |
| 1       | 5.5   | 8.2   |
| 2       | 7.1   | 9.8   |
| 4       | 9   | 11.7  |

**Weight in US units**

| DN [in] | Weight [lbs]  |   |
|---------|---|---|
|         | Order code for "Housing", option C "GT20 dual compartment, aluminum, coated, compact" | Order code for "Housing", option B "GT18 dual compartment, 316L, compact" |
| 1/24    | 12  | 18  |
| 1/12    | 16  | 22  |
| 1/8     | 20  | 26  |

Materials

**Transmitter housing**

- Order code for "Housing", option B "Compact, stainless":  
Stainless steel CF-3M (316L, 1.4404)
- Order code for "Housing", option C "Compact, aluminum coated":  
Aluminum, AlSi10Mg, coated
- Window material: glass

**Cable entries/cable glands**

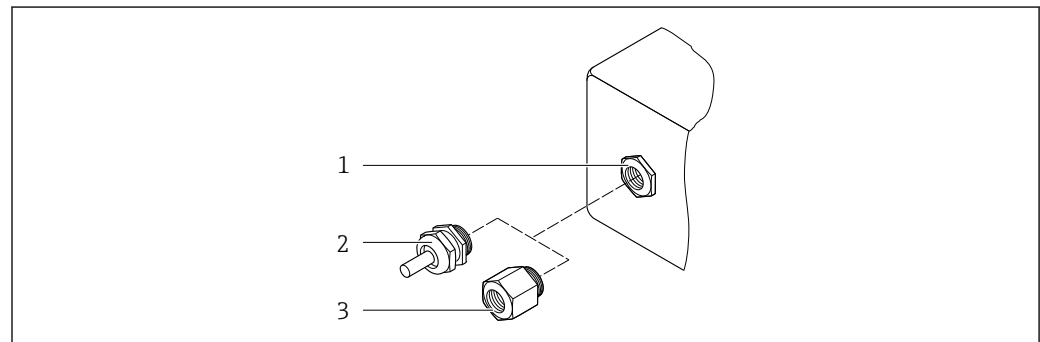

22 Possible cable entries/cable glands

- 1 Female thread M20 × 1.5
- 2 Cable gland M20 × 1.5
- 3 Adapter for cable entry with female thread G ½" or NPT ½"

Order code for "Housing", option B "GT18 dual compartment, 316L"

| Cable entry/cable gland                           | Type of protection   | Material                       |
|---|--|--------------------------------|
| Cable gland M20 × 1.5                             | <ul style="list-style-type: none"> <li>■ Non-Ex</li> <li>■ Ex ia</li> <li>■ Ex ic</li> <li>■ Ex nA</li> <li>■ Ex tb</li> </ul> | Stainless steel ,1.4404        |
| Adapter for cable entry with female thread G ½"   | For non-Ex and Ex (except for CSA Ex d/XP)   | Stainless steel, 1.4404 (316L) |
| Adapter for cable entry with female thread NPT ½" | For non-Ex and Ex  |                                |

Order code for "Housing", option C "GT20 dual compartment, aluminum coated"

| Cable entry/cable gland                           | Type of protection   | Material            |
|---|--|---------------------|
| Cable gland M20 × 1.5                             | <ul style="list-style-type: none"> <li>■ Non-Ex</li> <li>■ Ex ia</li> <li>■ Ex ic</li> </ul> | Plastic             |
|   | Adapter for cable entry with female thread G ½"  | Nickel-plated brass |
| Adapter for cable entry with female thread NPT ½" | For non-Ex and Ex (except for CSA Ex d/XP)   | Nickel-plated brass |
| Thread NPT ½" via adapter                         | For non-Ex and Ex  |                     |

### Sensor housing

- Acid and alkali-resistant outer surface
- Stainless steel, 1.4404 (316L)

### Measuring tubes

Order code for "Measuring tube mat., wetted surface", option BB, BF, SA  
Stainless steel, 1.4435 (316/316L)

Order code for "Measuring tube mat., wetted surface", option HA, HB, HC, HD  
Alloy C22, 2.4602 (UNS N06022)

### Process connections

Order code for "Measuring tube mat., wetted surface", option SA

|   |                                    |
|---|------------------------------------|
| VCO coupling                                  | Stainless steel, 1.4404 (316/316L) |
| G¾", G½" female thread                        | Stainless steel, 1.4404 (316/316L) |
| NPT¼", NPT½" female thread                    | Stainless steel, 1.4404 (316/316L) |
| Tri-Clamp½"                                   | Stainless steel, 1.4435 (316L)     |
| Fixed flange EN 1092-1, ASME B16.5, JIS B2220 | Stainless steel, 1.4404 (316/316L) |

Order code for "Measuring tube mat., wetted surface", option BB, BF

|              |                                    |
|--------------|------------------------------------|
| VCO coupling | Stainless steel, 1.4404 (316/316L) |
| Tri-Clamp½"  | Stainless steel, 1.4435 (316L)     |

Order code for "Measuring tube mat., wetted surface", option HC, HD



|                     |                                |
|---------------------|--------------------------------|
| <b>VCO coupling</b> | Alloy C22, 2.4602 (UNS N06022) |
| <b>Tri-Clamp ½"</b> | Alloy C22, 2.4602 (UNS N06022) |

Order code for "Measuring tube mat., wetted surface", option HA

|  |   |
|--|---|
| <b>VCO coupling</b>                                      | Alloy C22, 2.4602 (UNS N06022)  |
| <b>G¼", G½" female thread</b>                            | Alloy C22, 2.4602 (UNS N06022)  |
| <b>NPT¼", NPT½" female thread</b>                        | Alloy C22, 2.4602 (UNS N06022)  |
| <b>Fixed flange EN 1092-1, ASME B16.5, JIS B2220</b>     | Alloy C22, 2.4602 (UNS N06022)  |
| <b>Lap joint flange EN 1092-1, ASME B16.5, JIS B2220</b> | Stainless steel, 1.4301 (F304), wetted parts Alloy C22, 2.4602 (UNS N06022) |

Order code for "Measuring tube mat., wetted surface", option HB (high-pressure option)

|  |  |
|--|--|
| <b>VCO coupling</b>                                  | Alloy C22, 2.4602 (UNS N06022)                                     |
| <b>G¼", G½" female thread</b>                        | Alloy C22, 2.4602 (UNS N06022)                                     |
| <b>NPT¼", NPT½" female thread</b>                    | Alloy C22, 2.4602 (UNS N06022)                                     |
| <b>Fixed flange EN 1092-1, ASME B16.5, JIS B2220</b> | Stainless steel, 1.4404 (316/316L); Alloy C22, 2.4602 (UNS N06022) |

 Available process connections →  143

### Seals

Welded process connections without internal seals

### Accessories

#### Sensor holder

Stainless steel, 1.4404 (316L)

#### Heating jacket

- Heating jacket housing: stainless steel, 1.4571 (316Ti)
- NPT adapter ½": stainless steel, 1.4404 (316)
- G½" adapter: stainless steel, 1.4404

#### Protective cover

Stainless steel, 1.4404 (316L)



#### Remote display FHX50

Housing material:

- Plastic PBT
- Stainless steel CF-3M (316L, 1.4404)

Process connections

- Fixed flange connections:
  - EN 1092-1 (DIN 2501) flange
  - EN 1092-1 (DIN 2512N) flange
  - ASME B16.5 flange
  - JIS B2220 flange
- Clamp connections:
  - Tri-Clamp (OD tubes), DIN 11866 series C
- VCO connections:
  - 4-VCO-4
- Female thread:
  - Cylindrical female thread BSPP (G) in accordance with ISO 228-1
  - NPT

 Process connection materials →  141

Surface roughness

All data relate to parts in contact with fluid. The following surface roughness quality can be ordered.

- Not polished
- Ra<sub>max</sub> = 0.76 µm (30 µin) mechanically polished
- Ra<sub>max</sub> = 0.38 µm (15 µin) mechanically polished

## 16.11 Operability

Languages

Can be operated in the following languages:

- Via local display:
  - English, German, French, Spanish, Italian, Dutch, Portuguese, Polish, Russian, Swedish, Turkish, Chinese, Japanese, Bahasa (Indonesian), Vietnamese, Czech
- Via "FieldCare" operating tool:
  - English, German, French, Spanish, Italian, Chinese, Japanese

Local operation

**Via display module**

Two display modules are available:

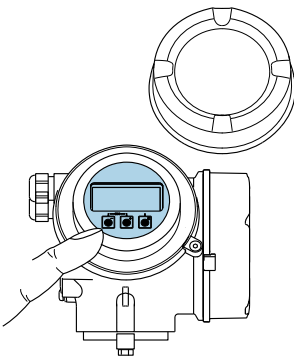
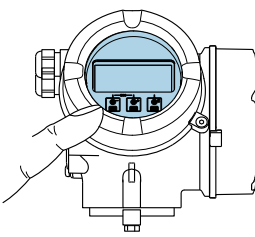
| Order code for "Display; Operation", option C "SD02"   | Order code for "Display; Operation", option E "SD03"   |
|--|--|
|  <p style="text-align: right; font-size: small;">A0032219</p> |  <p style="text-align: right; font-size: small;">A0032221</p> |
| 1 Operation with pushbuttons   | 1 Operation with touch control   |

*Display elements*

- 4-line, illuminated, graphic display
- White background lighting; switches to red in event of device errors
- Format for displaying measured variables and status variables can be individually configured
- Permitted ambient temperature for the display: -20 to +60 °C (-4 to +140 °F)  
The readability of the display may be impaired at temperatures outside the temperature range.



*Operating elements*

- Operation with 3 push buttons with open housing: ⊕, ⊖, ⊞  
or
- External operation via touch control (3 optical keys) without opening the housing: ⊕, ⊖, ⊞
- Operating elements also accessible in the various zones of the hazardous area

*Additional functionality*

- Data backup function  
The device configuration can be saved in the display module.
- Data comparison function  
The device configuration saved in the display module can be compared to the current device configuration.
- Data transfer function  
The transmitter configuration can be transmitted to another device using the display module.

**Via remote display FHX50**

 The remote display FHX50 can be ordered as an optional extra →  122.

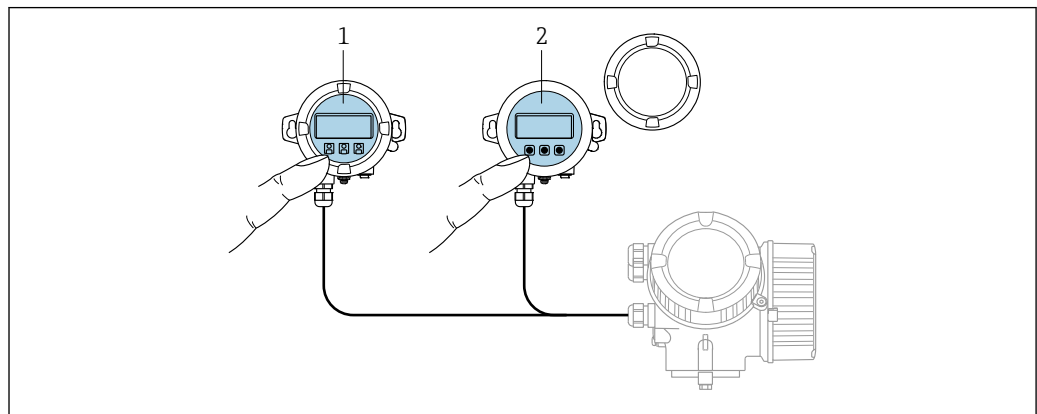

A0032215

 23 FHX50 operating options

- 1 SD02 display and operating module, push buttons: cover must be opened for operation
- 2 SD03 display and operating module, optical buttons: operation possible through cover glass

*Display and operating elements*

The display and operating elements correspond to those of the display module .



Remote operation →  51



Service interface →  52



## 16.12 Certificates and approvals

 Currently available certificates and approvals can be called up via the product configurator.



|                              |  |
|------------------------------|--|
| CE mark                      | <p>The device meets the legal requirements of the applicable EU Directives. These are listed in the corresponding EU Declaration of Conformity along with the standards applied.</p> <p>Endress+Hauser confirms successful testing of the device by affixing to it the CE mark.</p>  |
| RCM-tick symbol              | <p>The measuring system meets the EMC requirements of the "Australian Communications and Media Authority (ACMA)".</p>  |
| Functional safety            | <p>The measuring device can be used for flow monitoring systems (min., max., range) up to SIL 2 (single-channel architecture; order code for "Additional approval", option LA) and SIL 3 (multichannel architecture with homogeneous redundancy) and is independently evaluated and certified by the TÜV in accordance with IEC 61508.</p> <p>The following types of monitoring in safety equipment are possible:</p> <ul style="list-style-type: none"> <li>▪ Mass flow</li> <li>▪ Volume flow</li> <li>▪ Density</li> </ul> <p> Functional Safety Manual with information on the SIL device →  148</p>   |
| Ex approval                  | <p>The devices are certified for use in hazardous areas and the relevant safety instructions are provided in the separate "Safety Instructions" (XA) document. Reference is made to this document on the nameplate.</p>  |
| Sanitary compatibility       | <ul style="list-style-type: none"> <li>▪ 3-A approval           <ul style="list-style-type: none"> <li>▪ Only measuring devices with the order code for "Additional approval", option LP "3A" have 3-A approval.</li> <li>▪ The 3-A approval refers to the measuring device.</li> <li>▪ When installing the measuring device, ensure that no liquid can accumulate on the outside of the measuring device.</li> </ul> </li> <li>Remote transmitters must be installed in accordance with the 3-A Standard.</li> <li>▪ Accessories (e.g. heating jacket, weather protection cover, wall holder unit) must be installed in accordance with the 3-A Standard.</li> <li>Each accessory can be cleaned. Disassembly may be necessary under certain circumstances.</li> <li>▪ FDA</li> <li>▪ Food Contact Materials Regulation (EC) 1935/2004</li> </ul> |
| Pharmaceutical compatibility | <ul style="list-style-type: none"> <li>▪ FDA 21 CFR 177</li> <li>▪ USP &lt;87&gt;</li> <li>▪ USP &lt;88&gt; Class VI 121 °C</li> <li>▪ TSE/BSE Certificate of Suitability</li> <li>▪ cGMP</li> </ul> <p> Devices with order code for "Test, certificate", option JG "Compliance with requirements derived from cGMP, declaration" are in accordance with cGMP requirements relating to the surfaces of wetted parts, design, FDA 21 CFR material conformity, USP Class VI tests and TSE/BSE-compliance.</p> <p>A manufacturer's declaration specific to the serial number is supplied with the device.</p>  |

|                                |   |
|--------------------------------|---|
| Functional safety              | <p>The measuring device can be used for flow monitoring systems (min., max., range) up to SIL 2 (single-channel architecture; order code for "Additional approval", option LA) and SIL 3 (multichannel architecture with homogeneous redundancy) and is independently evaluated and certified by the TÜV in accordance with IEC 61508.</p> <p>The following types of monitoring in safety equipment are possible:</p> <ul style="list-style-type: none"> <li>■ Mass flow</li> <li>■ Volume flow</li> <li>■ Density</li> </ul> <p> Functional Safety Manual with information on the SIL device →  148</p>  |
| HART certification             | <p><b>HART interface</b></p> <p>The measuring device is certified and registered by the FieldComm Group. The measuring system meets all the requirements of the following specifications:</p> <ul style="list-style-type: none"> <li>■ Certified according to HART 7</li> <li>■ The device can also be operated with certified devices of other manufacturers (interoperability)</li> </ul>   |
| Other standards and guidelines | <ul style="list-style-type: none"> <li>■ EN 60529<br/>Degrees of protection provided by enclosures (IP code)</li> <li>■ IEC/EN 60068-2-6<br/>Environmental influences: Test procedure - Test Fc: vibrate (sinusoidal).</li> <li>■ IEC/EN 60068-2-31<br/>Environmental influences: Test procedure - Test Ec: shocks due to rough handling, primarily for devices.</li> <li>■ EN 61010-1<br/>Safety requirements for electrical equipment for measurement, control and laboratory use - general requirements</li> <li>■ IEC/EN 61326<br/>Emission in accordance with Class A requirements. Electromagnetic compatibility (EMC requirements).</li> <li>■ IEC 61508<br/>Functional safety of electrical/electronic/programmable electronic safety-related systems</li> <li>■ NAMUR NE 21<br/>Electromagnetic compatibility (EMC) of industrial process and laboratory control equipment</li> <li>■ NAMUR NE 32<br/>Data retention in the event of a power failure in field and control instruments with microprocessors</li> <li>■ NAMUR NE 43<br/>Standardization of the signal level for the breakdown information of digital transmitters with analog output signal.</li> <li>■ NAMUR NE 53<br/>Software of field devices and signal-processing devices with digital electronics</li> <li>■ NAMUR NE 105<br/>Specifications for integrating fieldbus devices in engineering tools for field devices</li> <li>■ NAMUR NE 107<br/>Self-monitoring and diagnosis of field devices</li> <li>■ NAMUR NE 131<br/>Requirements for field devices for standard applications</li> <li>■ NAMUR NE 132<br/>Coriolis mass meter</li> </ul> |

## 16.13 Application packages

Many different application packages are available to enhance the functionality of the device. Such packages might be needed to address safety aspects or specific application requirements.

The application packages can be ordered with the device or subsequently from Endress+Hauser. Detailed information on the order code in question is available from your local Endress+Hauser sales center or on the product page of the Endress+Hauser website: [www.endress.com](http://www.endress.com).



 Detailed information on the application packages:  
Special Documentation for the device →  148

| Diagnostics functions | Package           | Description   |
|-----------------------|-------------------|---|
|                       | Extended HistoROM | <p>Comprises extended functions concerning the event log and the activation of the measured value memory.</p> <p>Event log:<br/>Memory volume is extended from 20 message entries (standard version) to up to 100 entries.</p> <p>Data logging (line recorder):</p> <ul style="list-style-type: none"> <li>▪ Memory capacity for up to 1000 measured values is activated.</li> <li>▪ 250 measured values can be output via each of the 4 memory channels. The recording interval can be defined and configured by the user.</li> <li>▪ Measured value logs can be accessed via the local display or operating tool e.g. FieldCare, DeviceCare or Web server.</li> </ul> |

| Heartbeat Technology | Package                | Description  |
|----------------------|------------------------|--|
|                      | Heartbeat Verification | <p><b>Heartbeat Verification</b></p> <p>Meets the requirement for traceable verification to DIN ISO 9001:2008 Chapter 7.6 a) "Control of monitoring and measuring equipment".</p> <ul style="list-style-type: none"> <li>▪ Functional testing in the installed state without interrupting the process.</li> <li>▪ Traceable verification results on request, including a report.</li> <li>▪ Simple testing process via local operation or other operating interfaces.</li> <li>▪ Clear measuring point assessment (pass/fail) with high test coverage within the framework of manufacturer specifications.</li> <li>▪ Extension of calibration intervals according to operator's risk assessment.</li> </ul> |

| Special density | Package         | Description  |
|-----------------|-----------------|--|
|                 | Special density | <p>Many applications use density as a key measured value for monitoring quality or controlling processes. The device measures the density of the fluid as standard and makes this value available to the control system.</p> <p>The "Special Density" application package offers high-precision density measurement over a wide density and temperature range particularly for applications subject to varying process conditions.</p> |

## 16.14 Accessories

 Overview of accessories available for order →  122

## 16.15 Supplementary documentation

 For an overview of the scope of the associated Technical Documentation, refer to the following:

- *W@M Device Viewer* ([www.endress.com/deviceviewer](http://www.endress.com/deviceviewer)): Enter the serial number from nameplate
- *Endress+Hauser Operations App*: Enter the serial number from the nameplate or scan the 2D matrix code (QR code) on the nameplate

### Standard documentation      **Brief Operating Instructions**

#### *Brief Operating Instructions for the sensor*

| Measuring device  | Documentation code |
|-------------------|--------------------|
| Proline Promass A | KA01282D           |

#### *Brief Operating Instructions for transmitter*

| Measuring device    | Documentation code |
|---------------------|--------------------|
| Proline Promass 200 | KA01268D           |

### Technical Information

| Measuring device | Documentation code |
|------------------|--------------------|
| Promass A 200    | TI01380D           |

### Supplementary device-dependent documentation      **Safety instructions**

| Contents         | Documentation code |
|------------------|--------------------|
| ATEX/IECEX Ex i  | XA00144D           |
| ATEX/IECEX Ex d  | XA00143D           |
| ATEX/IECEX Ex nA | XA00145D           |
| cCSAus IS        | XA00151D           |
| cCSAus XP        | XA00152D           |
| INMETRO Ex i     | XA01300D           |
| INMETRO Ex d     | XA01305D           |
| INMETRO Ex nA    | XA01306D           |
| NEPSI Ex i       | XA00156D           |
| NEPSI Ex d       | XA00155D           |
| NEPSI Ex nA      | XA00157D           |
| NEPSI Ex i       | XA1755D            |
| NEPSI Ex d       | XA1754D            |
| NEPSI Ex nA      | XA1756D            |
| JPN Ex d         | XA01763D           |

### Special Documentation

| Contents  | Documentation code |
|---|--------------------|
| Information on the Pressure Equipment Directive | SD01614D           |
| Functional Safety Manual                        | SD00147D           |
| Display and operating module FHX50              | SD01007F           |
| Heartbeat Technology                            | SD01849D           |

### Installation Instructions

| Contents  | Comment  |
|---|--|
| Installation instructions for spare part sets and accessories | <ul style="list-style-type: none"><li>▪ Access the overview of all the available spare part sets via <i>W@M Device Viewer</i> → 📖 119</li><li>▪ Accessories available for order with Installation Instructions → 📖 122</li></ul> |

# Index

- 0 ... 9**  
 3-A approval . . . . . 145
- A**  
 Access authorization to parameters  
   Read access . . . . . 50  
   Write access . . . . . 50  
 Access code . . . . . 50  
   Incorrect input . . . . . 50  
 Accuracy . . . . . 133  
 Adapting the diagnostic behavior . . . . . 107  
 Adapting the status signal . . . . . 108  
 Ambient temperature  
   Influence . . . . . 135  
 AMS Device Manager . . . . . 54  
   Function . . . . . 54  
 Application . . . . . 126  
 Application packages . . . . . 147  
 Applicator . . . . . 127  
 Approvals . . . . . 145
- B**  
 Burst Mode . . . . . 58
- C**  
 Cable entries  
   Technical data . . . . . 132  
 Cable entry  
   Degree of protection . . . . . 35  
 CE mark . . . . . 11, 145  
 Certificates . . . . . 145  
 cGMP . . . . . 145  
 Check  
   Installation . . . . . 28  
 Checklist  
   Post-connection check . . . . . 36  
   Post-installation check . . . . . 28  
 Cleaning  
   Cleaning in place (CIP) . . . . . 118  
   Exterior cleaning . . . . . 118  
   Interior cleaning . . . . . 118  
   Sterilization in place (SIP) . . . . . 118  
 Cleaning in place (CIP) . . . . . 138  
 Climate class . . . . . 137  
 Commissioning . . . . . 61  
   Advanced settings . . . . . 80  
   Configuring the measuring device . . . . . 61  
 Communication-specific data . . . . . 56  
 Connecting cable . . . . . 29  
 Connecting the measuring device . . . . . 31  
 Connection  
   see Electrical connection  
 Connection preparations . . . . . 31  
 Connection tools . . . . . 29  
 Context menu  
   Calling up . . . . . 45  
   Closing . . . . . 45  
   Explanation . . . . . 45  
 Current consumption . . . . . 132
- D**  
 Declaration of Conformity . . . . . 11  
 Define access code . . . . . 90  
 Degree of protection . . . . . 35, 137  
 Density . . . . . 138  
 Design fundamentals  
   Maximum measured error . . . . . 136  
   Repeatability . . . . . 136  
 Designated use . . . . . 9  
 Device components . . . . . 13  
 Device description files . . . . . 56  
 Device documentation  
   Supplementary documentation . . . . . 8  
 Device locking, status . . . . . 93  
 Device name  
   Sensor . . . . . 16  
   Transmitter . . . . . 15  
 Device repair . . . . . 119  
 Device revision . . . . . 56  
 Device type ID . . . . . 56  
 DeviceCare . . . . . 54  
   Device description file . . . . . 56  
 Diagnostic behavior  
   Explanation . . . . . 104  
   Symbols . . . . . 104  
 Diagnostic information  
   Design, description . . . . . 104, 106  
   DeviceCare . . . . . 105  
   FieldCare . . . . . 105  
   Local display . . . . . 103  
   Overview . . . . . 109  
   Remedial measures . . . . . 109  
 Diagnostic list . . . . . 112  
 Diagnostic message . . . . . 103  
 Diagnostics  
   Symbols . . . . . 103  
 DIP switches  
   see Write protection switch  
 Direct access . . . . . 47  
 Direct access code . . . . . 42  
 Disabling write protection . . . . . 89  
 Display  
   see Local display  
 Display area  
   For operational display . . . . . 40  
   In the navigation view . . . . . 42  
 Display values  
   For locking status . . . . . 93  
 Disposal . . . . . 120  
 Document  
   Function . . . . . 6  
   Symbols . . . . . 6

- Document function . . . . . 6
- Down pipe . . . . . 20
- E**
- EHDEG-certified . . . . . 145
- Electrical connection
  - Commubox FXA195 (USB) . . . . . 51
  - Commubox FXA291 . . . . . 52
  - Degree of protection . . . . . 35
  - Field Communicator 475 . . . . . 51
  - Field Xpert SFX350/SFX370 . . . . . 51
  - Measuring device . . . . . 29
  - Operating tool (e.g. FieldCare, AMS Device Manager, SIMATIC PDM) . . . . . 51
  - Operating tools
    - Via HART protocol . . . . . 51
    - Via service interface (CDI) . . . . . 52
  - Transmitter power supply unit . . . . . 51
  - VIATOR Bluetooth modem . . . . . 51
- Electromagnetic compatibility . . . . . 138
- Enabling write protection . . . . . 89
- Enabling/disabling the keypad lock . . . . . 51
- Endress+Hauser services
  - Maintenance . . . . . 118
  - Repair . . . . . 120
- Environment
  - Shock resistance . . . . . 138
  - Storage temperature . . . . . 137
  - Vibration resistance . . . . . 137
- Error messages
  - see Diagnostic messages
- Event list . . . . . 113
- Event logbook . . . . . 113
- Ex approval . . . . . 145
- Extended order code
  - Sensor . . . . . 16
  - Transmitter . . . . . 15
- Exterior cleaning . . . . . 118
- F**
- FDA . . . . . 145
- Field Communicator
  - Function . . . . . 55
- Field Communicator 475 . . . . . 55
- Field of application
  - Residual risks . . . . . 10
- Field Xpert
  - Function . . . . . 52
- Field Xpert SFX350 . . . . . 52
- FieldCare . . . . . 53
  - Device description file . . . . . 56
  - Establishing a connection . . . . . 53
  - Function . . . . . 53
  - User interface . . . . . 54
- Filtering the event logbook . . . . . 113
- Firmware
  - Release date . . . . . 56
  - Version . . . . . 56
- Firmware history . . . . . 117
- Flow direction . . . . . 21, 26
- Flow limit . . . . . 139
- Food Contact Materials Regulation . . . . . 145
- Function check . . . . . 61
- Function range
  - Field Xpert . . . . . 52
- Function scope
  - AMS Device Manager . . . . . 54
  - Field Communicator . . . . . 55
  - Field Communicator 475 . . . . . 55
  - SIMATIC PDM . . . . . 55
- Functional safety (SIL) . . . . . 145, 146
- Functions
  - see Parameter
- G**
- Galvanic isolation . . . . . 130
- H**
- Hardware write protection . . . . . 90
- HART certification . . . . . 146
- HART protocol
  - Device variables . . . . . 56
  - Measured values . . . . . 56
- Help text
  - Calling up . . . . . 48
  - Closing . . . . . 48
  - Explanation . . . . . 48
- HistoROM . . . . . 86
- I**
- I/O electronics module . . . . . 13, 32
- Identifying the measuring device . . . . . 14
- Incoming acceptance . . . . . 14
- Influence
  - Ambient temperature . . . . . 135
  - Medium pressure . . . . . 136
  - Medium temperature . . . . . 135
- Information on the document . . . . . 6
- Inlet runs . . . . . 21
- Input . . . . . 127
- Input mask . . . . . 43
- Inspection
  - Received goods . . . . . 14
- Inspection check
  - Connection . . . . . 36
- Installation . . . . . 20
- Installation conditions
  - Down pipe . . . . . 20
  - Inlet and outlet runs . . . . . 21
  - Installation dimensions . . . . . 21
  - Mounting location . . . . . 20
  - Orientation . . . . . 21
  - Rupture disk . . . . . 24
  - Sensor heating . . . . . 23
  - System pressure . . . . . 22
  - Thermal insulation . . . . . 22
  - Vibrations . . . . . 23
- Installation dimensions . . . . . 21

Interior cleaning . . . . . 118, 138

## L

Languages, operation options . . . . . 143  
 Line recorder . . . . . 98  
 Load . . . . . 30  
 Local display . . . . . 143  
   Editing view . . . . . 43  
   Navigation view . . . . . 41  
     see Diagnostic message  
     see In alarm condition  
     see Operational display  
 Low flow cut off . . . . . 130

## M

Main electronics module . . . . . 13  
 Maintenance tasks . . . . . 118  
 Managing the device configuration . . . . . 86  
 Manufacturer ID . . . . . 56  
 Manufacturing date . . . . . 15, 16  
 Materials . . . . . 140  
 Maximum measured error . . . . . 133  
 Measured values  
   see Process variables  
 Measuring and test equipment . . . . . 118  
 Measuring device  
   Configuration . . . . . 61  
   Conversion . . . . . 119  
   Disposal . . . . . 121  
   Mounting the sensor . . . . . 26  
   Preparing for electrical connection . . . . . 31  
   Preparing for mounting . . . . . 26  
   Removing . . . . . 120  
   Repairs . . . . . 119  
   Structure . . . . . 13  
   Switch-on . . . . . 61  
 Measuring principle . . . . . 126  
 Measuring range  
   Calculation example for gas . . . . . 127  
   For gases . . . . . 127  
   For liquids . . . . . 127  
 Measuring range, recommended . . . . . 139  
 Measuring system . . . . . 126  
 Medium pressure  
   Influence . . . . . 136  
 Medium temperature  
   Influence . . . . . 135  
 Menu  
   Diagnostics . . . . . 112  
   Setup . . . . . 62  
 Menus  
   For measuring device configuration . . . . . 61  
   For specific settings . . . . . 80  
 Mounting dimensions  
   see Installation dimensions  
 Mounting location . . . . . 20  
 Mounting preparations . . . . . 26  
 Mounting tools . . . . . 26

## N

Nameplate  
   Sensor . . . . . 16  
   Transmitter . . . . . 15  
 Navigation path (navigation view) . . . . . 41  
 Navigation view  
   In the submenu . . . . . 41  
   In the wizard . . . . . 41  
 Numeric editor . . . . . 43

## O

Operable flow range . . . . . 128  
 Operating elements . . . . . 45, 104  
 Operating keys  
   see Operating elements  
 Operating menu  
   Menu, submenus . . . . . 38  
   Structure . . . . . 38  
   Submenus and user roles . . . . . 39  
 Operating philosophy . . . . . 39  
 Operation . . . . . 93  
 Operation options . . . . . 37  
 Operational display . . . . . 40  
 Operational safety . . . . . 10  
 Order code . . . . . 15, 16  
 Orientation (vertical, horizontal) . . . . . 21  
 Outlet runs . . . . . 21  
 Output . . . . . 128  
 Output signal . . . . . 128

## P

Packaging disposal . . . . . 19  
 Parameter  
   Changing . . . . . 49  
   Entering a value . . . . . 49  
 Parameter settings  
   Administration (Submenu) . . . . . 85  
   Burst configuration 1 to n (Submenu) . . . . . 58  
   Configuration backup display (Submenu) . . . . . 86  
   Current output 1 to n (Wizard) . . . . . 67  
   Data logging (Submenu) . . . . . 98  
   Device information (Submenu) . . . . . 115  
   Diagnostics (Menu) . . . . . 112  
   Display (Submenu) . . . . . 83  
   Display (Wizard) . . . . . 74  
   Low flow cut off (Wizard) . . . . . 78  
   Medium selection (Submenu) . . . . . 64  
   Output conditioning (Wizard) . . . . . 75  
   Output values (Submenu) . . . . . 96  
   Partially filled pipe detection (Wizard) . . . . . 79  
   Process variables (Submenu) . . . . . 94  
   Pulse/frequency/switch output (Wizard) 68, 69,  
     70, . . . . . 72  
   Sensor adjustment (Submenu) . . . . . 81  
   Setup (Menu) . . . . . 62  
   Simulation (Submenu) . . . . . 87  
   System units (Submenu) . . . . . 64  
   Totalizer (Submenu) . . . . . 95  
   Totalizer 1 to n (Submenu) . . . . . 82



- Totalizer handling (Submenu) . . . . . 97
- Zero point adjustment (Submenu) . . . . . 81
- Performance characteristics . . . . . 133
- Pharmaceutical compatibility . . . . . 145
- Post-connection check (checklist) . . . . . 36
- Post-installation check . . . . . 61
- Post-installation check (checklist) . . . . . 28
- Potential equalization . . . . . 33
- Power consumption . . . . . 132
- Power supply failure . . . . . 132
- Pressure loss . . . . . 139
- Pressure-temperature ratings . . . . . 138
- Process connections . . . . . 143
- Process variables
  - Calculated . . . . . 127
  - Measured . . . . . 127
- Product safety . . . . . 11
- Protecting parameter settings . . . . . 89
- R**
- RCM-tick symbol . . . . . 145
- Read access . . . . . 50
- Reading measured values . . . . . 93
- Recalibration . . . . . 118
- Reference operating conditions . . . . . 133
- Registered trademarks . . . . . 8
- Remedial measures
  - Calling up . . . . . 105
  - Closing . . . . . 105
- Remote operation . . . . . 144
- Repair . . . . . 119
- Repair of a device . . . . . 119
- Repairs
  - Notes . . . . . 119
- Repeatability . . . . . 135
- Replacement
  - Device components . . . . . 119
- Requirements for personnel . . . . . 9
- Response time . . . . . 135
- Return . . . . . 120
- Rupture disk
  - Safety instructions . . . . . 24
  - Triggering pressure . . . . . 139
- S**
- Safety . . . . . 9
- Sanitary compatibility . . . . . 145
- Sensor
  - Mounting . . . . . 26
- Sensor heating . . . . . 23
- Sensor housing . . . . . 138
- Serial number . . . . . 15, 16
- Setting the operating language . . . . . 61
- Settings
  - Adapting the measuring device to the process conditions . . . . . 97
  - Administration . . . . . 85
  - Advanced display configurations . . . . . 83
  - Current output . . . . . 67
  - Device reset . . . . . 115
  - Device tag . . . . . 62
  - Local display . . . . . 74
  - Low flow . . . . . 78
  - Managing the device configuration . . . . . 86
  - Medium . . . . . 64
  - Operating language . . . . . 61
  - Output conditioning . . . . . 75
  - Partial filled pipe detection . . . . . 79
  - Pulse output . . . . . 69
  - Pulse/frequency/switch output . . . . . 68, 70
  - Resetting the totalizer . . . . . 97
  - Sensor adjustment . . . . . 81
  - Simulation . . . . . 87
  - Switch output . . . . . 72
  - System units . . . . . 64
  - Totalizer . . . . . 82
  - Totalizer reset . . . . . 97
- Shock resistance . . . . . 138
- Showing data logging . . . . . 98
- Signal on alarm . . . . . 129
- SIL (functional safety) . . . . . 145, 146
- SIMATIC PDM . . . . . 55
  - Function . . . . . 55
- Software release . . . . . 56
- Spare part . . . . . 119
- Spare parts . . . . . 119
- Special connection instructions . . . . . 33
- Special mounting instructions
  - Sanitary compatibility . . . . . 24
- Standards and guidelines . . . . . 146
- Status area
  - For operational display . . . . . 40
  - In the navigation view . . . . . 42
- Status signals . . . . . 103, 106
- Sterilization in place (SIP) . . . . . 138
- Storage conditions . . . . . 18
- Storage temperature . . . . . 18
- Storage temperature range . . . . . 137
- Structure
  - Measuring device . . . . . 13
  - Operating menu . . . . . 38
- Submenu
  - Administration . . . . . 85
  - Advanced setup . . . . . 80
  - Burst configuration 1 to n . . . . . 58
  - Configuration backup display . . . . . 86
  - Data logging . . . . . 98
  - Device information . . . . . 115
  - Display . . . . . 83
  - Event list . . . . . 113
  - Measured values . . . . . 93
  - Medium selection . . . . . 64
  - Output values . . . . . 96
  - Overview . . . . . 39
  - Process variables . . . . . 94
  - Sensor adjustment . . . . . 81
  - Simulation . . . . . 87
  - System units . . . . . 64

- Totalizer . . . . . 95
- Totalizer 1 to n . . . . . 82
- Totalizer handling . . . . . 97
- Zero point adjustment . . . . . 81
- Supply unit
  - Requirements . . . . . 30
- Supply voltage . . . . . 30, 131
- Surface roughness . . . . . 143
- Symbols
  - For communication . . . . . 40
  - For correction . . . . . 43
  - For diagnostic behavior . . . . . 40
  - For locking . . . . . 40
  - For measured variable . . . . . 40
  - For measurement channel number . . . . . 40
  - For menus . . . . . 42
  - For parameters . . . . . 42
  - For status signal . . . . . 40
  - For submenu . . . . . 42
  - For wizard . . . . . 42
  - In the status area of the local display . . . . . 40
  - In the text and numeric editor . . . . . 43
- System design
  - Measuring system . . . . . 126
  - see Measuring device design
- System integration . . . . . 56
- System pressure . . . . . 22
- T**
- Technical data, overview . . . . . 126
- Temperature range
  - Medium temperature . . . . . 138
  - Storage temperature . . . . . 18
- Terminal assignment . . . . . 30, 32, 131
- terminal voltage . . . . . 30
- Terminals . . . . . 132
- Text editor . . . . . 43
- Thermal insulation . . . . . 22
- Tool tip
  - see Help text
- Tools
  - Electrical connection . . . . . 29
  - Installation . . . . . 26
  - Transport . . . . . 18
- Totalizer
  - Configuration . . . . . 82
- Transmitter
  - Connecting the signal cables . . . . . 32
  - Turning the display module . . . . . 27
  - Turning the housing . . . . . 27
- Transporting the measuring device . . . . . 18
- Troubleshooting
  - General . . . . . 101
- TSE/BSE Certificate of Suitability . . . . . 145
- Turning the display module . . . . . 27
- Turning the electronics housing
  - see Turning the transmitter housing
- Turning the transmitter housing . . . . . 27
- U**
- Use of the measuring device
  - Borderline cases . . . . . 9
  - Incorrect use . . . . . 9
  - see Designated use
- User interface
  - Current diagnostic event . . . . . 112
  - Previous diagnostic event . . . . . 112
- User roles . . . . . 39
- USP Class VI . . . . . 145
- V**
- Version data for the device . . . . . 56
- Vibration resistance . . . . . 137
- Vibrations . . . . . 23
- W**
- W@M . . . . . 118, 119
- W@M Device Viewer . . . . . 14, 119
- Weight
  - SI units . . . . . 140
  - Transport (notes) . . . . . 18
  - US units . . . . . 140
- Wizard
  - Current output 1 to n . . . . . 67
  - Display . . . . . 74
  - Low flow cut off . . . . . 78
  - Output conditioning . . . . . 75
  - Partially filled pipe detection . . . . . 79
  - Pulse/frequency/switch output . . . . . 68, 69, 70, 72
- Workplace safety . . . . . 10
- Write access . . . . . 50
- Write protection
  - Via access code . . . . . 89
  - Via write protection switch . . . . . 90
- Write protection switch . . . . . 90



[www.addresses.endress.com](http://www.addresses.endress.com)

---