



MICRO-CONTROLLER X



Type : PXF-2

Operation Manual

PLEASE READ FIRST

Please read the section “Safety Warnings” thoroughly before using. Safety precautions must be taken by every user to prevent accidents. Failure to comply with the instructions contained in this manual may reduce the safety of the instrument.

The safety requirements are classified into “Warning” and “Caution” according to the following interpretations:

 WARNING	Mishandling may lead to serious injury or death.
 CAUTION	Mishandling may result in personal injury or damage to the property.

WARNING

Installation and wiring

- ▶ This equipment is intended to be used under the following conditions.

Ambient temperature	-10 to 50°C
Operating humidity	90%RH or less (Non condensation)
Installation category:	II
Pollution degree:	2
Recommended fuse	250V AC, 0.1A T(Time-Lag) (AC100~240V) 400V DC/400V AC, 1A T(Time-Lag) (DC/AC24V)
Usage environment	Indoor use

- ▶ If accessible Safety Extra Low Voltage (SELV) circuits are to be connected to Signal input terminal, SSR drive output terminal, Current output terminal or Communication (RS485) terminal, ensure to provide a basic insulation between the SELV circuits and these terminals. For example, use transformer which has a basic insulation or higher degree of insulation.

If accessible Safety Extra Low Voltage (SELV) circuits are to be connected to Communication (RS-485) terminal, be sure to provide a basic insulation between these terminals.

For example, use a RS-485/232 converter which has a basic insulation.

The basic insulation requires a clearance at least 1.5 mm and a creepage of at least 3.0 mm.

Failure to maintain these minimum distances would invalidate the UL61010/EN61010 safety approval.

- ▶ For 24V DC/AC power supply model, if the equipment is connected to the Safety Extra Low Voltage (SELV) circuit, a basic insulation must be provided between the SELV circuit and the power input terminals. Otherwise, the power input terminals must be connect to Extra Low Voltage (ELV) circuit so as to prevent the electric shock.
- ▶ For CT input, use Current Transfer which has specification as shown below in order to prevent the electric shock and spread of fire.

1) Over Voltage Category	II
2) Pollution Degree	2
3) Required level of Insulating	BASIC INSULATION, SUPPLYMENTARY INSULATION, or REINFORCED INSULATION
4) Maximum Voltage line to neutral	300Vac rms or 300Vdc

About safety standard

Please observe the following instructions to meet the requirements of safety standard. Failure to observe these instructions violates safety standards.

(This product is not safety equipment.)

- Install a recommended fuse, which is specified in the instruction manual, between the external main power (Mains Circuit) and this equipment.

- Do not connect SELV directly to Signal input terminal, SSR Drive output terminal, Current output terminal, or Communication (RS-485) terminal. Otherwise, it may result in electrical shock.

If accessible Safety Extra Low Voltage (SELV) circuits are to be connected to Signal input terminal, SSR Drive output terminal, Current output terminal or Communication (RS-485) terminal, ensure to provide a basic insulation between the SELV circuits and these terminals. For example, use transformer which has a basic insulation or higher degree of insulation.

If accessible Safety Extra Low Voltage (SELV) circuits are to be connected to Communication (RS-485) terminal, be sure to provide a basic insulation between these terminals

For example, use a RS-485/232 converter which has a basic insulation.

The basic insulation requires a clearance at least 1.5 mm and a creepage of at least 3.0 mm.

- Be sure to install an appropriate external protective circuit to prevent excessive temperature rise etc.
- When performing wiring work, be sure to turn the power off and to wear protection gloves or safety glasses, to prevent an electric shock.
- Set proper parameter input signals which correspond to each input to be connected.
Be careful not to confuse voltage input with current input, or vice versa.
- Do not use this equipment for the measurement of circuits which falls under measurement categories II, III, or IV.
- Do not use this equipment for measurement of signals to which a voltage over 30 Vr.m.s. or over 60 V DC is applied.
- Be sure to use terminal covers. Before removing a terminal cover, turn off all the power.

- For the above, if voltage exceeds 50Vdc (called danger voltage), grounding and basic insulation for all terminals of the equipment and auxiliary insulation for DO outputs are required.

Note that the insulation class for this equipment is as follows. Before installing, please confirm that the insulation class for equipment meets usage requirements.

Type PXF4

Power (AC 100 - 250V)		Internal circuit	Power (DC/AC 24V)		Internal circuit
Control output 1 (Relay contact) or Motorized valve OPEN output		Measurement input Auxiliary analog input (remote SV) Heater current detector input	Control output 1 (Relay contact) or Motorized valve OPEN output		Measurement input Auxiliary analog input (remote SV) Heater current detector input
Control output 2 (Relay contact) or Motorized valve CLOSE output		Control output 1 (SSR drive, current, voltage) Control output 2 (SSR drive, current, voltage)	Control output 2 (Relay contact) or Motorized valve CLOSE output		Control output 1 (SSR drive, current, voltage) Control output 2 (SSR drive, current, voltage)
Digital output 1 (Relay contact)	Digital output 1 to 3 (Relay contact)	Digital input 1 to 3 Communication (RS-485)	Digital output 1 (Relay contact)	Digital output 1 to 3 (Relay contact)	Digital input 1 to 3 Communication (RS-485)
Digital output 2 (Relay contact)			Digital output 2 (Relay contact)		
(1)	(2)		(1)	(2)	

(1): When the ninth digit in the model code is J (Do1,2 are independent common)

(2): When the ninth digit in the model code is not J (Do1 to 3 shared common)

Type PXF5/9

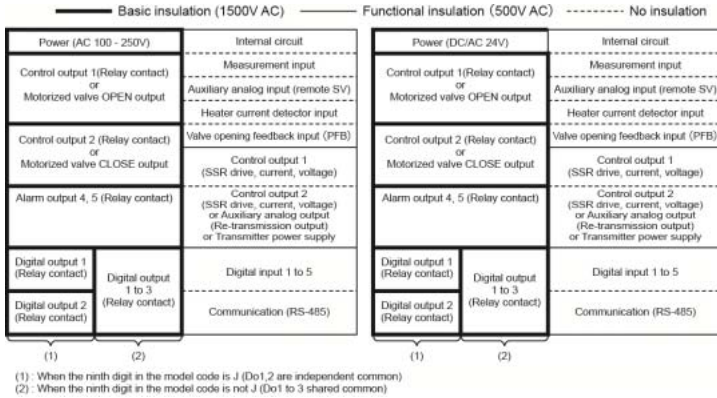

- In cases where damage or problems with this equipment may lead to serious accidents, install appropriate external protective circuits.
- As this equipment does not have a power switch or fuses, install them separately as necessary. If you install a fuse, be sure to place it between the main power switch and this equipment.
(Main power switch: 2-point Breaker, fuse rating: 250V 1A)
- A power switch or a circuit breaker should be installed within the power supply facility.
- A power switch or a circuit breaker should be properly installed within easy reach of an operator.
- A power switch or a circuit breaker should be identified as the one for this product.
- Electrical wiring must be made by the qualified personnel only and in accordance with your local and national standards.
- For power supply wiring, use wire equal to 600V vinyl insulation or above.
- To prevent damage and failure of the equipment, provide the rated power voltage.
- To prevent shock and equipment failure, do not turn the power ON until all wiring is complete.
- Before feeding power, confirm that clearance space has been secured to prevent shock and fire with the equipment.
- Do not touch the terminal while the machine is on. Doing so risks shock or equipment errors.
- Never disassemble, convert, modify or repair this equipment. Doing so carries the risk of abnormal operation, shock and fire.
- Output relays has limited-life. The contact of output relay may stay ON or OFF when it reaches the end of its service life. Be sure to provide an external protective circuit for safety.
- The factory default setting of this equipment is as follows. Change the setting as necessary so as the equipment to meet your application.
Please note that the improper settings may result in overheat or unexpected damage. For the details of operation, read this manual.

Control output 1: heating control

Control output 2 (optional): cooling control

Digital input 1 to 5 (optional): no function

- Symbols on the equipment
Please read this instruction manual thoroughly, and use the product accordingly.

Maintenance

- When installing and removing the equipment, turn the power OFF. Failing to do so may cause shock operational errors or failures.
- Periodic maintenance is recommended for continuous and safe use of this equipment.
- Some components used on this equipment have a limited life and/or may deteriorate over time.
- The warranty period for this unit (including accessories) is three year after the date of manufacture, if the product is used properly.

CAUTION

Cautions on installation

Avoid the following places for installation:

- A place where the ambient temperature may reach beyond the range of from 0 to 50°C while in operation.
- A place with rapid temperature changes, leading to dew condensation
- A place where corrosive gases (sulfide gas and ammonia gas, in particular) or combustible gases are emitted.
- A place with vibration or shock directly. (Vibration and shock may cause output relay malfunction.)
- A place exposed to water, oil, chemicals, steam and/or vapor.

(If the equipment gets wet, there is a risk of electric shock or fire, so have it inspected by the distributor.)

- A place where the unit is exposed to dust, salt air, or air containing iron particles.
- A place where the unit is subject to interference with static electricity, magnetism, and noise.
- A place where the unit is exposed to direct sunlight.
- A place where the heat may be accumulated due to the radiation of heat.

Recommended site condition:

- A place where the ambient humidity during operation is between 45 to 85%RH.

About EMC standard

- This equipment is designed as Class A (for industrial environment). Do not use this equipment in home environment, or it may cause electric jamming. If you use this equipment in home environment, install appropriate measures on the outside of the equipment.
- Under the requirement of EMC standard, the maximum length of a sensor to be connected to this equipment is 30 m. Do not connect the sensor longer than 30 m.

Caution on installation on panel

- Attach the included Fixtures (2 pieces) onto the top and bottom of PXF5/9 , and tighten them with a screwdriver. The clamp torque is approx. 0.15 N·m (1.5 kg·cm) The plastic fixture is designed such that over tightening will cause left/right cracking to the central area of the Fixtures and hence reduce the torque. Cracking to the central area will not cause any problems in terms of usability of the equipment as is.

(However, do exercise caution in not applying too much torque because the casing is made of plastic.)

- The front of this equipment is waterproof in compliance with NEMA-4X standards (IP66-equivalent). However, regarding waterproofing between the equipment and the panel, use the included packing to ensure waterproofing and attach it according to the guidelines below. (Incorrect attachment may cause the equipment to lose its waterproof capabilities.)

(1)As shown in Fig. 1, insert the panel after attaching the packing to the equipment case.

(2)As shown in Fig. 2, tighten the fixture screws so that no gaps can remain between the equipment face, the packing and the panels. Once finished, confirm that there are no changes in shape such as displaced or improperly-fitted packing, etc. as shown in Fig. 3.

- Please exercise caution if the panel strength is weak and gaps develop between the packing and the panel, as this will result in the loss of its waterproofing capabilities.

PXF4

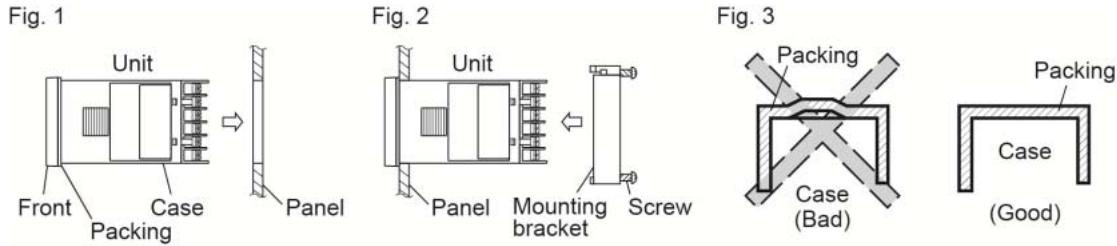

Mounting on vertical plane (in horizontal position)

PXF5/9

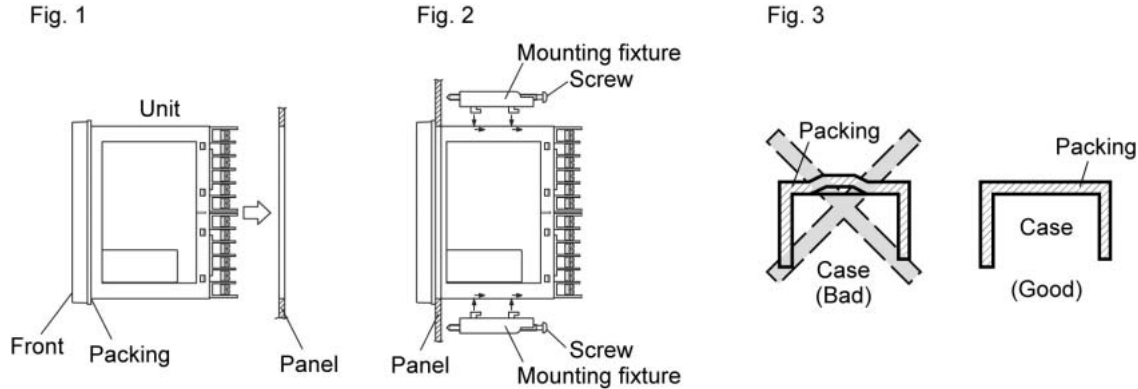

Mounting on vertical plane (in horizontal position)

Caution

- In order not to hamper heat radiation, do not block the sides of the equipment.
- Do not block the air vents on the upper part of the terminal.
- For PXF9, please attach the Fixtures to the attachment holes in the center of the main unit.

Cautions on wiring

- For thermocouple input, use the designated compensation lead; for resistance temperature sensors, use wires with small lead wire resistance and without any resistance difference among the three wires.
- To avoid noise conductor effects, do not use input signal wires in close proximity with electric power lines or load lines.
- Use the input signal lines and output signal lines that are separated from each other and are shielded.
- If there is a lot of noise from the power source, adding an insulation transducer and using a noise filter is recommended. Always attach a noise filter to a panel that is grounded securely, and keep the wiring between the noise filter output side and the measuring equipment power terminal wiring to a minimum length. Please do not attach fuses and switches, etc. to the noise filter output wiring since doing so will decrease the filter's effectiveness.
- Twisting the measuring instrument wiring is effective when connecting the wires. (The shorter the pitch of the twist, the more effective the connection is against noise.)
- When the power is turned on, it takes some time before a contact output starts operation. If using it as a signal to an external interlock circuit, please couple it with a delayed relay.
Concerning the output relay, connecting the maximum rated load will shorten the relay's life; so please attach an auxiliary relay. If the output operation frequency is high, selecting a SSR drive output type is recommended.
[Proportional cycles] Relay output: 30 seconds or more, SSR drive output: 1 second or more

(Example)

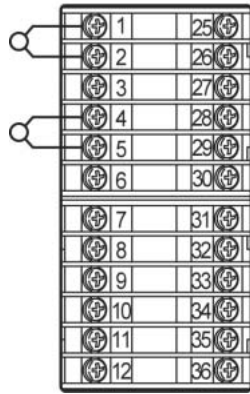

PXF5/9

(Example)

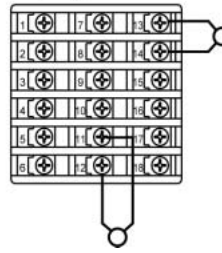

PXF4

- When inductive loads such as magnetic opening/closing equipment, etc. as relay output equipment are connected, use of a surge absorber is recommended in order to protect the connection points against opening/closing surges and to ensure long-term use.

Recommended specification for surge absorber

Voltage	Nominal varistor voltage
100 V	240 V
200 V	470 V

Key Operation Cautions/Error Operations

- The alarm function does not work properly when an error takes place unless the settings are made correctly. Always verify its setting before operation.
- If the input wiring breaks, the display will read "UUUU" or "LLLL". When replacing the sensor, always turn the power OFF.

Others

- Do not wipe the equipment with organic solvents such as alcohol or benzene, etc. If wiping is necessary, use a neutral cleaning agent.
- Do not use mobile phones near the instrument (within 50 cm). Otherwise malfunction may occur.
- Trouble may occur if the equipment is used near a radio, TV, or wireless device.
- Do not turn off the power right after you change the setting. If you turn off the power after setting change, be sure to wait for a few seconds before turning it off, so that the changed values can be stored on the nonvolatile memory.

Contents

PLEASE READ FIRST	1
Contents	8
For Proper Use	9
Model Specifications	10
1 Part names and functions	14
1-1 Digital characters	18
2 Basic Operation	19
2-1 Basic operation	19
2-2 Changing SV (set value)	20
2-3 Parameters List	21
3 Parameter functions and setting procedure	29
3-1 Operation mode	29
3-2 CH1 PID (Control parameters)	41
3-3 CH2 PLT (PID palette parameters)	57
3-4 CH3 PRG (Ramp soak parameters)	70
3-5 CH4 MON (Monitor parameters)	82
3-6 CH5 ALM (Alarm parameters)	100
3-7 CH6 SET (Setup parameters)	114
3-8 CH7 SYS (System parameters)	141
3-9 CH8 MATH (Calculation parameters)	162
3-10 CH9 COM (Communication parameters)	166
3-11 CH10 PFB (PFB parameter)	176
3-12 CH11 DSP (Parameter mask)	182
3-13 CH12 CFG (Configuration parameters)	183
3-14 CH13 PASS (Password parameters)	195
4 TROUBLESHOOTING	197

For Proper Use

Confirmation of model code	Please confirm that the model delivered matches your order. "Model Specifications" (page 10)
Installation and Mounting	External dimensions •Panel cutout • Panel mounting dimensions "3 Installation and Mounting" (instruction manual)
Wiring	Terminal connection diagram "4 Wiring" (instruction manual)
Power ON	
Display and Operations Parameters List Functions of the Temperature Controller	Changing set value Basic operations Parameters List Parameter setting "2-1 Basic operation" (page 19) "2-2 Changing SV (set value)" (page 20) "3-2 CH1 PID (Control parameters) " (page 41)
Advanced Usage	Setting of input sensor and input range Selecting control method Controlling through auto-tuning Parameter setting "3-7 CH6 SET (Setup parameters)" (page 114) "3-2 CH1 PID (Control parameters)" (page 41) "AT Auto tuning (005)" (page 33) "(4) Self tuning control (SELF) (3) Fuzzy control (FUZY)" (page 151)
Operation	
Error Indications	Display during equipment error "4 TROUBLESHOOTING" (page 197)

Caution

Wait 30 minutes for the controller to be stabilized thermally. Operations such as measurements should be started after the equipment has been energized at least for 30 minutes.

Model Specifications

<PXF4>

<48×48mm size>

PXF4 Standard Model List

PXF 4 5 6 7 8 9 10 11 12 13
 4 A 2 - 0 0

Digit	Description	Note	4	5	6	7	8	9	10	11	12	13
4	<Front panel size W×H> 48 × 48 mm		4									
5	-			A								
6	<Control output 1>											
	Relay contact (1a contact)	Note 1			A							
	Relay contact (1c contact)	Note 1			B							
	SSR drive output				C							
	Current output				E							
	Voltage output				P							
7	<Control output 2>											
	None					Y						
	Relay contact (1a contact)					A						
	SSR drive output					C						
	Current output					E						
	Voltage output					P						
	Re-transmission output (current)					R						
	Re-transmission output (voltage)				S							
8	<Revision code>						2					
9	<Alarm output>											
	None							0				
	1 point							1				
	2 points							F				
	3 points							M				
	Independent common 2 points							J				
10	<Power supply voltage/Instruction manual>											
	100~240V AC Japanese/English instruction manual							Y				
	100V/240V AC English instruction manual							V				
	100~240V AC Chinese/English instruction manual							W				
	24V AC/DC Japanese/English instruction manual							A				
	24V AC/DC English instruction manual							B				
	24V AC/DC Chinese/English instruction manual							D				
11	<Option>											
	None							Y				
	RS485							M				
	Digital input DI 1							S				
	RS 485 + digital input (DI 1)							V				
	Digital input + RSV1	Note 3						K				
	Digital input + CT1	Note 2						J				
12	-										0	0
13	-										0	0

Note 1: Not available for the 7th code "C", "E", "P", "R", "S".

However, if you want to order the 6th code "A" (SPST relay contact for the control output 1) and the 7th code "R" or "S" (current/voltage re-transmission output for the control output 2), specify the model as follows:

PXF4AA $\begin{matrix} R \\ S \end{matrix}$ 2-□□□02

Note 2: When using the CT input as a heater burnout alarm, add one alarm output for it in the 9th code.

Note 3: When using the current input for the remote SV input, add a 250-ohm resistor to the input terminal.

<48x48mm size>

Motorized Valve Control Model List

PXF 4 5 6 7 8 9 10 11 12 13
 4 A T Y 2 - 0 0

Digit	Description	Note
4	<Front panel size> 48x48mm	4
5	-	A
6	<Control output 1> Motorized valve Control output	T
7	<Control output 2> None	Y
8	<Revision code>	2
9	<Alarm output> None 1 point 2 points Independent common 2 points	0 1 F J
10	<Power supply voltage/Instruction manual> 100~240V AC Japanese/English instruction manual 100V/240V AC English instruction manual 100~240V AC Chinese/English instruction manual 24V AC/DC Japanese/English instruction manual 24V AC/DC English instruction manual 24V AC/DC Chinese/English instruction manual	Y V W A B D
11	<Option> None Digital input (DI 1, 2, 3) RS 485 + digital input (DI 1)	Y D V
12	-	0
13	-	0

<PXF5/9>

Standard Model List

Digit	Description	Note	4	5	6	7	8	9	10	11	12	13
4	<Front panel size W×H> 48×96mm 96×96mm		↓ 5 9									
5	-			A								
6	<Control output 1> Relay contact (1a contact) Relay contact (1c contact) SSR drive output ----- Current output Voltage output				↓ A B C ----- E P							
7	<Control output 2> None Relay contact (1a contact) SSR drive output ----- Current output Voltage output Re-transmission output (current) Re-transmission output (voltage)					↓ Y A C ----- E P R S						
8	<Revision code>						2					
9	<Alarm output> None 1 point 2 points ----- 3 points Independent common 2 points							↓ 0 1 ----- F ----- M J				
10	<Power supply voltage/Instruction manual> 100~240V AC Japanese/English instruction manual 100V/240V AC English instruction manual 100~240V AC Chinese/English instruction manual ----- 24V AC/DC Japanese/English instruction manual 24V AC/DC English instruction manual 24V AC/DC Chinese/English instruction manual							↓ Y V ----- W ----- A B D				
11	<Option> None RS485 Digital input (DI 1, 2) Digital input + RSV1 (DI 3) ----- Digital input + CT1 (DI 1) RS 485 + digital input (DI 1) RS 485 + digital input (DI 3, 4, 5) + Auxiliary alarm output (AL 4, 5)	Note 2 Note 1						↓ Y M T ----- H ----- G V C				
12	-										↓	0
13	-										↓	0

Note 1: When using the CT input as a heater burnout alarm, add one alarm output for it. (Add one point in the 9th code.)
Note 2: When a current input is used, a resistance of 250 Ω is required at the input terminal.

Motorized Valve Control Model List

Digit	Description	Note	4	5	6	7	8	9	10	11	12	13
4	<Front panel size> 48×96mm 96×96mm											
5	—											
6	<Control output 1> Motorized valve Control output (no PFB input) Motorized valve Control output (PFB input)											
7	<Control output 2> None											
8	<Revision code>											
9	<Alarm output> None 1 point 2 points 3 points Independent common 2 points											
10	<Power supply voltage/Instruction manual> 100~240V AC Japanese/English instruction manual 100V/240V AC English instruction manual 100~240V AC Chinese/English instruction manual 24V AC/DC Japanese/English instruction manual 24V AC/DC English instruction manual 24V AC/DC Chinese/English instruction manual											
11	<Option> None RS 485 + digital input (DI 1, 2, 3)											
12	-											
13												

PXF

4	5	6	7	8	9	10	11	12	13
A		Y	2	-				0	0

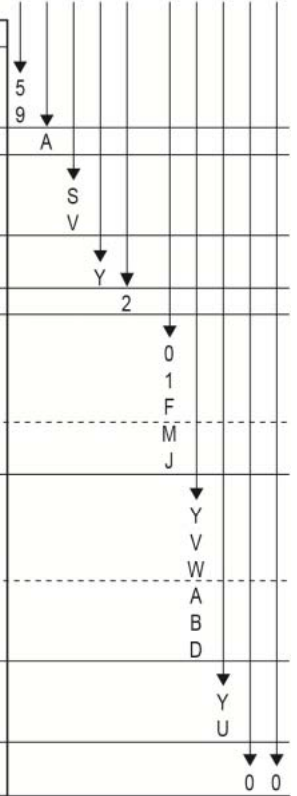

1 Part names and functions

This section describes the names and functions of each part of the front panel. The front panel has the PV and SV displays, the status indicator lamps, and the setting keys, etc. Their functions are explained below. Please read and understand them before using the PXF.

For details about the setting of parameters, see Chapter 2.

<PXF4>

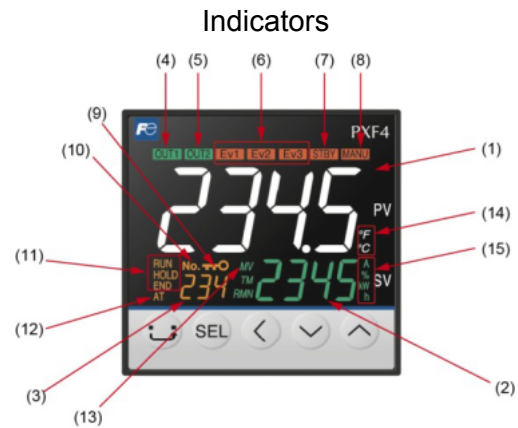

USER key

- Press this key once in PV/SV display to switch between SV display and MV display.
- Press and hold this key in PV/SV display to start the assigned function. (No function is allocated at the factory.)
- Press this key once in operation control mode, channel-selection mode, or setup mode to return to PV/SV display.

SEL key

- Press this key once in PV/SV display to move to operation control mode.
- Press and hold this key in setup mode to move to channel selection mode.
- Press this key once in channel selection mode to move to setup mode.
- Press and hold this key in setup mode to move to channel selection mode.
- Press this key once in parameter selection submode of setup mode to enter parameter editing submode.
- Press this key once in parameter editing submode to save the change and return to parameter selection submode.

< key

- Use the this key to select the digit when changing values.

v^ key

- Use the this key to change SV value when in PV/SV screen.
- During in operation control mode, channel selection mode, or setup mode, this key allows you to change parameters to be displayed.
- During in parameter setting mode, this key allows you to change parameter settings.

(1) Indicates process value (PV)

Shows parameter name when in parameter setting.

(2) Set point (SV)

Shows set value. Shows parameter set point when in parameter setting.

(3) Screen No.

Shows screen No. when in parameter setting.

(4) OUT1 indicator

Lights during control output 1 is ON.

(5) OUT2 indicator

Lights during control output 2 is ON.

(6) EV 1, EV 2, EV 3 indicators

Lights during digital output 1 to 3 are ON.

(7) STBY indicator

Lights during standby.

(8) MANU indicator

Lights during manual mode.

(9) Lock indicator

Lights during key lock.

(10) No. indicator

Lights during a screen No. is displayed.

(11) RUN/HOLD/END indicators

Lights during ramp/soak operation.

(12) AT indicator

Lights during auto tuning.

(13) MV indicator

Lights during MV is displayed on SV display.

(14)°C/°F indicator

Shows the temperature unit under use.

USER + ^ key

- Press and hold this key in PV/SV display to start the assigned function.
(The factory set function for this key is switching between RUN and standby.)

USER + v key

- Press and hold this key in PV/SV display to start the assigned function.
(The factory set function for this key is switching between start/stop of auto-tuning.)

(15) A, %, kW/h indicator

Shows the unit being applied to values on SV display during the operation mode.

<PXF5/9>

Operation keys

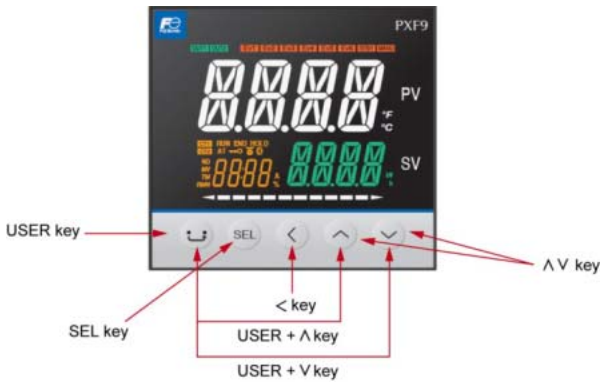

Indicators

PXF5

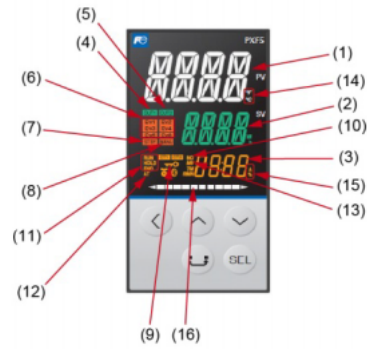

PXF9

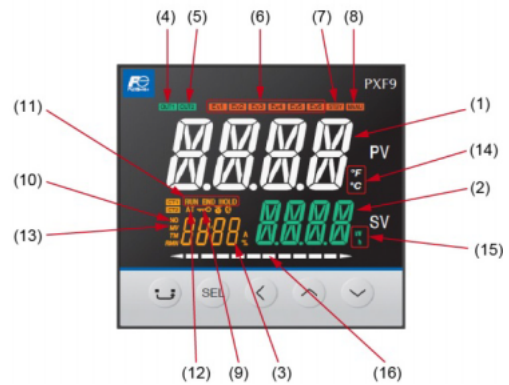

USER key

- Press this key once in PV/SV display to switch between SV display and MV display.
- Press and hold this key in PV/SV display to start the assigned function. (No function is allocated at the factory.)
- Press this key once in operation control mode, channel-selection mode, or setup mode to return to PV/SV display.

SEL key

- Press this key once in PV/SV display to move to operation control mode.
- Press and hold this key in setup mode to move to channel selection mode.
- Press this key once in channel selection mode to move to setup mode.
- Press and hold this key in setup mode to move to channel selection mode.
- Press this key once in parameter selection submode of setup mode to enter parameter editing submode.
- Press this key once in parameter editing submode to save the change and return to parameter selection submode.

< key

- Use the this key to select the digit when changing values.

∧ key

- Use the this key to change SV value when in PV/SV screen.
- During in operation control mode, channel selection mode, or setup mode, this key allows you to change parameters to be displayed.
- During in parameter setting mode, this key allows you to change parameter settings.

(1) Indicates process value (PV)

Shows parameter name when in parameter setting.

(2) Set point (SV)

Shows set value. Shows parameter set point when in parameter setting.

(3) Screen No.

Shows screen No. when in parameter setting.

(4) OUT1 indicator

Lights during control output 1 is ON.

(5) OUT2 indicator

Lights during control output 2 is ON.

(6) EV 1, EV 2, EV 3 indicators

Lights during digital output 1 to 3 are ON.

(7) STBY indicator

Lights during standby.

(8) MANU indicator

Lights during manual mode.

(9) Lock indicator

Lights during key lock.

(10) No. indicator

Lights during a screen No. is displayed.

(11) RUN/HOLD/END indicators

Lights during ramp/soak operation.

(12) AT indicator

Lights during auto tuning.

(13) MV indicator

Lights during MV is displayed on SV display.

(14) °C/°F indicator

Shows the temperature unit under use.

USER + ^ key

- Press and hold this key in PV/SV display to start the assigned function.
(The factory set function for this key is switching between RUN and standby.)

USER + v key

- Press and hold this key in PV/SV display to start the assigned function.
(The factory set function for this key is switching between start/stop of auto-tuning.)

(15) A, %, kW/h indicator

Shows the unit being applied to values on SV display during the operation mode.

(16) Bar graph

Shows MV.

1-1 Digital characters

The following tables provide correspondence between digital characters used for the display of the controller and alphanumerical characters. (See the following table for details.)

Alphabet	Digital characte	Alphabet	Digital characte	Alphabet	Digital characte
A	<i>A</i>	K	<i>K</i>	U	<i>U</i>
B	<i>b</i>	L	<i>L</i>	V	<i>V</i>
C	<i>C</i>	M	<i>M</i>	W	<i>W</i>
D	<i>d</i>	N	<i>N</i>	X	<i>X</i>
E	<i>E</i>	O	<i>o</i>	Y	<i>Y</i>
F	<i>F</i>	P	<i>P</i>	Z	—
G	<i>G</i>	Q	—		
H	<i>H</i>	R	<i>R</i>		
I	<i>I</i>	S	<i>S</i>		
J	—	T	<i>t</i>		

Number characte	Digital characte	Number characte	Digital characte
1	<i>1</i>	6	<i>6</i>
2	<i>2</i>	7	<i>7</i>
3	<i>3</i>	8	<i>8</i>
4	<i>4</i>	9	<i>9</i>
5	<i>5</i>	0	<i>0</i>

2 Basic Operation

2-1 Basic operation

The below figure illustrates the mode transition and the key operations.

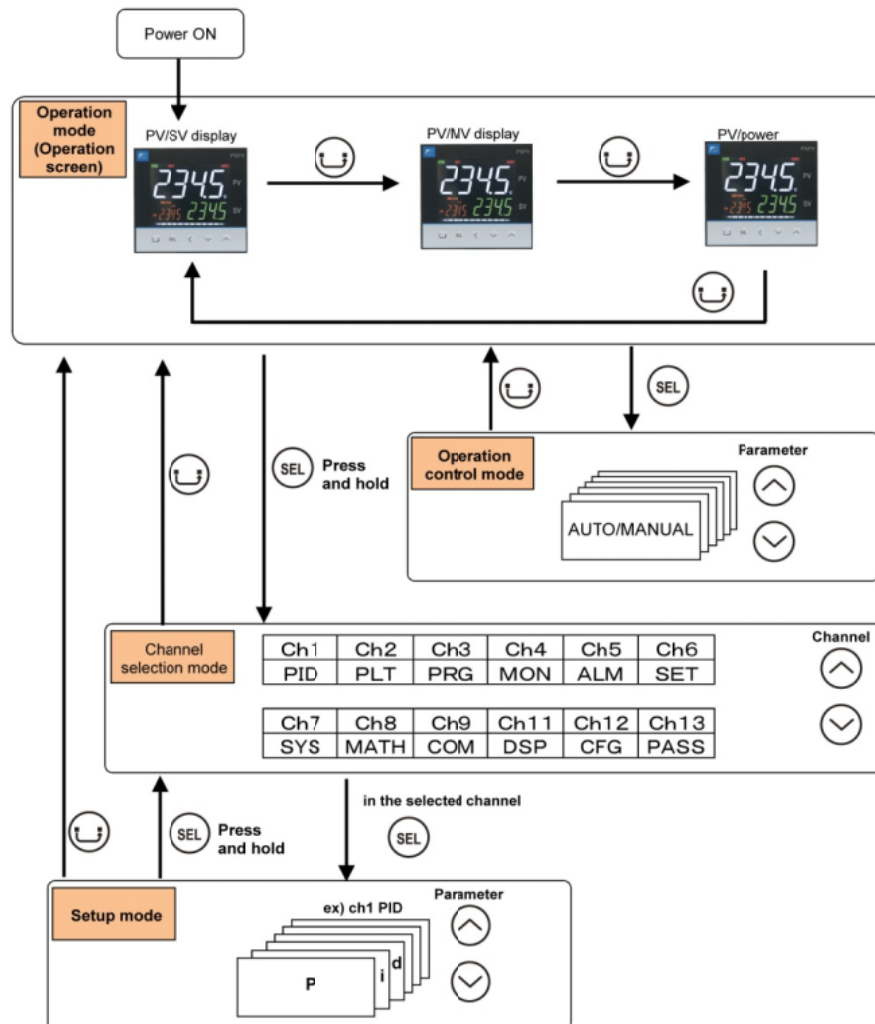

Operation mode

In this mode the normal operation is performed. The process value (PV) and the set value (SV) are displayed. The device starts in this mode when you turn on the power. You can change the set value (SV) in this mode. You can check the output value (MV) and the amount of electric power by switching the screen.

Operation control mode

In this mode you can put the device to standby or change the alarm set value.

Channel selection mode

In this mode you can select the parameter channel to be displayed.

Setup mode

In this mode you can setup each parameter. This mode includes the parameter selection submode and the parameter editing submode, which can be switched by SEL key. In the parameter selection submode, you can switch between parameters by using Δ ∇ keys. In the parameter editing submode, you can change parameter values by using Δ ∇ keys.



2-2 Changing SV (set value)

[Description] _____

- The SV is a target value for control.
- SV must be within the range between SVL (lower limit) and SVH (upper limit) which belong to Pid parameter.

Related parameters: SVL (page 50), SVH (page 50)

[Setting example] Changing the SV from 250°C to 1195°C _____

Display	Operating procedure				
<table border="1"><tr><td data-bbox="108 651 331 719">2 4 5</td><td data-bbox="336 651 384 719">PV</td></tr><tr><td data-bbox="108 725 331 786">250</td><td data-bbox="336 725 384 786">SV</td></tr></table>	2 4 5	PV	250	SV	<ol style="list-style-type: none">1. Check that the PV/SV display is shown.2. Press   key to change SV to “1195”.3. Press the SEL key to save the change. (The change will be saved after three seconds, even if you do not press any key.)
2 4 5	PV				
250	SV				
<table border="1"><tr><td data-bbox="108 853 331 920">2 4 5</td><td data-bbox="336 853 384 920">PV</td></tr><tr><td data-bbox="108 927 331 981">1195</td><td data-bbox="336 927 384 981">SV</td></tr></table>	2 4 5	PV	1195	SV	
2 4 5	PV				
1195	SV				

2-3 Parameters List

The following explains each channel parameter.

- The range of the parameters in the shaded area indicates the industrial values. When you change the PV input lower limit (Pvb), PV input upper limit (PvF), or decimal place position (Pvd), reconfigure all the industrial values.
- When the parameter that has [RESET] on its Remarks column is changed, turn off the power once, and then re-start the controller.

Operation control parameter						
No	Display	Parameter Name	Function	Setting range	Initial value	Remarks
001	MAN	Switchover between auto and manual mode	Switchover between auto and manual modes	oFF (auto) / on(manual)	oFF	This parameter is not displayed in default setting. If you need to change this parameter, change the setting of "Ch11 dSP" so that it appears.
002	Stby	Switchover between RUN and standby	Switchover the operation mode between RUN and standby	oFF(RUN) / on(standby)	oFF	
003	REM	Local/remote switchover	Switches SV between local/remote.	LoCL (local) / REM (remote)	LoCL	
004	PRG	Ramp soak control command	Changes ramp soak run states	oFF (stop)/Un (run)/hLd (hold)	oFF	Displays End (when ending) or GS (during guaranty soak).
005	RL	Auto-tuning run command	Runs auto-tuning.	oFF (stop/finish)on (normal type)Lo (low PV type)	oFF	
006	LRLH	Alarm output latch release command	Cancels the alarm output latch state	oFF / rST (latch resets)	oFF	
007	SVH	SV selection	Chooses the SV No. used for control	LoCL Sv1 Sv2 Sv3 Sv4 Sv5 Sv6 Sv7 ⊘ (chooses SV according to DI)	LoCL	"When changing the SV with the front key, do not change the "SvM" parameter via communication. Otherwise, the changed SV may not be stored correctly."
008	PLM	PID selection	Chooses the PID No. used for control	LoCL (PID ch) Pid 1 (PID group No. 1) Pid 2 (PID group No. 2) Pid 3 (PID group No. 3) Pid 4 (PID group No. 4) Pid 5 (PID group No. 5) Pid 6 (PID group No. 6) Pid 7 (PID group No. 7) ⊘ (chooses PID group according to DI)	LoCL	
009	AL1	ALM1 set value	Sets the alarm value for ALM1.	Absolute value alarm: 0 to 100% FS Deviation alarm: -100 to 100% FS	2.50%FS	
010	AL1-L					
011	AL1-H	ALM2 set value	Sets the alarm value for ALM2.	Absolute value alarm: 0 to 100% FS Deviation alarm: -100 to 100% FS	2.50%FS	
012	AL2					
013	AL2-L	ALM3 set value	Sets the alarm value for ALM3.	Absolute value alarm: 0 to 100% FS Deviation alarm: -100 to 100% FS	2.50%FS	
014	AL2-H					
015	AL3	ALM4 set value	Sets the alarm value for ALM4.	Absolute value alarm: 0 to 100% FS Deviation alarm: -100 to 100% FS	2.50%FS	
016	AL3-L					
017	AL3-H	ALM5 set value	Sets the alarm value for ALM5.	Absolute value alarm: 0 to 100% FS Deviation alarm: -100 to 100% FS	2.50%FS	
018	AL4					
019	AL4-L	ALM5 set value	Sets the alarm value for ALM5.	Absolute value alarm: 0 to 100% FS Deviation alarm: -100 to 100% FS	2.50%FS	
020	AL4-H					
021	AL5	ALM5 set value	Sets the alarm value for ALM5.	Absolute value alarm: 0 to 100% FS Deviation alarm: -100 to 100% FS	2.50%FS	
022	AL5-L					
023	AL5-H					
027	ALMd	Electric power calculation command	Switches among on/off/hold of electric power calculation.	oFF (stop calculation) rUn (run calculation) hLd (suspend calculation)	oFF	
028	LoL	Key lock	Sets the key lock to prevent wrong operation	oFF (no lock) ALL (all lock) PARA (All but SV locked)	oFF	

Ch1 PID (control parameters)						
No	Display	Parameter Name	Function	Setting range	Initial value	Remarks
050	P	Proportional band (%)	Sets the proportional band of the PID parameter.	0.1 to 999.9%	5.0%	
051	I	Integration time	Sets the integration time of the PID parameter. Setting "0" will turn off integration.	0 to 3200 sec	240 sec	
052	D	Differential time	Sets the differential band of the PID parameter. Setting "0" will turn off differentiation.	0.0 to 999.9 sec	60.0 sec	
053	HYS	ON/OFF control hysteresis	Sets the hysteresis width for the ON/OFF control.	0 to 50%FS	0.25%FS	
054	CoL	ON/OFF control hysteresis	Sets the proportional band coefficient for cooling. Setting "0.0" will turn the cooling into an ON/OFF control.	0.0 to 100.0	1.0	
055	db	Dead band (%)	Shifts the cooling proportional band from the set value	-50.0 to 50.0%	0.0%	
056	bAL	Output convergence value (%)	Offset value which is added to the M/ output value	-100.0 to 100.0%	0/50 (single/dual)	
057	RR	Anti-reset windup	Sets the range of integration control	0 to 100%FS	100%FS	
058	REV	Normal/reverse operation	Selects single control or dual control. Sets the control action (normal or reverse).	rv- (heat (reverse)/cool (none)) no- (heat (normal)/cool (none)) rvno (heat (reverse)/cool (normal)) norv (heat (normal)/cool (reverse)) rvrv (heat (reverse)/cool (reverse)) nono (heat (normal)/cool (normal))	rv- /rvno (single/dual)	[RESET]
059	SVL	SV limit (lower)	Sets the lower limit of SV	0 to 100%FS	0.00%FS	Note 1)
060	SVH	SV limit (upper)	Sets the upper limit of SV	0 to 100%FS	100.00%FS	Note 1)
061	LCC1	OUT1 proportion cycle	Sets the proportion cycle of the control output (OUT1) (contacts, SSR drive)	1 to 150 sec	30 (relay) 2 (SSR) 1 (current)	
062	LCC2	OUT2 proportion cycle	Sets the proportion cycle of the control output (OUT2) (contacts, SSR drive)	1 to 150 sec	30 (relay) 2 (SSR) 1 (current)	
063	PLC1	OUT1 lower limit	Sets the lower limit of the control output(OUT1)	-5.0 to 105.0%	-5.0%	
064	PHE1	OUT1 upper limit	Sets the upper limit of the control output(OUT1)	-5.0 to 105.0%	105.0%	
065	PLC2	OUT2 lower limit	Sets the lower limit of the control output(OUT2)	-5.0 to 105.0%	-5.0%	
066	PHE2	OUT2 upper limit	Sets the upper limit of the control output(OUT2)	-5.0 to 105.0%	105.0%	
067	PCLT	Type of output limiter	Sets the type of output limiter	0 to 15	0	
073	ALPA	Alpha	Sets 2-degrees of freedom coefficient α	-199.9to 300.0%	40.0%	
074	BETA	Beta	Sets 2-degrees of freedom coefficient β	0.0 to 999.9%	100.0%	

Note 1: "SVL" and "SVH" must be set so that SvL < SvH. When you change the values for "SVL" and "SVH", check SV 1 ("Sv1 Ch2") through SV 7 ("Sv7 Ch2").

Ch2 PLT (PID palette parameters)

Parameter		Function	Setting range	Initial value	Remarks
No	Display Name				
100	<i>Sv1</i>	SV1	Sets the SV (set value)	SV limit (lower)(SVL) to SV limit (upper)(SVH) %FS	0%FS Note 1)
101	<i>P</i>	Proportional band 1 (%)	Sets the proportional band.	0.1 to 999.9%	5.0%
102	<i>i</i>	Integration time 1	Sets the integration time.	0 to 3200 sec	240 sec
103	<i>d</i>	Differential time 1	Sets the differential time.	0.0 to 999.9 sec	60.0 sec
104	<i>HYS</i>	ON/OFF control hysteresis 1	Sets the hysteresis when using the ON/OFF control.	0 to 50%FS	0.25%FS
105	<i>CoL</i>	Cooling proportional band 1 (%)	Sets the cooling proportional band.	0.0 to 100.0	1.0
106	<i>db</i>	Dead band 1 (%)	Sets the dead band	-50.0 to 50.0%	0.0%
107	<i>bRL</i>	Output convergence value 1 (%)	Offset value which is added to the control output	-100.0 to 100.0%	0/50 (single/dual)
108	<i>RP</i>	Anti-reset windup 1	Sets the anti-reset windup	0 to 100%FS	100%FS
109	<i>REV</i>	Normal/reverse 1	Selects single control or dual control. Sets the control action (normal or reverse).	rv- (heat (reverse)/cool (none)) no- (heat (normal)/cool (none)) rno (heat (reverse)/cool (normal)) rnv (heat (normal)/cool (reverse)) rvv (heat (reverse)/cool (reverse)) nono (heat (normal)/cool (normal))	rv- /rvno (single/dual) Note 2) [RESET]
.
.
160	<i>Sv7</i>	SV 7	Sets the SV (set value)	SV limit (lower)(SVL) to SV limit (upper)(SVH) %FS	0%FS Note 1)
161	<i>P7</i>	Proportional band 7 (%)	Sets the proportional band.	0.1 to 999.9%	5.0%
162	<i>i7</i>	Integration time 7	Sets the integration time.	0 to 3200 sec	240 sec
163	<i>d7</i>	Differential time 7	Sets the differential time.	0.0 to 999.9 sec	60.0 sec
164	<i>HYS7</i>	ON/OFF control hysteresis 7	Sets the hysteresis when using the ON/OFF control.	0 to 50%FS	0.25%FS
165	<i>CoL7</i>	Cooling proportional band 7 (%)	Sets the cooling proportional band.	0.0 to 100.0	1.0
166	<i>db7</i>	Dead band 7 (%)	Sets the dead band	-50.0 to 50.0%	0.0%
167	<i>bRL7</i>	Output convergence value 7 (%)	Offset value which is added to the control output	-100.0 to 100.0%	0/50 (single/dual)
168	<i>RP7</i>	Anti-reset windup 7	Sets the anti-reset windup	0 to 100%FS	100%FS
169	<i>REV7</i>	Normal/reverse 7	Selects single control or dual control. Sets the control action (normal or reverse).	rv- (heat (reverse)/cool (none)) no- (heat (normal)/cool (none)) rno (heat (reverse)/cool (normal)) rnv (heat (normal)/cool (reverse)) rvv (heat (reverse)/cool (reverse)) nono (heat (normal)/cool (normal))	rv- /rvno (single/dual) Note 2) [RESET]
170	<i>REF1</i>	PID switching point 1	Sets the PID switching point for palette 1.	0 to 100%FS	0%FS
.
.
176	<i>REF7</i>	PID switching point 7	Sets the PID switching point for palette 7.	0 to 100%FS	0%FS
177	<i>SvH#</i>	Max SV selection number	Choosing SV with the user key sets it to the maximum possible number.	LoCL Sv1 Sv2 Sv3 Sv4 Sv5 Sv6 Sv7 dl (depending on DI)	Sv7
178	<i>PL #</i>	Max PID selection number	Choosing PID with the user key sets it to the maximum possible number.	LoCL Pid1 Pid2 Pid3 Pid4 Pid5 Pid6 Pid7 dl (chooses PID according to DI)	Pid7

Note 1: "SvL" and "Svh" must be set so that SvL < SvH. When you change the values for "SvL" and "Svh", check SV 1 ("Sv1 Ch2") through SV 7 ("Sv7 Ch2").

Note 2: Set the same value as the one for the Normal/Reverse setting ("rEv Ch1").

Ch 3 PRG (ramp soak parameters)

No	Display	Parameter		Function	Setting range	Initial value	Remarks
		Name					
200	PLH	Ramp soak operation pattern (Step No.)		Sets which steps to use in the ramp soak operation pattern	0 (uses steps 1 to 8) 1(uses steps 9 to 16) 2(uses steps 17 to 24) 3(uses steps 25 to 32) 4(uses steps 33 to 40) 5(uses steps 41 to 48) 6(uses steps 49 to 56) 7(uses steps 57 to 64) 8(uses steps 0 to 16) 9(uses steps 17 to 32) 10(uses steps 33 to 48) 11(uses steps 49 to 64) 12(uses steps 0 to 32) 13(uses steps 33 to 64) 14(uses steps 0 to 64) di (depending on DI)	14	Note 1)
201	LMU	Ramp soak time units		Sets the units of the ramp soak time	hh.MM (hour:min) MM.SS (min:sec)	hh.MM	
202	$SV-1$	Ramp soak 1 seg/SV 1		Sets the SV	0 to 100%FS	0%FS	
203	LMR	Ramp soak 1 seg ramp time		Sets the ramp time.	00:00 to 99:59 (hour:min/min:sec)	00:00	
204	LS	Ramp soak 1 seg soak time		Sets the soak time.	00:00 to 99:59 (hour:min/min:sec)	00:00	
205	$SV-2$	Ramp soak 2 seg/SV 2		Sets the SV	0 to 100%FS	0%FS	
206	LMR	Ramp soak 2 seg ramp time		Sets the ramp time.	00:00 to 99:59 (hour:min/min:sec)	00:00	
.
389	LMR	Ramp soak 63 seg ramp time		Sets the ramp time.	00:00 to 99:59 (hour:min/min:sec)	00:00	
390	LS	Ramp soak 63 seg soak time		Sets the soak time.	00:00 to 99:59 (hour:min/min:sec)	00:00	
391	$SV-64$	Ramp soak 64 seg/SV 64		Sets the SV	0 to 100%FS	0%FS	
392	LMR	Ramp soak 64 seg ramp time		Sets the ramp time.	00:00 to 99:59 (hour:min/min:sec)	00:00	
393	LS	Ramp soak 64 seg soak time		Sets the soak time.	00:00 to 99:59 (hour:min/min:sec)	00:00	
394	Mod	Ramp soak mode		Sets the program operation method	0 to 15	0	
395	$LSOH$	Guaranty soak ON/OFF		Sets the guaranty soak ON or OFF	oFF (guaranty soak off) on (guaranty soak on)	oFF	
396	$LS-L$	Guaranty soak band (Lower)		Sets the lower limit of guaranty soak	0 to 50%FS	1.25%FS	
397	$LS-H$	Guaranty soak band (Upper)		Sets the upper limit of guaranty soak	0 to 50%FS	1.25%FS	
398	$PVSt$	PV start		Sets whether or not to start ramp soak with PV.	oFF (PV start off) on (PV start on)	oFF	
399	CaM	Restore mode		Sets how to restart when the controller is restored after a power loss.	rES (Reset) Con (Continue) ini (Restart)	rES	
400	PLM	Max pattern selection		Sets the maximum pattern number selectable by using the user key.	0 to 14	14	
401	PLM	Min pattern selection		Sets the minimum pattern number selectable by using the user key.	0 to 14	0	

Note 1: Do not change this parameter during the ramp soak operation. Be sure to set "PRG" = "oFF" before changing the parameter

Ch 4 MON (monitor parameters)

No	Parameter		Function	Setting range	Initial value	Remarks
	Display	Name				
420	SLRL	Ramp soak progress	Displays the progress of the ramp soak	oFF (ramp soak stopped) 1-rP (ramp in step 1) 1-Sk (soak in step 1) 64rP (ramp in step 64) 64Sk (soak in step 64) End (ramp soak finished)	—	
421	MV1	MV1(%)	Displays the output value of the control output (OUT1)	-5.0 to 105.0%	—	
422	MV2	MV2(%)	Displays the output value of the control output (OUT2)	-5.0 to 105.0%	—	
423	PFB	PFB input value (%)	Displays the position feedback input value.	-10.0 to 110.0%	—	
424	RSV	Remote SV	Shows a remote SV.	-5 to 105%FS	—	
425	LtI	Heater current (A)	Shows a heater current value. (A current value when OUT1 is ON.)	0 to 110.0 A	—	
427	LtI	SSR leak current (A)	Shows a leak current value. (A current value when OUT1 is OFF.)	0 to 110.0 A	—	
429	EM1	Remaining time on timer 1	Displays the remaining time on timer 1	0 to 9999 sec/ 0 to 9999 min	—	
430	EM2	Remaining time on timer 2	Displays the remaining time on timer 2	0 to 9999 sec/ 0 to 9999 min	—	
431	EM3	Remaining time on timer 3	Displays the remaining time on timer 3	0 to 9999 sec/ 0 to 9999 min	—	
432	EM4	Remaining time on timer 4	Displays the remaining time on timer 4	0 to 9999 sec/ 0 to 9999 min	—	
433	EM5	Remaining time on timer 5	Displays the remaining time on timer 5	0 to 9999 sec/ 0 to 9999 min	—	
435	COM	Communication status	Displays the communication status.	0 to 9999 times (number of communication times)	—	
436	IUP	Current (A)	Shows a value measured by CT.	0 to 110.0 A	—	
438	POH	Electric power	Shows a calculated amount of electric power.	0.0 to 9999 KW	—	
439	HHH	Power	Displays the calculated amount of electric power.	0.0 to 999.9 Wh	—	
440	RCN1	Number of operating times (control relay 1)	Displays the number of times that control relay 1 has operated.	0 to 9999k times	—	
441	RCN2	Number of operating times (control relay 2)	Displays the number of times that control relay 2 has operated.	0 to 9999k times	—	
442	RUNL	Operating days	Displays the number of days operated, converted from total operating time.	0 to 5000 days	—	
443	FRLE	Error source	Displays the source of an error	0 bit: PV input underflow (LLLL) 1 bit: PV input overflow (UUUU) 2 bit: PV underrange 3 bit: PV overrange 4 bit: RSV underrange 5 bit: RSV overrange 6 bit: Range setting error 8 bit: PV input circuit error 9 bit: R-SV input circuit error 10 bit: CT/PFB input circuit error 11 bit: PFB input underrange 12 bit: PFB input overrange	—	
444	dI	DI input state	Displays the state of DI.	0 bit: DI1 1 bit: DI2 2 bit: DI3	—	
445	EPSE	Communication error station number	Shows the station number under a cooperative communication error or a programless communication error.	1 to 31	—	
446	PLNo	Current PID No.	Displays the currently used PID number.	0 to 7	—	
447	PLNo	Current pattern No.	Displays the ramp soak pattern number being used.	0 to 15	—	

Ch 5 ALM (alarm parameters)

No	Parameter		Function	Setting range	Initial value	Remarks
	Display	Name				
470	ALP	ALM1 alarm type	Set the alarm type for ALM1.	0 to 47	0	Refer to section 11 for the detail.
471	AHY	ALM1 hysteresis	Sets the hysteresis for alarm output 1 ON/OFF	0 to 50%FS	0.25%FS	
472	dLY1	ALM1 delay	Sets the delay before detecting alarm output 1	0 to 9999 [sec/min]	0	
473	dLU	ALM1 delay time units	Sets the delay time units for alarm output 1	sec (second)/Min (minute)	sec	
474	RoP1	ALM1 option function	Assigns the optional functions to ALM1 Ones digit: alarm output latch Tens digit: error alarm Hundreds digit: inverted output Thousands digit: hold reset	0000 to 1111	0000	
.
490	ALP	ALM5 alarm type	Set the alarm type for ALM5.	0 to 58	0	Refer to section 11 for the detail.
491	AHY	ALM5 hysteresis	Sets the hysteresis for alarm output 5 ON/OFF	0 to 50%FS	0.25%FS	
492	dLY5	ALM5 delay	Sets the delay before detecting alarm output 5	0 to 9999[sec/min]	0	
493	dLU	ALM5 delay time units	Sets the delay time unit for alarm output 5	sec (second)/Min (minute)	sec	
494	RoP5	ALM5 option	Assigns the optional functions to ALM5 Ones digit: alarm output latch Tens digit: error alarm Hundreds digit: inverted output Thousands digit: hold reset	0000 to 1111	0000	
500	HbI	HB alarm set value	Sets the value to activate the heater burnout alarm.	0.0 to 100.0 (A)	0.0 A	
501	HbIH	HB alarm hysteresis	Sets an ON/OFF hysteresis for the heater burnout alarm.	0.0 to 100.0 (A)	0.5 A	
502	HSI	Shorted-load alarm set value	Sets the value to activate the shorted load alarm.	0.0 to 100.0 (A)	0.0 A	
503	HSIH	Shorted-load alarm hysteresis	Sets an ON/OFF hysteresis for the shorted heater-load alarm.	0.0 to 100.0 (A)	0.5 A	
508	LbLM	Loop break detection time	Sets the time before detecting a broken loop	0 to 9999 sec	0 (OFF)	
509	LbRb	Loop break detector detection range (°C)	Sets the temperature range before detecting a broken loop	0.0 to 100.0%FS	2.50%FS	
511	WHRL	Electricity alarm setpoint	Sets the value for electricity alarm.	0-9999KWh	0	

CH 6 SET (setup parameters)

No	Display	Parameter		Function	Setting range	Initial value	Remarks
		Name					
530	PVt	PV input type		Sets the type of input sensor	JPT1: 0.0 to 150.0°C JPT2: 0.0 to 300.0°C JPT3: 0.0 to 500.0°C JPT4: 0.0 to 600.0°C JPT5: -50.0 to 100.0°C JPT6: -100.0 to 200.0°C JPT7: -199.9 to 800.0°C PT1: 0.0 to 150.0°C PT2: 0.0 to 300.0°C PT3: 0.0 to 500.0°C PT4: 0.0 to 600.0°C PT5: -50.0 to 100.0°C PT6: -100.0 to 200.0°C PT7: -199.9 to 800.0°C PT8: -200 to 850°C J1: 0.0 to 400.0°C J2: -20.0 to 400.0°C J3: 0.0 to 800.0°C J4: -100 to 1000°C K1: 0 to 400°C K2: -20.0 to 500.0°C K3: 0.0 to 800.0°C K4: -200 to 1300°C R: 0 to 1700°C B: 0 to 1800°C S: 0 to 1700°C T1: -199.9 to 200.0°C PT2: -199.9 to 400.0°C E1: 0.0 to 740.0°C E2: -150.0 to 740.0°C E3: -200 to 740.0°C L: -100 to 850°C U1: -199.9 to 400.0°C U2: -200 to 400°C N: -200 to 1300°C W: 0 to 2300°C PL-2: 0 to 1300°C 0-5 V: 0 to 5 V 1-5 V: 1 to 5 V 0-10: 0 to 10 V 2-10: 2 to 10 V MV: 0 to 100 mV 0-20: 0 to 20 mA 4-20: 4 to 20 mA	K1	[RESET] Refer to section 10 for the detail.
531	PVb	PV input lower limit		Sets the lower limit of PV input	-1999 to 9999	0	[RESET]
532	PVf	PV input upper limit		Sets the upper limit of PV input	-1999 to 9999	400	[RESET]
533	PVd	Decimal point position		Sets the decimal point position for the PV/SV	0: No digit after decimal point 1: 1 digit after decimal point 2: 2 digit after decimal point 3: 3 digit after decimal point	0	[RESET]
535	[UL	Square-root extractor cut point		Sets the cut point for square root calculation.	-0.1 to 105.0(%)	-0.1%	
536	PVoF	PV input shift		Sets the amount of shift for PV input	-10 to 10%FS	0.00%FS	
537	SVoF	SV shift		Sets the amount of shift for PV input	-50 to 50%FS	0.00%	
538	tF	PV input filter		Sets the time constant for the PV input filter	0.0 to 120.0 sec	5.0 sec	
539	Adj0	PV display zero adjustment		Adjusts zero side of PV display.	-50 to 50%FS	0.00%FS	
540	Adj5	PV display span adjustment		Adjusts span side of PV display.	-50 to 50%FS	0.00%FS	
541	RCJ	Cold junction compensation		Sets on/off of cold junction compensation.	oFF on	oN	
543	REM0	Remote SV zero adjustment		Adjusts the zero side of the remote SV input.	-50 to 50%FS	0.00%FS	
544	REM5	Remote SV span adjustment		Adjusts the span side of the remote SV input.	-50 to 50%FS	0.00%FS	
545	REMR	Remote SV input range		Sets the range for remote SV input	0-5v: 0 to 5 V 1-5v: 1 to 5 V 0-10: 0 to 10 V 2-10: 2 to 10 V	1-5V	
546	RCJ	Remote SV input filter		Sets the time constant for the RSV input filter	0.0 to 120.0 sec	0.0 s	
547	[IR	OUT1 range		Sets the range of the control output 1(OUT1)	0-5v: 0 to 5 V 1-5v: 1 to 5 V 0-10: 0 to 10 V 2-10: 2 to 10 V 0-20: 0 to 20 mA 4-20: 4 to 20 mA	0-10 (voltage) 4-20 (current)	Displayed when the control output 1 is current or voltage output.
548	[2R	OUT2 range		Sets the range of the control output 2(OUT2)	0-5v: 0 to 5 V 1-5v: 1 to 5 V 0-10: 0 to 10 V 2-10: 2 to 10 V 0-20: 0 to 20 mA 4-20: 4 to 20 mA	0-10 (voltage) 4-20 (current)	Displayed when the control output 2 is current or voltage output.
549	FLa1	MV1 during FALT		Sets the output value for the control output (MV1) during FALT	-5.0 to 105.0%	-5.0%	
550	FLa2	MV2 during FALT		Sets the output value for the control output (MV2) during FALT	-5.0 to 105.0%	-5.0%	
551	SFa1	MV1 during Soft Start		Sets the value for the control output (MV1) during soft start	-5.0 to 105.0%	105.0%	
553	SFTM	Soft Start set time		Sets the time from startup to the finish of soft start	00:00 to 99:59 (hour:min)	00:00	Be sure to set 0.00 during dual control.
554	Sba1	MV1 during standby		Sets the value for the control output (MV1) during standby	-5.0 to 105.0%	-5.0%	
555	Sba2	MV2 during standby		Sets the value for the control output (MV2) during standby	-5.0 to 105.0%	-5.0%	
556	SbMd	Standby mode		Sets on/off of the alarm output during standby	0: ALM=OFF, AO=ON 1: ALM=ON, AO=ON 2: ALM=OFF, AO=OFF 3: ALM=ON, AO=OFF	0	[RESET]
557	RoL	AO output type		Selects what to transfer to the analog output.	PV SV MV DV PFb	PV	
558	RoL	AO lower scaling		Sets the AO lower scaling	-100.0 to 100.0%	0.0%	
559	RoH	AO upper scaling		Sets the AO upper scaling	-100.0 to 100.0%	100.0%	
561	VoL	Fixed voltage value		Sets the voltage for calculating electric power	1 to 500V	100 (100 V)	
562	[IP	Current value for simple power calculation		Sets the current value for simple power calculation	0.0 to 100.0A	0 (0.0A)	
563	IN	Electric current nullification point		Sets the value that the values below which are nullified before power calculation. The set value or below are treated as null in calculation.	0.0 to 100.0A	0 (0.0A)	
564	ddP	Decial point position for electric power		Sets the position of decimal point for calculated power consumption.	0: 0 1: 0.1 2: 0.01 3: 0.001	1: 0.1	Do not change it during calculation.
565	PHY	Power factor for simple calculation		Sets the power factor for simple calculation	0.00 to 1.00	1.00	
566	PyCN	Upper limit of relay contact operation		Sets the upper limit on the number of times a relay contact can operate. If you set it to 0, no alarm will be generated.	0 to 9999	10 (10K times)	
567	oPEM	Upper limit of operating days		Sets the upper limit on the number of days the device operates. If you set it to 0, no alarm will be generated.	0 to 5000	3650 (3650 days)	

Ch 7 SYS (system parameters)

Parameter		Function	Setting range	Initial value	Remarks	
No	Display Name					
590	U#Y1	USER key	Assigns the function to the [USER] key	0 to 27	0	Refer to section 12 for the detail.
591	U#Y2	USER + UP key	Assigns the function to the [USER]+ A key	0 to 27	5	
592	U#Y3	USER + DOWN key	Assigns the function to the [USER]+ V key	0 to 27	1	
593	d#1	DI-1 function	Allocates a function to DI-1.	0-48	0	Refer to section 14 for the detail.
594	d#2	DI-2 function	Allocates a function to DI-2.	0-48	0	
595	d#3	DI-3 function	Allocates a function to DI-3.	0-48	0	
596	d#4	DI-4 function	Allocates a function to DI-4.	0-48	0	
597	d#5	DI-5 function	Allocates a function to DI-5.	0-48	0	
599	oU#t	OUT1 output type	Selects the content to be output from OUT1	0 to 427	1	Refer to section 13 for the detail.
600	oU#2t	OUT2 output type	Selects the content to be output from OUT2	0 to 427	2	
601	do#1t	DO1 output type	Selects the content to be output from DO1.	0 to 427	3	
602	do#2t	DO2 output type	Selects the content to be output from DO2.	0 to 427	4	
603	do#3t	DO3 output type	Selects the content to be output from DO3.	0 to 427	5	
604	do#4t	DO4 output type	Selects the content to be output from DO4.	0 to 427	6	
605	do#5t	DO5 output type	Selects the content to be output from DO5.	0 to 427	7	
607	LoU#1	LED indicator assignment (OUT1)	Selects the content for OUT1 to indicate.	0 to 427	1	
608	LoU#2	LED indicator assignment (OUT2)	Selects the content for OUT2 to indicate.	0 to 427	2	
609	LE#1	LED indicator assignment (EV1)	Selects the content for EV1 lamp to indicate.	0 to 427	3	
610	LE#2	LED indicator assignment (EV2)	Selects the content for EV2 lamp to indicate.	0 to 427	4	
611	LE#3	LED indicator assignment (EV3)	Selects the content for EV3 lamp to indicate.	0 to 427	5	
612	LE#4	LED indicator assignment (EV4)	Selects the content for EV4 lamp to indicate.	0 to 427	6	
613	LE#5	LED indicator assignment (EV5)	Selects the content for EV5 lamp to indicate.	0 to 427	7	
614	LE#6	LED indicator assignment (EV6)	Selects the content for EV6 lamp to indicate.	0 to 427	0	
615	LE#b	LED indicator assignment (STBY)	Selects the content for STBY lamp to indicate.	0 to 427	12	
616	LE#MAN	LED indicator assignment (MANU)	Selects the content for MAN lamp to indicate.	0 to 427	13	
617	R#MP	Ramp SV ON/OFF	Sets the ramp SV ON/OFF	oFF oN	1(O/N)	
618	R#MPL	Ramp SV-Decline	Sets the slope for a falling SV during ramp SV operations	0 to 100%FS	0.00%FS	
619	R#MPH	Ramp SV-Incline	Sets the slope for a rising SV during ramp SV operations	0 to 100%FS	0.00%FS	
620	R#MPU	Ramp SV-slope time unit	Sets the unit of time for the slope during ramp SV operations	hoUr: slope temperature/hour Min: slope temperature/min	hoUr	
621	S#t	Ramp SV - display mode	Displays the SV during ramp operations or the SV goal value on the SV display	r#MP: ramping SV TRG: target SV	r#MP	
622	LE#PL	Control method	Selects the control method.	ONOF: ON/OFF control Pid: PID control FLZY: Fuzzy control SELF: Self-tuning control Pid2: PID2 control 2FRE: 2-degrees-of-freedom PID	Pid	
623	P#RES	Control target	Selects the control target.	SRV1: servo control 1 SRV2: servo control 2 PFb: Position feedback control	SRV1 (SRV1: without position feedback control) PFb (PFb: with position feedback control)	
624	o#NoF	ONOFF hysteresis	Selects the hysteresis operation during 2-position control.	oFF oN	oN	
626	S#tMd	Start mode	Sets the operation mode during startup	AUTO: starts in AUTO mode MAN: starts in Manual mode REM: starts in remote mode STBY: starts in Standby mode	AUTO	
627	d#t	Control operation cycle	Sets the control operation cycle.	0.1 to 0.9S, 1 to 99S	0.1s	
628	PL#tS	PID palette switching method	Sets the method for switching among PID palette.	0: selected PID No 1: selected SV No 2: PV	0	

Ch 8 MATH (calculation parameters)

Parameter		Function	Setting range	Initial value	Remarks
No	Display Name				
650	M#RLH	Simple calculation ON/OFF	Sets ON/OFF of simple calculation	OFF/ON	OFF
651	W#1#A	Wafer 1 calculation	Sets the wafer 1 calculation.	0-6	0
652	W#1#1	Wafer 1 input 1	Sets the wafer 1 input 1.	0 to 9999	0
653	W#1#2	Wafer 1 input 2	Sets the wafer 1 input 2.	0 to 9999	0
654	W#1#3	Wafer 1 input 3	Sets the wafer 1 input 3.	0 to 9999	0
655	W#1#1	Simple calculation result wafer 1 output 1	Displays the wafer 1 output 1.	-1999 to 9999	-
656	W#1#2	Simple calculation result wafer 1 output 2	Displays the wafer 1 output 2.	-1999 to 9999	-
657	W#1#3	Simple calculation result wafer 1 output 3	Displays the wafer 1 output 3.	-1999 to 9999	-
658	W#1#4	Simple calculation result wafer 1 output 4	Displays the wafer 1 output 4.	-1999 to 9999	-
659	W#2#A	Wafer 2 calculation	Sets the wafer 2 calculation.	0 to 9999	0
660	W#2#1	Wafer 2 input 1	Sets the wafer 2 input 1.	0 to 9999	0
729	W#10#3	Simple calculation result wafer 10 output 3	Displays the wafer 10 output 3.	-1999 to 9999	-
730	W#10#4	Simple calculation result wafer 10 output 4	Displays the wafer 10 output 4.	-1999 to 9999	-
731	Co#N1	Constant 1	Sets the constant 1.	-1999 to 9999	0
740	Co#N10	Constant 10	Sets the constant 10.	-1999 to 9999	0

Ch 9 COM (communication parameters)

No	Display	Parameter		Function	Setting range	Initial value	Remarks
		Name					
760	<i>[L4P]</i>	Communication type		Selects the type of communication.	0: MODBUS RTU 1: Cooperative operation 2: Programless communication	0	[RESET] Note 1
761	<i>[StNo]</i>	Station No.		Sets the station number.	0 to 255 (0: unresponsive communication)	1	[RESET]
762	<i>[SPEd]</i>	RS-485 baud rate		Sets the baud rate	96: 9600 bps 192: 19200 bps 384: 38400 bps 115K: 115 Kbps	0 (96)	[RESET]
763	<i>[PRLY]</i>	RS-485 parity		Sets the parity check	none odd even	1(odd)	[RESET]
764	<i>[rNtV]</i>	RS-485 response interval		Widen the time interval of receiving response. (Set value x 20 ms)	0 to 100	1 (20 ms)	[RESET]
767	<i>[SCC]</i>	Communication permissions		Sets whether or not overwriting is possible from the master side (PC, etc.)	r: Read only rW: Read/overwrite permitted	1 (R/W)	[RESET]
769	<i>[URQ 1]</i>	MODBUS user address setting 1		Sets the MODBUS user address		30001	[RESET]
.
800	<i>[URQ 32]</i>	MODBUS user address setting 32				30001	[RESET]
801	<i>[SVG]</i>	Communication SV gain		Configures the gain to be added to the SV changed through cooperative operation.	0.001 to 9.999%	1.000%	
802	<i>[SVS]</i>	Communication SV shift		Sets the shift value for the SV changed through cooperative operation.	-100 to 100% FS	1.000%	
803	<i>[YHd]</i>	Cooperative operation items		Selects the items to be changed through cooperative operation.	0: SV and RUN/standby 1: all parameters	0%FS	[RESET]
804	<i>[APCY]</i>	All parameters copy		Copies all parameter values of a master to slave devices.	0: not copy 1: copy	-	
805	<i>[PLSt]</i>	Target PLC station No.		Sets the target station number for programless communication.	0 to 255 (0: undefined)	0	[RESET]
806	<i>[PRdH]</i>	PLC registration number allocation rule		Define the method for allocating registration numbers to the PLC programless communication areas.	0: contiguous allocation] 1: individual allocation	0	[RESET]
807	<i>[MStL]</i>	Communication interval between temperature controllers		Sets the time interval of programless communications between temperature controllers.	0 to 100 ms	0	[RESET]
808	<i>[PLtL]</i>	Communication interval between a PLC and temperature controllers		Sets the time interval of programless communications between a PLC and temperature controllers (setpoint x 2 ms).	0 to 100	20 ms	[RESET]
809	<i>[PLAd]</i>	Head of PLC registration numbers		Sets the PLC register number to which PXF accesses in programless communication.	0000 to FFFF	10 (20 ms)	[RESET]
810	<i>[SRQ 1]</i>	Modbus address of data No.1 in setting area		Sets a MODBUS address for data to be registered in setting area data field in programless communication	40001 to 49999: MODBUS address, 0: undefined	0	[RESET]
.
825	<i>[SR 16]</i>	Modbus address of data No.16 in setting area		Sets a MODBUS address for data to be registered in setting area data field in programless communication	40001 to 49999: MODBUS address, 0: undefined	0	[RESET]
826	<i>[MRQ 1]</i>	Modbus address of data No.1 in monitor area		Sets a MODBUS address for data to be registered in monitor area data field in programless communication	30001 to 39999, 40001 to 49999: MODBUS address, 0: undefined	0	[RESET]
.
841	<i>[MR 16]</i>	Modbus address of data No.16 in monitor area		Sets a MODBUS address for data to be registered in monitor area data field in programless communication	30001 to 39999, 40001 to 49999: MODBUS address, 0: undefined	0	[RESET]
842	<i>[AFc#]</i>	Auto Fix		Sets the auto write function for communication.	oN/oFF	oN	Note 2

Note 1) Refer to the communication instruction manual (MODBUS) for the detail of communication functions.

Note 2) You cannot set or change this parameter by using the loader software.

Ch 10 PFB (PFB parameters)

No	Display	Parameter		Function	Setting range	Initial value	Remarks
		Name					
870	<i>[PGAP]</i>	PFB dead band		Sets the dead band for PFB.	0.0 to 100.0%	5.0%	
871	<i>[LPTL]</i>	Valve stroke time		Sets the full-stroke time for the valve.	5 to 180 s	30 s	
873	<i>[CAL]</i>	PFB input adjustment		Carry out zero/span adjustment of PFB input.	0: no adjustment/forced termination 1: zero adjustment 2: span adjustment 3: auto adjustment	-	

Ch 11 DSP (parameter mask)

No	Display	Parameter		Function	Setting range	Initial value	Remarks
		Name					
-	-	Parameter mask		Sets the parameters to be displayed/not displayed.	OFF/dISP	Values differ depending on the model.	

Ch 12 CFG (configuration parameters)

No	Display	Parameter		Function	Setting range	Initial value	Remarks
		Name					
940	<i>toUt</i>		Operation timeout	Sets the time until the display returns to PV/SV screen from setting screen.	15S: 15 sec 30S: 30 sec 60S: 60 sec 5M: 5 min 10M: 10 min non	60S	
942	<i>SoF#</i>		Blinking SV during Soft Start	Sets whether or not to blink SV during Soft Start.	oFF: OFF oN: ON	ON	
943	<i>ALMF</i>		Blinking PV/SV at ALM	Sets whether or not to blink PV/SV when DO becomes ON.	0: PV display (no change) 1: PV and alarm status, alternately 2: blinking PV 3: alarm status	0	
944	<i>LoFF</i>		Display timeout	Sets the time until the display automatically turns off.	oFF: Not use 15s: Auto-off after 15 sec. 30s: Auto-off after 30 sec. 1M: Auto-off after 1 min. 5M: Auto off after 5 min.	oFF	
945	<i>dSPt</i>		PV/SV Display off	Sets ON/OFF of PV and SV display	0: PV and SV ON 1: SV OFF 2: PV OFF 3: PV and SV OFF 4: PV, SV, and indicators OFF (all OFF) 5: SV OFF (relights for 5 sec. by pressing any key) 6: PV OFF (relights for 5 sec. by pressing any key) 7: PV and SV OFF (relights for 5 sec. by pressing any key) 8: PV, SV, and indicators OFF (relights for 5 sec. by pressing any key)	0	
946	<i>FLtF</i>		Blinking PV at input error	Sets whether or not to blink PV at an input error	0: PV blinks at an input error 1: No blink	0	
947	<i>bLcL</i>		Brightness	Sets the brightness of LED backlight	0 to 3 (3 is the brightest)	3	
948	<i>bCoN</i>		Control at burnout	Sets whether to continue or to stop control when the device detects a burnout of PV input	oFF: stops control oN: continues control	oFF	
950	<i>PL01</i>		Model code	Shows model code	-	P	
951	<i>PL02</i>					X	
952	<i>PL03</i>					F	
	*	*	*	*	*	*	*
	*	*	*	*	*	*	*
	*	*	*	*	*	*	*
962	<i>PL13</i>					*	
963	<i>RSr</i>		Reset	Resets the controller	oFF: No reset rST: Performs reset	oFF	
964	<i>VER1</i>		Software version	Shows the software version	-	-	
965	<i>VER2</i>						
966	<i>VER3</i>						
967	<i>VER4</i>						

Ch 13 PASS (password parameters)

No	Display	Parameter		Function	Setting range	Initial value	Remarks
		Name					
990	<i>PRS1</i>		Password1 setup	Sets password 1.	0000 to FFFF	0000	
991	<i>PRS2</i>		Password2 setup	Sets password 2.	0000 to FFFF	0000	
992	<i>PRS3</i>		Password3 setup	Sets password 3.	0000 to FFFF	0000	

3 Parameter functions and setting procedure

3-1 Operation mode

MAN Auto/manual switchover (001)

[Description]

Manual control allows you to set the control output to any value.

- Range: oFF (auto) / on(manual)
- MANU indicator lights during manual operation.
- In this screen, only the switchover between auto/manual is available. Manual operation of control output is available on PV/MV screen.

Note:

This parameter is not displayed in default setting. To use this parameter, change the setting of "CH11 dSP".

[Setting example] Changing the mode from Auto to Manual

Display	Operating procedure						
<table border="1"> <tr> <td>2 4 5</td> <td>PV</td> </tr> <tr> <td>250</td> <td>SV</td> </tr> </table>	2 4 5	PV	250	SV	1. Check that the PV/SV display is shown.		
2 4 5	PV						
250	SV						
<table border="1"> <tr> <td>MAN</td> <td>PV</td> </tr> <tr> <td>oFF</td> <td>SV</td> </tr> </table>	MAN	PV	oFF	SV	2. Press the SEL key to move to operation mode.		
MAN	PV						
oFF	SV						
<table border="1"> <tr> <td>oN</td> <td>SV</td> </tr> </table>	oN	SV	3. Press the SEL key to enter MAN mode. (The lower part of the screen begins to blink.)				
oN	SV						
<table border="1"> <tr> <td>MAN</td> <td>PV</td> </tr> <tr> <td>oN</td> <td>SV</td> </tr> </table>	MAN	PV	oN	SV	4. Use the $\text{\textcircled{\small \wedge}}$ $\text{\textcircled{\small \vee}}$ keys to change oFF to oN.		
MAN	PV						
oN	SV						
<table border="1"> <tr> <td>MANU</td> <td>PV</td> </tr> <tr> <td>MAN</td> <td>PV</td> </tr> <tr> <td>oN</td> <td>SV</td> </tr> </table>	MANU	PV	MAN	PV	oN	SV	5. Press the SEL key to save the change. The mode switches from the auto mode to the manual mode. (MANU indicator turns on.)
MANU	PV						
MAN	PV						
oN	SV						
	6. Press the $\text{\textcircled{\small \leftarrow}}$ key to return to the PV/SV display.						

StbY RUN/Standby switchover (002)

[Description]

Allows you to switch between operation mode and standby mode.

The following items used during standby can be set beforehand.





- Control output (-5.0 to 105.0%)
- Alarm output (ON/OFF)
- Transfer output (ON/OFF)

You can set the detail of standby mode in "Standby mode".

Related parameters: SbMd (page 133), Sbo1 (page 132), Sbo2 (page 132)

- Point:
- When "hold alarms" is on, the hold function activates when you switch the standby setting from on to off.
 - If the instrument is put into standby during auto tuning, the auto tuning is canceled. To complete auto-tuning, turn standby mode off and restart auto tuning.
 - When the controller switches to standby mode, the ON delay timer will be reset. It will begin again when standby mode is turned off.

[Setting example] Switching to Standby mode

Display	Operating procedure						
<table border="1"> <tr> <td>2 4 5</td> <td>PV</td> </tr> <tr> <td>250</td> <td>SV</td> </tr> </table>	2 4 5	PV	250	SV	1. Check that the PV/SV display is shown.		
2 4 5	PV						
250	SV						
<table border="1"> <tr> <td>MAN</td> <td>PV</td> </tr> <tr> <td>oFF</td> <td>SV</td> </tr> </table>	MAN	PV	oFF	SV	2. Press the SEL key to move to operation mode.		
MAN	PV						
oFF	SV						
<table border="1"> <tr> <td>S t b Y</td> <td>PV</td> </tr> <tr> <td>oFF</td> <td>SV</td> </tr> </table>	S t b Y	PV	oFF	SV	3. Use the   keys to change MAN to StbY.		
S t b Y	PV						
oFF	SV						
<table border="1"> <tr> <td>S t b Y</td> <td>PV</td> </tr> <tr> <td>oFF</td> <td>SV</td> </tr> </table>	S t b Y	PV	oFF	SV	4. Press the SEL key to enter StbY mode. (The lower part of the screen begins to blink.)		
S t b Y	PV						
oFF	SV						
<table border="1"> <tr> <td>STBY</td> <td></td> </tr> <tr> <td>S t b Y</td> <td>PV</td> </tr> <tr> <td>oN</td> <td>SV</td> </tr> </table>	STBY		S t b Y	PV	oN	SV	5. Use the   keys to change oFF to oN.
STBY							
S t b Y	PV						
oN	SV						
	6. Press the SEL key to save the change. Now the controller is in the Standby Mode. (STBY indicator turns on.)						
	7. Press the  key to return to the PV/SV display.						

REM Remote/local switchover (003)

[Description]

The following will switch you between local SV and remote SV operation. In remote SV operation, SV is controlled by an external SV input (RSV).

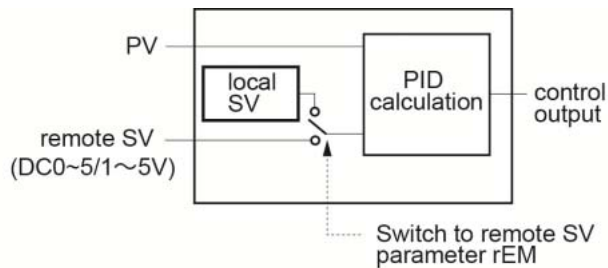

Note:

During remote operation, you cannot change the SV by using UP/DOWN keys on the front panel.

[Setting example] Switching to the remote SV mode

Display	Operating procedure				
<table border="1"> <tr> <td>2 4 5</td> <td>PV</td> </tr> <tr> <td>250</td> <td>SV</td> </tr> </table>	2 4 5	PV	250	SV	1. Check that the PV/SV display is shown.
2 4 5	PV				
250	SV				
<table border="1"> <tr> <td>MAN</td> <td>PV</td> </tr> <tr> <td>oFF</td> <td>SV</td> </tr> </table>	MAN	PV	oFF	SV	2. Press the SEL key to move to operation mode.
MAN	PV				
oFF	SV				
<table border="1"> <tr> <td>REM</td> <td>PV</td> </tr> <tr> <td>LoCL</td> <td>SV</td> </tr> </table>	REM	PV	LoCL	SV	3. Use the Δ ∇ keys to change “MAN” to “REM”.
REM	PV				
LoCL	SV				
<table border="1"> <tr> <td>REM</td> <td>PV</td> </tr> <tr> <td>LoCL</td> <td>SV</td> </tr> </table>	REM	PV	LoCL	SV	4. Press the SEL key. (The first digit of the lower part of the screen begins to blink.)
REM	PV				
LoCL	SV				
<table border="1"> <tr> <td>REM</td> <td>PV</td> </tr> <tr> <td>REM</td> <td>SV</td> </tr> </table>	REM	PV	REM	SV	5. Use Δ ∇ keys to change “LoCL” to “REM”..
REM	PV				
REM	SV				
<table border="1"> <tr> <td>REM</td> <td>PV</td> </tr> <tr> <td>REM</td> <td>SV</td> </tr> </table>	REM	PV	REM	SV	6. Press the SEL key to save the change. Remote SV mode starts
REM	PV				
REM	SV				
<table border="1"> <tr> <td>2 4 5</td> <td>PV</td> </tr> <tr> <td>PSV 250</td> <td>SV</td> </tr> </table>	2 4 5	PV	PSV 250	SV	7. Press the \odot key to return to the PV/SV display “RSV” appears on the screen number indication area.
2 4 5	PV				
PSV 250	SV				

PRoG Ramp Soak control command (004)

[Description]

Allows you to switch between Ramp/soak states.

You can select among the following three state.

- oFF (stop): Ramp/soak is stopped.
- RUN (start): Ramp/soak starts.
- HLd (hold): Ramp/soak hold. To release the hold, select "RUN" again.

The parameter information changes automatically depending on the ramp/soak state.

- GS (Guaranty soak ON): Guaranty soak is activated and PV is out of guaranty soak setting range.
- ENd (end): Ramp/soak has finished.

During ramp soak operation, one of RUN, HOLD, or END indicators light according to the state of ramp soak.

During ramp soak operation, on-going step No. and "r" (ramp) or "-" (soak) are displayed on the screen No. area of operation screen (PV/SV screen).

For example, "2r" appears during step 2 ramp, and "2-" during step 2 soak.

Related parameters: PRG (CH3) (page 70)

[Setting example] Ramp Soak command is carried out

Display	Operating procedure				
<table border="1"> <tr> <td>2 4 5</td> <td>PV</td> </tr> <tr> <td>250</td> <td>SV</td> </tr> </table>	2 4 5	PV	250	SV	<ol style="list-style-type: none"> 1. Check that the PV/SV display is shown. 2. Press the SEL key to move to operation mode. 3. Use the Δ ∇ keys to change MAN to PRoG. 4. Press the SEL key to enter PRoG mode. (The lower part of the screen begins to blink.) 5. Use the Δ ∇ keys to change oFF to RUN. 6. Press the SEL key to save the change. Ramp Soak command is carried out. 7. Press the \odot key to return to the PV/SV display.
2 4 5	PV				
250	SV				
<table border="1"> <tr> <td>MAN</td> <td>PV</td> </tr> <tr> <td>oFF</td> <td>SV</td> </tr> </table>	MAN	PV	oFF	SV	
MAN	PV				
oFF	SV				
<table border="1"> <tr> <td>PRoG</td> <td>PV</td> </tr> <tr> <td>oFF</td> <td>SV</td> </tr> </table>	PRoG	PV	oFF	SV	
PRoG	PV				
oFF	SV				
<table border="1"> <tr> <td>RUN</td> <td>SV</td> </tr> </table>	RUN	SV			
RUN	SV				

AT Auto tuning (005)

[Description]

Running auto-tuning automatically sets the optimal PID.

- Setting range
 - oFF: Stop/Finish
 - oN: starts auto tuning (normal type)
 - L-oN: starts auto tuning (low-PV type)

There are the following two types in auto-tuning.

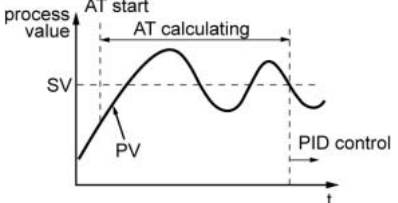
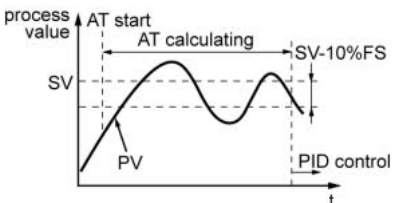
Normal type	Performs ON/OFF operation with SV as the baseline to calculate PID.	
Low-PV type	Performs ON/OFF operation with SV-10% to calculate PID. Use this setting if you want to prevent overshoot.	





- When auto tuning is normally completed, the automatically set PID parameter value is maintained even if the power is turned off. If the power is turned off during auto tuning, the auto-tuning function is invalidated with PID parameters unchanged. In such a case, start again from the beginning.
- Since ON-OFF operation (2-position operation) is performed during auto tuning, PV may fluctuate greatly depending on the process. Do not perform auto tuning for the processes where large fluctuation of PV is not allowed. Do not perform auto tuning, either, for the processes where the response is quick, such as pressure control or flow rate control.
- If auto tuning does not end after 4 hours, it means that tuning may not be completed successfully. Check input/output wiring and parameters such as control output (forward, reverse) and input sensor type.
- When you change SV or PV input type, or when operation does not work properly due to the change in operating conditions, perform auto tuning again.
- You can run auto-tuning when the control type is set to "fuzzy" or "PID2".
- You cannot run auto-tuning during manual mode.
- When you are using the PID selection function, the auto-tuning result for the selected PID group is stored.
- Auto tuning is forcibly terminated when SV is changed by the ramp soak function, remote SV function, or ramp SV.

Note:

Since ON/OFF control is performed during auto-tuning, overshoot against the SV may occur. To reduce the overshoot, execute the auto-tuning with [L-on] (Low PV).

Related parameters: CtRL (CH7) (page 153)

[Setting example] Running Auto-tuning

Display	Operating procedure				
<table border="1"> <tr> <td data-bbox="108 282 331 349">2 4 5</td> <td data-bbox="331 282 384 349">PV</td> </tr> <tr> <td data-bbox="108 349 331 416">250</td> <td data-bbox="331 349 384 416">SV</td> </tr> </table>	2 4 5	PV	250	SV	<p>1. Check that the PV/SV display is shown.</p>
2 4 5	PV				
250	SV				
<table border="1"> <tr> <td data-bbox="108 483 331 551">MAN</td> <td data-bbox="331 483 384 551">PV</td> </tr> <tr> <td data-bbox="108 551 331 618">oFF</td> <td data-bbox="331 551 384 618">SV</td> </tr> </table>	MAN	PV	oFF	SV	<p>2. Press the SEL key to move to operation mode.</p> <p>3. Use the   keys to change MAN to At.</p>
MAN	PV				
oFF	SV				
<table border="1"> <tr> <td data-bbox="108 685 331 752">A t</td> <td data-bbox="331 685 384 752">PV</td> </tr> <tr> <td data-bbox="108 752 331 819">oFF</td> <td data-bbox="331 752 384 819">SV</td> </tr> </table>	A t	PV	oFF	SV	<p>4. Press the SEL key to enter At mode. (The lower part of the screen begins to blink.)</p>
A t	PV				
oFF	SV				
<table border="1"> <tr> <td data-bbox="108 842 331 909">AT</td> <td data-bbox="331 842 384 909">oN</td> </tr> </table>	AT	oN	<p>5. Use the   keys to change oFF to oN.</p>		
AT	oN				
	<p>6. Press the SEL key to save the change. Auto tuning starts. AT indicator lamp blinks.</p>				
	<p>7. Press the  key to return to the PV/SV display.</p>				





LACH Alarm output latch release (006)

[Description]

Allows you to cancel the alarm Latch.

- Setting range
 - oFF: keeps the latch on
 - RSt: releases latch

[Setting example] Releasing alarm output latch

Display	Operating procedure				
<table border="1"><tr><td>2 4 5</td><td>PV</td></tr><tr><td>250</td><td>SV</td></tr></table>	2 4 5	PV	250	SV	1. Check that the PV/SV display is shown.
2 4 5	PV				
250	SV				
<table border="1"><tr><td>MAN</td><td>PV</td></tr><tr><td>oFF</td><td>SV</td></tr></table>	MAN	PV	oFF	SV	2. Press the SEL key to move to operation mode. 3. Use the   keys to change MAN to LACH.
MAN	PV				
oFF	SV				
<table border="1"><tr><td>LACH</td><td>PV</td></tr><tr><td>oFF</td><td>SV</td></tr></table>	LACH	PV	oFF	SV	4. Press the SEL key to enter LACH mode. (The lower part of the screen begins to blink.)
LACH	PV				
oFF	SV				
<table border="1"><tr><td>RSt</td><td>SV</td></tr></table>	RSt	SV	5. Use the   keys to change oFF to RSt. 6. Press the SEL key to save the change. The alarm latch has been canceled.		
RSt	SV				
	7. Press the  key to return to the PV/SV display.				

SVN SV selection (007)

[Description]

Allows you to easily switch SV among the following.

- Setting range: LoCL, SV1, SV2, SV3, SV4, SV5, SV6, SV7, di

To use this function, you need to configure SVs (SV1 to SV7) in the PID palette parameters. It is recommended to activate the ramp SV before changing SV number so that control disorders can be reduced.

Related parameters: RMP (CH7) (page 148)

Note:

Changing the SV number will not change the control parameters (PID, etc).

When changing the SV value with the front panel key, do not change the "Svn" parameter via communication. Otherwise, the changed SV may not be stored correctly.

[Setting example] Changing SV Number

Display	Operating procedure				
<table border="1"> <tr> <td>2 4 5</td> <td>PV</td> </tr> <tr> <td>250</td> <td>SV</td> </tr> </table>	2 4 5	PV	250	SV	<ol style="list-style-type: none"> 1. Check that the PV/SV display is shown. 2. Press the SEL key to move to operation mode. 3. Use the Δ ∇ keys to change MAN to SVN. 4. Press the SEL key to enter SVN mode. (The lower part of the screen begins to blink.) 5. Use the Δ ∇ keys to change LoCL to SV3. 6. Press the SEL key to save the change. The SV used for control is now set to "SV3". 7. Press the C key to return to the PV/SV display.
2 4 5	PV				
250	SV				
<table border="1"> <tr> <td>MAN</td> <td>PV</td> </tr> <tr> <td>oFF</td> <td>SV</td> </tr> </table>	MAN	PV	oFF	SV	
MAN	PV				
oFF	SV				
<table border="1"> <tr> <td>SVN</td> <td>PV</td> </tr> <tr> <td>LoCL</td> <td>SV</td> </tr> </table>	SVN	PV	LoCL	SV	
SVN	PV				
LoCL	SV				
<table border="1"> <tr> <td>SV3</td> <td>SV</td> </tr> </table>	SV3	SV			
SV3	SV				

PLN1 PID selection (008)





[Description]

Allows you to easily switch PID No. among those you configured in the PID palette parameters.

This allows you to change the PID according to the change of SV or control target.

- Range: LoCL, Pid1, Pid2, Pid3, Pid4, Pid5, Pid6, Pid7, di

[Setting example] Changing PID Number

Display	Operating procedure				
<table border="1" style="width: 100%; border-collapse: collapse;"> <tr> <td style="text-align: center; padding: 5px;">2 4 5</td> <td style="text-align: center; padding: 5px;">PV</td> </tr> <tr> <td style="text-align: center; padding: 5px;">250</td> <td style="text-align: center; padding: 5px;">SV</td> </tr> </table>	2 4 5	PV	250	SV	<p>1. Check that the PV/SV display is shown.</p>
2 4 5	PV				
250	SV				
<table border="1" style="width: 100%; border-collapse: collapse;"> <tr> <td style="text-align: center; padding: 5px;">MAN</td> <td style="text-align: center; padding: 5px;">PV</td> </tr> <tr> <td style="text-align: center; padding: 5px;">oFF</td> <td style="text-align: center; padding: 5px;">SV</td> </tr> </table>	MAN	PV	oFF	SV	<p>2. Press the SEL key to move to operation mode.</p> <p>3. Use the   keys to change MAN to PLN1.</p>
MAN	PV				
oFF	SV				
<table border="1" style="width: 100%; border-collapse: collapse;"> <tr> <td style="text-align: center; padding: 5px;">P L N 1</td> <td style="text-align: center; padding: 5px;">PV</td> </tr> <tr> <td style="text-align: center; padding: 5px;">LoCL</td> <td style="text-align: center; padding: 5px;">SV</td> </tr> </table>	P L N 1	PV	LoCL	SV	<p>4. Press the SEL key to enter PLN1 mode. (The lower part of the screen begins to blink.)</p>
P L N 1	PV				
LoCL	SV				
<table border="1" style="width: 100%; border-collapse: collapse;"> <tr> <td style="text-align: center; padding: 5px;">Pid1</td> <td style="text-align: center; padding: 5px;">SV</td> </tr> </table>	Pid1	SV	<p>5. Use the   keys to change LoCL to Pid1.</p>		
Pid1	SV				
	<p>6. Press the SEL key to save the change. The PID calculation parameter used for control is now set to Pid1.</p> <p>7. Press the  key to return to the PV/SV display.</p>				

AL1	A1-L	A1-H	Alarm settings (009 to 011)
AL2	A2-L	A2-H	(012 to 014)
AL3	A3-L	A3-H	(015 to 017)
AL4	A4-L	A4-H	(018 to 020)
AL5	A5-L	A5-H	(021 to 023)







[Description] _____

Allows you to set the values for alarm 1 to alarm 5.

- Setting range: absolute value alarm: 0% to 100% FS
deviation alarm: -100% to 100% FS

Related parameters: CH5 Alarm parameters (page 100)

[Setting example] Setting alarms _____

Display	Operating procedure				
<table border="1"> <tr> <td>2 4 5</td> <td>PV</td> </tr> <tr> <td>250</td> <td>SV</td> </tr> </table>	2 4 5	PV	250	SV	<ol style="list-style-type: none"> 1. Check that the PV/SV display is shown. 2. Press the SEL key to move to operation mode. 3. Use the   keys to change MAN to AL1. 4. Press the SEL key to enter AL1 mode. (The first digit of the lower part of the screen begins to blink.) 5. Use the    keys to change 10 to 20. 6. Press the SEL key to save the change. The alarm value is now set to 20°C. 7. Press the  key to return to the PV/SV display.
2 4 5	PV				
250	SV				
<table border="1"> <tr> <td>MAN</td> <td>PV</td> </tr> <tr> <td>oFF</td> <td>SV</td> </tr> </table>	MAN	PV	oFF	SV	
MAN	PV				
oFF	SV				
<table border="1"> <tr> <td>AL 1</td> <td>PV</td> </tr> <tr> <td>0010</td> <td>SV</td> </tr> </table>	AL 1	PV	0010	SV	
AL 1	PV				
0010	SV				
<table border="1"> <tr> <td>0020</td> <td>SV</td> </tr> </table>	0020	SV			
0020	SV				

WCMd Electric power calculation command (027)





[Description]

Allows you to switch the electric power calculation status among the following three modes.

- oFF: Stops calculation. (Calculated amount of electric power will be cleared.)
- RUN: Calculates the amount of electric energy.
- HLd: Suspend the calculation. (Calculated value of electric power will be retained.)

Related parameters: CH6 Setup parameters (page 114)

[Setting example] Switching electricity power calculation status

Display	Operating procedure				
<table border="1" style="width: 100%; text-align: center;"> <tr> <td style="width: 80%;">2 4 5</td> <td style="width: 20%;">PV</td> </tr> <tr> <td>250</td> <td>SV</td> </tr> </table>	2 4 5	PV	250	SV	<p>1. Check that the PV/SV display is shown.</p>
2 4 5	PV				
250	SV				
<table border="1" style="width: 100%; text-align: center;"> <tr> <td style="width: 80%;">MAN</td> <td style="width: 20%;">PV</td> </tr> <tr> <td>oFF</td> <td>SV</td> </tr> </table>	MAN	PV	oFF	SV	<p>2. Press the SEL key to move to operation mode.</p> <p>3. Use the   keys to change MAN to WCMd.</p>
MAN	PV				
oFF	SV				
<table border="1" style="width: 100%; text-align: center;"> <tr> <td style="width: 80%;">WCMd</td> <td style="width: 20%;">PV</td> </tr> <tr> <td>oFF</td> <td>SV</td> </tr> </table>	WCMd	PV	oFF	SV	<p>4. Press the SEL key to enter WCMd mode. (The lower part of the screen begins to blink.)</p>
WCMd	PV				
oFF	SV				
<table border="1" style="width: 100%; text-align: center;"> <tr> <td style="width: 80%;">RUN</td> <td style="width: 20%;">SV</td> </tr> </table>	RUN	SV	<p>5. Use the   keys to change oFF to RUN.</p>		
RUN	SV				
	<p>6. Press the SEL key to save the change. Calculates the amount of electric energy.</p> <p>7. Press the  key to return to the PV/SV display.</p>				

LoC Key lock (028)

[Description]

Prevents SV parameters from being changed.





The following three settings are available:

- oFF: No lock
- ALL: All locked
- PARA: All but SV locked

The channel menu can be displayed even when key lock is active.

Related parameters: Accidental operation can also be prevented with a password. See CH13 Password parameters (page 195).

[Setting example] Setting Key Lock

Display	Operating procedure				
<table border="1" style="width: 100%; border-collapse: collapse;"> <tr> <td style="text-align: center; padding: 5px;">2 4 5</td> <td style="text-align: center; padding: 5px;">PV</td> </tr> <tr> <td style="text-align: center; padding: 5px;">250</td> <td style="text-align: center; padding: 5px;">SV</td> </tr> </table>	2 4 5	PV	250	SV	<ol style="list-style-type: none"> 1. Check that the PV/SV display is shown. 2. Press the SEL key to move to operation mode. 3. Use the   keys to change MAN to LoC. 4. Press the SEL key to enter LoC mode. (The first digit of the lower part of the screen begins to blink.) 5. Use the   keys to change oFF to ALL. 6. Press the SEL key to save the change. Key Lock is now activated. 7. Press the  key to return to the PV/SV display.
2 4 5	PV				
250	SV				
<table border="1" style="width: 100%; border-collapse: collapse;"> <tr> <td style="text-align: center; padding: 5px;">MAN</td> <td style="text-align: center; padding: 5px;">PV</td> </tr> <tr> <td style="text-align: center; padding: 5px;">oFF</td> <td style="text-align: center; padding: 5px;">SV</td> </tr> </table>	MAN	PV	oFF	SV	
MAN	PV				
oFF	SV				
<table border="1" style="width: 100%; border-collapse: collapse;"> <tr> <td style="text-align: center; padding: 5px;">L o C</td> <td style="text-align: center; padding: 5px;">PV</td> </tr> <tr> <td style="text-align: center; padding: 5px;">oFF</td> <td style="text-align: center; padding: 5px;">SV</td> </tr> </table>	L o C	PV	oFF	SV	
L o C	PV				
oFF	SV				
<table border="1" style="width: 100%; border-collapse: collapse;"> <tr> <td style="text-align: center; padding: 5px;">ALL</td> <td style="text-align: center; padding: 5px;">SV</td> </tr> </table>	ALL	SV			
ALL	SV				

3-2 CH1 PID (Control parameters)

P Proportional band (050)

i Integration time (051)

d Differential time (052)

[Description]

Allows you to set PID (Proportional Band, Integration Time, Differential Time).

Setting range

P: 0.1 to 999.9%

I: 0 to 3200 seconds

D: 0.0 to 999.9 seconds

The following control methods are available with PID settings.

ON/OFF control (2-position control)	When the control method CtRL is set to oNoF, ON/OFF control is used. Use this function when you want to run simple control without worrying about the controllability.
PID control	Use this function when you want to control with high controllability. P, I, and D should be adjusted to optimal values for the control target, although Pid can be activated with $P \neq 0$, $I \neq 0$, and $D \neq 0$. In normal situations, run auto-tuning to optimally adjust P, I, and D before using this function.
PI control	When $P \neq 0$, $I \neq 0$, and $D = 0$, D control is turned off and PI control is used.
P control	When $P \neq 0$ and $I = 0$, $D = 0$, I and D controls are turned off and P control is used. In principle, P control generates offset and PV does not agree with SV. In this case, adjust the output convergence value "bAL".

Running auto-tuning automatically sets the optimal PID. See "[AT] Auto tuning (005)" (page 33)

The PID settings configured by auto-tuning are generally considered to be optimal settings. If you want to change the responsiveness, adjust PID manually.

Generally, control becomes unstable when "P" is set too small. On the other hand, setting it too big makes the response slow.

Set the hysteresis for the ON/OFF (2-position) control with the parameter "hyS".

Note

Do not perform auto tuning during ON/OFF control.

[Setting example] Setting P = 10.0%, I = 100sec., D = 20sec.

Display	Operating procedure				
<table border="1"> <tr> <td>2 4 5</td> <td>PV</td> </tr> <tr> <td>250</td> <td>SV</td> </tr> </table>	2 4 5	PV	250	SV	<p>1. Check that the PV/SV display is shown.</p>
2 4 5	PV				
250	SV				
<table border="1"> <tr> <td>CH 1</td> <td>PV</td> </tr> <tr> <td>Pid</td> <td>SV</td> </tr> </table>	CH 1	PV	Pid	SV	<p>2. Press and hold the SEL key to display CH1 (PID parameters). 3. Press the SEL key to enter CH1 (PID parameters). P is displayed.</p>
CH 1	PV				
Pid	SV				
<table border="1"> <tr> <td>P</td> <td>PV</td> </tr> <tr> <td>5.0</td> <td>SV</td> </tr> </table>	P	PV	5.0	SV	<p>4. Press the SEL key. (The first digit of the lower part of the screen begins to blink.)</p>
P	PV				
5.0	SV				
<table border="1"> <tr> <td>10.0</td> <td>SV</td> </tr> </table>	10.0	SV	<p>5. Use the Δ ∇ keys to change 5.0 to 10.0. 6. Press the SEL key to save the change.</p>		
10.0	SV				
<table border="1"> <tr> <td>i</td> <td>PV</td> </tr> <tr> <td>240</td> <td>SV</td> </tr> </table>	i	PV	240	SV	<p>7. Use the ∇ key to display i(integration time). 8. Press the SEL key. (The first digit of the lower part of the screen begins to blink.)</p>
i	PV				
240	SV				
<table border="1"> <tr> <td>100</td> <td>SV</td> </tr> </table>	100	SV	<p>9. Use the Δ ∇ keys to change 240 to 100. 10. Press the SEL key to save the change.</p>		
100	SV				
<table border="1"> <tr> <td>d</td> <td>PV</td> </tr> <tr> <td>60.0</td> <td>SV</td> </tr> </table>	d	PV	60.0	SV	<p>11. Use the ∇ key to display d(differential time). 12. Press the SEL key. (The first digit of the lower part of the screen begins to blink.)</p>
d	PV				
60.0	SV				
<table border="1"> <tr> <td>20.0</td> <td>SV</td> </tr> </table>	20.0	SV	<p>13. Use the Δ ∇ keys to change 60.0 to 20.0. 14. Press the SEL key to save the change.</p>		
20.0	SV				
	<p>15. Press the ⏪ key to return to the PV/SV display.</p>				

HYS ON/OFF control hysteresis (053)

[Description]

Allows you to set the hysteresis for ON/OFF (2 position) control

- Setting range: 0.0 to 50.0% FS

The controllability varies with the size of the hysteresis.

Small hysteresis	<ul style="list-style-type: none"> • High-precision control • Frequency of output relays is high, so lifespan becomes short.
Large hysteresis	<ul style="list-style-type: none"> • Low-precision control • Frequency of output relays is low, so lifespan is relatively long.

The relationship between SV and hysteresis in normal and reverse operation is shown below.

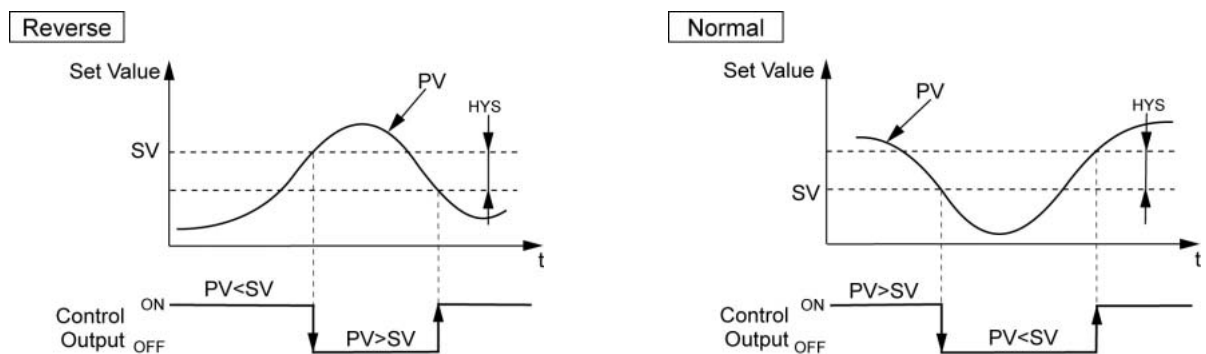

- During ON/OFF control, the i and d settings do not affect control.
- If the hysteresis width is narrow, and PV and SV are nearly equal, the output may frequently switch on and off. Note that it may affect the life of the contact.

[Setting example] Changing the hysteresis range from 25%FS to 30%FS

Display	Operating procedure				
<table border="1"> <tr> <td>245</td> <td>PV</td> </tr> <tr> <td>250</td> <td>SV</td> </tr> </table>	245	PV	250	SV	1. Check that the PV/SV display is shown.
245	PV				
250	SV				
<table border="1"> <tr> <td>CH 1</td> <td>PV</td> </tr> <tr> <td>Pid</td> <td>SV</td> </tr> </table>	CH 1	PV	Pid	SV	2. Press and hold the SEL key to display CH1 (PID parameters).
CH 1	PV				
Pid	SV				
<table border="1"> <tr> <td>P</td> <td>PV</td> </tr> <tr> <td>5.0</td> <td>SV</td> </tr> </table>	P	PV	5.0	SV	3. Press the SEL key to enter CH1 (PID parameters). P is displayed.
P	PV				
5.0	SV				
<table border="1"> <tr> <td>P</td> <td>PV</td> </tr> <tr> <td>5.0</td> <td>SV</td> </tr> </table>	P	PV	5.0	SV	4. Use the Δ ∇ keys to change P to HYS.
P	PV				
5.0	SV				
<table border="1"> <tr> <td>HYS</td> <td>PV</td> </tr> <tr> <td>25</td> <td>SV</td> </tr> </table>	HYS	PV	25	SV	5. Press the SEL key. (The first digit of the lower part of the screen begins to blink.)
HYS	PV				
25	SV				
<table border="1"> <tr> <td>HYS</td> <td>PV</td> </tr> <tr> <td>25</td> <td>SV</td> </tr> </table>	HYS	PV	25	SV	6. Use the Δ ∇ keys to change 25 to 30.
HYS	PV				
25	SV				
<table border="1"> <tr> <td>HYS</td> <td>PV</td> </tr> <tr> <td>30</td> <td>SV</td> </tr> </table>	HYS	PV	30	SV	7. Press the SEL key to save the change.
HYS	PV				
30	SV				
<table border="1"> <tr> <td>HYS</td> <td>PV</td> </tr> <tr> <td>30</td> <td>SV</td> </tr> </table>	HYS	PV	30	SV	8. Press the \ominus key to return to the PV/SV display.
HYS	PV				
30	SV				

Cool Cooling proportional band coefficient (054)

[Description]

Allows you to set the proportional band coefficient for cooling.

- Setting range: 0.0 to 100.0

The relationship between heating control output and cooling control output is outlined below.

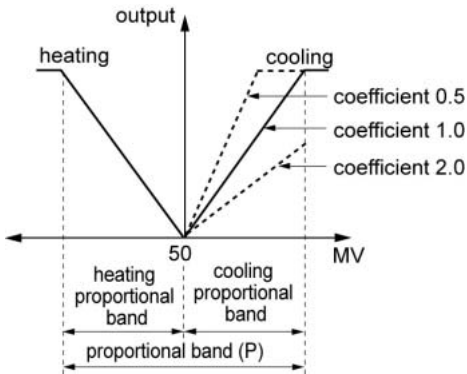

Cooling proportional band is set after the optimal value for heating proportional band is set.

$$\text{Cooling proportional band} = (\text{Proportional band } P/2) \times \text{Coefficient}$$

The following example shows how the cooling proportional band is calculated.

Example: Calculating the coefficient that will give a cooling proportional band of 10% when proportional band(P) = 50% with full scale cooling

$$10\% = (50\%/2) \times \text{Coefficient}$$

$$\text{Coefficient} = 0.4$$

To set cooling as a secondary operation, set "Cool" to 0.0.

With two outputs set as P=0.0 and Cool=0.0, heating and cooling outputs become ON/OFF actions (3-position control). In this situation, the ON/OFF hysteresis is 0.5% FS (fixed) for heating and cooling outputs. The point of operation for the heating output can be shifted with the "HYS" parameter. The point of operation for the cooling output can be shifted with the "db" parameter.

The relationship between SV and hysteresis in normal and reverse operation is shown below.

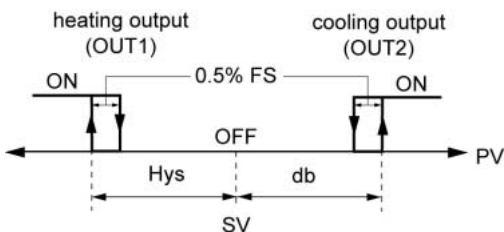

[Setting example] Changing cooling proportional band coefficient from 1.0 to 2.5

Display	Operating procedure				
<table border="1"> <tr> <td data-bbox="217 282 443 349">2 4 5</td> <td data-bbox="443 282 504 349">PV</td> </tr> <tr> <td data-bbox="217 349 443 405">250</td> <td data-bbox="443 349 504 405">SV</td> </tr> </table>	2 4 5	PV	250	SV	<p>1. Check that the PV/SV display is shown.</p>
2 4 5	PV				
250	SV				
<table border="1"> <tr> <td data-bbox="217 472 443 539">CH 1</td> <td data-bbox="443 472 504 539">PV</td> </tr> <tr> <td data-bbox="217 539 443 607">Pid</td> <td data-bbox="443 539 504 607">SV</td> </tr> </table>	CH 1	PV	Pid	SV	<p>2. Press and hold the SEL key to display CH1 (PID parameters).</p>
CH 1	PV				
Pid	SV				
<table border="1"> <tr> <td data-bbox="217 674 443 741">P</td> <td data-bbox="443 674 504 741">PV</td> </tr> <tr> <td data-bbox="217 741 443 808">5.0</td> <td data-bbox="443 741 504 808">SV</td> </tr> </table>	P	PV	5.0	SV	<p>3. Press the SEL key to enter CH1 (PID parameters). P is displayed.</p>
P	PV				
5.0	SV				
<table border="1"> <tr> <td data-bbox="217 875 443 943">C o o L</td> <td data-bbox="443 875 504 943">PV</td> </tr> <tr> <td data-bbox="217 943 443 1010">1.0</td> <td data-bbox="443 943 504 1010">SV</td> </tr> </table>	C o o L	PV	1.0	SV	<p>4. Use the Δ ∇ keys to change P to Cool. 5. Press the SEL key. (The first digit of the lower part of the screen begins to blink.)</p>
C o o L	PV				
1.0	SV				
<table border="1"> <tr> <td data-bbox="217 1032 443 1099">2.5</td> <td data-bbox="443 1032 504 1099">SV</td> </tr> </table>	2.5	SV	<p>6. Use the Δ ∇ keys to change 1.0 to 2.5. 7. Press the SEL key to save the change.</p>		
2.5	SV				
	<p>8. Press the \leftarrow key to return to the PV/SV display.</p>				

db Dead band (055)

[Description]

Shifts the cooling proportional band against the set value as follows.

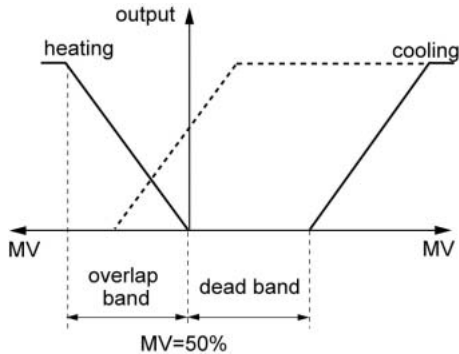

"db" is called dead band when the value is positive, and overlap band when the value is negative.

- Range: -50% to 50%

"db" is measured as a percentage of MV and can be converted to a percentage deviation by the following formula.

$$DB [\%] = \text{deviation} \times 100/P [\%]$$

Example: Proportional Band (P) = 5.0%, with a desired dead band of 1% deviation from SV:

$$DB [\%] = 1.0 \times 100/5.0 = 20 [\%]$$

Dead band = 20 (%)

[Setting example] Setting Dead band to 1.5%

Display	Operating procedure				
<table border="1"> <tr> <td>2 4 5</td> <td>PV</td> </tr> <tr> <td>250</td> <td>SV</td> </tr> </table>	2 4 5	PV	250	SV	1. Check that the PV/SV display is shown.
2 4 5	PV				
250	SV				
<table border="1"> <tr> <td>CH 1</td> <td>PV</td> </tr> <tr> <td>Pid</td> <td>SV</td> </tr> </table>	CH 1	PV	Pid	SV	2. Press and hold the SEL key to display CH1 (PID parameters).
CH 1	PV				
Pid	SV				
<table border="1"> <tr> <td>P</td> <td>PV</td> </tr> <tr> <td>5.0</td> <td>SV</td> </tr> </table>	P	PV	5.0	SV	3. Press the SEL key to enter CH1 (PID parameters). P is displayed.
P	PV				
5.0	SV				
<table border="1"> <tr> <td>db</td> <td>PV</td> </tr> <tr> <td>0.0</td> <td>SV</td> </tr> </table>	db	PV	0.0	SV	4. Use the Δ ∇ keys to change P to db. 5. Press the SEL key. (The first digit of the lower part of the screen begins to blink.)
db	PV				
0.0	SV				
<table border="1"> <tr> <td>1.5</td> <td>SV</td> </tr> </table>	1.5	SV	6. Use the Δ ∇ keys to change 0.0 to 1.5. 7. Press the SEL key to save the change.		
1.5	SV				
	8. Press the \odot key to return to the PV/SV display.				

bAL Output convergence value (056)

[Description]

Output convergence value is a function that adds an offset to MV value.

- Setting range bAL: -100 to 100%

By this function, the bAL offset is added to original MV which is the result of PID calculation determined by PV and SV, and the total value is outputted as MV.

(The factory setting of bAL is 0% for single output, 50% for dual output.)

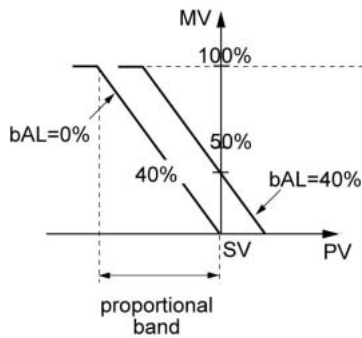

[Setting example] Changing Output convergence value from 0.0% to 3.0%

Display	Operating procedure				
<table border="1"> <tr> <td>2 4 5</td> <td>PV</td> </tr> <tr> <td>250</td> <td>SV</td> </tr> </table>	2 4 5	PV	250	SV	1. Check that the PV/SV display is shown.
2 4 5	PV				
250	SV				
<table border="1"> <tr> <td>CH 1</td> <td>PV</td> </tr> <tr> <td>Pid</td> <td>SV</td> </tr> </table>	CH 1	PV	Pid	SV	2. Press and hold the SEL key to display CH1 (PID parameters).
CH 1	PV				
Pid	SV				
<table border="1"> <tr> <td>P</td> <td>PV</td> </tr> <tr> <td>5.0</td> <td>SV</td> </tr> </table>	P	PV	5.0	SV	3. Press the SEL key to enter CH1 (PID parameters). P is displayed.
P	PV				
5.0	SV				
<table border="1"> <tr> <td>bAL</td> <td>PV</td> </tr> <tr> <td>0.0</td> <td>SV</td> </tr> </table>	bAL	PV	0.0	SV	4. Use the Δ ∇ keys to change P to bAL. 5. Press the SEL key. (The first digit of the lower part of the screen begins to blink.)
bAL	PV				
0.0	SV				
<table border="1"> <tr> <td>3.0</td> <td>SV</td> </tr> </table>	3.0	SV	6. Use the Δ ∇ keys to change 0.0 to 3.0. 7. Press the SEL key to save the change.		
3.0	SV				
	8. Press the \odot key to return to the PV/SV display.				

AR Anti-reset windup (057)

[Description]

Anti-reset windup is a function that limits the range of valid integration to control overshooting.

Setting range Ar: 0 to 100% FS

- The anti-reset windup function (“AR”) cuts integration that falls outside of the Ar set range that is centered around SV. It is automatically set to the optimum value when auto-tuning is activated

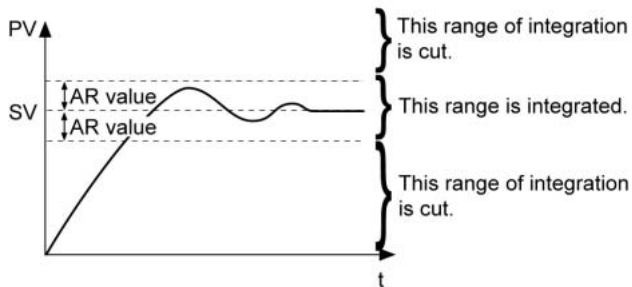

[Setting example] Changing the anti-reset windup to 500°C

Display	Operating procedure				
<table border="1"> <tr> <td>2 4 5</td> <td>PV</td> </tr> <tr> <td>250</td> <td>SV</td> </tr> </table>	2 4 5	PV	250	SV	<ol style="list-style-type: none"> 1. Check that the PV/SV display is shown. 2. Press and hold the SEL key to display CH1 (PID parameters). 3. Press the SEL key to enter CH1 (PID parameters). P is displayed. 4. Use the Δ ∇ keys to change P to AR. 5. Press the SEL key. (The first digit of the lower part of the screen begins to blink.) 6. Use the Δ ∇ keys to change 100 to 500. 7. Press the SEL key to save the change. 8. Press the ⏪ key to return to the PV/SV display.
2 4 5	PV				
250	SV				
<table border="1"> <tr> <td>CH 1</td> <td>PV</td> </tr> <tr> <td>Pid</td> <td>SV</td> </tr> </table>	CH 1	PV	Pid	SV	
CH 1	PV				
Pid	SV				
<table border="1"> <tr> <td>P</td> <td>PV</td> </tr> <tr> <td>5.0</td> <td>SV</td> </tr> </table>	P	PV	5.0	SV	
P	PV				
5.0	SV				
<table border="1"> <tr> <td>AR</td> <td>PV</td> </tr> <tr> <td>100</td> <td>SV</td> </tr> </table>	AR	PV	100	SV	
AR	PV				
100	SV				
<table border="1"> <tr> <td>500</td> <td>SV</td> </tr> </table>	500	SV			
500	SV				

REV Normal/reverse operation (058)

[Description]

Specifies whether the control operations are normal or reverse.

- Setting range

RV__:	heat (reverse) / cool (none)
No__:	heat (normal) / cool (none)
RVNo:	heat (reverse) / cool (normal)
NoRV:	heat (normal) / cool (reverse)
RVRV:	heat (reverse) / cool (reverse)
NoNo:	heat (normal) / cool (normal)

Most temperature control is done with heating in reverse and cooling in normal.

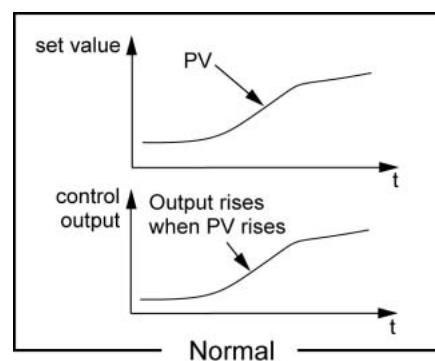
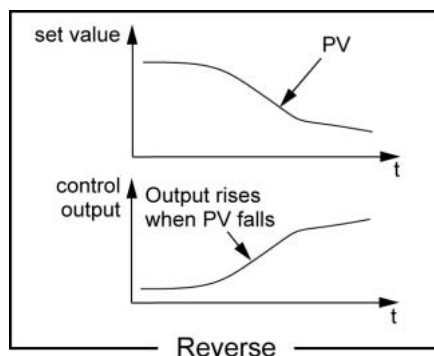

[Setting example] Setting the heating control to reverse, cooling control to normal action

Display	Operating procedure				
<table border="1" style="width: 100%;"> <tr> <td style="text-align: center; width: 80%;">2 4 5</td> <td style="text-align: center; width: 20%;">PV</td> </tr> <tr> <td style="text-align: center;">250</td> <td style="text-align: center;">SV</td> </tr> </table>	2 4 5	PV	250	SV	1. Check that the PV/SV display is shown.
2 4 5	PV				
250	SV				
<table border="1" style="width: 100%;"> <tr> <td style="text-align: center; width: 80%;">CH 1</td> <td style="text-align: center; width: 20%;">PV</td> </tr> <tr> <td style="text-align: center;">Pid</td> <td style="text-align: center;">SV</td> </tr> </table>	CH 1	PV	Pid	SV	2. Press and hold the SEL key to display CH1 (PID parameters).
CH 1	PV				
Pid	SV				
<table border="1" style="width: 100%;"> <tr> <td style="text-align: center; width: 80%;">P</td> <td style="text-align: center; width: 20%;">PV</td> </tr> <tr> <td style="text-align: center;">5.0</td> <td style="text-align: center;">SV</td> </tr> </table>	P	PV	5.0	SV	3. Press the SEL key to enter CH1 (PID parameters). P is displayed.
P	PV				
5.0	SV				
<table border="1" style="width: 100%;"> <tr> <td style="text-align: center; width: 80%;">REV</td> <td style="text-align: center; width: 20%;">PV</td> </tr> <tr> <td style="text-align: center;">RV__</td> <td style="text-align: center;">SV</td> </tr> </table>	REV	PV	RV__	SV	4. Use the Δ ∇ keys to change P to REV. 5. Press the SEL key. (The first digit of the lower part of the screen begins to blink.)
REV	PV				
RV__	SV				
<table border="1" style="width: 100%;"> <tr> <td style="text-align: center; width: 80%;">RVNo</td> <td style="text-align: center; width: 20%;">SV</td> </tr> </table>	RVNo	SV	6. Use the Δ ∇ keys to change RV__ to RVNo. 7. Press the SEL key to save the change.		
RVNo	SV				
	8. Press the \square key to return to the PV/SV display.				

SVL SV lower limit (059)

SVH SV upper limit (060)

[Description]

These parameters specify the setting range of the SV (Setting value). You can set any value within the measurement range.

- Setting range: 0 to 100% FS (Upper/Lower)

The relationship between SV limits and the measurement range is as follows:

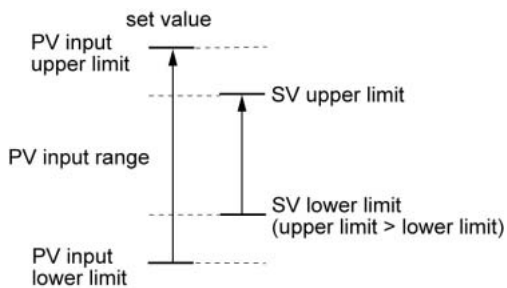

Note:

- Before setting SVH/SVL, be sure to set the following parameters in CH6 Setup parameters.
PV lower limit (PVb)/PV upper limit (PVF)
- SVs set before setting the SV limits (Local SV, Palette SV, etc.) are affected by new SV limits.
- Make sure to set the value of SVh greater than SVL.

[Setting example] Setting the lower SV limit to 50°C

Display	Operating procedure				
<table border="1"><tr><td>245</td><td>PV</td></tr><tr><td>250</td><td>SV</td></tr></table>	245	PV	250	SV	1. Check that the PV/SV display is shown.
245	PV				
250	SV				
<table border="1"><tr><td>CH 1</td><td>PV</td></tr><tr><td>Pid</td><td>SV</td></tr></table>	CH 1	PV	Pid	SV	2. Press and hold the SEL key to display CH1 (PID parameters).
CH 1	PV				
Pid	SV				
<table border="1"><tr><td>P</td><td>PV</td></tr><tr><td>5.0</td><td>SV</td></tr></table>	P	PV	5.0	SV	3. Press the SEL key to enter CH1 (PID parameters). P is displayed.
P	PV				
5.0	SV				
<table border="1"><tr><td>SVL</td><td>PV</td></tr><tr><td>0</td><td>SV</td></tr></table>	SVL	PV	0	SV	4. Use the Δ ∇ keys to change P to SVL. 5. Press the SEL key. (The first digit of the lower part of the screen begins to blink.)
SVL	PV				
0	SV				
<table border="1"><tr><td>50</td><td>SV</td></tr></table>	50	SV	6. Use the Δ ∇ keys to change 0 to 50. 7. Press the SEL key to save the change.		
50	SV				
	8. Press the \odot key to return to the PV/SV display.				

tC1 OUT1 proportional cycle (061)

tC2 OUT2 proportional cycle (062)

[Description]

When using contact output and SSR drive output with PV input inside the proportional band, output will switch between ON and OFF at regular intervals.

- These intervals are called proportional cycles. OUT1 and OUT2 can be set separately.

Setting range: 1 to 150

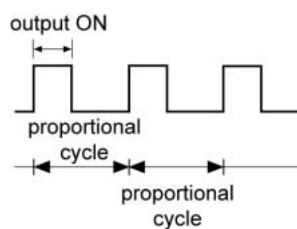

The following are the recommended settings for each control output.

Contact output	The shorter the proportional cycle, the finer the control, however shorter proportional cycles also shorten the lifespan of the contact points and operating device. Keep a balance between controllability and controller lifespan when adjusting the proportional cycles. Approx.: 30 sec
SSR drive output	Because there are no mechanical parts, use a short proportional cycle if the operating device is working properly. Approx.: 1 or 2 seconds

Note:

- TC2 is only valid when there are dual outputs.
- The proportional cycle for the current output is same as the blinking cycle of OUT indicator (approximately 1 second).

[Setting example] Setting OUT1 proportional cycle to 60 sec

Display	Operating procedure				
<table border="1"> <tr> <td>2 4 5</td> <td>PV</td> </tr> <tr> <td>250</td> <td>SV</td> </tr> </table>	2 4 5	PV	250	SV	<p>1. Check that the PV/SV display is shown.</p>
2 4 5	PV				
250	SV				
<table border="1"> <tr> <td>CH 1</td> <td>PV</td> </tr> <tr> <td>Pid</td> <td>SV</td> </tr> </table>	CH 1	PV	Pid	SV	<p>2. Press and hold the SEL key to display CH1 (PID parameters).</p>
CH 1	PV				
Pid	SV				
<table border="1"> <tr> <td>P</td> <td>PV</td> </tr> <tr> <td>5.0</td> <td>SV</td> </tr> </table>	P	PV	5.0	SV	<p>3. Press the SEL key to enter CH1 (PID parameters). P is displayed.</p>
P	PV				
5.0	SV				
<table border="1"> <tr> <td>t C 1</td> <td>PV</td> </tr> <tr> <td>30</td> <td>SV</td> </tr> </table>	t C 1	PV	30	SV	<p>4. Use the Δ ∇ keys to change P to tC1. 5. Press the SEL key. (The first digit of the lower part of the screen begins to blink.)</p>
t C 1	PV				
30	SV				
<table border="1"> <tr> <td>60</td> <td>SV</td> </tr> </table>	60	SV	<p>6. Use the Δ ∇ keys to change 30 to 60.</p>		
60	SV				
	<p>7. Press the SEL key to save the change.</p>				
	<p>8. Press the \square key to return to the PV/SV display.</p>				

PLC1 **PHC1** OUT1 Upper/Lower Limits (063, 064)

PLC2 **PHC2** OUT2 Upper/Lower Limits (065, 066)

[Description]

This parameter specifies the upper and lower limits for output control.

- Setting range

Output	Lower limit	Upper limit	Setting range
OUT1	PLC1	PHC1	-5.0 to 105.0%
OUT2	PLC2	PHC2	-5.0 to 105.0%

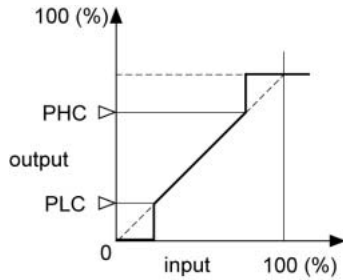

Related parameters: CH1 "Type of Output Limiter" (page 54)

Note:

Be sure to set the values so that PHC is greater than PLC.

[Setting example] Setting OUT1 lower limit to 5%

Display	Operating procedure				
<table border="1"> <tr> <td>2 4 5</td> <td>PV</td> </tr> <tr> <td>250</td> <td>SV</td> </tr> </table>	2 4 5	PV	250	SV	1. Check that the PV/SV display is shown.
2 4 5	PV				
250	SV				
<table border="1"> <tr> <td>CH 1</td> <td>PV</td> </tr> <tr> <td>Pid</td> <td>SV</td> </tr> </table>	CH 1	PV	Pid	SV	2. Press and hold the SEL key to display CH1 (PID parameters).
CH 1	PV				
Pid	SV				
<table border="1"> <tr> <td>P</td> <td>PV</td> </tr> <tr> <td>5.0</td> <td>SV</td> </tr> </table>	P	PV	5.0	SV	3. Press the SEL key to enter CH1 (PID parameters). P is displayed.
P	PV				
5.0	SV				
<table border="1"> <tr> <td>PLC 1</td> <td>PV</td> </tr> <tr> <td>-5.0</td> <td>SV</td> </tr> </table>	PLC 1	PV	-5.0	SV	4. Use the Δ ∇ keys to change P to PLC1.
PLC 1	PV				
-5.0	SV				
<table border="1"> <tr> <td>5.0</td> <td>SV</td> </tr> </table>	5.0	SV	5. Press the SEL key. (The first digit of the lower part of the screen begins to blink.)		
5.0	SV				
<table border="1"> <tr> <td>5.0</td> <td>SV</td> </tr> </table>	5.0	SV	6. Use the Δ ∇ keys to change -5.0 to 5.0.		
5.0	SV				
	7. Press the SEL key to save the change.				
	8. Press the \ominus key to return to the PV/SV display.				

PCUt Type of output limiter (067)

[Description]

You can choose whether to apply the limit on the output value or let it exceed the limit.

The output changes according to the limit, as follows.

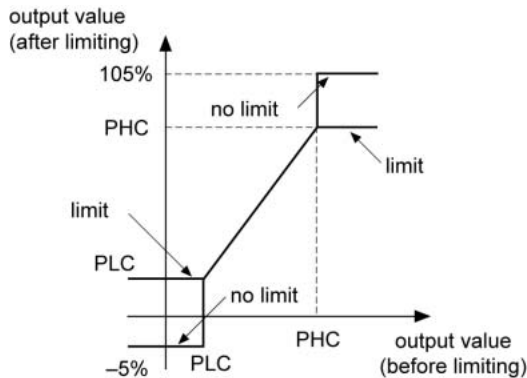

Setting range

Setting	Output 1 (OUT1)		Output 2 (OUT2)	
	Lower limit	Upper limit	Lower limit	Upper limit
0	-5%	105%	-5%	105%
1	limit	105%	-5%	105%
2	-5%	limit	-5%	105%
3	limit	limit	-5%	105%
4	-5%	105%	limit	105%
5	limit	105%	limit	105%
6	-5%	limit	limit	105%
7	limit	limit	limit	105%
8	-5%	105%	-5%	limit
9	limit	105%	-5%	limit
10	-5%	limit	-5%	limit
11	limit	limit	-5%	limit
12	-5%	105%	limit	limit
13	limit	105%	limit	limit
14	-5%	limit	limit	limit
15	limit	limit	limit	limit

[Setting example] Setting to keep all the outputs within limits

Display	Operating procedure				
<table border="1"> <tr><td>2 4 5</td><td>PV</td></tr> <tr><td>250</td><td>SV</td></tr> </table>	2 4 5	PV	250	SV	<ol style="list-style-type: none"> 1. Check that the PV/SV display is shown. 2. Press and hold the SEL key to display CH1 (PID parameters). 3. Press the SEL key to enter CH1 (PID parameters). P is displayed. 4. Use the Δ ∇ keys to change P to PCUt. 5. Press the SEL key. (The first digit of the lower part of the screen begins to blink.) 6. Use the Δ ∇ keys to change 0 to 15 (limit all). 7. Press the SEL key to save the change. 8. Press the \square key to return to the PV/SV display.
2 4 5	PV				
250	SV				
<table border="1"> <tr><td>CH 1</td><td>PV</td></tr> <tr><td>Pid</td><td>SV</td></tr> </table>	CH 1	PV	Pid	SV	
CH 1	PV				
Pid	SV				
<table border="1"> <tr><td>P</td><td>PV</td></tr> <tr><td>5.0</td><td>SV</td></tr> </table>	P	PV	5.0	SV	
P	PV				
5.0	SV				
<table border="1"> <tr><td>PCUt</td><td>PV</td></tr> <tr><td>0</td><td>SV</td></tr> </table>	PCUt	PV	0	SV	
PCUt	PV				
0	SV				
<table border="1"> <tr><td>15</td><td>SV</td></tr> </table>	15	SV			
15	SV				

ALPA 2-degrees-of-freedom coefficient α (073)

bEtA 2-degrees-of-freedom coefficient β (074)

[Description]

These coefficients are used to suppress overshoot generated in PID control.

The 2-degrees-of-freedom PID system of this instrument adopts set value (SV) filter method, which is effective in suppressing overshoot at the time of setting change or start-up.

If ALPA (α) is set to 100.0%, and bEtA (β) to 0.0%, ordinary PID control (1 degree of freedom PID) is performed.

Adjust ALPA (α) and bEtA (β) as follows.

(1) Set ALPA (α) to 40.0%, and bEtA (β) to 100.0%. (Factory default setting)

(2) Perform control and check responsiveness (overshoot volume).

If overshoot cannot be improved in this stage, adjust ALPA (α) and bEtA (β), following the definition listed in the following table.

Generally, ALPA (α) does not require adjustment. Therefore, it is recommended to use the instrument with ALPA (α) set to 40.0%.

Result of control	bEtA	ALPA
Large overshoot	Increase BETA (β) by 20%	Decrease ALPA (α) by 10%
Small overshoot	Decrease BETA (β) by 20%	Increase ALPA (α) by 10%

Setting range

ALPA	-300.0 to 300.0
bEtA	0.0 to 900.0

[2 degrees of freedom PID block diagram]

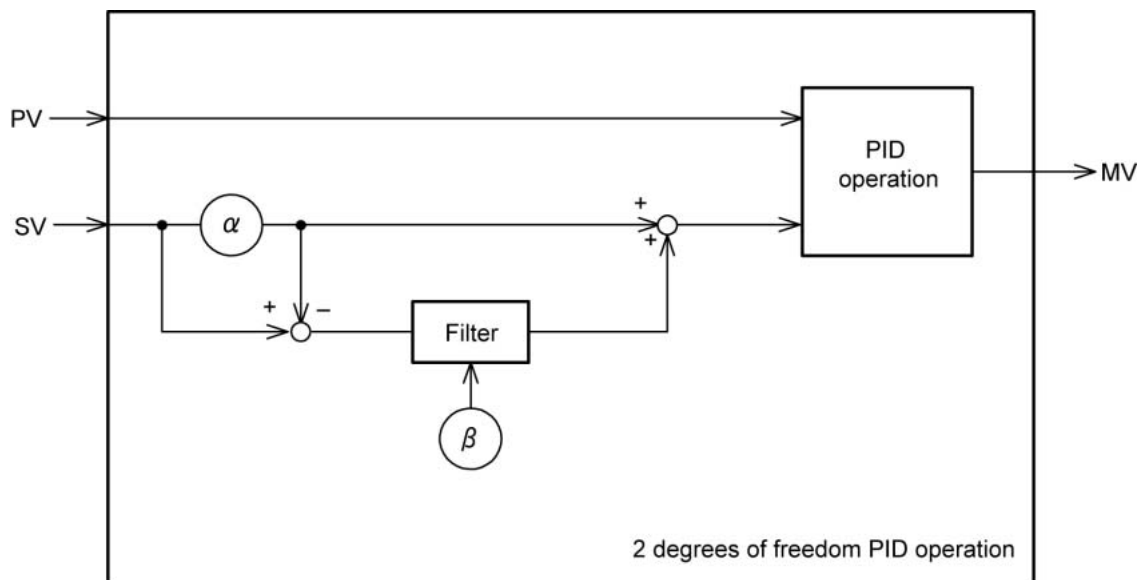

Note:

Changing ALPA (α) should be performed during manual mode.

Before changing ALPA (α) setting, set bEtA (β) to 0.0%. First, change ALPA (α) setting, and then set bEtA (β) to desired value. Improper procedure may cause output (target value) to increase temporarily, thus posing danger.

The purpose of this function is to suppress overshoot generated in ordinary PID control. Overshoot may not always be eliminated.

[Setting example] Setting the 2-degrees-of-freedom coefficient α to 50.0%

Display	Operating procedure				
<table border="1"> <tr> <td data-bbox="108 282 331 353">2 4 5</td> <td data-bbox="331 282 384 353">PV</td> </tr> <tr> <td data-bbox="108 353 331 416">250</td> <td data-bbox="331 353 384 416">SV</td> </tr> </table>	2 4 5	PV	250	SV	<p>1. Check that the PV/SV display is shown.</p>
2 4 5	PV				
250	SV				
<table border="1"> <tr> <td data-bbox="108 450 331 521">CH 1</td> <td data-bbox="331 450 384 521">PV</td> </tr> <tr> <td data-bbox="108 521 331 584">Pid</td> <td data-bbox="331 521 384 584">SV</td> </tr> </table>	CH 1	PV	Pid	SV	<p>2. Press and hold the SEL key to display CH1 (PID parameters).</p>
CH 1	PV				
Pid	SV				
<table border="1"> <tr> <td data-bbox="108 618 331 689">P</td> <td data-bbox="331 618 384 689">PV</td> </tr> <tr> <td data-bbox="108 689 331 752">5.0</td> <td data-bbox="331 689 384 752">SV</td> </tr> </table>	P	PV	5.0	SV	<p>3. Press the SEL key to enter CH1 (PID parameters). P is displayed.</p>
P	PV				
5.0	SV				
<table border="1"> <tr> <td data-bbox="108 786 331 857">ALPA</td> <td data-bbox="331 786 384 857">PV</td> </tr> <tr> <td data-bbox="108 857 331 920">40.0</td> <td data-bbox="331 857 384 920">SV</td> </tr> </table>	ALPA	PV	40.0	SV	<p>4. Use the \uparrow \downarrow keys to change P to ALPA. 5. Press the SEL key. (The first digit of the lower part of the screen begins to blink.)</p>
ALPA	PV				
40.0	SV				
<table border="1"> <tr> <td data-bbox="108 954 331 1010">50.0</td> <td data-bbox="331 954 384 1010">SV</td> </tr> </table>	50.0	SV	<p>6. Use the \uparrow \downarrow keys to change 40.0 to 50.0.</p>		
50.0	SV				
	<p>7. Press the SEL key to save the change.</p>				
	<p>8. Press the \leftarrow key to return to the PV/SV display.</p>				

3-3 CH2 PLT (PID palette parameters)

PID palette parameters are used to register SVs, PIDs, and other control parameters. Up to seven sets of SVs and PIDs can be stored, and you can toggle among them by simply selecting their numbers.

This is very useful when operating conditions change frequently.

The palette menu (CH2) consists of the following function blocks:

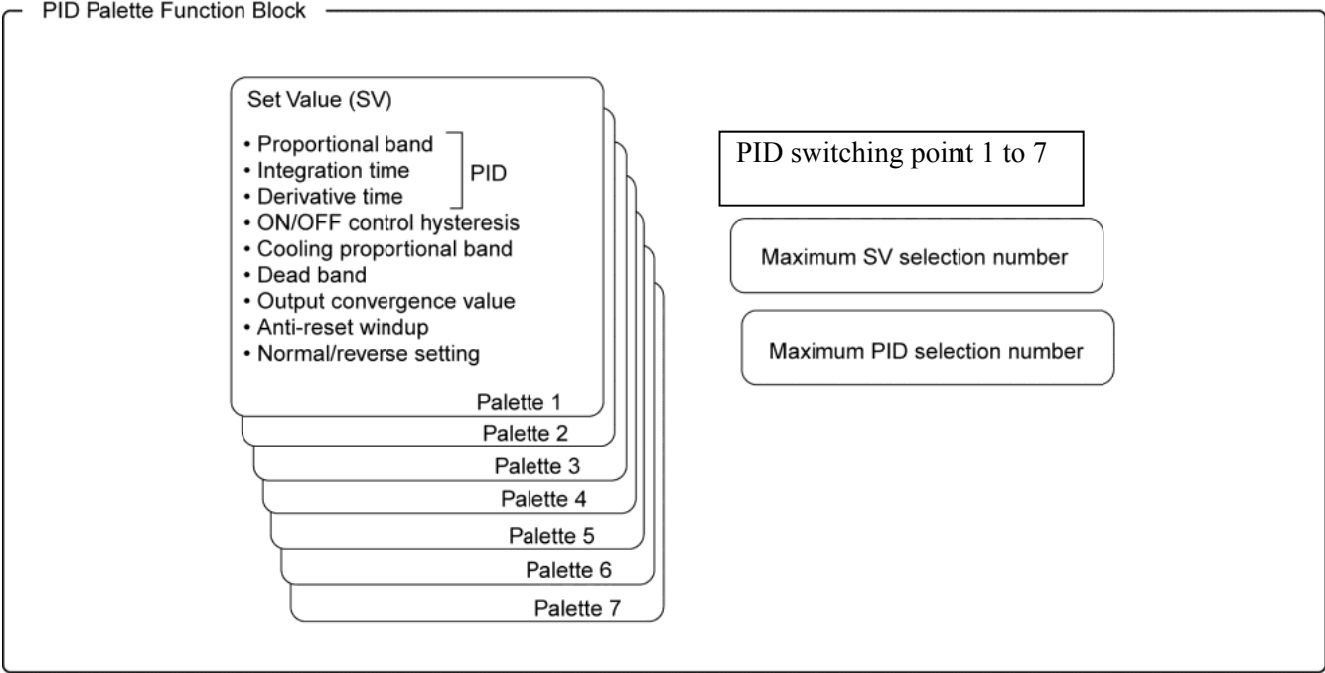

To change the SV No. or PID No., refer to "SV selection" (page 36), "PID selection" (page 37).

SV1 to SV7 Set Value (100 to 160)

[Description]





Up to seven SVs (SV1-SV7) can be recorded. Recorded SVs can be invoked by the SV selection ("Svn") parameter in the operation menu.

Setting range: SV lower limit (SVL) to SV upper limit (SVH) %FS

It is recommended to activate the ramp SV before changing SV number, so that control disorders can be reduced.

Related parameters: "SV selection" (page 36)

[Setting example] Setting SV1 to 300°C

Display	Operating procedure				
<table border="1"> <tr> <td data-bbox="108 680 331 748">2 4 5</td> <td data-bbox="336 680 379 748">PV</td> </tr> <tr> <td data-bbox="108 754 331 819">250</td> <td data-bbox="336 754 379 819">SV</td> </tr> </table>	2 4 5	PV	250	SV	<p>1. Check that the PV/SV display is shown.</p>
2 4 5	PV				
250	SV				
<table border="1"> <tr> <td data-bbox="108 871 331 938">CH 2</td> <td data-bbox="336 871 379 938">PV</td> </tr> <tr> <td data-bbox="108 945 331 987">PLt</td> <td data-bbox="336 945 379 987">SV</td> </tr> </table>	CH 2	PV	PLt	SV	<p>2. Press and hold the SEL key to display CH1 (PID parameters).</p> <p>3. Press the  key to access CH2 (PID palette parameters).</p>
CH 2	PV				
PLt	SV				
<table border="1"> <tr> <td data-bbox="108 1106 331 1173">SV 1</td> <td data-bbox="336 1106 379 1173">PV</td> </tr> <tr> <td data-bbox="108 1180 331 1223">0</td> <td data-bbox="336 1180 379 1223">SV</td> </tr> </table>	SV 1	PV	0	SV	<p>4. Press the SEL key to enter CH2 (PID palette parameters). SV1 (set value) is displayed.</p> <p>5. Press the SEL key. (The first digit of the lower part of the screen begins to blink.)</p>
SV 1	PV				
0	SV				
<table border="1"> <tr> <td data-bbox="108 1252 331 1312">300</td> <td data-bbox="336 1252 379 1312">SV</td> </tr> </table>	300	SV	<p>6. Use the   keys to change 0 to 300.</p> <p>7. Press the SEL key to save the change.</p> <p>8. To set SV2 to SV7, press the  key in the step 4 and then repeat steps 5 to 7.</p>		
300	SV				
	<p>9. Press the  key to return to the PV/SV display.</p>				

P1 to **P7** Proportional band (101 to 161)

i1 to **i7** Integration time (102 to 162)

d1 to **d7** Differential time (103 to 163)

[Description] _____

These parameters allows you to configure PID. Up to seven types of PID (palettes 1 to 7) can be recorded.

Recorded PIDs can be called from selected PID number ("PLN1") in the operation menu CH1.

- Setting range

Proportional band (P): 0.0 to 999.9%

Integration time (I): 0 to 3200 seconds

Differential time (D): 0.0 to 999.9 seconds

Related parameters: "Proportional Band, Integration Time, Differential Time (CH1)" (page 41)

When a PID No. is changed, the following parameters change to match it.







- ON/OFF control hysteresis
- Cooling proportional band
- Dead band
- Output convergence value
- Anti-reset windup
- Normal/reverse operation

Running auto-tuning will automatically set to the PID No. selected in the PID selection parameter.

Note:

- For safety, make sure to turn off the power before switching the normal/reverse operations by using the PID selection function. (Do not switch between normal and reverse while operation.)
- If "(PID No. +1, SV No. +1(increment))" function is executed under the "PID No. ≠ SV No.", PID No. and SV No. is automatically set to the same value.
- PID is switched per palette. You cannot combine the values of PID among palettes.

[Setting example] Setting P = 10.0%, I = 100 sec., D = 20 sec.

Display	Operating procedure				
<table border="1"> <tr> <td>2 4 5</td> <td>PV</td> </tr> <tr> <td>250</td> <td>SV</td> </tr> </table>	2 4 5	PV	250	SV	<p>1. Check that the PV/SV display is shown.</p>
2 4 5	PV				
250	SV				
<table border="1"> <tr> <td>CH 2</td> <td>PV</td> </tr> <tr> <td>PLt</td> <td>SV</td> </tr> </table>	CH 2	PV	PLt	SV	<p>2. Press and hold the SEL key to display CH1 (PID parameters).</p> <p>3. Press the  key to access CH2 (PID palette parameters).</p>
CH 2	PV				
PLt	SV				
<table border="1"> <tr> <td>SV 1</td> <td>PV</td> </tr> <tr> <td>0</td> <td>SV</td> </tr> </table>	SV 1	PV	0	SV	<p>4. Press the SEL key to enter CH2 (PID palette parameters). SV1 (set value) is displayed.</p>
SV 1	PV				
0	SV				
<table border="1"> <tr> <td>P1</td> <td>PV</td> </tr> <tr> <td>10.0</td> <td>SV</td> </tr> </table>	P1	PV	10.0	SV	<p>5. Use the   keys to change SV1 to P1.</p> <p>6. Press the SEL key. (The first digit of the lower part of the screen begins to blink.)</p>
P1	PV				
10.0	SV				
<table border="1"> <tr> <td>i1</td> <td>PV</td> </tr> <tr> <td>100</td> <td>SV</td> </tr> </table>	i1	PV	100	SV	<p>7. Use the   keys to change 5.0 to 10.0.</p> <p>8. Press the SEL key to save the change.</p>
i1	PV				
100	SV				
<table border="1"> <tr> <td>d 1</td> <td>PV</td> </tr> <tr> <td>20</td> <td>SV</td> </tr> </table>	d 1	PV	20	SV	<p>9. Use the  key to change 100 to 20.</p> <p>10. Repeat the same steps to set Pid2 to Pid7.</p> <p>11. Press the  key to return to the PV/SV display.</p>
d 1	PV				
20	SV				

HYS1 to **HYS7** ON/OFF control hysteresis (104 to 164)







[Description]

This parameter allows you to set the hysteresis width for the ON/OFF control. Up to seven types of hysteresis (for palettes 1 to 7) can be recorded. Recorded hysteresis can be called by PID selection ("PLN1") in the operation mode.

- Setting range: 0 to 50% FS

Related parameters: "ON/OFF control hysteresis" (page 43)

[Setting example] Setting the ON/OFF control hysteresis 1 to 3°C

Display	Operating procedure				
<table border="1"> <tr> <td>2 4 5</td> <td>PV</td> </tr> <tr> <td>250</td> <td>SV</td> </tr> </table>	2 4 5	PV	250	SV	<p>1. Check that the PV/SV display is shown.</p>
2 4 5	PV				
250	SV				
<table border="1"> <tr> <td>CH 2</td> <td>PV</td> </tr> <tr> <td>PLt</td> <td>SV</td> </tr> </table>	CH 2	PV	PLt	SV	<p>2. Press and hold the SEL key to display CH1 (PID parameters).</p> <p>3. Press the  key to access CH2 (PID palette parameters).</p>
CH 2	PV				
PLt	SV				
<table border="1"> <tr> <td>SV 1</td> <td>PV</td> </tr> <tr> <td>0</td> <td>SV</td> </tr> </table>	SV 1	PV	0	SV	<p>4. Press the SEL key to enter CH2 (PID palette parameters). SV1 (set value) is displayed.</p>
SV 1	PV				
0	SV				
<table border="1"> <tr> <td>HYS 1</td> <td>PV</td> </tr> <tr> <td>1</td> <td>SV</td> </tr> </table>	HYS 1	PV	1	SV	<p>5. Use the   keys to change SV1 to HYS1.</p> <p>6. Press the SEL key. (The first digit of the lower part of the screen begins to blink.)</p>
HYS 1	PV				
1	SV				
<table border="1"> <tr> <td>3</td> <td>SV</td> </tr> </table>	3	SV	<p>7. Use the   keys to change 1 to 3.</p> <p>8. Press the SEL key to save the change.</p> <p>9. Repeat the same steps to set HYS2 to HYS7.</p>		
3	SV				
	<p>10. Press the  key to return to the PV/SV display.</p>				

CoL1 to CoL7 Cooling Proportional Band (105 to 165)

[Description]

Allows you to set the cooling proportional band when dual outputs are selected. Up to seven types of cooling proportional band (for palettes 1 to 7) can be recorded.

Recorded cooling proportional band can be called from PID selection ("PLN1") in the operation mode.

- Setting range: 0.0% to 100.0%

Related parameters: "Cooling Proportional Band Coefficient" (p. 45)

[Setting example] Setting the Cooling proportional band 1 to 5.0%

Display	Operating procedure				
<table border="1"> <tr> <td>2 4 5</td> <td>PV</td> </tr> <tr> <td>250</td> <td>SV</td> </tr> </table>	2 4 5	PV	250	SV	1. Check that the PV/SV display is shown.
2 4 5	PV				
250	SV				
<table border="1"> <tr> <td>CH 2</td> <td>PV</td> </tr> <tr> <td>PLt</td> <td>SV</td> </tr> </table>	CH 2	PV	PLt	SV	2. Press and hold the SEL key to display CH1 (PID parameters).
CH 2	PV				
PLt	SV				
	3. Press the \odot key to access CH2 (PID palette parameters).				
<table border="1"> <tr> <td>SV 1</td> <td>PV</td> </tr> <tr> <td>0</td> <td>SV</td> </tr> </table>	SV 1	PV	0	SV	4. Press the SEL key to enter CH2 (PID palette parameters). SV1 (set value) is displayed.
SV 1	PV				
0	SV				
	5. Use the \wedge \vee keys to change SV1 to CoL1.				
<table border="1"> <tr> <td>CoL 1</td> <td>PV</td> </tr> <tr> <td>1.0</td> <td>SV</td> </tr> </table>	CoL 1	PV	1.0	SV	6. Press the SEL key. (The first digit of the lower part of the screen begins to blink.)
CoL 1	PV				
1.0	SV				
<table border="1"> <tr> <td>5.0</td> <td>SV</td> </tr> </table>	5.0	SV	7. Use the \wedge \vee keys to change 1.0 to 5.0.		
5.0	SV				
	8. Press the SEL key to save the change.				
	9. Repeat the same steps to set CoL2 to CoL7.				
	10. Press the \odot key to return to the PV/SV display.				

db1 to **db7** Dead band (106 to 166)

[Description]







Allows you to set the dead band when dual outputs are selected. Up to seven types of dead band (for palettes 1 to 7) can be recorded.

Recorded dead band can be called from PID selection ("PLN1") in the operation mode.

- Setting range: -50.0% to 50.0%

Related parameters: "Dead Band" (page 46)

[Setting example] Setting Dead band 1 to 7.0%

Display	Operating procedure				
<table border="1"> <tr> <td data-bbox="220 645 443 712">2 4 5</td> <td data-bbox="443 645 501 712">PV</td> </tr> <tr> <td data-bbox="220 712 443 779">250</td> <td data-bbox="443 712 501 779">SV</td> </tr> </table>	2 4 5	PV	250	SV	<p>1. Check that the PV/SV display is shown.</p>
2 4 5	PV				
250	SV				
<table border="1"> <tr> <td data-bbox="220 813 443 880">CH 2</td> <td data-bbox="443 813 501 880">PV</td> </tr> <tr> <td data-bbox="220 880 443 947">PLt</td> <td data-bbox="443 880 501 947">SV</td> </tr> </table>	CH 2	PV	PLt	SV	<p>2. Press and hold the SEL key to display CH1 (PID parameters).</p> <p>3. Press the  key to access CH2 (PID palette parameters).</p>
CH 2	PV				
PLt	SV				
<table border="1"> <tr> <td data-bbox="220 981 443 1048">SV 1</td> <td data-bbox="443 981 501 1048">PV</td> </tr> <tr> <td data-bbox="220 1048 443 1115">0</td> <td data-bbox="443 1048 501 1115">SV</td> </tr> </table>	SV 1	PV	0	SV	<p>4. Press the SEL key to enter CH2 (PID palette parameters). SV1 (set value) is displayed.</p>
SV 1	PV				
0	SV				
<table border="1"> <tr> <td data-bbox="220 1149 443 1216">db 1</td> <td data-bbox="443 1149 501 1216">PV</td> </tr> <tr> <td data-bbox="220 1216 443 1283">0.0</td> <td data-bbox="443 1216 501 1283">SV</td> </tr> </table>	db 1	PV	0.0	SV	<p>5. Use the   keys to change SV1 to db1.</p> <p>6. Press the SEL key. (The first digit of the lower part of the screen begins to blink.)</p>
db 1	PV				
0.0	SV				
<table border="1"> <tr> <td data-bbox="220 1317 443 1384">7.0</td> <td data-bbox="443 1317 501 1384">SV</td> </tr> </table>	7.0	SV	<p>7. Use the   keys to change 0.0 to 7.0.</p> <p>8. Press the SEL key to save the change.</p>		
7.0	SV				
	<p>9. Repeat the same steps to set db2 to db7.</p> <p>10. Press the  key to return to the PV/SV display.</p>				

bAL1 to bAL7 Output convergence value (107 to 167)







[Description]

Allows you to set the output convergence value. Up to seven types of output convergence value (for palettes 1 to 7) can be recorded. Recorded output convergence value can be called from PID selection ("PLN1") in the operation mode.

- Setting range: -100.0% to 100.0%

Related parameters: "Output Convergence Value" (page 47)

[Setting example] Setting Output convergence value 1 to -5.5%

Display	Operating procedure				
<table border="1" style="width: 100%; border-collapse: collapse;"> <tr> <td style="text-align: center; width: 80%;">2 4 5</td> <td style="text-align: center; width: 20%;">PV</td> </tr> <tr> <td style="text-align: center;">250</td> <td style="text-align: center;">SV</td> </tr> </table>	2 4 5	PV	250	SV	<p>1. Check that the PV/SV display is shown.</p>
2 4 5	PV				
250	SV				
<table border="1" style="width: 100%; border-collapse: collapse;"> <tr> <td style="text-align: center; width: 80%;">CH 2</td> <td style="text-align: center; width: 20%;">PV</td> </tr> <tr> <td style="text-align: center;">PLt</td> <td style="text-align: center;">SV</td> </tr> </table>	CH 2	PV	PLt	SV	<p>2. Press and hold the SEL key to display CH1 (PID parameters).</p> <p>3. Press the  key to access CH2 (PID palette parameters).</p>
CH 2	PV				
PLt	SV				
<table border="1" style="width: 100%; border-collapse: collapse;"> <tr> <td style="text-align: center; width: 80%;">SV 1</td> <td style="text-align: center; width: 20%;">PV</td> </tr> <tr> <td style="text-align: center;">0</td> <td style="text-align: center;">SV</td> </tr> </table>	SV 1	PV	0	SV	<p>4. Press the SEL key to enter CH2 (PID palette parameters). SV1 (set value) is displayed.</p>
SV 1	PV				
0	SV				
<table border="1" style="width: 100%; border-collapse: collapse;"> <tr> <td style="text-align: center; width: 80%;">bAL 1</td> <td style="text-align: center; width: 20%;">PV</td> </tr> <tr> <td style="text-align: center;">0.0</td> <td style="text-align: center;">SV</td> </tr> </table>	bAL 1	PV	0.0	SV	<p>5. Use the   keys to change SV1 to bAL1.</p> <p>6. Press the SEL key. (The first digit of the lower part of the screen begins to blink.)</p>
bAL 1	PV				
0.0	SV				
<table border="1" style="width: 100%; border-collapse: collapse;"> <tr> <td style="text-align: center; width: 80%;">-5.5</td> <td style="text-align: center; width: 20%;">SV</td> </tr> </table>	-5.5	SV	<p>7. Use the   keys to change 0.0 to -5.5.</p>		
-5.5	SV				
	<p>8. Press the SEL key to save the change.</p>				
	<p>9. Repeat the same steps to set bAL2 to bAL7.</p>				
	<p>10. Press the  key to return to the PV/SV display.</p>				

AR1 to AR7 Anti-reset windup (108 to 168)

[Description]

Allows you to set the anti-reset windup. Up to seven types of anti-reset windup (for palettes 1 to 7) can be recorded.

Recorded anti-reset windup can be called from PID selection ("PLN1") in the operation mode.

- Setting range: 0.0% to 100.0%

Related parameters: "Anti-reset windup" (page 48)

[Setting example] Setting the anti-reset windup 1 to 50 FS

Display	Operating procedure				
<table border="1"> <tr> <td>2 4 5</td> <td>PV</td> </tr> <tr> <td>250</td> <td>SV</td> </tr> </table>	2 4 5	PV	250	SV	1. Check that the PV/SV display is shown.
2 4 5	PV				
250	SV				
<table border="1"> <tr> <td>CH 2</td> <td>PV</td> </tr> <tr> <td>PLt</td> <td>SV</td> </tr> </table>	CH 2	PV	PLt	SV	2. Press and hold the SEL key to display CH1 (PID parameters).
CH 2	PV				
PLt	SV				
	3. Press the \odot key to access CH2 (PID palette parameters).				
<table border="1"> <tr> <td>SV 1</td> <td>PV</td> </tr> <tr> <td>0</td> <td>SV</td> </tr> </table>	SV 1	PV	0	SV	4. Press the SEL key to enter CH2 (PID palette parameters). SV1 (set value) is displayed.
SV 1	PV				
0	SV				
<table border="1"> <tr> <td>AR 1</td> <td>PV</td> </tr> <tr> <td>100</td> <td>SV</td> </tr> </table>	AR 1	PV	100	SV	5. Use the \wedge \vee keys to change SV1 to AR1.
AR 1	PV				
100	SV				
	6. Press the SEL key. (The first digit of the lower part of the screen begins to blink.)				
<table border="1"> <tr> <td>50</td> <td>SV</td> </tr> </table>	50	SV	7. Use the \wedge \vee keys to change 100 to 50.		
50	SV				
	8. Press the SEL key to save the change.				
	9. Repeat the same steps to set bAL2 to bAL7.				
	10. Press the \odot key to return to the PV/SV display.				

REV1 to **REV7** Normal/reverse (109 to 169)

[Description] _____







Allows you to set the normal/reverse setting. Up to seven types of normal/reverse settings (for palettes 1 to 7) can be recorded.

Recorded normal/reverse settings can be called from PID selection ("PLN1") in the operation mode.

Range	Control operation
RV__	heat (reverse) / cool (none)
No__	heat (normal) / cool (none)
RVNo	heat (reverse) / cool (normal)
NoRV	heat (normal) / cool (reverse)
RVRV	heat (reverse) / cool (reverse)
NoNo	heat (normal) / cool (normal)

Related parameters: "Normal/Reverse" (CH1) (page 49)

[Setting example] Setting the normal/reverse 1 to heat (reverse)/ cool (normal) _____

Display	Operating procedure				
<table border="1"> <tr> <td>2 4 5</td> <td>PV</td> </tr> <tr> <td>250</td> <td>SV</td> </tr> </table>	2 4 5	PV	250	SV	<ol style="list-style-type: none"> 1. Check that the PV/SV display is shown. 2. Press and hold the SEL key to display CH1 (PID parameters). 3. Press the  key to access CH2 (PID palette parameters). 4. Press the SEL key to enter CH2 (PID palette parameters). SV1 (set value) is displayed. 5. Use the   keys to change SV1 to REV1. 6. Press the SEL key. (The first digit of the lower part of the screen begins to blink.) 7. Use the   keys to change "RV" to "RVNo". 8. Press the SEL key to save the change. 9. Repeat the same steps to set REV2 to REV7. 10. Press the  key to return to the PV/SV display.
2 4 5	PV				
250	SV				
<table border="1"> <tr> <td>CH 2</td> <td>PV</td> </tr> <tr> <td>PLt</td> <td>SV</td> </tr> </table>	CH 2	PV	PLt	SV	
CH 2	PV				
PLt	SV				
<table border="1"> <tr> <td>SV 1</td> <td>PV</td> </tr> <tr> <td>0</td> <td>SV</td> </tr> </table>	SV 1	PV	0	SV	
SV 1	PV				
0	SV				
<table border="1"> <tr> <td>REV 1</td> <td>PV</td> </tr> <tr> <td>RV__</td> <td>SV</td> </tr> </table>	REV 1	PV	RV__	SV	
REV 1	PV				
RV__	SV				
<table border="1"> <tr> <td>RVNo</td> <td>SV</td> </tr> </table>	RVNo	SV			
RVNo	SV				

REF1 to **REF7** PID palette switching point (170 to 176)







[Description] _____

This parameter allows you to set threshold value at which the controller automatically switches among PID palettes.

- Setting range: 0 to 100% FS

Related parameters: PID palette switching method (CH 7) (page 161)

[Setting example] Setting the PID palette switching point 1 to 30% FS _____

Display	Operating procedure				
<table border="1" style="width: 100%; text-align: center;"> <tr> <td style="width: 80%;">2 4 5</td> <td style="width: 20%;">PV</td> </tr> <tr> <td>250</td> <td>SV</td> </tr> </table>	2 4 5	PV	250	SV	<p>1. Check that the PV/SV display is shown.</p>
2 4 5	PV				
250	SV				
<table border="1" style="width: 100%; text-align: center;"> <tr> <td style="width: 80%;">CH 2</td> <td style="width: 20%;">PV</td> </tr> <tr> <td>PLt</td> <td>SV</td> </tr> </table>	CH 2	PV	PLt	SV	<p>2. Press and hold the SEL key to display CH1 (PID parameters).</p> <p>3. Press the  key to access CH2 (PID palette parameters).</p>
CH 2	PV				
PLt	SV				
<table border="1" style="width: 100%; text-align: center;"> <tr> <td style="width: 80%;">SV 1</td> <td style="width: 20%;">PV</td> </tr> <tr> <td>0</td> <td>SV</td> </tr> </table>	SV 1	PV	0	SV	<p>4. Press the SEL key to enter CH2 (PID palette parameters). SV1 (set value) is displayed.</p>
SV 1	PV				
0	SV				
<table border="1" style="width: 100%; text-align: center;"> <tr> <td style="width: 80%;">REF 1</td> <td style="width: 20%;">PV</td> </tr> <tr> <td>0</td> <td>SV</td> </tr> </table>	REF 1	PV	0	SV	<p>5. Use the   keys to change SV1 to REF1.</p> <p>6. Press the SEL key. (The first digit of the lower part of the screen begins to blink.)</p>
REF 1	PV				
0	SV				
<table border="1" style="width: 100%; text-align: center;"> <tr> <td style="width: 80%;">30</td> <td style="width: 20%;">SV</td> </tr> </table>	30	SV	<p>7. Use the   keys to change 0 to 30.</p> <p>8. Press the SEL key to save the change.</p> <p>9. Repeat the same steps to set REF2 to REF7.</p>		
30	SV				
	<p>10. Press the  key to return to the PV/SV display.</p>				

SVMX Max SV selection number (177)







[Description]

Allows you to set the maximum SV number that can be selected via the USER key.

- Setting range: SV1 to SV7, LoCL, di

Related parameters: "User key assignment" (CH 7) (page 141)

[Setting example] Setting the max. SV selection number to SV4

Display	Operating procedure				
<table border="1"> <tr> <td>2 4 5</td> <td>PV</td> </tr> <tr> <td>250</td> <td>SV</td> </tr> </table>	2 4 5	PV	250	SV	<p>1. Check that the PV/SV display is shown.</p>
2 4 5	PV				
250	SV				
<table border="1"> <tr> <td>CH 2</td> <td>PV</td> </tr> <tr> <td>PLt</td> <td>SV</td> </tr> </table>	CH 2	PV	PLt	SV	<p>2. Press and hold the SEL key to display CH1 (PID parameters).</p> <p>3. Press the  key to access CH2 (PID palette parameters).</p>
CH 2	PV				
PLt	SV				
<table border="1"> <tr> <td>SV 1</td> <td>PV</td> </tr> <tr> <td>0</td> <td>SV</td> </tr> </table>	SV 1	PV	0	SV	<p>4. Press the SEL key to enter CH2 (PID palette parameters). SV1 (set value) is displayed.</p>
SV 1	PV				
0	SV				
<table border="1"> <tr> <td>SVMX</td> <td>PV</td> </tr> <tr> <td>SV7</td> <td>SV</td> </tr> </table>	SVMX	PV	SV7	SV	<p>5. Use the   keys to change SV1 to SVMX.</p> <p>6. Press the SEL key. (The first digit of the lower part of the screen begins to blink.)</p>
SVMX	PV				
SV7	SV				
<table border="1"> <tr> <td>SV4</td> <td>SV</td> </tr> </table>	SV4	SV	<p>7. Use the   keys to change SV7 to SV4.</p> <p>8. Press the SEL key to save the change.</p>		
SV4	SV				
	<p>9. Press the  key to return to the PV/SV display.</p>				

PL1M Max PID selection number (178)







[Description]

Allows you to set the maximum PID number that can be selected via the USER key.

- Setting range: Pid1 to Pid7, LoCL, di

Related parameters: "User key assignment" (CH 7) (page 141)

[Setting example] Setting the max. PID selection number to PID6

Display	Operating procedure				
<table border="1"> <tr> <td>2 4 5</td> <td>PV</td> </tr> <tr> <td>250</td> <td>SV</td> </tr> </table>	2 4 5	PV	250	SV	<p>1. Check that the PV/SV display is shown.</p>
2 4 5	PV				
250	SV				
<table border="1"> <tr> <td>CH 2</td> <td>PV</td> </tr> <tr> <td>PLt</td> <td>SV</td> </tr> </table>	CH 2	PV	PLt	SV	<p>2. Press and hold the SEL key to display CH1 (PID parameters).</p> <p>3. Press the  key to access CH2 (PID palette parameters).</p>
CH 2	PV				
PLt	SV				
<table border="1"> <tr> <td>SV 1</td> <td>PV</td> </tr> <tr> <td>0</td> <td>SV</td> </tr> </table>	SV 1	PV	0	SV	<p>4. Press the SEL key to enter CH2 (PID palette parameters). SV1 (set value) is displayed.</p>
SV 1	PV				
0	SV				
<table border="1"> <tr> <td>PL 1M</td> <td>PV</td> </tr> <tr> <td>Pid7</td> <td>SV</td> </tr> </table>	PL 1M	PV	Pid7	SV	<p>5. Use the   keys to change SV1 to PL1M.</p> <p>6. Press the SEL key. (The first digit of the lower part of the screen begins to blink.)</p>
PL 1M	PV				
Pid7	SV				
<table border="1"> <tr> <td>Pid6</td> <td>SV</td> </tr> </table>	Pid6	SV	<p>7. Use the   keys to change "Pid7" to "Pid6".</p>		
Pid6	SV				
	<p>8. Press the SEL key to save the change.</p> <p>9. Press the  key to return to the PV/SV display.</p>				

3-4 CH3 PRG (Ramp soak parameters)

This function automatically runs according to SVs and the times for the SV changes configured previously. You can choose up to 64 steps for SV setting and 14 types of operation patterns.

- Ramp: Changing SV towards a target SV
- Soak: Maintains a SV

The ramp/soak parameters (CH3) consists of the following function blocks.

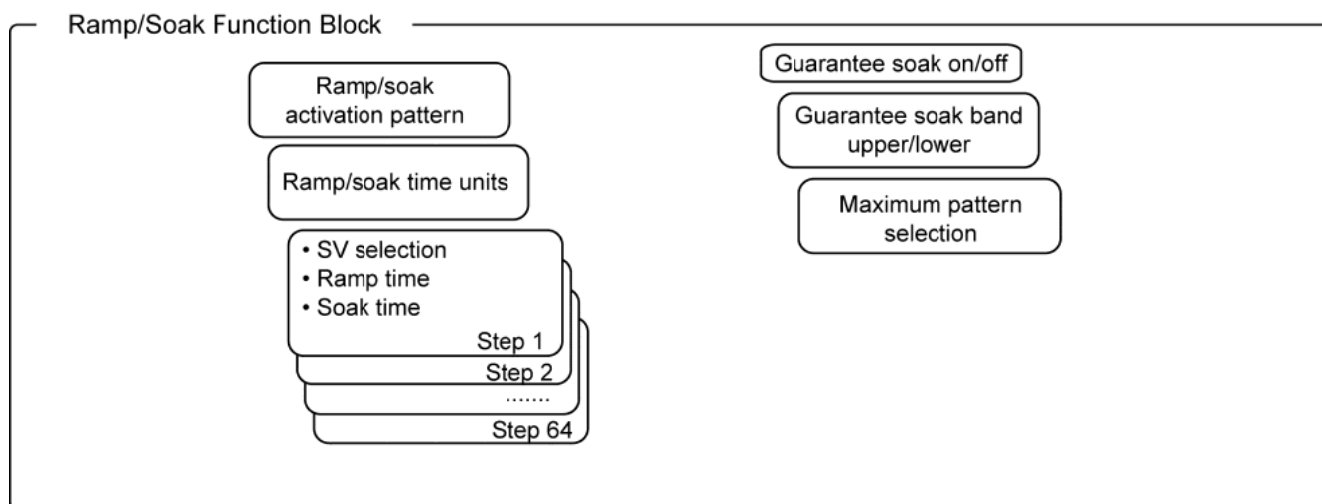

PtN Ramp/soak operation pattern (Step No.) (200)

[Description]

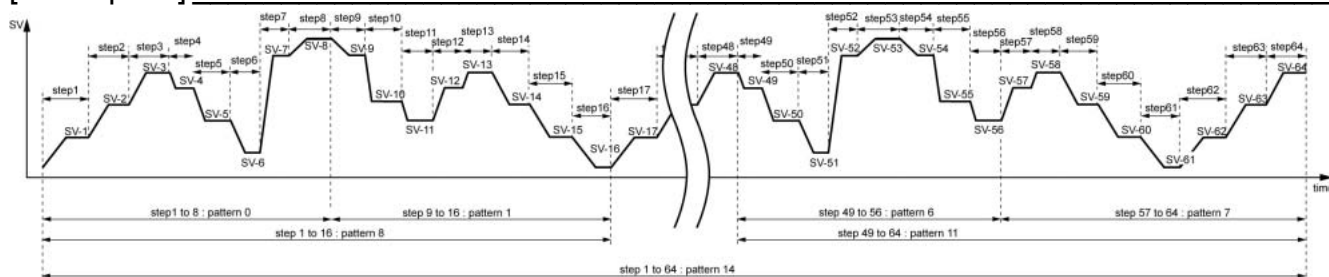

The 64-step ramp/soak patterns are divided into 15 segments. You can choose any one to use.

• Setting range

0	steps 1 to 8	8	steps 1 to 16
1	steps 9 to 16	9	steps 17 to 32
2	steps 17 to 24	10	steps 33 to 48
3	steps 25 to 32	11	steps 49 to 64
4	steps 33 to 40	12	steps 1 to 32
5	steps 41 to 48	13	steps 33 to 64
6	steps 49 to 56	14	steps 1 to 64
7	steps 57 to 64	di	depending on di

Note:

Do not change this parameter during the ramp soak operation. Be sure to set "PRG" = "OFF" before changing the parameter.

[Setting example] Setting the Ramp/Soak Activation Pattern to steps 1 to 8

Display	Operating procedure				
<table border="1"> <tr> <td>2 4 5</td> <td>PV</td> </tr> <tr> <td>250</td> <td>SV</td> </tr> </table>	2 4 5	PV	250	SV	1. Check that the PV/SV display is shown.
2 4 5	PV				
250	SV				
<table border="1"> <tr> <td>CH 3</td> <td>PV</td> </tr> <tr> <td>PRG</td> <td>SV</td> </tr> </table>	CH 3	PV	PRG	SV	2. Press and hold the SEL key to display CH1 (PID parameters).
CH 3	PV				
PRG	SV				
<table border="1"> <tr> <td>P t N</td> <td>PV</td> </tr> <tr> <td>14</td> <td>SV</td> </tr> </table>	P t N	PV	14	SV	3. Press the \odot key to access CH3 (Ramp soak parameters).
P t N	PV				
14	SV				
<table border="1"> <tr> <td>0</td> <td>SV</td> </tr> </table>	0	SV	4. Press the SEL key to enter CH3 (Ramp soak parameters). PtN (Ramp soak operation pattern) is displayed.		
0	SV				
	5. Press the SEL key. (The first digit of the lower part of the screen begins to blink.)				
	6. Use the \wedge \vee keys to change 14 to 0.				
	7. Press the SEL key to save the change.				
	8. Press the \ominus key to return to the PV/SV display.				

tiMU Ramp/soak time units (201)

[Description]

Allows you to set the time units for Ramp/soak operation.







- Setting range: HH : MM(hour:min) MM : SS(min:sec)

Note:

Time units can not be set separately for each step.

All steps use the same unit of time.

[Setting example] Setting the time unit to MM:SS

Display	Operating procedure				
<table border="1" style="width: 100%; border-collapse: collapse;"> <tr> <td style="text-align: center; padding: 5px;">2 4 5</td> <td style="text-align: center; padding: 5px;">PV</td> </tr> <tr> <td style="text-align: center; padding: 5px;">250</td> <td style="text-align: center; padding: 5px;">SV</td> </tr> </table>	2 4 5	PV	250	SV	<ol style="list-style-type: none"> 1. Check that the PV/SV display is shown. 2. Press and hold the SEL key to display CH1 (PID parameters). 3. Press the  key to access CH3 (Ramp soak parameters). 4. Press the SEL key to enter CH3 (Ramp soak parameters). PtN (Ramp soak operation pattern) is displayed. 5. Use the   keys to change PtN to tiMU. 6. Press the SEL key. (The first digit of the lower part of the screen begins to blink.) 7. Press the   keys to change HH:MM to MM:SS. 8. Press the SEL key to save the change. 9. Press the  key to return to the PV/SV display.
2 4 5	PV				
250	SV				
<table border="1" style="width: 100%; border-collapse: collapse;"> <tr> <td style="text-align: center; padding: 5px;">CH 3</td> <td style="text-align: center; padding: 5px;">PV</td> </tr> <tr> <td style="text-align: center; padding: 5px;">PRG</td> <td style="text-align: center; padding: 5px;">SV</td> </tr> </table>	CH 3	PV	PRG	SV	
CH 3	PV				
PRG	SV				
<table border="1" style="width: 100%; border-collapse: collapse;"> <tr> <td style="text-align: center; padding: 5px;">P t N</td> <td style="text-align: center; padding: 5px;">PV</td> </tr> <tr> <td style="text-align: center; padding: 5px;">14</td> <td style="text-align: center; padding: 5px;">SV</td> </tr> </table>	P t N	PV	14	SV	
P t N	PV				
14	SV				
<table border="1" style="width: 100%; border-collapse: collapse;"> <tr> <td style="text-align: center; padding: 5px;">t i MU</td> <td style="text-align: center; padding: 5px;">PV</td> </tr> <tr> <td style="text-align: center; padding: 5px;">HH:MM</td> <td style="text-align: center; padding: 5px;">SV</td> </tr> </table>	t i MU	PV	HH:MM	SV	
t i MU	PV				
HH:MM	SV				
<table border="1" style="width: 100%; border-collapse: collapse;"> <tr> <td style="text-align: center; padding: 5px;">MM:SS</td> <td style="text-align: center; padding: 5px;">SV</td> </tr> </table>	MM:SS	SV			
MM:SS	SV				

SV-1 to SV64 Ramp soak seg1 SV1 to seg64 SV64 (202 to 391)

tM1R to t64R Ramp soak seg1 ramp time to seg64 ramp time (203 to 392)

tM1S to t64S Ramp soak seg1 soak time to seg64 ramp time (204 to 393)

[Description]

Sets the ramp soak SV, ramp time and soak time.

Setting range:

SV	SV lower limit (SVL) to SV upper limit (SVH) %FS
Ramp time	00:00 to 99:59 (hour:min/min:sec)
Soak time	00:00 to 99:59 (hour:min/min:sec)

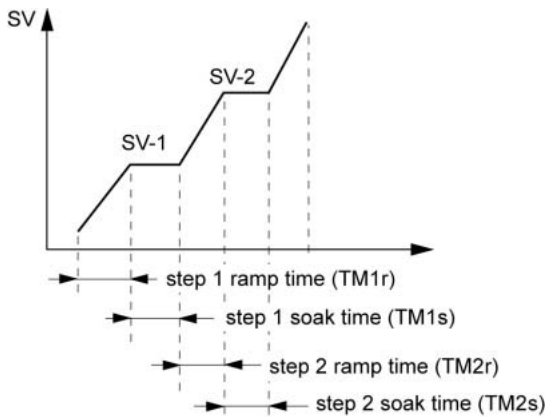

- The segment that both ramp time and soak time are set to 0.00 will be skipped.

(Example)

SV-1 : 50	SV-2 : 200	SV-3 : 100
TM1r : 0.10	TM2r : 0.00	TM3r : 1.00
TM1S : 0.05	TM2S : 0.00	TM3S : 0.75

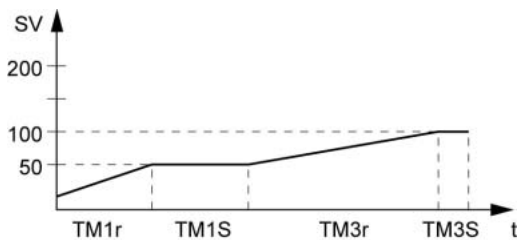

- The SV limit function (SV-h, SV-L) is in effect while ramp/soak is running. The set value (SV-n) does not change, but the value is limited during ramp/soak. For the above reason, the value may not change at the set times and the ramp soak runs with the following pattern.

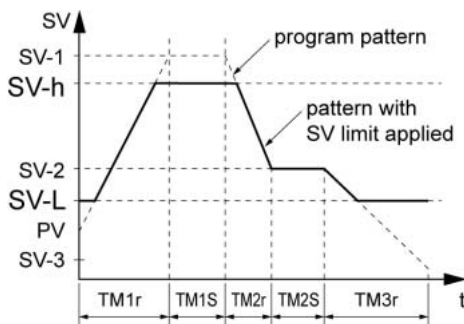

[Setting example] Setting SV1, ramp time, and soak time for step1 _____

Display	Operating procedure				
<table border="1"> <tr> <td>2 4 5</td> <td>PV</td> </tr> <tr> <td>250</td> <td>SV</td> </tr> </table>	2 4 5	PV	250	SV	<p>1. Check that the PV/SV display is shown.</p>
2 4 5	PV				
250	SV				
<table border="1"> <tr> <td>CH 3</td> <td>PV</td> </tr> <tr> <td>PRG</td> <td>SV</td> </tr> </table>	CH 3	PV	PRG	SV	<p>2. Press and hold the SEL key to display CH1 (PID parameters).</p> <p>3. Press the \odot key to access CH3 (Ramp soak parameters).</p>
CH 3	PV				
PRG	SV				
<table border="1"> <tr> <td>P t N</td> <td>PV</td> </tr> <tr> <td>14</td> <td>SV</td> </tr> </table>	P t N	PV	14	SV	<p>4. Press the SEL key to enter CH3 (Ramp soak parameters). PtN (Ramp soak operation pattern) is displayed.</p>
P t N	PV				
14	SV				
<table border="1"> <tr> <td>SV-1</td> <td>PV</td> </tr> <tr> <td>0</td> <td>SV</td> </tr> </table>	SV-1	PV	0	SV	<p>5. Use the \wedge \odot keys to change PtN to SV-1.</p> <p>6. Press the SEL key. (The first digit of the lower part of the screen begins to blink.)</p>
SV-1	PV				
0	SV				
<table border="1"> <tr> <td>50</td> <td>SV</td> </tr> </table>	50	SV	<p>7. Use the \wedge \odot keys to change 0 to 50.</p>		
50	SV				
<table border="1"> <tr> <td>t M 1 R</td> <td>PV</td> </tr> <tr> <td>0</td> <td>SV</td> </tr> </table>	t M 1 R	PV	0	SV	<p>8. Press the SEL key to save the change.</p> <p>9. Use the \wedge \odot keys to change SV-1 to tM1R.</p> <p>10. Press the SEL key. (The first digit of the lower part of the screen begins to blink.)</p>
t M 1 R	PV				
0	SV				
<table border="1"> <tr> <td>0.10</td> <td>SV</td> </tr> </table>	0.10	SV	<p>11. Use the \wedge \odot keys to change 0 to 0.10.</p>		
0.10	SV				
<table border="1"> <tr> <td>t M 1 S</td> <td>PV</td> </tr> <tr> <td>0</td> <td>SV</td> </tr> </table>	t M 1 S	PV	0	SV	<p>12. Press the SEL key to save the change.</p> <p>13. Use the \wedge \odot keys to change tM1R to tM1S.</p> <p>14. Press the SEL key. (The first digit of the lower part of the screen begins to blink.)</p>
t M 1 S	PV				
0	SV				
<table border="1"> <tr> <td>0.05</td> <td>SV</td> </tr> </table>	0.05	SV	<p>15. Use the \wedge \odot keys to change 0 to 0.05.</p>		
0.05	SV				
	<p>16. Press the SEL key to save the change.</p> <p>17. Repeat the same steps for step 2 to step 64.</p> <p>18. Press the \odot key to return to the PV/SV display.</p>				

Mod Ramp soak mode (394)

[Description]

Allows you to set the method of ramp/soak operation.

The following items can be set.

Power-on start	Starts ramp/soak with the current PV when the main unit is turned on.
END time output	Maintains the same state as at the end of ramp/soak when ramp/soak is complete.
oFF time output	Switches to the OFF state when ramp/soak is complete.
Repeat operation	Repeats ramp/soak from step 1 when the last step finishes.

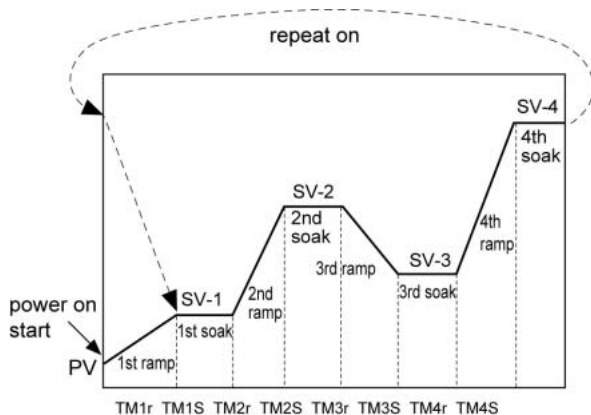

- You can choose from the following 16 modes.

MOD	Power-on start	Ending output	OFF output	Repeat behavior
0	none	Maintain control	Maintain control	none
1	none	Maintain control	Maintain control	on
2	none	Maintain control	Standby Mode	none
3	none	Maintain control	Standby Mode	on
4	none	Standby Mode	Maintain control	none
5	none	Standby Mode	Maintain control	on
6	none	Standby Mode	Standby Mode	none
7	none	Standby Mode	Standby Mode	on
8	on	Maintain control	Maintain control	none
9	on	Maintain control	Maintain control	on
10	on	Maintain control	Standby Mode	none
11	on	Maintain control	Standby Mode	on
12	on	Standby Mode	Maintain control	none
13	on	Standby Mode	Maintain control	on
14	on	Standby Mode	Standby Mode	none
15	on	Standby Mode	Standby Mode	on

- When not in repeat operation, the last SV value is held when ramp/soak finishes.

[Setting example] Setting the ramp soak mode to 1 _____

Display	Operating procedure				
<table border="1"> <tr> <td>2 4 5</td> <td>PV</td> </tr> <tr> <td>250</td> <td>SV</td> </tr> </table>	2 4 5	PV	250	SV	<p>1. Check that the PV/SV display is shown.</p>
2 4 5	PV				
250	SV				
<table border="1"> <tr> <td>CH 3</td> <td>PV</td> </tr> <tr> <td>PRG</td> <td>SV</td> </tr> </table>	CH 3	PV	PRG	SV	<p>2. Press and hold the SEL key to display CH1 (PID parameters).</p> <p>3. Press the \odot key to access CH3 (Ramp soak parameters).</p>
CH 3	PV				
PRG	SV				
<table border="1"> <tr> <td>P t N</td> <td>PV</td> </tr> <tr> <td>14</td> <td>SV</td> </tr> </table>	P t N	PV	14	SV	<p>4. Press the SEL key to enter CH3 (Ramp soak parameters). PtN (Ramp soak operation pattern) is displayed.</p>
P t N	PV				
14	SV				
<table border="1"> <tr> <td>Mod</td> <td>PV</td> </tr> <tr> <td>0</td> <td>SV</td> </tr> </table>	Mod	PV	0	SV	<p>5. Use the \wedge \odot keys to change PtN to Mod.</p> <p>6. Press the SEL key. (The first digit of the lower part of the screen begins to blink.)</p>
Mod	PV				
0	SV				
<table border="1"> <tr> <td>1</td> <td>SV</td> </tr> </table>	1	SV	<p>7. Use the \wedge \odot keys to change 0 to 1.</p> <p>8. Press the SEL key to save the change.</p>		
1	SV				
	<p>9. Press the \odot key to return to the PV/SV display.</p>				

GSoK Guarantee soak (395)

GS-L Guarantee soak band (lower) (396)

GS-H Guarantee soak band (upper) (397)

[Description] _____

This function guarantees the soak time. Soak time is counted down only when PV is in the certain temperature range.

As seen in the figure below, only the sum of the shaded areas is counted as soak time. The operation moves onto the next step when the total soak time has reached the specified soak time.

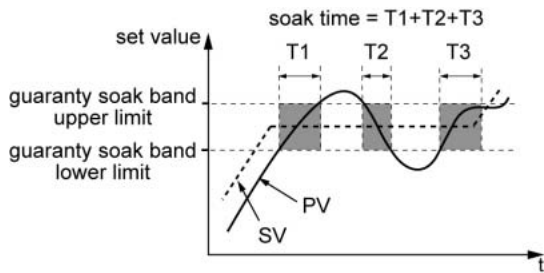

Setting range:

Guarantee soak	on/off
Guarantee soak upper limit	0 to 50% FS
Guarantee soak lower limit	0 to 50% FS

[Setting example] Setting guaranty soak to ON and upper/lower limits to 5°C

Display	Operating procedure				
<table border="1"> <tr> <td>2 4 5</td> <td>PV</td> </tr> <tr> <td>250</td> <td>SV</td> </tr> </table>	2 4 5	PV	250	SV	<p>1. Check that the PV/SV display is shown.</p>
2 4 5	PV				
250	SV				
<table border="1"> <tr> <td>CH 3</td> <td>PV</td> </tr> <tr> <td>PRG</td> <td>SV</td> </tr> </table>	CH 3	PV	PRG	SV	<p>2. Press and hold the SEL key to display CH1 (PID parameters).</p> <p>3. Press the \odot key to access CH3 (Ramp soak parameters).</p>
CH 3	PV				
PRG	SV				
<table border="1"> <tr> <td>P t N</td> <td>PV</td> </tr> <tr> <td>14</td> <td>SV</td> </tr> </table>	P t N	PV	14	SV	<p>4. Press the SEL key to enter CH3 (Ramp soak parameters). PtN (Ramp soak operation pattern) is displayed.</p>
P t N	PV				
14	SV				
<table border="1"> <tr> <td>G S o K</td> <td>PV</td> </tr> <tr> <td>oFF</td> <td>SV</td> </tr> </table>	G S o K	PV	oFF	SV	<p>5. Use the \wedge \vee keys to change PtN to GSoK.</p> <p>6. Press the SEL key. (The first digit of the lower part of the screen begins to blink.)</p>
G S o K	PV				
oFF	SV				
<table border="1"> <tr> <td>oN</td> <td>SV</td> </tr> </table>	oN	SV	<p>7. Use \wedge \vee keys to change "oFF" to "oN".</p>		
oN	SV				
<table border="1"> <tr> <td>G S - L</td> <td>PV</td> </tr> <tr> <td>0</td> <td>SV</td> </tr> </table>	G S - L	PV	0	SV	<p>8. Press the SEL key to save the change.</p> <p>9. Use \wedge \vee keys to change GSoK to GS-L.</p>
G S - L	PV				
0	SV				
<table border="1"> <tr> <td>5</td> <td>SV</td> </tr> </table>	5	SV	<p>10. Press the SEL key. (The first digit of the lower part of the screen begins to blink.)</p>		
5	SV				
<table border="1"> <tr> <td>G S - H</td> <td>PV</td> </tr> <tr> <td>0</td> <td>SV</td> </tr> </table>	G S - H	PV	0	SV	<p>11. Use the \wedge \vee keys to change 0 to 5.</p>
G S - H	PV				
0	SV				
<table border="1"> <tr> <td>5</td> <td>SV</td> </tr> </table>	5	SV	<p>12. Press the SEL key to save the change.</p>		
5	SV				
<table border="1"> <tr> <td>G S - H</td> <td>PV</td> </tr> <tr> <td>0</td> <td>SV</td> </tr> </table>	G S - H	PV	0	SV	<p>13. Use \wedge \vee keys to change GS-L to GS-H.</p> <p>14. Press the SEL key. (The first digit of the lower part of the screen begins to blink.)</p>
G S - H	PV				
0	SV				
<table border="1"> <tr> <td>5</td> <td>SV</td> </tr> </table>	5	SV	<p>15. Use the \wedge \vee keys to change 0 to 5.</p>		
5	SV				
	<p>16. Press the SEL key to save the change.</p>				
	<p>17. Press the \odot key to return to the PV/SV display.</p>				

PVSt PV start (398)

[Description]

When the ramp soak starts (RUN), this function searches the first point where the measurement value (PV) and the program pattern match, and starts operation at that point.

If the measurement value does not match the pattern as with (3), the normal operation starts.

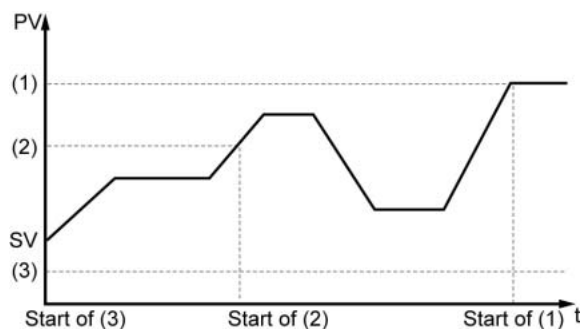

Setting range: oN (PV start on), oFF (PV start off)

[Setting example] Setting PV start to ON

Display	Operating procedure				
<table border="1"> <tr> <td>2 4 5</td> <td>PV</td> </tr> <tr> <td>250</td> <td>SV</td> </tr> </table>	2 4 5	PV	250	SV	1. Check that the PV/SV display is shown.
2 4 5	PV				
250	SV				
<table border="1"> <tr> <td>CH 3</td> <td>PV</td> </tr> <tr> <td>PRG</td> <td>SV</td> </tr> </table>	CH 3	PV	PRG	SV	2. Press and hold the SEL key to display CH1 (PID parameters).
CH 3	PV				
PRG	SV				
<table border="1"> <tr> <td>P t N</td> <td>PV</td> </tr> <tr> <td>14</td> <td>SV</td> </tr> </table>	P t N	PV	14	SV	3. Press the \odot key to access CH3 (Ramp soak parameters).
P t N	PV				
14	SV				
<table border="1"> <tr> <td>P V S t</td> <td>PV</td> </tr> <tr> <td>oFF</td> <td>SV</td> </tr> </table>	P V S t	PV	oFF	SV	4. Press the SEL key to enter CH3 (Ramp soak parameters). PtN (Ramp soak operation pattern) is displayed.
P V S t	PV				
oFF	SV				
<table border="1"> <tr> <td>oN</td> <td>SV</td> </tr> </table>	oN	SV	5. Use the \wedge \odot keys to change PtN to PVSt.		
oN	SV				
	6. Press the SEL key. (The first digit of the lower part of the screen begins to blink.)				
	7. Use \wedge \odot keys to change "oFF" to "oN".				
	8. Press the SEL key to save the change.				
	9. Press the \odot key to return to the PV/SV display.				

CoNt Restore mode (399)

[Description]

This parameter specifies the ramp soak operation when the power is restored after being interrupted due to power outage or other reasons.

Setting range

RES: Does not operate ramp soak.







CoN: Resumes the operation from the status of the time at which power is turned off. (It can restore the state to five minutes before maximum.)

iNi: Starts the Ramp/Soak from the first step again.

Note:

Do not change this parameter during the ramp soak operation. Be sure to set "PRG" = "oFF" before changing the parameter.

[Setting example] Setting the restore mode so that the device resumes the operation

Display	Operating procedure				
<table border="1"> <tr> <td>2 4 5</td> <td>PV</td> </tr> <tr> <td>250</td> <td>SV</td> </tr> </table>	2 4 5	PV	250	SV	1. Check that the PV/SV display is shown.
2 4 5	PV				
250	SV				
<table border="1"> <tr> <td>CH 3</td> <td>PV</td> </tr> <tr> <td>PRG</td> <td>SV</td> </tr> </table>	CH 3	PV	PRG	SV	2. Press and hold the SEL key to display CH1 (PID parameters). 3. Press the  key to access CH3 (Ramp soak parameters).
CH 3	PV				
PRG	SV				
<table border="1"> <tr> <td>P t N</td> <td>PV</td> </tr> <tr> <td>14</td> <td>SV</td> </tr> </table>	P t N	PV	14	SV	4. Press the SEL key to enter CH3 (Ramp soak parameters). PtN (Ramp soak operation pattern) is displayed.
P t N	PV				
14	SV				
<table border="1"> <tr> <td>CoNt</td> <td>PV</td> </tr> <tr> <td>RES</td> <td>SV</td> </tr> </table>	CoNt	PV	RES	SV	5. Use the   keys to change PtN to CoNt. 6. Press the SEL key. (The first digit of the lower part of the screen begins to blink.)
CoNt	PV				
RES	SV				
<table border="1"> <tr> <td>CoNt</td> <td>SV</td> </tr> </table>	CoNt	SV	7. Use   keys to change "RES" to "CoNt". 8. Press the SEL key to save the change.		
CoNt	SV				
	9. Press the  key to return to the PV/SV display.				

PtNM Max pattern selection (400)

PMiN Min pattern selection (401)

[Description]

Sets the max./min. pattern number that can be selected when proceeding the Ramp/soak activation pattern with USER keys.

- Setting range: 0 to 14
- Related parameters: Ramp soak operation pattern (CH 3) (page 71)
User key assignment (CH 7) (page 141)

Note:

Do not set a value for Min pattern selection that is larger than the value for Max pattern selection.

[Setting example] Setting the min. number to 2 and max. number to 4

Display	Operating procedure				
<table border="1"><tr><td>2 4 5</td><td>PV</td></tr><tr><td>250</td><td>SV</td></tr></table>	2 4 5	PV	250	SV	1. Check that the PV/SV display is shown.
2 4 5	PV				
250	SV				
<table border="1"><tr><td>CH 3</td><td>PV</td></tr><tr><td>PRG</td><td>SV</td></tr></table>	CH 3	PV	PRG	SV	2. Press and hold the SEL key to display CH1 (PID parameters).
CH 3	PV				
PRG	SV				
	3. Press the \odot key to access CH3 (Ramp soak parameters).				
<table border="1"><tr><td>P t N</td><td>PV</td></tr><tr><td>14</td><td>SV</td></tr></table>	P t N	PV	14	SV	4. Press the SEL key to enter CH3 (Ramp soak parameters). PtN (Ramp soak operation pattern) is displayed.
P t N	PV				
14	SV				
	5. Use the \wedge \odot keys to change PtN to PtNM.				
<table border="1"><tr><td>P t NM</td><td>PV</td></tr><tr><td>14</td><td>SV</td></tr></table>	P t NM	PV	14	SV	6. Press the SEL key. (The first digit of the lower part of the screen begins to blink.)
P t NM	PV				
14	SV				
<table border="1"><tr><td>4</td><td>SV</td></tr></table>	4	SV	7. Use the \wedge \odot keys to change 14 to 4.		
4	SV				
	8. Press the SEL key to save the change.				
<table border="1"><tr><td>PMiN</td><td>PV</td></tr><tr><td>0</td><td>SV</td></tr></table>	PMiN	PV	0	SV	9. Use the \wedge \odot keys to change PtNM to PMiN.
PMiN	PV				
0	SV				
	10. Press the SEL key. (The first digit of the lower part of the screen begins to blink.)				
<table border="1"><tr><td>2</td><td>SV</td></tr></table>	2	SV	11. Use the \wedge \odot keys to change 0 to 2.		
2	SV				
	12. Press the SEL key to save the change.				
	13. Press the \odot key to return to the PV/SV display.				

3-5 CH4 MON (Monitor parameters)

StAt Ramp soak progress (420)

[Description]



Displays the progress of the ramp soak.

The ramp soak status are indicated as follows.

Display	Status
oFF	Ramp soak is stopped
1-RP	Step 1 ramp
1-St	Step 1 soak
2-RP	Step 2 ramp
2-St	Step 2 soak
⋮	⋮
64RP	Step 64 ramp
64St	Step 64 soak
ENd	Ramp soak is finished

Related parameters: Ramp soak parameters (CH 3) (page 70)





[Setting example] Checking ramp soak progress

Display	Operating procedure				
<table border="1"> <tr> <td>2 4 5</td> <td>PV</td> </tr> <tr> <td>250</td> <td>SV</td> </tr> </table>	2 4 5	PV	250	SV	<ol style="list-style-type: none"> 1. Check that the PV/SV display is shown. 2. Press and hold the SEL key to display CH1 (PID parameters). 3. Press the  key to access CH4 (Monitor parameters). 4. Press the SEL key to enter CH4 (Monitor parameters). StAt (Ramp soak progress) is displayed. 5. Press the  key to return to the PV/SV display.
2 4 5	PV				
250	SV				
<table border="1"> <tr> <td>CH 4</td> <td>PV</td> </tr> <tr> <td>MoN</td> <td>SV</td> </tr> </table>	CH 4	PV	MoN	SV	
CH 4	PV				
MoN	SV				
<table border="1"> <tr> <td>S t A t</td> <td>PV</td> </tr> <tr> <td>oFF</td> <td>SV</td> </tr> </table>	S t A t	PV	oFF	SV	
S t A t	PV				
oFF	SV				

MV1, **MV2** Control output (MV1, MV2) (421, 422)

[Description] _____
 Displays the output values (OUT1/OUT2).

[Setting example] Checking the output value (OUT1) _____





Display	Operating procedure				
<table border="1"> <tr> <td data-bbox="225 495 443 562">2 4 5</td> <td data-bbox="443 495 496 562">PV</td> </tr> <tr> <td data-bbox="225 562 443 629">250</td> <td data-bbox="443 562 496 629">SV</td> </tr> </table>	2 4 5	PV	250	SV	<p>1. Check that the PV/SV display is shown.</p>
2 4 5	PV				
250	SV				
<table border="1"> <tr> <td data-bbox="225 665 443 732">CH 4</td> <td data-bbox="443 665 496 732">PV</td> </tr> <tr> <td data-bbox="225 732 443 799">MoN</td> <td data-bbox="443 732 496 799">SV</td> </tr> </table>	CH 4	PV	MoN	SV	<p>2. Press and hold the SEL key to display CH1 (PID parameters).</p> <p>3. Use the  key to access CH4 (Monitor parameters).</p>
CH 4	PV				
MoN	SV				
<table border="1"> <tr> <td data-bbox="225 857 443 925">S t A t</td> <td data-bbox="443 857 496 925">PV</td> </tr> <tr> <td data-bbox="225 925 443 969">oFF</td> <td data-bbox="443 925 496 969">SV</td> </tr> </table>	S t A t	PV	oFF	SV	<p>4. Press the SEL key to enter CH4 (Monitor parameters). StAt (Ramp soak progress) is displayed.</p>
S t A t	PV				
oFF	SV				
<table border="1"> <tr> <td data-bbox="225 1050 443 1117">MV 1</td> <td data-bbox="443 1050 496 1117">PV</td> </tr> <tr> <td data-bbox="225 1117 443 1184">58.4</td> <td data-bbox="443 1117 496 1184">SV</td> </tr> </table>	MV 1	PV	58.4	SV	<p>5. Use the   keys to change StAt to MV1. The output value of OUT1 is displayed.</p>
MV 1	PV				
58.4	SV				
	<p>6. Repeat the same steps to check the output value of OUT2.</p>				
	<p>7. Press the  key to return to the PV/SV display.</p>				

Pfb PFB input value (423)

[Description]

Motorized valve opening will be displayed when using position feedback (PFB) as the control.

[Setting example] Checking the PFB input value





Display	Operating procedure				
<table border="1"> <tr> <td data-bbox="108 488 331 562">2 4 5</td> <td data-bbox="336 488 379 562">PV</td> </tr> <tr> <td data-bbox="108 568 331 629">250</td> <td data-bbox="336 568 379 629">SV</td> </tr> </table>	2 4 5	PV	250	SV	<p>1. Check that the PV/SV display is shown.</p>
2 4 5	PV				
250	SV				
<table border="1"> <tr> <td data-bbox="108 658 331 732">CH 4</td> <td data-bbox="336 658 379 732">PV</td> </tr> <tr> <td data-bbox="108 739 331 799">MoN</td> <td data-bbox="336 739 379 799">SV</td> </tr> </table>	CH 4	PV	MoN	SV	<p>2. Press and hold the SEL key to display CH1 (PID parameters).</p> <p>3. Use the  key to access CH4 (Monitor parameters).</p>
CH 4	PV				
MoN	SV				
<table border="1"> <tr> <td data-bbox="108 828 331 902">S t A t</td> <td data-bbox="336 828 379 902">PV</td> </tr> <tr> <td data-bbox="108 909 331 969">oFF</td> <td data-bbox="336 909 379 969">SV</td> </tr> </table>	S t A t	PV	oFF	SV	<p>4. Press the SEL key to enter CH4 (Monitor parameters). StAt (Ramp soak progress) is displayed.</p>
S t A t	PV				
oFF	SV				
<table border="1"> <tr> <td data-bbox="108 999 331 1072">P F b</td> <td data-bbox="336 999 379 1072">PV</td> </tr> <tr> <td data-bbox="108 1079 331 1140">19.5</td> <td data-bbox="336 1079 379 1140">SV</td> </tr> </table>	P F b	PV	19.5	SV	<p>5. Use the   keys to change “StAt” to “Pfb”. The input value for PFB is displayed.</p>
P F b	PV				
19.5	SV				
	<p>6. Press the  key to return to the PV/SV display.</p>				

RSV Remote SV (424)

[Description] _____

Displays the remote SV input value.

[Setting example] Checking the remote SV input value _____

Display	Operating procedure				
<table border="1"> <tr> <td data-bbox="225 495 443 562">245</td> <td data-bbox="443 495 496 562">PV</td> </tr> <tr> <td data-bbox="225 562 443 629">250</td> <td data-bbox="443 562 496 629">SV</td> </tr> </table>	245	PV	250	SV	<p>1. Check that the PV/SV display is shown.</p>
245	PV				
250	SV				
<table border="1"> <tr> <td data-bbox="225 663 443 730">CH 4</td> <td data-bbox="443 663 496 730">PV</td> </tr> <tr> <td data-bbox="225 730 443 797">MoN</td> <td data-bbox="443 730 496 797">SV</td> </tr> </table>	CH 4	PV	MoN	SV	<p>2. Press and hold the SEL key to display CH1 (PID parameters).</p> <p>3. Use the  key to access CH4 (Monitor parameters).</p>
CH 4	PV				
MoN	SV				
<table border="1"> <tr> <td data-bbox="225 831 443 898">StAt</td> <td data-bbox="443 831 496 898">PV</td> </tr> <tr> <td data-bbox="225 898 443 965">oFF</td> <td data-bbox="443 898 496 965">SV</td> </tr> </table>	StAt	PV	oFF	SV	<p>4. Press the SEL key to enter CH4 (Monitor parameters). StAt (Ramp soak progress) is displayed.</p>
StAt	PV				
oFF	SV				
<table border="1"> <tr> <td data-bbox="225 999 443 1066">RSV</td> <td data-bbox="443 999 496 1066">PV</td> </tr> <tr> <td data-bbox="225 1066 443 1133">17.5</td> <td data-bbox="443 1066 496 1133">SV</td> </tr> </table>	RSV	PV	17.5	SV	<p>5. Use the   keys to change “StAt” to “RSV”. The input value for remote SV is displayed.</p>
RSV	PV				
17.5	SV				
	<p>6. Press the  key to return to the PV/SV display.</p>				





Ct1 Heater current (425)

[Description]

Display the Heater current value.

(The current value measured during the control output 1 is ON is indicated.)

[Setting example] Checking the heater current value

Display	Operating procedure				
<table border="1" style="width: 100%; border-collapse: collapse;"> <tr> <td style="text-align: center; padding: 5px;">2 4 5</td> <td style="text-align: center; padding: 5px;">PV</td> </tr> <tr> <td style="text-align: center; padding: 5px;">250</td> <td style="text-align: center; padding: 5px;">SV</td> </tr> </table>	2 4 5	PV	250	SV	<p>1. Check that the PV/SV display is shown.</p>
2 4 5	PV				
250	SV				
<table border="1" style="width: 100%; border-collapse: collapse;"> <tr> <td style="text-align: center; padding: 5px;">CH 4</td> <td style="text-align: center; padding: 5px;">PV</td> </tr> <tr> <td style="text-align: center; padding: 5px;">MoN</td> <td style="text-align: center; padding: 5px;">SV</td> </tr> </table>	CH 4	PV	MoN	SV	<p>2. Press and hold the SEL key to display CH1 (PID parameters).</p> <p>3. Use the  key to access CH4 (Monitor parameters).</p>
CH 4	PV				
MoN	SV				
<table border="1" style="width: 100%; border-collapse: collapse;"> <tr> <td style="text-align: center; padding: 5px;">S t A t</td> <td style="text-align: center; padding: 5px;">PV</td> </tr> <tr> <td style="text-align: center; padding: 5px;">oFF</td> <td style="text-align: center; padding: 5px;">SV</td> </tr> </table>	S t A t	PV	oFF	SV	<p>4. Press the SEL key to enter CH4 (Monitor parameters). StAt (Ramp soak progress) is displayed.</p>
S t A t	PV				
oFF	SV				
<table border="1" style="width: 100%; border-collapse: collapse;"> <tr> <td style="text-align: center; padding: 5px;">C t 1</td> <td style="text-align: center; padding: 5px;">PV</td> </tr> <tr> <td style="text-align: center; padding: 5px;">25.5</td> <td style="text-align: center; padding: 5px;">SV</td> </tr> </table>	C t 1	PV	25.5	SV	<p>5. Use the   keys to change “StAt” to “Ct1”. The input value for heater current is displayed.</p>
C t 1	PV				
25.5	SV				
	<p>6. Press the  key to return to the PV/SV display.</p>				





LC1 Leak current (427)

[Description]

Display the Leak current value.

(The current value measured during the control output 1 is OFF is indicated.)

[Setting example] Checking the leak current value

Display	Operating procedure				
<table border="1"> <tr> <td>2 4 5</td> <td>PV</td> </tr> <tr> <td>250</td> <td>SV</td> </tr> </table>	2 4 5	PV	250	SV	1. Check that the PV/SV display is shown.
2 4 5	PV				
250	SV				
<table border="1"> <tr> <td>CH 4</td> <td>PV</td> </tr> <tr> <td>MoN</td> <td>SV</td> </tr> </table>	CH 4	PV	MoN	SV	2. Press and hold the SEL key to display CH1 (PID parameters). 3. Use the  key to access CH4 (Monitor parameters).
CH 4	PV				
MoN	SV				
<table border="1"> <tr> <td>S t A t</td> <td>PV</td> </tr> <tr> <td>oFF</td> <td>SV</td> </tr> </table>	S t A t	PV	oFF	SV	4. Press the SEL key to enter CH4 (Monitor parameters). StAt (Ramp soak progress) is displayed.
S t A t	PV				
oFF	SV				
<table border="1"> <tr> <td>LC1</td> <td>PV</td> </tr> <tr> <td>0.0</td> <td>SV</td> </tr> </table>	LC1	PV	0.0	SV	5. Use the   keys to change "StAt" to "LC1". The leak current value is displayed.
LC1	PV				
0.0	SV				
	6. Press the  key to return to the PV/SV display.				





tM1 to **tM5** Remaining time on timer (429 to 433)

[Description] _____

Displays the remaining time on timer.

Related parameters: ALM hysteresis, ALM delay, ALM delay time units (CH 5) (page 100)

[Setting example] Checking the remaining time on the timer 1 _____

Display	Operating procedure				
<table border="1"> <tr> <td data-bbox="103 524 331 600">2 4 5</td> <td data-bbox="336 524 387 600">PV</td> </tr> <tr> <td data-bbox="103 600 331 663">250</td> <td data-bbox="336 600 387 663">SV</td> </tr> </table>	2 4 5	PV	250	SV	<p>1. Check that the PV/SV display is shown.</p>
2 4 5	PV				
250	SV				
<table border="1"> <tr> <td data-bbox="103 694 331 770">CH 4</td> <td data-bbox="336 694 387 770">PV</td> </tr> <tr> <td data-bbox="103 770 331 833">MoN</td> <td data-bbox="336 770 387 833">SV</td> </tr> </table>	CH 4	PV	MoN	SV	<p>2. Press and hold the SEL key to display CH1 (PID parameters).</p> <p>3. Use the  key to access CH4 (Monitor parameters).</p>
CH 4	PV				
MoN	SV				
<table border="1"> <tr> <td data-bbox="103 864 331 940">S t A t</td> <td data-bbox="336 864 387 940">PV</td> </tr> <tr> <td data-bbox="103 940 331 1003">oFF</td> <td data-bbox="336 940 387 1003">SV</td> </tr> </table>	S t A t	PV	oFF	SV	<p>4. Press the SEL key to enter CH4 (Monitor parameters). StAt (Ramp soak progress) is displayed.</p>
S t A t	PV				
oFF	SV				
<table border="1"> <tr> <td data-bbox="103 1034 331 1111">t M 1</td> <td data-bbox="336 1034 387 1111">PV</td> </tr> <tr> <td data-bbox="103 1111 331 1173">8</td> <td data-bbox="336 1111 387 1173">SV</td> </tr> </table>	t M 1	PV	8	SV	<p>5. Use the   keys to change StAt to tM1. The remaining time on the timer 1 is displayed.</p>
t M 1	PV				
8	SV				
	<p>6. Repeat the same steps to check the remaining times of the timer2 and the timer 3.</p> <p>7. Press the  key to return to the PV/SV display.</p>				





CoMM Communication status (435)

[Description]

Counts the number of communication times.

If the counter has reached 9999, it restarts counting from zero.

[Setting example] Checking the count

Display	Operating procedure				
<table border="1"> <tr> <td data-bbox="217 533 443 600">2 4 5</td> <td data-bbox="443 533 504 600">PV</td> </tr> <tr> <td data-bbox="217 600 443 667">250</td> <td data-bbox="443 600 504 667">SV</td> </tr> </table>	2 4 5	PV	250	SV	<p>1. Check that the PV/SV display is shown.</p>
2 4 5	PV				
250	SV				
<table border="1"> <tr> <td data-bbox="217 701 443 768">CH 4</td> <td data-bbox="443 701 504 768">PV</td> </tr> <tr> <td data-bbox="217 768 443 835">MoN</td> <td data-bbox="443 768 504 835">SV</td> </tr> </table>	CH 4	PV	MoN	SV	<p>2. Press and hold the SEL key to display CH1 (PID parameters).</p> <p>3. Use the  key to access CH4 (Monitor parameters).</p>
CH 4	PV				
MoN	SV				
<table border="1"> <tr> <td data-bbox="217 869 443 936">S t A t</td> <td data-bbox="443 869 504 936">PV</td> </tr> <tr> <td data-bbox="217 936 443 1025">oFF</td> <td data-bbox="443 936 504 1025">SV</td> </tr> </table>	S t A t	PV	oFF	SV	<p>4. Press the SEL key to enter CH4 (Monitor parameters). StAt (Ramp soak progress) is displayed.</p>
S t A t	PV				
oFF	SV				
<table border="1"> <tr> <td data-bbox="217 1059 443 1126">C o M M</td> <td data-bbox="443 1059 504 1126">PV</td> </tr> <tr> <td data-bbox="217 1126 443 1216">0</td> <td data-bbox="443 1126 504 1216">SV</td> </tr> </table>	C o M M	PV	0	SV	<p>5. Use the   keys to change StAt to CoMM. Communication count is displayed.</p>
C o M M	PV				
0	SV				
	<p>6. Press the  key to return to the PV/SV display.</p>				





CUR1 Current (436)

[Description]

Displays the electric current value measured with CT.

(The value is independent of the control output 1.)

[Setting example] Checking the leak current value





Display	Operating procedure				
<table border="1"><tr><td data-bbox="108 533 331 600">2 4 5</td><td data-bbox="336 555 379 600">PV</td></tr><tr><td data-bbox="108 607 331 667">250</td><td data-bbox="336 622 379 667">SV</td></tr></table>	2 4 5	PV	250	SV	<p>1. Check that the PV/SV display is shown.</p>
2 4 5	PV				
250	SV				
<table border="1"><tr><td data-bbox="108 701 331 768">CH 4</td><td data-bbox="336 723 379 768">PV</td></tr><tr><td data-bbox="108 775 331 835">MoN</td><td data-bbox="336 790 379 835">SV</td></tr></table>	CH 4	PV	MoN	SV	<p>2. Press and hold the SEL key to display CH1 (PID parameters).</p> <p>3. Use the  key to access CH4 (Monitor parameters).</p>
CH 4	PV				
MoN	SV				
<table border="1"><tr><td data-bbox="108 869 331 936">S t A t</td><td data-bbox="336 891 379 936">PV</td></tr><tr><td data-bbox="108 943 331 1003">oFF</td><td data-bbox="336 958 379 1003">SV</td></tr></table>	S t A t	PV	oFF	SV	<p>4. Press the SEL key to enter CH4 (Monitor parameters). StAt (Ramp soak progress) is displayed.</p>
S t A t	PV				
oFF	SV				
<table border="1"><tr><td data-bbox="108 1037 331 1104">CUR 1</td><td data-bbox="336 1059 379 1104">PV</td></tr><tr><td data-bbox="108 1111 331 1171">0.0</td><td data-bbox="336 1126 379 1171">SV</td></tr></table>	CUR 1	PV	0.0	SV	<p>5. Use the   keys to change “StAt” to “CUR1”. The current value is displayed.</p>
CUR 1	PV				
0.0	SV				
	<p>6. Press the  key to return to the PV/SV display.</p>				

PoW Electric power (438)

[Description]

Displays the calculated amount of electric power (kW).

[Setting example] Checking the electric power





Display	Operating procedure				
<table border="1" style="width: 100%; text-align: center;"> <tr> <td style="width: 80%;">2 4 5</td> <td style="width: 20%;">PV</td> </tr> <tr> <td>250</td> <td>SV</td> </tr> </table>	2 4 5	PV	250	SV	<p>1. Check that the PV/SV display is shown.</p>
2 4 5	PV				
250	SV				
<table border="1" style="width: 100%; text-align: center;"> <tr> <td style="width: 80%;">CH 4</td> <td style="width: 20%;">PV</td> </tr> <tr> <td>MoN</td> <td>SV</td> </tr> </table>	CH 4	PV	MoN	SV	<p>2. Press and hold the SEL key to display CH1 (PID parameters).</p> <p>3. Use the  key to access CH4 (Monitor parameters).</p>
CH 4	PV				
MoN	SV				
<table border="1" style="width: 100%; text-align: center;"> <tr> <td style="width: 80%;">S t A t</td> <td style="width: 20%;">PV</td> </tr> <tr> <td>oFF</td> <td>SV</td> </tr> </table>	S t A t	PV	oFF	SV	<p>4. Press the SEL key to enter CH4 (Monitor parameters). StAt (Ramp soak progress) is displayed.</p>
S t A t	PV				
oFF	SV				
<table border="1" style="width: 100%; text-align: center;"> <tr> <td style="width: 80%;">P o W</td> <td style="width: 20%;">PV</td> </tr> <tr> <td>0.0</td> <td>SV</td> </tr> </table>	P o W	PV	0.0	SV	<p>5. Use the   keys to change “StAt” to “PoW”. The electric power is displayed.</p>
P o W	PV				
0.0	SV				
	<p>6. Press the  key to return to the PV/SV display.</p>				

KWH Power (439)

[Description]

Displays the calculated amount of electric power.

[Setting example] Checking the amount of electric power

Display	Operating procedure				
<table border="1"><tr><td data-bbox="108 481 331 548">2 4 5</td><td data-bbox="338 504 379 548">PV</td></tr><tr><td data-bbox="108 555 331 622">250</td><td data-bbox="338 577 379 622">SV</td></tr></table>	2 4 5	PV	250	SV	<p>1. Check that the PV/SV display is shown.</p>
2 4 5	PV				
250	SV				
<table border="1"><tr><td data-bbox="108 654 331 721">CH 4</td><td data-bbox="338 676 379 721">PV</td></tr><tr><td data-bbox="108 728 331 795">MoN</td><td data-bbox="338 750 379 795">SV</td></tr></table>	CH 4	PV	MoN	SV	<p>2. Press and hold the SEL key to display CH1 (PID parameters).</p> <p>3. Use the  key to access CH4 (Monitor parameters).</p>
CH 4	PV				
MoN	SV				
<table border="1"><tr><td data-bbox="108 826 331 893">S t A t</td><td data-bbox="338 848 379 893">PV</td></tr><tr><td data-bbox="108 900 331 967">oFF</td><td data-bbox="338 922 379 967">SV</td></tr></table>	S t A t	PV	oFF	SV	<p>4. Press the SEL key to enter CH4 (Monitor parameters). StAt (Ramp soak progress) is displayed.</p>
S t A t	PV				
oFF	SV				
<table border="1"><tr><td data-bbox="108 999 331 1066">KWH</td><td data-bbox="338 1021 379 1066">PV</td></tr><tr><td data-bbox="108 1072 331 1140">1.2</td><td data-bbox="338 1095 379 1140">SV</td></tr></table>	KWH	PV	1.2	SV	<p>5. Use the   keys to change StAt to KWH. The amount of electric power is displayed.</p>
KWH	PV				
1.2	SV				
	<p>6. Press the  key to return to the PV/SV display.</p>				

RCN1, RCN2 Number of operating times (440, 441)





[Description]

Displays the number of times that control output relay 1 or 2 has operated.

The number is displayed in increments of 1000.

(For example, when 1 is displayed, it means the relay has operated 1000 times.)

[Setting example] Checking the number of operating times (control relay 1)





Display	Operating procedure				
<table border="1"> <tr> <td>2 4 5</td> <td>PV</td> </tr> <tr> <td>250</td> <td>SV</td> </tr> </table>	2 4 5	PV	250	SV	<p>1. Check that the PV/SV display is shown.</p>
2 4 5	PV				
250	SV				
<table border="1"> <tr> <td>CH 4</td> <td>PV</td> </tr> <tr> <td>MoN</td> <td>SV</td> </tr> </table>	CH 4	PV	MoN	SV	<p>2. Press and hold the SEL key to display CH1 (PID parameters).</p> <p>3. Use the  key to access CH4 (Monitor parameters).</p>
CH 4	PV				
MoN	SV				
<table border="1"> <tr> <td>S t A t</td> <td>PV</td> </tr> <tr> <td>oFF</td> <td>SV</td> </tr> </table>	S t A t	PV	oFF	SV	<p>4. Press the SEL key to enter CH4 (Monitor parameters). StAt (Ramp soak progress) is displayed.</p>
S t A t	PV				
oFF	SV				
<table border="1"> <tr> <td>RCN 1</td> <td>PV</td> </tr> <tr> <td>0</td> <td>SV</td> </tr> </table>	RCN 1	PV	0	SV	<p>5. Use the   keys to change StAt to RCN1. The number of times that control output relay 1 has operated is displayed.</p>
RCN 1	PV				
0	SV				
	<p>6. Repeat the same steps to check the number of operating times of control output relay 2.</p> <p>7. Press the  key to return to the PV/SV display.</p>				

RUNt Operating days (442)

[Description]

Displays the number of days that the temperature controller has been operated.

[Setting example] Checking the number of days the controller has operated

Display	Operating procedure				
<table border="1"> <tr> <td>2 4 5</td> <td>PV</td> </tr> <tr> <td>250</td> <td>SV</td> </tr> </table>	2 4 5	PV	250	SV	<p>1. Check that the PV/SV display is shown.</p>
2 4 5	PV				
250	SV				
<table border="1"> <tr> <td>CH 4</td> <td>PV</td> </tr> <tr> <td>MoN</td> <td>SV</td> </tr> </table>	CH 4	PV	MoN	SV	<p>2. Press and hold the SEL key to display CH1 (PID parameters).</p> <p>3. Use the  key to access CH4 (Monitor parameters).</p>
CH 4	PV				
MoN	SV				
<table border="1"> <tr> <td>S t A t</td> <td>PV</td> </tr> <tr> <td>oFF</td> <td>SV</td> </tr> </table>	S t A t	PV	oFF	SV	<p>4. Press the SEL key to enter CH4 (Monitor parameters). StAt (Ramp soak progress) is displayed.</p>
S t A t	PV				
oFF	SV				
<table border="1"> <tr> <td>RCN 1</td> <td>PV</td> </tr> <tr> <td>10</td> <td>SV</td> </tr> </table>	RCN 1	PV	10	SV	<p>5. Use the   keys to change StAt to RUNt. The number of days that the controller has operated is displayed.</p>
RCN 1	PV				
10	SV				
	<p>6. Press the  key to return to the PV/SV display.</p>				

FALt Error source (443)

[Description]

Displays the source of an error. (with hexadecimal number)

0 bit	PV input underflow (LLLL)
1 bit	PV input overflow (UUUU)
2 bit	PV under range
3 bit	PV over range
4 bit	RSV under range
5 bit	RSV over range
6 bit	Range setting error
8 bit	PV input circuit error
9 bit	RSV input circuit error
10 bit	CT & PFB input circuit error
11 bit	PFB input underrange
12 bit	PFB input overrange

[Setting example] Checking the error source

Display	Operating procedure				
<table border="1"> <tr> <td>2 4 5</td> <td>PV</td> </tr> <tr> <td>250</td> <td>SV</td> </tr> </table>	2 4 5	PV	250	SV	<ol style="list-style-type: none"> 1. Check that the PV/SV display is shown. 2. Press and hold the SEL key to display CH1 (PID parameters). 3. Use the \odot key to access CH4 (Monitor parameters). 4. Press the SEL key to enter CH4 (Monitor parameters). StAt (Ramp soak progress) is displayed. 5. Use the \wedge \odot keys to change StAt to FALt. The error source is displayed. (with hexadecimal number) 6. Press the \ominus key to return to the PV/SV display.
2 4 5	PV				
250	SV				
<table border="1"> <tr> <td>CH 4</td> <td>PV</td> </tr> <tr> <td>MoN</td> <td>SV</td> </tr> </table>	CH 4	PV	MoN	SV	
CH 4	PV				
MoN	SV				
<table border="1"> <tr> <td>S t A t</td> <td>PV</td> </tr> <tr> <td>oFF</td> <td>SV</td> </tr> </table>	S t A t	PV	oFF	SV	
S t A t	PV				
oFF	SV				
<table border="1"> <tr> <td>F A L t</td> <td>PV</td> </tr> <tr> <td>0000</td> <td>SV</td> </tr> </table>	F A L t	PV	0000	SV	
F A L t	PV				
0000	SV				





Di DI input state (444)

[Description]

Displays the state of DI (with hexadecimal number).

0 bit	DI 1
1 bit	DI 2
2 bit	DI 3
3 bit	DI 4
4 bit	DI 5





[Setting example] Checking the DI input state

Display	Operating procedure				
<table border="1"> <tr> <td>2 4 5</td> <td>PV</td> </tr> <tr> <td>250</td> <td>SV</td> </tr> </table>	2 4 5	PV	250	SV	<ol style="list-style-type: none"> 1. Check that the PV/SV display is shown. 2. Press and hold the SEL key to display CH1 (PID parameters). 3. Use the  key to access CH4 (Monitor parameters). 4. Press the SEL key to enter CH4 (Monitor parameters). StAt (Ramp soak progress) is displayed. 5. Use the   keys to change “StAt” to “di”. The DI input state is displayed in hexadecimal. 6. Press the  key to return to the PV/SV display.
2 4 5	PV				
250	SV				
<table border="1"> <tr> <td>CH 4</td> <td>PV</td> </tr> <tr> <td>MoN</td> <td>SV</td> </tr> </table>	CH 4	PV	MoN	SV	
CH 4	PV				
MoN	SV				
<table border="1"> <tr> <td>S t A t</td> <td>PV</td> </tr> <tr> <td>oFF</td> <td>SV</td> </tr> </table>	S t A t	PV	oFF	SV	
S t A t	PV				
oFF	SV				
<table border="1"> <tr> <td>d i</td> <td>PV</td> </tr> <tr> <td>0000</td> <td>SV</td> </tr> </table>	d i	PV	0000	SV	
d i	PV				
0000	SV				

ERSt Communication error station number (445)

[Description] _____
 Shows the station number under error and the detail of error during cooperative communication or programless communication.





[Setting example] Checking the station number under communication error _____

Display	Operating procedure				
<table border="1"> <tr> <td data-bbox="220 533 443 600">2 4 5</td> <td data-bbox="443 533 501 600">PV</td> </tr> <tr> <td data-bbox="220 600 443 667">250</td> <td data-bbox="443 600 501 667">SV</td> </tr> </table>	2 4 5	PV	250	SV	<p>1. Check that the PV/SV display is shown.</p>
2 4 5	PV				
250	SV				
<table border="1"> <tr> <td data-bbox="220 701 443 768">CH 4</td> <td data-bbox="443 701 501 768">PV</td> </tr> <tr> <td data-bbox="220 768 443 835">MoN</td> <td data-bbox="443 768 501 835">SV</td> </tr> </table>	CH 4	PV	MoN	SV	<p>2. Press and hold the SEL key to display CH1 (PID parameters). 3. Use the  key to access CH4 (Monitor parameters).</p>
CH 4	PV				
MoN	SV				
<table border="1"> <tr> <td data-bbox="220 891 443 958">S t A t</td> <td data-bbox="443 891 501 958">PV</td> </tr> <tr> <td data-bbox="220 958 443 1025">oFF</td> <td data-bbox="443 958 501 1025">SV</td> </tr> </table>	S t A t	PV	oFF	SV	<p>4. Press the SEL key to enter CH4 (Monitor parameters). StAt (Ramp soak progress) is displayed.</p>
S t A t	PV				
oFF	SV				
<table border="1"> <tr> <td data-bbox="220 1081 443 1149">ERS t</td> <td data-bbox="443 1081 501 1149">PV</td> </tr> <tr> <td data-bbox="220 1149 443 1216">0</td> <td data-bbox="443 1149 501 1216">SV</td> </tr> </table>	ERS t	PV	0	SV	<p>5. Use the   keys to change “StAt” to “ERSt”. The station number under communication error is displayed.</p>
ERS t	PV				
0	SV				
	<p>6. Press the  key to return to the PV/SV display.</p>				

PLNo Current PID No. (446)

[Description] _____
Displays the PID palette No. currently selected.





[Setting example] Checking the PID number currently selected _____

Display	Operating procedure				
<table border="1"><tr><td data-bbox="108 488 331 562">2 4 5</td><td data-bbox="338 488 387 562">PV</td></tr><tr><td data-bbox="108 571 331 629">250</td><td data-bbox="338 571 387 629">SV</td></tr></table>	2 4 5	PV	250	SV	<p>1. Check that the PV/SV display is shown.</p>
2 4 5	PV				
250	SV				
<table border="1"><tr><td data-bbox="108 660 331 734">CH 4</td><td data-bbox="338 660 387 734">PV</td></tr><tr><td data-bbox="108 743 331 801">MoN</td><td data-bbox="338 743 387 801">SV</td></tr></table>	CH 4	PV	MoN	SV	<p>2. Press and hold the SEL key to display CH1 (PID parameters).</p> <p>3. Use the  key to access CH4 (Monitor parameters).</p>
CH 4	PV				
MoN	SV				
<table border="1"><tr><td data-bbox="108 833 331 907">StAt</td><td data-bbox="338 833 387 907">PV</td></tr><tr><td data-bbox="108 916 331 974">oFF</td><td data-bbox="338 916 387 974">SV</td></tr></table>	StAt	PV	oFF	SV	<p>4. Press the SEL key to enter CH4 (Monitor parameters). StAt (Ramp soak progress) is displayed.</p>
StAt	PV				
oFF	SV				
<table border="1"><tr><td data-bbox="108 1005 331 1079">PLNo</td><td data-bbox="338 1005 387 1079">PV</td></tr><tr><td data-bbox="108 1088 331 1146">LoCL</td><td data-bbox="338 1088 387 1146">SV</td></tr></table>	PLNo	PV	LoCL	SV	<p>5. Use the   keys to change “StAt” to “PLNo”. The PID number currently selected is displayed.</p>
PLNo	PV				
LoCL	SV				
	<p>6. Press the  key to return to the PV/SV display.</p>				

PtNo Current pattern No. (447)

[Description] _____
Displays the ramp soak pattern No. currently selected.

[Setting example] Checking the pattern number currently selected _____

Display	Operating procedure				
<table border="1"><tr><td data-bbox="225 488 443 562">2 4 5</td><td data-bbox="443 488 496 562">PV</td></tr><tr><td data-bbox="225 562 443 629">250</td><td data-bbox="443 562 496 629">SV</td></tr></table>	2 4 5	PV	250	SV	1. Check that the PV/SV display is shown.
2 4 5	PV				
250	SV				
<table border="1"><tr><td data-bbox="225 658 443 732">CH 4</td><td data-bbox="443 658 496 732">PV</td></tr><tr><td data-bbox="225 732 443 799">MoN</td><td data-bbox="443 732 496 799">SV</td></tr></table>	CH 4	PV	MoN	SV	2. Press and hold the SEL key to display CH1 (PID parameters). 3. Use the  key to access CH4 (Monitor parameters).
CH 4	PV				
MoN	SV				
<table border="1"><tr><td data-bbox="225 828 443 902">S t A t</td><td data-bbox="443 828 496 902">PV</td></tr><tr><td data-bbox="225 902 443 969">oFF</td><td data-bbox="443 902 496 969">SV</td></tr></table>	S t A t	PV	oFF	SV	4. Press the SEL key to enter CH4 (Monitor parameters). StAt (Ramp soak progress) is displayed.
S t A t	PV				
oFF	SV				
<table border="1"><tr><td data-bbox="225 999 443 1072">P t N o</td><td data-bbox="443 999 496 1072">PV</td></tr><tr><td data-bbox="225 1072 443 1140">LoCL</td><td data-bbox="443 1072 496 1140">SV</td></tr></table>	P t N o	PV	LoCL	SV	5. Use the   keys to change “StAt” to “PtNo”. The currently selected pattern number is displayed
P t N o	PV				
LoCL	SV				
	6. Press the  key to return to the PV/SV display.				

3-6 CH5 ALM (Alarm parameters)

The alarm parameters (CH5) consists of the following function blocks.

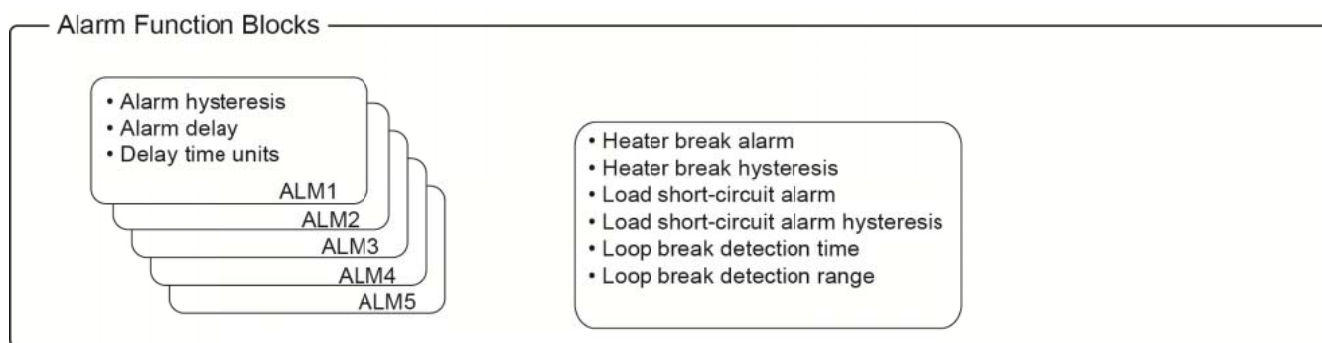

PXF4 can use ALM1 to ALM3.

PXF5/9 can use ALM1 to ALM5.

Alarm threshold values are set under ALM1 to ALM5 in the Operation control parameters.

A1tP to A5tP Alarm type (470, 475, 480, 485, 490)

[Description]

Set the alarm type for ALM1 to ALM5.

You can select the alarm type from the below tables.

1-point alarm

Type	A1Tp to A5Tp	Alarm Type	Action diagram
	0	No alarm	—
Absolute value alarm	1	High alarm	
	2	Low alarm	
	3	High alarm (with hold)	
	4	Low alarm (with hold)	
Deviation alarm	5	High alarm	
	6	Low alarm	
	7	High/Low alarm	
	8	High alarm (with hold)	
	9	Low alarm (with hold)	
	10	High/Low alarm (with hold)	
Zone alarm	11	High/Low deviation alarm	

2-point alarm

Type	A1Tp to A5Tp	Alarm Type	Action diagram	
High/Low limit alarm	16	High/Low absolute alarm		
	17	High/Low deviation alarm		
	18	High absolute/Low deviation alarm		
	19	High deviation/Low absolute alarm		
	20	High/Low absolute alarm (with hold)		
	21	High/Low deviation alarm (with hold)		
	22	High absolute/Low deviation alarm (with hold)		
	23	High deviation/Low absolute alarm (with hold)		
	Zone alarm	24	High/Low absolute alarm	
		25	High/Low deviation alarm	
		26	High absolute/Low deviation alarm	
		27	High deviation/Low absolute alarm	
		28	High/Low absolute alarm (with hold)	
29		High/Low deviation alarm (with hold)		
30		High absolute/Low deviation alarm (with hold)		
31		High deviation/Low absolute alarm (with hold)		

Timers and others

Type	A1Tp to A5Tp	Alarm Type	Action diagram
Timer	32	ON delay timer	
	33	OFF delay timer	
	34	ON/OFF delay timer	
	35	Delay start ON	
Open circuit/Short circuit	37	Loop break alarm	
	38	Heater burnout alarm (Optional CT is required)	
	41	Shorted load alarm (Optional CT is required)	
Power	45	Amount of electric energy	
Maintenance	46	Preventive maintenance. The number of times that the relay has operated (MV1, MV2)	
	47	Preventive maintenance. Operated hours	

What is alarm with hold?



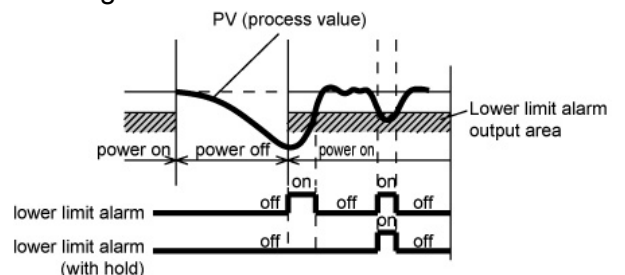

The alarm will not turn ON immediately when the process value gets into the alarm band and enters again.



Note:

- When alarm action code is changed, alarm set value may also become different from previous settings.
 - When alarm action type code is changed, turn off the power once, and then re-start the controller, before starting control.
 - ALn: indicates the alarm set values (AL1 to AL5).
 - ALnh: indicates the alarm set values (A1-H to A5-H).
 - ALnL: indicates the alarm set values (A1-L to A5-L).
 - dLYn: indicates the alarm delay set values (dLY1 to dLY5).
- You can assign different event output functions for DO1 to DO5, other than alarm functions. Refer to "CH.7 OUT, DO, and LED indicator assignment" for event output functions.

[Setting example] Setting the type of the alarm 1 to "upper limit deviation alarm with hold"

Display	Operating procedure				
<table border="1"> <tr> <td data-bbox="108 763 331 831">2 4 5</td> <td data-bbox="336 763 384 831">PV</td> </tr> <tr> <td data-bbox="108 837 331 898">250</td> <td data-bbox="336 837 384 898">SV</td> </tr> </table>	2 4 5	PV	250	SV	<p>1. Check that the PV/SV display is shown.</p>
2 4 5	PV				
250	SV				
<table border="1"> <tr> <td data-bbox="108 936 331 1003">CH 5</td> <td data-bbox="336 936 384 1003">PV</td> </tr> <tr> <td data-bbox="108 1010 331 1070">ALM</td> <td data-bbox="336 1010 384 1070">SV</td> </tr> </table>	CH 5	PV	ALM	SV	<p>2. Press and hold the SEL key to display CH1 (PID parameters).</p> <p>3. Use the  key to access CH5 (Alarm parameters).</p>
CH 5	PV				
ALM	SV				
<table border="1"> <tr> <td data-bbox="108 1160 331 1227">A 1 t P</td> <td data-bbox="336 1160 384 1227">PV</td> </tr> <tr> <td data-bbox="108 1234 331 1294">0</td> <td data-bbox="336 1234 384 1294">SV</td> </tr> </table>	A 1 t P	PV	0	SV	<p>4. Press the SEL key to enter CH5 (Alarm parameters). A1tP (alarm type) is displayed.</p> <p>5. Press the SEL key. (The first digit of the lower part of the screen begins to blink.)</p>
A 1 t P	PV				
0	SV				
<table border="1"> <tr> <td data-bbox="108 1323 331 1391">8</td> <td data-bbox="336 1323 384 1391">SV</td> </tr> </table>	8	SV	<p>6. Use the   keys to change 0 to 8.</p>		
8	SV				
	<p>7. Press the SEL key to save the change.</p>				
	<p>8. Repeat the same steps to set the type for the alarm 2 to the alarm 3.</p>				
	<p>9. Press the  key to return to the PV/SV display.</p>				

A1HY to **A5HY** Alarm hysteresis (471, 476, 481, 486, 491)

dLY1 to **dLY5** Alarm delay (472, 477, 482, 487, 492)

dL1U to **dL5U** Alarm delay time units (473, 478, 483, 488, 493)

[Description]

Alarm parameter settings are as follows:

Alarm hysteresis	Specifies alarm detection width and recovery width. Setting range: 0 to 50% FS
Alarm delay time	Specifies the amount of time from the occurrence of the alarm to the sounding of the alarm. Setting range: 0 to 9999 (sec/min)
Alarm delay time units	Specifies the unit of time (sec/min) used for the alarm delay Setting range: sec/min

The alarm and hysteresis are related as follows.

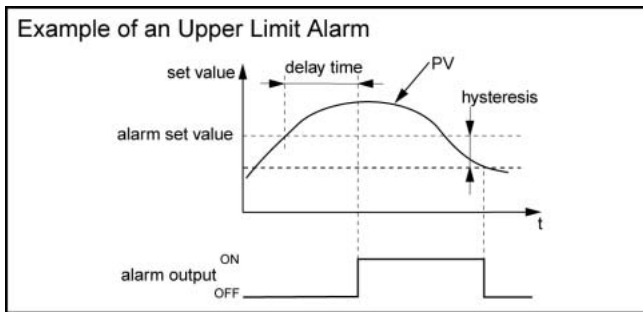

• upper limit alarm

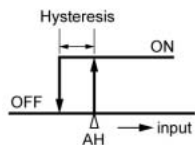

• lower limit alarm

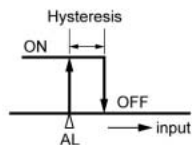

• range alarm

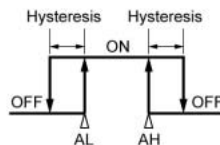

[Setting example] Setting the Alarm 1 hysteresis to 5°C, delay time to 30, and delay time unit to seconds

Display	Operating procedure				
<table border="1"> <tr> <td>245</td> <td>PV</td> </tr> <tr> <td>250</td> <td>SV</td> </tr> </table>	245	PV	250	SV	1. Check that the PV/SV display is shown.
245	PV				
250	SV				
<table border="1"> <tr> <td>CH 5</td> <td>PV</td> </tr> <tr> <td>ALM</td> <td>SV</td> </tr> </table>	CH 5	PV	ALM	SV	2. Press and hold the SEL key to display CH1 (PID parameters). 3. Use the \odot key to access CH5 (Alarm parameters).
CH 5	PV				
ALM	SV				
<table border="1"> <tr> <td>A1tP</td> <td>PV</td> </tr> <tr> <td>1</td> <td>SV</td> </tr> </table>	A1tP	PV	1	SV	4. Press the SEL key to enter CH5 (Alarm parameters). A1tP (alarm type) is displayed.
A1tP	PV				
1	SV				
<table border="1"> <tr> <td>A1HY</td> <td>PV</td> </tr> <tr> <td>1</td> <td>SV</td> </tr> </table>	A1HY	PV	1	SV	5. Use the \wedge \odot keys to change A1tP to A1HY. 6. Press the SEL key. (The first digit of the lower part of the screen begins to blink.)
A1HY	PV				
1	SV				
<table border="1"> <tr> <td>5</td> <td>SV</td> </tr> </table>	5	SV	7. Use the \wedge \odot keys to change 1 to 5. 8. Press the SEL key to save the change.		
5	SV				
<table border="1"> <tr> <td>dLY1</td> <td>PV</td> </tr> <tr> <td>0</td> <td>SV</td> </tr> </table>	dLY1	PV	0	SV	9. Use the \wedge \odot keys to change A1HY to dLY1. 10. Press the SEL key. (The first digit of the lower part of the screen begins to blink.)
dLY1	PV				
0	SV				
<table border="1"> <tr> <td>30</td> <td>SV</td> </tr> </table>	30	SV	11. Use the \wedge \odot keys to change 0 to 30. 12. Press the SEL key to save the change.		
30	SV				
<table border="1"> <tr> <td>dL1U</td> <td>PV</td> </tr> <tr> <td>Min</td> <td>SV</td> </tr> </table>	dL1U	PV	Min	SV	13. Use the \wedge \odot keys to change dLY1 to dL1U. 14. Press the SEL key. (The first digit of the lower part of the screen begins to blink.)
dL1U	PV				
Min	SV				
<table border="1"> <tr> <td>SEC</td> <td>SV</td> </tr> </table>	SEC	SV	15. Use the \wedge \odot keys to change Min to SEC. 16. Press the SEL key to save the change.		
SEC	SV				
	17. Repeat the same steps to set the hysteresis, delay time, and delay time unit for the alarm 2 to the alarm 3.				
	18. Press the \odot key to return to the PV/SV display.				

AoP1 to **AoP5** Alarm option (474, 470, 484, 489, 494)

[Description] _____

You can set the optional functions to the alarm 1 to the alarm 5, if you need. The four types of optional functions are assigned for each bit.

- Setting range: 0000 to 1111

The inverted output alarm can be imitated in software by changing from SPST contact to SPDT contact. It becomes SPST contact when power is cut.

Alarms are set per bit.

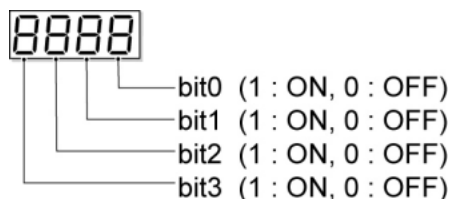

bit	Function	Description
bit 0	Alarm latch	Latches (maintains) the state when an event occurs.
bit 1	Input error alarm	Outputs when an input error ("UUUU" or "LLLL" is displayed) occurs. Set the alarm type to "0" to use this function.
bit 2	Inverted output function	Inverts the output and outputs from the DO terminal when an event occurs.
bit 3	Hold reset function	When an alarm with hold is applied, the hold function is reset when any of the following actions occur: SV change/alarm type change/alarm set value change/standby cancel/ power off and on

[Setting example] Adding the alarm latch and the converted output function to the alarm 1

Display	Operating procedure				
<table border="1"> <tr> <td>245</td> <td>PV</td> </tr> <tr> <td>250</td> <td>SV</td> </tr> </table>	245	PV	250	SV	<p>1. Check that the PV/SV display is shown.</p>
245	PV				
250	SV				
<table border="1"> <tr> <td>CH 5</td> <td>PV</td> </tr> <tr> <td>ALM</td> <td>SV</td> </tr> </table>	CH 5	PV	ALM	SV	<p>2. Press and hold the SEL key to display CH1 (PID parameters).</p> <p>3. Use the \odot key to access CH5 (Alarm parameters).</p>
CH 5	PV				
ALM	SV				
<table border="1"> <tr> <td>A1tP</td> <td>PV</td> </tr> <tr> <td>1</td> <td>SV</td> </tr> </table>	A1tP	PV	1	SV	<p>4. Press the SEL key to enter CH5 (Alarm parameters). A1tP (alarm type) is displayed.</p>
A1tP	PV				
1	SV				
<table border="1"> <tr> <td>AoP1</td> <td>PV</td> </tr> <tr> <td>0000</td> <td>SV</td> </tr> </table>	AoP1	PV	0000	SV	<p>5. Use the \wedge \vee keys to change A1tP to AoP1.</p> <p>6. Press the SEL key. (The first digit of the lower part of the screen begins to blink.)</p>
AoP1	PV				
0000	SV				
<table border="1"> <tr> <td>0101</td> <td>SV</td> </tr> </table>	0101	SV	<p>7. Use the \wedge \vee keys to change 0000 to 0101.</p> <p>8. Press the SEL key to save the change.</p>		
0101	SV				
	<p>9. Repeat the same steps to set the optional functions for the alarm 2 to the alarm 3.</p>				
	<p>10. Press the \odot key to return to the PV/SV display.</p>				

Hb1 Heater break alarm set value (500)

Hb1H Heater break alarm hysteresis (501)

[Description]

This function controls whether the heater break alarm is active.

The heater break alarm includes the following settings:

Heater break alarm Settings	The electric current set value at which the alarm trips. • Range: 0.0A to 100.0A
Heater break alarm hysteresis	The detection and recovery width of the heater break alarm hysteresis. • Range: 0.0A to 100.0A

• The following connection diagram includes CT connections.

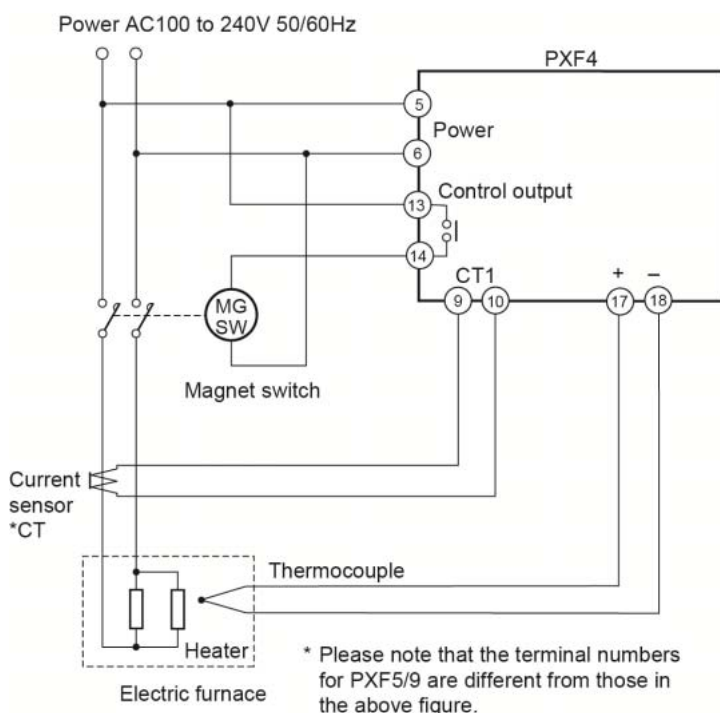

• The relationship between the heater disconnect alarm settings and hysteresis is shown below

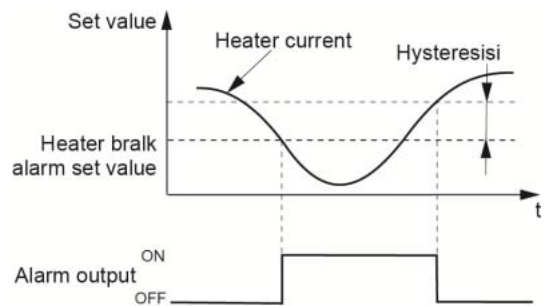

Note:

- This is not used when the heater is controlled by thyristor phase angle control.
- When the margin of error is large due to low heater capacity, the problem is resolved by doubling the current to increase the sensitivity. (Be sure to double the setting value in such cases.)
- If there are multiple CTs, make sure to use the same procedure for each of them.

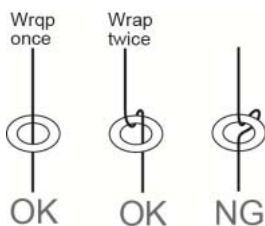

- The heater break detector CT is connected as shown below:

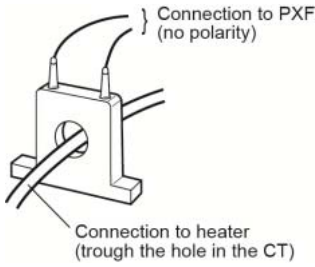

- The heater break alarm is effective only for a singlephase power supply. It cannot be used for a threephase power supply.
- The heater current detection is available only after the control output 1 has been working for at least 0.3 seconds.
- The heater break alarm is not available when the control output 1 is current or voltage output.

[Setting example] Setting the HB alarm to 5A and the HB alarm hysteresis to 2A

Display	Operating procedure				
<table border="1" style="width: 100%;"> <tr> <td style="text-align: center; width: 100px;">2 4 5</td> <td style="width: 20px; text-align: center;">PV</td> </tr> <tr> <td style="text-align: center;">250</td> <td style="text-align: center;">SV</td> </tr> </table>	2 4 5	PV	250	SV	<p>1. Check that the PV/SV display is shown.</p>
2 4 5	PV				
250	SV				
<table border="1" style="width: 100%;"> <tr> <td style="text-align: center; width: 100px;">2 4 5</td> <td style="width: 20px; text-align: center;">PV</td> </tr> <tr> <td style="text-align: center;">250</td> <td style="text-align: center;">SV</td> </tr> </table>	2 4 5	PV	250	SV	<p>2. Switch to manual mode. (Refer to “Auto/manual switchover” on page 29.)</p>
2 4 5	PV				
250	SV				
<table border="1" style="width: 100%;"> <tr> <td style="text-align: center; width: 100px;">2 4 5</td> <td style="width: 20px; text-align: center;">PV</td> </tr> <tr> <td style="text-align: center;">MV 100</td> <td style="text-align: center;">SV</td> </tr> </table>	2 4 5	PV	MV 100	SV	<p>3. In MV display, use the Δ key to set the control output (MV) to 100%.</p>
2 4 5	PV				
MV 100	SV				
<table border="1" style="width: 100%;"> <tr> <td style="text-align: center; width: 100px;">CH 4</td> <td style="width: 20px; text-align: center;">PV</td> </tr> <tr> <td style="text-align: center;">MoN</td> <td style="text-align: center;">SV</td> </tr> </table>	CH 4	PV	MoN	SV	<p>4. Press and hold the SEL key to display CH1 (PID parameters). 5. Use the Δ key to access CH4 (Monitor parameters).</p>
CH 4	PV				
MoN	SV				
<table border="1" style="width: 100%;"> <tr> <td style="text-align: center; width: 100px;">StAt</td> <td style="width: 20px; text-align: center;">PV</td> </tr> <tr> <td style="text-align: center;">oFF</td> <td style="text-align: center;">SV</td> </tr> </table>	StAt	PV	oFF	SV	<p>6. Press the SEL key to enter CH4 (Monitor parameters). StAt (Ramp soak progress) is displayed.</p>
StAt	PV				
oFF	SV				
<table border="1" style="width: 100%;"> <tr> <td style="text-align: center; width: 100px;">Ct 1</td> <td style="width: 20px; text-align: center;">PV</td> </tr> <tr> <td style="text-align: center;">7.1</td> <td style="text-align: center;">SV</td> </tr> </table>	Ct 1	PV	7.1	SV	<p>7. Use the Δ ∇ keys to change “StAt” to “Ct1” (heater current). Check the value of CT1. (The appropriate trigger value for HB alarm is 70 to 80% of the current value.)</p>
Ct 1	PV				
7.1	SV				

CH 5	PV
ALM	SV

AltP	PV
1	SV

Hb 1	PV
5.0	SV

Hb 1H	PV
2.0	SV

8. Press the SEL key to switch to CH1 (PID parameters).
9. Use the \odot key to access CH5 (Alarm parameters).
10. Press the SEL key to enter CH5 (Alarm parameters).
AltP (alarm type) is displayed.
11. Use the \triangle \odot keys to change "AltP" to "Hb1" (Heater alarm set value)
12. Press the SEL key.
(The first digit of the lower part of the screen begins to blink.)
13. Use the \triangle \odot keys to change "0.0" to "5.0".
14. Press the SEL key to save the change.
15. Use the \triangle \odot keys to change "Hb1" to "Hb1H" (HB alarm hysteresis).
16. Press the SEL key.
(The first digit of the lower part of the screen begins to blink.)
17. Use the \triangle \odot keys to change "0.0" to "2.0".
18. Press the SEL key to save the change.
19. Press the \ominus key to return to the PV/SV display.

Applicable current transformers:

single-phase

- 1~30A : CTL-6-S-H
- 20~100A : CTL-12-S36-8F

HS1 Shorted-load alarm set value (502)

HS1H Shorted load alarm hysteresis (503)

[Description]

These are the functions to detect short-circuiting of the SSR or Conductor.

The setting items of the load short-circuit alarm are as follows:

Load shortcircuit alarm setting	Sets the electrical current value at which to detect a load short-circuit alarm. • Range: 0.0 to 100.0A
Load shortcircuit alarm hysteresis	Sets the space between the detection and restoration of the load short-circuit alarm. • Range: 0.0A to 100.0A

- The current detection is available only after the control output 1 has been inactive for at least 0.3 seconds.
- The shorted-load alarm is not available when the control output 1 is current or voltage output.

[Setting example] Setting the shorted-load alarm set value to 5A and the shorted load alarm hysteresis to 2A

Display	Operating procedure				
<table border="1"> <tr> <td>2 4 5</td> <td>PV</td> </tr> <tr> <td>250</td> <td>SV</td> </tr> </table>	2 4 5	PV	250	SV	1. Check that the PV/SV display is shown.
2 4 5	PV				
250	SV				
<table border="1"> <tr> <td>CH 5</td> <td>PV</td> </tr> <tr> <td>ALM</td> <td>SV</td> </tr> </table>	CH 5	PV	ALM	SV	2. Press and hold the SEL key to display CH1 (PID parameters). 3. Use the \odot key to access CH5 (Alarm parameters).
CH 5	PV				
ALM	SV				
<table border="1"> <tr> <td>A l t P</td> <td>PV</td> </tr> <tr> <td>1</td> <td>SV</td> </tr> </table>	A l t P	PV	1	SV	4. Press the SEL key to enter CH5 (Alarm parameters). AltP (alarm type) is displayed.
A l t P	PV				
1	SV				
<table border="1"> <tr> <td>HS 1</td> <td>PV</td> </tr> <tr> <td>0.0</td> <td>SV</td> </tr> </table>	HS 1	PV	0.0	SV	5. Use the \wedge \odot keys to change "ALtP" to "HS1". 6. Press the SEL key. (The first digit of the lower part of the screen begins to blink.)
HS 1	PV				
0.0	SV				
<table border="1"> <tr> <td>5.0</td> <td>SV</td> </tr> </table>	5.0	SV	7. Use the \wedge \odot keys to change "0.0" to "5.0". 8. Press the SEL key to save the change.		
5.0	SV				
<table border="1"> <tr> <td>HS 1 H</td> <td>PV</td> </tr> <tr> <td>0.5</td> <td>SV</td> </tr> </table>	HS 1 H	PV	0.5	SV	9. Use the \wedge \odot keys to change "HS1" to "HS1H". 10. Press the SEL key. (The first digit of the lower part of the screen begins to blink.)
HS 1 H	PV				
0.5	SV				
<table border="1"> <tr> <td>2.0</td> <td>SV</td> </tr> </table>	2.0	SV	11. Use the \wedge \odot keys to change "0.0" to "2.0". 12. Press the SEL key to save the change. 13. Press the \odot key to return to the PV/SV display.		
2.0	SV				

LbtM Loop break detection time (508)

LbAb Loop break detection range (509)

[Description] _____

This function detects if the control loop is broken.

This function does not use a CT like the heater break alarm, while instead it checks the change of control output and PV to determine if the loop is broken.

The loop break detector has the following functions.

Loop break detection time	Specifies how much time must pass before the loop is determined to be broken. Setting range: 0 to 9999 sec.
Loop break detection range	Sets the temperature range before detecting a broken loop Setting range: 0.0 to 100.0% FS

Loop break detection time and width are related as follows:

Example of Loop Break Detection in Reverse Operation

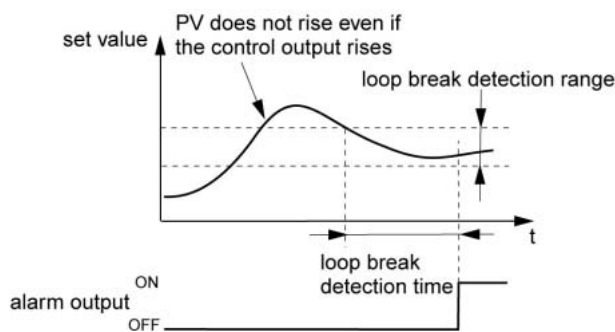

Note:

If there is an abnormal input (UUUU, LLLL) or an input setting error (Err), the alarm sounds even before the loop break detection time period.

[Setting example] Setting the loop break detection time to 600 sec. and detection range to 20°C

Display	Operating procedure				
<table border="1"> <tr> <td>2 4 5</td> <td>PV</td> </tr> <tr> <td>250</td> <td>SV</td> </tr> </table>	2 4 5	PV	250	SV	<p>1. Check that the PV/SV display is shown.</p>
2 4 5	PV				
250	SV				
<table border="1"> <tr> <td>CH 5</td> <td>PV</td> </tr> <tr> <td>ALM</td> <td>SV</td> </tr> </table>	CH 5	PV	ALM	SV	<p>2. Press and hold the SEL key to display CH1 (PID parameters). 3. Use the \odot key to access CH5 (Alarm parameters).</p>
CH 5	PV				
ALM	SV				
<table border="1"> <tr> <td>A 1 t P</td> <td>PV</td> </tr> <tr> <td>1</td> <td>SV</td> </tr> </table>	A 1 t P	PV	1	SV	<p>4. Press the SEL key to enter CH5 (Alarm parameters). A1tP (alarm type) is displayed.</p>
A 1 t P	PV				
1	SV				
<table border="1"> <tr> <td>L b t M</td> <td>PV</td> </tr> <tr> <td>0</td> <td>SV</td> </tr> </table>	L b t M	PV	0	SV	<p>5. Use the \wedge \odot keys to change A1tP to LbtM. 6. Press the SEL key. (The first digit of the lower part of the screen begins to blink.)</p>
L b t M	PV				
0	SV				
<table border="1"> <tr> <td>600</td> <td>SV</td> </tr> </table>	600	SV	<p>7. Use the \wedge \odot keys to change 0 to 600. 8. Press the SEL key to save the change.</p>		
600	SV				
<table border="1"> <tr> <td>L b A b</td> <td>PV</td> </tr> <tr> <td>2</td> <td>SV</td> </tr> </table>	L b A b	PV	2	SV	<p>9. Use the \wedge \odot keys to change LbtM to LbAb. 10. Press the SEL key. (The first digit of the lower part of the screen begins to blink.)</p>
L b A b	PV				
2	SV				
<table border="1"> <tr> <td>20</td> <td>SV</td> </tr> </table>	20	SV	<p>11. Use the \wedge \odot keys to change 2 to 20. 12. Press the SEL key to save the change.</p>		
20	SV				
	<p>13. Press the \odot key to return to the PV/SV display.</p>				

WHAL Electricity alarm (511)

[Description]

Allows you to set the value for electricity alarm.

The electricity alarm will be activated when the amount of electric power has reached the setpoint.

- Setting range

Decimal point position for electric power (WdP)	Setting range
0	0 to 9999 kWh
0.1	0.0 to 999.9 kWh
0.01	0.00 to 99.99 kWh
0.001	0.000 to 9.999 kWh

[Setting example] Setting the electricity alarm to 20.0 kWh

Display	Operating procedure				
<table border="1"> <tr> <td>2 4 5</td> <td>PV</td> </tr> <tr> <td>250</td> <td>SV</td> </tr> </table>	2 4 5	PV	250	SV	1. Check that the PV/SV display is shown.
2 4 5	PV				
250	SV				
<table border="1"> <tr> <td>CH 5</td> <td>PV</td> </tr> <tr> <td>ALM</td> <td>SV</td> </tr> </table>	CH 5	PV	ALM	SV	2. Press and hold the SEL key to display CH1 (PID parameters). 3. Use the \odot key to access CH5 (Alarm parameters).
CH 5	PV				
ALM	SV				
<table border="1"> <tr> <td>A 1 t P</td> <td>PV</td> </tr> <tr> <td>1</td> <td>SV</td> </tr> </table>	A 1 t P	PV	1	SV	4. Press the SEL key to enter CH5 (Alarm parameters). A1tP (alarm type) is displayed.
A 1 t P	PV				
1	SV				
<table border="1"> <tr> <td>W H A L</td> <td>PV</td> </tr> <tr> <td>10.0</td> <td>SV</td> </tr> </table>	W H A L	PV	10.0	SV	5. Use the \wedge \odot keys to change A1tP to WHAL. 6. Press the SEL key. (The first digit of the lower part of the screen begins to blink.)
W H A L	PV				
10.0	SV				
<table border="1"> <tr> <td>20.0</td> <td>SV</td> </tr> </table>	20.0	SV	7. Use the \wedge \odot keys to change 10.0 to 20.0. 8. Press the SEL key to save the change.		
20.0	SV				
	9. Press the \ominus key to return to the PV/SV display.				

3-7 CH6 SET (Setup parameters)

PVt PV input type (530)

[Description]

Allows you to select PV input source from thermocouples, RTD, and others.

Note:

- The connection to the terminal block differs with types of input (thermocouple/RTD/voltage or current input). Check the Instruction Manual.

[Setting example] Changing the input from thermocouple K to thermocouple R

Display	Operating procedure				
<table border="1"> <tr> <td data-bbox="108 712 331 779">2 4 5</td> <td data-bbox="338 712 383 779">PV</td> </tr> <tr> <td data-bbox="108 788 331 846">250</td> <td data-bbox="338 788 383 846">SV</td> </tr> </table>	2 4 5	PV	250	SV	<p>1. Check that the PV/SV display is shown.</p>
2 4 5	PV				
250	SV				
<table border="1"> <tr> <td data-bbox="108 880 331 947">CH 6</td> <td data-bbox="338 880 383 947">PV</td> </tr> <tr> <td data-bbox="108 956 331 1014">SEt</td> <td data-bbox="338 956 383 1014">SV</td> </tr> </table>	CH 6	PV	SEt	SV	<p>2. Press and hold the SEL key to display CH1 (PID parameters).</p> <p>3. Use the \odot key to access CH6 (Setup parameters).</p>
CH 6	PV				
SEt	SV				
<table border="1"> <tr> <td data-bbox="108 1048 331 1115">PV t</td> <td data-bbox="338 1048 383 1115">PV</td> </tr> <tr> <td data-bbox="108 1124 331 1182">K1</td> <td data-bbox="338 1124 383 1182">SV</td> </tr> </table>	PV t	PV	K1	SV	<p>4. Press the SEL key to enter CH6 (Setup parameters). PVt (PV input type) is displayed.</p> <p>5. Press the SEL key. (The first digit of the lower part of the screen begins to blink.)</p>
PV t	PV				
K1	SV				
<table border="1"> <tr> <td data-bbox="108 1216 331 1283">R</td> <td data-bbox="338 1216 383 1283">SV</td> </tr> </table>	R	SV	<p>6. Use \wedge \vee keys to change K1 to R.</p> <p>7. Press the SEL key to save the change.</p>		
R	SV				
	<p>8. Press the \ominus key to return to the PV/SV display.</p>				

PVb PV input lower limit (531)

PVF PV input upper limit (532)

[Description]

Allows you to set the upper/lower limit of PV input within the measurement range.

Setting range: -1999 to 9999

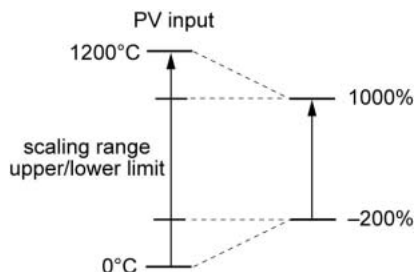

Note:

- Be sure to set the values so that PVF is greater than PVb.
- Be sure to set the values so that the subtraction of PVb from PVF is less than 10000 with no decimal point.

[Setting example] Setting the PV input upper limit to 1000°C and lower limit to 200°C

Display	Operating procedure				
<table border="1"> <tr> <td>2 4 5</td> <td>PV</td> </tr> <tr> <td>250</td> <td>SV</td> </tr> </table>	2 4 5	PV	250	SV	1. Check that the PV/SV display is shown.
2 4 5	PV				
250	SV				
<table border="1"> <tr> <td>CH 6</td> <td>PV</td> </tr> <tr> <td>SEt</td> <td>SV</td> </tr> </table>	CH 6	PV	SEt	SV	2. Press and hold the SEL key to display CH1 (PID parameters). 3. Use the \odot key to access CH6 (Setup parameters).
CH 6	PV				
SEt	SV				
<table border="1"> <tr> <td>PV t</td> <td>PV</td> </tr> <tr> <td>K1</td> <td>SV</td> </tr> </table>	PV t	PV	K1	SV	4. Press the SEL key to enter CH6 (Setup parameters). PVt (PV input type) is displayed.
PV t	PV				
K1	SV				
<table border="1"> <tr> <td>PV b</td> <td>PV</td> </tr> <tr> <td>0</td> <td>SV</td> </tr> </table>	PV b	PV	0	SV	5. Use the \wedge \odot keys to change PVt to PVb.
PV b	PV				
0	SV				
<table border="1"> <tr> <td>200</td> <td>SV</td> </tr> </table>	200	SV	6. Press the SEL key. (The first digit of the lower part of the screen begins to blink.)		
200	SV				
<table border="1"> <tr> <td>400</td> <td>SV</td> </tr> </table>	400	SV	7. Use the \wedge \odot keys to change 0 to 200.		
400	SV				
<table border="1"> <tr> <td>1000</td> <td>SV</td> </tr> </table>	1000	SV	8. Press the SEL key to save the change.		
1000	SV				
<table border="1"> <tr> <td>PVF</td> <td>PV</td> </tr> <tr> <td>400</td> <td>SV</td> </tr> </table>	PVF	PV	400	SV	9. Use the \wedge \odot keys to change PVb to PVF.
PVF	PV				
400	SV				
<table border="1"> <tr> <td>1000</td> <td>SV</td> </tr> </table>	1000	SV	10. Press the SEL key. (The first digit of the lower part of the screen begins to blink.)		
1000	SV				
<table border="1"> <tr> <td>1000</td> <td>SV</td> </tr> </table>	1000	SV	11. Use the \wedge \odot keys to change 400 to 1000.		
1000	SV				
<table border="1"> <tr> <td>1000</td> <td>SV</td> </tr> </table>	1000	SV	12. Press the SEL key to save the change.		
1000	SV				
<table border="1"> <tr> <td>1000</td> <td>SV</td> </tr> </table>	1000	SV	13. Press the \odot key to return to the PV/SV display.		
1000	SV				

PVd Decimal point position (533)

[Description]

Sets the decimal point position for the PV.

- Setting range 0: No digit after decimal point
 - 1: 1 digit after decimal point
 - 2: 2 digit after decimal point
 - 3: 3 digit after decimal point

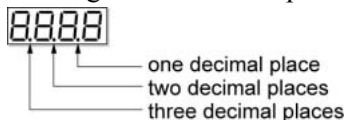

- Two, three decimal places are available only when the input is voltage/current.
- If you change the setting from numerals without decimal point to numerals with decimal point, the measurement range is limited to the range from -199.9°C through 999.9°C. For example, if you make the above change when the range is from 0 through 1300°C, the range will become the one from 0.0 through 999.9°C.

[Setting example] Setting the PV display with one decimal place

Display	Operating procedure				
<table border="1" style="margin: auto;"> <tr> <td style="text-align: center;">2 4 5</td> <td style="text-align: center;">PV</td> </tr> <tr> <td style="text-align: center;">250</td> <td style="text-align: center;">SV</td> </tr> </table>	2 4 5	PV	250	SV	<ol style="list-style-type: none"> 1. Check that the PV/SV display is shown. 2. Press and hold the SEL key to display CH1 (PID parameters). 3. Use the key to access CH6 (Setup parameters). 4. Press the SEL key to enter CH6 (Setup parameters). PVt (PV input type) is displayed. 5. Use the keys to change PVt to PVd. 6. Press the SEL key. (The first digit of the lower part of the screen begins to blink.) 7. Use the keys to change 0 to 1. 8. Press the SEL key to save the change. 9. Press the key to return to the PV/SV display.
2 4 5	PV				
250	SV				
<table border="1" style="margin: auto;"> <tr> <td style="text-align: center;">CH 6</td> <td style="text-align: center;">PV</td> </tr> <tr> <td style="text-align: center;">SEt</td> <td style="text-align: center;">SV</td> </tr> </table>	CH 6	PV	SEt	SV	
CH 6	PV				
SEt	SV				
<table border="1" style="margin: auto;"> <tr> <td style="text-align: center;">PV t</td> <td style="text-align: center;">PV</td> </tr> <tr> <td style="text-align: center;">K1</td> <td style="text-align: center;">SV</td> </tr> </table>	PV t	PV	K1	SV	
PV t	PV				
K1	SV				
<table border="1" style="margin: auto;"> <tr> <td style="text-align: center;">PV d</td> <td style="text-align: center;">PV</td> </tr> <tr> <td style="text-align: center;">0</td> <td style="text-align: center;">SV</td> </tr> </table>	PV d	PV	0	SV	
PV d	PV				
0	SV				
<table border="1" style="margin: auto;"> <tr> <td style="text-align: center;">1</td> <td style="text-align: center;">SV</td> </tr> </table>	1	SV			
1	SV				

CUT Square-root extractor cut point (535)

[Description]

Square root extractions

- To convert differential pressure to flow rate, square root extraction is used. Where the differential pressure is small, the differential pressure to the router cut point is handled as zero, because under such a condition flow fluctuation or noise affects largely on readings.



Setting range: -0.1 to 105.0% (Setting -0.1% cancels square root extraction)

[Setting example] Setting the cut point to 1.0

Display	Operating procedure				
<table border="1"> <tr> <td>2 4 5</td> <td>PV</td> </tr> <tr> <td>250</td> <td>SV</td> </tr> </table>	2 4 5	PV	250	SV	1. Check that the PV/SV display is shown.
2 4 5	PV				
250	SV				
<table border="1"> <tr> <td>CH 6</td> <td>PV</td> </tr> <tr> <td>SEt</td> <td>SV</td> </tr> </table>	CH 6	PV	SEt	SV	2. Press and hold the SEL key to display CH1 (PID parameters). 3. Use the \odot key to access CH6 (Setup parameters).
CH 6	PV				
SEt	SV				
<table border="1"> <tr> <td>PV t</td> <td>PV</td> </tr> <tr> <td>K1</td> <td>SV</td> </tr> </table>	PV t	PV	K1	SV	4. Press the SEL key to enter CH6 (Setup parameters). PVt (PV input type) is displayed.
PV t	PV				
K1	SV				
<table border="1"> <tr> <td>CU t</td> <td>PV</td> </tr> <tr> <td>-0.1</td> <td>SV</td> </tr> </table>	CU t	PV	-0.1	SV	5. Use the \wedge \odot keys to change PVt to CUt. 6. Press the SEL key. (The first digit of the lower part of the screen begins to blink.)
CU t	PV				
-0.1	SV				
<table border="1"> <tr> <td>1.0</td> <td>SV</td> </tr> </table>	1.0	SV	7. Use the \wedge \odot keys to change -0.1 to 1.0. 8. Press the SEL key to save the change.		
1.0	SV				
	9. Press the \odot key to return to the PV/SV display.				

PVoF PV input shift (536)

[Description]

This function shifts PV input before display.

This function can be used to make the SV value correspond with other instruments.

- Setting range: -10 to 10% FS

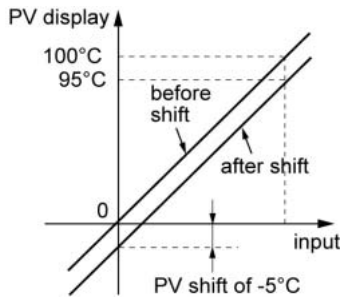

[Setting example] Setting the PV input shift to -5.0°C

Display	Operating procedure				
<table border="1"> <tr> <td>2 4 5</td> <td>PV</td> </tr> <tr> <td>250</td> <td>SV</td> </tr> </table>	2 4 5	PV	250	SV	1. Check that the PV/SV display is shown.
2 4 5	PV				
250	SV				
<table border="1"> <tr> <td>CH 6</td> <td>PV</td> </tr> <tr> <td>SEt</td> <td>SV</td> </tr> </table>	CH 6	PV	SEt	SV	2. Press and hold the SEL key to display CH1 (PID parameters).
CH 6	PV				
SEt	SV				
	3. Use the \odot key to access CH6 (Setup parameters).				
<table border="1"> <tr> <td>PV t</td> <td>PV</td> </tr> <tr> <td>K1</td> <td>SV</td> </tr> </table>	PV t	PV	K1	SV	4. Press the SEL key to enter CH6 (Setup parameters). PVt (PV input type) is displayed.
PV t	PV				
K1	SV				
<table border="1"> <tr> <td>PVoF</td> <td>PV</td> </tr> <tr> <td>0</td> <td>SV</td> </tr> </table>	PVoF	PV	0	SV	5. Use the \wedge \vee keys to change PVt to PVoF.
PVoF	PV				
0	SV				
	6. Press the SEL key. (The first digit of the lower part of the screen begins to blink.)				
<table border="1"> <tr> <td>-5.0</td> <td>SV</td> </tr> </table>	-5.0	SV	7. Use the \wedge \vee keys to change 0 to -5.0.		
-5.0	SV				
	8. Press the SEL key to save the change.				
	9. Press the \odot key to return to the PV/SV display.				

SVoF SV shift (537)







[Description]

This function specifies the SV shift.

This is used to eliminate remaining offset when using P control.

- Controls act on the calculated SV with SV offset.
- Alarm determination acts on the displayed SV without SV offset.
- Range: -50% to 50%

[Setting example] Setting the SV shift to 7°C

Display	Operating procedure				
<table border="1"> <tr> <td>245.0</td> <td>PV</td> </tr> <tr> <td>250.0</td> <td>SV</td> </tr> </table>	245.0	PV	250.0	SV	<p>1. Check that the PV/SV display is shown.</p>
245.0	PV				
250.0	SV				
<table border="1"> <tr> <td>CH 6</td> <td>PV</td> </tr> <tr> <td>SEt</td> <td>SV</td> </tr> </table>	CH 6	PV	SEt	SV	<p>2. Press and hold the SEL key to display CH1 (PID parameters).</p> <p>3. Use the  key to access CH6 (Setup parameters).</p>
CH 6	PV				
SEt	SV				
<table border="1"> <tr> <td>PVt</td> <td>PV</td> </tr> <tr> <td>K1</td> <td>SV</td> </tr> </table>	PVt	PV	K1	SV	<p>4. Press the SEL key to enter CH6 (Setup parameters). PVt (PV input type) is displayed.</p>
PVt	PV				
K1	SV				
<table border="1"> <tr> <td>SVoF</td> <td>PV</td> </tr> <tr> <td>0.0</td> <td>SV</td> </tr> </table>	SVoF	PV	0.0	SV	<p>5. Use the   keys to change "PVt" to "SVoF".</p> <p>6. Press the SEL key. (The first digit of the lower part of the screen begins to blink.)</p>
SVoF	PV				
0.0	SV				
<table border="1"> <tr> <td>7.0</td> <td>SV</td> </tr> </table>	7.0	SV	<p>7. Use the   keys to change "0.0" to "7.0".</p> <p>8. Press the SEL key to save the change.</p>		
7.0	SV				
	<p>9. Press the  key to return to the PV/SV display.</p>				

tF PV input filter (538)

[Description]

This low-pass filter function reduces noise and signal fluctuation.

- Setting range: 0.0 to 120.0 sec. (input filter time constant)

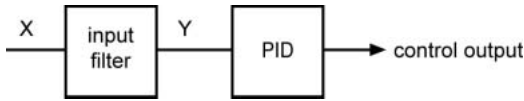

If the input filter time constant is set to 5 and input is changed from 0 to 100%, the PV display gradually changes, and it takes about 5 seconds for the value to change from 0 to 63.2%, as shown in the figure below.

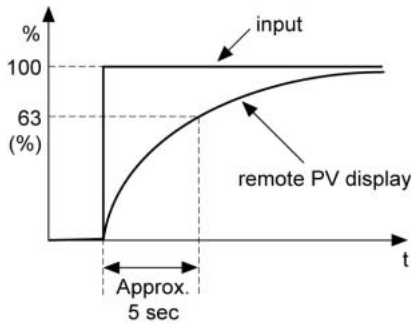

Note:

The factory setting for input filter time constant is 5%. Do not change this value unless absolutely necessary.

[Setting example] Setting the PV input filter time constant to 10 seconds

Display	Operating procedure				
<table border="1"> <tr> <td>2 4 5</td> <td>PV</td> </tr> <tr> <td>250</td> <td>SV</td> </tr> </table>	2 4 5	PV	250	SV	1. Check that the PV/SV display is shown.
2 4 5	PV				
250	SV				
<table border="1"> <tr> <td>CH 6</td> <td>PV</td> </tr> <tr> <td>SEt</td> <td>SV</td> </tr> </table>	CH 6	PV	SEt	SV	2. Press and hold the SEL key to display CH1 (PID parameters). 3. Use the \odot key to access CH6 (Setup parameters).
CH 6	PV				
SEt	SV				
<table border="1"> <tr> <td>PV t</td> <td>PV</td> </tr> <tr> <td>K1</td> <td>SV</td> </tr> </table>	PV t	PV	K1	SV	4. Press the SEL key to enter CH6 (Setup parameters). PVt (PV input type) is displayed.
PV t	PV				
K1	SV				
<table border="1"> <tr> <td>t F</td> <td>PV</td> </tr> <tr> <td>5</td> <td>SV</td> </tr> </table>	t F	PV	5	SV	5. Use the \wedge \odot keys to change PVt to tF. 6. Press the SEL key. (The first digit of the lower part of the screen begins to blink.)
t F	PV				
5	SV				
<table border="1"> <tr> <td>10</td> <td>SV</td> </tr> </table>	10	SV	7. Use the \wedge \odot keys to change 5 to 10.		
10	SV				
	8. Press the SEL key to save the change.				
	9. Press the \odot key to return to the PV/SV display.				

Adj0 PV display zero adjustment (539)

AdjS PV display span adjustment (540)

[Description] _____

This is the procedure for adjusting the PV display zero/span.

Set the following equipment before using these parameters or starting revisions.

- mv Generator
1V to 5V (for voltage/current input)
0mV to 100mV (for thermocouple input)
- Dial resistance unit
100.0 to 400.0 (for resistance thermometer bulb input)
- Range: -50.0% to 50.0% FS (zero/span)

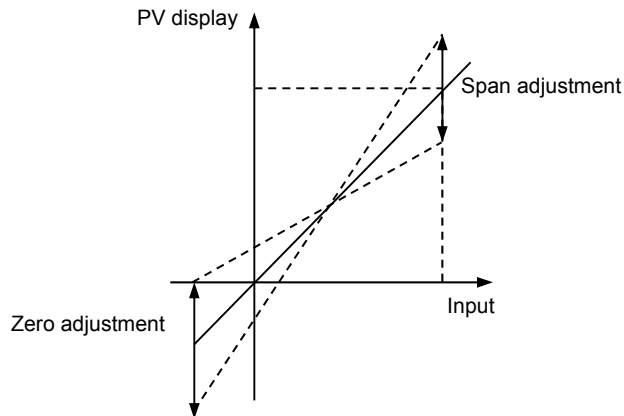

Note:

- Set the zero/span adjustment value to "0" to restore the factory setting.
- The user correction function operates independently from the controller adjustment value. Setting this value to 0 returns the settings to the factory settings.

[Setting example] Adjusting zero and span in PV display

Display	Operating procedure				
	<ol style="list-style-type: none"> 1. Confirm the accuracy of PV display by checking PV display when an mV generator or a dial resistor is set to 0% and 100%. This example assumes a zero deviation of -3°C and a span deviation of 4°C. Note: Before using thermocouple input, make sure that cold junction compensation is off. See “Cold junction compensation” on page 123. 				
<table border="1"> <tr> <td>245</td> <td>PV</td> </tr> <tr> <td>250</td> <td>SV</td> </tr> </table>	245	PV	250	SV	<ol style="list-style-type: none"> 2. Check that the PV/SV display is shown.
245	PV				
250	SV				
<table border="1"> <tr> <td>CH 6</td> <td>PV</td> </tr> <tr> <td>SEt</td> <td>SV</td> </tr> </table>	CH 6	PV	SEt	SV	<ol style="list-style-type: none"> 3. Press and hold the SEL key to display CH1 (PID parameters). 4. Use the \odot key to access CH6 (Setup parameters).
CH 6	PV				
SEt	SV				
<table border="1"> <tr> <td>PVt</td> <td>PV</td> </tr> <tr> <td>K1</td> <td>SV</td> </tr> </table>	PVt	PV	K1	SV	<ol style="list-style-type: none"> 5. Press the SEL key to enter CH6 (Setup parameters). PVt (PV input type) is displayed.
PVt	PV				
K1	SV				
<table border="1"> <tr> <td>AdJ0</td> <td>PV</td> </tr> <tr> <td>0</td> <td>SV</td> </tr> </table>	AdJ0	PV	0	SV	<ol style="list-style-type: none"> 6. Use the \wedge \odot keys to change “PVt” to “AdJ0”. 7. Press the SEL key. (The first digit of the lower part of the screen begins to blink.)
AdJ0	PV				
0	SV				
<table border="1"> <tr> <td>3</td> <td>SV</td> </tr> </table>	3	SV	<ol style="list-style-type: none"> 8. Use the \wedge \odot keys to change “0” to “3”. 9. Press the SEL key to save the change. 		
3	SV				
<table border="1"> <tr> <td>AdJS</td> <td>PV</td> </tr> <tr> <td>0</td> <td>SV</td> </tr> </table>	AdJS	PV	0	SV	<ol style="list-style-type: none"> 10. Use the \wedge \odot keys to change “AdJ0” to “AdJS”. 11. Press the SEL key. (The first digit of the lower part of the screen begins to blink.)
AdJS	PV				
0	SV				
<table border="1"> <tr> <td>-4</td> <td>SV</td> </tr> </table>	-4	SV	<ol style="list-style-type: none"> 12. Use the \wedge \odot keys to change “0” to “-4”. 13. Press the SEL key to save the change. 		
-4	SV				
	<ol style="list-style-type: none"> 14. Press the \odot key to return to the PV/SV display. 15. By using an mV generator or a dial resistor, input the values corresponds to 0% and 100% to check errors of PV display. Fix the errors, if any. 				

Caution:

Be sure to set the cold junction compensation back to “ON” when using thermocouple input.

RCJ Cold junction compensation (541)

[Description]

This is the procedure for turning cold junction compensation on or off when using input from a thermocouple sensor.

This setting should be left "ON" during normal operation. It should only be turned off when cold junction compensation is being performed externally or you wish to record temperature differences.

- Range oN: Cold junction compensation on
 oFF: Cold junction compensation off

[Setting example] Setting the cold junction compensation to OFF

Display	Operating procedure				
<table border="1"> <tr> <td>2 4 5</td> <td>PV</td> </tr> <tr> <td>250</td> <td>SV</td> </tr> </table>	2 4 5	PV	250	SV	1. Check that the PV/SV display is shown.
2 4 5	PV				
250	SV				
<table border="1"> <tr> <td>CH 6</td> <td>PV</td> </tr> <tr> <td>SEt</td> <td>SV</td> </tr> </table>	CH 6	PV	SEt	SV	2. Press and hold the SEL key to display CH1 (PID parameters). 3. Use the \odot key to access CH6 (Setup parameters).
CH 6	PV				
SEt	SV				
<table border="1"> <tr> <td>PV t</td> <td>PV</td> </tr> <tr> <td>K1</td> <td>SV</td> </tr> </table>	PV t	PV	K1	SV	4. Press the SEL key to enter CH6 (Setup parameters). PVt (PV input type) is displayed.
PV t	PV				
K1	SV				
<table border="1"> <tr> <td>RCJ</td> <td>PV</td> </tr> <tr> <td>oN</td> <td>SV</td> </tr> </table>	RCJ	PV	oN	SV	5. Use the \wedge \odot keys to change "PVt" to "RCJ". 6. Press the SEL key.
RCJ	PV				
oN	SV				
<table border="1"> <tr> <td>oFF</td> <td>SV</td> </tr> </table>	oFF	SV	7. Use the \wedge \odot keys to change "oN" to "oFF". 8. Press the SEL key to save the change. 9. Press the \ominus key to return to the PV/SV display.		
oFF	SV				

REMO Remote SV zero adjustment (543)

REMS Remote SV span adjustment (544)

[Description] _____

This function adjusts remote SV zero/span.

Use this function to match zero/span to an output gauge.

- Range: -50% to 50% FS (zero/span)

If the input range is 1 V to 5 V, zero and span adjustment shall be as follows.

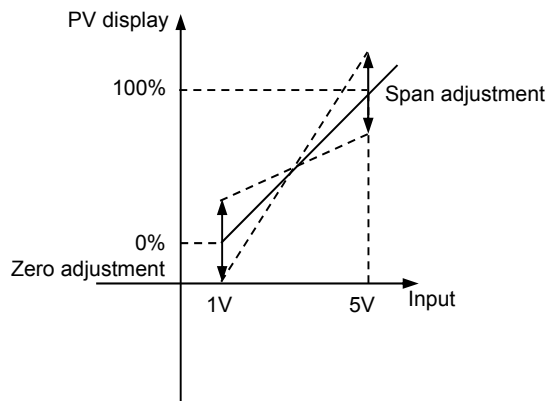

[Setting example] Adjusting zero and span in PV display

Display	Operating procedure					
<table border="1" style="width: 100%; border-collapse: collapse;"> <tr> <td style="text-align: center; padding: 5px;">2 4 5</td> <td style="text-align: center; padding: 5px;">PV</td> </tr> <tr> <td style="text-align: center; padding: 5px;">250</td> <td style="text-align: center; padding: 5px;">SV</td> </tr> </table>	2 4 5	PV	250	SV	<ol style="list-style-type: none"> 1. Confirm the accuracy of PV display by checking PV display when an output gauge or a dial resistor is set to 0% and 100%. This example assumes a zero deviation of -5% and a span deviation of 7%. See "Remote SV" on page 85. 2. Check that the PV/SV display is shown. 3. Press and hold the SEL key to display CH1 (PID parameters). 4. Use the \odot key to access CH6 (Setup parameters). 	
2 4 5	PV					
250	SV					
<table border="1" style="width: 100%; border-collapse: collapse;"> <tr> <td style="text-align: center; padding: 5px;">CH 6</td> <td style="text-align: center; padding: 5px;">PV</td> </tr> <tr> <td style="text-align: center; padding: 5px;">SEt</td> <td style="text-align: center; padding: 5px;">SV</td> </tr> </table>	CH 6	PV	SEt	SV		<ol style="list-style-type: none"> 5. Press the SEL key to enter CH6 (Setup parameters). PVt (PV input type) is displayed.
CH 6	PV					
SEt	SV					
<table border="1" style="width: 100%; border-collapse: collapse;"> <tr> <td style="text-align: center; padding: 5px;">PV t</td> <td style="text-align: center; padding: 5px;">PV</td> </tr> <tr> <td style="text-align: center; padding: 5px;">K1</td> <td style="text-align: center; padding: 5px;">SV</td> </tr> </table>	PV t	PV	K1	SV	<ol style="list-style-type: none"> 6. Use the \wedge \odot keys to change "PVt" to "REM0". 7. Press the SEL key. (The first digit of the lower part of the screen begins to blink.) 8. Use the \wedge \odot keys to change "0" to "5". 9. Press the SEL key to save the change. 	
PV t	PV					
K1	SV					
<table border="1" style="width: 100%; border-collapse: collapse;"> <tr> <td style="text-align: center; padding: 5px;">REMO</td> <td style="text-align: center; padding: 5px;">PV</td> </tr> <tr> <td style="text-align: center; padding: 5px;">0</td> <td style="text-align: center; padding: 5px;">SV</td> </tr> </table>	REMO	PV	0	SV	<ol style="list-style-type: none"> 10. Use the \wedge \odot keys to change "PVt" to "REMS". 11. Press the SEL key. (The first digit of the lower part of the screen begins to blink.) 12. Use the \wedge \odot keys to change "0" to "-7". 13. Press the SEL key to save the change. 	
REMO	PV					
0	SV					
<table border="1" style="width: 100%; border-collapse: collapse;"> <tr> <td style="text-align: center; padding: 5px;">5</td> <td style="text-align: center; padding: 5px;">SV</td> </tr> </table>	5	SV	<ol style="list-style-type: none"> 14. Press the \ominus key to return to the PV/SV display. 15. By using a device on output side, input the values corresponds to 0% and 100% to check errors of remote SV display. Fix the errors, if any. 			
5	SV					
<table border="1" style="width: 100%; border-collapse: collapse;"> <tr> <td style="text-align: center; padding: 5px;">REMS</td> <td style="text-align: center; padding: 5px;">PV</td> </tr> <tr> <td style="text-align: center; padding: 5px;">0</td> <td style="text-align: center; padding: 5px;">SV</td> </tr> </table>	REMS	PV		0	SV	<ol style="list-style-type: none"> 14. Press the \ominus key to return to the PV/SV display. 15. By using a device on output side, input the values corresponds to 0% and 100% to check errors of remote SV display. Fix the errors, if any.
REMS	PV					
0	SV					
<table border="1" style="width: 100%; border-collapse: collapse;"> <tr> <td style="text-align: center; padding: 5px;">-7</td> <td style="text-align: center; padding: 5px;">SV</td> </tr> </table>	-7	SV				
-7	SV					







REMR Remote SV input range (545)

[Description]

This is the procedure for specifying the remote SV input range.

- Range 0-5V: 0V to 5V
- 1-5V: 1V to 5V
- 0-10: 0V to 10V
- 2-10: 2V to 10V

[Setting example] Setting the remote SV input range to 0-5V

Display	Operating procedure				
<table style="width: 100%; border-collapse: collapse;"> <tr> <td style="border: 1px solid black; padding: 5px; text-align: center;">2 4 5</td> <td style="border: 1px solid black; padding: 5px; text-align: center;">PV</td> </tr> <tr> <td style="border: 1px solid black; padding: 5px; text-align: center;">250</td> <td style="border: 1px solid black; padding: 5px; text-align: center;">SV</td> </tr> </table>	2 4 5	PV	250	SV	<ol style="list-style-type: none"> 1. Check that the PV/SV display is shown. 2. Press and hold the SEL key to display CH1 (PID parameters). 3. Use the  key to access CH6 (Setup parameters). 4. Press the SEL key to enter CH6 (Setup parameters). PVt (PV input type) is displayed. 5. Use the   keys to change "PVt" to "REMR". 6. Press the SEL key. 7. Use the   keys to change "1-5V" to "0-5V". 8. Press the SEL key to save the change. 9. Press the  key to return to the PV/SV display.
2 4 5	PV				
250	SV				
<table style="width: 100%; border-collapse: collapse;"> <tr> <td style="border: 1px solid black; padding: 5px; text-align: center;">CH 6</td> <td style="border: 1px solid black; padding: 5px; text-align: center;">PV</td> </tr> <tr> <td style="border: 1px solid black; padding: 5px; text-align: center;">SEt</td> <td style="border: 1px solid black; padding: 5px; text-align: center;">SV</td> </tr> </table>	CH 6	PV	SEt	SV	
CH 6	PV				
SEt	SV				
<table style="width: 100%; border-collapse: collapse;"> <tr> <td style="border: 1px solid black; padding: 5px; text-align: center;">PV t</td> <td style="border: 1px solid black; padding: 5px; text-align: center;">PV</td> </tr> <tr> <td style="border: 1px solid black; padding: 5px; text-align: center;">K1</td> <td style="border: 1px solid black; padding: 5px; text-align: center;">SV</td> </tr> </table>	PV t	PV	K1	SV	
PV t	PV				
K1	SV				
<table style="width: 100%; border-collapse: collapse;"> <tr> <td style="border: 1px solid black; padding: 5px; text-align: center;">REMR</td> <td style="border: 1px solid black; padding: 5px; text-align: center;">PV</td> </tr> <tr> <td style="border: 1px solid black; padding: 5px; text-align: center;">1-5V</td> <td style="border: 1px solid black; padding: 5px; text-align: center;">SV</td> </tr> </table>	REMR	PV	1-5V	SV	
REMR	PV				
1-5V	SV				
<table style="width: 100%; border-collapse: collapse;"> <tr> <td style="border: 1px solid black; padding: 5px; text-align: center;">0-5V</td> <td style="border: 1px solid black; padding: 5px; text-align: center;">SV</td> </tr> </table>	0-5V	SV			
0-5V	SV				

RtF Remote SV input filter (546)

[Description]

This low-pass filter function reduces noise and signal wavering.

- Range: 0.0 sec to 120.0 sec (input filter damping)

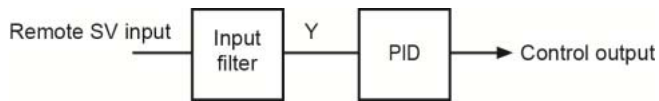

When the input suddenly steps from 0% to 100% with the input filter constant set to 5 seconds, the remote SV display will change slowly and take 5 seconds to change from 0% to 63.2%.

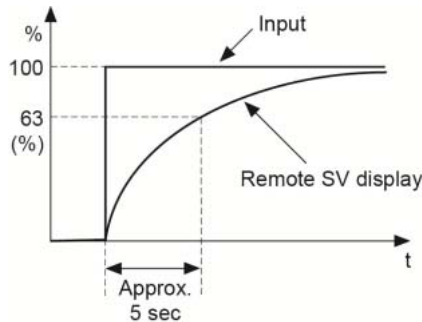

Note:

The factory setting for input filter damping is 5%. Do not change this unless absolutely necessary.

[Setting example] Setting the remote SV input filter to 10.0 s

Display	Operating procedure				
<table border="1"> <tr> <td>2 4 5</td> <td>PV</td> </tr> <tr> <td>250</td> <td>SV</td> </tr> </table>	2 4 5	PV	250	SV	1. Check that the PV/SV display is shown.
2 4 5	PV				
250	SV				
<table border="1"> <tr> <td>CH 6</td> <td>PV</td> </tr> <tr> <td>SEt</td> <td>SV</td> </tr> </table>	CH 6	PV	SEt	SV	2. Press and hold the SEL key to display CH1 (PID parameters).
CH 6	PV				
SEt	SV				
<table border="1"> <tr> <td>PV t</td> <td>PV</td> </tr> <tr> <td>K1</td> <td>SV</td> </tr> </table>	PV t	PV	K1	SV	3. Use the \odot key to access CH6 (Setup parameters).
PV t	PV				
K1	SV				
<table border="1"> <tr> <td>R t F</td> <td>PV</td> </tr> <tr> <td>0.0</td> <td>SV</td> </tr> </table>	R t F	PV	0.0	SV	4. Press the SEL key to enter CH6 (Setup parameters). PVt (PV input type) is displayed.
R t F	PV				
0.0	SV				
<table border="1"> <tr> <td>10.0</td> <td>SV</td> </tr> </table>	10.0	SV	5. Use the \odot \odot keys to change "PVt" to "RtF".		
10.0	SV				
	6. Press the SEL key.				
	7. Use the \odot \odot keys to change "0.0" to "10.0".				
	8. Press the SEL key to save the change.				
	9. Press the \ominus key to return to the PV/SV display.				

C1R OUT1 range (547)

C2R OUT2 range (548)

[Description]

Allows you to set the range of the control output 1(OUT1, OUT2).

- Setting range
 - 0-5V: 0 to 5 V
 - 1-5V: 1 to 5 V
 - 0-10: 0 to 10 V
 - 2-10: 2 to 10 V
 - 0-20: 0 to 20 mA
 - 4-20: 4 to 20 mA

Note

If you have selected current output for the output 1 and the output 2 in model selection, do not set this parameter to 0-5V, 1-5V, 0-10, or 2-10.

If you have selected voltage output for the output 1 and the output 2 in model selection, do not set this parameter to 0-20 or 4-20. Wrong settings may cause malfunction.

[Setting example] Setting OUT1 range to 0-20 mA

Display	Operating procedure				
<table border="1"><tr><td>2 4 5</td><td>PV</td></tr><tr><td>250</td><td>SV</td></tr></table>	2 4 5	PV	250	SV	1. Check that the PV/SV display is shown.
2 4 5	PV				
250	SV				
<table border="1"><tr><td>CH 6</td><td>PV</td></tr><tr><td>SEt</td><td>SV</td></tr></table>	CH 6	PV	SEt	SV	2. Press and hold the SEL key to display CH1 (PID parameters).
CH 6	PV				
SEt	SV				
	3. Use the \odot key to access CH6 (Setup parameters).				
<table border="1"><tr><td>PV t</td><td>PV</td></tr><tr><td>K1</td><td>SV</td></tr></table>	PV t	PV	K1	SV	4. Press the SEL key to enter CH6 (Setup parameters). PVt (PV input type) is displayed.
PV t	PV				
K1	SV				
<table border="1"><tr><td>C 1 R</td><td>PV</td></tr><tr><td>4-20</td><td>SV</td></tr></table>	C 1 R	PV	4-20	SV	5. Use the \wedge \odot keys to change PVt to C1R.
C 1 R	PV				
4-20	SV				
	6. Press the SEL key. (The first digit of the lower part of the screen begins to blink.)				
<table border="1"><tr><td>0-20</td><td>SV</td></tr></table>	0-20	SV	7. Use the \wedge \odot keys to change "4-20" to "0-20".		
0-20	SV				
	8. Press the SEL key to save the change.				
	9. Press the \odot key to return to the PV/SV display.				

FLo1 MV1 during FALT (549)

FLo2 MV2 during FALT (550)

[Description]

Allows you to specify the control output values when the controller falls into FALT (input error).

- Setting range: -5.0% to 105.0% (OUT1/OUT2)

[Setting example] Setting the OUT1/OUT2 during FALT to 5%

Display	Operating procedure				
<table border="1"><tr><td>2 4 5</td><td>PV</td></tr><tr><td>250</td><td>SV</td></tr></table>	2 4 5	PV	250	SV	<p>1. Check that the PV/SV display is shown.</p>
2 4 5	PV				
250	SV				
<table border="1"><tr><td>CH 6</td><td>PV</td></tr><tr><td>SEt</td><td>SV</td></tr></table>	CH 6	PV	SEt	SV	<p>2. Press and hold the SEL key to display CH1 (PID parameters).</p> <p>3. Use the \odot key to access CH6 (Setup parameters).</p>
CH 6	PV				
SEt	SV				
<table border="1"><tr><td>PV t</td><td>PV</td></tr><tr><td>K1</td><td>SV</td></tr></table>	PV t	PV	K1	SV	<p>4. Press the SEL key to enter CH6 (Setup parameters). PVt (PV input type) is displayed.</p>
PV t	PV				
K1	SV				
<table border="1"><tr><td>FLo 1</td><td>PV</td></tr><tr><td>-5.0</td><td>SV</td></tr></table>	FLo 1	PV	-5.0	SV	<p>5. Use the \wedge \odot keys to change PVt to FLo1.</p> <p>6. Press the SEL key. (The first digit of the lower part of the screen begins to blink.)</p>
FLo 1	PV				
-5.0	SV				
<table border="1"><tr><td>5.0</td><td>SV</td></tr></table>	5.0	SV	<p>7. Use the \wedge \odot keys to change -5 to 5.</p> <p>8. Press the SEL key to save the change.</p>		
5.0	SV				
<table border="1"><tr><td>FLo 2</td><td>PV</td></tr><tr><td>-5.0</td><td>SV</td></tr></table>	FLo 2	PV	-5.0	SV	<p>9. Use the \wedge \odot keys to change FLo1 to FLo2.</p> <p>10. Press the SEL key. (The first digit of the lower part of the screen begins to blink.)</p>
FLo 2	PV				
-5.0	SV				
<table border="1"><tr><td>5.0</td><td>SV</td></tr></table>	5.0	SV	<p>11. Use the \wedge \odot keys to change -5 to 5.</p> <p>12. Press the SEL key to save the change.</p>		
5.0	SV				
	<p>13. Press the \ominus key to return to the PV/SV display.</p>				

SFo1 MV1 during soft start (551)

SFtM Soft start set time (553)

[Description]

This function controls the maximum output produced when turning on the equipment (including the temperature controller). The controls place an upper limit on the output for a set time period after the power is turned on. This function is useful for effects such as suppressing the heater output during equipment startup, or lightening the load. After the specified time has passed after switching on the equipment (or if SFTM = 0), the soft start function ends and normal controls begin.

Parameter	Function
SFo1	OUT1 is limited for the time period specified in SFtM after the power is turned on.
SFtM (in hh:mm)	Sets the time for soft start to function after turning power on. Setting "0" will turn off soft start.

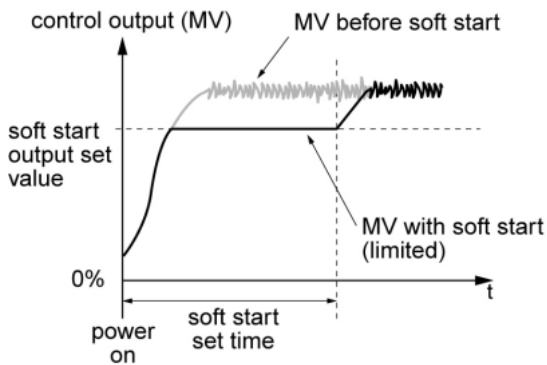

During manual mode, the manual output value has priority, but soft start will continue to keep track of the set time period.

Note:

The soft start function cannot be used when there are dual outputs.

Do not use self-tuning during soft start. The soft start may not be controlled correctly.

[Setting example] Setting OUT1 during soft start to 5%, and time to 30 minutes

Display	Operating procedure				
<table border="1"> <tr> <td>2 4 5</td> <td>PV</td> </tr> <tr> <td>250</td> <td>SV</td> </tr> </table>	2 4 5	PV	250	SV	<p>1. Check that the PV/SV display is shown.</p>
2 4 5	PV				
250	SV				
<table border="1"> <tr> <td>CH 6</td> <td>PV</td> </tr> <tr> <td>SEt</td> <td>SV</td> </tr> </table>	CH 6	PV	SEt	SV	<p>2. Press and hold the SEL key to display CH1 (PID parameters). 3. Use the \odot key to access CH6 (Setup parameters).</p>
CH 6	PV				
SEt	SV				
<table border="1"> <tr> <td>PV t</td> <td>PV</td> </tr> <tr> <td>K1</td> <td>SV</td> </tr> </table>	PV t	PV	K1	SV	<p>4. Press the SEL key to enter CH6 (Setup parameters). PVt (PV input type) is displayed.</p>
PV t	PV				
K1	SV				
<table border="1"> <tr> <td>SF o 1</td> <td>PV</td> </tr> <tr> <td>105.0</td> <td>SV</td> </tr> </table>	SF o 1	PV	105.0	SV	<p>5. Use the \wedge \vee keys to change PVt to SFo1. 6. Press the SEL key. (The first digit of the lower part of the screen begins to blink.)</p>
SF o 1	PV				
105.0	SV				
<table border="1"> <tr> <td>5.0</td> <td>SV</td> </tr> </table>	5.0	SV	<p>7. Use the \wedge \vee keys to change 105.0 to 5.0. 8. Press the SEL key to save the change.</p>		
5.0	SV				
<table border="1"> <tr> <td>SF tM</td> <td>PV</td> </tr> <tr> <td>0</td> <td>SV</td> </tr> </table>	SF tM	PV	0	SV	<p>9. Use the \wedge \vee keys to change SFo1 to SFtM. 10. Press the SEL key. (The first digit of the lower part of the screen begins to blink.)</p>
SF tM	PV				
0	SV				
<table border="1"> <tr> <td>30</td> <td>SV</td> </tr> </table>	30	SV	<p>11. Use the \wedge \vee keys to change 0 to 30. 12. Press the SEL key to save the change.</p>		
30	SV				
	<p>13. Press the \ominus key to return to the PV/SV display.</p>				

Sbo1 MV1 during standby (554)







Sbo2 MV2 during standby (555)

[Description]

Allows you to set the control output values used during standby mode.

- Setting range: -5.0% to 105.0% (OUT1/OUT2)

[Setting example] Setting OUT1 during standby to 5%

Display	Operating procedure				
<table border="1"><tr><td>2 4 5</td><td>PV</td></tr><tr><td>250</td><td>SV</td></tr></table>	2 4 5	PV	250	SV	1. Check that the PV/SV display is shown.
2 4 5	PV				
250	SV				
<table border="1"><tr><td>CH 6</td><td>PV</td></tr><tr><td>SEt</td><td>SV</td></tr></table>	CH 6	PV	SEt	SV	2. Press and hold the SEL key to display CH1 (PID parameters).
CH 6	PV				
SEt	SV				
	3. Use the  key to access CH6 (Setup parameters).				
<table border="1"><tr><td>PV t</td><td>PV</td></tr><tr><td>K1</td><td>SV</td></tr></table>	PV t	PV	K1	SV	4. Press the SEL key to enter CH6 (Setup parameters). PVt (PV input type) is displayed.
PV t	PV				
K1	SV				
<table border="1"><tr><td>Sbo 1</td><td>PV</td></tr><tr><td>-5.0</td><td>SV</td></tr></table>	Sbo 1	PV	-5.0	SV	5. Use the   keys to change PVt to Sbo1.
Sbo 1	PV				
-5.0	SV				
	6. Press the SEL key. (The first digit of the lower part of the screen begins to blink.)				
	7. Use the   keys to change -5.0 to 5.0.				
<table border="1"><tr><td>5.0</td><td>SV</td></tr></table>	5.0	SV	8. Press the SEL key to save the change.		
5.0	SV				
	9. Repeat the same steps to set OUT2 during standby.				
	10. Press the  key to return to the PV/SV display.				

SbMd Standby mode (556)

[Description]

Allows you to specify the alarm action during standby.

Select the alarm action and transfer output during standby among the following four combinations.

Setting range

SbMd	Alarm action	Transfer output
0	Suspends the alarm action. (alarm output OFF)	Continues to output.
1	Keeps the alarm action ON	Continues to output.
2	Suspends the alarm action. (alarm output OFF)	Outputs -5% value.
3	Keeps the alarm action ON	Outputs -5% value.

[Setting example] Setting the alarm action to be continued during standby

Display	Operating procedure				
<table border="1"> <tr> <td>2 4 5</td> <td>PV</td> </tr> <tr> <td>250</td> <td>SV</td> </tr> </table>	2 4 5	PV	250	SV	1. Check that the PV/SV display is shown.
2 4 5	PV				
250	SV				
<table border="1"> <tr> <td>CH 6</td> <td>PV</td> </tr> <tr> <td>SEt</td> <td>SV</td> </tr> </table>	CH 6	PV	SEt	SV	2. Press and hold the SEL key to display CH1 (PID parameters).
CH 6	PV				
SEt	SV				
<table border="1"> <tr> <td>PV t</td> <td>PV</td> </tr> <tr> <td>K1</td> <td>SV</td> </tr> </table>	PV t	PV	K1	SV	3. Use the \odot key to access CH6 (Setup parameters).
PV t	PV				
K1	SV				
<table border="1"> <tr> <td>S b M d</td> <td>PV</td> </tr> <tr> <td>0</td> <td>SV</td> </tr> </table>	S b M d	PV	0	SV	4. Press the SEL key to enter CH6 (Setup parameters). PVt (PV input type) is displayed.
S b M d	PV				
0	SV				
<table border="1"> <tr> <td>1</td> <td>SV</td> </tr> </table>	1	SV	5. Use the \wedge \odot keys to change PVt to SbMd.		
1	SV				
	6. Press the SEL key. (The first digit of the lower part of the screen begins to blink.)				
	7. Use the \wedge \odot keys to change 0 to 1.				
	8. Press the SEL key to save the change.				
	9. Press the \ominus key to return to the PV/SV display.				

Aot AO output type (557)







[Description]

This is the procedure to specify what output is retransmitted.

The following five settings are available:

- Range
 - Pv: Measurement
 - Sv: Set value
 - Mv: Control output
 - Dv: Variable (PV-SV)
 - Pfb: Position Feedback (Do not select this if you ordered the version without PFB input.)

[Setting example] Setting the AO output type to SV

Display	Operating procedure				
<table border="1" style="margin: auto;"> <tr> <td style="text-align: center;">2 4 5</td> <td style="text-align: center;">PV</td> </tr> <tr> <td style="text-align: center;">250</td> <td style="text-align: center;">SV</td> </tr> </table>	2 4 5	PV	250	SV	<p>1. Check that the PV/SV display is shown.</p>
2 4 5	PV				
250	SV				
<table border="1" style="margin: auto;"> <tr> <td style="text-align: center;">CH 6</td> <td style="text-align: center;">PV</td> </tr> <tr> <td style="text-align: center;">SEt</td> <td style="text-align: center;">SV</td> </tr> </table>	CH 6	PV	SEt	SV	<p>2. Press and hold the SEL key to display CH1 (PID parameters).</p> <p>3. Use the  key to access CH6 (Setup parameters).</p>
CH 6	PV				
SEt	SV				
<table border="1" style="margin: auto;"> <tr> <td style="text-align: center;">PVt</td> <td style="text-align: center;">PV</td> </tr> <tr> <td style="text-align: center;">K1</td> <td style="text-align: center;">SV</td> </tr> </table>	PVt	PV	K1	SV	<p>4. Press the SEL key to enter CH6 (Setup parameters). PVt (PV input type) is displayed.</p>
PVt	PV				
K1	SV				
<table border="1" style="margin: auto;"> <tr> <td style="text-align: center;">A o t</td> <td style="text-align: center;">PV</td> </tr> <tr> <td style="text-align: center;">PV</td> <td style="text-align: center;">SV</td> </tr> </table>	A o t	PV	PV	SV	<p>5. Use the   keys to change "PVt" to "Aot".</p> <p>6. Press the SEL key. (The first digit of the lower part of the screen begins to blink.)</p>
A o t	PV				
PV	SV				
<table border="1" style="margin: auto;"> <tr> <td style="text-align: center;">SV</td> <td style="text-align: center;">SV</td> </tr> </table>	SV	SV	<p>7. Use the   keys to change "PV" to "SV".</p> <p>8. Press the SEL key to save the change.</p> <p>9. Press the  key to return to the PV/SV display.</p>		
SV	SV				

AoL AO lower scaling (558)

AoH AO upper scaling (559)

[Description] _____

This is the procedure for specifying the upper and lower limits of re-transmission input.

- Range: -100% to 100% FS (Upper/lower limit)

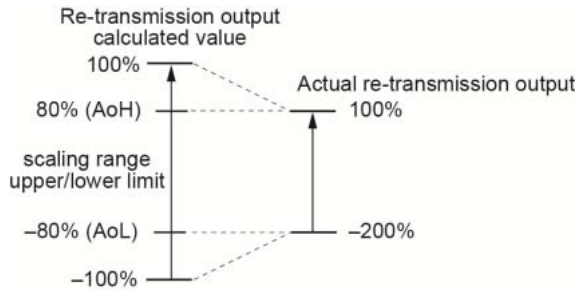

Calculate the set value with the following equation. (Use the example set value below as a reference.)

$$\text{Set value (\%)} = (A \div B) \times 100 \text{ [\%]}$$

A = (Desired temperature) – (Set value of parameter “PVb”)

B = (Set value of parameter “PVF”) – (Set value of “PVb”)

- When the value of the re-transmission output type (ex: SV) is equal to the AoL set value, the re-transmission output will be 0% (output).
- When the value of the re-transmission output type (ex: SV) is equal to the AoH set value, the re-transmission output will be 100% (output).

Note:

Make sure to set the value of AoH greater than AoL.

[Setting example] Setting the AO lower scaling to -80%, upper scaling to 80%

Display	Operating procedure				
<table border="1"> <tr> <td>2 4 5</td> <td>PV</td> </tr> <tr> <td>250</td> <td>SV</td> </tr> </table>	2 4 5	PV	250	SV	<p>1. Check that the PV/SV display is shown.</p>
2 4 5	PV				
250	SV				
<table border="1"> <tr> <td>CH 6</td> <td>PV</td> </tr> <tr> <td>SEt</td> <td>SV</td> </tr> </table>	CH 6	PV	SEt	SV	<p>2. Press and hold the SEL key to display CH1 (PID parameters). 3. Use the \odot key to access CH6 (Setup parameters).</p>
CH 6	PV				
SEt	SV				
<table border="1"> <tr> <td>PVt</td> <td>PV</td> </tr> <tr> <td>K1</td> <td>SV</td> </tr> </table>	PVt	PV	K1	SV	<p>4. Press the SEL key to enter CH6 (Setup parameters). PVt (PV input type) is displayed.</p>
PVt	PV				
K1	SV				
<table border="1"> <tr> <td>AoL</td> <td>PV</td> </tr> <tr> <td>0</td> <td>SV</td> </tr> </table>	AoL	PV	0	SV	<p>5. Use the \wedge \vee keys to change “PVt” to “AoL”. 6. Press the SEL key. (The first digit of the lower part of the screen begins to blink.)</p>
AoL	PV				
0	SV				
<table border="1"> <tr> <td>-80</td> <td>SV</td> </tr> </table>	-80	SV	<p>7. Use the \wedge \vee keys to change “0” to “-80”. 8. Press the SEL key to save the change.</p>		
-80	SV				
<table border="1"> <tr> <td>AoH</td> <td>PV</td> </tr> <tr> <td>0</td> <td>SV</td> </tr> </table>	AoH	PV	0	SV	<p>9. Use the \wedge \vee keys to change “PVt” to “AoH”. 10. Press the SEL key. (The first digit of the lower part of the screen begins to blink.)</p>
AoH	PV				
0	SV				
<table border="1"> <tr> <td>80</td> <td>SV</td> </tr> </table>	80	SV	<p>11. Use the \wedge \vee keys to change “0” to “80”. 12. Press the SEL key to save the change.</p>		
80	SV				
	<p>13. Press the \odot key to return to the PV/SV display.</p>				

VoLt Fixed voltage value (561)

CRU Current value for simple power calculation (562)

iMiN Electric current nullification point (563)

WdP Decimal point position for electric power (564)

PHY Power factor for simple calculation (565)

[Description] _____

These parameters are used for calculating the amount of electric power, based on the time duration that the control output relay 1 has operated.

- The amount of electric power is calculated by the following expression, with Fixed voltage value (VoLt), Current value for simple calculation (CUR), and Power factor for simple calculation (Phy).
Amount of electric energy (kWh) = Σ (OUT1ON \times VoLt \times CUR \times Phy)
OUT1ON: percentage of time that the control output relay 1 has operated
- The amount of electric power is displayed with the decimal point position set in Decimal point position for electric power (WdP).
- If the amount of electric power has reached the maximum value (9999) during calculation, the device restarts calculation from zero.
- The calculated amount of electric power is saved on the nonvolatile memory every 5 minutes.

[Fixed voltage value (VoLt)]

Allows you to set the voltage value to be applied on the controlled device when the control output relay 1 is activated.

Setting range: 1 to 500 V

[Current value for simple power calculation (CUR)]

Allows you to set the current which flows through the controlled device when the control output relay 1 is activated. If you set to 0.0, power calculation is carried out based on the current value measured by CT.

Setting range: 0.0 to 100.0 A

[Electric current nullification point (iMiN)]

Allows you to set the value below which the current value measured by CT to be used for power calculation is nullified.

The current value below the setpoint is treated as 0 A in power calculation.

Setting range: 0.0 A to 100.0 A

[Decimal point position for electric power (WdP)]

Allows you to set the decimal point position for electric energy. The maximum value of electric energy changes with the decimal point position.

Setting range: 0 to 3

Decimal point position	Max. electric energy
0	9999 (kWh)
1	999.9 (kWh)
2	99.99 (kWh)
3	9.999 (kWh)

[Power factor for simple calculation (PHY)]

Allows you to set the power factor for calculating electric power.

Setting range: 0.00 to 1.00

[Setting example] Setting the voltage to 150 V, current to 1.2 A, decimal place to 0.01 _____

Display	Operating procedure				
<table border="1"> <tr> <td>2 4 5</td> <td>PV</td> </tr> <tr> <td>250</td> <td>SV</td> </tr> </table>	2 4 5	PV	250	SV	<p>1. Check that the PV/SV display is shown.</p>
2 4 5	PV				
250	SV				
<table border="1"> <tr> <td>CH 6</td> <td>PV</td> </tr> <tr> <td>SEt</td> <td>SV</td> </tr> </table>	CH 6	PV	SEt	SV	<p>2. Press and hold the SEL key to display CH1 (PID parameters). 3. Use the \odot key to access CH6 (Setup parameters).</p>
CH 6	PV				
SEt	SV				
<table border="1"> <tr> <td>PVt</td> <td>PV</td> </tr> <tr> <td>K1</td> <td>SV</td> </tr> </table>	PVt	PV	K1	SV	<p>4. Press the SEL key to enter CH6 (Setup parameters). PVt (PV input type) is displayed. 5. Use the \wedge \odot keys to change PVt to VoLt.</p>
PVt	PV				
K1	SV				
<table border="1"> <tr> <td>VoLt</td> <td>PV</td> </tr> <tr> <td>100</td> <td>SV</td> </tr> </table>	VoLt	PV	100	SV	<p>6. Press the SEL key. (The first digit of the lower part of the screen begins to blink.) 7. Use the \wedge \odot keys to change 100 to 150.</p>
VoLt	PV				
100	SV				
<table border="1"> <tr> <td>150</td> <td>SV</td> </tr> </table>	150	SV	<p>8. Press the SEL key to save the change.</p>		
150	SV				
<table border="1"> <tr> <td>CUR</td> <td>PV</td> </tr> <tr> <td>0</td> <td>SV</td> </tr> </table>	CUR	PV	0	SV	<p>9. Use the \wedge \odot keys to change VoLt to CUR. 10. Press the SEL key. (The first digit of the lower part of the screen begins to blink.)</p>
CUR	PV				
0	SV				
<table border="1"> <tr> <td>1.2</td> <td>SV</td> </tr> </table>	1.2	SV	<p>11. Use the \wedge \odot keys to change 0 to 1.2. 12. Press the SEL key to save the change.</p>		
1.2	SV				
<table border="1"> <tr> <td>WbP</td> <td>PV</td> </tr> <tr> <td>0</td> <td>SV</td> </tr> </table>	WbP	PV	0	SV	<p>13. Use the \wedge \odot keys to change CUR to WbP. 14. Press the SEL key. (The first digit of the lower part of the screen begins to blink.)</p>
WbP	PV				
0	SV				
<table border="1"> <tr> <td>2</td> <td>SV</td> </tr> </table>	2	SV	<p>15. Use the \wedge \odot keys to change 0 to 2. 16. Press the SEL key to save the change.</p>		
2	SV				
	<p>17. Press the \odot key to return to the PV/SV display.</p>				

RYCN Upper limit of relay contact operation (566)

[Description]

Allows you to set the upper limit on the number of times that the control output relay 1 and 2 can operate. The alarm will be activated when the control output relay 1 or 2 has operated the number of times you set.

- You can set the upper limit of operating times in increments of 1000.
(For example, if you set this parameter to 1, the alarm will be activated when the relay worked 1000 times.)
- If you set it to 0, no alarm will be generated.
- The numbers of times that the control output relays have operated are saved on the nonvolatile memory every 10 minutes.

[Setting example] Setting the upper limit of contact operation to 20 thousand times

Display	Operating procedure				
<table border="1"> <tr> <td>2 4 5</td> <td>PV</td> </tr> <tr> <td>250</td> <td>SV</td> </tr> </table>	2 4 5	PV	250	SV	1. Check that the PV/SV display is shown.
2 4 5	PV				
250	SV				
<table border="1"> <tr> <td>CH 6</td> <td>PV</td> </tr> <tr> <td>SEt</td> <td>SV</td> </tr> </table>	CH 6	PV	SEt	SV	2. Press and hold the SEL key to display CH1 (PID parameters). 3. Use the \odot key to access CH6 (Setup parameters).
CH 6	PV				
SEt	SV				
<table border="1"> <tr> <td>PV t</td> <td>PV</td> </tr> <tr> <td>K1</td> <td>SV</td> </tr> </table>	PV t	PV	K1	SV	4. Press the SEL key to enter CH6 (Setup parameters). PVt (PV input type) is displayed. 5. Use the \wedge \odot keys to change PVt to RYCN.
PV t	PV				
K1	SV				
<table border="1"> <tr> <td>RYCN</td> <td>PV</td> </tr> <tr> <td>10</td> <td>SV</td> </tr> </table>	RYCN	PV	10	SV	6. Press the SEL key. (The first digit of the lower part of the screen begins to blink.) 7. Use the \wedge \odot keys to change 10 to 20.
RYCN	PV				
10	SV				
<table border="1"> <tr> <td>20</td> <td>SV</td> </tr> </table>	20	SV	8. Press the SEL key to save the change.		
20	SV				
	9. Press the \ominus key to return to the PV/SV display.				

oPtM Upper limit of operating days (567)







[Description]

Allows you to set the upper limit on the number of days that the device can operate.

The alarm will be activated when the number of operating days has reached the setpoint.

- You can set the upper limit of operating days in days.
(For example, if you set this parameter to 1, the alarm will be activated when the device worked 1 day.)
- If you set it to 0, no alarm will be generated.
- The number of operating days is saved on the nonvolatile memory every 10 minutes.

[Setting example] Setting the upper limit of operating days to 100 days

Display	Operating procedure				
<table border="1"> <tr> <td>2 4 5</td> <td>PV</td> </tr> <tr> <td>250</td> <td>SV</td> </tr> </table>	2 4 5	PV	250	SV	<p>1. Check that the PV/SV display is shown.</p>
2 4 5	PV				
250	SV				
<table border="1"> <tr> <td>CH 6</td> <td>PV</td> </tr> <tr> <td>SEt</td> <td>SV</td> </tr> </table>	CH 6	PV	SEt	SV	<p>2. Press and hold the SEL key to display CH1 (PID parameters).</p> <p>3. Use the  key to access CH6 (Setup parameters).</p>
CH 6	PV				
SEt	SV				
<table border="1"> <tr> <td>PV t</td> <td>PV</td> </tr> <tr> <td>K1</td> <td>SV</td> </tr> </table>	PV t	PV	K1	SV	<p>4. Press the SEL key to enter CH6 (Setup parameters). PVt (PV input type) is displayed.</p> <p>5. Use the   keys to change PVt to oPtM.</p>
PV t	PV				
K1	SV				
<table border="1"> <tr> <td>o P t M</td> <td>PV</td> </tr> <tr> <td>3650</td> <td>SV</td> </tr> </table>	o P t M	PV	3650	SV	<p>6. Press the SEL key. (The first digit of the lower part of the screen begins to blink.)</p> <p>7. Use the   keys to change 3650 to 100.</p>
o P t M	PV				
3650	SV				
<table border="1"> <tr> <td>100</td> <td>SV</td> </tr> </table>	100	SV	<p>8. Press the SEL key to save the change.</p>		
100	SV				
	<p>9. Press the  key to return to the PV/SV display.</p>				

3-8 CH7 SYS (System parameters)

UKY1 USER key assignment (590)

UKY2 USER key assignment (591)

UKY3 USER key assignment (592)

[Description]

- Allows you to assign functions to each USER key.

UKY1	USER key
UKY2	USER key + v key
UKY3	USER key + ^ key

Select a function from the table below.





Setpoint *1	Function
0	No function
1	Switchover between STBY ON/OFF
2	Switchover between Auto/Manual
3	Switchover between Local/Remote.
5	Starts AT (standard)
6	Starts AT (low PV)
8	Ramp SV RUN/HOLD switchover
9	Ramp soak RUN/OFF switchover
10	Ramp soak RUN/HOLD switchover
12	Latch release (all)
13	Latch release (ALM1)
14	Latch release (ALM2)
15	Latch release (ALM3)
16	Latch release (ALM4)
17	Latch release (ALM5)
19	Start timer (ALM1)
20	Start timer (ALM2)
21	Start timer (ALM3)
22	Start timer (ALM4)
23	Start timer (ALM5)
25	SVNo. + 1 (send) *2
26	PIDNo. + 1 (send) *2
28	Ramp soak pattern No. + 1 (send) *3
29	(SV No.,PID No.) + 1 (send) *2

Note *1: Enter the numbers only listed in this table.

*2: When the number has reached the maximum, it returns to zero.

*3: When the number has reached the maximum, it returns to the minimum number.

[Setting example] Assigning the switchover between STBY ON/OFF to the USER key _____

Display	Operating procedure				
<table border="1"> <tr> <td data-bbox="108 286 331 353">2 4 5</td> <td data-bbox="338 286 383 353">PV</td> </tr> <tr> <td data-bbox="108 353 331 421">250</td> <td data-bbox="338 353 383 421">SV</td> </tr> </table>	2 4 5	PV	250	SV	<p>1. Check that the PV/SV display is shown.</p>
2 4 5	PV				
250	SV				
<table border="1"> <tr> <td data-bbox="108 501 331 568">CH 7</td> <td data-bbox="338 501 383 568">PV</td> </tr> <tr> <td data-bbox="108 568 331 636">SYS</td> <td data-bbox="338 568 383 636">SV</td> </tr> </table>	CH 7	PV	SYS	SV	<p>2. Press and hold the SEL key to display CH1 (PID parameters).</p> <p>3. Use the  key to access CH7 (System parameters).</p>
CH 7	PV				
SYS	SV				
<table border="1"> <tr> <td data-bbox="108 716 331 784">UKY 1</td> <td data-bbox="338 716 383 784">PV</td> </tr> <tr> <td data-bbox="108 784 331 851">0</td> <td data-bbox="338 784 383 851">SV</td> </tr> </table>	UKY 1	PV	0	SV	<p>4. Press the SEL key to enter CH7 (System parameters). UKY1 (USER key assignment) is displayed.</p> <p>5. Press the SEL key. (The first digit of the lower part of the screen begins to blink.)</p>
UKY 1	PV				
0	SV				
<table border="1"> <tr> <td data-bbox="108 869 331 931">1</td> <td data-bbox="338 869 383 931">SV</td> </tr> </table>	1	SV	<p>6. Use the   keys to change 0 to 1.</p>		
1	SV				
	<p>7. Press the SEL key to save the change.</p> <p>8. Press the  key to return to the PV/SV display.</p>				

di1 to di5 DI function select (593 to 597)

[Description]

You can allocate one of the following functions to each of DI1 to DI5. These functions are activated by external DI signals.

No.	Function	Action	ON	OFF	Criteria
0	No function	No action	-	-	-
1	Standby ON/OFF switchover	Switches between Standby ON/OFF.	Standby	Cancels Standby	Edge
2	Auto/manual switchover	Switches the control output action between auto/manual.	Manual	Auto	Edge
3	Local/remote switchover	Switches SV between local/remote.	Remote	Local	Edge
4	Setting prohibited	-	-	-	-
5	Auto tuning (standard) start	Runs standard auto-tuning.	Start	Stop	Edge
6	Auto tuning (low-PV) start	Runs low-PV type auto-tuning.	Start	Stop	Edge
7	Ramp SV ON/OFF	Enables or disables ramp SV.	Disable	Enable	Edge
8	Ramp SV hold	Switches between ramp SV hold and hold cancel.	Hold	Hold cancel	Edge
9	Ramp soak RUN/OFF	Switches between ramp soak RUN/OFF.	RUN	OFF	Edge
10	Ramp soak RUN/HOLD	Switches between ramp soak RUN/HOLD.	RUN	HOLD	Edge
11	Setting prohibited	-	-	-	-
12	Unlatch (all)	Cancels all the alarm latches.	Unlatch	-	Edge
13	Unlatch (alarm 1)	Unlatches the alarm 1.			
14	Unlatch (alarm 2)	Unlatches the alarm 2.			
15	Unlatch (alarm 3)	Unlatches the alarm 3.			
16	Unlatch (alarm 4)	Unlatches the alarm 4.			
17	Unlatch (alarm 5)	Unlatches the alarm 5.			
18	Setting prohibited	-	-	-	-
19	Timer (alarm 1)	Runs the timer for the alarm 1.	Timer ON	Timer OFF	Level
20	Timer (alarm 2)	Runs the timer for the alarm 2.			
21	Timer (alarm 3)	Runs the timer for the alarm 3.			
22	Timer (alarm 4)	Runs the timer for the alarm 4.			
23	Timer (alarm 5)	Runs the timer for the alarm 5.			
24	Setting prohibited	-	-	-	-
25	SV No. + 1	Increases the SV number by 1.	+ 1	-	Level
26	SV No. + 2	Increases the SV number by 2.	+ 2	-	Level
27	SV No. + 4	Increases the SV number by 4.	+ 4	-	Level
28	PID No. + 1	Increases the PID number by 1.	+ 1	-	Level
29	PID No. + 2	Increases the PID number by 2.	+ 2	-	Level
30	PID No. + 4	Increases the PID number by 4.	+ 4	-	Level
31	SV No. + 1, PID No. + 1	Increases both the SV number and PID number by 1.	+ 1	-	Level
32	SV No. + 2, PID No. + 2	Increases both the SV number and PID number by 2.	+ 2	-	Level
33	SV No. + 4, PID No. + 4	Increases both the SV number and PID number by 4.	+ 4	-	Level
34	Ramp soak OFF	Stops ramp soak operation.	OFF	-	Edge
35	Ramp soak RUN	Runs ramp soak.	RUN	-	Edge
36	Ramp soak HOLD	Holds ramp soak.	HOLD	-	Edge
37	Pattern No. + 1	Increases the pattern number by 1.	+ 1	-	Level
38	Pattern No. + 2	Increases the pattern number by 2.	+ 2	-	Level

No.	Function	Action	ON	OFF	Criteria
39	Pattern No. + 4	Increases the pattern number by 4.	+ 4	-	Level
40	Pattern No. + 8	Increases the pattern number by 8.	+ 8	-	Level
41	DI soft start	Starts DI soft start.	Start	-	Edge
42	Setting prohibited	-	-	-	-
43	Delay start (alarm 1)	Enables delay start with the delay time = dLY1.	Delay start enabled		-
44	Delay start (alarm 2)	Enables delay start with the delay time = dLY2.	Delay start enabled		-
45	Delay start (alarm 3)	Enables delay start with the delay time = dLY3.	Delay start enabled		-
46	Delay start (alarm 4)	Enables delay start with the delay time = dLY4.	Delay start enabled		-
47	Delay start (alarm 5)	Enables delay start with the delay time = dLY5.	Delay start enabled		-
48	Setting prohibited	-	-	-	-

Note:

When the DI function for edge operation is selected please note the following:

- When the power to the unit is turned on with DI turned on, the ON edge is accepted and the selected function is performed.
- When the power to the unit is turned on with DI turned off, the OFF edge is rejected and the selected function is not performed.

[Setting example] Setting the DI1 function to “standby ON/OFF switchover”

Display	Operating procedure				
<table border="1"> <tr> <td>2 4 5</td> <td>PV</td> </tr> <tr> <td>250</td> <td>SV</td> </tr> </table>	2 4 5	PV	250	SV	1. Check that the PV/SV display is shown.
2 4 5	PV				
250	SV				
<table border="1"> <tr> <td>CH 7</td> <td>PV</td> </tr> <tr> <td>SYS</td> <td>SV</td> </tr> </table>	CH 7	PV	SYS	SV	2. Press and hold the SEL key to display CH1 (PID parameters).
CH 7	PV				
SYS	SV				
<table border="1"> <tr> <td>UKY 1</td> <td>PV</td> </tr> <tr> <td>0</td> <td>SV</td> </tr> </table>	UKY 1	PV	0	SV	3. Use the \odot key to access CH7 (System parameters).
UKY 1	PV				
0	SV				
<table border="1"> <tr> <td>UKY 1</td> <td>PV</td> </tr> <tr> <td>0</td> <td>SV</td> </tr> </table>	UKY 1	PV	0	SV	4. Press the SEL key to enter CH7 (System parameters). UKY1 (User key) is displayed.
UKY 1	PV				
0	SV				
<table border="1"> <tr> <td>d i 1</td> <td>PV</td> </tr> <tr> <td>0</td> <td>SV</td> </tr> </table>	d i 1	PV	0	SV	5. Use the \wedge \odot keys to change “UKY1” to “di1”.
d i 1	PV				
0	SV				
<table border="1"> <tr> <td>1</td> <td>SV</td> </tr> </table>	1	SV	6. Press the SEL key. (The first digit of the lower part of the screen begins to blink.)		
1	SV				
<table border="1"> <tr> <td>1</td> <td>SV</td> </tr> </table>	1	SV	7. Use the \wedge \odot keys to change “0” to “1”.		
1	SV				
	8. Press the SEL key to save the change.				
	9. Press the \odot key to return to the PV/SV display.				

oU1t OUT1 output type (599)

oU2t OUT2 output type (600)

do1t to **do3t** Output type (DO1 to DO3) (601 to 603)

LoU1 LED indicator assignment (OUT1) (607)

LoU2 LED indicator assignment (OUT2) (608)

LEV1 to **LEV6** LED indicator assignment (EV1 to EV6) (609 to 614)

LStb LED indicator assignment (STBY) (615)

LMAN LED indicator assignment (MAN) (616)

[Description]

You can select what to be output from each output terminal, and what each indicator lamp means.

Select numbers from the table below.

OUT (relay/SSR)	OUT (current voltage)	DO	Indicator lamps Set value	Category	Function
oU1T, oU2T	oU1T, oU2T	do1T, do2T, do3T, do4T, do5T	LoU1, LoU2, LEV 1 to 6, LSTb, LMAN		
0	0	0	0		None
1	1	1	1	Control output	MV1 (heating)
2	2	2	2		MV2 (cooling)
3	-	3	3	Alarm output	Alarm 1
4	-	4	4		Alarm 2
5	-	5	5		Alarm 3
6	-	6	6		Alarm 4
7	-	7	7		Alarm 5
10	-	10	10	Status output	During auto-tuning startup
11	-	11	11		Normal
12	-	12	12		Standby
13	-	13	13		During manual mode
15	-	15	15		During ramp SV
16	-	16	16		System error
20	-	20	20	Ramp soak Event output	OFF
21	-	21	21		RUN
22	-	22	22		HOLD
23	-	23	23		GS (Guaranty soak)
24	-	24	24		END
30	-	30	30	simple calculation result	Simple calculation result wafer 1 output 1
31	-	31	31		Simple calculation result wafer 1 output 2
32	-	32	32		Simple calculation result wafer 1 output 3
33	-	33	33		Simple calculation result wafer 1 output 4
66	-	66	66		Simple calculation result wafer 10 output 1
67	-	67	67		Simple calculation result wafer 10 output 2
68	-	68	68		Simple calculation result wafer 10 output 3
69	-	69	69		Simple calculation result wafer 10 output 4
170	-	170	170	Ramp soak Time signal	Time signal (step 1 ramp)
171	-	171	171		Time signal (step 1 soak)
172	-	172	172		Time signal (step 2 ramp)
173	-	173	173		Time signal (step 2 soak)
294	-	294	294		Time signal (step 63 ramp)
295	-	295	295		Time signal (step 63 soak)
296	-	296	296		Time signal (step 64 ramp)
297	-	297	297		Time signal (step 64 soak)
300	-	300	300	Ramp soak Relative time signal	Time signal (1st step ramp)
301	-	301	301		Time signal (1st step soak)
302	-	302	302		Time signal (2nd step ramp)
303	-	303	303		Time signal (2nd step soak)
424	-	424	424		Time signal (63rd step ramp)
425	-	425	425		Time signal (63rd step soak)
426	-	426	426		Time signal (64th step ramp)
427	-	427	427		Time signal (64th step soak)

Notes: • Enter the numbers only listed in this table.

- Use only 0, 1, or 2 for current and voltage output.
- When you select control output for an indicator, the indicator blinks at the intervals of "tC1" and "tC2".

[Setting example] Setting MV1 to be output from OUT1 , alarm output 1 from DO1, alarm output 1 from OUT1 indicator _____

Display	Operating procedure				
<table border="1"> <tr> <td>2 4 5</td> <td>PV</td> </tr> <tr> <td>250</td> <td>SV</td> </tr> </table>	2 4 5	PV	250	SV	<p>1. Check that the PV/SV display is shown.</p>
2 4 5	PV				
250	SV				
<table border="1"> <tr> <td>CH 7</td> <td>PV</td> </tr> <tr> <td>SYS</td> <td>SV</td> </tr> </table>	CH 7	PV	SYS	SV	<p>2. Press and hold the SEL key to display CH1 (PID parameters). 3. Use the \odot key to access CH7 (System parameters).</p>
CH 7	PV				
SYS	SV				
<table border="1"> <tr> <td>UKY 1</td> <td>PV</td> </tr> <tr> <td>0</td> <td>SV</td> </tr> </table>	UKY 1	PV	0	SV	<p>4. Press the SEL key to enter CH7 (System parameters). UKY1 (USER key assignment) is displayed.</p>
UKY 1	PV				
0	SV				
<table border="1"> <tr> <td>oU1t</td> <td>PV</td> </tr> <tr> <td>0</td> <td>SV</td> </tr> </table>	oU1t	PV	0	SV	<p>5. Use the \wedge \odot keys to change UKY1 to oU1t. 6. Press the SEL key. (The first digit of the lower part of the screen begins to blink.)</p>
oU1t	PV				
0	SV				
<table border="1"> <tr> <td>1</td> <td>SV</td> </tr> </table>	1	SV	<p>7. Use the \wedge \odot keys to change 0 to 1. 8. Press the SEL key to save the change.</p>		
1	SV				
<table border="1"> <tr> <td>do1t</td> <td>PV</td> </tr> <tr> <td>0</td> <td>SV</td> </tr> </table>	do1t	PV	0	SV	<p>9. Use the \wedge \odot keys to change oU1t to do1t. 10. Press the SEL key. (The first digit of the lower part of the screen begins to blink.)</p>
do1t	PV				
0	SV				
<table border="1"> <tr> <td>3</td> <td>SV</td> </tr> </table>	3	SV	<p>11. Use the \wedge \odot keys to change 0 to 3. 12. Press the SEL key to save the change.</p>		
3	SV				
<table border="1"> <tr> <td>LoU1</td> <td>PV</td> </tr> <tr> <td>0</td> <td>SV</td> </tr> </table>	LoU1	PV	0	SV	<p>13. Use the \wedge \odot keys to change do1t to LoU1. 14. Press the SEL key. (The first digit of the lower part of the screen begins to blink.)</p>
LoU1	PV				
0	SV				
<table border="1"> <tr> <td>3</td> <td>SV</td> </tr> </table>	3	SV	<p>15. Use the \wedge \odot keys to change 0 to 3. 16. Press the SEL key to save the change.</p>		
3	SV				
	<p>17. Press the \odot key to return to the PV/SV display.</p>				

[RMP] Ramp SV ON/OFF (617)

[RMPL] Ramp SV-decline (618)

[RMPH] Ramp SV-incline (619)

[RMPU] Ramp SV-slope time unit (620)

[Description] _____

This function changes a SV to the new value at the preset ramp rate.

SV changes smoothly, not stepwise. Incline and decline rates can be set independently.

- Setting range

Ramp SV-incline/decline: 0% to 100% FS/°C

Ramp SV-slope time unit: hoUr (slope temperature/hour), Min (slope temperature/min)

Operation is as follows for changing SV.

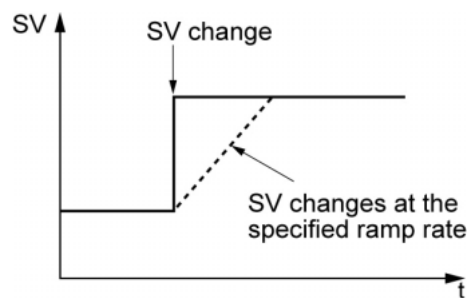

[Setting example] Setting the ramp SV incline to 10°C/min, and decline to 5°C/min

Display	Operating procedure				
<table border="1"> <tr> <td>2 4 5</td> <td>PV</td> </tr> <tr> <td>250</td> <td>SV</td> </tr> </table>	2 4 5	PV	250	SV	<p>1. Check that the PV/SV display is shown.</p>
2 4 5	PV				
250	SV				
<table border="1"> <tr> <td>CH 7</td> <td>PV</td> </tr> <tr> <td>SYS</td> <td>SV</td> </tr> </table>	CH 7	PV	SYS	SV	<p>2. Press and hold the SEL key to display CH1 (PID parameters).</p> <p>3. Use the \odot key to access CH7 (System parameters).</p>
CH 7	PV				
SYS	SV				
<table border="1"> <tr> <td>UKY 1</td> <td>PV</td> </tr> <tr> <td>0</td> <td>SV</td> </tr> </table>	UKY 1	PV	0	SV	<p>4. Press the SEL key to enter CH7 (System parameters). UKY1 (USER key assignment) is displayed.</p>
UKY 1	PV				
0	SV				
<table border="1"> <tr> <td>RMP</td> <td>PV</td> </tr> <tr> <td>oN</td> <td>SV</td> </tr> </table>	RMP	PV	oN	SV	<p>5. Use the \wedge \odot keys to change UKY1 to RMP.</p> <p>6. Press the SEL key. (The first digit of the lower part of the screen begins to blink.)</p>
RMP	PV				
oN	SV				
<table border="1"> <tr> <td>RMP L</td> <td>PV</td> </tr> <tr> <td>0</td> <td>SV</td> </tr> </table>	RMP L	PV	0	SV	<p>7. Press the SEL key to save the change.</p> <p>8. Use the \wedge \odot keys to change RMP to RMPL.</p>
RMP L	PV				
0	SV				
<table border="1"> <tr> <td>5</td> <td>SV</td> </tr> </table>	5	SV	<p>9. Press the SEL key. (The first digit of the lower part of the screen begins to blink.)</p> <p>10. Use the \wedge \odot keys to change 0 to 5.</p>		
5	SV				
<table border="1"> <tr> <td>RMP H</td> <td>PV</td> </tr> <tr> <td>0</td> <td>SV</td> </tr> </table>	RMP H	PV	0	SV	<p>11. Press the SEL key to save the change.</p> <p>12. Use the \wedge \odot keys to change RMPL to RMPH.</p>
RMP H	PV				
0	SV				
<table border="1"> <tr> <td>10</td> <td>SV</td> </tr> </table>	10	SV	<p>13. Press the SEL key. (The first digit of the lower part of the screen begins to blink.)</p> <p>14. Use the \wedge \odot keys to change 0 to 10.</p>		
10	SV				
<table border="1"> <tr> <td>RMP U</td> <td>PV</td> </tr> <tr> <td>HoUR</td> <td>SV</td> </tr> </table>	RMP U	PV	HoUR	SV	<p>15. Press the SEL key to save the change.</p> <p>16. Use the \wedge \odot keys to change RMPH to RMPU.</p>
RMP U	PV				
HoUR	SV				
<table border="1"> <tr> <td>Min</td> <td>SV</td> </tr> </table>	Min	SV	<p>17. Press the SEL key. (The first digit of the lower part of the screen begins to blink.)</p> <p>18. Use the \wedge \odot keys to change HoUR to MiN.</p>		
Min	SV				
	<p>19. Press the SEL key to save the change.</p> <p>20. Press the \odot key to return to the PV/SV display.</p>				

SVt Ramp SV display mode (621)

[Description]

Selects which to display between the SV during ramp operations or the SV goal value.

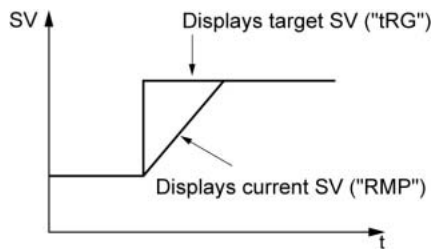

[Setting example] Setting the target SV to be displayed

Display	Operating procedure				
<table border="1"> <tr> <td>2 4 5</td> <td>PV</td> </tr> <tr> <td>250</td> <td>SV</td> </tr> </table>	2 4 5	PV	250	SV	1. Check that the PV/SV display is shown.
2 4 5	PV				
250	SV				
<table border="1"> <tr> <td>CH 7</td> <td>PV</td> </tr> <tr> <td>SYS</td> <td>SV</td> </tr> </table>	CH 7	PV	SYS	SV	2. Press and hold the SEL key to display CH1 (PID parameters). 3. Use the \odot key to access CH7 (System parameters).
CH 7	PV				
SYS	SV				
<table border="1"> <tr> <td>UKY 1</td> <td>PV</td> </tr> <tr> <td>0</td> <td>SV</td> </tr> </table>	UKY 1	PV	0	SV	4. Press the SEL key to enter CH7 (System parameters). UKY1 (USER key assignment) is displayed.
UKY 1	PV				
0	SV				
<table border="1"> <tr> <td>SV t</td> <td>PV</td> </tr> <tr> <td>RMP</td> <td>SV</td> </tr> </table>	SV t	PV	RMP	SV	5. Use the \wedge \odot keys to change UKY1 to SVt. 6. Press the SEL key. (The first digit of the lower part of the screen begins to blink.)
SV t	PV				
RMP	SV				
<table border="1"> <tr> <td>tRG</td> <td>SV</td> </tr> </table>	tRG	SV	7. Use the \wedge \odot keys to change RMP to tRG. 8. Press the SEL key to save the change. 9. Press the \ominus key to return to the PV/SV display.		
tRG	SV				

CtRL Control method (622)

[Description]

This controller has six temperature control functions. Select the best control method for your application.

- Temperature control functions

ON/OFF (2-position) control	Switches output control ON/OFF according to the SV/PV magnitude relationship. Control systems can be built from simple elements such as SSR. This is appropriate for situations which require a low degree of accuracy.
PID control	PID calculation and controls proceed according to the previously set PID parameters. PID parameters can be set manually or through auto-tuning (AT). It is the most basic control in this equipment.
Fuzzy control	Reduces the amount of overshoot during control. It is effective when you want to suppress overshoot while changing SV, even during processes where it may take a long time to reach the target value.
Self tuning control	Adds controls while automatically calculating PID to meet the control target or changing SV. It is effective when the control conditions change frequently.
PID2 control	Suppresses the amount of overshoot during control for processes that turn the control target off and then on again. It is effective when the control target turns on and off while power flows continuously to the temperature controller.
2-degree-of freedom PID control	The function is used to suppress overshoot generated in PID control. The 2 degrees of freedom PID system of this instrument adopts set value (SV) filter method, which is effective at suppressing overshoot at the time of setting change or power ON.

(1) ON/OFF (2-position) control (oNoF)

When you set the control method (CtRL) to oNoF, the device uses ON/OFF control.

In ON/OFF control, the controller switches the control output between ON (100%) and OFF (0%) according to the SV/PV magnitude relationship. You can set the output hysteresis in the control parameters (CH2 PLT)

Reverse Operation (Heating)

Method used to control the electrical heating furnace. Set the HYS to an appropriate value according to the control target.

Parameter	Set value
CtRL	oNoF
REV	RV_ _
HYS	optional (default: 1°C)

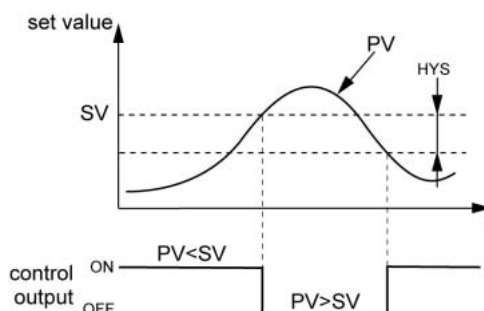

Normal operation (Cooling)

Method used to control the cooling machine.

Parameter	Set value
CtRL	oNoF
REV	No__
HYS	optional (default: 1°C)

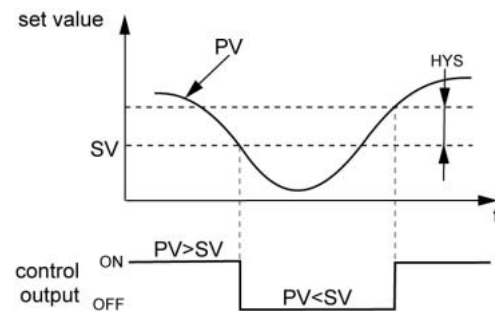

- During ON/OFF control, the P, I and D settings do not affect control.
- In the manual operation during ON/OFF control, MV displayed by pressing UP key is 100%, and MV displayed by pressing DOWN key is 0%.
- If the hysteresis width is narrow, and PV and SV are nearly equal, the output may frequently switch on and off. Note that it may affect the life of the contact.

(2) PID control (Pid)

Pid control starts when the parameter "CtRL" is "Pid". Pid control calculates Pid and outputs the result according to the set values of the parameters "P", "i", "d", and "AR". (-5 to 105%)

Each parameter can be set either by manually tuning the values or by running auto-tuning (AT) to automatically set the values.

Related parameters: Auto-tuning (page 33)

(3) Fuzzy control (FUZY)

This control minimizes the overshoot compared to normal PID. Fuzzy control can only be used after auto-tuning has been activated and a PID set.

Related parameters: Auto-tuning (page 33)

(4) Self tuning control (SELF)

Adds controls while automatically calculating PID to meet the control target or changing SV. Self-tuning is especially effective for situations when a high level of control is not needed, but auto-tuning cannot be run due to frequent changes in the control target conditions. If a high degree of control is required, select PID control, fuzzy control or PID2 control.

Conditions where self-tuning can be used

- When temperature rises right after the power is turned on
- When temperature rises after SV change (or when the controller judges it necessary)
- When the controller judges it necessary because the control has become unstable

Conditions where self-tuning cannot be used

- During standby
- During ON/OFF (2 setting) control
- During auto-tuning
- During ramp/soak operation
- When input error occurs
- When dual output is used
- When any of the P, I, D, or Ar parameters have been manually configured

- During manual mode
- During soft start

Conditions where self-tuning is halted

- When SV is changed (including when SV is changed by the ramp/soak function, remote SV function, or ramp SV.)
- When self-tuning has not finished after running for nine or more hours
- The equipment will not be tuned properly if power is turned on first.
- When redoing the self-tuning settings, first set the control method to PID ("Pid"), and then set back to self-tuning.

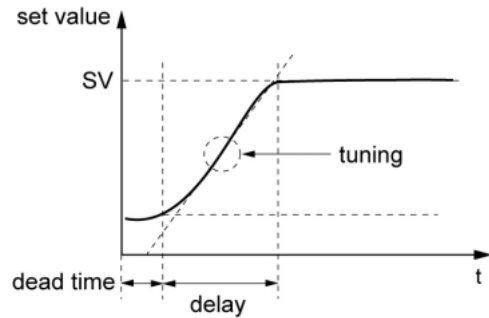

(5) PID2 control (Pid2)

This type of control reduces overshoot during control for processes that turn the control target off and then on again. The algorithm used prevents over integration of the PID calculations even while the control loop is still open. PID2 control can only be used after auto-tuning has been activated and a PID set.

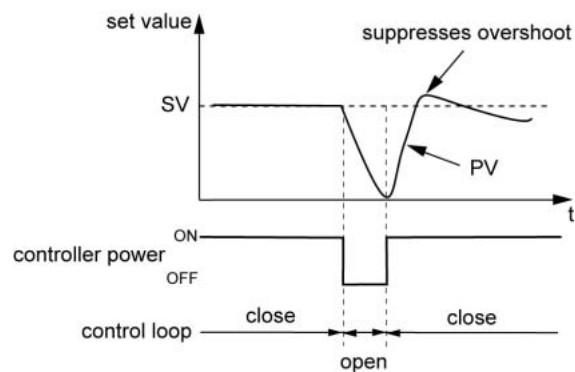

(6) 2-degrees-of-freedom PID (2 FRE)

The 2 degrees of freedom PID system of this instrument adopts set value (SV) filter method, which is effective in suppressing overshoot at the time of setting change or power ON.

The controllability of 2-degrees-of-freedom PID control changes according to the settings of coefficient α and β .

If you set coefficient α to 100.0% and β to 0.0%, normal PID control is operated.

Adjust α and β as follows.







- 1) set $\alpha = 40.0\%$, $\beta = 100.0\%$ (Factory default setting)
- 2) Perform control and check responsibility (overshoot volume).

If overshoot is not reduced, adjust α and β as follows.

Generally, ALPA (α) does not require adjusting. Therefore, it is recommended to use the instrument with ALPA (α) set to 40.0%.

Result of control	Coefficient β	Coefficient α
Large overshoot	Increase β by 20%	Decrease α by 10%
Small overshoot	Decrease β by 20%	Increase α by 10%

[Setting example] Setting the control method to ON/OFF control

Display	Operating procedure				
<table border="1"> <tr> <td data-bbox="209 248 443 349">2 4 5</td> <td data-bbox="443 248 512 349">PV</td> </tr> <tr> <td data-bbox="209 349 443 416">250</td> <td data-bbox="443 349 512 416">SV</td> </tr> </table>	2 4 5	PV	250	SV	<p>1. Check that the PV/SV display is shown.</p>
2 4 5	PV				
250	SV				
<table border="1"> <tr> <td data-bbox="209 416 443 551">CH 7</td> <td data-bbox="443 416 512 551">PV</td> </tr> <tr> <td data-bbox="209 551 443 622">SYS</td> <td data-bbox="443 551 512 622">SV</td> </tr> </table>	CH 7	PV	SYS	SV	<p>2. Press and hold the SEL key to display CH1 (PID parameters).</p> <p>3. Use the  key to access CH7 (System parameters).</p>
CH 7	PV				
SYS	SV				
<table border="1"> <tr> <td data-bbox="209 622 443 757">UKY 1</td> <td data-bbox="443 622 512 757">PV</td> </tr> <tr> <td data-bbox="209 757 443 828">0</td> <td data-bbox="443 757 512 828">SV</td> </tr> </table>	UKY 1	PV	0	SV	<p>4. Press the SEL key to enter CH7 (System parameters). UKY1 (USER key assignment) is displayed.</p>
UKY 1	PV				
0	SV				
<table border="1"> <tr> <td data-bbox="209 828 443 963">C t R L</td> <td data-bbox="443 828 512 963">PV</td> </tr> <tr> <td data-bbox="209 963 443 1034">Pid</td> <td data-bbox="443 963 512 1034">SV</td> </tr> </table>	C t R L	PV	Pid	SV	<p>5. Use the   keys to change UKY1 to CtRL.</p> <p>6. Press the SEL key. (The first digit of the lower part of the screen begins to blink.)</p>
C t R L	PV				
Pid	SV				
<table border="1"> <tr> <td data-bbox="209 1034 443 1137">oNoF</td> <td data-bbox="443 1034 512 1137">SV</td> </tr> </table>	oNoF	SV	<p>7. Use the   keys to change Pid to oNoF.</p> <p>8. Press the SEL key to save the change.</p>		
oNoF	SV				
	<p>9. Press the  key to return to the PV/SV display.</p>				

PRCS Control target (623)

[Description]

This controller has three valve control functions.

Select the best function for the current application.

●Valve Control Functions

Servo control 1	Controls the motorized valve opening through [OPEN], [CLOSE] connection points.
Servo control 2	Controls the motorized valve opening through [OPEN], [CLOSE] connection points. The opening of the valve can be displayed by reading the open position signal from the motorized valve, but it cannot be used in control output calculations.
Position feedback	Inserts controls by adding the opening signal from the motorized valve to the control calculation results. Controls the motorized valve opening through [OPEN], [CLOSE] connection points. This control can be used when there are opening signals coming from the motorized valve.

(1) Servo Control 1/Servo Control 2

Adjusts and controls the motorized valve opening through [OPEN], [CLOSE] connection points.

In manual mode, press the key to switch between [OPEN] and [CLOSE].

Servo control 1 and servo control 2 have the following differences.

- Servo Control 1: No valve opening display
- Servo Control 2: Has valve opening display



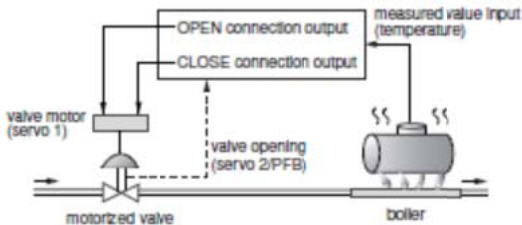



Neither control can be used to control the valve opening itself.



Note:

- Servo control 1 can control the motorized valve even without a valve opening signal from the motorized valve. (The motorized valve opening is estimated from a calculation of the valve stroke time.)
- Servo control 2 adds the valve opening signal display function to servo control 1. Valve position display can be used to automatically or manually adjust zero/span.
- Zero/span adjustment is necessary for using valve position indication.

[Setting example] Changing the control target from servo1 to servo2







Display	Operating procedure				
<table border="1" style="width: 100%; border-collapse: collapse;"> <tr> <td style="text-align: center; padding: 5px;">2 4 5</td> <td style="text-align: center; padding: 5px;">PV</td> </tr> <tr> <td style="text-align: center; padding: 5px;">250</td> <td style="text-align: center; padding: 5px;">SV</td> </tr> </table>	2 4 5	PV	250	SV	<p>1. Check that the PV/SV display is shown.</p>
2 4 5	PV				
250	SV				
<table border="1" style="width: 100%; border-collapse: collapse;"> <tr> <td style="text-align: center; padding: 5px;">CH 7</td> <td style="text-align: center; padding: 5px;">PV</td> </tr> <tr> <td style="text-align: center; padding: 5px;">SYS</td> <td style="text-align: center; padding: 5px;">SV</td> </tr> </table>	CH 7	PV	SYS	SV	<p>2. Press and hold the SEL key to display CH1 (PID parameters).</p> <p>3. Use the  key to access CH7 (System parameters).</p>
CH 7	PV				
SYS	SV				
<table border="1" style="width: 100%; border-collapse: collapse;"> <tr> <td style="text-align: center; padding: 5px;">UKY 1</td> <td style="text-align: center; padding: 5px;">PV</td> </tr> <tr> <td style="text-align: center; padding: 5px;">0</td> <td style="text-align: center; padding: 5px;">SV</td> </tr> </table>	UKY 1	PV	0	SV	<p>4. Press the SEL key to enter CH7 (System parameters). UKY1 (USER key assignment) is displayed.</p>
UKY 1	PV				
0	SV				
<table border="1" style="width: 100%; border-collapse: collapse;"> <tr> <td style="text-align: center; padding: 5px;">PRCS</td> <td style="text-align: center; padding: 5px;">PV</td> </tr> <tr> <td style="text-align: center; padding: 5px;">SRV1</td> <td style="text-align: center; padding: 5px;">SV</td> </tr> </table>	PRCS	PV	SRV1	SV	<p>5. Use the   keys to change “UKY1” to “PRCS”.</p> <p>6. Press the SEL key. (The first digit of the lower part of the screen begins to blink.)</p>
PRCS	PV				
SRV1	SV				
<table border="1" style="width: 100%; border-collapse: collapse;"> <tr> <td style="text-align: center; padding: 5px;">SRV2</td> <td style="text-align: center; padding: 5px;">SV</td> </tr> </table>	SRV2	SV	<p>7. Use the   keys to change “SRV1” to “SRV2”.</p> <p>8. Press the SEL key to save the change.</p>		
SRV2	SV				
	<p>9. Press the  key to return to the PV/SV display.</p>				

(2) Position Feedback Control (PFB control)

Position feedback control (PFB) is used to control the position of the motorized valve based on the position signal transmitted from the motorized valve. During manual mode, the controller displays the valve position signal as MV.

Because it is based on the actual valve position, PFB control is more precise than the servo 1/servo 2 control.

[Setting example] Changing to PFB control

Display	Operating procedure				
<table border="1"> <tr> <td>2 4 5</td> <td>PV</td> </tr> <tr> <td>250</td> <td>SV</td> </tr> </table>	2 4 5	PV	250	SV	<p>1. Check that the PV/SV display is shown.</p>
2 4 5	PV				
250	SV				
<table border="1"> <tr> <td>CH 7</td> <td>PV</td> </tr> <tr> <td>SYS</td> <td>SV</td> </tr> </table>	CH 7	PV	SYS	SV	<p>2. Press and hold the SEL key to display CH1 (PID parameters). 3. Use the  key to access CH7 (System parameters).</p>
CH 7	PV				
SYS	SV				
<table border="1"> <tr> <td>UKY 1</td> <td>PV</td> </tr> <tr> <td>0</td> <td>SV</td> </tr> </table>	UKY 1	PV	0	SV	<p>4. Press the SEL key to enter CH7 (System parameters). UKY1 (USER key assignment) is displayed.</p>
UKY 1	PV				
0	SV				
<table border="1"> <tr> <td>PRCS</td> <td>PV</td> </tr> <tr> <td>SRV1</td> <td>SV</td> </tr> </table>	PRCS	PV	SRV1	SV	<p>5. Use the   keys to change “UKY1” to “PRCS”. 6. Press the SEL key. (The first digit of the lower part of the screen begins to blink.)</p>
PRCS	PV				
SRV1	SV				
<table border="1"> <tr> <td>PFb</td> <td>SV</td> </tr> </table>	PFb	SV	<p>7. Use the   keys to change “SRV1” to “PFb”. 8. Press the SEL key to save the change.</p>		
PFb	SV				
	<p>9. Press the  key to return to the PV/SV display.</p>				

oNoF ONOFF Hysteresis (624)

[Description]

Selects the hysteresis operation during two state action.

OFF: Performs two state action at $SV+HYS/2$ and $SV-HYS/2$.

ON: Performs two state action at SV , $SV+HYS$ and SV , $SVHYS$.

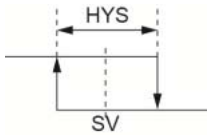
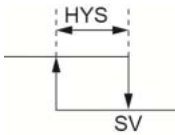
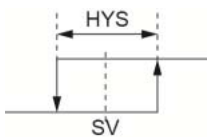
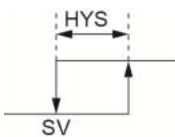
	oNoF: OFF	oNoF: ON
Reverse		
Normal Operation		

[Setting example] Setting the start mode to control output manual mode

Display	Operating procedure				
<table border="1" style="width: 100%;"> <tr> <td style="text-align: center;">2 4 5</td> <td style="text-align: right; font-size: small;">PV</td> </tr> <tr> <td style="text-align: center;">250</td> <td style="text-align: right; font-size: small;">SV</td> </tr> </table>	2 4 5	PV	250	SV	1. Check that the PV/SV display is shown.
2 4 5	PV				
250	SV				
<table border="1" style="width: 100%;"> <tr> <td style="text-align: center;">CH 7</td> <td style="text-align: right; font-size: small;">PV</td> </tr> <tr> <td style="text-align: center;">SYS</td> <td style="text-align: right; font-size: small;">SV</td> </tr> </table>	CH 7	PV	SYS	SV	2. Press and hold the SEL key to display CH1 (PID parameters).
CH 7	PV				
SYS	SV				
<table border="1" style="width: 100%;"> <tr> <td style="text-align: center;">UKY 1</td> <td style="text-align: right; font-size: small;">PV</td> </tr> <tr> <td style="text-align: center;">0</td> <td style="text-align: right; font-size: small;">SV</td> </tr> </table>	UKY 1	PV	0	SV	3. Use the \odot key to access CH7 (System parameters).
UKY 1	PV				
0	SV				
<table border="1" style="width: 100%;"> <tr> <td style="text-align: center;">oNoF</td> <td style="text-align: right; font-size: small;">PV</td> </tr> <tr> <td style="text-align: center;">oFF</td> <td style="text-align: right; font-size: small;">SV</td> </tr> </table>	oNoF	PV	oFF	SV	4. Press the SEL key to enter CH7 (System parameters). UKY1 (USER key assignment) is displayed.
oNoF	PV				
oFF	SV				
<table border="1" style="width: 100%;"> <tr> <td style="text-align: center;">oN</td> <td style="text-align: right; font-size: small;">SV</td> </tr> </table>	oN	SV	5. Use the \wedge \vee keys to change "UKY1" to "oNoF".		
oN	SV				
	6. Press the SEL key. (The first digit of the lower part of the screen begins to blink.)				
	7. Use the \wedge \vee keys to change "oFF" to "oN".				
	8. Press the SEL key to save the change.				
	9. Press the \odot key to return to the PV/SV display.				

StMd Start mode (626)

[Description]

Allows you to specify the mode that the device starts up.

Select from the following four options.

- Setting range

AUto	Control output auto mode
MAN	Control output manual mode
REM	Remote SV mode
StbY	Standby Mode

[Setting example] Setting the start mode to control output manual mode

Display	Operating procedure				
<table border="1"> <tr> <td>2 4 5</td> <td>PV</td> </tr> <tr> <td>250</td> <td>SV</td> </tr> </table>	2 4 5	PV	250	SV	1. Check that the PV/SV display is shown.
2 4 5	PV				
250	SV				
<table border="1"> <tr> <td>CH 7</td> <td>PV</td> </tr> <tr> <td>SYS</td> <td>SV</td> </tr> </table>	CH 7	PV	SYS	SV	2. Press and hold the SEL key to display CH1 (PID parameters).
CH 7	PV				
SYS	SV				
<table border="1"> <tr> <td>UKY 1</td> <td>PV</td> </tr> <tr> <td>0</td> <td>SV</td> </tr> </table>	UKY 1	PV	0	SV	3. Use the \odot key to access CH7 (System parameters).
UKY 1	PV				
0	SV				
<table border="1"> <tr> <td>UKY 1</td> <td>PV</td> </tr> <tr> <td>0</td> <td>SV</td> </tr> </table>	UKY 1	PV	0	SV	4. Press the SEL key to enter CH7 (System parameters). UKY1 (USER key assignment) is displayed.
UKY 1	PV				
0	SV				
<table border="1"> <tr> <td>S t M d</td> <td>PV</td> </tr> <tr> <td>AUto</td> <td>SV</td> </tr> </table>	S t M d	PV	AUto	SV	5. Use the \wedge \vee keys to change UKY1 to StMd.
S t M d	PV				
AUto	SV				
<table border="1"> <tr> <td>MAN</td> <td>SV</td> </tr> </table>	MAN	SV	6. Press the SEL key. (The first digit of the lower part of the screen begins to blink.)		
MAN	SV				
	7. Use the \wedge \vee keys to change AUto to MAN.				
	8. Press the SEL key to save the change.				
	9. Press the \odot key to return to the PV/SV display.				

dt Control operation cycle (627)

[Description]

Allows you to set the control operation cycle.

Note:

Be sure to restart the controller after changing the setpoint.

Setting range: 0.1 to 0.9 s, 1 to 99 s

[Setting example] Setting the control operation cycle to 0.2 seconds.

Display	Operating procedure				
<table border="1"> <tr> <td data-bbox="220 611 443 678">2 4 5</td> <td data-bbox="443 611 501 678">PV</td> </tr> <tr> <td data-bbox="220 678 443 745">250</td> <td data-bbox="443 678 501 745">SV</td> </tr> </table>	2 4 5	PV	250	SV	<p>1. Check that the PV/SV display is shown.</p>
2 4 5	PV				
250	SV				
<table border="1"> <tr> <td data-bbox="220 824 443 891">CH 7</td> <td data-bbox="443 824 501 891">PV</td> </tr> <tr> <td data-bbox="220 891 443 958">SYS</td> <td data-bbox="443 891 501 958">SV</td> </tr> </table>	CH 7	PV	SYS	SV	<p>2. Press and hold the SEL key to display CH1 (PID parameters).</p> <p>3. Use the \odot key to access CH7 (System parameters).</p>
CH 7	PV				
SYS	SV				
<table border="1"> <tr> <td data-bbox="220 1048 443 1115">UKY 1</td> <td data-bbox="443 1048 501 1115">PV</td> </tr> <tr> <td data-bbox="220 1115 443 1182">0</td> <td data-bbox="443 1115 501 1182">SV</td> </tr> </table>	UKY 1	PV	0	SV	<p>4. Press the SEL key to enter CH7 (System parameters). UKY1 (USER key assignment) is displayed.</p> <p>5. Use the \wedge \odot keys to change UKY1 to dt.</p>
UKY 1	PV				
0	SV				
<table border="1"> <tr> <td data-bbox="220 1272 443 1339">d t</td> <td data-bbox="443 1272 501 1339">PV</td> </tr> <tr> <td data-bbox="220 1339 443 1406">0.1</td> <td data-bbox="443 1339 501 1406">SV</td> </tr> </table>	d t	PV	0.1	SV	<p>6. Press the SEL key. (The first digit of the lower part of the screen begins to blink.)</p> <p>7. Use the \wedge \odot keys to change 0.1 to 0.2.</p>
d t	PV				
0.1	SV				
<table border="1"> <tr> <td data-bbox="220 1429 443 1496">0.2</td> <td data-bbox="443 1429 501 1496">SV</td> </tr> </table>	0.2	SV	<p>8. Press the SEL key to save the change.</p> <p>9. Press the \ominus key to return to the PV/SV display.</p>		
0.2	SV				

PLTS PID palette switching method (628)

[Description]

This instrument is provided with 7 groups of control palettes (group of control parameters) in CH2 (PLT), in addition to control parameters in CH1 (PID). Control can be made while switching these control palettes. Select control palette switching method with PLTS parameter.

Setting range

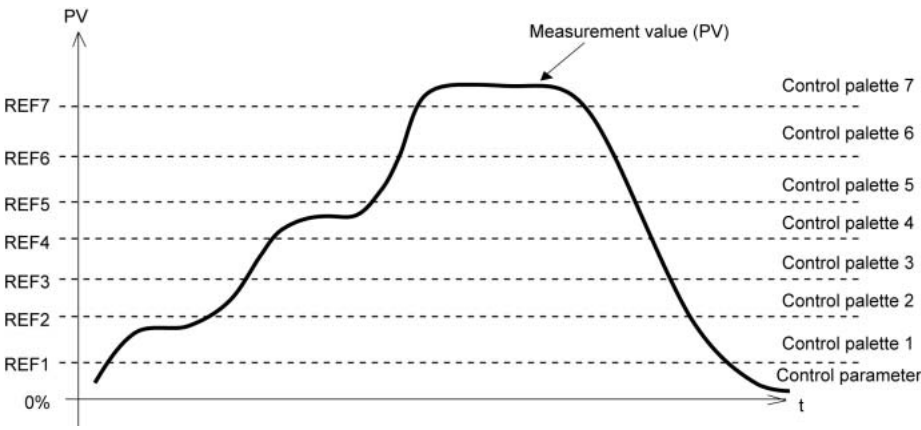
0 (PID selection)	Operation is performed with the control palette set at PLN1 (PID selection).
1 (SV selection)	Operation is performed with the control palette of the SV No. selected by SVn.
2 (Switch according to PV)	<p>Operation is performed while control palettes are automatically switched depending on the measurement value (PV), with the value set for REF1 to REF7 as threshold.</p> <p>The following figure shows the relation between the PV reference point and the control palettes.</p> 

[Setting example] Switching palettes by SV selection No. _____

Display	Operating procedure				
<table border="1"> <tr> <td data-bbox="209 248 443 349">2 4 5</td> <td data-bbox="443 248 512 349">PV</td> </tr> <tr> <td data-bbox="209 349 443 416">250</td> <td data-bbox="443 349 512 416">SV</td> </tr> </table>	2 4 5	PV	250	SV	<p>1. Check that the PV/SV display is shown.</p>
2 4 5	PV				
250	SV				
<table border="1"> <tr> <td data-bbox="209 416 443 517">CH 7</td> <td data-bbox="443 416 512 517">PV</td> </tr> <tr> <td data-bbox="209 517 443 584">SYS</td> <td data-bbox="443 517 512 584">SV</td> </tr> </table>	CH 7	PV	SYS	SV	<p>2. Press and hold the SEL key to display CH1 (PID parameters). 3. Use the \odot key to access CH7 (System parameters).</p>
CH 7	PV				
SYS	SV				
<table border="1"> <tr> <td data-bbox="209 584 443 685">UKY 1</td> <td data-bbox="443 584 512 685">PV</td> </tr> <tr> <td data-bbox="209 685 443 752">0</td> <td data-bbox="443 685 512 752">SV</td> </tr> </table>	UKY 1	PV	0	SV	<p>4. Press the SEL key to enter CH7 (System parameters). UKY1 (USER key assignment) is displayed.</p>
UKY 1	PV				
0	SV				
<table border="1"> <tr> <td data-bbox="209 752 443 853">PLtS</td> <td data-bbox="443 752 512 853">PV</td> </tr> <tr> <td data-bbox="209 853 443 920">0</td> <td data-bbox="443 853 512 920">SV</td> </tr> </table>	PLtS	PV	0	SV	<p>5. Use the \wedge \odot keys to change UKY1 to PLtS. 6. Press the SEL key. (The first digit of the lower part of the screen begins to blink.)</p>
PLtS	PV				
0	SV				
<table border="1"> <tr> <td data-bbox="209 920 443 1088">1</td> <td data-bbox="443 920 512 1088">SV</td> </tr> </table>	1	SV	<p>7. Use the \wedge \odot keys to change 0 to 1. 8. Press the SEL key to save the change.</p>		
1	SV				
	<p>9. Press the \ominus key to return to the PV/SV display.</p>				

3-9 CH8 MATH (Calculation parameters)

MATH Simple calculation ON/OFF (650)

W1MA to **MAo4** Simple calculation setting and result (651 to 730)

CoN1 to **CoNA** Constant setting (731 to 740)

[Description]

The controller can make calculations with alarm outputs or control status, and send calculation results to DO or LED.

A calculation is done by combination of function blocks called "wafer".

- You can register 10 wafers maximum.
- There are the following six kinds of calculation in the simple calculation function.

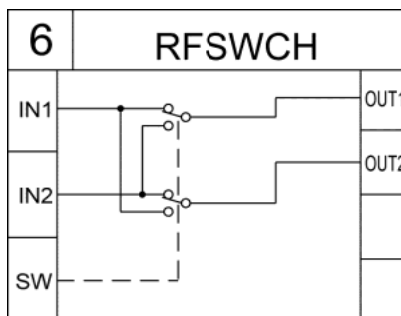
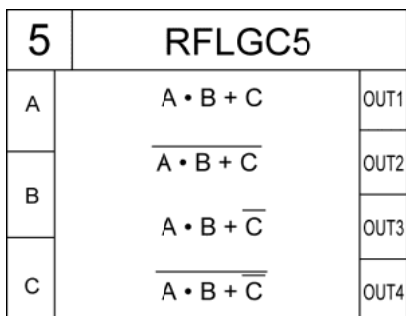
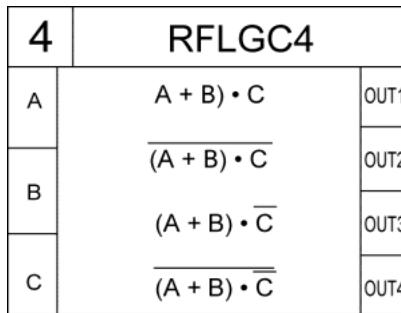
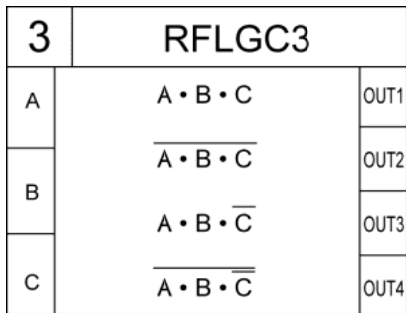
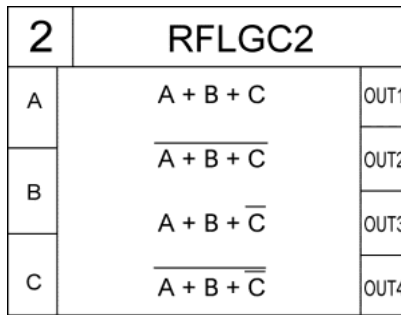
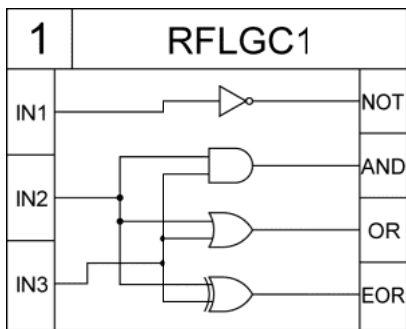

You can use the following values as inputs for calculation.

No	Category	Function
0		No input
3	Alarm output	Alarm 1
4		Alarm 2
5		Alarm 3
6		Alarm 4
7		Alarm 5
20	Ramp soak event output	Ramp soak (OFF)
21		Ramp soak (RUN)
22		Ramp soak (HOLD)
23		Guarantee soak (GS)
24		Ramp soak (END)
30	simple calculation result	Simple calculation result wafer 1 output 1
31		Simple calculation result wafer 1 output 2
32		Simple calculation result wafer 1 output 3
33		Simple calculation result wafer 1 output 4
⋮		⋮
66		Simple calculation result wafer 10 output 1
67		Simple calculation result wafer 10 output 2
68		Simple calculation result wafer 10 output 3
69		Simple calculation result wafer 10 output 4
70		Constant
⋮	⋮	
79	Constant 10	
94	Input error	Underrange
95		Overrange
98		Range setting error
103		Input error
104	Operation information	Auto/manual mode status
105		RUN/standby status
107		Auto-tuning RUN/STOP
108		Auto-tuning normal type start-up
109		Auto-tuning low-PV type start-up
170	Ramp soak time signal	Time signal (step 1 ramp)
171		Time signal (step 1 soak)
172		Time signal (step 2 ramp)
173		Time signal (step 2 soak)
⋮		⋮
294		Time signal (step 63 ramp)
295		Time signal (step 63 soak)
296		Time signal (step 64 ramp)
297		Time signal (step 64 soak)
300		Ramp soak relative time signal
301	Time signal (1st step soak)	
302	Time signal (2nd step ramp)	
303	Time signal (2nd step soak)	
⋮	⋮	
424	Time signal (63th step ramp)	
425	Time signal (63th step soak)	
426	Time signal (64th step ramp)	
427	Time signal (64th step soak)	

(1) Simple calculation ON/OFF (MAtH) (650)

Allows you to switch between ON/OFF of simple calculation.

Setting range: ON, OFF

(2) Calculation setting (wafer 1 to wafer 10) (W1MA to WAMA) (651 to 723)

Allows you to set the contents of wafer calculation.

Setting range: 1 to 6

(3) Input 1 setting (wafer 1 to wafer 10) (W1i1 to WAI1) (652 to 724)

Input 2 setting (wafer 1 to wafer 10) (W1i2 to WAI2) (653 to 725)

Input 3 setting (wafer 1 to wafer 10) (W1i3 to WAI3) (654 to 726)

Sets the input used in wafer calculation.

Setting range: 0 to 347

(4) Output 1 setting (wafer 1 to wafer 10) (W1o1 to WAO1) (655 to 727)

Output 2 setting (wafer 1 to wafer 10) (W1o2 to WAO2) (656 to 728)

Output 3 setting (wafer 1 to wafer 10) (W1o3 to WAO3) (657 to 729)

Output 4 setting (wafer 1 to wafer 10) (W1o4 to WAO4) (658 to 730)

Shows the result of wafer calculation.

(5) Constant 1 to constant 10

Allows you to set the constant used in wafer calculation.

Setting range: -32767 to 32767

[Setting example] Setting DO1 to output a logical sum of ON/OFF information of Alarm 1, 2, and 3 _____

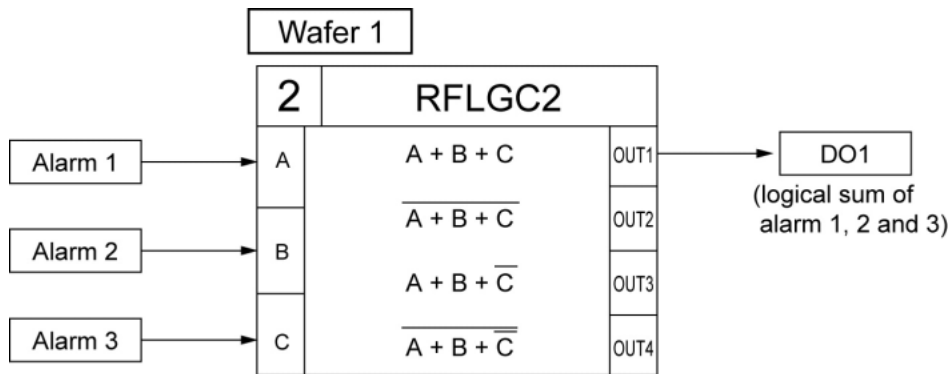

Screen No	Display	Set value	Description
650	MAtH	ON	Makes the simple calculation.
651	W1MA	2	Carries out the "logical operation wafer 2" on wafer 1.
652	W1i1	1	Enter the Alarm 1 ON/OFF information to the input 1 of wafer 1.
653	W1i2	2	Enter the Alarm 2 ON/OFF information to the input 2 of wafer 1.
653	W1i3	3	Enter the Alarm 3 ON/OFF information to the input 3 of wafer 3.
601	do1t	30	Outputs the output 1 of wafer 1 from DO1.

Display	Operating procedure				
<table border="1"> <tr> <td>245</td> <td>PV</td> </tr> <tr> <td>250</td> <td>SV</td> </tr> </table>	245	PV	250	SV	<p>1. Check that the PV/SV display is shown.</p>
245	PV				
250	SV				
<table border="1"> <tr> <td>CH 8</td> <td>PV</td> </tr> <tr> <td>MAtH</td> <td>SV</td> </tr> </table>	CH 8	PV	MAtH	SV	<p>2. Press and hold the SEL key to display CH1 (PID parameters).</p> <p>3. Use the \odot key to access CH8 (Calculation parameters).</p>
CH 8	PV				
MAtH	SV				
<table border="1"> <tr> <td>MA t H</td> <td>PV</td> </tr> <tr> <td>oFF</td> <td>SV</td> </tr> </table>	MA t H	PV	oFF	SV	<p>4. Press the SEL key to enter CH8 (Calculation parameters). MAtH (simple calculation ON/OFF) is displayed.</p> <p>5. Press the SEL key. (The lower part of the screen begins to blink.)</p>
MA t H	PV				
oFF	SV				
<table border="1"> <tr> <td>oN</td> <td>SV</td> </tr> </table>	oN	SV	<p>6. Use \wedge \odot keys to change oFF to oN.</p>		
oN	SV				
<table border="1"> <tr> <td>W1MA</td> <td>PV</td> </tr> <tr> <td>1</td> <td>SV</td> </tr> </table>	W1MA	PV	1	SV	<p>7. Press the SEL key to save the change.</p> <p>8. Use the \wedge \odot keys to change MAtH to W1MA.</p>
W1MA	PV				
1	SV				
<table border="1"> <tr> <td>2</td> <td>SV</td> </tr> </table>	2	SV	<p>9. Press the SEL key. (The lower part of the screen begins to blink.)</p> <p>10. Use the \wedge \odot keys to change 1 to 2.</p>		
2	SV				
<table border="1"> <tr> <td>W1 i 1</td> <td>PV</td> </tr> <tr> <td>1</td> <td>SV</td> </tr> </table>	W1 i 1	PV	1	SV	<p>11. Press the SEL key to save the change.</p> <p>12. Use the \wedge \odot keys to change MAtH to W1i1.</p>
W1 i 1	PV				
1	SV				
<table border="1"> <tr> <td>W1 i 2</td> <td>PV</td> </tr> <tr> <td>2</td> <td>SV</td> </tr> </table>	W1 i 2	PV	2	SV	<p>13. Set W1i1 to "1", W1i2 to "2", and W1i3 to "3".</p>
W1 i 2	PV				
2	SV				
<table border="1"> <tr> <td>W1 i 3</td> <td>PV</td> </tr> <tr> <td>3</td> <td>SV</td> </tr> </table>	W1 i 3	PV	3	SV	<p>14. Press the SEL key to save the change.</p>
W1 i 3	PV				
3	SV				
<table border="1"> <tr> <td>CH 7</td> <td>PV</td> </tr> <tr> <td>SYS</td> <td>SV</td> </tr> </table>	CH 7	PV	SYS	SV	<p>15. Press the \wedge key to enter CH7 (System parameters).</p> <p>16. Set do1t to 30.</p>
CH 7	PV				
SYS	SV				
<table border="1"> <tr> <td>do 1 t</td> <td>PV</td> </tr> <tr> <td>30</td> <td>SV</td> </tr> </table>	do 1 t	PV	30	SV	<p>17. Press the SEL key to save the change.</p>
do 1 t	PV				
30	SV				
	<p>18. Press the \odot key to return to the PV/SV display.</p> <p>19. Turn the power off and on again.</p>				

3-10 CH9 COM (Communication parameters)

This device uses an RS-485 interface and can therefore communicate with personal computers, programmable operation indicators, and other devices. These parameters set the communication conditions for sending and receiving data.

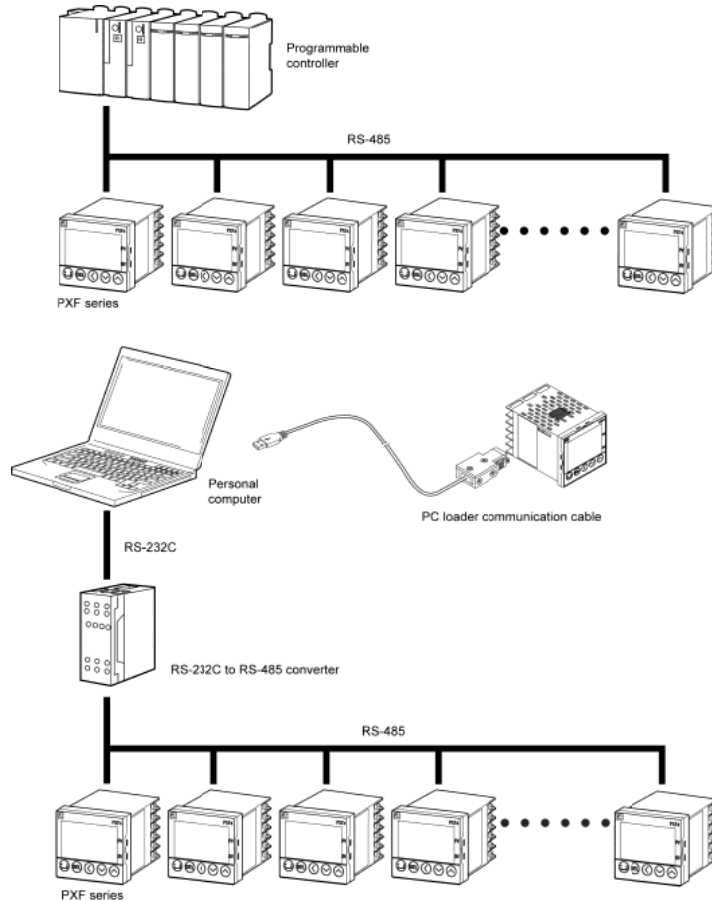

Note:

When using an RS-232C to RS-485 converter, make sure to correctly connect the cable between the converter and master. Communication will not occur properly if the connection is incorrect.

Also make sure to correctly set any communication settings (such as communication speed and parity) on the RS-232C and RS-485 converter. Communication will not occur properly if the settings are incorrect.

The following describes the typical communication behavior available when using MODBUS RTU.

The center of communications (personal computer, etc) on a network is called the "master". There can only be one master per network. The other devices on the network (including this device) are called "slaves" (1: N connection communication). Set a station number for each slave so that they do not overlap with each other. Communication consists of the master sending out a message with a station number attached and each slave determining if the message is meant for it. The slave to which the message was sent then responds to the master. Slaves do not initiate communication. A network consists of 1 master and up to 31 slaves (including this device). A network cable can be up to 500m long.

Refer to the "Micro Controller (Model: PXF) Communication Function Manual (MODBUS)" for information on communication procedures, protocols and settings.

CtyP Communication type (760)

[Description]

Selects the type of communication.

- Setting range

0	MODBUS RTU
1	Cooperative operation
2	Programless communication

Their functions are as follows: Refer to the "Micro Controller (Model: PXF) Communication Function Manual (MODBUS)" for the detail.

0: MODBUS RTU	Typical master/slave communication is available. A PC or PLC acts as a master, while multiple temperature controllers act as slaves. Communication is made in such a way that the master sends messages to the slaves, and the slaves respond to it.
1: Cooperative operation	When you control one temperature controller, the other controllers follow it. The controller acts as a master, while other controllers act as slaves. When you change the settings of the master controller, a message will be sent to all slave controllers so that they follow the change of the master.
2: Programless communication	PLC can read the data of temperature controllers or write data on temperature controllers without preparing a rudder program. One PLC act as a master, and multiple temperature controllers act as slaves. Each temperature controller in turn carries out master-slave communication with PLC. The communication protocol is MODBUS RTU.

Note:

Be sure to restart the controller after changing set points.

[Setting example] Setting the station No. to 3

Display	Operating procedure				
<table border="1"> <tr> <td>2 4 5</td> <td>PV</td> </tr> <tr> <td>250</td> <td>SV</td> </tr> </table>	2 4 5	PV	250	SV	<ol style="list-style-type: none"> 1. Check that the PV/SV display is shown. 2. Press and hold the SEL key to display CH1 (PID parameters). 3. Use the \odot key to access CH9 (Communication parameters). 4. Press the SEL key to enter CH9 (Communication parameters). CtyP (communication type) is displayed. 5. Press the SEL key. (The first digit of the lower part of the screen begins to blink.) 6. Use the \wedge \vee keys to change 0 to 2. 7. Press the SEL key to save the change. 8. Press the \ominus key to return to the PV/SV display.
2 4 5	PV				
250	SV				
<table border="1"> <tr> <td>CH 9</td> <td>PV</td> </tr> <tr> <td>CoM</td> <td>SV</td> </tr> </table>	CH 9	PV	CoM	SV	
CH 9	PV				
CoM	SV				
<table border="1"> <tr> <td>C t y P</td> <td>PV</td> </tr> <tr> <td>0</td> <td>SV</td> </tr> </table>	C t y P	PV	0	SV	
C t y P	PV				
0	SV				
<table border="1"> <tr> <td>2</td> <td>SV</td> </tr> </table>	2	SV			
2	SV				

StNo Station No. (761)

[Description] _____

Allows you to set the station number.

- Setting range: 0 to 255

(Note that setting the station number to 0 will suspend communication.)

If there are two or more slave devices, make sure that they do not have the same station numbers. If two devices on the same network share a station number, communication becomes unavailable.

[Setting example] Setting the station No. to 3 _____

Display	Operating procedure				
<table border="1"><tr><td data-bbox="108 649 331 716">2 4 5</td><td data-bbox="336 649 384 694">PV</td></tr><tr><td data-bbox="108 723 331 779">250</td><td data-bbox="336 723 384 768">SV</td></tr></table>	2 4 5	PV	250	SV	<p>1. Check that the PV/SV display is shown.</p>
2 4 5	PV				
250	SV				
<table border="1"><tr><td data-bbox="108 817 331 884">CH 9</td><td data-bbox="336 817 384 862">PV</td></tr><tr><td data-bbox="108 891 331 947">CoM</td><td data-bbox="336 891 384 936">SV</td></tr></table>	CH 9	PV	CoM	SV	<p>2. Press and hold the SEL key to display CH1 (PID parameters). 3. Use the \odot key to access CH9 (Communication parameters).</p>
CH 9	PV				
CoM	SV				
<table border="1"><tr><td data-bbox="108 985 331 1052">S t N o</td><td data-bbox="336 985 384 1030">PV</td></tr><tr><td data-bbox="108 1059 331 1115">1</td><td data-bbox="336 1059 384 1104">SV</td></tr></table>	S t N o	PV	1	SV	<p>4. Press the SEL key to enter CH9 (Communication parameters). StNo (station No.) is displayed. 5. Press the SEL key. (The first digit of the lower part of the screen begins to blink.)</p>
S t N o	PV				
1	SV				
<table border="1"><tr><td data-bbox="108 1153 331 1220">3</td><td data-bbox="336 1153 384 1198">SV</td></tr></table>	3	SV	<p>6. Use the \wedge \vee keys to change 1 to 3. 7. Press the SEL key to save the change.</p>		
3	SV				
	<p>8. Press the \odot key to return to the PV/SV display.</p>				

SPEd RS485 baud rate (762)

[Description] _____

Allows you to set the baud rate of RS-485 communication.

- Setting range: 96 (9600 bps), 192 (19200 bps), 384 (38400 bps), 115 k (115 kbps)

Note:

Be sure to restart the controller after changing the setpoint.

[Setting example] Setting the baud rate to 19200 bps _____

Display	Operating procedure				
<table border="1"> <tr> <td data-bbox="217 611 443 678">2 4 5</td> <td data-bbox="443 611 504 678">PV</td> </tr> <tr> <td data-bbox="217 678 443 745">250</td> <td data-bbox="443 678 504 745">SV</td> </tr> </table>	2 4 5	PV	250	SV	<p>1. Check that the PV/SV display is shown.</p>
2 4 5	PV				
250	SV				
<table border="1"> <tr> <td data-bbox="217 779 443 846">CH 9</td> <td data-bbox="443 779 504 846">PV</td> </tr> <tr> <td data-bbox="217 846 443 936">CoM</td> <td data-bbox="443 846 504 936">SV</td> </tr> </table>	CH 9	PV	CoM	SV	<p>2. Press and hold the SEL key to display CH1 (PID parameters).</p> <p>3. Use the \odot key to access CH9 (Communication parameters).</p>
CH 9	PV				
CoM	SV				
<table border="1"> <tr> <td data-bbox="217 969 443 1037">S t N o</td> <td data-bbox="443 969 504 1037">PV</td> </tr> <tr> <td data-bbox="217 1037 443 1126">1</td> <td data-bbox="443 1037 504 1126">SV</td> </tr> </table>	S t N o	PV	1	SV	<p>4. Press the SEL key to enter CH9 (Communication parameters). StNo (station No.) is displayed.</p>
S t N o	PV				
1	SV				
<table border="1"> <tr> <td data-bbox="217 1160 443 1227">S P E d</td> <td data-bbox="443 1160 504 1227">PV</td> </tr> <tr> <td data-bbox="217 1227 443 1317">96</td> <td data-bbox="443 1227 504 1317">SV</td> </tr> </table>	S P E d	PV	96	SV	<p>5. Use the \wedge \vee keys to change StNo to SPEd.</p> <p>6. Press the SEL key. (The first digit of the lower part of the screen begins to blink.)</p>
S P E d	PV				
96	SV				
<table border="1"> <tr> <td data-bbox="217 1350 443 1417">192</td> <td data-bbox="443 1350 504 1417">SV</td> </tr> </table>	192	SV	<p>7. Use the \wedge \vee keys to change 96 to 192.</p> <p>8. Press the SEL key to save the change.</p>		
192	SV				
	<p>9. Press the \odot key to return to the PV/SV display.</p>				

PRtY RS-485 parity (763)

[Description] _____







Allows you to set the parity check of RS-485 communication.

- Setting range: NoNE (no parity), odd, EVEN

Note:

Be sure to restart the controller after changing the setpoint.

[Setting example] Setting the RS-485 parity to NoNE (no parity) _____

Display	Operating procedure				
<table border="1"> <tr> <td>2 4 5</td> <td>PV</td> </tr> <tr> <td>250</td> <td>SV</td> </tr> </table>	2 4 5	PV	250	SV	<p>1. Check that the PV/SV display is shown.</p>
2 4 5	PV				
250	SV				
<table border="1"> <tr> <td>CH 9</td> <td>PV</td> </tr> <tr> <td>CoM</td> <td>SV</td> </tr> </table>	CH 9	PV	CoM	SV	<p>2. Press and hold the SEL key to display CH1 (PID parameters). 3. Use the  key to access CH9 (Communication parameters).</p>
CH 9	PV				
CoM	SV				
<table border="1"> <tr> <td>StNo</td> <td>PV</td> </tr> <tr> <td>1</td> <td>SV</td> </tr> </table>	StNo	PV	1	SV	<p>4. Press the SEL key to enter CH9 (Communication parameters). StNo (station No.) is displayed.</p>
StNo	PV				
1	SV				
<table border="1"> <tr> <td>PRtY</td> <td>PV</td> </tr> <tr> <td>odd</td> <td>SV</td> </tr> </table>	PRtY	PV	odd	SV	<p>5. Use the   keys to change StNo to PRtY. 6. Press the SEL key. (The lower part of the screen begins to blink.)</p>
PRtY	PV				
odd	SV				
<table border="1"> <tr> <td>NoNE</td> <td>SV</td> </tr> </table>	NoNE	SV	<p>7. Use the   keys to change odd to NoNE. 8. Press the SEL key to save the change.</p>		
NoNE	SV				
<table border="1"> <tr> <td>NoNE</td> <td>SV</td> </tr> </table>	NoNE	SV	<p>9. Press the  key to return to the PV/SV display.</p>		
NoNE	SV				

iNtV RS-485 response interval (764)

[Description]

Allows you to set the time interval before sending response.

Setpoint x 20 ms makes the response interval time.

- Setting range: 0 to 100

[Setting example] Setting the response interval to 40 ms

Display	Operating procedure				
<table border="1"> <tr> <td>2 4 5</td> <td>PV</td> </tr> <tr> <td>250</td> <td>SV</td> </tr> </table>	2 4 5	PV	250	SV	<p>1. Check that the PV/SV display is shown.</p>
2 4 5	PV				
250	SV				
<table border="1"> <tr> <td>CH 9</td> <td>PV</td> </tr> <tr> <td>CoM</td> <td>SV</td> </tr> </table>	CH 9	PV	CoM	SV	<p>2. Press and hold the SEL key to display CH1 (PID parameters).</p> <p>3. Use the \odot key to access CH9 (Communication parameters).</p>
CH 9	PV				
CoM	SV				
<table border="1"> <tr> <td>S t N o</td> <td>PV</td> </tr> <tr> <td>1</td> <td>SV</td> </tr> </table>	S t N o	PV	1	SV	<p>4. Press the SEL key to enter CH9 (Communication parameters). StNo (station No.) is displayed.</p> <p>5. Use the \wedge \odot keys to change StNo to iNtV.</p>
S t N o	PV				
1	SV				
<table border="1"> <tr> <td>i N t V</td> <td>PV</td> </tr> <tr> <td>1</td> <td>SV</td> </tr> </table>	i N t V	PV	1	SV	<p>6. Press the SEL key. (The lower part of the screen begins to blink.)</p> <p>7. Use the \wedge \odot keys to change 1 to 2.</p>
i N t V	PV				
1	SV				
<table border="1"> <tr> <td>2</td> <td>SV</td> </tr> </table>	2	SV	<p>8. Press the SEL key to save the change.</p>		
2	SV				
	<p>9. Press the \odot key to return to the PV/SV display.</p>				

SCC Communication permission (767)

[Description]

Allows you to specify whether the master is permitted or forbidden to write to the slave.

- Setting range R: read only
RW: read/write

[Setting example] Enabling the write protection

Display	Operating procedure				
<table border="1"> <tr> <td>2 4 5</td> <td>PV</td> </tr> <tr> <td>250</td> <td>SV</td> </tr> </table>	2 4 5	PV	250	SV	<p>1. Check that the PV/SV display is shown.</p>
2 4 5	PV				
250	SV				
<table border="1"> <tr> <td>CH 9</td> <td>PV</td> </tr> <tr> <td>CoM</td> <td>SV</td> </tr> </table>	CH 9	PV	CoM	SV	<p>2. Press and hold the SEL key to display CH1 (PID parameters). 3. Use the \odot key to access CH9 (Communication parameters).</p>
CH 9	PV				
CoM	SV				
<table border="1"> <tr> <td>StNo</td> <td>PV</td> </tr> <tr> <td>1</td> <td>SV</td> </tr> </table>	StNo	PV	1	SV	<p>4. Press the SEL key to enter CH9 (Communication parameters). StNo (station No.) is displayed.</p>
StNo	PV				
1	SV				
<table border="1"> <tr> <td>SCC</td> <td>PV</td> </tr> <tr> <td>RW</td> <td>SV</td> </tr> </table>	SCC	PV	RW	SV	<p>5. Use the \wedge \odot keys to change StNo to SCC. 6. Press the SEL key. (The lower part of the screen begins to blink.)</p>
SCC	PV				
RW	SV				
<table border="1"> <tr> <td>R</td> <td>SV</td> </tr> </table>	R	SV	<p>7. Use \wedge \odot keys to change RW to R. 8. Press the SEL key to save the change.</p>		
R	SV				
	<p>9. Press the \odot key to return to the PV/SV display.</p>				

UA01 to UA32 MODBUS user address setting 1 to 32 (769 to 800)

[Description]

By registering a MODBUS communication address with the user address area, you can read/write the data of addresses through one communication even if those address are not sequential.

You can register 32 addresses maximum.







The registered addresses are allocated to MODBUS address 45001 to 45032. By reading/writing on MODBUS address 45001 to 45032, you can read/write the data of registered addresses.

- Setting range: 30001 to 49999

Note:

Be sure to restart the controller after changing the setpoint.

[Setting example] Setting the user address 1 to 30100

Display	Operating procedure				
<table border="1"> <tr> <td>2 4 5</td> <td>PV</td> </tr> <tr> <td>250</td> <td>SV</td> </tr> </table>	2 4 5	PV	250	SV	<p>1. Check that the PV/SV display is shown.</p>
2 4 5	PV				
250	SV				
<table border="1"> <tr> <td>CH 9</td> <td>PV</td> </tr> <tr> <td>CoM</td> <td>SV</td> </tr> </table>	CH 9	PV	CoM	SV	<p>2. Press and hold the SEL key to display CH1 (PID parameters). 3. Use the  key to access CH9 (Communication parameters).</p>
CH 9	PV				
CoM	SV				
<table border="1"> <tr> <td>S t N o</td> <td>PV</td> </tr> <tr> <td>1</td> <td>SV</td> </tr> </table>	S t N o	PV	1	SV	<p>4. Press the SEL key to enter CH9 (Communication parameters). StNo (station No.) is displayed.</p>
S t N o	PV				
1	SV				
<table border="1"> <tr> <td>U A 0 1</td> <td>PV</td> </tr> <tr> <td>Ad3 0001</td> <td>SV</td> </tr> </table>	U A 0 1	PV	Ad3 0001	SV	<p>5. Use the   keys to change StNo to UA01. 6. Press the SEL key. (The lower part of the screen begins to blink.)</p>
U A 0 1	PV				
Ad3 0001	SV				
<table border="1"> <tr> <td>Ad3 0100</td> <td>SV</td> </tr> </table>	Ad3 0100	SV	<p>7. Use the   keys to change 30001 to 30100. 8. Press the SEL key to save the change.</p>		
Ad3 0100	SV				
	<p>9. Repeat the same steps to set other user addresses. 10. Press the  key to return to the PV/SV display.</p>				

- Cooperative operation parameters

CSVG Communication SV gain (801)

CSVs Communication SV shift (802)

kykd Cooperative operation items (803)

APCy All parameters copy (804)

- Programless communication parameters

PLSt Target PLC station No. (805)

PAdk PLC registration number allocation rule (806)

MSWt Communication interval between temperature controllers (807)

PLWt Communication interval between PLC and temperature controllers (808)

PLAd Head of PLC registration numbers (809)

SA01 to **SA16** Modbus address of data No.1 to No. 16 in setting area (810) to (825)

MA01 to **MA16** Modbus address of data No.1 to No. 16 in monitor area (826) to (841)

Refer to the "Micro Controller (Model: PXF) Communication Function Manual (MODBUS)" for configuration of cooperative operation parameters and programless communication parameters.

AFix Auto Fix (842)

[Description]

Sets whether or not to automatically save parameter values that are written via communication onto EEPROM.

- Setting range oN: Automatic data save
oFF: No data save

[Setting example] No data save

Display	Operating procedure				
<table border="1"> <tr> <td>245</td> <td>PV</td> </tr> <tr> <td>250</td> <td>SV</td> </tr> </table>	245	PV	250	SV	1. Check that the PV/SV display is shown.
245	PV				
250	SV				
<table border="1"> <tr> <td>CH 9</td> <td>PV</td> </tr> <tr> <td>CoM</td> <td>SV</td> </tr> </table>	CH 9	PV	CoM	SV	2. Press and hold the SEL key to display CH1 (PID parameters). 3. Use the \odot key to access CH9 (Communication parameters).
CH 9	PV				
CoM	SV				
<table border="1"> <tr> <td>StNo</td> <td>PV</td> </tr> <tr> <td>1</td> <td>SV</td> </tr> </table>	StNo	PV	1	SV	4. Press the SEL key to enter CH9 (Communication parameters). StNo (station No.) is displayed.
StNo	PV				
1	SV				
<table border="1"> <tr> <td>AFix</td> <td>PV</td> </tr> <tr> <td>oN</td> <td>SV</td> </tr> </table>	AFix	PV	oN	SV	5. Use the \wedge \vee keys to change StNo to AFix. 6. Press the SEL key. (The lower part of the screen begins to blink.)
AFix	PV				
oN	SV				
<table border="1"> <tr> <td>oFF</td> <td>SV</td> </tr> </table>	oFF	SV	7. Use \wedge \vee keys to change oN to oFF. 8. Press the SEL key to save the change.		
oFF	SV				
	9. Press the \square key to return to the PV/SV display.				

Note:

You cannot set or change this parameter by using the loader software.

3-11 CH10 PFB (PFB parameter)

PGAP PFB dead band (870)

[Description]

The dead band can be set to not output the valve open or close signal.

Using the valve dead band suppresses the motorized valve hatching and allows greater stabilization of the output.

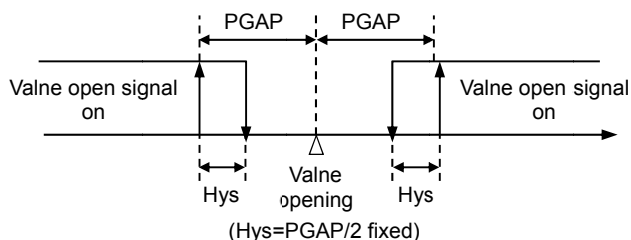

- Range: 0.0% to 100.0%

Note:

Narrow dead band may cause output chattering.

[Setting example] Setting parameter mask

Display	Operating procedure				
<table border="1" style="width: 100%;"> <tr> <td style="text-align: center; font-size: 24px;">2 4 5</td> <td style="text-align: center; font-size: 12px;">PV</td> </tr> <tr> <td style="text-align: center; font-size: 24px;">250</td> <td style="text-align: center; font-size: 12px;">SV</td> </tr> </table>	2 4 5	PV	250	SV	<ol style="list-style-type: none"> 1. Check that the PV/SV display is shown. 2. Press and hold the SEL key to display CH1 (PID parameters). 3. Use the key to access CH10 (PFB parameters). 4. Press the SEL key to enter CH10 (PFB parameters). PGAP (PFB dead band) is displayed. 5. Press the SEL key. (The first digit of the lower part of the screen begins to blink.) 6. Use the keys to change "0.0" to "10.0". 7. Press the SEL key to save the change. 8. Press the key to return to the PV/SV display.
2 4 5	PV				
250	SV				
<table border="1" style="width: 100%;"> <tr> <td style="text-align: center; font-size: 24px;">CH 1 0</td> <td style="text-align: center; font-size: 12px;">PV</td> </tr> <tr> <td style="text-align: center; font-size: 24px;">PFB</td> <td style="text-align: center; font-size: 12px;">SV</td> </tr> </table>	CH 1 0	PV	PFB	SV	
CH 1 0	PV				
PFB	SV				
<table border="1" style="width: 100%;"> <tr> <td style="text-align: center; font-size: 24px;">PGAP</td> <td style="text-align: center; font-size: 12px;">PV</td> </tr> <tr> <td style="text-align: center; font-size: 24px;">0.0</td> <td style="text-align: center; font-size: 12px;">SV</td> </tr> </table>	PGAP	PV	0.0	SV	
PGAP	PV				
0.0	SV				
<table border="1" style="width: 100%;"> <tr> <td style="text-align: center; font-size: 24px;">10.0</td> <td style="text-align: center; font-size: 12px;">SV</td> </tr> </table>	10.0	SV			
10.0	SV				

tRVL Valve stroke time (871)

[Description]

This function controls the time it takes for the motorized valve to go from fully open to fully closed. Refer to the motorized valve maker's catalog for the correct stroke time.

- Range: 5 sec to 180 sec

[Setting example] Setting the valve stroke time to 50 seconds

Display	Operating procedure				
<table border="1"> <tr> <td>2 4 5</td> <td>PV</td> </tr> <tr> <td>250</td> <td>SV</td> </tr> </table>	2 4 5	PV	250	SV	<ol style="list-style-type: none"> 1. Check that the PV/SV display is shown.
2 4 5	PV				
250	SV				
<table border="1"> <tr> <td>CH 1 0</td> <td>PV</td> </tr> <tr> <td>PFB</td> <td>SV</td> </tr> </table>	CH 1 0	PV	PFB	SV	<ol style="list-style-type: none"> 2. Press and hold the SEL key to display CH1 (PID parameters). 3. Use the \odot key to access CH10 (PFB parameters).
CH 1 0	PV				
PFB	SV				
<table border="1"> <tr> <td>PGAP</td> <td>PV</td> </tr> <tr> <td>0.0</td> <td>SV</td> </tr> </table>	PGAP	PV	0.0	SV	<ol style="list-style-type: none"> 4. Press the SEL key to enter CH10 (PFB parameters). PGAP (PFB dead band) is displayed.
PGAP	PV				
0.0	SV				
<table border="1"> <tr> <td>t RVL</td> <td>PV</td> </tr> <tr> <td>30</td> <td>SV</td> </tr> </table>	t RVL	PV	30	SV	<ol style="list-style-type: none"> 5. Use the \odot \odot keys to change "PGAP" to "tRVL". 6. Press the SEL key. (The first digit of the lower part of the screen begins to blink.)
t RVL	PV				
30	SV				
<table border="1"> <tr> <td>50</td> <td>SV</td> </tr> </table>	50	SV	<ol style="list-style-type: none"> 7. Use the \odot \odot keys to change "30" to "50". 8. Press the SEL key to save the change. 		
50	SV				
	<ol style="list-style-type: none"> 9. Press the \odot key to return to the PV/SV display. 				

CAL PFB input adjustment (873)

[Description] _____

This function adjusts whether PFB input is zero (fully closed) or span (fully opened).

There are automatic and manual methods for adjusting.

Setting	Function	Explanation
0	None/forcible termination	Ends adjustment immediately
1	Zero adjustment	Manually adjust zero
2	Span adjustment	Manually adjust span
3	Automatic adjustment	Automatically adjusts zero/span







Making Adjustments Manually

This section explains how to make motorized valve adjustments manually.

Note:

Manual adjustment must be set in the order zero (fully closed), then span (fully open). Adjustments cannot be made on just zero or just span.

[Setting example] Making the adjustment manually _____

Display	Operating procedure						
<table border="1"> <tr> <td>2 4 5</td> <td>PV</td> </tr> <tr> <td>250</td> <td>SV</td> </tr> </table>	2 4 5	PV	250	SV	1. Check that the PV/SV display is shown.		
2 4 5	PV						
250	SV						
<table border="1"> <tr> <td>MAN</td> <td></td> </tr> <tr> <td>2 4 5</td> <td>PV</td> </tr> <tr> <td>0</td> <td>MV</td> </tr> </table>	MAN		2 4 5	PV	0	MV	2. Change to the manual mode. (Refer to “auto/manual switchover” on page 29.)
MAN							
2 4 5	PV						
0	MV						
<table border="1"> <tr> <td>CH 1 0</td> <td>PV</td> </tr> <tr> <td>PFB</td> <td>SV</td> </tr> </table>	CH 1 0	PV	PFB	SV	3. Press the  key to move to PV/MV display, and press the  key to fully open the motorized valve..		
CH 1 0	PV						
PFB	SV						
<table border="1"> <tr> <td>PGAP</td> <td>PV</td> </tr> <tr> <td>0.0</td> <td>SV</td> </tr> </table>	PGAP	PV	0.0	SV	4. Press the SEL key to display CH1 (PID parameters). Use the  key to access CH10 (PFB parameters).		
PGAP	PV						
0.0	SV						
<table border="1"> <tr> <td>PGAP</td> <td>PV</td> </tr> <tr> <td>0.0</td> <td>SV</td> </tr> </table>	PGAP	PV	0.0	SV	5. Press the SEL key to enter CH10 (PFB parameters). PGAP (PFB dead band) is displayed.		
PGAP	PV						
0.0	SV						
<table border="1"> <tr> <td>CAL</td> <td>PV</td> </tr> <tr> <td>0</td> <td>SV</td> </tr> </table>	CAL	PV	0	SV	6. Use the   keys to change “PGAP” to “CAL”.		
CAL	PV						
0	SV						
<table border="1"> <tr> <td>1</td> <td>SV</td> </tr> </table>	1	SV	7. Press the SEL key. (The first digit of the lower part of the screen begins to blink.)				
1	SV						
<table border="1"> <tr> <td>0</td> <td>SV</td> </tr> </table>	0	SV	8. Use the   keys to change “0” to “1”.				
0	SV						
<table border="1"> <tr> <td>0</td> <td>SV</td> </tr> </table>	0	SV	9. Press the SEL key. When the value on SV display automatically changes from “1” back to “0”, the zero adjustment is finished.				
0	SV						

MAN	2 4 5	PV
	100	MV









CH 1 0	PV
PFB	SV

PGAP	PV
0.0	SV

CAL	PV
0	SV

2	SV
---	----

0	SV
---	----

10. Press the  key to return to the PV/MV display.
11. Fully open the motorized valve by using the  key.
12. Press and hold the SEL key to display CH1 (PID parameters).
13. Use the  key to access CH10 (PFB parameters).
14. Press the SEL key to enter CH10 (PFB parameters). PGAP (PFB dead band) is displayed.
15. Use the   keys to change "PGAP" to "CAL".
16. Press the SEL key.
(The first digit of the lower part of the screen begins to blink.)
17. Use the   keys to change "0" to "2".
18. Press the SEL key. When the value on SV display automatically changes from "2" back to "0", the span adjustment is finished.
19. Press the  key to return to the PV/MV display.

Making the adjustment automatically

The following steps explain how to make adjustments to zero and span automatically.

- In automatic adjustment, the controller fully opens or fully closes the motorized valve to make zero and span adjustment for PFB input. The controller also change the valve stroke time "TrvL" to the optimal value.
- When running automatic adjustment with "CAL" at "3", an adjustment error has occurred if the display changes to "10" or "20". Remove the source of the error and perform adjustment again.

CAL display	Error name	Error source	Measures against error
10	Over travel time	Automatic adjustment does not finish within 180 seconds.	The full stroke time greater than 180 seconds cannot be used for the motorized valve. Use a full stroke time within 180 seconds for the motorized valve.
20	PFB span error	There is an error in the span value for PFB input.	Recheck the valve control output and PFB input wire connection.

[Setting example] Making the adjustment automatically

Display	Operating procedure						
<table border="1"> <tr> <td>2 4 5</td> <td>PV</td> </tr> <tr> <td>250</td> <td>SV</td> </tr> </table>	2 4 5	PV	250	SV	<p>1. Check that the PV/SV display is shown.</p>		
2 4 5	PV						
250	SV						
<table border="1"> <tr> <td>MAN</td> <td></td> </tr> <tr> <td>2 4 5</td> <td>PV</td> </tr> <tr> <td>250</td> <td>SV</td> </tr> </table>	MAN		2 4 5	PV	250	SV	<p>2. Change to the manual mode. (Refer to “auto/manual switchover” on page 29.)</p>
MAN							
2 4 5	PV						
250	SV						
<table border="1"> <tr> <td>CH 1 0</td> <td>PV</td> </tr> <tr> <td>PFB</td> <td>SV</td> </tr> </table>	CH 1 0	PV	PFB	SV	<p>3. Press and hold the SEL key to display CH1 (PID parameters). 4. Use the \odot key to access CH10 (PFB parameters).</p>		
CH 1 0	PV						
PFB	SV						
<table border="1"> <tr> <td>PGAP</td> <td>PV</td> </tr> <tr> <td>0.0</td> <td>SV</td> </tr> </table>	PGAP	PV	0.0	SV	<p>5. Press the SEL key to enter CH10 (PFB parameters). PGAP (PFB dead band) is displayed.</p>		
PGAP	PV						
0.0	SV						
<table border="1"> <tr> <td>CAL</td> <td>PV</td> </tr> <tr> <td>0</td> <td>SV</td> </tr> </table>	CAL	PV	0	SV	<p>6. Use the \wedge \odot keys to change “PGAP” to “CAL”.</p>		
CAL	PV						
0	SV						
<table border="1"> <tr> <td>3</td> <td>SV</td> </tr> </table>	3	SV	<p>7. Press the SEL key. (The first digit of the lower part of the screen begins to blink.)</p>				
3	SV						
<table border="1"> <tr> <td>0</td> <td>SV</td> </tr> </table>	0	SV	<p>8. Use the \wedge \odot keys to change “0” to “3”.</p>				
0	SV						
	<p>9. Press the SEL key. The motorized valve will automatically move from fully open to fully closed and record those positions. When the value on SV display automatically changes from “3” back to “0”, the adjustment is finished.</p>						
	<p>10. Press the \odot key to return to the PV/SV display.</p>						

Note:

Automatic adjustment of PFB input is available only in the manual mode.

3-12 CH11 DSP (Parameter mask)

dp01 Parameter mask

[Description]

- The parameter mask allows you to hide unused parameters or to skip over the parameters you want to keep their setpoints. To hide a parameter, change its parameter mask setting from "diSP" to "oFF". You can also select a whole channel to hide.

Note:

Do not let the parameters which are not described in this operation manual appear on the screen.

[Setting example] Setting parameter mask

Display	Operating procedure				
<table border="1"> <tr> <td>2 4 5</td> <td>PV</td> </tr> <tr> <td>250</td> <td>SV</td> </tr> </table>	2 4 5	PV	250	SV	1. Check that the PV/SV display is shown.
2 4 5	PV				
250	SV				
<table border="1"> <tr> <td>CH 1 1</td> <td>PV</td> </tr> <tr> <td>dSP</td> <td>SV</td> </tr> </table>	CH 1 1	PV	dSP	SV	2. Press and hold the SEL key to display CH1 (PID parameters).
CH 1 1	PV				
dSP	SV				
<table border="1"> <tr> <td>dSP</td> <td>PV</td> </tr> <tr> <td>CH</td> <td>SV</td> </tr> </table>	dSP	PV	CH	SV	3. Use the \odot key to access CH11 (Parameter mask).
dSP	PV				
CH	SV				
<table border="1"> <tr> <td>dSP</td> <td>PV</td> </tr> <tr> <td>CH</td> <td>SV</td> </tr> </table>	dSP	PV	CH	SV	4. Press the SEL key to enter CH11 (Parameter mask). dSP (parameter mask) is displayed.
dSP	PV				
CH	SV				
<table border="1"> <tr> <td>P i d</td> <td>PV</td> </tr> <tr> <td>diSP</td> <td>SV</td> </tr> </table>	P i d	PV	diSP	SV	<u>To set parameter mask for a whole channel</u>
P i d	PV				
diSP	SV				
<table border="1"> <tr> <td>oFF</td> <td>SV</td> </tr> </table>	oFF	SV	5. Press the SEL key. Use the \wedge \odot keys to select the CH to hide, and the press the SEL key.		
oFF	SV				
<table border="1"> <tr> <td>dSP</td> <td>PV</td> </tr> <tr> <td>CH1 Pid</td> <td>SV</td> </tr> </table>	dSP	PV	CH1 Pid	SV	<u>To set parameter mask for each parameter</u>
dSP	PV				
CH1 Pid	SV				
<table border="1"> <tr> <td>P</td> <td>PV</td> </tr> <tr> <td>diSP</td> <td>SV</td> </tr> </table>	P	PV	diSP	SV	6. Use the \wedge \odot keys to select CH to which the parameter you want to hide belongs.
P	PV				
diSP	SV				
<table border="1"> <tr> <td>P</td> <td>PV</td> </tr> <tr> <td>diSP</td> <td>SV</td> </tr> </table>	P	PV	diSP	SV	7. Press the SEL key.
P	PV				
diSP	SV				
<table border="1"> <tr> <td>P</td> <td>PV</td> </tr> <tr> <td>diSP</td> <td>SV</td> </tr> </table>	P	PV	diSP	SV	8. Use the \wedge \odot keys to select the parameter to hide, and the press the SEL key.
P	PV				
diSP	SV				
<table border="1"> <tr> <td>oFF</td> <td>SV</td> </tr> </table>	oFF	SV	9. Press the \odot key to return to the PV/SV display.		
oFF	SV				





3-13 CH12 CFG (Configuration parameters)

toUt Operation timeout (940)

[Description]

- Sets the time until the display returns to the PV/SV screen when no operation is made during setting mode (channel display or parameter display).
- Setting range: 15S: 15 sec., 30S: 30 sec., 60S: 60 sec., 5M: 5 min., 10M: 10 min., non: no return

[Setting example] Setting the operation timeout to 5 minutes







Display	Operating procedure				
<table border="1" style="width: 100%; text-align: center;"> <tr> <td style="width: 80%;">2 4 5</td> <td style="width: 20%;">PV</td> </tr> <tr> <td>250</td> <td>SV</td> </tr> </table>	2 4 5	PV	250	SV	<p>1. Check that the PV/SV display is shown.</p>
2 4 5	PV				
250	SV				
<table border="1" style="width: 100%; text-align: center;"> <tr> <td style="width: 80%;">CH 1 2</td> <td style="width: 20%;">PV</td> </tr> <tr> <td>CFG</td> <td>SV</td> </tr> </table>	CH 1 2	PV	CFG	SV	<p>2. Press and hold the SEL key to display CH1 (PID parameters).</p> <p>3. Press the  key to display CH12 (Configuration parameters).</p>
CH 1 2	PV				
CFG	SV				
<table border="1" style="width: 100%; text-align: center;"> <tr> <td style="width: 80%;">t o U t</td> <td style="width: 20%;">PV</td> </tr> <tr> <td>60 S</td> <td>SV</td> </tr> </table>	t o U t	PV	60 S	SV	<p>4. Press the SEL key to enter CH12 (Configuration parameters). toUt (operation timeout) is displayed.</p> <p>5. Press the SEL key. (The first digit of the lower part of the screen begins to blink.)</p>
t o U t	PV				
60 S	SV				
<table border="1" style="width: 100%; text-align: center;"> <tr> <td style="width: 80%;">5 M</td> <td style="width: 20%;">SV</td> </tr> </table>	5 M	SV	<p>6. Use the   keys to change 60S to 5M.</p> <p>7. Press the SEL key to save the change.</p> <p>8. Press the  key to return to the PV/SV display.</p>		
5 M	SV				

SoFK Blinking SV during soft start (942)

[Description]

- Specifies whether or not to blink “SoFT” on SV display during soft start.
- Setting range: oFF: does not display “SoFT” and SV alternately.
oN: displays “SoFT” and SV alternately.

[Setting example] Setting not to blink SoFt

Display	Operating procedure				
<table border="1"> <tr> <td>2 4 5</td> <td>PV</td> </tr> <tr> <td>250</td> <td>SV</td> </tr> </table>	2 4 5	PV	250	SV	<p>1. Check that the PV/SV display is shown.</p>
2 4 5	PV				
250	SV				
<table border="1"> <tr> <td>CH 1 2</td> <td>PV</td> </tr> <tr> <td>CFG</td> <td>SV</td> </tr> </table>	CH 1 2	PV	CFG	SV	<p>2. Press and hold the SEL key to display CH1 (PID parameters).</p> <p>3. Press the  key to display CH12 (Configuration parameters).</p>
CH 1 2	PV				
CFG	SV				
<table border="1"> <tr> <td>t o U t</td> <td>PV</td> </tr> <tr> <td>60 S</td> <td>SV</td> </tr> </table>	t o U t	PV	60 S	SV	<p>4. Press the SEL key to enter CH12 (Configuration parameters). toUt (operation timeout) is displayed.</p>
t o U t	PV				
60 S	SV				
<table border="1"> <tr> <td>S o F t</td> <td>PV</td> </tr> <tr> <td>oN</td> <td>SV</td> </tr> </table>	S o F t	PV	oN	SV	<p>5. Use the   keys to change toUt to SoFt.</p> <p>6. Press the SEL key. (The first digit of the lower part of the screen begins to blink.)</p>
S o F t	PV				
oN	SV				
<table border="1"> <tr> <td>oFF</td> <td>SV</td> </tr> </table>	oFF	SV	<p>7. Use   keys to change oN to oFF.</p>		
oFF	SV				
	<p>8. Press the SEL key to save the change.</p> <p>9. Press the  key to return to the PV/SV display.</p>				

ALMF Blinking PV/SV at ALM (943)

[Description]

- Specifies the contents displayed when an alarm occurs.

Setting	Function
0	Displays PV (no change)
1	Displays PV and the alarm status alternately
2	Displays flashing PV
3	Displays the alarm status only (PV is not displayed)

- The following shows the detail of the contents displayed for each setting.
- Setting 0: Displays PV (no change)

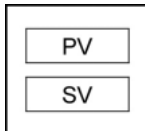

Setting 1: PV and the alarm status are alternately displayed when an alarm or alarms occur.

- PV and the alarm number that is activated (“AL1” for the alarm 1 and “AL2” for the alarm 2) are alternately displayed.
- The alarm number that is activated (“AL1” for the alarm 1, “AL2” for the alarm 2).

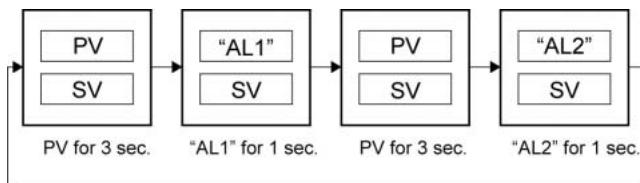

Setting 2: Blinking PV is displayed when an alarm or alarms occur.

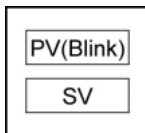





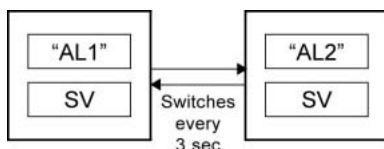

Setting 3: The alarm status is only displayed when an alarm or alarms occur. PV is not displayed.

- Will be displayed on PV display area.
- The alarm number that is activated (“AL1” for the alarm 1, “AL2” for the alarm 2).
- When both of the alarm 1 and 2 are activated, “AL1” and “AL2” are displayed alternately.



[Setting example] Setting to display only the alarm status during an alarm

Display	Operating procedure				
<table border="1"> <tr> <td data-bbox="103 280 327 347">2 4 5</td> <td data-bbox="335 280 383 347">PV</td> </tr> <tr> <td data-bbox="103 347 327 414">250</td> <td data-bbox="335 347 383 414">SV</td> </tr> </table>	2 4 5	PV	250	SV	<p>1. Check that the PV/SV display is shown.</p>
2 4 5	PV				
250	SV				
<table border="1"> <tr> <td data-bbox="103 481 327 548">CH 1 2</td> <td data-bbox="335 481 383 548">PV</td> </tr> <tr> <td data-bbox="103 548 327 622">CFG</td> <td data-bbox="335 548 383 622">SV</td> </tr> </table>	CH 1 2	PV	CFG	SV	<p>2. Press and hold the SEL key to display CH1 (PID parameters).</p> <p>3. Press the  key to display CH12 (Configuration parameters).</p>
CH 1 2	PV				
CFG	SV				
<table border="1"> <tr> <td data-bbox="103 683 327 750">t o U t</td> <td data-bbox="335 683 383 750">PV</td> </tr> <tr> <td data-bbox="103 750 327 831">60 S</td> <td data-bbox="335 750 383 831">SV</td> </tr> </table>	t o U t	PV	60 S	SV	<p>4. Press the SEL key to enter CH12 (Configuration parameters). toUt (operation timeout) is displayed.</p>
t o U t	PV				
60 S	SV				
<table border="1"> <tr> <td data-bbox="103 884 327 952">ALMF</td> <td data-bbox="335 884 383 952">PV</td> </tr> <tr> <td data-bbox="103 952 327 1039">0</td> <td data-bbox="335 952 383 1039">SV</td> </tr> </table>	ALMF	PV	0	SV	<p>5. Use the   keys to change toUt to ALMF.</p> <p>6. Press the SEL key. (The first digit of the lower part of the screen begins to blink.)</p>
ALMF	PV				
0	SV				
<table border="1"> <tr> <td data-bbox="103 1064 327 1137">3</td> <td data-bbox="335 1064 383 1137">SV</td> </tr> </table>	3	SV	<p>7. Use the   keys to change 0 to 3.</p> <p>8. Press the SEL key to save the change.</p>		
3	SV				
	<p>9. Press the  key to return to the PV/SV display.</p>				

LoFF Display timeout (944)







[Description]

With this function, the displays and indicator lamps are automatically turned off if the specified time passed without any key operation.

Setting	Function
oFF	Displays stay ON
15 S	Displays are turned off 15 seconds after the last key operation.
30 S	Displays are turned off 30 seconds after the last key operation.
1 M	Displays are turned off 1 minute after the last key operation.
5 M	Displays are turned off 5 minutes after the last key operation.

- When the displays are turned off, all the displays and lamps except SV lamp will be turned off and PV lamp blinks.
- The displays stay ON during an input error or an alarm status.
- PV and SV will be turned on when an input error or an alarm occurs during the displays are turned off.

[Setting example] Setting the time for auto display off to 15 seconds after the last key operation

Display	Operating procedure				
<table border="1"> <tr> <td>2 4 5</td> <td>PV</td> </tr> <tr> <td>250</td> <td>SV</td> </tr> </table>	2 4 5	PV	250	SV	1. Check that the PV/SV display is shown.
2 4 5	PV				
250	SV				
<table border="1"> <tr> <td>CH 1 2</td> <td>PV</td> </tr> <tr> <td>CFG</td> <td>SV</td> </tr> </table>	CH 1 2	PV	CFG	SV	2. Press and hold the SEL key to display CH1 (PID parameters).
CH 1 2	PV				
CFG	SV				
<table border="1"> <tr> <td>t o U t</td> <td>PV</td> </tr> <tr> <td>60 S</td> <td>SV</td> </tr> </table>	t o U t	PV	60 S	SV	3. Press the  key to display CH12 (Configuration parameters).
t o U t	PV				
60 S	SV				
<table border="1"> <tr> <td>t o U t</td> <td>PV</td> </tr> <tr> <td>60 S</td> <td>SV</td> </tr> </table>	t o U t	PV	60 S	SV	4. Press the SEL key to enter CH12 (Configuration parameters). toUt (operation timeout) is displayed.
t o U t	PV				
60 S	SV				
<table border="1"> <tr> <td>L o F F</td> <td>PV</td> </tr> <tr> <td>oFF</td> <td>SV</td> </tr> </table>	L o F F	PV	oFF	SV	5. Use the   keys to change toUt to LoFF.
L o F F	PV				
oFF	SV				
<table border="1"> <tr> <td>15 S</td> <td>SV</td> </tr> </table>	15 S	SV	6. Press the SEL key. (The first digit of the lower part of the screen begins to blink.)		
15 S	SV				
	7. Use   keys to change "oFF" to "15S".				
	8. Press the SEL key to save the change.				
	9. Press the  key to return to the PV/SV display.				

dSPt PV/SV display OFF (945)

[Description]

This parameter is used to manually turn off the PV, SV, and LED lamps on PV/SV screen.

Setting	Function
0	PV, SV, and LED lamps stay ON
1	SV display OFF
2	PV display OFF
3	PV and SV displays OFF
4	PV, SV, and LED lamps OFF
5	SV display OFF (relights for 5 sec. by pressing any key)
6	PV display OFF (relights for 5 sec. by pressing any key)
7	PV and SV displays OFF (relights for 5 sec. by pressing any key)
8	PV, SV, and LED lamps OFF (relights for 5 sec. by pressing any key)

- In settings 5 to 8, the displays and lamps stay ON even after 5 seconds, if an input error or an alarm has occurred.
- PV and SV will be turned on when an input error or an alarm occurs during the displays are turned off.

[Setting example] Turning off the PV display

Display	Operating procedure				
<table border="1"> <tr> <td>2 4 5</td> <td>PV</td> </tr> <tr> <td>250</td> <td>SV</td> </tr> </table>	2 4 5	PV	250	SV	<ol style="list-style-type: none"> 1. Check that the PV/SV display is shown. 2. Press and hold the SEL key to display CH1 (PID parameters). 3. Press the \odot key to display CH12 (Configuration parameters). 4. Press the SEL key to enter CH12 (Configuration parameters). toUt (operation timeout) is displayed. 5. Use the \wedge \odot keys to change toUt to dSPt. 6. Press the SEL key. (The first digit of the lower part of the screen begins to blink.) 7. Use the \wedge \odot keys to change 0 to 2. 8. Press the SEL key to save the change. 9. Press the \ominus key to return to the PV/SV display.
2 4 5	PV				
250	SV				
<table border="1"> <tr> <td>CH 1 2</td> <td>PV</td> </tr> <tr> <td>CFG</td> <td>SV</td> </tr> </table>	CH 1 2	PV	CFG	SV	
CH 1 2	PV				
CFG	SV				
<table border="1"> <tr> <td>t o U t</td> <td>PV</td> </tr> <tr> <td>60 S</td> <td>SV</td> </tr> </table>	t o U t	PV	60 S	SV	
t o U t	PV				
60 S	SV				
<table border="1"> <tr> <td>d S P t</td> <td>PV</td> </tr> <tr> <td>0</td> <td>SV</td> </tr> </table>	d S P t	PV	0	SV	
d S P t	PV				
0	SV				
<table border="1"> <tr> <td>2</td> <td>SV</td> </tr> </table>	2	SV			
2	SV				

FLtF Blinking PV at input error (946)

[Description]

Allows you to set whether or not to blink PV during an input error (UUUU, LLLL, ERR).

Setting	Function
0	PV blinks during an input error
1	PV does not blink during an input error

[Setting example] Setting PV display not to blink during an input error

Display	Operating procedure				
<table border="1"> <tr> <td>2 4 5</td> <td>PV</td> </tr> <tr> <td>250</td> <td>SV</td> </tr> </table>	2 4 5	PV	250	SV	<ol style="list-style-type: none"> 1. Check that the PV/SV display is shown. 2. Press and hold the SEL key to display CH1 (PID parameters). 3. Press the \odot key to display CH12 (Configuration parameters). 4. Press the SEL key to enter CH12 (Configuration parameters). toUt (operation timeout) is displayed. 5. Use the \wedge \vee keys to change toUt to FLtF. 6. Press the SEL key. (The first digit of the lower part of the screen begins to blink.) 7. Use the \wedge \vee keys to change 0 to 1. 8. Press the SEL key to save the change. 9. Press the \ominus key to return to the PV/SV display.
2 4 5	PV				
250	SV				
<table border="1"> <tr> <td>CH 1 2</td> <td>PV</td> </tr> <tr> <td>CFG</td> <td>SV</td> </tr> </table>	CH 1 2	PV	CFG	SV	
CH 1 2	PV				
CFG	SV				
<table border="1"> <tr> <td>t o U t</td> <td>PV</td> </tr> <tr> <td>60 S</td> <td>SV</td> </tr> </table>	t o U t	PV	60 S	SV	
t o U t	PV				
60 S	SV				
<table border="1"> <tr> <td>FLtF</td> <td>PV</td> </tr> <tr> <td>0</td> <td>SV</td> </tr> </table>	FLtF	PV	0	SV	
FLtF	PV				
0	SV				
<table border="1"> <tr> <td>1</td> <td>SV</td> </tr> </table>	1	SV			
1	SV				

bLit Brightness (947)

[Description]

Allows you to set the brightness of LED backlight.

- Setting range: 0 to 3 (3 is the brightest)

[Setting example] Setting the brightness to 0 (the darkest)

Display	Operating procedure				
<table border="1"><tr><td>2 4 5</td><td>PV</td></tr><tr><td>250</td><td>SV</td></tr></table>	2 4 5	PV	250	SV	1. Check that the PV/SV display is shown.
2 4 5	PV				
250	SV				
<table border="1"><tr><td>CH 1 2</td><td>PV</td></tr><tr><td>CFG</td><td>SV</td></tr></table>	CH 1 2	PV	CFG	SV	2. Press and hold the SEL key to display CH1 (PID parameters).
CH 1 2	PV				
CFG	SV				
	3. Press the \odot key to display CH12 (Configuration parameters).				
<table border="1"><tr><td>t o U t</td><td>PV</td></tr><tr><td>60 S</td><td>SV</td></tr></table>	t o U t	PV	60 S	SV	4. Press the SEL key to enter CH12 (Configuration parameters). toUt (operation timeout) is displayed.
t o U t	PV				
60 S	SV				
<table border="1"><tr><td>b L i t</td><td>PV</td></tr><tr><td>3</td><td>SV</td></tr></table>	b L i t	PV	3	SV	5. Use the \wedge \odot keys to change toUt to bLit.
b L i t	PV				
3	SV				
	6. Press the SEL key. (The first digit of the lower part of the screen begins to blink.)				
<table border="1"><tr><td>0</td><td>SV</td></tr></table>	0	SV	7. Use the \wedge \odot keys to change 3 to 0.		
0	SV				
	8. Press the SEL key to save the change.				
	9. Press the \odot key to return to the PV/SV display.				







bCoN Control at burnout (948)

[Description]

Allows you to set whether to continue or to stop control when the device detects a burnout of PV input.

- Setting range: oN: continues control
oFF: Stop control (control output depends on the set values of FL01 and FL02.)

[Setting example] Setting to continue the control at burnout





Display	Operating procedure				
<table border="1"> <tr> <td>245</td> <td>PV</td> </tr> <tr> <td>250</td> <td>SV</td> </tr> </table>	245	PV	250	SV	1. Check that the PV/SV display is shown.
245	PV				
250	SV				
<table border="1"> <tr> <td>CH12</td> <td>PV</td> </tr> <tr> <td>CFG</td> <td>SV</td> </tr> </table>	CH12	PV	CFG	SV	2. Press and hold the SEL key to display CH1 (PID parameters). 3. Press the  key to display CH12 (Configuration parameters).
CH12	PV				
CFG	SV				
<table border="1"> <tr> <td>toUt</td> <td>PV</td> </tr> <tr> <td>60 S</td> <td>SV</td> </tr> </table>	toUt	PV	60 S	SV	4. Press the SEL key to enter CH12 (Configuration parameters). toUt (operation timeout) is displayed.
toUt	PV				
60 S	SV				
<table border="1"> <tr> <td>bCoN</td> <td>PV</td> </tr> <tr> <td>oFF</td> <td>SV</td> </tr> </table>	bCoN	PV	oFF	SV	5. Use the   keys to change toUt to bCoN. 6. Press the SEL key. (The first digit of the lower part of the screen begins to blink.)
bCoN	PV				
oFF	SV				
<table border="1"> <tr> <td>oN</td> <td>SV</td> </tr> </table>	oN	SV	7. Use   keys to change "oFF" to "oN". 8. Press the SEL key to save the change.		
oN	SV				
	9. Press the  key to return to the PV/SV display.				

PL01 to PL13 Model code (950 to 962)

[Description] _____

Displays the model code of the controller.

[Setting example] Checking the model code _____

Display	Operating procedure						
<table border="1"> <tr> <td>245</td> <td>PV</td> </tr> <tr> <td>250</td> <td>SV</td> </tr> </table>	245	PV	250	SV	1. Check that the PV/SV display is shown.		
245	PV						
250	SV						
<table border="1"> <tr> <td>CH12</td> <td>PV</td> </tr> <tr> <td>CFG</td> <td>SV</td> </tr> </table>	CH12	PV	CFG	SV	2. Press and hold the SEL key to display CH1 (PID parameters).		
CH12	PV						
CFG	SV						
<table border="1"> <tr> <td>toUt</td> <td>PV</td> </tr> <tr> <td>60 S</td> <td>SV</td> </tr> </table>	toUt	PV	60 S	SV	3. Press the  key to display CH12 (Configuration parameters).		
toUt	PV						
60 S	SV						
<table border="1"> <tr> <td>PL01</td> <td>PV</td> </tr> <tr> <td>P</td> <td>SV</td> </tr> </table>	PL01	PV	P	SV	4. Press the SEL key to enter CH12 (Configuration parameters). toUt (operation timeout) is displayed.		
PL01	PV						
P	SV						
<table border="1"> <tr> <td>PL02</td> <td>PV</td> </tr> <tr> <td>X</td> <td>SV</td> </tr> </table>	PL02	PV	X	SV	5. Use the   keys to change toUt to PL01. (The first code is displayed.)		
PL02	PV						
X	SV						
<table border="1"> <tr> <td>PL03</td> <td>PV</td> </tr> <tr> <td>F</td> <td>SV</td> </tr> </table>	PL03	PV	F	SV	6. Use the  key to check PL02 to PL13. (The code from the second to the 13th appears in order.)		
PL03	PV						
F	SV						
<table border="1"> <tr> <td>.</td> <td></td> </tr> <tr> <td>.</td> <td></td> </tr> <tr> <td>.</td> <td></td> </tr> </table>	.		.		.		7. Press the  key to return to the PV/SV display.
.							
.							
.							
<table border="1"> <tr> <td>PL13</td> <td>PV</td> </tr> <tr> <td>0</td> <td>SV</td> </tr> </table>	PL13	PV	0	SV			
PL13	PV						
0	SV						

RSt Reset (963)

[Description]





Allows you to reset the controller without recycling the power.

- Setting range: oFF: do nothing

RSt: reset the controller

Resetting the controller is equivalent to turning the power off and on.

[Setting example] Resetting the controller





Display	Operating procedure				
<table border="1"> <tr> <td data-bbox="217 611 443 678">2 4 5</td> <td data-bbox="443 611 504 678">PV</td> </tr> <tr> <td data-bbox="217 678 443 745">250</td> <td data-bbox="443 678 504 745">SV</td> </tr> </table>	2 4 5	PV	250	SV	<p>1. Check that the PV/SV display is shown.</p>
2 4 5	PV				
250	SV				
<table border="1"> <tr> <td data-bbox="217 813 443 880">CH 1 2</td> <td data-bbox="443 813 504 880">PV</td> </tr> <tr> <td data-bbox="217 880 443 947">CFG</td> <td data-bbox="443 880 504 947">SV</td> </tr> </table>	CH 1 2	PV	CFG	SV	<p>2. Press and hold the SEL key to display CH1 (PID parameters).</p> <p>3. Press the  key to display CH12 (Configuration parameters).</p>
CH 1 2	PV				
CFG	SV				
<table border="1"> <tr> <td data-bbox="217 1025 443 1093">t o U t</td> <td data-bbox="443 1025 504 1093">PV</td> </tr> <tr> <td data-bbox="217 1093 443 1160">60 S</td> <td data-bbox="443 1093 504 1160">SV</td> </tr> </table>	t o U t	PV	60 S	SV	<p>4. Press the SEL key to enter CH12 (Configuration parameters). toUt (operation timeout) is displayed.</p>
t o U t	PV				
60 S	SV				
<table border="1"> <tr> <td data-bbox="217 1238 443 1305">R S t</td> <td data-bbox="443 1238 504 1305">PV</td> </tr> <tr> <td data-bbox="217 1305 443 1373">oFF</td> <td data-bbox="443 1305 504 1373">SV</td> </tr> </table>	R S t	PV	oFF	SV	<p>5. Use the   keys to change toUt to RSt.</p> <p>6. Press the SEL key.</p> <p>7. Use the   keys to change oFF to RSt.</p>
R S t	PV				
oFF	SV				
<table border="1"> <tr> <td data-bbox="217 1406 443 1473">RSt</td> <td data-bbox="443 1406 504 1473">SV</td> </tr> </table>	RSt	SV	<p>8. Press the SEL key to reset the controller.</p>		
RSt	SV				

VER1 to VER4 Software version (965 to 968)





[Description] _____

You can check the software version.

[Setting example] Checking the software version _____

Display	Operating procedure				
<table border="1"> <tr> <td>2 4 5</td> <td>PV</td> </tr> <tr> <td>250</td> <td>SV</td> </tr> </table>	2 4 5	PV	250	SV	<p>1. Check that the PV/SV display is shown.</p>
2 4 5	PV				
250	SV				
<table border="1"> <tr> <td>CH 1 2</td> <td>PV</td> </tr> <tr> <td>CFG</td> <td>SV</td> </tr> </table>	CH 1 2	PV	CFG	SV	<p>2. Press and hold the SEL key to display CH1 (PID parameters). 3. Press the  key to access CH12 (Configuration parameters).</p>
CH 1 2	PV				
CFG	SV				
<table border="1"> <tr> <td>t o U t</td> <td>PV</td> </tr> <tr> <td>60 S</td> <td>SV</td> </tr> </table>	t o U t	PV	60 S	SV	<p>4. Press the SEL key to enter CH12 (Configuration parameters). toUt (operation timeout) is displayed.</p>
t o U t	PV				
60 S	SV				
<table border="1"> <tr> <td>VER 1</td> <td>PV</td> </tr> <tr> <td>F</td> <td>SV</td> </tr> </table>	VER 1	PV	F	SV	<p>5. Use the   keys to change “toUt” to “VER1”. 6. Press the  key by looking from VER1 through VER4, you can check the software version.</p>
VER 1	PV				
F	SV				
<table border="1"> <tr> <td>VER 4</td> <td>PV</td> </tr> <tr> <td>R</td> <td>SV</td> </tr> </table>	VER 4	PV	R	SV	<p>7. Press the  key to return to the PV/SV display.</p>
VER 4	PV				
R	SV				

[Setting example] Setting the password for parameter change

Display	Operation procedure				
<table border="1"> <tr> <td data-bbox="108 282 331 349">2 4 5</td> <td data-bbox="331 282 384 349">PV</td> </tr> <tr> <td data-bbox="108 349 331 416">250</td> <td data-bbox="331 349 384 416">SV</td> </tr> </table>	2 4 5	PV	250	SV	<p>1. Check that the PV/SV display is shown.</p>
2 4 5	PV				
250	SV				
<table border="1"> <tr> <td data-bbox="108 490 331 557">CH 1 3</td> <td data-bbox="331 490 384 557">PV</td> </tr> <tr> <td data-bbox="108 557 331 624">PASS</td> <td data-bbox="331 557 384 624">SV</td> </tr> </table>	CH 1 3	PV	PASS	SV	<p>2. Press and hold the SEL key to display CH1 (PID parameters).</p> <p>3. Use the  key to access CH13 (Password parameters).</p>
CH 1 3	PV				
PASS	SV				
<table border="1"> <tr> <td data-bbox="108 698 331 766">PAS 1</td> <td data-bbox="331 698 384 766">PV</td> </tr> <tr> <td data-bbox="108 766 331 833">0000</td> <td data-bbox="331 766 384 833">SV</td> </tr> </table>	PAS 1	PV	0000	SV	<p>4. Press the SEL key to enter CH13 (Password parameters). PAS1 (password1) is displayed.</p>
PAS 1	PV				
0000	SV				
<table border="1"> <tr> <td data-bbox="108 907 331 974">PAS 2</td> <td data-bbox="331 907 384 974">PV</td> </tr> <tr> <td data-bbox="108 974 331 1041">0000</td> <td data-bbox="331 974 384 1041">SV</td> </tr> </table>	PAS 2	PV	0000	SV	<p>5. Use the  keys to change PAS1 to PAS2.</p> <p>6. Press the SEL key. (The first digit of the lower part of the screen begins to blink.)</p>
PAS 2	PV				
0000	SV				
<table border="1"> <tr> <td data-bbox="108 1072 331 1140">****</td> <td data-bbox="331 1072 384 1140">SV</td> </tr> </table>	****	SV	<p>7. Use the   keys to set the password "****".</p> <p>8. Press the SEL key to save the change.</p>		
****	SV				
	<p>9. Press the  key to return to the PV/SV display.</p>				

4 TROUBLESHOOTING

When a trouble occurs, first check the model, wiring, and parameter settings. The following table shows some typical cases and their solutions.

Trouble	Cause	Solution	Reference Ch. Screen No.
Cannot communicate with the host	Parity does not agree.	Make the parity on the host and the unit the same.	No. 763
	Communication speed does not agree.	Make the communication speed on the host and the unit the same.	No. 762
Parameters you want to view do not appear	Display mask is set.	Check the DSP settings.	Ch. 11
	A password is set.	Cancel the password with the master password.	Ch. 13
Control output is not output even with the power turned on	Soft start is set.	Check the soft start settings.	No. 551 No. 553
	The ramp/soak settings have the output turned OFF.	Check the ramp/soak settings.	No. 004 No. 344
	Standby mode is on.	Check the output settings during standby mode.	No. 002 No. 554 No. 555
Keys do not work	Key lock is set to ON.	Check the key lock settings.	No. 028
	SV limit value is set.	Check the SV limit value settings.	No. 059 No. 060
	The USER key settings have changed.	Check the USER key settings.	No. 590 No. 591 No. 592
Channel parameters cannot be displayed	Password is incorrect.	Cancel the password with the master password.	Ch. 13
	Forgot the password.		
SV blinks when power is turned on	FLTF is set.	Check the FLTF settings.	Ch. 12 No. 946
	ALMF is set.	Check the ALMF settings.	Ch. 7 No. 626
Control does not start even if power is turned on	StMd mode is set to manual output.	Check the StMd settings.	

⚠ Caution on Safety

*Before using this product, be sure to read its instruction manual.

 Fuji Electric Co., Ltd.

Global Sales Section

Instrumentation & Sensors Planning Dept.

1, Fuji-machi, Hino-city, Tokyo 191-8502, Japan

<http://www.fujielectric.com>

Phone: +81-42-514-8930 Fax: +81-42-583-8275

<http://www.fujielectric.com/products/instruments/>