

PUR-X 2000 Circulation Heater

The CAS PUR-X replaceable tube circulation heater provides contamination-free heating of liquids and gases.



TARGET MARKETS

- Semiconductor solvent heating
- High-purity liquid heating

SPECIFICATIONS

- **PUR-X 2000:** 5.0kW – 7.9kW, 120V, 200V, 208V, 220V, 230V, 240V, 380V, 400V, 415V, 480V
- Explosion resistant (NEMA 7) electrical enclosure
- Tubing, .375" (3/8") O.D. x .031" wall, field replaceable
 - Standard PFA
 - High purity PFA, SEMI F57 compliant
 - 325" Long (27ft or 8.3m)
 - Tube size & length are the same for both standard PFA & high purity PFA
- Body: Aluminum 319, Teflon®- coated
- Maximum operating temperature: 200°C (392°F)
- Two sensors, for process control and process high-limit, choice of J or K type thermocouples
- Third sensor (J or K type, matching the selected process sensors) for casting & tube protection. Requires independent high limit control loop set no higher than 235°C (455°F)
- Optional insulation jacket
- Optional fittings, PFA 3/8" Straight Union, SEMI F57 compliant
- 70 psi max (480 kPa)

Size and Weight:

- PUR-X 2000: 4.3" O.D. (10.9cm) x 22" (55.9cm) tall, 29 lbs (13.1Kg) (includes housing)

APPLICATIONS

- Semiconductor wet process systems
- Wafer cleaning equipment (wet bench systems)
- Heating of photo-resist removal solvents
- DI water heating for wafer rinsing
- Air and Nitrogen heating for wafer drying
- Acid heating

FEATURES/BENEFITS

- Heating elements cast in aluminum
- Low maintenance
- Teflon®- coated for easy cleaning
- High purity heating
- Fluid path independent of heater sheath
- Non-welded construction
- Self-draining
- Replaceable tubing



CAST ALUMINUM

Solutions

PUR-X 2000

Circulation Heater

TECHNICAL DRAWING

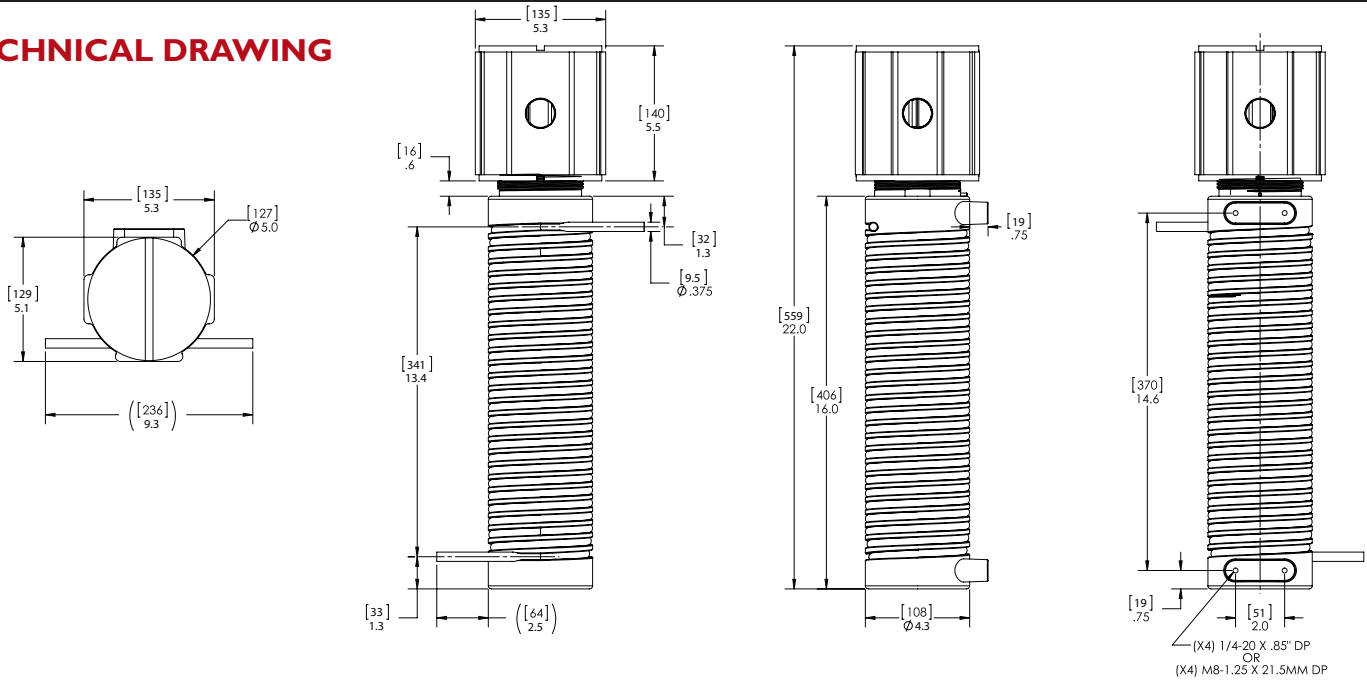

HEATING PROFILE (water) Inlet water 15°C (59°F) at 200°C (392°F) set point with insulation jacket.

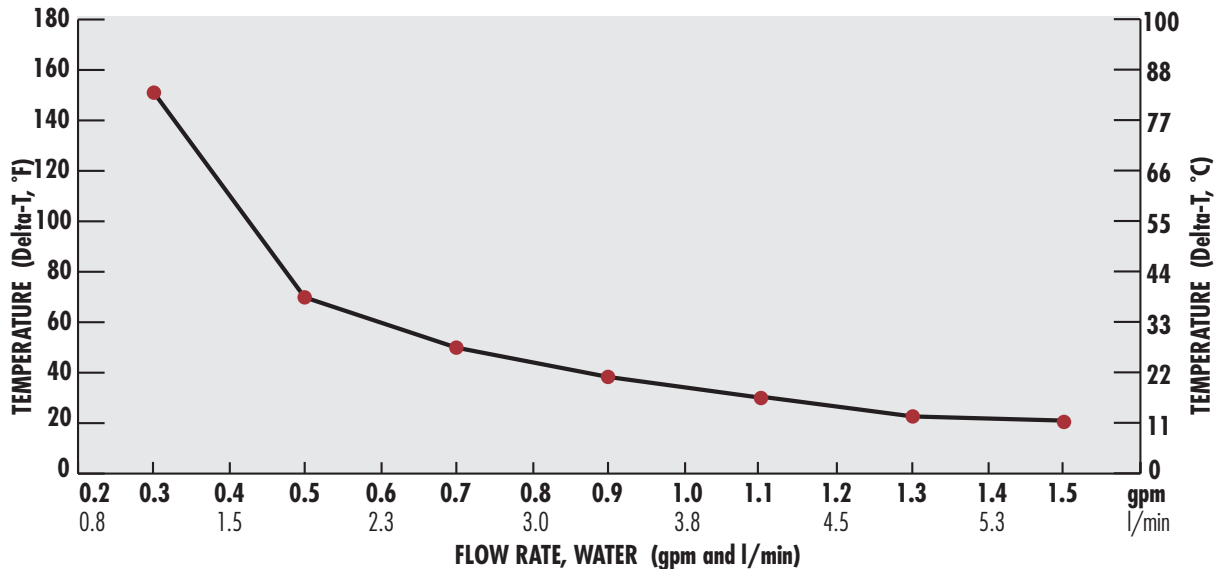

PRESSURE DROP PROFILE (water)

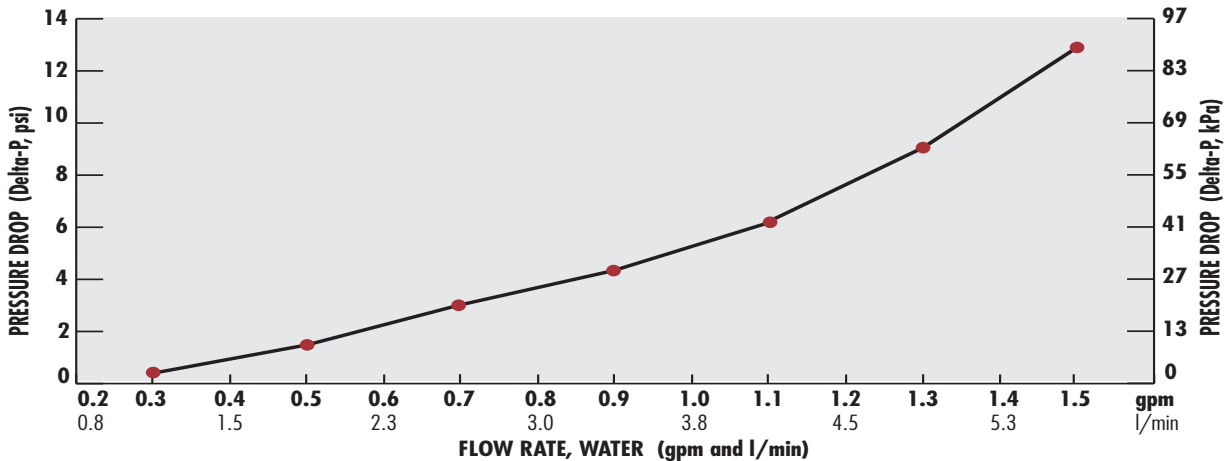

ORDERING INFORMATION

BASE CIRCULATION HEATER	
NEMA 7 ENCLOSURE	
HEATER WATTAGE	
10 = 240V, 3-phase delta circuit 7.9kW 19.3 Amps	
11 = 208V, 3-phase delta circuit 6.0kW 16.7 Amps	
12 = 415V, 3-phase wye circuit 7.9kW 11.1 Amps	
13 = 400V, 3-phase wye circuit 7.4kW 10.7 Amps	
14 = 380V, 3-phase wye circuit 6.6kW 10.2 Amps	
15 = 200V, 1-phase 5.5kW 27.8 Amps	
16 = 208V, 1-phase 6.0kW 28.9 Amps	
17 = 220V, 1-phase 6.7kW 30.5 Amps	
18 = 230V, 1-phase 7.3kW 31.9 Amps	
19 = 480V, 3-phase delta circuit 7.2kW 8.6 Amps	
20 = 415V, 3-phase delta circuit 5.3kW 7.5 Amps	
21 = 400V, 3-phase delta circuit 5.0kW 7.2 Amps	
TUBE MATERIAL	
00 = Standard PFA tubing 3/8" O.D., .031" wall thickness	
01 = High Purity PFA tubing 3/8" O.D., .031" wall (SEMI F57 compliant)	
SENSOR	
JJ = J type thermocouples	
KK = K type thermocouples	
ACCESSORIES (ordered separately, loose packed)	
274-131-1-3 (PFA fitting 3/8" Straight Union, SEMI F57 compliant) 2 pieces	
307-0-18-2 (Insulation Jacket) 1/2" fiberglass insulation, Teflon® coated fiberglass outer cover (rated to 550°F/288°C), Red silicone impregnated fiberglass inner liner, velcro flap fastening, H.T. construction.	
515-68-1-6 replacement PFA tube	
515-68-1-8 replacement HP PFA tube	



PUR-X 2000
with insulation
jacket

WIRING DIAGRAMS

3-PHASE DELTA CIRCUIT

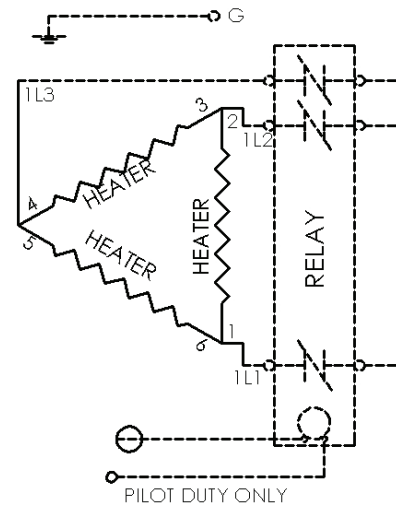

3-PHASE WYE CIRCUIT

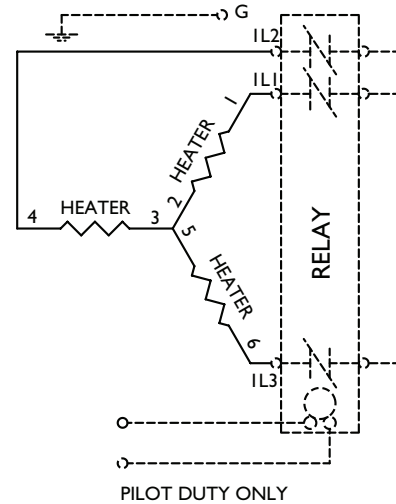

I-PHASE CIRCUIT

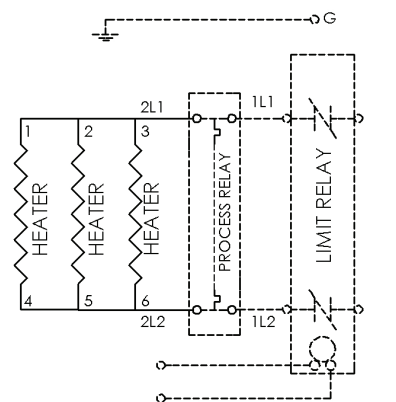

HEATING PROFILE (air) Inlet air at 21°C (70°F) and 70psi; 200°C (392°F) set point with insulation jacket.

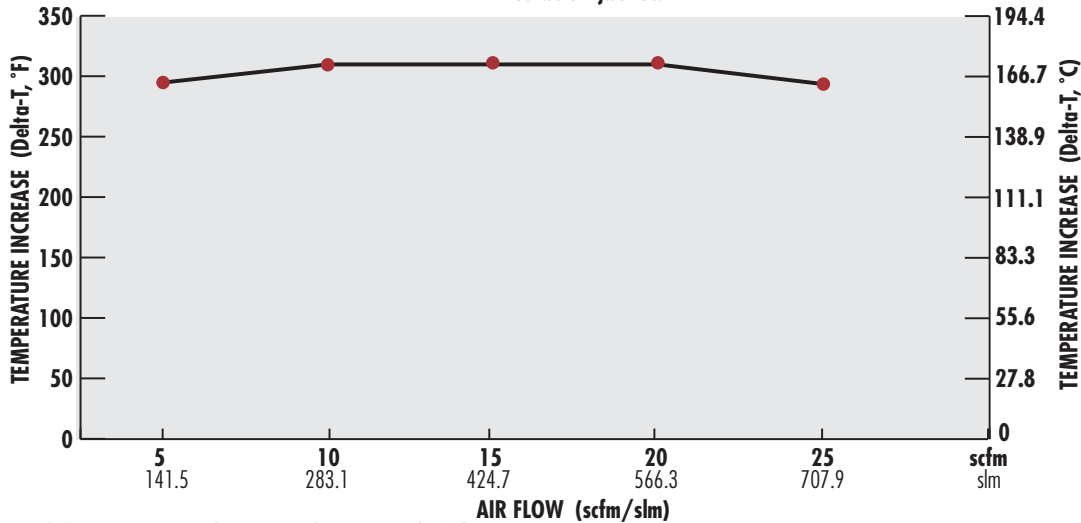

PRESSURE DROP PROFILE (air)

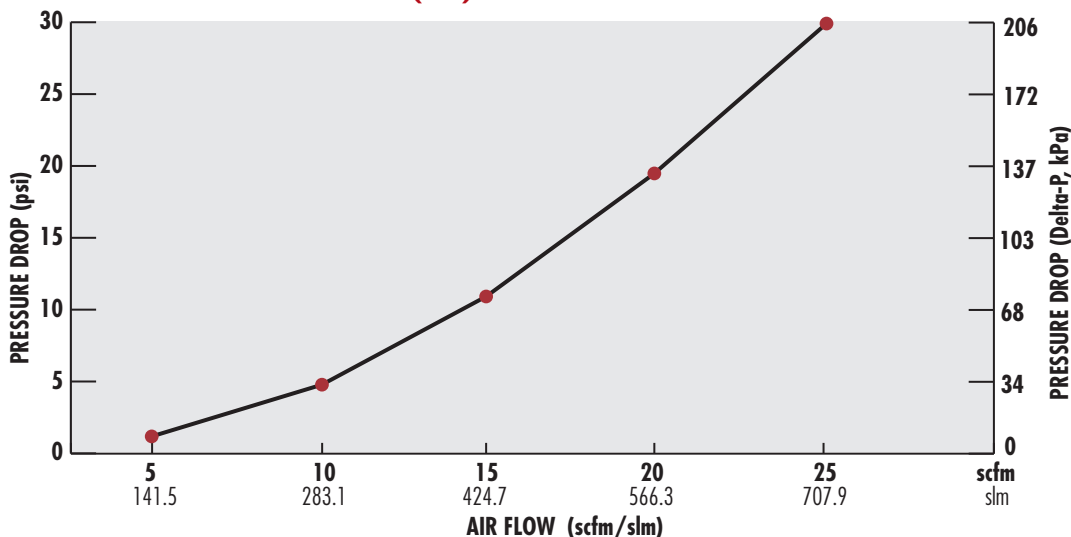

PUR-X 2000

Circulation Heater

COMPETITOR COMPARISON

ATTRIBUTE	PUR-X	COMPETITIVE PRODUCT
Enclosure	Explosion resistant (NEMA 7) electrical enclosure	Requires inert gas purging
Maximum temperature	200°C (392°F)	180°C (356°F)
Heater element / construction	Tubular heating element, cast into aluminum 319. No contact with fluid.	PTFE-sheathed element, in contact with fluid.
Insulation jacket	Optional	Not available
Fluid path	Field-replaceable PFA tubing	Not an isolated fluid path - Body and heater element are in contact with fluid

U.S.A. SALES REPRESENTATIVES

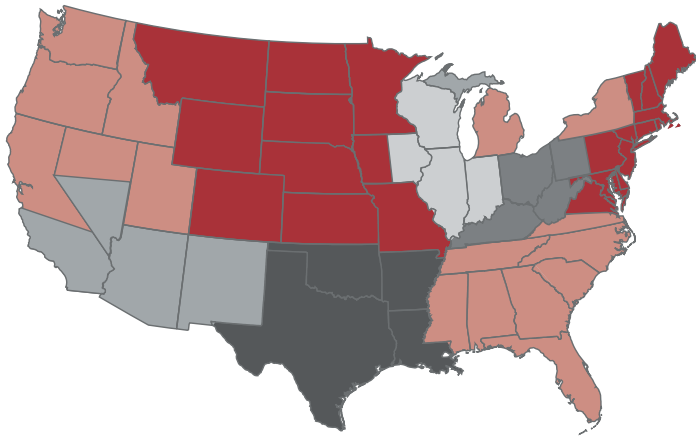

San Francisco
tel: 408-754-3370

Los Angeles
tel: 714-935-2999

Texas
tel: 972-620-6030

**MIDWEST &
WEST CENTRAL CANADA**
tel: 952-892-9222

Chicago
tel: 847-458-1500

**GREAT LAKES,
EASTERN &
CENTRAL CANADA**
tel: 248-651-0500

NORTHEAST
tel: 215-345-8130

SOUTHEAST
tel: 573-754-4806

OHIO VALLEY
tel: 513-398-5500

INTERNATIONAL SALES REPRESENTATIVES

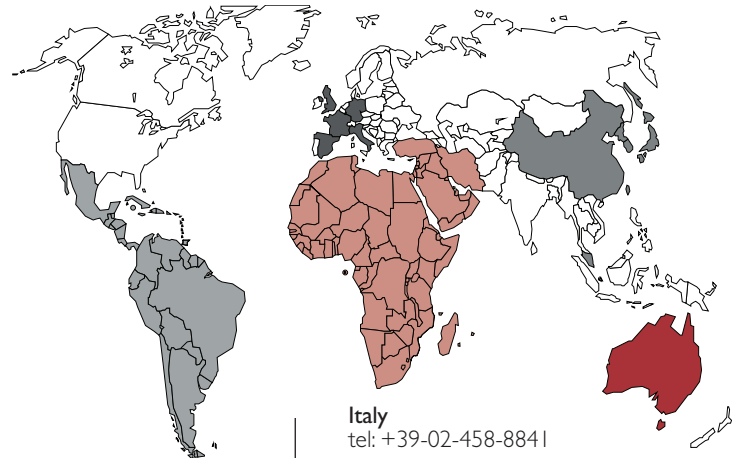

Italy
tel: +39-02-458-8841

Spain
tel: +34-91-675-1292

United Kingdom
tel: +44-115-964-0777

SOUTHEAST ASIA
China
tel: +86-21-3532-8532

Japan
tel: +81-3-3518-6630

Korea
tel: +82-2-2169-2600

Singapore
tel: +65-6773-9488

Taiwan
tel: +866-7-288-5168

India
tel: +91-40-234-12216

AMERICAS
Mexico
Central America
South America
tel: +52-442-256-2200

**AFRICA
MIDDLE EAST**
tel: +20-2-388-9574

AUSTRALIA
tel: +61-3-9335-6449

EUROPE
France
tel: +33 (0) 1-41-32-79-70

Germany
tel: +49-7253-9400-0



CAST ALUMINUM

Solutions

1310 Kingsland Drive Batavia, Illinois 60510 Phone: 888-367-3992 CAS@CastAluminumSolutions.com www.CastAluminumSolutions.com