

# oxy.IQ

## Panametrics Oxygen Transmitter User's Manual





**oxy.IQ**

***Panametrics Oxygen Transmitter***

**User's Manual**

BH024C11 EN G  
April 2023

[panametrics.com](https://panametrics.com)

Copyright 2023 Baker Hughes company.

This material contains one or more registered trademarks of Baker Hughes Company and its subsidiaries in one or more countries. All third-party product and company names are trademarks of their respective holders.

[no content intended for this page]

## Services



Panametrics provides customers with an experienced staff of customer support personnel ready to respond to technical inquiries, as well as other remote and on-site support needs. To complement our broad portfolio of industry-leading solutions, we offer several types of flexible and scalable support services including: Training, Product Repairs, Service Agreements and more.

Please visit <https://www.bakerhughes.com/panametrics/panametrics-services> for more details.

## Information Paragraphs

**Note:** *These paragraphs provide additional information about the topic which is helpful but is not essential to proper completion of the task.*

**IMPORTANT:** These paragraphs provide emphasis to instructions that are essential to proper setup of the equipment. Failure to follow these instructions carefully may cause unreliable performance.



**WARNING!** Indicates a potentially hazardous situation which can result in serious personal injury or death, if it is not avoided.



**CAUTION!** Indicates a potentially hazardous situation which can result in minor or moderate injury to personnel or damage to the equipment, if it is not avoided.

## Safety Issues



**WARNING!** It is the responsibility of the user to make sure all local, county, state and national codes, regulations, rules and laws related to safety and safe operating conditions are met for each installation.



**Attention European Customers!** To meet CE marking requirements for all units intended for use in the EU, all electrical cables must be installed as described in this manual.

## Auxiliary Equipment

### Local Safety Standards

The user must make sure that he operates all auxiliary equipment in accordance with local codes, standards, regulations, or laws applicable to safety.

## Working Area



**WARNING!** Auxiliary equipment may have both manual and automatic modes of operation. As equipment can move suddenly and without warning, do not enter the work cell of this equipment during automatic operation, and do not enter the work envelope of this equipment during manual operation. If you do, serious injury can result.



**WARNING!** Make sure that power to the auxiliary equipment is turned OFF and locked out before you perform maintenance procedures on the equipment.

## Qualification of Personnel

Make sure that all personnel have manufacturer-approved training applicable to the auxiliary equipment.

## Personal Safety Equipment

Make sure that operators and maintenance personnel have all safety equipment applicable to the auxiliary equipment. Examples include safety glasses, protective headgear, safety shoes, etc.

## Unauthorized Operation

Make sure that unauthorized personnel cannot gain access to the operation of the equipment.

## Environmental Compliance

### Waste Electrical and Electronic Equipment (WEEE) Directive

Panametrics is an active participant in Europe's *Waste Electrical and Electronic Equipment* (WEEE) take-back initiative, directive 2012/19/EC.



The equipment that you bought has required the extraction and use of natural resources for its production. It may contain hazardous substances that could impact health and the environment.

In order to avoid the dissemination of those substances in our environment and to diminish the pressure on the natural resources, we encourage you to use the appropriate take-back systems. Those systems will reuse or recycle most of the materials of your end life equipment in a sound way.

The crossed-out wheeled bin symbol invites you to use those systems.

If you need more information on the collection, reuse and recycling systems, please contact your local or regional waste administration.

Please visit [www.bakerhughesds.com/health-safety-and-environment-hse](http://www.bakerhughesds.com/health-safety-and-environment-hse) for take-back instructions and more information about this initiative.

## RoHS

The oxy.iQ fully complies with RoHS regulations (directive 2011/65/EU).



<b>Chapter 1. Features and Capabilities .....</b>	<b>1</b>
1.1 Introduction .....	1
1.2 Hazardous Location Certifications .....	1
1.3 Applications .....	1
1.4 Features .....	2
1.5 Sample Systems .....	3
<b>Chapter 2. Installation .....</b>	<b>5</b>
2.1 Mounting the oxy.IQ .....	5
2.2 Wiring the oxy.IQ .....	7
2.2.1 Longer Cable Lengths .....	7
2.3 Installing an Oxygen Sensor .....	8
<b>Chapter 3. Initial Setup and Operation .....</b>	<b>9</b>
3.1 The oxy.IQ Display and Keypad .....	9
3.2 The oxy.IQ Menu Map .....	9
3.3 Adjusting and Calibrating the oxy.IQ .....	10
3.3.1 Selecting the Output Range .....	10
3.3.2 Trimming the Analog Output .....	10
3.3.2.1 Preparing to Trim the Analog Output .....	10
3.3.2.2 Trimming the Analog Output Low (4 mA) End .....	10
3.3.2.3 Trimming the Analog Output High (20 mA) End .....	11
3.3.2.4 Completing the Trim Procedure .....	11
3.3.3 Air Calibration .....	11
3.3.3.1 Calibrating a New Sensor .....	11
3.3.3.2 Recalibrating an Existing Sensor .....	12
3.3.4 Span Gas Calibration .....	12
<b>Chapter 4. User Programming .....</b>	<b>13</b>
4.1 Introduction .....	13
4.2 The Calibration Menu .....	13
4.2.1 Air .....	13
4.2.2 Span Gas .....	13
4.2.3 Sensor Life .....	13
4.3 The Display Menu .....	14
4.3.1 Select the O <sub>2</sub> Parameter .....	14
4.3.2 Display the Sensor Range .....	14
4.3.3 Adjust the Contrast .....	14
4.4 The Output Menu .....	15
4.4.1 Range .....	15
4.4.2 Trim .....	15
4.4.3 Error Type .....	15
4.4.4 Error Output .....	16
<b>Chapter 5. The Service Menu .....</b>	<b>17</b>
5.1 Menu Map and Service Passcode .....	17
5.2 Entering the Service Menu .....	17
5.2.1 Diagnostics .....	17
<b>Chapter 6. Specifications .....</b>	<b>19</b>
6.1 Intrinsically Safe (IS) Installation .....	19
6.1.1 Power requirements .....	19
6.1.2 Cable .....	19
6.1.3 Output .....	19
6.2 Non-incendive (div 2) and general purpose installation .....	19
6.2.1 Power requirements .....	19
6.2.2 Cable .....	19



6.3	All Installations.....	19
6.3.1	Process Wetted Materials .....	19
6.3.2	User-Selectable Measurement Ranges.....	19
6.3.3	Accuracy .....	19
6.3.4	Repeatability .....	20
6.3.5	Resolution .....	20
6.3.6	Linearity .....	20
6.3.7	O2 Sensor Operating Temperature .....	20
6.3.8	Sample Pressure .....	20
6.3.9	Atmospheric Pressure Effect.....	20
6.3.10	Process Connection .....	20
6.3.11	Dimensions.....	20
6.3.12	Weight .....	20
6.3.13	Sample Flow Rate .....	20
6.3.14	Electrical Classification .....	20
6.3.15	European Compliance.....	21
6.4	Storage.....	21
6.5	Product label .....	21
	<b>Appendix A. Outline and Installation Drawings .....</b>	<b>23</b>
	<b>Appendix B. Menu Maps .....</b>	<b>31</b>
	<b>Appendix C. Order String.....</b>	<b>33</b>
	<b>Appendix D. Certification and safety statements.....</b>	<b>35</b>
	<b>Appendix E. Cell Models.....</b>	<b>39</b>
E.1	Oxygen Sensors Chemical Compatibility Chart.....	39
E.1	Oxygen Concentration Range of Different Cell Models.....	41
	<b>Index.....</b>	<b>45</b>

# Chapter 1. Features and Capabilities

## 1.1 Introduction

The **oxy.IQ** Panametrics Oxygen Transmitter (see Figure 1 below) is a highly reliable and cost-effective two-wire, loop-powered transmitter with a linearized 4 to 20 mA output. It measures oxygen content in ten ppm ranges (10, 20, 50, 100, 200, 500, 1000, 2000, 5000 and 10000 ppm) and eight percentage ranges (1, 2, 5, 10, 21, 25, 50 and 100%). All ranges are user-selectable. This compact transmitter uses proven sensor technology to accurately measure O<sub>2</sub> in a variety of gases, even in hazardous (classified) locations.



Figure 1: oxy.IQ

## 1.2 Hazardous Location Certifications

When equipped with an optional Zener barrier or galvanic isolator, the oxy.IQ can be mounted in a hazardous (classified) location. The oxy.IQ with intrinsically safe option is certified to USA, Canadian, ATEX, and international IECEx IS requirements. The standard oxy.IQ is certified to USA, Canadian, EU ATEX and International IECEx div2/Zone 2 non-incendive requirements.

## 1.3 Applications

Some typical applications for the **oxy.IQ** Panametrics oxygen transmitter include the following:

- Glove box purge and leak detection
- Natural gas
- Semiconductor wafer machines
- Coating process machines
- Membrane air separators
- Inert welding gases
- Pure gaseous hydrocarbon streams
- Process monitoring of gaseous monomers
- Heat treating and bright annealing

## 1.4 Features

The **oxy.IQ** oxygen sensor is an advanced galvanic fuel cell that provides superior performance, accuracy, stability and long life. The cell's innovative design eliminates the potential for negative signal output and reduces sources of contamination. The different types of cells used with the oxy.IQ are listed in Table 1 below. Refer to Table 6 on page 41 for the concentration ranges for each type of cell.

**Table 1: Types of cells used with the oxy.IQ**

Ordering part no.	Recommended for
OX-1	Low range ppm measurement, standard background gases
OX-2	Low range ppm measurement, acid background gases
OX-3	Percent measurement, standard background gases
OX-4	Percent measurement, acid background gases
OX-5	Low/mid-range ppm measurement, standard background gases

The cell is unaffected by other background gases or hydrocarbons and is compatible with acidic gases (**OX-2** and **OX-4** cells). Recovery from air at low ppm levels takes just a few minutes. Because the cell is self-contained, minimal maintenance is required. There is no electrolyte to change and no electrodes to clean. Refer to Appendix E: Cell Models, for more information on the different cell models compatible with oxy.IQ.

The **oxy.IQ** offers the following features:

- Two-wire, loop-powered, 4 to 20 mA transmitter
- Display with keypad
- Intrinsically-safe option
- Proven galvanic fuel cell O<sub>2</sub> sensor technology
- User-selectable ranges for ppm and percent oxygen
- User-friendly and intuitive user interface with diagnostics
- Microprocessor-based, all-digital technology for reliable operation
- Low maintenance, economical and compact
- Sensor failure output error
- Sensor lifetime indication
- NAMUR error indication

## 1.5 Sample Systems

In addition to the standard features and options, Panametrics offers a full line of sample handling systems for a variety of applications. If needed, Panametrics can design and build a sample conditioning system to meet unique application requirements. Please contact Panametrics for details. *Table 2* below lists some background gases that can interfere with the oxygen sensor.

**Table 2: Oxygen Sensor Interference Gases**

Gas	OX-1 & 5 ppm	OX-2 ppm	OX-3 %		OX-4 %	
	Cont.	Cont.	Cont.	Int. (1)	Cont.	Int.
H <sub>2</sub> S	<5 ppm	<10 ppm	0.0005 %	0.01 %	0.001 %	0.1 %
SO <sub>3</sub>	<10 ppm	<10 ppm	0.01 %	0.1 %	0.01 %	0.1 %
SO <sub>2</sub>	<10 ppm	(3)	0.01 %	0.1 %	(3)	(3)
HCl	<1000 ppm	(3)	0.1 %	1.0 %	(3)	(3)
HCN	<1000 ppm	(3)	0.1 %	1.0 %	(3)	(3)
CO <sub>2</sub>	<1000 ppm	(3)	0.1 %	20 &	(3)	(3)
NO <sub>2</sub>	(2)	(2)	(2)	(2)	(2)	(2)
Cl <sub>2</sub>	(2)	(2)	(2)	(2)	(2)	(2)

Cont. = Continuous, Int. = Intermittent  
 (1) Recommended maximum exposure 30 minutes, followed by flushing with ambient air for an equal period.  
 (2) Minimal effect on sensor performance, but produces signal interference of 1:2 ratio for ppm levels only (e.g., 100 ppm NO<sub>2</sub> looks like 200 ppm O<sub>2</sub>).  
 (3) Minimal effect on sensor performance

[no content intended for this page]

## Chapter 2. Installation

### 2.1 Mounting the oxy.IQ

To install the **oxy.IQ** into the process or sample system, refer to *Figure 9 on page 24* or *Figure 2 below* and proceed to the next page.

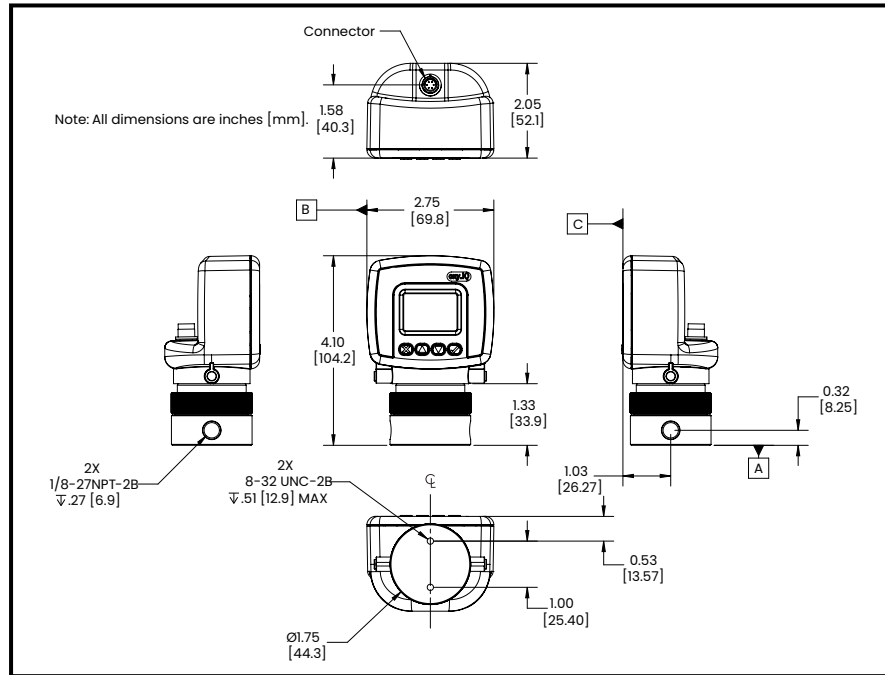

**Figure 2: Outline and Installation Drawing**

**Note:** To avoid collecting condensate that may damage the oxygen sensor, mount the oxy.IQ in an upright position, with the sensor manifold below the electronics module.

Install the oxy.IQ by completing the following steps:

1. Remove the oxy.IQ and the separately-packaged oxygen sensor (see *Figure 3* below) from the shipping container. Keep the shipping container and packaging material for possible future use.

**IMPORTANT:** DO NOT open the oxygen sensor package until you are ready to install the sensor.

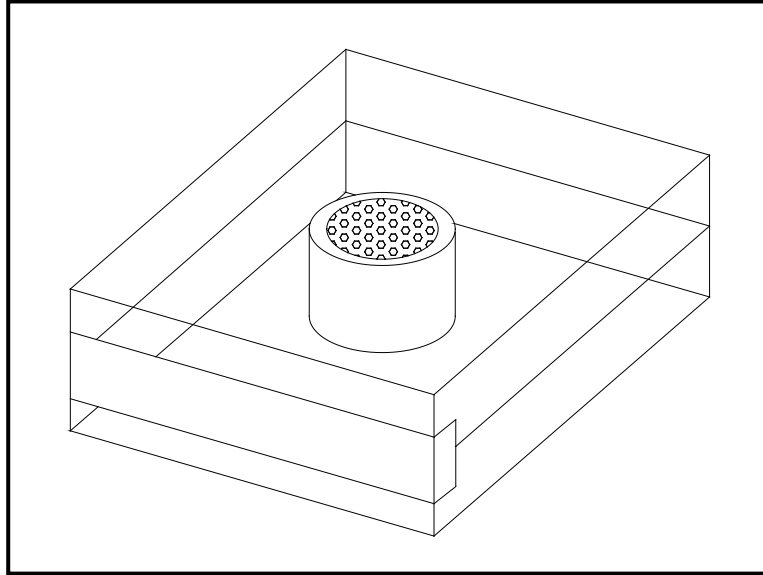
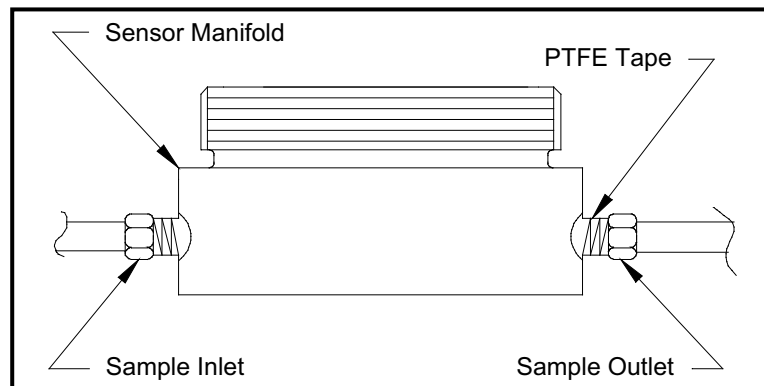

**Figure 3: Packaged Oxygen Sensor**

2. Remove the sensor manifold by unscrewing it from the blue knurled nut on the sensor base at the bottom of the electronics module.

**IMPORTANT:** The maximum operating sample pressure for the oxy.IQ is 10 psig except when the ambient air adapter is used for the sample manifold. The burst pressure of the sample manifold is 200 psig for all bases except the ISO KF-40 flange adapter. Since this option is designed for a vacuum flange it cannot handle sample pressure greater than 20 psig. Be sure the sample conditioning system is designed to maintain the oxy.IQ pressure below these limits, and that the oxy.IQ outlet is vented to atmosphere during operation and calibration.

3. Using PTFE tape as a sealant, connect the sample gas inlet and outlet to the 1/8" NPT ports on the sensor manifold (see *Figure 4* below). Either port may be used as the inlet or the outlet, as the direction of flow does not matter.



**Figure 4: Sensor Manifold Installation**

## 2.2 Wiring the oxy.IQ

To wire the oxy.IQ, refer to *Figure 14 on page 28*, then proceed as follows:



**WARNING!** For IS (Intrinsically Safe) applications, the oxy.IQ must be installed with a zener barrier (see the top of *Figure 14 on page 28*). Also, for installations in a hazardous location, the blue IS cable (p/n 704-1318-02, 10) must be used.

1. Attach the appropriate cable to the oxy.IQ (see *Figure 5 below*). Be sure to align the white arrow on the cable connector with the white arrow on the oxy.IQ connector, and then push the top of the cable connector straight down onto the mating connector on the rear of the electronics module until you hear it click into place.

**IMPORTANT:** Do not rotate the cable connector during installation (it is not threaded) and do not hold the connector by its bottom section while pushing it down into place.

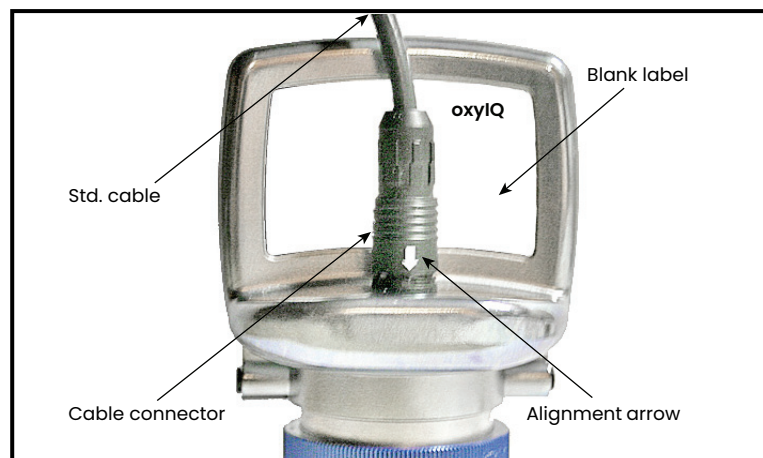

**Figure 5: oxy.IQ Cable and Connector**

2. Connect the flying lead end of the cable as shown in the wiring diagram, according to one of the following conditions:
  - **No Zener barrier or galvanic isolator:** For use in non-hazardous areas or div 2 hazardous areas.
  - **With Zener barrier or galvanic isolator:** Required for use in hazardous areas.

**IMPORTANT:** To remove the cable from the oxy.IQ electronics module, simply pull straight up on the lower section of the cable connector as close to the oxy.IQ body as possible. Do not pull on the cable or the upper portion of the cable connector, and do not try to unscrew the cable connector.

### 2.2.1 Longer Cable Lengths

Panametrics offers cables in 2 m and 10 m standard lengths. Longer cable lengths may be used with the oxy.IQ, but these are not available from Panametrics. If you require a longer cable, refer to the following figures for the required cable specifications and construct your own cable for splicing onto the standard Panametrics cable:

- Standard cable: figure 10 and figure 11.
- IS cable: figure 12 and figure 13.



## 2.3 Installing an Oxygen Sensor

To install a new or replacement oxygen sensor in the oxy.IQ, refer to figure 6 below and complete the following steps:

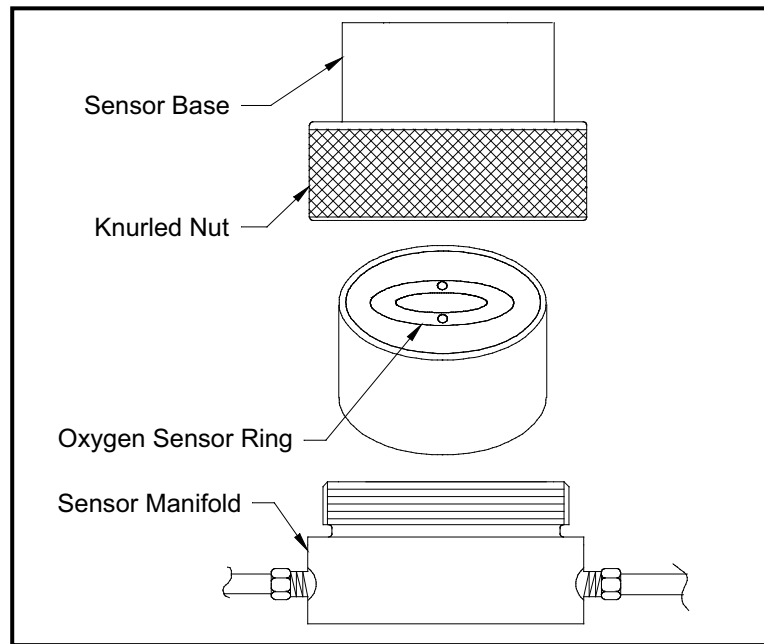

**Figure 6: Oxygen Sensor Installation**

1. Disconnect the power from the oxy.IQ.
2. Loosen the blue knurled nut and remove the oxy.IQ electronics module from the sensor manifold. If a previous oxygen sensor is already in place, remove and discard it.
3. Apply power to the unit. The screen will display "INITIALIZING PLEASE WAIT" for a few seconds before it begins to display measurement data.

**Note:** Before continuing with the installation, become familiar with the procedures for programming and calibrating the oxy.IQ discussed in Chapter 3, Initial Setup and Operation.

4. Trim the 4-20 mA analog output and set the range to 0-25% oxygen.
5. Open the airtight package (see figure 3) and remove the oxygen sensor from the package. To maintain the oxygen sensor's energy level, remove the red grounding tab and immediately install the sensor in the oxy.IQ
6. Orient the sensor so that its gold-plated electrodes are facing the spring-loaded contact pins in the sensor base (see figure 6). Firmly press the oxygen sensor into the sensor base at the bottom of the oxy.IQ electronics module.
7. Perform an air calibration on the new oxygen sensor at this time. On the 0-25% oxygen scale, a properly calibrated oxygen sensor shows a reading of 20.9% on the display and generates a current of 17.4 mA at the 4-20 mA analog output terminals.
8. Using the blue knurled nut, attach the oxy.IQ electronics module with the calibrated oxygen sensor to the sensor manifold. Rotate the display as desired and then hand-tighten the blue knurled nut.

**IMPORTANT:** Make sure that the o-ring on the top of the sensor manifold is in place and undamaged. If necessary, contact Panametrics for a replacement.

9. Begin the flow of the process gas. The analog output reading will drop as the oxygen sensor adjusts to the reduced oxygen level. During this time, reset the range as required.
10. For improved accuracy in the ppm oxygen ranges, a span gas calibration should now be performed (see "span gas calibration").

**IMPORTANT:** Sensor life is dependent on the application. High oxygen concentrations and contaminants such as acidic gases will shorten the sensor life.

## Chapter 3. Initial Setup and Operation





### 3.1 The oxy.IQ Display and Keypad

All programming of the **oxy.IQ** is done via the front panel keypad and display, as illustrated below.



**Figure 7: oxy.IQ Display and Keypad**

The front panel components perform the following functions:

- **Display** - Data measurements and the programming menus and options are shown on the LCD display screen.
-  **Enter** - While in measurement mode, press this key to enter the *Main Menu*. While in the *Main Menu*, press this key to save an entry and advance to the next screen.
-  **Cancel** - While in the *Main Menu*, press this key to cancel an entry and to return to the previous screen.
-  and  **Keys** - In the *Main Menu*, use these keys to move the cursor between rows one row at a time in the direction indicated.

### 3.2 The oxy.IQ Menu Map

As an aid in navigating through the main menu, a complete menu map of the user program is shown in figure 16. Refer to this figure as needed while programming the oxy.IQ.

- The oxy.IQ main menu consists of the following submenus:
  - Calibration menu (no passcode required)
  - Display menu (no passcode required)
  - Output menu (no passcode required)
  - Service menu (factory service passcode required)

To enter the *Main Menu* from normal display mode, simply press the  **Enter** key at any time. To leave the *Main Menu* and return to measurement mode, press the  **Cancel** key.

**Note:** Depending on how deep you are in the menu structure, it may be necessary to press the  **Cancel** key more than once to return all the way back to measurement mode.







### 3.3 Adjusting and Calibrating the oxy.IQ

Upon startup, the following five-step adjustment and calibration procedure must be performed on the oxy.IQ:

1. Select the desired output range.
2. Trim the low (4 mA) and high (20 mA) analog outputs.
3. Upon installation of a new oxygen sensor, calibrate the unit with air for either a ppm or % sensor.
4. For ppm sensors only, purge the sensor with a low ppm oxygen gas.
5. For all subsequent calibrations, use a span gas that is appropriate for the sensor and range selected.

#### 3.3.1 Selecting the Output Range

To select the desired measurement range, complete the following steps:

1. Press the  **Enter** key to enter the *Main Menu*.
2. Press the  key twice and then press the  **Enter** key to enter the *Output* menu.
3. Press the  **Enter** key to select the *Range* menu option.
4. Use the  and  keys to scroll through the available options, as listed in *Table 3* below.

**Table 3: Available Output Ranges**

Units	Span Value
% O <sub>2</sub>	1, 2, 5, 10, 21, 25, 50, 100
ppm O <sub>2</sub>	10, 20, 50, 100, 200, 500, 1000, 2000, 5000, 10000

5. After selecting the desired output range, press the  **Enter** key to save the selection. Then, press the  **Cancel** key to return to the *Output* menu.





#### 3.3.2 Trimming the Analog Output

To trim the analog output, calibrate the low (4 mA) end of the output then the high (20 mA) end of the output.





**IMPORTANT:** The 4 mA and 20 mA adjustments interact with each other. Therefore, recheck the trim after the procedure has been completed.

##### 3.3.2.1 Preparing to Trim the Analog Output

Prepare to trim the analog output as follows:

1. Connect an ammeter in series with the positive oxy.IQ power supply lead, to monitor the analog output current.
2. Press the  **Enter** key to enter the *Main Menu*.
3. Press the  key twice and then press the  **Enter** key to enter the *Output* menu.
4. Press the  key and then press the  **Enter** key to enter the *Trim* menu.

##### 3.3.2.2 Trimming the Analog Output Low (4 mA) End

1. Press the  **Enter** key to enter the 4 mA *Trim* menu, and the analog output is driven to about 4 mA.
2. Use the  and  keys to adjust the analog output up or down, until it equals  $4.00 \pm 0.01$  mA.
3. Press the  **Enter** key to save the trim adjustment and return to the *Trim* menu.

### 3.3.2.3 Trimming the Analog Output High (20 mA) End

1. Press the ▼ key and then press the ✓ Enter key to enter the 20 mA *Trim* menu, and the analog output is driven to about 20 mA.
2. Use the ▲ and ▼ keys to adjust the analog output up or down, until it equals  $20.00 \pm 0.01$  mA.
3. Press the ✓ Enter key to save the trim adjustment and return to the *Trim* menu.

### 3.3.2.4 Completing the Trim Procedure

1. Repeat both the low (4 mA) end and high (20 mA) end analog output trimming steps until no further trimming adjustments are required.
2. Press the ✕ Cancel key twice to return to the *Main Menu*.

### 3.3.3 Air Calibration

An air calibration is always recommended upon installation of a new oxygen sensor. However, because of the non-linearity of the oxygen sensor, a span gas calibration (see the next section) should also be performed to ensure more accurate readings in the ppm ranges.



**CAUTION!** The useful life of ppm sensors will be extended by minimizing exposure of the sensor to air.

To perform an air calibration, complete the following steps:

1. Press the ✓ Enter key to enter the *Main Menu*.
2. Press the ✓ Enter key to enter the *Calibration* menu.
3. Press the ✓ Enter key to select the *Air* menu option.

Proceed to the appropriate section, depending on whether you are calibrating a new sensor or recalibrating an existing sensor.

#### 3.3.3.1 Calibrating a New Sensor



For a new sensor, continue the air calibration procedure as follows:

1. Press the ▼ key and then press the ✓ Enter key to select the *YES* menu option.
2. Press the ✓ Enter key to acknowledge that you are resetting the *sensor lifetime clock*.
3. As instructed, remove the sensor manifold to expose the new oxygen sensor to ambient air for about two minutes. Then, press the ✓ Enter key to continue.
4. A message indicating that the calibration is in progress will be displayed, and then the calibration data will be shown. At that time, press the ✓ Enter key to save the calibration data and return to measurement mode.

**Note:** A second calibration of the new sensor should be performed within 1-2 days of the first calibration.

### 3.3.3.2 Recalibrating an Existing Sensor

For an existing sensor, continue the air calibration procedure as follows:

1. Press the  **Enter** key to select the *NO* menu option.
2. As instructed, remove the sensor manifold to expose the oxygen sensor to ambient air for about two minutes. Then, press the  **Enter** key to continue.
3. A message indicating that the calibration is in progress will be displayed, and then the calibration data will be shown. At that time, press the  **Enter** key to save the calibration data and return to measurement mode.

### 3.3.4 Span Gas Calibration









Before beginning the span gas calibration, make sure the oxy.iQ is indicating an O<sub>2</sub> level less than the span gas value, to ensure an accurate calibration. Then, start the flow of the span gas to the sensor. For accurate calibration, the span gas should have an oxygen content of 70-90% of the range being calibrated.

To perform the span calibration, complete the following steps:

1. Use the equation below to calculate the expected mA output that corresponds to the known oxygen content of the span gas:

$$4.0 + 16.0 \times \frac{\text{Span Gas ppm}}{\text{Full Range ppm}} = \text{mA Output}$$

For example, if the span gas contains 80 ppm oxygen and the 0-100 ppm range is being calibrated, the analog output should equal  $4 + 16 \times (80/100) = 16.8$  mA.

2. If you have not done so already, start the flow of span gas to the sensor and allow both the 4-20 mA output reading and the display reading to stabilize.
3. After the reading has stabilized, press the  **Enter** key to enter the *Main Menu*.
4. Press the  **Enter** key to enter the *Calibration* menu.
5. Press the  key and then press the  **Enter** key to select the *Span Gas* menu option.
6. Press the  and  keys until the measurement agrees with the span calibration gas value.
7. Confirm that the reading on the display has stabilized, and press the  **Enter** key to save the calibration. Then, press the  **Cancel** key twice to return to measurement mode.

## Chapter 4. User Programming

### 4.1 Introduction

**IMPORTANT:** The oxy.IQ service menu is for use by qualified service personnel only and requires a special passcode for access. That menu is not discussed in this chapter.

This chapter provides instructions for programming all of the oxy.IQ menu options available to the user, which can be accessed without the use of a passcode. These menu options are found in the following main menu submenus:

- Calibration menu
- Display menu
- Output menu
- While programming these menus, refer to the menu map in figure 16.

**Note:** *The menu options for initial setup are described in chapter 3, Initial setup and operation, and are only referenced in this chapter.*

### 4.2 The Calibration Menu

Proceed to the appropriate section to program the desired menu option.

#### 4.2.1 Air







See “Air Calibration” on page 11.

#### 4.2.2 Span Gas

See “Span Gas Calibration” on page 12.

#### 4.2.3 Sensor Life

To read the sensor life, complete the following steps:







1. Press the  **Enter** key to enter the *Main Menu*.
2. Press the  **Enter** key to enter the *Calibration* menu.
3. Press the  key three times and then press the  **Enter** key to enter the *Sensor Life* menu.
4. The number of days your sensor has been in use is displayed. When you have finished reading the information, press the  **Enter** key to return to the *Calibration* menu.
5. Press the  **Cancel** key twice to return to measurement mode.

## 4.3 The Display Menu

Proceed to the appropriate section to program the desired menu option.









### 4.3.1 Select the O<sub>2</sub> Parameter

To select the O<sub>2</sub> parameter for display, complete the following steps:

1. Press the  **Enter** key to enter the *Main Menu*.
2. Press the  key once and then press the  **Enter** key to enter the *Display* menu.
3. Press the  **Enter** key to enter the O<sub>2</sub> menu.
4. Use the  and  keys to select the desired O<sub>2</sub> range to be displayed:
  - ppm only
  - % only
  - Auto Select (automatically displays the appropriate range)
5. Press the  **Enter** key to confirm your choice and return to measurement mode.







### 4.3.2 Display the Sensor Range

To select whether or not the O<sub>2</sub> range of the installed sensor is displayed, complete the following steps:

1. Press the  **Enter** key to enter the *Main Menu*.
2. Press the  key once and then press the  **Enter** key to enter the *Display* menu.
3. Press the  key once and then press the  **Enter** key to enter the *Display Range* menu.
4. Use the  and  keys to select the desired option:
  - On - the O<sub>2</sub> range is displayed at the bottom of the screen
  - Off - the O<sub>2</sub> range is not displayed at the bottom of the screen
5. Press the  **Enter** key to confirm your choice and return to measurement mode.

### 4.3.3 Adjust the Contrast

To adjust the display contrast, complete the following steps:

1. Press the  **Enter** key to enter the *Main Menu*.
2. Press the  key twice and then press the  **Enter** key to enter the *Contrast* menu.
3. Use the  and  keys to adjust the contrast to the desired value, then press the  **Enter** key to save the new value.
4. Press the  **Cancel** key twice to return to measurement mode.

## 4.4 The Output Menu

Proceed to the appropriate section to program the desired menu option.

### 4.4.1 Range









See “Selecting the Output Range” on page 10.

### 4.4.2 Trim

See “Trimming the Analog Output” on page 10.

### 4.4.3 Error Type

To select the process conditions that will activate an on-screen warning and send an alarm to the analog output device, complete the following steps:

1. Press the  **Enter** key to enter the *Main Menu*.
2. Press the  key twice and then press the  **Enter** key to enter the *Output* menu.
3. Press the  key twice and then press the  **Enter** key to enter the *Error Type* menu.
4. Use the  and  keys to select the desired option and then press the  **Enter** key to activate that error type. A check mark will appear next to the selected option to indicate that it is activated. The following options are available, and you may activate as many of these options as you wish.

**Note:** Only the first four options are displayed on the screen upon entering this menu. When you scroll down to the fourth option (low temp), a down arrow to the right of this option indicates that an additional screen of options is available.

- High O<sub>2</sub> (Fixed value of >25%, regardless of selected range)
- Low O<sub>2</sub> (programmable)
- High temp
- Low temp (programmable)
- Temp comp (listed on second screen of options)









**Note:** Pressing the  **Enter** key on an error type that has already been activated, will deactivate that option and remove the check mark.

5. Press the  **Cancel** key three times to return to measurement mode.





#### 4.4.4 Error Output

To select the desired output value that will be sent to the analog output device upon an error, complete the following steps:

1. Press the  **Enter** key to enter the *Main Menu*.
2. Press the  key twice and then press the  **Enter** key to enter the *Output* menu.
3. Press the  key three times and then press the  **Enter** key to enter the *Error Output* menu.
4. Use the  and  keys to select the desired option and then press the  **Enter** key to activate that error output. A check mark will appear next to the selected option to indicate that it is activated. The following options are available, and you may activate only one option at a time.

**Note:** *In order to implement the Namur output, two settings must be changed:*

1. Set the output error type to low O<sub>2</sub> (Main Menu → Output → Error type → Low O<sub>2</sub> → Enter ).
2. Activate the NAMUR over the Error output menu and select NAMUR (Main Menu → Output → Error output → NAMUR → Enter .

**Note:** *Only the first four options are displayed on the screen upon entering this menu. When you scroll down to the fourth option (NAMUR), a down arrow to the right of this option indicates that an additional screen of options is available.*

- None (no error output is generated)
- Low (an output below 4 mA is generated)
- High (an output above 20 mA is generated)
- Value (an error output at a programmable fixed value is generated)
- NAMUR (listed on second screen of options)

**Note:** *Pressing the  **Enter** key on a different error output will automatically deselect any previously selected output.*

3. Press the  **Cancel** key three times to return to measurement mode.

## Chapter 5. The Service Menu



**CAUTION!** The *Service Menu* is intended for use by qualified service personnel only, and access to this menu requires entry of the service passcode. Misuse of the information in this menu may significantly impair the accuracy and performance of your oxy.IQ and may cause it to fail to meet its published specifications.







### 5.1 Menu Map and Service Passcode

For help in navigating through the *Service Menu*, refer to the menu map shown in *Figure 17 on page 32*. The service passcode required for access to the oxy.IQ *Service Menu* is:

**7378**

### 5.2 Entering the Service Menu

To enter the *Service Menu*, complete the following steps:



1. Press the  **Enter** key to enter the *Main Menu*.
2. Press the  key three times and then press the  **Enter** key to select the *Service* menu.
3. Use the  and  keys to increment or decrement the displayed value (default = 5000) to enter the service passcode, and then press the  **Enter** key to access the *Service* menu.



**Note:** When entering the passcode, press and release an arrow key to change the value one digit at a time, or press and hold an arrow key to change the value at an accelerating rate.

4. Proceed to the appropriate section for the desired menu option.



#### 5.2.1 Diagnostics

To enter the *Diagnostics* menu option from the *Service Menu*, complete the following steps:

1. Use the  and  keys as necessary to highlight the *Diagnostics* menu option.
2. Press the  **Enter** key to enter the *Diagnostics* menu.
3. *Page 1* of the *Diagnostics* option displays the current values for the following parameters:
  - O<sub>2</sub>  $\mu$ A
  - Output mA
  - Output %

When you have finished reading the information, press the  **Enter** key to move to *Page 2* of the *Diagnostics* menu or press the  **Cancel** key to exit the *Diagnostics* menu.

4. *Page 2* of the *Diagnostics* option displays the current values for the following parameters:
  - Temp °C
  - Temp Res
  - Gain
  - OX-n (currently installed sensor type, n = 1, 2, 3 or 4)

When you have finished reading the information, press the  **Enter** key to move to *Page 1* of the *Diagnostics* menu or press the  **Cancel** key to exit the *Diagnostics* menu.

5. Press the  **Cancel** key twice to return to measurement mode.

[no content intended for this page]

## Chapter 6. Specifications

### 6.1 Intrinsically Safe (IS) Installation

Intrinsically safe installations require an MTL7706 Zener barrier, one IS cable, and one non-IS cable.

#### 6.1.1 Power requirements

24 to 28 VDC at 50 mA

#### 6.1.2 Cable

P/N 704-1318-02 (2 m length) or p/n 704-1317-10 (10 m length) blue jacketed, twisted-pair with connector, 26 AWG conductors, with connector

#### 6.1.3 Output

Total load must equal 250  $\pm$ 5% when using a Zener barrier

### 6.2 Non-incendive (div 2) and general purpose installation

No Zener barrier or galvanic isolator is used.

#### 6.2.1 Power requirements

9 to 28 VDC, loop-powered, 0.7 W max

#### 6.2.2 Cable

P/N 704-1317-02 (2 m length) or p/n 704-1317-10 (10 m length) black jacketed, twisted-pair with connector, 26 AWG conductors, with connector

### 6.3 All Installations

#### 6.3.1 Process Wetted Materials

SS process unit: 316 stainless steel, Viton® o-ring, gold-plated sensor electrical contacts, and glass

#### 6.3.2 User-Selectable Measurement Ranges

- *PPM sensors:*
  - 0 to 10 ppm<sub>v</sub> O<sub>2</sub> (OX-1 or OX-2 only)
  - 0 to 20 ppm<sub>v</sub> O<sub>2</sub> (OX-1 or OX-2 only)
  - 0 to 50 ppm<sub>v</sub> O<sub>2</sub> (OX-1 or OX-2 only)
  - 0 to 100 ppm<sub>v</sub> O<sub>2</sub>
  - 0 to 200 ppm<sub>v</sub> O<sub>2</sub>
  - 0 to 500 ppm<sub>v</sub> O<sub>2</sub>
  - 0 to 1000 ppm<sub>v</sub> O<sub>2</sub>
  - 0 to 2000 ppm<sub>v</sub> O<sub>2</sub>
  - 0 to 5000 ppm<sub>v</sub> O<sub>2</sub>
  - 0 to 10,000 ppm<sub>v</sub> O<sub>2</sub>
- *Percent sensors:*
  - 0% to 1% O<sub>2</sub>
  - 0% to 2% O<sub>2</sub>
  - 0% to 5% O<sub>2</sub>
  - 0% to 10% O<sub>2</sub>
  - 0% to 25% O<sub>2</sub>
  - 0% to 50% O<sub>2</sub>

#### 6.3.3 Accuracy

- $\pm$ 1% of range at calibration point
- $\pm$ 2% of range at the calibration point for the 0 to 10 ppm<sub>v</sub> O<sub>2</sub> range (OX-1, 2)

### 6.3.4 Repeatability

- $\pm 1\%$  of range
- $\pm 2\%$  of range for the 0 to 10 ppm<sub>v</sub> O<sub>2</sub> range (OX-1, 2)

### 6.3.5 Resolution

$\pm 0.1\%$  of range

### 6.3.6 Linearity

$\pm 2\%$  of range (OX-1, 2, 3, 5)  
 $\pm 5\%$  of range (OX-4)

### 6.3.7 O<sub>2</sub> Sensor Operating Temperature

32°F to 113°F (0°C to 45°C)

### 6.3.8 Sample Pressure

- Vented to atmosphere during operation and calibration
- 10 psig (0.69 bar) maximum sample operating pressure (except when using ambient air adapter for the sample manifold)
- 200 psig (13.78 bar) sample manifold burst pressure (for all bases except ISO-KF-40 flange adapter)
- ISO-KF-40 is designed for a vacuum flange, where a positive sample pressure is not desired.

### 6.3.9 Atmospheric Pressure Effect

$\pm 0.13\%$  of reading per mmHg (directly proportional to absolute pressure).

**Note:** During calibration, pressure and flow must be kept constant.

### 6.3.10 Process Connection

1/8" NPT-F inlet and outlet

### 6.3.11 Dimensions

4.10 in. x 2.75 in. x 2.05 in. (104.1 x 69.9 x 52.1 mm)

### 6.3.12 Weight

1.35 lb (612 grams)

### 6.3.13 Sample Flow Rate

1.0 SCFH (500 cc/min) recommended for process units

### 6.3.14 Electrical Classification

Intrinsically safe package with Zener barrier or galvanic isolator:

- USA/Canada:  
IS for class I, div 1, groups A, B, C, D; T4  
IS for class I, zone 0, AEx ia IIC T4; Tamb -20 to +60°C
- EU ATEX:  
II 1 G ia IIC Ga  
IECEx Ex ia IIC T4; Tamb -20 to +60°C

Intrinsically safe package for non-incendive (div 2) application without use of Zener barrier or galvanic isolator:

- USA/Canada:  
Class I, div. 2, groups A, B, C, D; T4
- ATEX/IECEx:  
Ex na IIC T4

### 6.3.15 European Compliance

See the EU declaration of conformity at the back of this manual.

## 6.4 Storage

- The storage environment should be cool and dry.
- The ideal temperature range is 0°C to 25°C (32°F to 77°F).
- The fuel cell can be intermittently stored at a temperature of up to 55°C (131°F). (e.g., during transportation).

## 6.5 Product label

A typical product label is shown in figure 8 below.

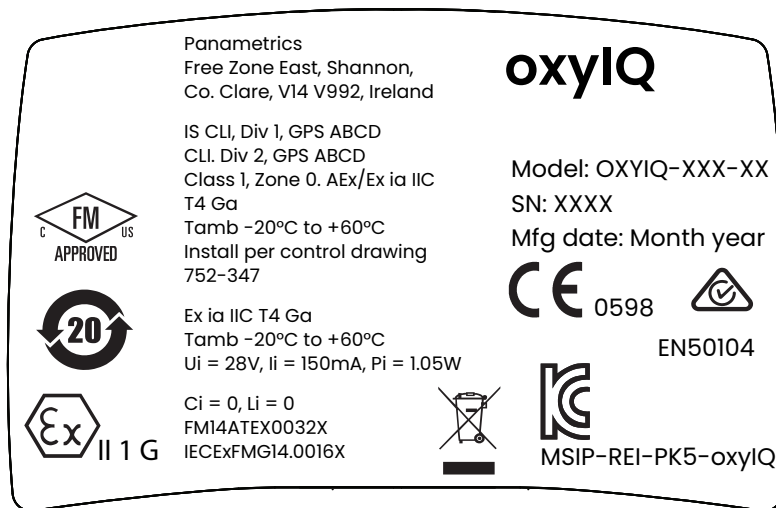

**Figure 8: oxy.IQ label - IS package option**

[no content intended for this page]

## Appendix A. Outline and Installation Drawings

This appendix includes the following oxy.IQ drawings:

- Outline and installation (ref. dwg. 712-1840)
- Cable, standard (ref. dwg. 704-1317, sh 1 of 2)
- Cable, standard (ref. dwg. 704-1317, sh 2 of 2)
- Cable, is (ref. dwg. 704-1318, sh 1 of 2)
- Cable, is (ref. dwg. 704-1318, sh 2 of 2)
- Wiring options (ref. dwgs. 702-285 and 702-286)
- Schematic diagram (ref. dwg. 752-347)



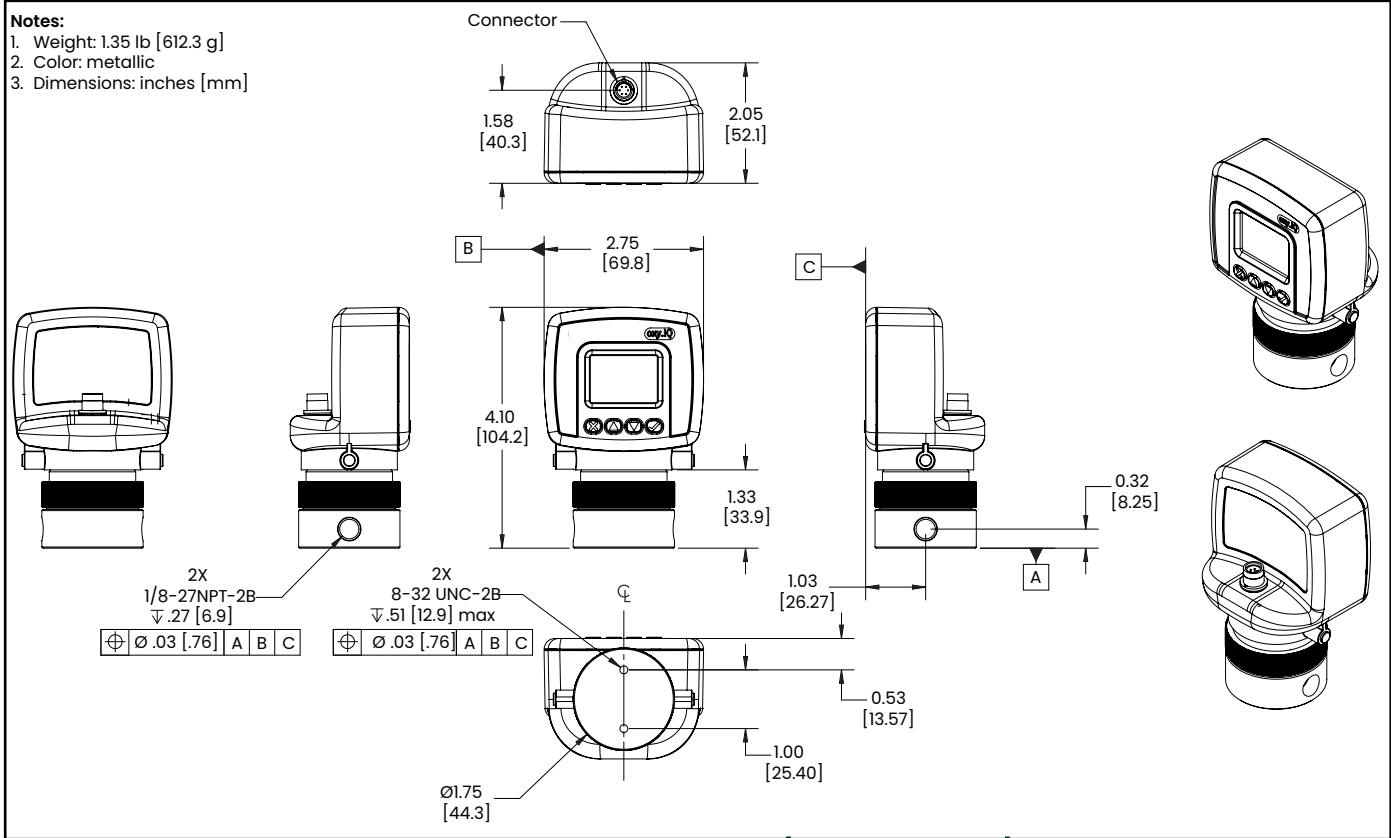

Figure 9: Outline and installation (ref. dwg. 712-1840)

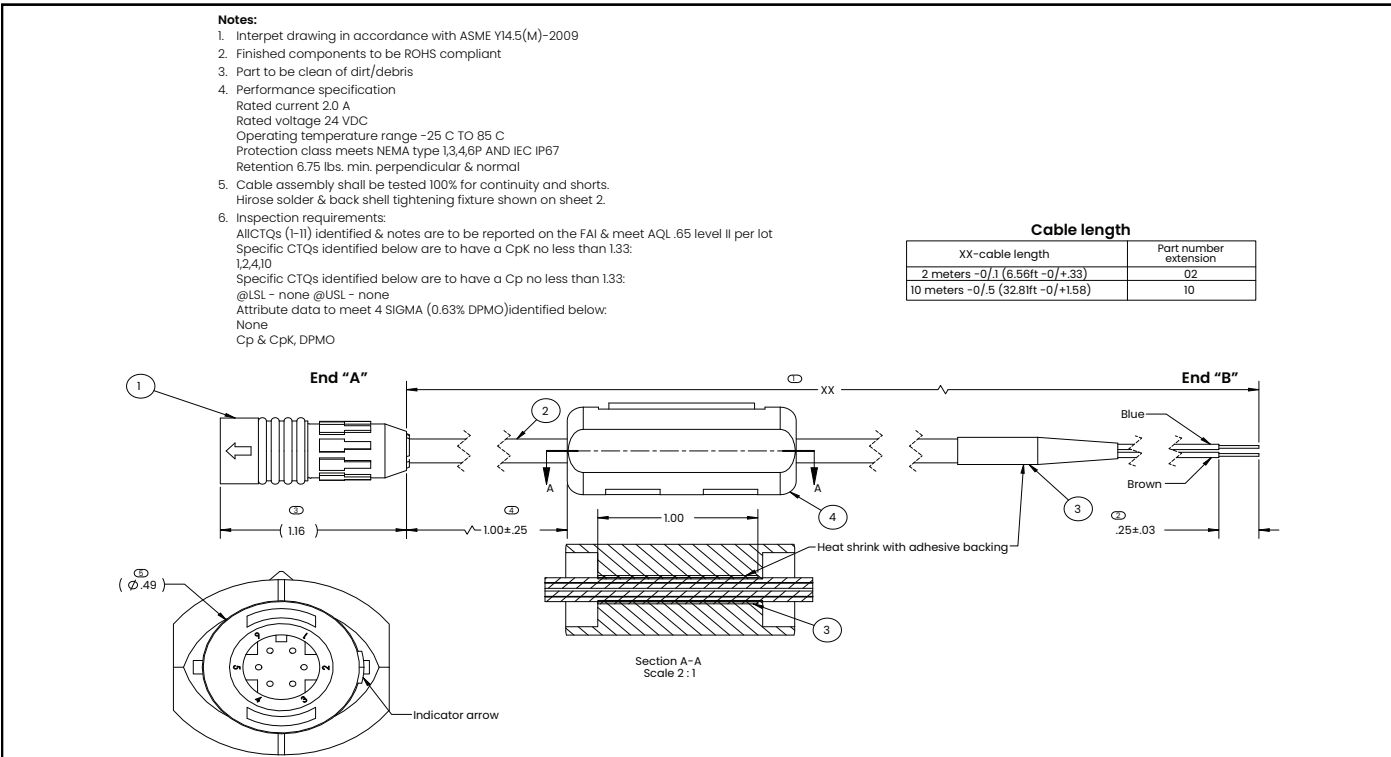
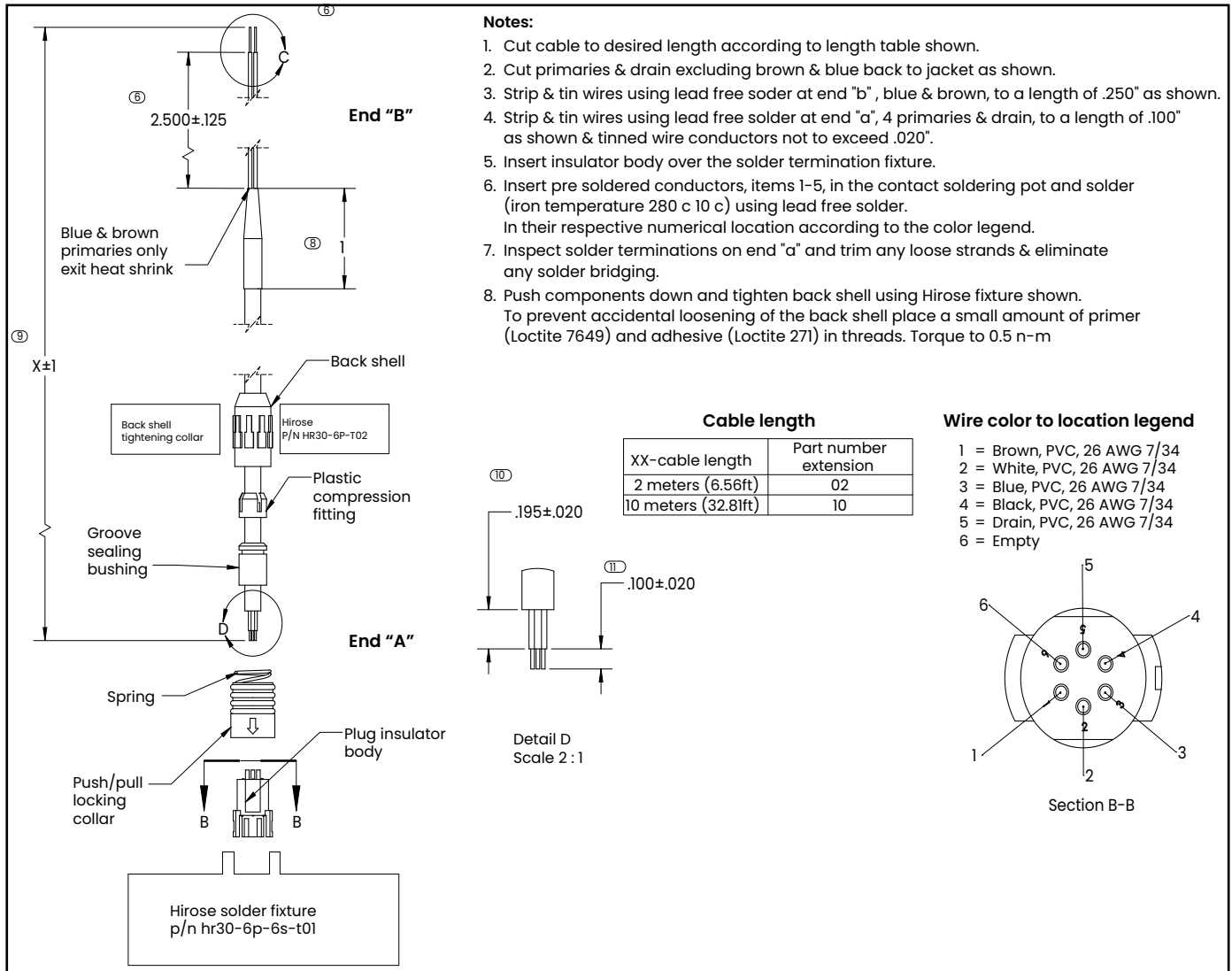

Figure 10: Cable, standard (ref. dwg. 704-1317, SH 1 of 2)



**Notes:**

1. Interpret drawing in accordance with ASME Y14.5(M)-2009
2. Finished components to be ROHS compliant
3. Part to be clean of dirt/debris
4. Performance specification  
 Rated current 2.0 A  
 Rated voltage 24 VDC  
 Operating temperature range -25 C TO 85 C  
 Protection class meets NEMA type 1,3,4,6P and IEC IP67  
 Retention 6.75 lbs. min. perpendicular & normal
5. Cable assembly shall be tested 100% for continuity and shorts.  
 Hirose solder & back shell tightening fixture shown on sheet 2.
6. Inspection requirements:  
 All CTQs (1-11) identified & notes are to be reported on the FAI & meet AQL .65 level II per lot  
 Specific CTQs identified below are to have a CpK no less than 1.33:  
 1,2,4  
 Specific CTQs identified below are to have a Cp no less than 1.33:  
 @LSL none @USL - none  
 Attribute data to meet 4 Sigma (0.63% DPMO) identified below:  
 None

**Cable length**

XX-cable length	Part number extension
2 meters -0/.1 (6.56ft -0/+ .33)	02
10 meters -0/.5 (32.81ft -0/+1.58)	10

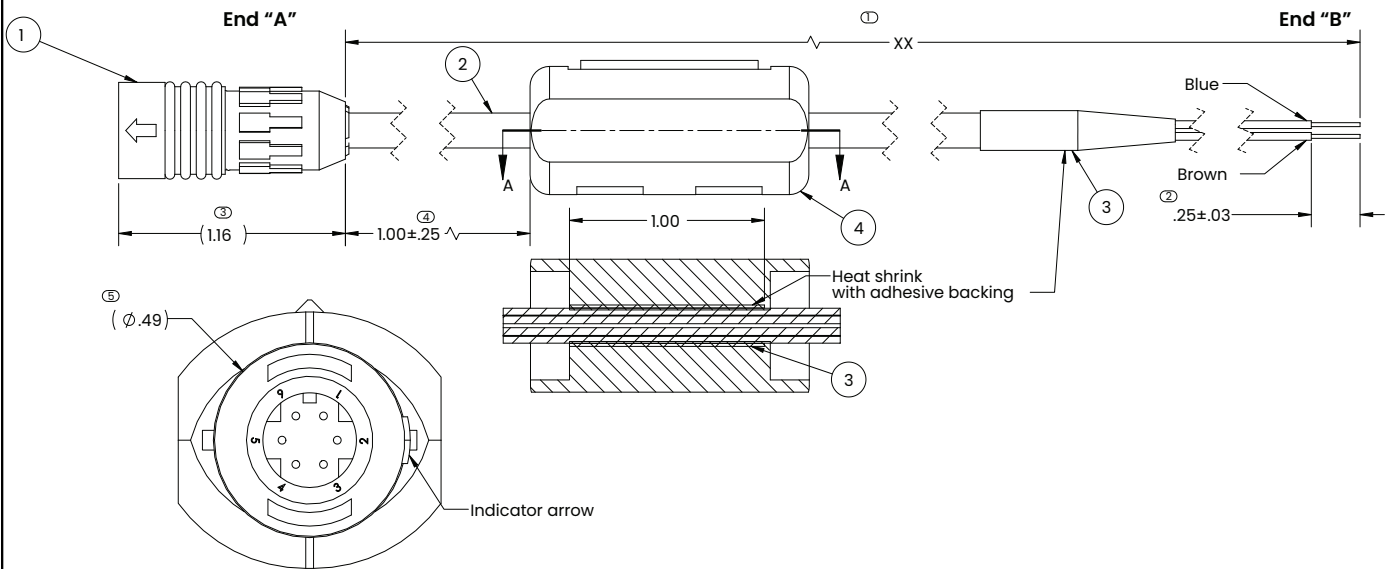

**Figure 12: Cable, IS (ref. dwg. 704-1318, SH1 of 2)**

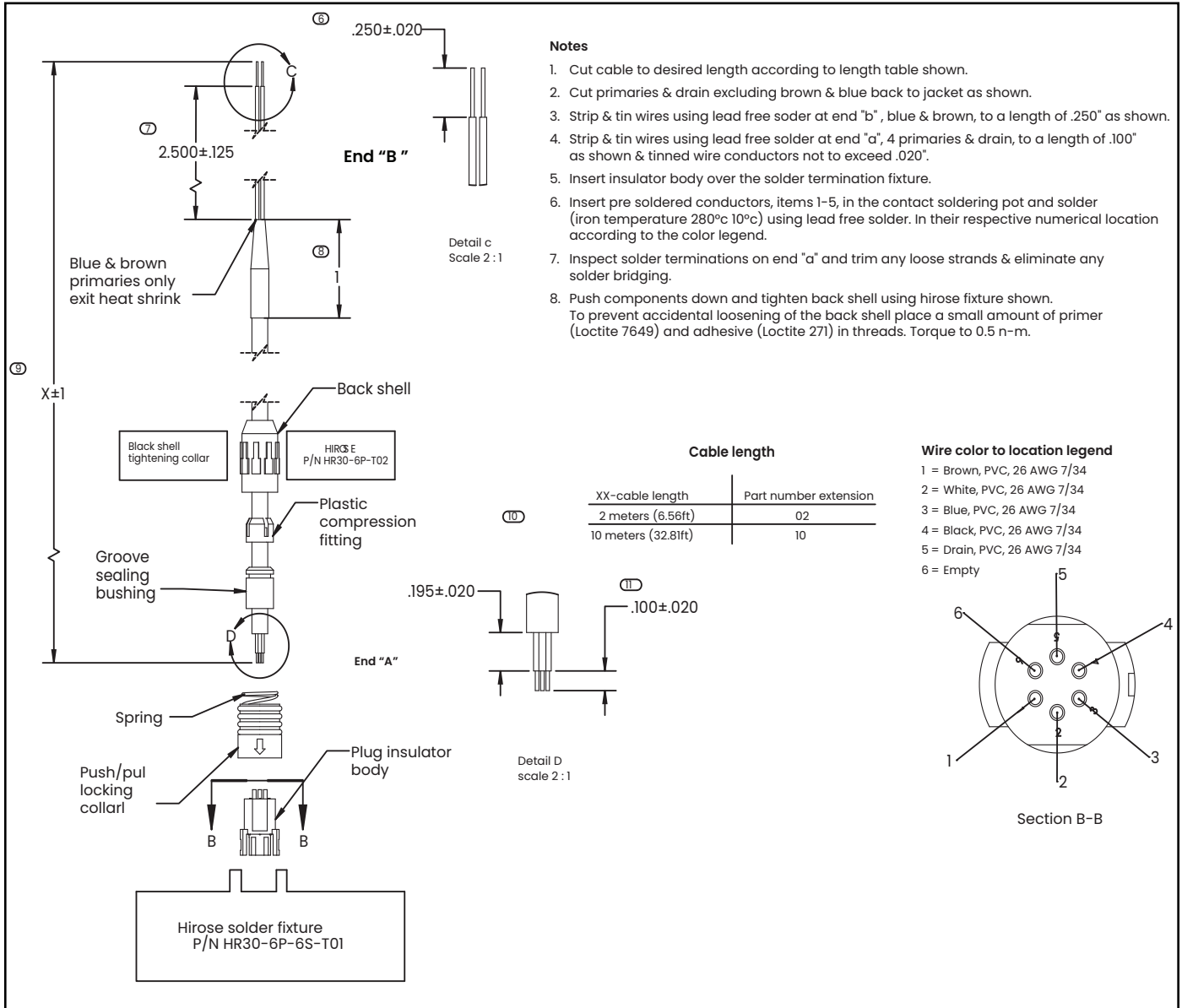

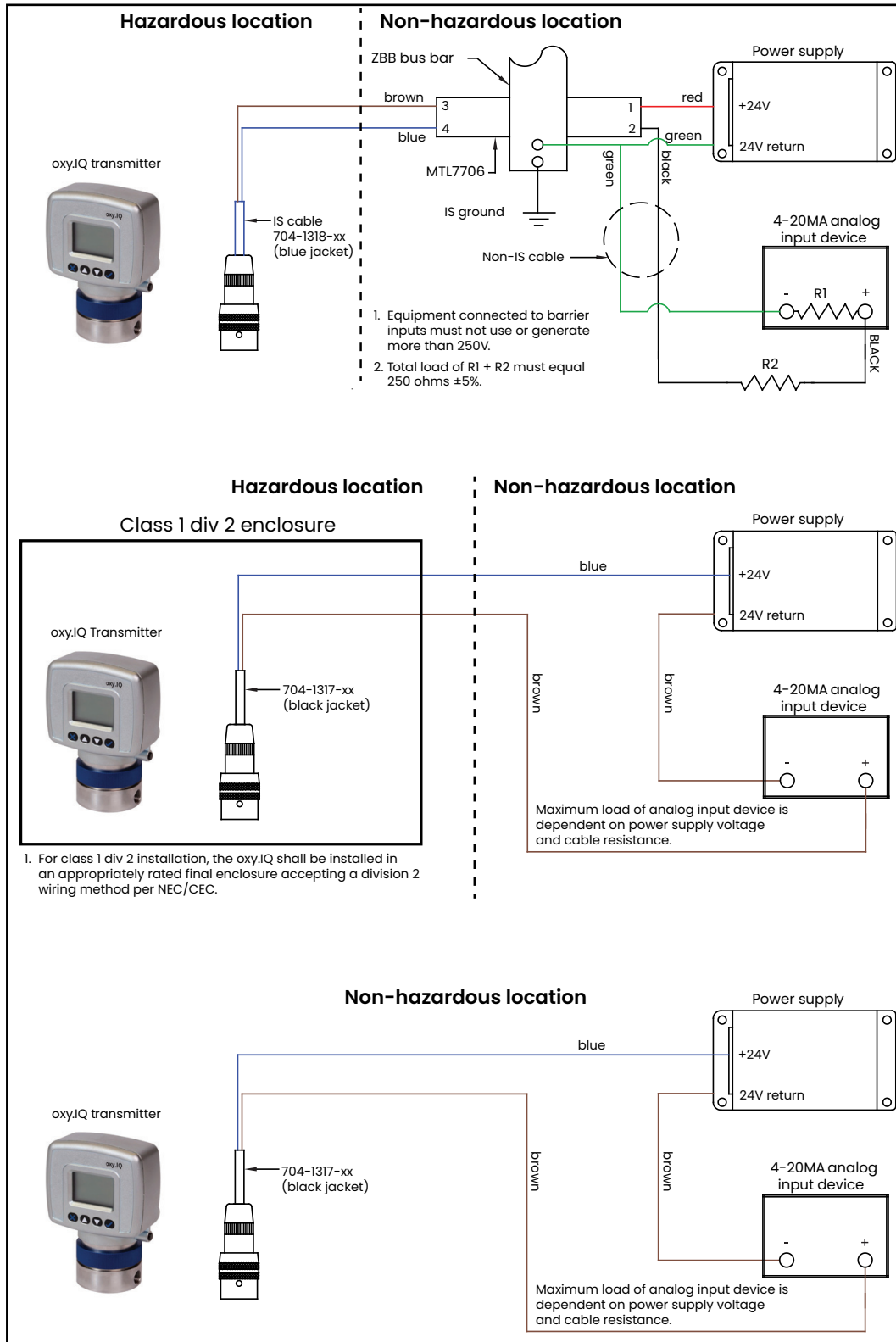

**Figure 14: Wiring options (ref. dwgs. 702-285 and 702-286)**

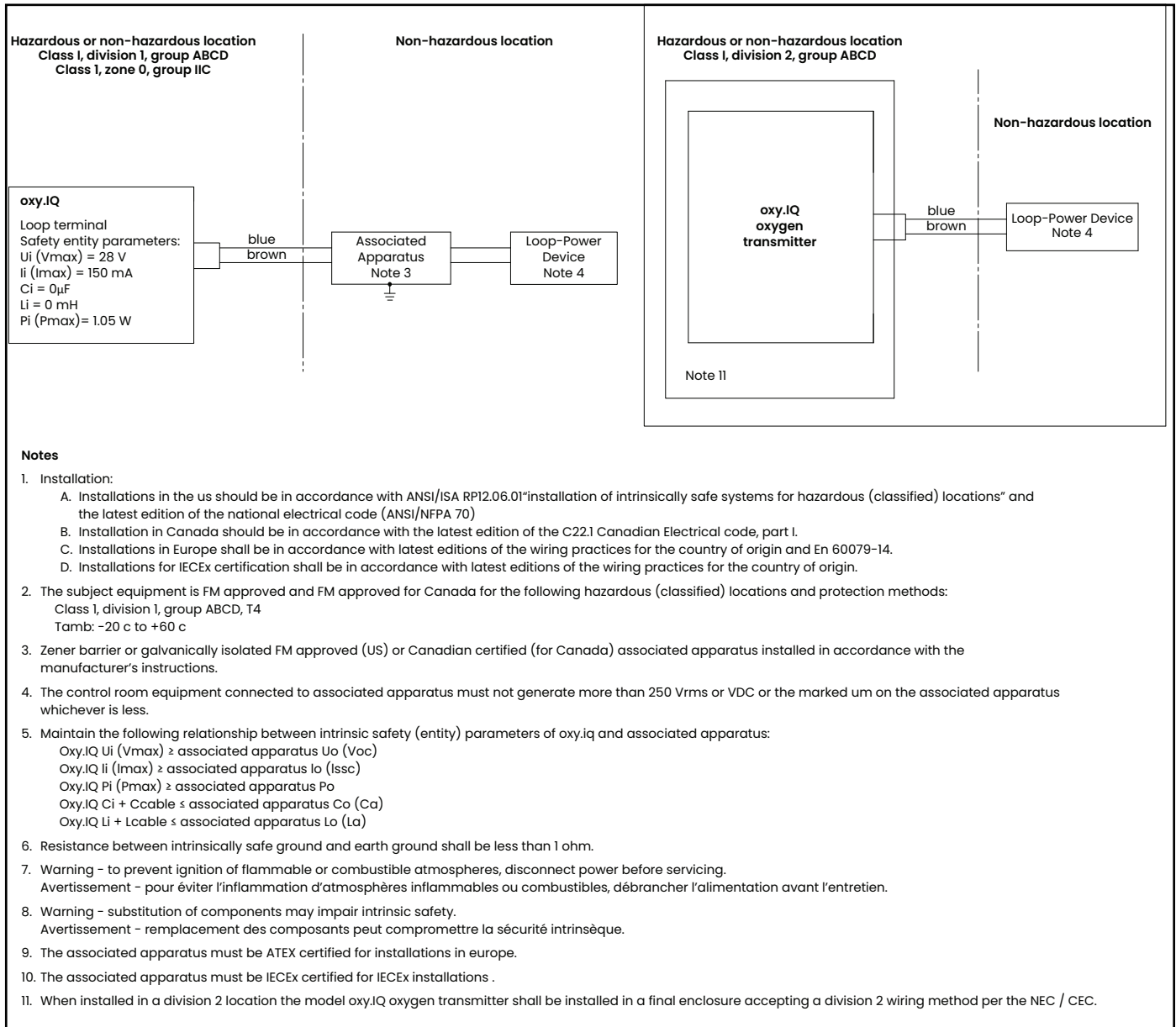

Figure 15: Schematic diagram (ref. dwg. 752-347)

[no content intended for this page]

# Appendix B. Menu Maps

This appendix includes the oxy.IQ user menu maps

**Note:** The service menu map is available to qualified Panametrics field service personnel only.

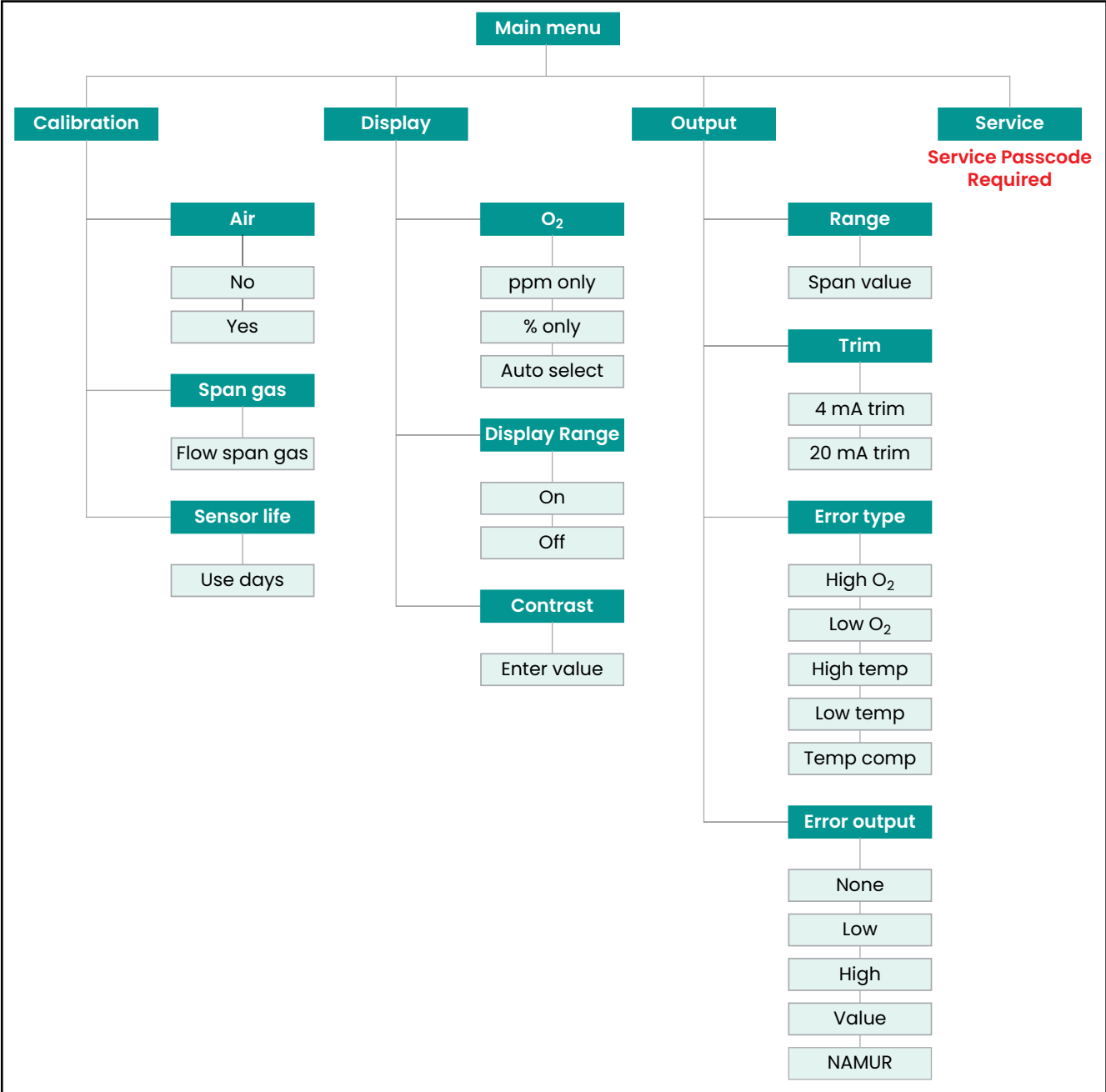

Figure 16: User's Menu Map



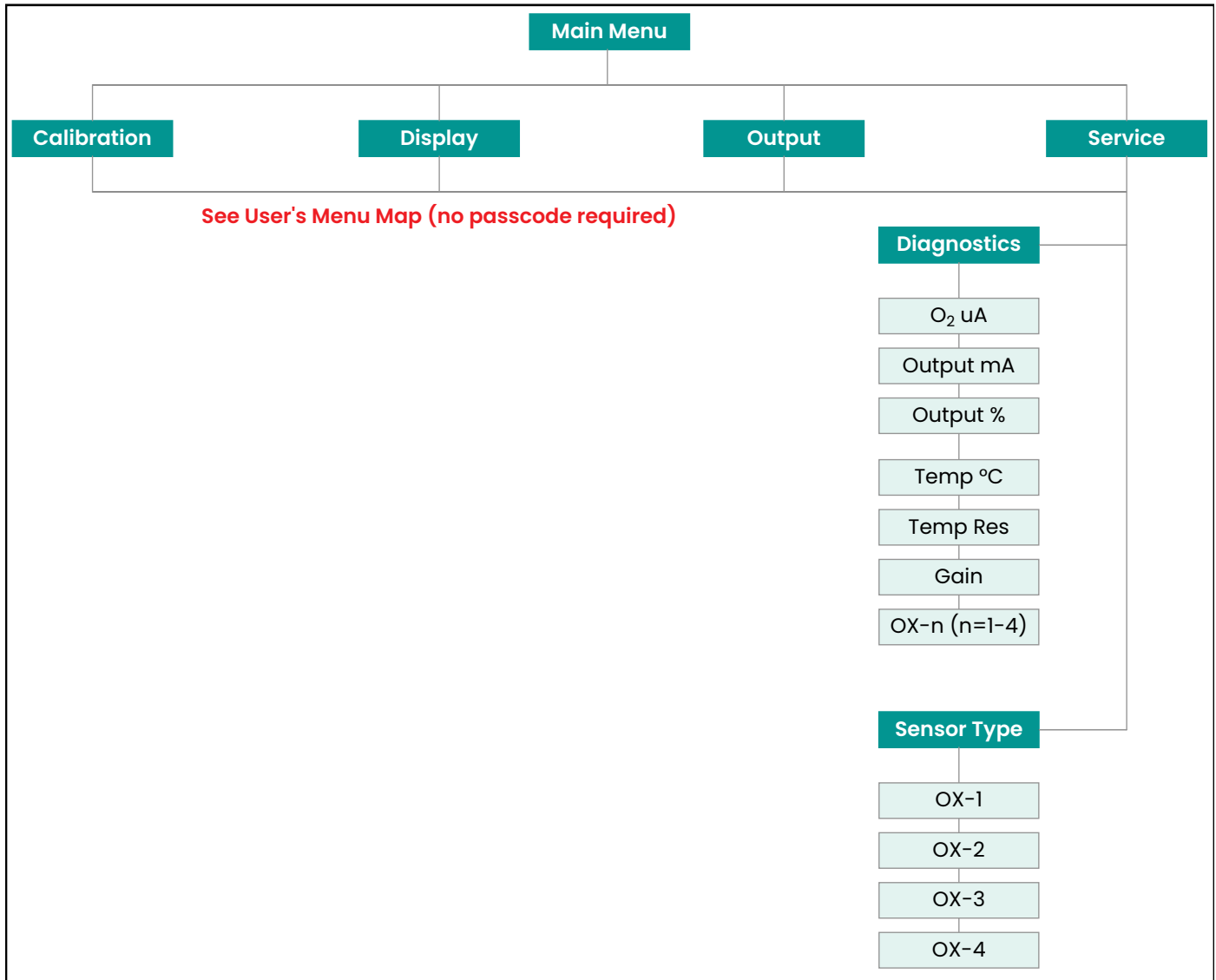

Figure 17: Service Personnel Menu Map

## Appendix C. Order String

The **oxy.IQ** order string is shown in *Table 4* below.

**Table 4: oxy.IQ Order String**  
**OXYIQ – BCD-E (Option Code)**

OXYIQ – BCD-E (Option Code)	
<b>A</b> - Model Only	<ul style="list-style-type: none"> <li>• oxy.IQ Oxygen Transmitter; 4 to 20 mA Output</li> </ul>
<b>B</b> - Sensor <ul style="list-style-type: none"> <li>• 0</li> <li>• 1</li> <li>• 2</li> <li>• 3</li> <li>• 4</li> <li>• 5</li> </ul>	<ul style="list-style-type: none"> <li>• no sensor</li> <li>• Standard ppm, 0 to 10, 20, 50, 100, 200, 500, 1000 ppm</li> <li>• Acid ppm, 0 to 10, 20, 50, 100, 200, 500, 1000 ppm</li> <li>• Standard percent sensor</li> <li>• Acid percent sensor</li> <li>• Standard ppm, 0 to 100, 200, 500 and 1000 ppm</li> </ul>
<b>C</b> - Package <ul style="list-style-type: none"> <li>• 1</li> <li>• 3</li> <li>• 4</li> </ul>	<ul style="list-style-type: none"> <li>• Standard package</li> <li>• Intrinsically safe (US/CAN Class 1 div 1) or Non-incendive (US/CAN class 1 div 2)</li> <li>• Ex flameproof</li> </ul>
<b>D</b> - Cable Length <ul style="list-style-type: none"> <li>• 0</li> <li>• 1</li> <li>• 2</li> </ul>	<ul style="list-style-type: none"> <li>• no cable</li> <li>• 2 meter cable</li> <li>• 10 meter cable</li> </ul>
<b>E</b> - Zener Barrier <ul style="list-style-type: none"> <li>• 0</li> <li>• 1</li> <li>• 2</li> </ul>	<ul style="list-style-type: none"> <li>• none</li> <li>• Zener Barrier</li> <li>• Galvanic isolator.</li> </ul> <p><b>Note:</b> <i>For class 1 div 1 either Zener barrier or galvanic isolator must be selected. For class 1 div 2, no barriers needed. Please refer to dwg 752-347 for installation guidelines.</i></p>

Example part number: **oxy.IQ I32-1**

[no content intended for this page]

## Appendix D. Certification and safety statements

oxy.IQ		Panametrics 1100 Technology Park Drive Billerica, MA 01821				oxy.IQ safety manual	
MODEL		DWG NO.		714-1344	REV. C	TITLE	
Rev	REL/ECO No.	Drawn	Date	Checked	Date	Approved	Date
A	RN 7786	J. Ferro	1/8/15	PMH	1/8/15	J. Ferro	1/8/15
B	ECO-09423	CD SMART	1/19/16	CD SMART	1/19/16	G. KOZINSKI	1/19/16
C	ECO-157348404	CD SMART	1/5/17	J. FERRO	1/5/17	J. FERRO	1/5/17

The oxy.IQ is a highly reliable and cost-effective two-wire, loop-powered transmitter with a linearized 4 to 20 mA output. It measures oxygen in ten ppm ranges and seven percentage ranges. All ranges are user-selectable. This compact transmitter uses proven sensor technology to accurately measure oxygen in a variety of gases, even in hazardous environments.

### When installing this apparatus, the following requirements must be met:

- The system is covered by the certificate numbers FM14ATEX0032X and IECEx FMG 14.00016X as shown on the labels on the following page. The system temperature code is T4 in the temperature range of -20 to 60 °C.
- The apparatus should be de-energized before servicing.
- Installation shall be in accordance with the installation instructions and the National Electrical Code® ANSI/NFPA 70, the Canadian Electrical Code C22.1, or IEC/EN 60079-14, as applicable.
- Equipment is of type Intrinsically Safe and complies with: EN 60079-0:2012, EN 60079-11:2012, IEC 60079-0:2011, IEC 60079-11:2011, IEC 60529:1992, C22.2 No.1010.1:2004, CAN/ CSA-E60079-0:2011, CAN/CSA-E60079-11:2011, C22.2.60529:2005, FM Class 3600:2011, FM Class 3610:2010, FM Class 3810:2005, ANSI/ ISA 61010-1:2004 Ed.2, ANSI/ ISA 60079-0:2009 Ed.5, ANSI/ ISA 60079-11:2009 Ed.5
- The product contains no exposed parts which produce surface temperature infrared, electromagnetic ionizing, or non-electrical dangers.
- The product must not be subjected to mechanical or thermal stresses in excess of those permitted in the certification documentation and the instruction manual.
- The product cannot be repaired by the user; it must be replaced by an equivalent certified product. Repairs should only be carried out by the manufacturer or by an approved repairer. Please contact Panametrics Customer Support Center for repair, maintenance or replacement of the product. For oxygen sensor replacements, please contact Panametrics.

Customer Support Center.

**U.S.A**

Panametrics LLC  
1100 Technology Park Drive  
Billerica, MA 01821

U.S.A

Tel: 800 833 9438 (toll-free)  
978 437 1000

E-mail: Panametricstechsupport@bakerhughes.com

**Ireland**

Baker Hughes Sensing EMEA  
Free Zone East, Shannon,  
CO. CLARE, V14 V992, Ireland  
Tel: +35 361 470200

- Only trained, competent personnel may install, operate and maintain the equipment.
- For product training, please contact Panametrics Customer Support Center:

**U.S.A**

Panametrics LLC  
1100 Technology Park Drive  
Billerica, MA 01821

U.S.A

Tel: 800 833 9438 (toll-free)  
978 437 1000

E-mail: Panametricstechsupport@bakerhughes.com

**Ireland**

Baker Hughes Sensing EMEA  
Free Zone East, Shannon,  
CO. CLARE, V14 V992, Ireland  
Tel: +35 361 470200

- The product is an electrical apparatus and must be installed in the hazardous area in accordance with the requirements of the EC Type Examination Certificate. The installation must be carried out in accordance with all the appropriate international, national and local standard codes and practices and site regulations for Intrinsically Safe apparatus and in accordance with the instructions contained in the manual. Access to the circuitry must not be made during operation.
- The maximum operating pressure for the oxy.IQ is 10 psig. Be sure the sample conditioning system is designed to maintain the oxy.IQ pressure below these limits, and that the oxy.IQ outlet is vented to atmosphere during operation and calibration.



**WARNING! Substitution of components may impair intrinsic safety.**



**WARNING! To prevent ignition of flammable or combustible atmospheres, disconnect power before servicing.**

**AVERTISSEMENT!**

**Pour éviter l'inflammation d'atmosphères inflammables ou combustibles, débrancher l'alimentation avant l'entretien.**

**AVERTISSEMENT!**

**Remplacement des composants peut compromettre la sécurité intrinsèque.**

- Equipment is not intended for the measurement of oxygen in fluid of liquid phase.

## Special conditions of safe use

The model oxy.IQ will not pass the 500V dielectric test. This must be taken into account upon installation.

## Markings

- Markings shall appear on the oxy.IQ as shown below for the intrinsically safe version of the product.

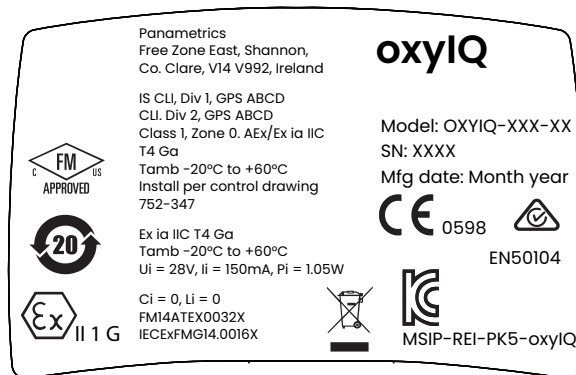

## Connection and wiring diagram

The following diagram is the entity parameters for the oxy.IQ.

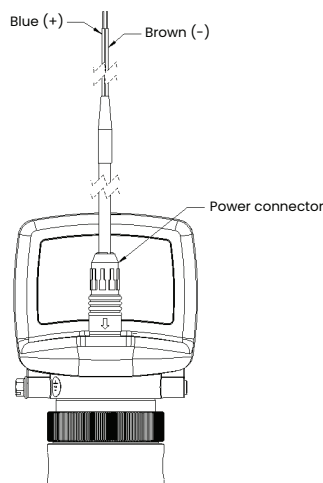

## Power requirements:

Nominal operating parameters: 28VDC at 50mA

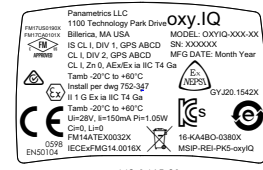
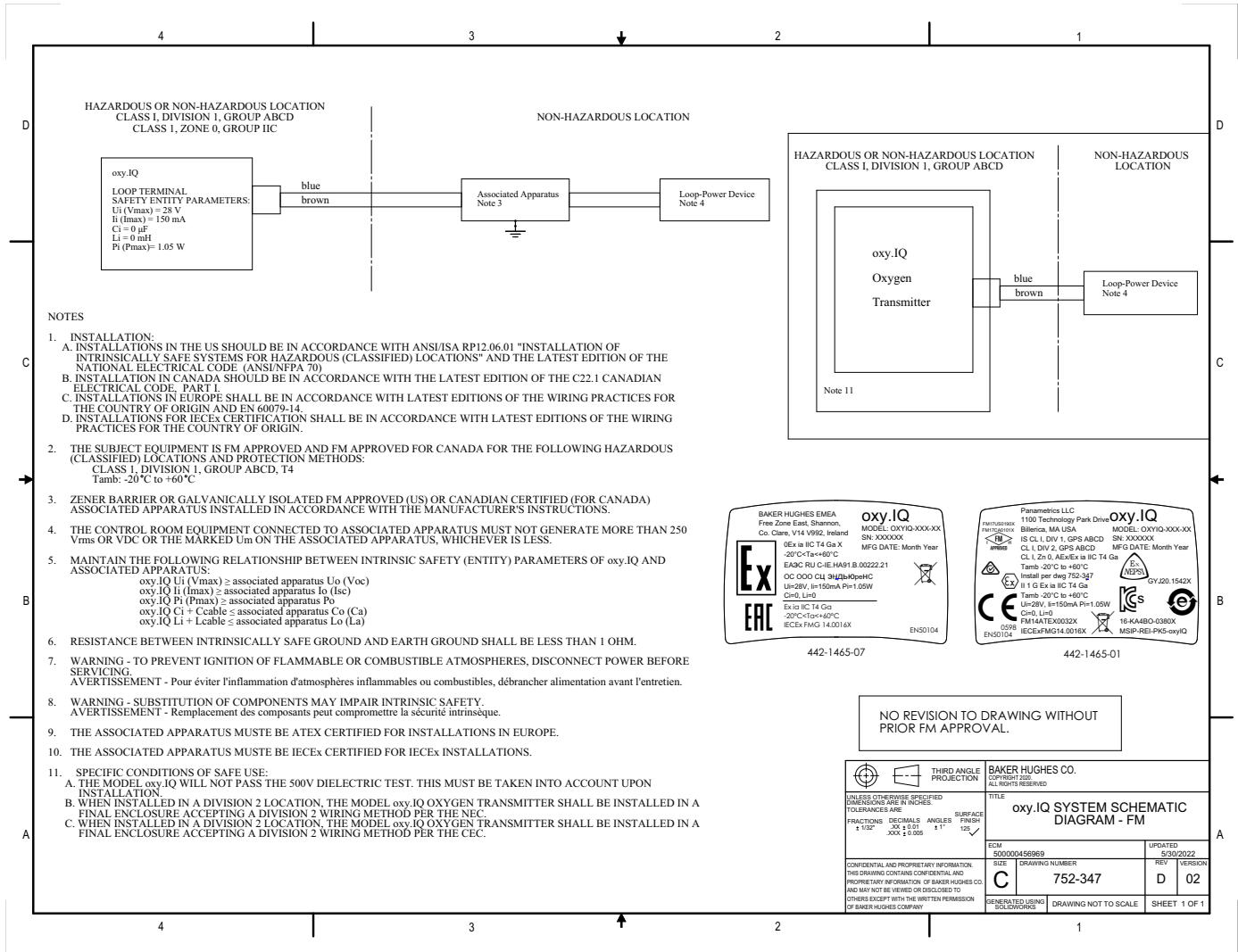

NO REVISION TO DRAWING WITHOUT PRIOR FM APPROVAL.

THIRD ANGLE PROJECTION		BAKER HUGHES CO. COPYRIGHT 2020 ALL RIGHTS RESERVED	
UNLESS OTHERWISE SPECIFIED DIMENSIONS ARE IN INCHES TOLERANCES ARE FRACTIONS DECIMALS ANGLES SURFACE FINISH		TITLE <b>oxy.iQ SYSTEM SCHEMATIC DIAGRAM - FM</b>	
± .012 XX ± 0.01 XXX ± 0.005		ESEM 500000456969	
CONFIDENTIAL AND PROPRIETARY INFORMATION. THIS DRAWING CONTAINS CONFIDENTIAL AND PROPRIETARY INFORMATION OF BAKER-HUGHES CO. AND MAY NOT BE VIEWED OR DISCLOSED TO OTHERS EXCEPT WITH THE WRITTEN PERMISSION OF BAKER HUGHES COMPANY.		SIZE <b>C</b>	UPDATED 5/30/2022
GENERATED USING SOLIDWORK		DRAWING NUMBER <b>752-347</b>	REV <b>D</b>
DRAWING NOT TO SCALE		VERSION <b>02</b>	
		SHEET 1 OF 1	

## Appendix E. Cell Models

### E.1 Oxygen Sensors Chemical Compatibility Chart

Table 4 lists the chemical compatibility for the oxygen sensor used with the oxy.IQ.

**Table 4: Oxygen Sensor Chemical Compatibility Chart**

Common Name	Chemical Formula	OX-1 & OX-5 Standard Gas ppm Sensor	OX-2 Acid Gas ppm Sensor	OX-3 Standard Gas % Sensor	OX-4 Acid Gas % Sensor
Acetic Acid (Liquid)	H3COOH	Note: (7)	Note: (7)	Note: (7)	Note: (7)
Acetone	(CH3)2CO	Note (7)	Note (7)	Note (7)	Note (7)
Acetylene	HCCH	Excellent	Excellent	Excellent	Excellent
Acrylonitrile	C3H3N	Good	Good	Good	Good
Air	"N2+O2+Ar..."	Excellent	Excellent	Excellent	Excellent
Ammonia	NH3	Note: (12)	Note (6)	Note: (12)	Note (6)
Arsine	AsH3	Note (6)	Note (6)	Note (6)	Note (6)
Argon	Ar	Excellent	Excellent	Excellent	Excellent
Butane	C4H10	Excellent	Excellent	Excellent	Excellent
Butadiene	C4H6	Note: (10)	Note: (6)	Note: (10)	Note: (6)
Carbon Dioxide	CO2	<5000 ppm	Excellent	<0.5%	Excellent
Carbon Disulfide	CS2	<1000 ppm	Excellent	<0.1%	Excellent
Carbon Monoxide	CO	Excellent	Excellent	Excellent	Excellent
Chlorinated Hydrocarbons	"C + H + Cl"	Good	Good	Good	Good
Chlorine	Cl2	Note: (11)	Note: (11)	Note: (11)	Note: (11)
Chloro-fluorocarbons	"H+F+Cl+C"	Excellent	Excellent	Excellent	Excellent
Ethyl Acetate	C4H8O2	Excellent (4)	Excellent (4)	Excellent (4)	Excellent (4)
Ethylene	C2H4	Excellent	Excellent	Excellent	Excellent
Fluorine	F2	Note: (3)	Note: (3)	Note: (3)	Note: (3)
Formaldehyde	CH2O	Excellent (7)	Excellent (7)	Excellent (7)	Excellent (7)
Helium	He	Excellent	Excellent	Excellent	Excellent
Heptanes	"-C7H16"	Note: (7)	Note: (7)	Note: (7)	Note: (7)
Hexanes	"-C6H14"	(7)(10)	Note: (7)	(7)(10)	Note: (7)
Hydrocarbons (Light- C5 and below)	"H+C"	Excellent (4)	Excellent (4)	Excellent (4)	Excellent (4)
Hydrogen	H2	Excellent	Good (13)	Excellent	Good
Hydrochloric Acid	HCl	<1000 ppm	Note: (5)	0.01% (1)	Note: (5)
Hydrogen Cyanide	HCN	<1000 ppm	Note: (5)	0.01% (1)	Note: (5)
Hydrogen Fluoride	HF	Note: (6)	Good (1)	Note: (6)	Good (1)
Hydrogen Sulfide	H2S	<10 ppm (1)	<10 ppm (1)	0.001% (1)	0.001% (1)
Methane	CH4	Excellent	Excellent	Excellent	Excellent
Methanol	CH3OH	Good (7)	Good (7)	Good (7)	Good (7)
Methyl Iodide	CH3I	Note: (7)	Note: (7)	Note: (7)	Note: (7)
Nitrogen	N2	Excellent	Excellent	Excellent	Excellent
Isopropyl Acetate	C5H10O2	Excellent (4)	Excellent (4)	Excellent (4)	Excellent (4)



**Table 4: Oxygen Sensor Chemical Compatibility Chart**

Common Name	Chemical Formula	OX-1 & OX-5 Standard Gas ppm Sensor	OX-2 Acid Gas ppm Sensor	OX-3 Standard Gas % Sensor	OX-4 Acid Gas % Sensor
Isopropyl Alcohol (IPA)	C3H8O	Excellent (7)	Excellent (7)	Excellent (7)	Excellent (7)
Nitric Oxide	NO	Note: (8)	Note: (8)	Note: (8)	Note: (8)
Nitrogen	N2	Excellent	Excellent	Excellent	Excellent
Nitrogen Dioxide	NO2	Note: (3)	Note: (3)	Note: (3)	Note: (3)
Nitrous Oxide	N2O	Note: (8)	Note: (8)	Note: (8)	Note: (8)
NOx	NO, NO2	Note: (6)	Note: (6)	Note: (8)	Note: (8)
Methanol (MeOH)	CH4O	Note: (7)	Note: (7)	Note: (7)	Note: (7)
MTBE (Methyl Tert-Butyl Ether)	C5H12O			Good	Good
Octofluorocyclobutane	C4F8			Good	Good
Pentane	C5H12	Note: (7)	Note: (7)	Note: (7)	Note: (7)
Phosgene	CCl2O	Note: (6)	Note: (6)	Note: (6)	Note: (6)
Phosphine	PH3	Note: (6)	Note: (6)	Note: (6)	Note: (6)
Propane	C3H8	Excellent	Excellent	Excellent	Excellent
Propionic Acid	C3H6O2	Good	Note: (7)	Good	Note: (7)
Propylene	C3H6	Excellent	Excellent	Excellent	Excellent
Propylene Aldehyde	C3H4O	Note: (7)	Note: (7)	Note: (7)	Note: (7)
Silane	SiH4	Note: (6)	Note: (6)	Note: (6)	Note: (6)
Styrene	C8H8	Excellent	Excellent	Excellent	Excellent
Sulfur Dioxide	SO2	<10ppm	Note: (5)(8)	0.01% (1)	Note: (5)(8)
Sulfuric Acid	H2SO4	Note: (1)	Note: (1)	Note: (1)	Note: (1)
Sulfur Hexafluoride	SF6	Excellent	Excellent	Excellent	Excellent
Turpene	(C5H8)n	(8)(9)(10)	(8)(9)(10)	(8)(9)(10)	(8)(9)(10)
Tetrafluoromethane	CF4	Good	Good	Good	Good
Tetrahydrofuran (THF) (Oxolane)	C4H8O	Excellent	Excellent	Excellent	Excellent
Toluene	C7H8	Note:(7)	Note:(7)	Note:(7)	Note:(7)
Vinyl Acetate	C4H6O2	Good (7)	Good (7)	Good (7)	Good (7)
Vinyl Chloride	C2H3Cl	Excellent	Excellent	Excellent	Excellent

**Note:**

1. No interference with O2 sensor's signal output. Exposure above recommended stated value without sample conditioning (e.g. removal of subject gas) reduces expected sensor life (varies with duration and conditioning) and voids warranty. Consult factory for sample conditioning recommendations.
2. No interference with O2 sensor's signal output. Exposure above recommended stated value reduces expected sensor life (varies with duration and concentration) and voids sensor warranty. Use OX-2 and OX-4 sensors.
3. Minimal effect on expected sensor life. Produces a signal output equal to 50% of its concentration in the gas stream in addition to the O2 concentration.
4. Compatible with most HC gas streams, but due to the wide variety of combinations - consult factory. Anything above C5 needs a coalescing filter.
5. No interference. Minimal effect on expected sensor life.
6. Not Recommended
7. Condensable liquid at ambient temperature. Remove by cooling and/or coalescing filter upstream of the sensor.
8. Not recommended in high volume percent

9. Can be removed by absorbent in low concentrations
10. Reduces sensor life, but no effect on signal output.
11. Produces a negative signal equal to 50% of its concentration in the gas stream. Minimal effect on sensor life.
12. For intermittent use only (A few hours per day). Analyzer must be purged after measurement.
13. Suitable if  $H_2 < 65\%$

## E.2 Oxygen Concentration Range of Different Cell Models

The Oxygen concentration of the different cells models used with oxy.IQ are given below in Table 5.

**Table 5: Oxygen concentration range of cell models**

Oxygen content	OX-1 and OX-2	OX-3 and OX-4	OX-5
0 to 10 ppmv	✓		
0 to 20 ppmv	✓		
0 to 50 ppmv	✓		
0 to 100 ppmv	✓		✓
0 to 200 ppmv	✓		✓
0 to 500 ppmv	✓		✓
0 to 1,000 ppmv	✓		✓
0 to 2,000 ppmv	✓		✓
0 to 5,000 ppmv	✓		✓
0 to 10,000 ppmv	✓		✓
0% to 1%		✓	
0% to 2%		✓	
0% to 5%		✓	
0% to 10%		✓	
0% to 25%		✓	
0% to 50%		✓	

[no content intended for this page]



Service Menu

Diagnostics Option ..... 17  
Entering ..... 17  
Menu Map ..... 32  
Passcode ..... 17  
Specifications ..... 19

**T**

Trimming

Analog Output ..... 10  
Output, High (20 mA) ..... 11  
Output, Low (4 mA) ..... 10

**W**

Warranty ..... 47  
Weight ..... 20  
Wiring the oxy.iQ ..... 7

---

## Warranty

Each instrument manufactured by Panametrics is warranted to be free from defects in material and workmanship. Liability under this warranty is limited to restoring the instrument to normal operation or replacing the instrument, at the sole discretion of Panametrics. Fuses and batteries are specifically excluded from any liability. This warranty is effective from the date of delivery to the original purchaser. If Panametrics determines that the equipment was defective, the warranty period is:

- 12 months from delivery for electronic or mechanical failures
- 12 months from delivery for sensor shelf life

If Panametrics determines that the equipment was damaged by misuse, improper installation, the use of unauthorized replacement parts, or operating conditions outside the guidelines specified by Panametrics, the repairs are not covered under this warranty.

---

**The warranties set forth herein are exclusive and are in lieu of all other warranties whether statutory, express or implied (including warranties or merchantability and fitness for a particular purpose, and warranties arising from course of dealing or usage or trade).**

---

## Return Policy

If a Panametrics instrument malfunctions within the warranty period, the following procedure must be completed:

1. Notify Panametrics, giving full details of the problem, and provide the model number and serial number of the instrument. If the nature of the problem indicates the need for factory service, Panametrics will issue a RETURN AUTHORIZATION NUMBER (RAN), and shipping instructions for the return of the instrument to a service center will be provided.
2. If Panametrics instructs you to send your instrument to a service center, it must be shipped prepaid to the authorized repair station indicated in the shipping instructions.
3. Upon receipt, Panametrics will evaluate the instrument to determine the cause of the malfunction.

Then, one of the following courses of action will then be taken:

- If the damage is covered under the terms of the warranty, the instrument will be repaired at no cost to the owner and returned.
- If Panametrics determines that the damage is not covered under the terms of the warranty, or if the warranty has expired, an estimate for the cost of the repairs at standard rates will be provided. Upon receipt of the owner's approval to proceed, the instrument will be repaired and returned.

[no content intended for this page]





## Customer Support Centers

### U.S.A.

Panametrics LLC,  
1100 Technology Park Drive,  
Billerica, MA 01821,  
U.S.A.

Tel: 800 833 9438 (toll-free)  
978 437 1000

E-mail: [PanametricsTechSupport@BakerHughes.com](mailto:PanametricsTechSupport@BakerHughes.com)

### Ireland

Baker Hughes Sensing EMEA,  
Shannon Free Zone East,  
Shannon, County Clare,  
Ireland.

Tel: +35 361 470291

E-mail: [PanametricsTechSupport@BakerHughes.com](mailto:PanametricsTechSupport@BakerHughes.com)

**Scan here for Panametrics  
support and service information**



Copyright 2023 Baker Hughes company.

This material contains one or more registered trademarks of Baker Hughes Company and its subsidiaries in one or more countries. All third-party product and company names are trademarks of their respective holders.

BH024C11 EN G (04/2023)

**Baker Hughes** 