

OCEANUS-6 SERIES MODEL 580

This manual is issued under the authority of
Mr. J.P. Tavener, Managing Director



**Isotech North America
158 Brentwood Drive, Unit 4
Colchester, VT 05446**

**Phone: 802-863-8050
Fax: 802-863-8125**

**www.isotechna.com
sales@isotechna.com**

The company is always willing to give technical advice and assistance where appropriate. Equally, because of the programme of continual development and improvement we reserve the right to amend or alter characteristics and design without prior notice. This publication is for information only.

CONTENTS



<u>PAGE</u>	<u>DESCRIPTION</u>
3 - 4	EMC Information
5	Health & Safety Instructions
6	Do's and Don'ts
7	Guarantee
8	Cautionary Note
9	Unpacking & Initial Inspection
10 - 12	Introduction
13 - 15	Mode of Operation
16	Adjusting the Timer
17 - 18	Using Water & Gallium Fixed Point Cells
19 - 20	Thermometric Fixed Points (a tutorial note)
21	How to measure the true temperature inside the accessories supplied with the Isocal-6
22	Specification
23	Performance Graph
24 - 25	Operation
26 - 28	Altering the Ramp Rate
29	Determining the Calibration Data
30 - 31	Connecting a current transmitter (up to 20mA) Testing Thermostats
32	Using the PC Interface
33 - 34	Using the Cal Notepad
35	Diagnostics
36	Initial Testing
37	Maintenance
38	Figure 1
39	Appendix 1 - Trouble Shooting
40 - 41	Appendix 2 - Indicator Configuration
42 - 43	Appendix 3 - Accessories



EMC INFORMATION

This product meets the requirements of the European Directive on Electromagnetic Compatibility (EMC) 89/336/EEC as amended by EC Directive 92/31/EEC and the European Low Voltage Directive 73/25/EEC, amended by 93/68/EEC. To ensure emission compliance please ensure that any serial communications connecting leads (RS232 or RS422(485)) are fully screened.

The product meets the susceptibility requirements of EN 50082-1, criterion B.

Symbol Identification	Publication	Description
	ISO3864	Caution (Refer to Handbook)
	IEC 417	Caution, Hot Surface

ELECTRICAL SAFETY



This equipment must be correctly earthed.

This equipment is a Class 1 Appliance. A protective earth is used to ensure the conductive parts can not become live in the event of a failure of the insulation.

The protective conductor of the flexible mains cable which is coloured green/yellow **MUST** be connected to a suitable earth.

The blue conductor should be connected to Neutral and the Brown conductor to Live (Line).

Warning: Internal mains voltage hazard. Do not remove the panels.

There are no user serviceable parts inside. Contact your nearest Isotech agent for repair.

Voltage transients on the supply must not exceed 2.5kV.

Conductive pollution, eg. Carbon dust, must be excluded from the apparatus. EN61010 pollution degree 2.

The apparatus has two input connectors for temperature sensors, see Figure 1. These inputs are only suitable for either a thermocouple or resistance thermometer. No other sensor or signal may be connected.

ENVIRONMENTAL RATINGS

Operating Temperature 5-50°C

Relative Humidity 5-95%, non condensing



HEALTH AND SAFETY INSTRUCTIONS

1. Read all of this handbook before use.
2. Wear appropriate protective clothing.
3. Operators of this equipment should be adequately trained in the handling of hot and cold items and liquids.
4. Do not use the apparatus for jobs other than those for which it was designed, ie. the calibration of thermometers.
5. Do not handle the apparatus when it is hot (or cold), unless wearing the appropriate protective clothing and having the necessary training.
6. Do not drill, modify or otherwise change the shape of the apparatus.
7. Do not dismantle the apparatus.
8. Do not use the apparatus outside its recommended temperature range.
9. If cased, do not return the apparatus to its carrying case until the unit has cooled.
10. There are no user serviceable parts inside. Contact your nearest Isotech agent for repair.
11. Ensure materials, especially flammable materials are kept away from hot parts of the apparatus, to prevent fire risk.

OCEANUS-6 MODEL 580

'DO'S AND DON'TS'

DO NOT handle the accessories when they are very hot or very cold.

DO NOT place hot or cold accessories back in the carrying case

DO NOT use the pocket designed for the black body source sensor to measure the temperature of the insert, stirred liquid bath or surface calibrator.

DO use that pocket for pre-warming, pre-cooling or storage.

DO NOT spill liquids inside the Oceanus-6

DO NOT use liquids outside their recommended temperature range

DO NOT use viscous liquids in the stirred liquid accessory, the stirring will be restricted and larger gradients will occur.

DO NOT mix liquids. If you are using 1 container for different liquids make sure the container is completely clean and dry before adding another liquid.

DO NOT worry if the black anodising gets discoloured or scratched. We can supply some special black touch up paint.

DO NOT rely on the controller to tell you the temperature of the insert or stirred liquid bath. It's job is only to provide an isothermal volume. It is the calibrated working standard that is used to measure actual temperature.

DO NOT calibrate very large sensors in the Oceanus-6 unless you can accept large immersion errors. We have larger products for larger sensors.

DO NOT try to straighten the working standard, it is deliberately bent so that it does not interfere with the sensors you are calibrating.

GUARANTEE

This instrument has been manufactured to exacting standards and is guaranteed for twelve months against electrical break-down or mechanical failure caused through defective material or workmanship, provided the failure is not the result of misuse. In the event of failure covered by this guarantee, the instrument must be returned, carriage paid, to the supplier for examination and will be replaced or repaired at our option.

FRAGILE CERAMIC AND/OR GLASS PARTS ARE NOT COVERED BY THIS
GUARANTEE

INTERFERENCE WITH, OR FAILURE TO PROPERLY MAINTAIN THIS INSTRUMENT
MAY INVALIDATE THIS GUARANTEE

RECOMMENDATION

The life of your **ISOTECH** Instrument will be prolonged if regular maintenance and cleaning to remove general dust and debris is carried out.

Serial No:.....

Date:.....

Isotech North America
158 Brentwood Drive, Unit 4
Colchester, VT 05446

Phone: 802-863-8050
Fax: 802-863-8125

sales@isotechna.com
www.isotechna.com



CAUTIONARY NOTE

ISOTECH PRODUCTS ARE INTENDED FOR USE BY TECHNICALLY TRAINED AND COMPETENT PERSONNEL FAMILIAR WITH GOOD MEASUREMENT PRACTICES.

IT IS EXPECTED THAT PERSONNEL USING THIS EQUIPMENT WILL BE COMPETENT WITH THE MANAGEMENT OF APPARATUS WHICH MAY BE POWERED OR UNDER EXTREMES OF TEMPERATURE, AND ARE ABLE TO APPRECIATE THE HAZARDS WHICH MAY BE ASSOCIATED WITH, AND THE PRECAUTIONS TO BE TAKEN WITH, SUCH EQUIPMENT.

UNPACKING AND INITIAL INSPECTION

Our Packing Department uses custom designed packaging to send out your unit, but as accidents can still happen in transit, you are advised, after unpacking the unit, to inspect it for any sign of shipping damage, and confirm that your delivery is in accordance with the packing note. If you find any damage or that part of the delivery is missing notify us or our agent, and the carrier immediately. If the unit is damaged you should keep the packing for possible insurance assessment.

ELECTRICITY SUPPLY

Before connecting to the electricity supply please familiarise yourself with the parts of the handbook relevant to your model.

Your unit's supply voltage requirement is specified on a plate on the instrument along with the serial number. All Oceanus-6 instruments will work on an electricity supply frequency of 50Hz or 60Hz.



The apparatus is provided with an approved power cord. If the plug is not suitable for your location then the plug should be removed and replaced with an appropriate plug.

Take care to ensure the old plug is disposed safely.

The cable is colour coded as follows:

<u>COLOUR</u>	<u>FUNCTION</u>
Green/yellow	Earth (Ground)
Brown	Live (line)
Blue	Neutral

Please ensure that your unit is correctly connected to the electricity supply.

THE APPARATUS MUST BE CORRECTLY EARTHED (GROUNDED)

The units on/off switch is located on the power inlet. Take care NOT to switch the unit off when it is hot - allow to cool first.

INTRODUCTION

The Oceanus-6 range of products allows unprecedented flexibility for the calibration of temperature sensors. The Oceanus-6 range may be used with the following options:

1. An ITS-90 Fixed Point Apparatus
2. As a Metal Block Bath
3. As a Stirred Liquid Bath
4. As a Stirred Ice Bath
5. A Black Body Source
6. A Surface Sensor Calibrator

The Oceanus-6 is available in two variants. The Basic (B) model which incorporates a single temperature controller. The Potts as Site (S) model also include a temperature indicator and a timer.

COMPARISON CALIBRATION:

By definition, one compares industrial thermometers to a calibrated standard.

There are 3 methods commonly used.

1) **USING THE CONTROLLER**

Using the controller as the “calibrated standard” this method means that the complete bath is calibrated by comparing the controller reading to a calibrated standard placed in the bath.

This is a common method but is unsafe since the control sensor is

- a) inaccessible
- b) in the wrong place to give correct temperature of the insert

For these reasons it fails to satisfy ISO9000 and gives large uncertainties.

2) **USING THE INDICATOR - (Not Basic (B) Model)**

In these an indicator and external calibrated sensor are used to measure the temperature of the insert. This arrangement gives good accurate and reliable results. To recalibrate however it does mean sending the whole calibrator back to the calibration laboratory. This, the calibrator is self-contained, self-sufficient and meets ISO9000 requirements.

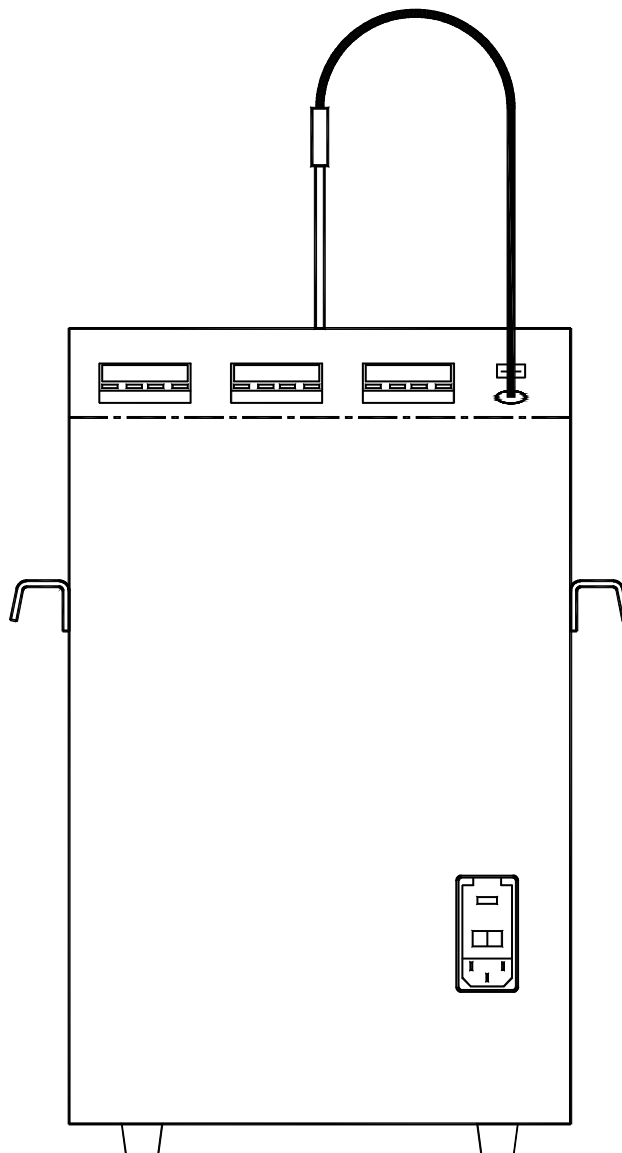

3) **USING EXTERNAL STANDARDS**

Here a separate indicator and calibrated sensor are used to measure the inserts temperature. This can give the most accurate and reliable results, depending on the indicator.

It means that the calibrator does not need calibrating only the indicator and it's calibrated sensor need re-calibration, but this option is more bulky, expensive and less portable than 2) above. It also meets ISO9000 requirements.

MODE OF OPERATION

1) **ITS-90 FIXED POINT CALIBRATION**

The ITS-90 fixed point function of the Oceanus-6 is well suited for fast, convenient, mess free calibration of thermometers to uncertainties as low as 0.001°C.

The special cell is placed into the Oceanus-6 calibration well. The stir speed control should be set to the OFF position.

The equipment incorporates a timer which can change temperatures to allow MELTING or FREEZING of a Gallium Cell. Once initiated the Cell can be arranged to be on the melt plateau during the day and automatically frozen and brought back to the melt plateau overnight.

For use with a Gallium Cell the well temperature should be 30.5°C for the MELT or 15°C for the FREEZE.

On power up the timer is set to run at setpoint 1 for 20 hours at setpoint 2 for 4 hours.

2) **METAL BLOCK BATH**

The metal block bath function of the Oceanus-6 is well suited for fast, convenient, mess free calibration of temperature sensors.

The Oceanus-6 metal insert is placed into the calibration well. The stir speed control should be set to the OFF position (turn fully anti-clockwise).

The thermometers under test are placed into suitable holes in metal insert (part number 580-06-03), see accessory section page 40. A calibrated reference probe should be placed into the insert and the actual temperature can be read from the temperature indicator.

For traceable calibration the actual value of the insert temperature should be recorded along with the values from the sensors under test.

3) **STIRRED LIQUID BATH**

The stirred liquid bath function of the Oceanus-6 is well suited for odd shaped sensors which will not easily be accommodated in a metal insert.

The Oceanus-6 Liquid Container (part number 580-06-07) is placed into the calibration well and the container is filled with a suitable liquid, see accessory section page 40 for the temperature range that the bath is to be used over. The container should be filled to 25mm from the top of the tank. Care must be taken to adjust the level as the liquid contracts or expands with temperature changes. The stirrer speed control is set ON and to the mid position. If necessary the speed can be adjusted to give the optimum value for a particular application, this position should be found experimentally and then noted for future use.

The thermometers under test are placed into the liquid. Two accessories are available to support the thermometers.

- a) The Thermometer Support Kit (part number 580-06-00) allows thermometers with a diameter of 2 to 6.5mm to be suspended in the liquid.
- b) The Sensor Guide which fits into the tank and can support a number of thermometers (part number 580-02-16).

It is important that one of the accessories is used to prevent the probes from reaching the bottom of the tank which would stop the stirring action. A calibrated reference probe should be placed into the liquid and the actual temperature can be read from the temperature indicator.

For traceable calibration the actual value of the liquid temperature should be recorded along with the values from the sensors under test.

4) **STIRRED ICE BATH**

The Stirred Ice Bath function is as the Stirred Liquid Bath. The liquid container - part number 580-06-07 is filled with water, the stirrer speed control set to mid-position and the controller set to 0.0°C. Once the controller has stabilized at 0.0°C allow 10-15 minutes before starting calibration.

5) **BLACK BODY SOURCE**

The black body function of the Oceanus-6 is well suited for fast, convenient, mess free calibration of infra-red temperature sensors.

The Oceanus-6 black body target (part number 580-02-12), see accessory section page 40 is placed into the calibration well. The stir speed control should be set to the OFF position.

The units under test should be aligned with the target.

A calibrated reference probe should be placed into the hole in the block and the actual temperature can be read from the temperature indicator to which the infra red thermometer(s) are compared.

6) **SURFACE SENSOR CALIBRATION**

The surface sensor function of the Oceanus-6 is well suited for fast, convenient, mess free calibration of most surface temperature sensors.

The Oceanus-6 surface sensor insert (part number 580-02-11), see accessory section page 40, is placed into the calibration well. The stir speed control should be set to the OFF position.

A calibrated probe (part number 935-14-84) is placed in the pocket of the surface sensor insert and connected to the temperature indicator. Surface sensors are placed on top of the insert and when stable compared to the calibrated probe.

ADJUSTING THE TIMER

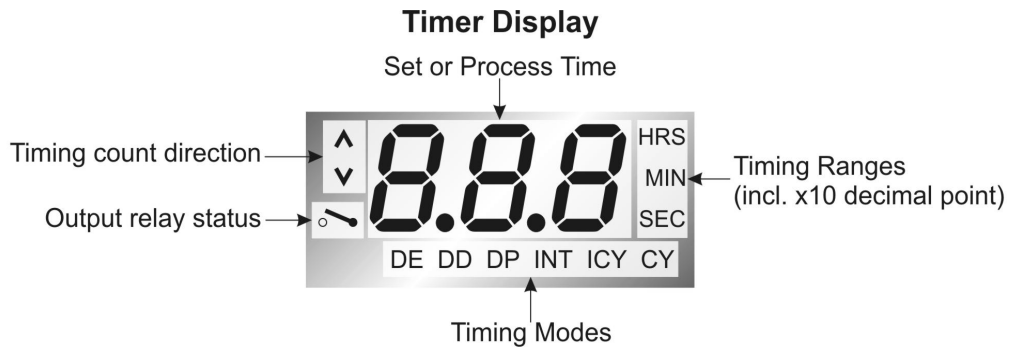

Programming the Timer (not Basic models)

- ① Remove the Power Supply from the Unit.
- ② Press down and hold the SET button for five seconds, until the timing mode currently selected begins to flash.
- ③ Press the Up Arrow button until ICY+ is flashing and press SET to select.
- ④ The decimal place and timing ranges should now be flashing, with the ICY+ symbol showing in timing mode area. Use the Up Arrow until the timing range is set to HRS (hours) and the Set Time is set for a single decimal place. Press the SET button to proceed.
- ⑤ The decimal place and timing ranges should now be flashing, with the ICY- symbol showing in timing mode area. Use the Up Arrow until the timing range is set to HRS (hours) and the Set Time is set for a single decimal place. Press the SET button to proceed.
- ⑥ The display will now flash the ^ or the v symbol in the top left corner. Use the Up Arrow button to alternate between the two. Press SET to select. The ^ means that when operating the display will show the time elapsed, and v means that the display will show the time remaining.
- ⑦ Now with ICY+ showing the first digit will be flashing. To set the time spent freezing use the Up Arrow button to select the required value. Press SET. The Second digit will now flash, use the Up Arrow button to select the required value. Press SET. The last digit will now flash, set the final digit with the Up Arrow button and press SET to proceed.
- ⑧ Now with ICY- showing the first digit will be flashing. To set the time spent melting use the Up Arrow button to select the required value. Press SET. The Second digit will now flash, use the Up Arrow button to select the required value. Press SET. The last digit will now flash, set the final digit with the Up Arrow button and press SET.
- ⑨ The display will now become blank. The setup is complete and the unit is now ready for use.
- ⑩ Upon powering up the unit will begin to freeze.

USING WATER & GALLIUM FIXED POINT CELLS

WATER TRIPLE POINT CELL

The adapter rings should be fitted above and below the cell so that the cell sits centrally in the block. The top of the well should then be thermally insulated with foam expanded polystyrene, tissue paper etc.

Switch on the Oceanus and set the temperature to -7°C . The Oceanus-6 will cool much quicker than the cell because there is an air gap between the cell and the block, therefore monitor the temperature of the cell using a thermocouple or resistance thermometer inside the cells re-entrant tube.

When the cell has reached about -6°C gently remove the cell from the Oceanus-6 and supporting the base of the cell in one hand, gently flick the top of the cell to one side, where upon ice forms and the temperature rises to the triple point value. In order to stabilise the ice mush which tends to rise to the surface, the cell is returned to the bath at -7°C . It is left there for ten minutes to stabilise. The cell is then briefly removed from the block. A small amount of ambient temperature alcohol introduced into the reentrant tube of the cell (washing the reentrant tube walls as it is introduced) will free the ice mantle from the reentrant tube. The outer surface of ice is then warmed by hand until the sheath of ice is free to rotate. A gentle axial twist of the cell will confirm the mantle is free. The cell is returned quickly to the Oceanus-6 block and the temperature increased to about -1°C . This gradually causes the ice to grow back to the outer wall of the cell and compensates for coolth losses from the thermometers being calibrated.

The cell should be periodically inspected and if necessary, the ice sheath freed from the wall of the cell.

There is nothing sacrosanct about the above procedure and provided between $\frac{1}{3}$ and $\frac{2}{3}$ of the cell is ice then the triple point calibration is valid.

The best temperature to maintain the cell can be found only after use.

It will depend on:

1. The number of sensors being calibrated.
2. The ambient temperature.

If, at any time, an ice bridge forms on the surface of the water in the cell, the cell may rupture. The likelihood of this happening is small since the surface of the cell is above the block of the Oceanus-6, however the cell should be checked regularly.

The accuracy with which the cell may be used to check a thermometers calibration may, in practice, be limited by the extent of its immersion in the cell, or by the self-heating of the thermometer. The magnitude of these effects may be checked (i) by reducing the immersion depth and (ii) by making measurements at two currents through the thermometer.

LARGE GALLIUM CELL

The adapter rings should be fitted above and below the cell so that the cell sits centrally in the block. The top of the well should then be thermally insulated with foam expanded polystyrene, tissue paper etc.

Set the Oceanus-6 to give a well temperature of approximately 32°C. Monitor the Cell until the Gallium starts to melt, at this stage the well temperature can be lowered to 30.5°C which will give a long melt plateau.

This two step procedure will lead to a rapid melt and long plateau. At the end of the plateau the setpoint should be set to 15°C to freeze the Cell. It is essential the Cell freezes from the bottom upwards. Leaving the Cell in the Oceanus-6 until it is frozen will ensure this happens and eliminates the possibility of the cell being damaged by the expansion of the Gallium during the freeze.

NB. For the flattest melt plateau, remove the cell from the Oceanus-6 and freeze by standing the bottom third of the cell in crushed ice or an ice/water mixture. Once frozen it can be melted as before but first make sure the cell is thoroughly dry before re-introducing into the Oceanus-6.

The operation can be automated - see page 24.

The accuracy with which the cell may be used to check a thermometers calibration may, in practice, be limited by the extent of its immersion in the cell, or by the self-heating of the thermometer. The magnitude of these effects may be checked (i) by reducing the immersion depth and (ii) by making measurements at two currents through the thermometer.

SLIM GALLIUM CELL

Please see separate handbook for this cell.

THERMOMETRIC FIXED POINTS (a tutorial note)

Temperature scales used in science and industry are defined by a series of "fixed points", which are realised by establishing thermal conditions under which pure materials exhibit equilibrium between two or three phases. A scale assigns numerical values to the temperatures at which these phase equilibria exist. For example, the temperature at which pure water exists simultaneously in its liquid, solid and gas phases (triple point) has been assigned the numerical value of 0.01°C on the International Temperature Scale, and the value of 273.16K on the Kelvin Thermodynamic Temperature Scale. Examples of other defining fixed points of the International Temperature Scale of 1990 are the respective liquid-solid equilibria of tin, zinc and silver under 1 standard atmosphere pressure.

In some important disciplines it is desirable to realise a thermometric fixed point between 0 and 100°C, frequently in the vicinity of body or environmental-temperature. The melting temperature of high purity gallium, 29.7646°C, is a fixed point that can be useful in this context.

The solid-liquid equilibrium point of gallium is realised in cells such as those shown in figure 1 or reference 2. A quantity of pure gallium is contained in a vessel which provides, also, a re-entrant well for insertion of a thermometer. The cycle for realising the melt equilibrium is as follows:

The gallium starts in a single phase, assumed for present purposes to be liquid. The cell is placed in a cold environment until the gallium has solidified. The phase-change of the metal can be determined by tracing the temperature of the well. As the metal cools from the liquid phase, the temperature will begin to fall. An initial smooth drop in temperature will be observed, and then at some temperature below the freezing temperature there will be seen a reversal and a subsequent rise in temperature. This "undercool" phenomenon is characteristic of many pure materials, most of which can remain liquid at temperatures below their normal freezing points (if the metal were initially solid, the temperature would fall uninterruptedly to that of the cold environment).

The reversal takes place as the first crystalline solid forms in the liquid; the temperature rises to the liquid-solid equilibrium plateau temperature as the metal gives up latent heat on freezing, remaining thereafter at this temperature until the metal is completely solid. Beyond this stage there will be a smooth drop in temperature to that of surrounding environment.

To establish the melting condition, the cell is then transferred to an environment maintained at a temperature slightly above the melt temperature of gallium. This environment may be a stirred fluid bath of sufficient heat capacity and control capability, or may be the Oceanus-6 POTTS or Gallium Temperature Standard Apparatus Model 17402B which is designed automatically to raise the temperature of the cell to initiate melting of the metal and then to maintain it at a correct level. The temperature to which the cell is exposed to melt the metal does not determine the solid-liquid equilibrium temperature, but it can have a substantial effect on the duration of the (constant-temperature) melt plateau.

The monitoring thermometer will indicate a rise in temperature in the well as the solid gallium approaches the melt temperature. Then, beyond the instant at which liquid first begins to form, the temperature will remain constant until all the metal has melted. The end of the melt plateau is signalled by a rise in well temperature to the temperature of the surrounding environment. An ITL 17401 gallium cell used in the Model 17402B system can give a plateau duration of at least 12 hours.

The melting cycle is now complete. The material in the cell is entirely in the liquid phase. Another cycle may be started immediately, if desired.

17cc of water should be poured into the re-entrant tube to allow proper conduction between cell and thermometer.

For the highest accuracy measurements (to less than 0.1mK of the ITS-90 value) an hour should elapse between switching to melt and commencing measurements. Alternatively, once the melt has begun the water in the well can be replaced by warm water at say 40°C to initiate a melt round the re-entrant tube. See CCT96/8 for additional guidance.

HINT

HOW TO MEASURE THE TRUE TEMPERATURE INSIDE THE ACCESSORIES SUPPLIED WITH THE OCEANUS-6 SERIES

The controller of the Oceanus-6 controls and reads the temperature of the block surrounding the 50mm \varnothing by 300mm deep calibration well.

There are various accessories including the surface calibration insert, the oil container, black body etc. These adapt the Oceanus-6 to perform varied calibration functions.

None of these accessories actually get to the block temperature and hence the controller's temperature because each accessory has a different immersion characteristic. For this reason the Oceanus-6 like all comparison baths requires a reference thermometer to indicate the true temperature inside the accessory.

Remember the following:-

THE CONTROLLER

The controller is used to set a constant temperature and create an isothermal environment for the comparison calibration of temperature sensors.

THE REFERENCE THERMOMETER

The Reference Thermometer is placed in the accessory or insert and measures the true temperature inside the insert or accessory.

THE INDUSTRIAL THERMOMETER

The Industrial thermometer is placed in the accessory or insert and is compared to the True Temperature as indicated by the reference thermometer. An insert will typically have a 1% immersion error. For more details see - Depths of Immersion. Tavener J. P. Volume 9.2. Isotech Journal of Thermometry pages 79-87.

SPECIFICATION

Voltage	:	230VAC (<u>or</u> 115VAC) see ratings plate
Power	:	300W
Supply Frequency	:	50/60Hz
Maximum Operating Temperature	:	110°C
Minimum Operating Temperature	:	45°C (below ambient)
Stability (Absolute over 30 Minutes)		
Metal Block Bath	:	±0.03°C
Stirred Liquid	:	±0.025°C
Black Body Source	:	±0.3°C
Surface Sensor Calibrator	:	±0.5°C
ITS-90 Fixed Point Apparatus	:	±0.0002°C
Ice/Water Bath	:	±0.001°C
Calibration Volume	:	50mm dia by 300mm deep
Standard Insert Hole Dimensions:	:	6 x 8mm
Insert Options	:	Adjustable Height Equalising Block
	:	Special drilling available to customer requirements.
	:	Blank
Dimensions (not including handle)	:	Height 430mm
	:	Width 310mm
	:	Depth 300mm
Weight	:	17Kg

OCEANUS-6 PERFORMANCE GRAPH

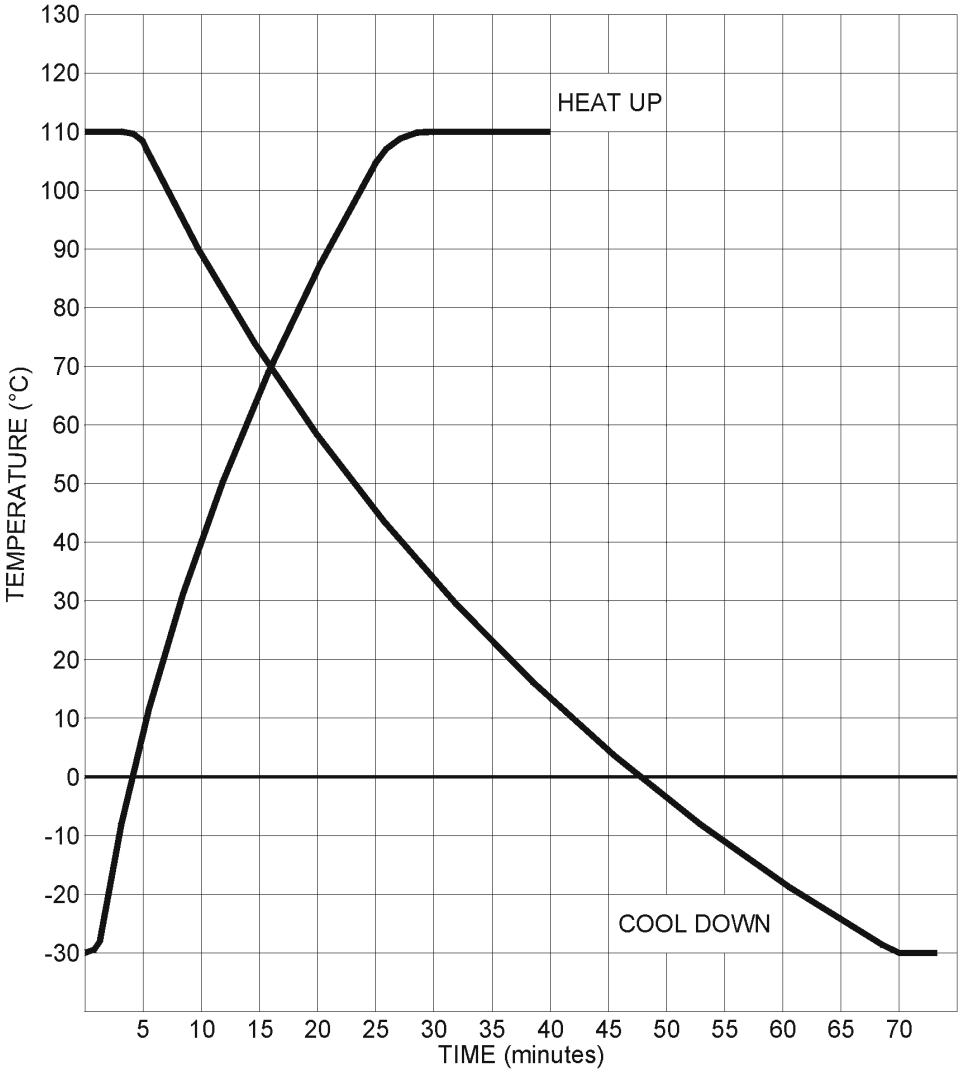

OPERATING THE OCEANUS-6

FRONT PANEL LAYOUT

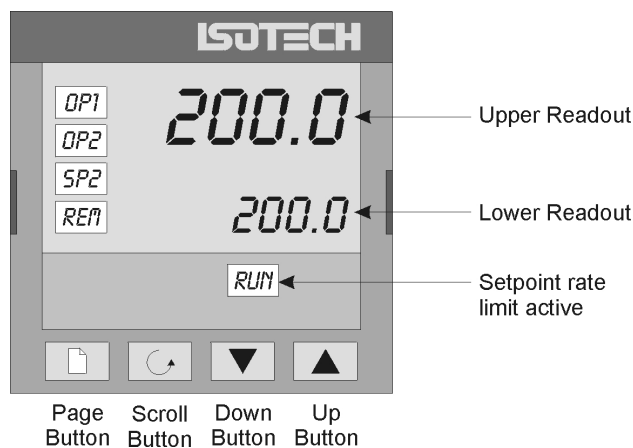

The Temperature Controller

The controller has a dual display, the upper display indicates the nominal block temperature, and the lower display indicates the desired temperature or setpoint.

Altering the Setpoint

To change the setpoint of the controller simply use the UP and DOWN keys to raise and lower the setpoint to the required value. The lower display changes to indicate the new setpoint.

Press scroll button to select setpoint 1 (SP1) or setpoint 2 (SP2).

Advanced Controller Features

Setpoint Ramp Rate

By default the Dry Blocks are configured to heat (and cool) as quickly as possible. There may be some calibration applications where it is advantageous to limit the heating (or cooling rate).

An example might be when testing bimetallic thermostats, by forcing the Dry Block to heat at a controlled rate it is easier to determine the temperature at which the thermostat changes state.

The Dry Block can have its heating rate limited with the Setpoint Ramp Rate feature. This feature is accessed from the Scroll key. Depress the key until the display shows,

SPrr

On the Upper Display, the lower display will show the current value from OFF (default) to 999.9. The desired rate is set here with the UP and DOWN keys, the units are °C/min.

When the SPrr is active the controller display will show "RUN", the lower setpoint display will now automatically update with the current value, known as the working setpoint. The setpoint can be seen by pressing either the UP and DOWN key.

The Setpoint ramp rate operates when the bath is heating and cooling.

Instrument Address

The controller has a configurable "address" which is used for PC communications. Each instrument has an address, this allows several instruments to be connected in parallel on the same communications bus. The default value is 1. This address would only need to be changed if more than one Dry Block is connected to the same PC port.

To check the Address value press the scroll key until the top display indicates,

Addr

The lower display will show the current value that can be modified with the UP and DOWN keys.

Monitoring the Controller Status

A row of beacons indicate the controllers status as follows,

OP1	Heat Output
OP2	Cool Output (Only for models which operate below 0°C)
REM	This beacon indicates activity on the PC interface

Units

Momentary pressing the Scroll key will show the controller units °C or °F.

The Temperature Indicator (Not Basic (B) Models)

The site models include an electronic temperature indicator. The indicator can be configured for the desired sensor type, and for custom calibration data. The customer calibration data can be set ON or OFF.

Setting the Input Type

A 100 Ohm resistance thermometer can be connected to the PRT Connector or a thermocouple may be connected to the miniature TC Connector.

Ensure that only a PRT or a TC is connected at any one time. If a PRT and TC are



connected simultaneously the indicator will read in error.

Check that any sensor placed into the Oceanus-6 is suitable for the temperature range. Sensors can be damaged if taken outside their normal operating limits.

The desired sensor type is easily set, press the Scroll key until the upper display indicates,

inPt

On the upper display. The lower display will show the current set sensor type,

J.tc	J thermocouple
K.tc	K thermocouple
L.tc	L thermocouple
r.tc	R thermocouple (Pt/Pt13%Rh)
b.tc	B thermocouple (Pt30%Rh/Pt6%Rh)
n.tc	N thermocouple
t.tc	T thermocouple
S.tc	S thermocouple (Pt/Pt10%Rh)
PL.2	PL 2 thermocouple
rtd	100Ω platinum resistance thermometer.
T012	E thermocouple

Again the value can be modified with the UP and DOWN keys.

Enabling / Disabling Custom Calibration

Custom calibration allows the indicator to be programmed to suit a particular temperature sensor. This allows the indicator to automatically show the true temperature, without having to manually apply a correction.

When the Custom or User Calibration is active the indicator will show the REM beacon lit continuously. The use of User calibration can make a significant difference to the accuracy of the instrument, and this REM beacon provides a clear and continuous indication of the calibration status. Isotech will configure and set user calibration when the Dry Block is ordered with a temperature sensor.

To alter the calibration status press the Scroll key until the upper display shows,

CAL

The lower display will indicate either,
USER for user calibration

Or

FACT for factory calibration of the indicator, i.e. User Cal OFF

Use the UP and DOWN keys to toggle between the two values.

When calibrating an unknown sensor against a calibrated probe it may be necessary to switch the calibration off for the unknown, and on for the calibrated probe.

Instrument Address

Like the controller, the indicator has a configurable "address" which is used for PC communications. Each instrument has an address; this allows several instruments to be connected in parallel on the same communications bus. The default value is 2 (The controller defaults to 1). This address would only need to be changed if more than one Dry Block is connected to the same PC port.

To check the Address value press the scroll key until the top display indicates,

Addr

The lower display will show the current value that can be modified with the UP and DOWN keys.

Monitoring the Indicator Status

For the indicator the REM beacon is lit continuously when the user calibration is active, the REM beacon flashes when the PC communications port is active.

Units

Momentary pressing the Scroll key will show the controller units °C or °F.

Advanced Indicator Operation

The indicator can be configured with up to five custom calibration points; the points contain "data pairs". First the temperature (point) and secondly the Error (offset) at this temperature point. Isotech Dry Block calibration certificates will show the values to suit a particular sensor.

These values can be inspected, and modified with the following procedure,

Press the PAGE key until the display indicates,

ACCS
LiSt

Press the SCROLL key until the display shows,

Goto
OPEr

Press the UP key until the display shows

Goto
conF

Press the Scroll Key twice, when the display will show,

inSt
Conf

Press the Page Key until the controller shows

CAL
Conf

Now use the Scroll key to examine the data pairs. The values can be modified with the UP and DOWN keys.

To exit this mode press the Page key until the top display shows,

Exit

And then set the lower display to YES. While in this mode take care not to modify other parameters - a full list of all the parameters can be found in appendix 2.

CALIBRATION DATA EXAMPLE

A maximum of five points may be entered, shown as Pnt 1 to Pnt 5 for the temperature point and Ofs 1 to Ofs 5 for the offset values.

The Pnt values must be entered in ascending order.

Set a Pnt to a value lower than the previous point to disable it.

The indicator would be programmed with the following data:

Pnt 1	100	Ofs 1	0.8
Pnt 2	300	Ofs 2	1.1
Pnt 3	500	Ofs 3	2.1
Pnt 4	-999	Ofs 4	0
Pnt 5	-999	Ofs 5	0

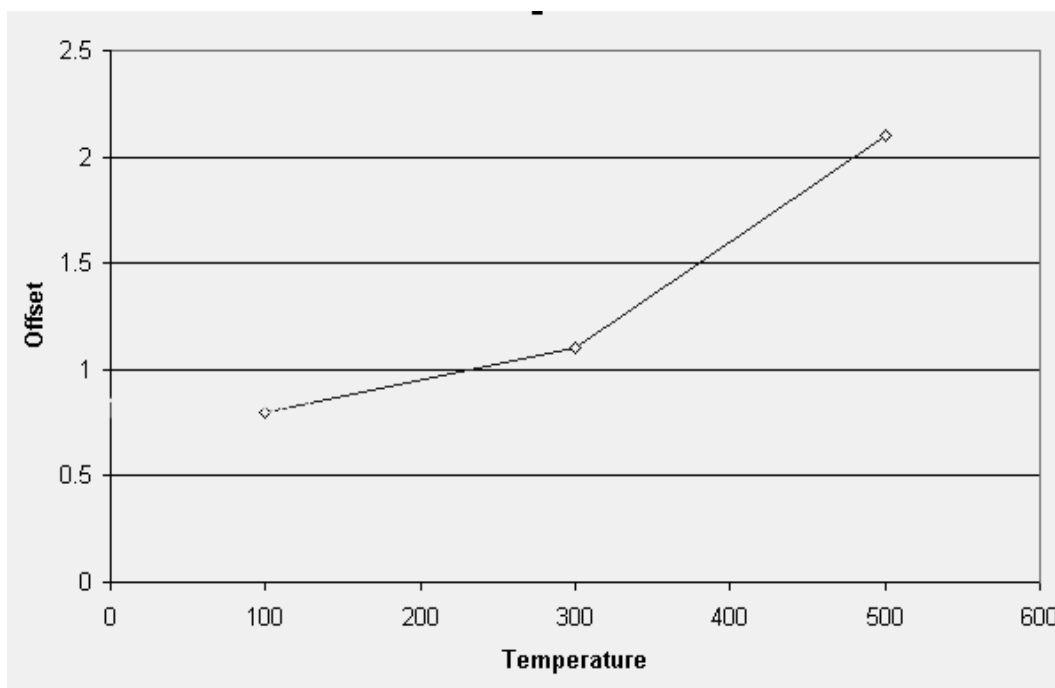

CONNECTING A CURRENT TRANSMITTER (UP TO 20MA)

The transmitter should be powered externally, a 2.49Ω current sense resistor is fitted internally and this allows the indicator to read mA.

1. From the input type menu select “mV”.
2. Access configuration level.

SELECTING CONFIGURATION LEVEL

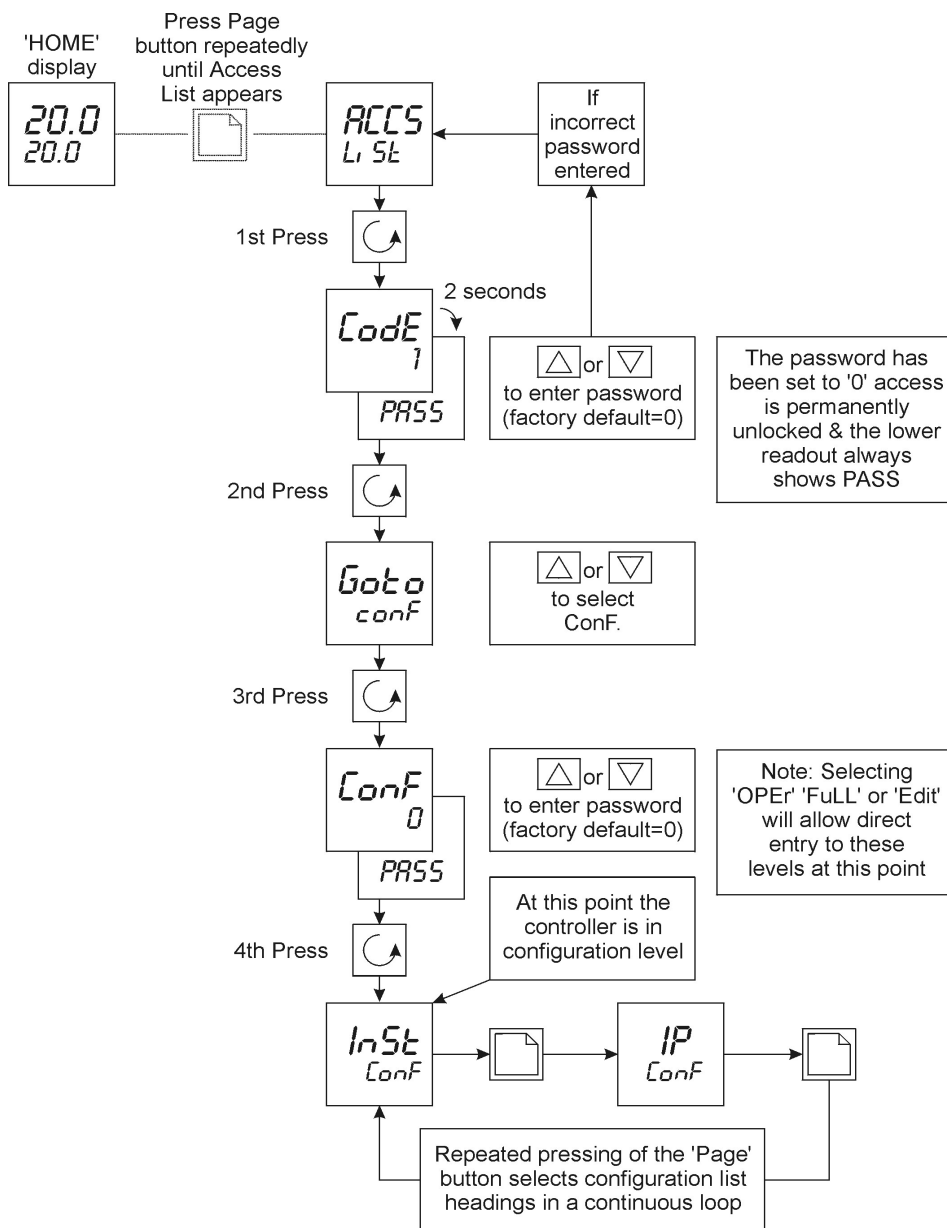

From the input menu iP set the inP.L, inP.H, VAL.L and VAL.H parameters to suit see table below:

Linear Input Scaling - The next 4 parameters only appear if a linear input is chosen																			
e.g. 4 to 20mA = 0 to 100°C																			
	inP.L	Input value low	i.e. 4mA set 9.96																
	inP.H	Input value high	i.e. 20mA set 49.8																
	VAL.L	Displayed reading low	0°C																
	VAL.H	Displayed reading high	100°C																
<p>E.g. 4-20mA = 0 to 100°C</p> <table> <tr> <td>inP.L</td> <td>=</td> <td>9.96 (mV)</td> <td>(4mA x 2.49Ω)</td> </tr> <tr> <td>inP.H</td> <td>=</td> <td>49.8 (mV)</td> <td>(20mA x 2.49Ω)</td> </tr> <tr> <td>VAL.L</td> <td>=</td> <td>0 (°C)</td> <td></td> </tr> <tr> <td>VAL.H</td> <td>=</td> <td>100 (°C)</td> <td></td> </tr> </table>				inP.L	=	9.96 (mV)	(4mA x 2.49Ω)	inP.H	=	49.8 (mV)	(20mA x 2.49Ω)	VAL.L	=	0 (°C)		VAL.H	=	100 (°C)	
inP.L	=	9.96 (mV)	(4mA x 2.49Ω)																
inP.H	=	49.8 (mV)	(20mA x 2.49Ω)																
VAL.L	=	0 (°C)																	
VAL.H	=	100 (°C)																	

Exit config level by pressing PAGE key until the top display shows Exit, use the UP key to select YES, after two seconds the instrument will reset.

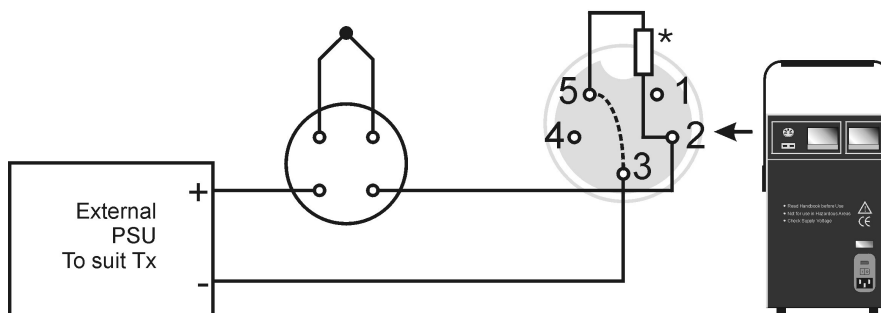

*2.49Ω resistor fitted internally (Pins 2 and 5).
Link Pins 3 and 5 for transmitter inputs.
Remove link for T/C's and PRT's.
Socket Pins shown from Panel View

Testing Thermostats

The Site model can be used the Isotech Cal Notepad software for the testing of thermostats and other thermal switches with volt free contacts. Cal Notepad can capture the temperature at which a switch opens or closes. It can also perform a hysteresis test. Refer to the Cal Notepad manual for details. Ensure only voltage free contacts are connected. Do not allow any voltage signal to be connected - doing so many damage the equipment and present a safety hazard.

Using the PC Interface

The Plus models include an RS422 PC interface and a special converter cable that allows use with the a standard RS232 port. When using the bath with an RS232 port it is essential that this converter cable is used. Replacement cables are available from Isotech, part number ISO-232-432. A further lead is available as an option, Part Number ISO-422-422 lead which permits up to 5 instruments to be daisy chained together.

The benefit of this approach is that a number of calibration baths may be connected together in a "daisy chain" configuration - and then linked to a single RS232, see diagram.

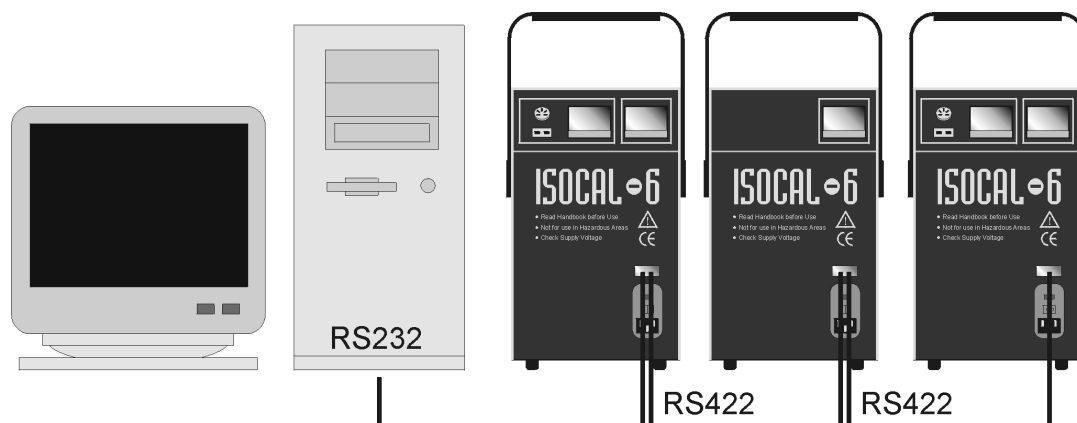

Note: The RS 422 standard specifies a maximum lead length of 1200M (4000ft). A true RS422 port will be required to realise such lead lengths. The Isotech conversion leads are suitable for maximum combined lead lengths of 10M that is adequate for most applications.

Connections

For RS232 use simply connect the Isotech cable, a 9 to 25 pin converter is included to suit PCs with a 25 pin serial converter.

RS422 Connections

Pin	Connection
4	Tx+ A
5	Tx- B
8	Rx+ A
9	Rx- B
1	Common

Using the Interface

The models are supplied with Cal NotePad as standard. This easy to use package is compatible with MS Windows 9x. A handbook for Cal NotePad can be found on the first installation disk in Adobe PDF format. If required a free Adobe PDF reader can be downloaded from, www.adobe.com.

CAL NOTEPAD

Cal Notepad can be used to log and display values from the Dry Blocks and an optional temperature indicator.

Minimum System Requirements

CNP requires Windows 95 / 98, a minimum of 5Mb of free hard drive space and free serial ports for the instruments to be connected.

Development

CNP was developed by Isothermal Technology using LabVIEW from National Instruments.

License

Use of the Cal NotePad software program "CNP" is as granted in this license agreement. In using the CNP

software the user "licensee" is agreeing to the terms of the license. You must read and understand the terms of this license before using CNP.

1, This license permits licensee to use CNP software on a single computer. The user may make copies for back up and archival purposes freely as long as the software is only ever in use on a single computer at any one time. Please enquire about multi-user licenses.

2, CNP is protected by international copyright laws and treaties. CNP must not be distributed to third parties.

3, CNP must not be reversed engineered, disassembled or de-compiled. Licensee may transfer the software to a third party provided that no copies or upgrades of CNP are retained.

4, It is the responsibility of the user to ensure the validity of all stored results and printed certificates. Isothermal Technology Ltd accept no responsibility for any errors caused by inappropriate use, incorrect set up or any other cause; including defects in the software.

5, Limited Warranty. Isothermal Technology warrants that CNP will perform substantially as described in this manual for a period of 90 days from receipt. Any distribution media will under normal used be guaranteed for a period of 90 days.

NO OTHER WARRANTIES, EXCEPT AS STATED ABOVE. The software and documentation is provided "as is" without warranty of any kind and no other warranties (either expressed or implied) are made with regard to CNP. Isothermal Technology does not warrant, guarantee or make any representations regarding the use or results of the use of the software or documentation and does not warrant that the operation of CNP will be error free.

In no event will Isothermal Technology, its employees, agents or other associated people be liable for direct, indirect, incidental or consequential damages, expenses, lost profits, business interruption, lost business information or other damages arising out the use or inability to use CNP. The license fee reflects this allocation of risk.

CNP is not designed for situations where the results can threaten or cause injury to humans.

Installing Cal NotePad

- 1 Insert CNP DISK 1 into the disk drive
- 2 Click on the START button on the task bar, select RUN, type A:\SETUP (Where A: is your drive letter) then click OK
- 3 Follow the prompts which will install the application and necessary LabVIEW run time support files.
- 4 Should you ever need to uninstall the software then use the Add/Remove Programs option from the Control Panel.

Starting Cal NotePad

From a Standard Installation:

Click the START button

Highlight PROGRAMS

Select Isotech - Select Calpad

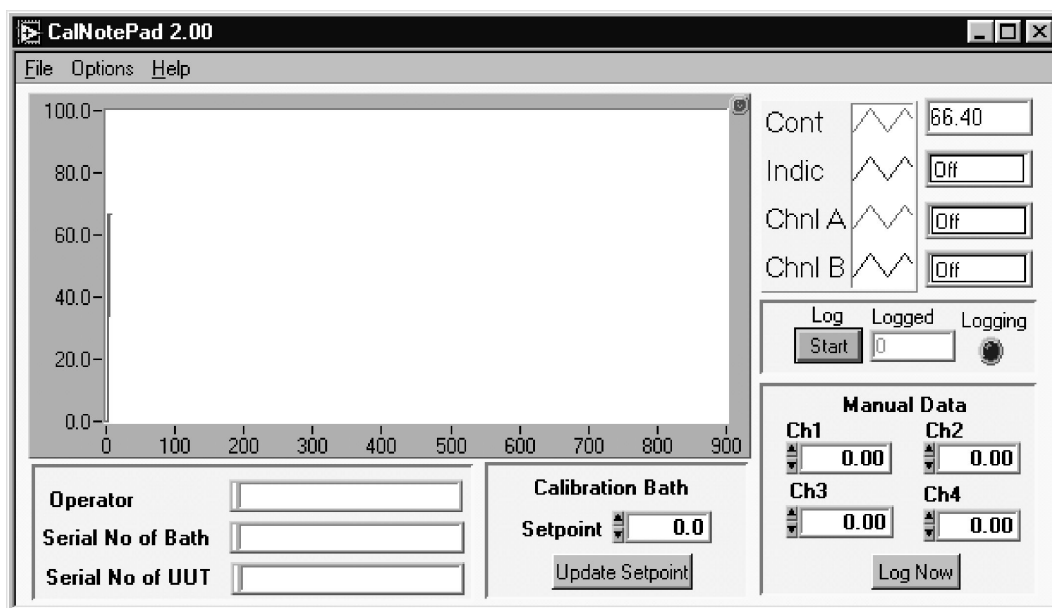

Protocol

The instruments use the "Eurotherm EI BiSynch Protocol"

If required, e.g. for writing custom software the technical details are available from our website at, www.isotech.co.uk/refer.html

Diagnostic alarms

These indicate that a fault exists in either the controller, indicator or the connected sensor.

Controller Error Messages

The instruments include powerful diagnostics and in the unlikely event of an internal failure, or a sensor error, one of the following error messages may be displayed.

Display shows	What it means	What to do about it
EE.Er	<i>Electrically Erasable Memory Error:</i> The value of an operator or configuration parameter has been corrupted	For Controller: Contact Isotech For Indicator: Check Config Against Data in Appendix
S.br	<i>Sensor Break:</i> Input sensor is unreliable or the input signal is out of range.	For Controller: Contact Isotech For Indicator: Check a sensor is connected. Check that only a PRT or a TC is Connected (Not both)
HW.Er	<i>Hardware error :</i> Indication that a module is of the wrong type, missing or faulty	Contact Isotech
LLLL	<i>Out of Display range, low reading</i>	For Controller: Contact Isotech For Indicator: Check Sensor and Connections
HHHH	<i>Out of Display range, high reading</i>	For Controller: Contact Isotech For Indicator: Check Sensor and Connections
Err1	<i>Error 1: ROM self-test fail</i>	Consult Isotech
Err2	<i>Error 2: RAM self-test fail</i>	Consult Isotech
Err3	<i>Error 3: Watchdog fail</i>	Consult Isotech
Err4	Error 4: Keyboard failure Stuck button, or a button was pressed during power up.	Switch the power off and then on without touching any of the controller buttons.
Err5	<i>Error 5: Input circuit failure</i>	Consult Isotech
Pwr.F	<i>Power failure.</i> The line voltage is too low	Check that the supply to the controller is within the rated limits

INITIAL TESTING

This unit was fully tested before despatch to you but please check its operation as outlined below.

After connecting the Oceanus-6 to the electricity supply, the temperature controller display will show the temperature of the block and the last set-point value. The controller and indicator both go through a self-test sequence first.

Change the set-point to 50°C and observe that the block temperature rises and settles to this value. Place a thermometer in the insert in the block and connect it to the suitably configured indicator. Confirm that the indicator agrees within $\pm 2^\circ\text{C}$ of the controller.

Your unit should have performed as described above and can now be used for calibration.

If any problems or faults arise during these tests please contact us or our agents for help and advice.



IMPORTANT NOTICE

The controller's function settings are preset and will not require adjustment.

The Oceanus-6 uses a powerful fan to cool the heat sinks inside the unit. This fan is located under the block assembly and should under no circumstances, be restricted. Restriction of this fan will impair the performance of the unit.

The Oceanus-6 uses Solid State Heat Pumps to drive the temperature range. These pumps to drive the temperature range. These pumps are very fragile and should be considered when lowering heavy objects into the well.

MAINTENANCE

Maintenance is limit to keeping the apparatus and the calibration volume clean and free from debris.

There are no internal user serviceable parts.

Repair and maintenance must be carried out by Isothermal Technology Limited or an approved agent.

FIGURE 1

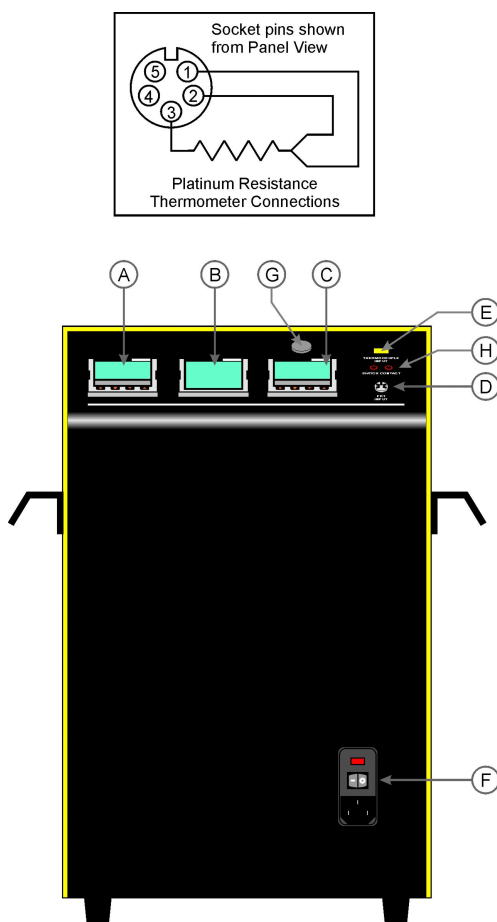

- A Platinum Resistance Thermometer Connector
- B Stir Speed
- C Switch Contact (Thermostat)
- D Thermocouple Connector
- E Temperature Indicator
- F Temperature Controller
- G Communications Connector
- H On/Off Switch
- I Power Entry and Fuse



Note: Only connect a thermocouple or platinum resistance thermometer to the input connectors. Ensure that only one sensor is connected at any time.

APPENDIX 1

OCEANUS-6 SERIES

TROUBLE SHOOTING

1. **Unit fails to operate**

Check fuse, Figure 1. If fuse blows repeatedly consult Isotech or local agent.

2. **Will not cool properly**

Check room temperature. Minimum operating temperature of 45°C below ambient, eg. -25°C at room temperature of 20°C.

3. **Indicator reads incorrectly**

Two sensors connected simultaneously.
Indicator incorrectly configured - see page 25 to 27.

4. **Unit unstable**

Control parameters have been interfered with - consult your local agent.

5. **Cannot establish PC Communications**

For RS232 you must use the Isotech adaptor cable.
Ensure the addresses of the controller and indicator match those set in Cal Notepad.
Ensure each controller and indicator are set to a unique address.
See page 30 and the Cal Notepad manual for further details.

APPENDIX 2

INDICATOR CONFIGURATION (Reference Only)

Config.INST

Name	Description	Value
unit	Instrument Units	°C (0)
dEcP	Decimal Places in Display	NN.NN
Ctrl	Control Type	PID (0)
Act	Control Action	REV (0)
COOL	Cooling Type	LIN (0)
PwrF	Power Feedback Enable	OFF (0)
Pdtr	Manual/Auto Transfer PD Control	NO (0)
FoP	Forced Output Enable	NO (0)
Sbrt	Sensor Break Type	SB.OP (0)
rnGH	Process Value High Limit	670
rnGL	Process Value Low Limit	0.00

Config.IP

Name	Description	Value
inPt	Linearisation Type	RTD
CJC	CJC Type	(EXT)
imP	Sensor break impedance	AUTO (1)

Config.CAL

Name	Description	Value
UCAL	User Calibration Enable	YES (1)
Pnt1	User Cal Point 1	0
Pnt5	User Cal Point 5	-99.00
OFS1	User Cal Offset 1	0.00
Pnt2	User Cal Point 2	-99
OFS2	User Cal Offset 2	0.00
Pnt3	User Cal Point 3	-99
OFS3	User Cal Offset 3	0.00
Pnt4	User Cal Point 4	-99.00
OFS4	User Cal Offset 4	0.00
OFS5	User Cal Offset 5	-99.00

Note: User Cal values are unique to each instrument. If available set values to those from calibration certificate

Config.AL

Name	Description	Value
AL_1	Alarm 1 Type	OFF (0)
Ltch1	Alarm 1 Latching	NO (0)
AL_2	Alarm 2 Type	OFF (0)
Ltch2	Alarm 2 Latching	NO (0)
AL_3	Alarm 3 Type	OFF (0)
Ltch3	Alarm 3 Latching	NO (0)
AL_4	Alarm 4 Type	OFF (0)
Ltch4	Alarm 4 Latching	NO (0)

Config.HA

Name	Description	Value
id	Module Identity	CMS (7)
Func	Module Function	CMS (65)
bAud	Baud Rate	9600 (0)
Prty	Comms Parity	NONE (0)
rES	Comms Resolution	FUL (0)

Config.1A

Name	Description	Value
id	Module Identity	LOG (3)
Func	Module function	NONE (0)
SEnS	Sense of Output	NOR (0)

Config.2A

Name	Description	Value
id	Module Identity	LOG (3)
Func	Module function	NONE (0)
SEnS	Sense of Output	NOR (0)

APPENDIX 3
ACCESSORIES PARTS LIST

OPTION 1

Standard Dry Block Insert 580-06-03

OPTION 2 & 3

Liquid Container Kit 580-06-07
Liquid Container 580-02-14
Magnetic Followers 932-12-60
Sealing Collar (O Ring) 932-12-59
Sensor Guide 580-02-16
Liquid in Glass Thermometer Support Kit 580-06-00
Gantry 580-02-17
Blank Disc 580-02-21A
Drilled Disc 580-02-21
3 x Gantry Plugs 820-02-24
3 x O Seals 932-12-49

OPTION 4

Black Body Target 580-02-12

OPTION 5

Surface Sensor Insert Calibrator Kit 580-06-08
Surface Sensor Insert 580-02-11
Surface Sensor Probe 935-14-84

OPTION 6

Slim Gallium Cell 17401M
Slim Water Triple Point Cell C12

C20 Oil 580-06-09
Standard Probe for On-site Model 935-14-85
Carrying Case 931-22-58

**LIQUID IN
 GLASS
 THERMOMETER
 SUPPORT
 KIT - 580-06-00**

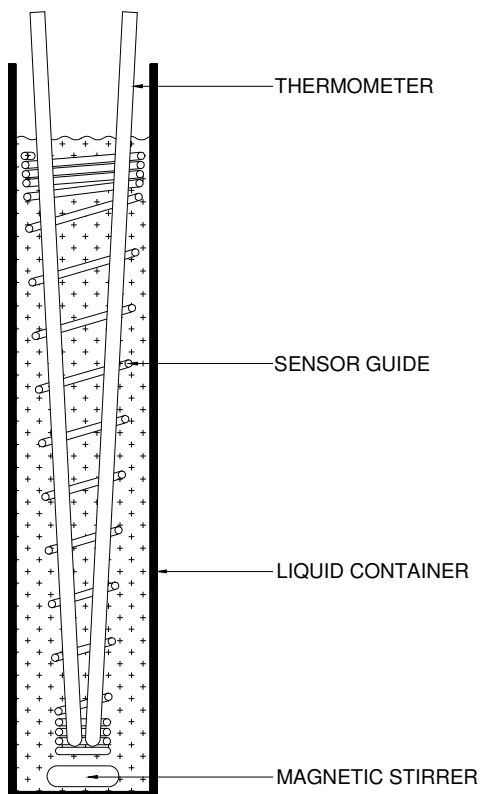
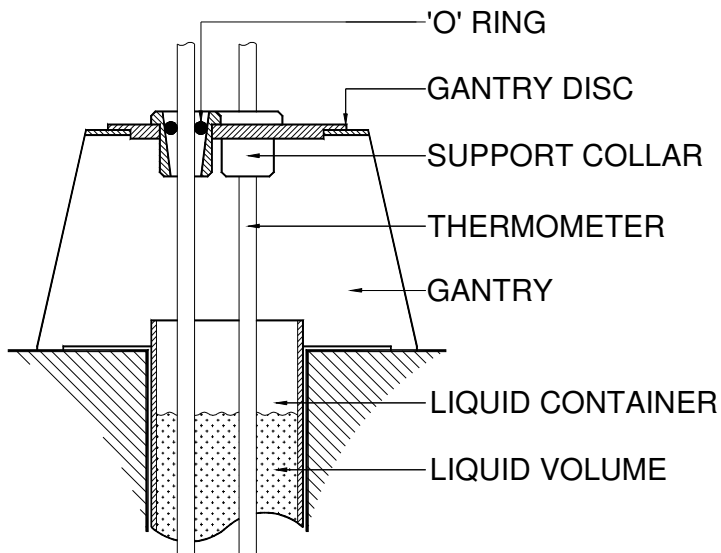

**LIQUID
 CONTAINER
 KIT - 580-06-07**