

OX-600

Indoor Oxygen Monitor

Operator's Manual

Part Number: 71-0376

Revision: D

Released: 12/7/21

Contents

1 Outline of the Product.....	4
Preface.....	4
Purpose of use.....	4
Definition of DANGER, WARNING, CAUTION and NOTE	4
2 Important Notice on Safety.....	5
2-1. Danger cases.....	5
2-2. Warning cases	5
2-3. Precautions.....	6
3 Product Components.....	7
3-1. Main unit and standard accessories.....	7
Main unit.....	7
Standard accessories.....	7
Optional accessories.....	8
Outline drawing	8
3-2. Names and functions for each part	9
Main unit.....	9
Display.....	10
Installation of batteries (for dry battery type)	10
4 How to Install	12
4-1. Precautions for installation points	12
4-2. Precautions for system designing	13
Using a stable power supply	13
Proper use of alarm contact.....	14
4-3. Installation of main unit.....	15
4-4. Precautions for wiring.....	18
How to connect to terminal plate.....	19
Figure of terminal plate	21
5 How to Use	22
5-1. Before using the monitor	22
5-2. Preparation for start-up	22
5-3. Power-on	22
5-4. User mode	24
Items that can be checked and set in user mode	25
5-5. Air calibration	26
5-6. Setting value check	27
5-7. Power-off	29
6 Alarm Activation and Functions	30
6-1. Gas alarm activation.....	30
Display operation	30
Contact activation.....	31
Response to gas alarm (In case of responding to leaked gas)	31
6-2. Fault alarm activation	31
6-3. External output operation	32
6-4. Suppression function	33
6-5. Air Follower Function	33
6-6. Auto Air Cal Function	34
7 Maintenance	35
7-1. Maintenance intervals and items.....	35
About maintenance services	36
7-2. Maintenance (regular maintenance) mode	37
How to enter maintenance mode	37
Test functions	40
7-3. Preparation for zero and span adjustment.....	42
7-4. Zero adjustment.....	43
7-5. Span adjustment.....	44
7-6. Environmental setting.....	45
7-7. Return to user mode.....	52

7-8. Component Replacement.....	52
7-9. Replacing a Sensor Cable.....	54
7-10. Adding a Sensor Cable.....	58
8 Storage and Disposal	63
8-1. Procedures to store the monitor or leave it for a long time	63
8-2. Procedures to relocate the monitor or use it again	63
8-3. Disposal of products	63
9 Troubleshooting	64
10 Product Specifications.....	66
10-1. List of specifications	66
10-2. List of accessories	67
11 Spare Parts List	68
12 Appendix.....	69
12-1. Detection principle of galvanic cell type	69
Important precautions	69
12-2. Definition of terms.....	70

1

Outline of the Product

Preface

Thank you for choosing our OX-600 indoor oxygen monitor (hereinafter referred to as the monitor). Please check that the model number of the product you purchased is included in the specifications on this manual.

This manual describes the monitor's specifications and how to use the monitor properly. Read and understand the operating manual and use this product as described in this manual.

Note that the contents of this manual are subject to change without notice for product improvement. It is also prohibited to copy or reproduce this manual, in whole or in part, without permission.

Regardless of warranty period, we shall not make any indemnification for accidents and damage caused by using the monitor.

Make sure to read the warranty policy specified on the warranty.



Purpose of use

This indoor oxygen monitor measures oxygen in the air and issues an alarm using the buzzer and LCD backlight when oxygen concentration drops below a preset concentration (alarm setpoint). While displaying measured oxygen concentration on the LCD, the monitor converts it to an analog signal of 4 - 20 mA or 0 - 1 V to output (only 0 - 1 V for the dry battery type) and outputs a two-step gas alarm contact at a gas alarm state.

The monitor is a safety unit, not an analyzer which performs quantitative/qualitative analysis/measurement for oxygen. Check the specifications before use and conduct measurement properly in accordance with purposes.

Definition of DANGER, WARNING, CAUTION and NOTE

Throughout this manual, the following indications are used to ensure safe and effective work.

 DANGER	This message indicates that improper handling may cause serious damage on life, health, or assets.
 WARNING	This message indicates that improper handling may cause serious damage on health or assets.
 CAUTION	This message indicates that improper handling may cause minor damage on health or assets.
NOTE	This message indicates advice on handling.

2

Important Notice on Safety

To maintain the performance of the monitor and use it safely, observe the following instructions with WARNING and CAUTION.



WARNING

- If an abnormality is found in the monitor, contact RKI immediately. Visit our website to find your nearest RKI office.
Web site: www.rkiinstruments.com

2-1. Danger cases



DANGER

- This is not an explosion-proof unit. Never attempt to measure a gas in an atmosphere over the lower explosive limit.

2-2. Warning cases



WARNING

- Before turning on the monitor, always check that the voltage is compliant with the specifications. Operating on an unstable power supply may cause malfunctions.
- When air calibration is performed, check the atmosphere for freshness before beginning it. If interference gases exist, the air calibration cannot be performed properly, thus leading to dangers when an oxygen deficiency occurs.
- Do not operate this monitor in a place where combustible/explosive gases or vapors are present. Operating the monitor in such an environment will lead to extreme dangers.
- Issuance of an oxygen deficiency alarm indicates that there are extreme dangers. Take proper actions based on your judgment.
- Perform span adjustment at fixed intervals.
- Make sure that the monitor is installed in a place where it is in contact with the atmosphere. If the monitor is installed in a place where it is in less contact with the atmosphere, it may not detect the correct oxygen concentration, thus leading to an oxygen deficiency accident.
- Do not run the power cable and remote sensor cable of the monitor in parallel with cables of high-frequency or high-voltage and other device's power cables.
- If a cable of high-frequency or high-voltage and the power cable need to intersect with each other, it should be orthogonally connected.
- When wiring, be careful not to apply any stresses on the cables by pulling, tightening or twisting.
- Do not disassemble/modify the monitor. It may invalidate the warranty of the performance. Changing the settings without understanding them may cause alarm malfunctions. Please use the monitor properly in accordance with the operating manual.

2-3. Precautions



CAUTION

- Do not use a device, such as a transceiver, which transmits a radio wave near the monitor or its cables. It may affect the measurement. If a transceiver or other radio wave transmitting device is used, it must be used in a place away from the monitor where it does not disturb the monitor.
- Restarting the monitor within five seconds after turning it off may cause errors.
- This is not a control unit. It is not allowed to use the external output of the monitor to control other units.
- This is a safety unit. Never fail to perform a regular maintenance to ensure safety. Continuing to use the monitor without performing maintenance will compromise the sensitivity of the sensor, thus resulting in inaccurate gas detection.
- Do not pick the sensor or buzzer opening with a sharp-pointed item. The unit may malfunction or get damaged, possibly resulting in incorrect measurements.
- Do not let the monitor draw in water. Do not install the monitor in a place where the monitor may get wet. Ignoring this may cause malfunction because the monitor is not water- and drip-proof.
- This is a precision device. Do not apply strong shock or vibration to the monitor.
- When the case is opened for wiring or other operation, do not touch inner parts. When wiring, be sure that excessive pressure is not applied to the power cable and remote sensor cable.
- Do not block the sensor vent.

3

Product Components

3-1. Main unit and standard accessories

After opening the shipping box, check the monitor and accessories.
If there is anything missing, contact RKI.

Main unit

For names and functions of individual parts of the monitor and LCD display, see "[3-2. Names and functions for each part](#)" on page 9.

OX-600 main unit



Sensor unit (Remote type)

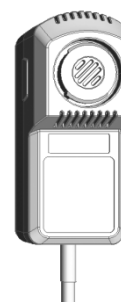

NOTE

- The OX-600's standard configuration is with the sensor installed in the main unit. Specify when ordering if you want an extender cable with a remote sensor.
- The sensor integrated type does not include the remote sensor.
- The cable lengths available for the remote sensor type are: 3, 5, 10 and 20 m.

Standard accessories

- Cross-recessed pan head machine screw (2 pcs.)
- Cross-recessed round head wood screw (2 pcs.)
- 3.2 m AC power cable (1 pc.) *Supplied only with AC specification
- Operating manual (1 pc.)



CAUTION

- The main unit and sensor unit (remote type) are precision devices. Be careful not to drop the monitor when installing or uninstalling the main unit or sensor unit. Dropping the monitor may compromise its original performance or cause malfunctions.

Optional accessories

- Mounting plate (1 pc.) RKI part number: 21-1927
- Gas calibration cup (1 pc.) RKI part number: 81-1153

Outline drawing

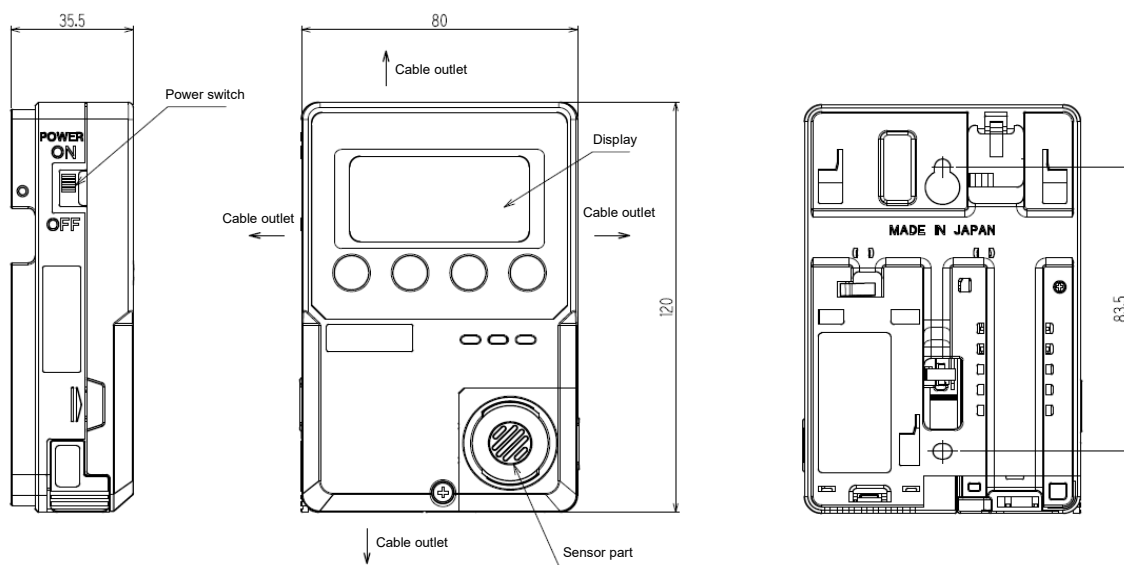

Main unit

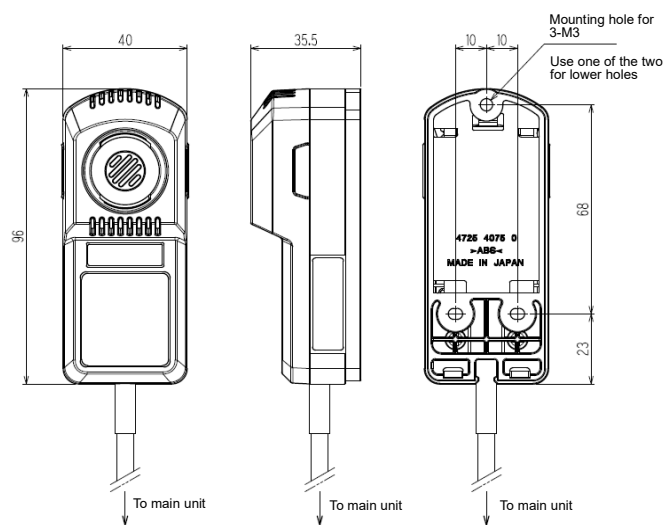

Remote sensor

3-2. Names and functions for each part

This section describes the names and functions of the individual parts and LCD display that make up the monitor.

Main unit

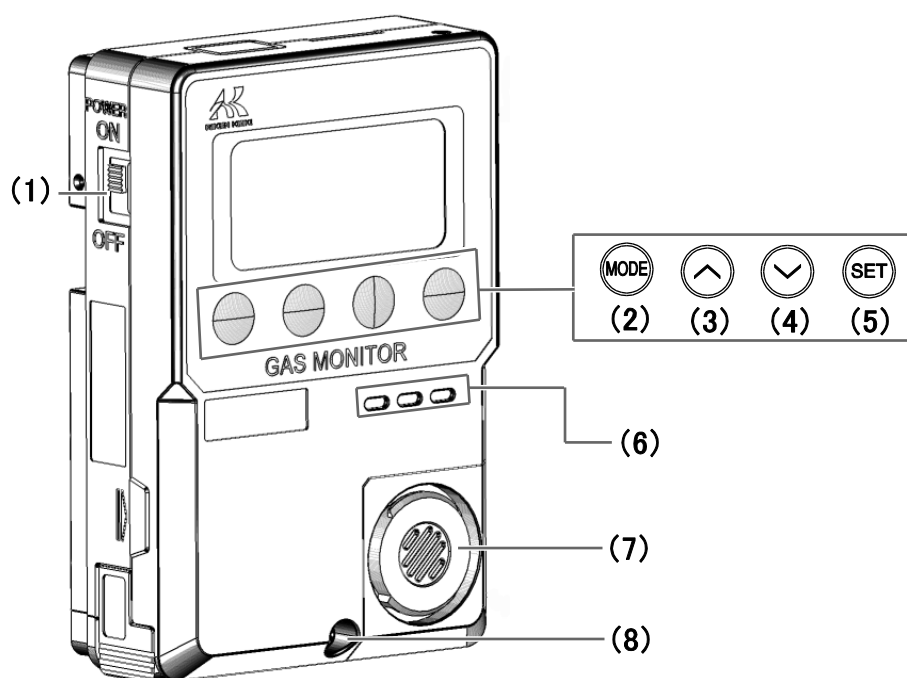

Name	Major function
(1) Power switch	Turns the power ON/OFF. Slide the switch up to power on and down to power off.
(2) MODE button	Hold down this button to enter the user mode. It is also used to cancel or skip during setup.
(3) ^ button	Used to change the screen and increase numerical values during setup.
(4) v button	Used to change the screen and decrease numerical values during setup.
(5) SET button	Used to confirm the setting.
(6) Buzzer sound opening	Emits operation and alarm sounds. (Do not block it.)
(7) Sensor part	Detects a gas to be detected. The sensor is inside the cover.
(8) Screw	Loosen this screw to open the case.

Display

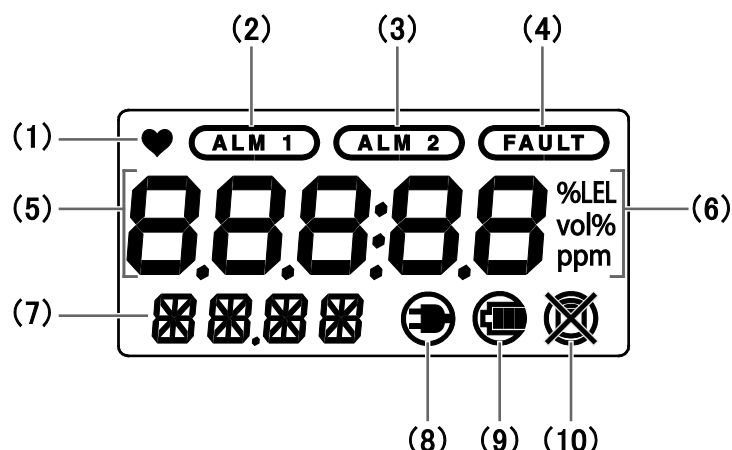

Name	Major function
(1) Operating state display	Displays the operating status. Blinks at a normal state.
(2) First alarm display	Lights up in orange at a first alarm state.
(3) Second alarm display	Lights up in red at a second alarm state.
(4) Fault alarm display	Lights up in red at a fault alarm state.
(5) Concentration value display	Displays the gas concentration.
Maintenance indicator	Maintenance items and others are displayed during setup.
(6) Unit display	Displays the unit (%) according to the specification.
(7) Gas name display	Displays the gas name (O2: Oxygen).
Maintenance display	Maintenance items and others are displayed during setup.
(8) AC/DC power display	Lights up when the monitor is operating on AC or DC power.
(9) Battery level icon	Displays the battery level when the monitor is operating on dry batteries.
(10)	This is not used for the monitor.

Installation of batteries (for dry battery type)

When the monitor is used for the first time, or when the battery level is low, install or replace with the new AA alkaline dry batteries according to the following procedure.



CAUTION

- Turn off the power of the monitor before replacing the batteries.
- Replace the batteries in a safe place where explosive gases are not present.
- Never fail to use alkaline batteries. If a rechargeable (secondary battery) nickel-cadmium battery or nickel metal hydride battery is used, the specifications cannot be met, such as continuous operating time.
- Replace both batteries at the same time.
- Pay attention to the polarities of the batteries when installing them.
- Completely lock the battery cover after installing the batteries. If the battery cover is not completely locked, the dry batteries may fall out.
- Do not use rechargeable batteries that may interrupt a measurement due to the discharge characteristic of rechargeable batteries.

- 1 Check that the power of the main unit is turned off.**
If the power is turned on, slide the power switch down to turn it off.

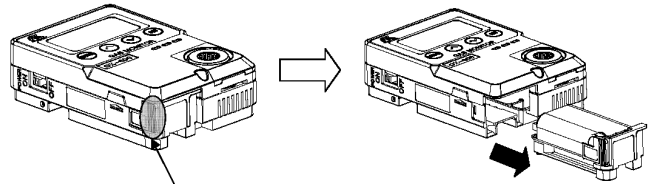

- 2 Remove the battery case from the monitor.**

Unlock the tab of the battery case.

- 3 Put new batteries (two AA alkaline dry batteries) in the battery case.**
Confirm that the polarities of the batteries are correct.

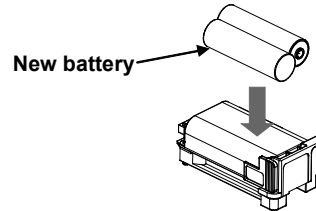

- 4 Put the battery case back in the monitor.**

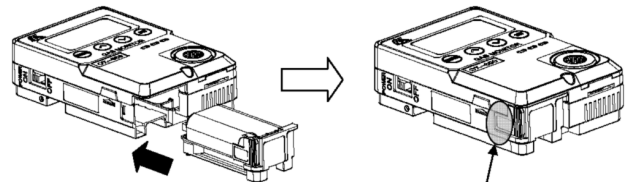

Push the circled area and confirm that the tab is locked.

4

How to Install

4-1. Precautions for installation points

When installing the monitor, never fail to observe the following precautions. Ignoring the precautions may damage the monitor, resulting in inaccurate gas detection.



CAUTION

- This is a precision device. Because the monitor may not provide the specified performance in some places (environments), check the environment in the installation site, and then take appropriate actions if necessary. Because the monitor plays an important role for safety and disaster prevention, it must be installed in appropriate points.
- Do not install this product in any of the following locations.
 - Place exposed to direct sunlight or outside
 - Place exposed to water
 - Place exposed to ventilation from an air conditioner, etc.
 - Place exposed to soot, smoke, or steam
 - Place where the temperature drops below -10°C or rises over 40°C or where the temperature changes suddenly
 - Place with high humidity like a bathroom
 - Place with bad ventilation such as behind a curtain or under an overhang.

<Do not install the monitor in a place with vibrations or shocks.>

The monitor consists of sensitive electronic parts. The monitor must be installed in a stable place without vibrations or shocks, etc. and it cannot drop.

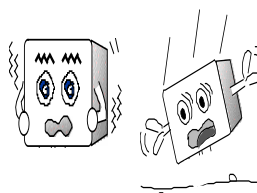

<Do not install the monitor in a place exposed to water, oil or chemicals, etc.>

When selecting installation points, avoid a place where the monitor is exposed to liquids such as water, oil, or chemicals.



<Do not install the monitor in a place where the temperature drops below -10°C or rises over 40°C .>

The operating temperature of the monitor is -10 to $+40^{\circ}\text{C}$. Install the monitor in a stable place not exceeding the operating temperature range.

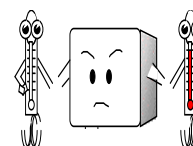

<Do not install the monitor in a place exposed to direct sunlight or sudden changes in temperature.>

Avoid a place where the monitor is exposed to direct sunlight or radiant heat (infrared rays emitted from a high-temperature object), and where the unit temperature changes suddenly. Condensation may be formed inside the monitor, or the monitor cannot adjust to sudden changes in the temperature.

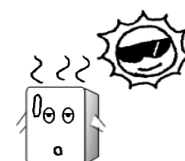

<Keep the monitor (and its cables) away from noise source devices.>



When selecting installation points, avoid a place where high-frequency/high-voltage devices exist.

<Do not install the monitor in a place where maintenance of the monitor cannot be performed or where handling the monitor involves dangers.>

Regular maintenance of the monitor must be performed.

Do not install the monitor in a place where the machinery must be stopped when maintenance is performed, where parts of the machinery must be removed to perform maintenance, or where the monitor cannot be removed because racks or other things prevent access to it. Do not install the monitor in a place where maintenance involves dangers, for example, near a high-voltage cable.

4-2. Precautions for system designing

Note the following precautions for system designing of the monitor.



CAUTION

- An unstable power supply and noise may cause malfunctions or false alarms.

Using a stable power supply

The external output and alarm contact of the monitor may be activated when the power is turned on, when momentary blackout occurs, or when the system is being stabilized. In such cases, use a UPS (uninterruptible power system), or take appropriate actions on the receiving side. The monitor must be provided with the following power supply.

Power supply voltage	100 - 120 VAC ±10% (50/60 Hz), 24 VDC±10% or AA alkaline dry battery (2 pcs.)
Allowed time of momentary blackout	Up to 10 milliseconds (To recover from the momentary blackout for 10 milliseconds or more, restart the monitor.) Example of actions To ensure continuous operation and activation, install a UPS (uninterruptible power system), etc. outside the monitor.
Others	Do not use it with a power supply of large power load or high-frequency noise. Example of actions Use a line filter, etc. to avoid the noise source if necessary.

Proper use of alarm contact

The alarm contact of the monitor is used to transmit signals to activate an external buzzer, alarm lamp or rotating lamp. Do not use it for controlling purpose (e.g., controlling the shutdown valve). The contacts can be configured as Form A or Form B but are factory set as Form A contacts and they are normally de-energized.



CAUTION

- The b contact (break contact) under de-energized state may be opened momentarily by a physical shock, such as external force.
When the b contact is selected for the alarm contact, take appropriate actions to prepare for a momentary activation such as adding a signal delay operation (approximately one second) to the receiving side of the b contact.

The specifications for the external output gas alarm contact of the monitor are based on the resistance load conditions. If inductive load is used at the alarm contact, the following errors will occur easily because counter electromotive force is generated at the contact.

- Deposition, defective insulation or defective contact at the relay contact
- Damage of any electric parts due to high-voltage generated inside the monitor
- Abnormal operations by an out-of-control CPU

If load is to be activated, appropriate measures must be taken to stabilize the operation of the monitor and protect the alarm contact referring to the following information.

- Relay it with an external relay at a lower voltage of 120 VAC or below (contact amplification). At the same time, the surge absorbing part SK1 suitable for the specifications must be attached to the external relay.
- In addition, the surge absorbing part SK2 must be attached to the loaded side of the external relay if necessary.
- It may be recommended that the surge absorbing part should be attached to the contact for certain load conditions. It must be attached to an appropriate position by checking how the load is activated.

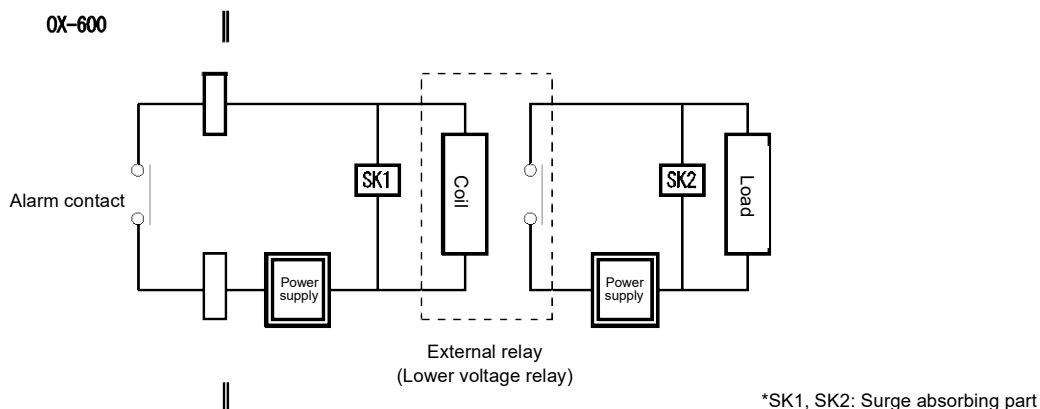

CAUTION

- In principle, do not activate an inductive load at the alarm contact of the monitor. In particular, never use the inductive load to activate a fluorescent lamp or motor.
- If inductive load is activated, relay it with an external relay (contact amplification). However, because the coil of an external relay also involves inductive load, select a relay at a lower voltage (120 VAC or below), and then protect the contact of the monitor with an appropriate surge absorbing part, such as a CR circuit.

4-3. Installation of main unit

Install the main unit on the wall 50 to 180 cm up from the floor.

If wall screws are available, remove the screw at the lower part of the main unit to open the cover and install the unit using the mounting holes on the back of the unit.



CAUTION

- Install the sensor in a place not directly exposed to ventilation from an air conditioner. Sudden changes in the temperature may cause the readings to disappear.

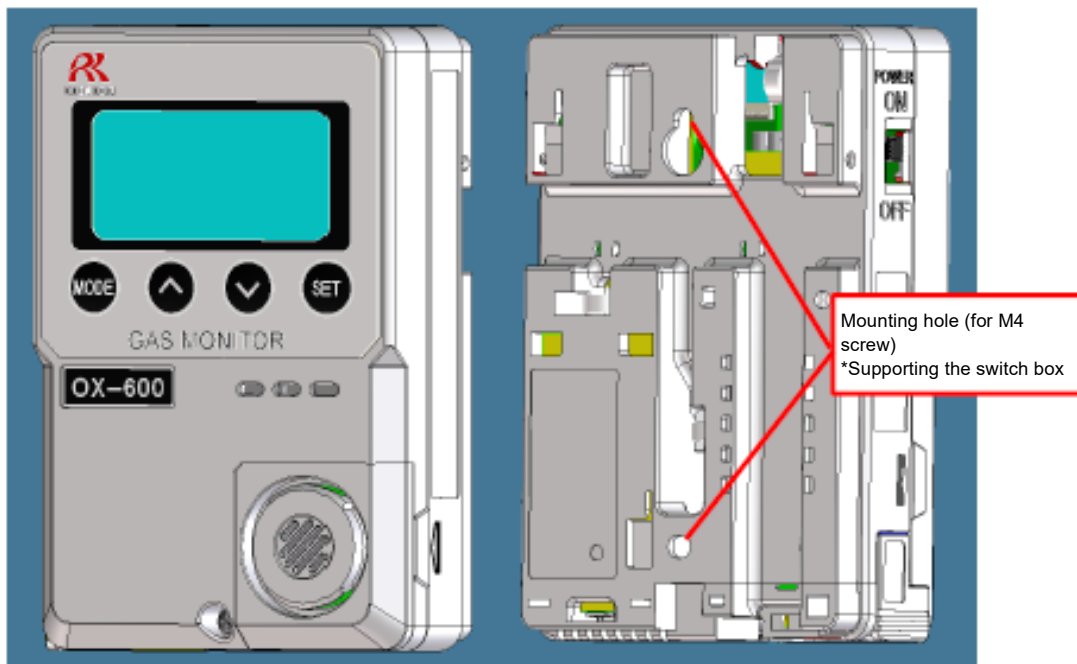

NOTE

- To install the main unit to the wall with screws, use the mounting holes on the back of the unit according to the following procedure.
 - (1) Loosen the screw at the lower part of the main unit and open the surface cover of the case.
 - (2) Fix the main unit with two screws (M4) through the mounting holes.
 - (3) Put the surface cover back on the case and tighten the screw at the lower part of the main unit.

If the monitor operating on dry batteries needs to be removed with the power on, use the mounting plate (option). When the mounting plate is used, install the plate before installing the main unit.

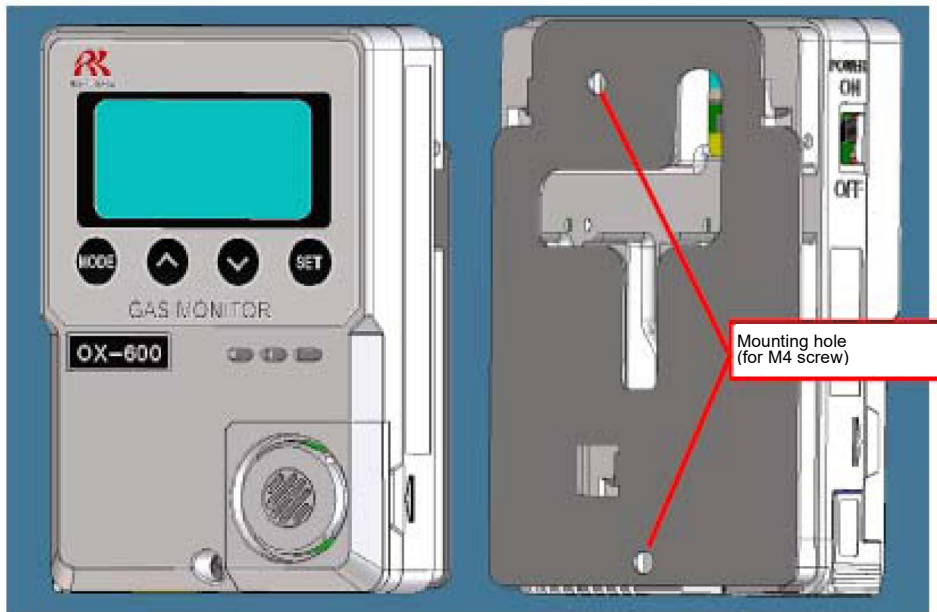

<Installation of Remote Sensor>

Tighten the screws through one upper mounting hole and one of the two lower mounting holes.

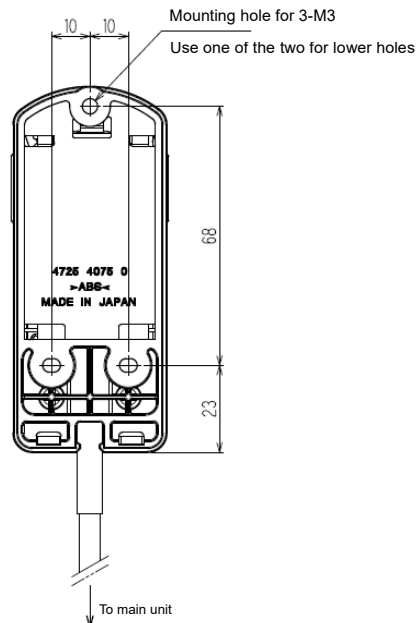

NOTE

- To install the remote sensor to the wall using screws, use the mounting holes on the back of the sensor according to the following procedure.
 - (1) Open the surface cover of the remote sensor.
 - (2) Attach the sensor with two screws (M4) through the mounting holes (one upper mounting hole and one of the two lower mounting holes).
 - (3) Put the cover back on the remote sensor.

<Maintenance Space>

For the dry battery type, be sure to leave space below the unit for battery replacement. If the mounting plate (optional) is used, be sure to leave space above the unit so that it can be installed by sliding.

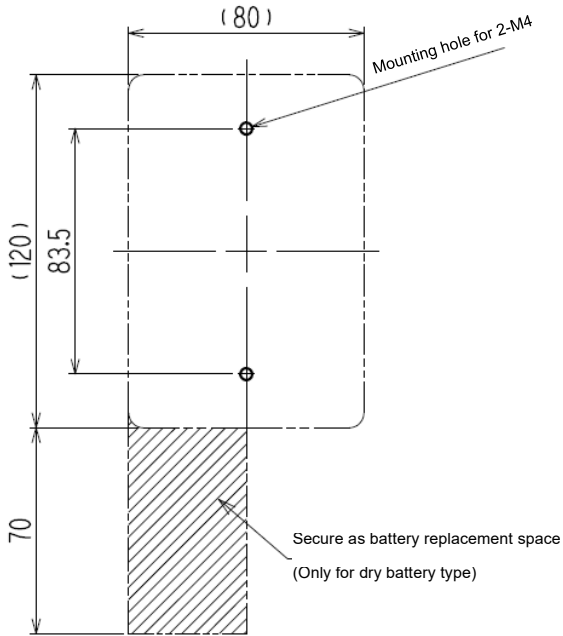

Installation dimension drawing (Mounting plate not used)
Compatible with JIS single switch box

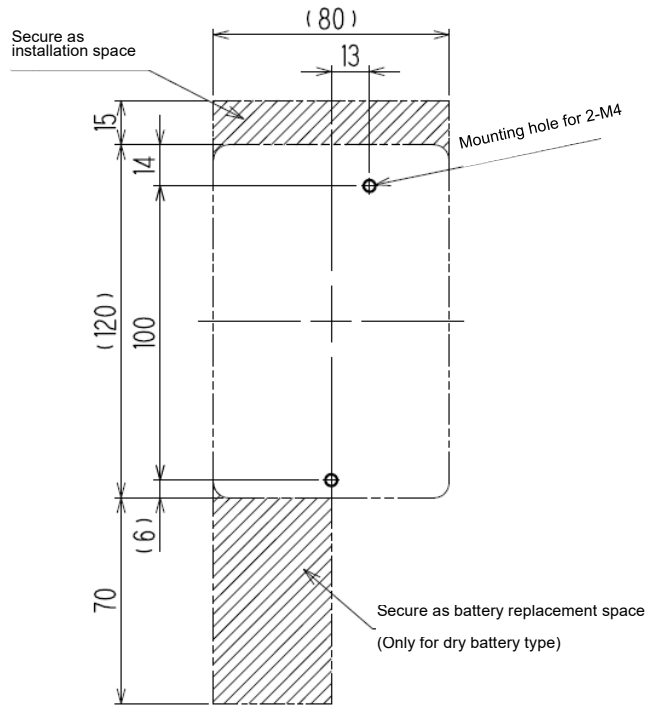

Installation dimension drawing (Mounting plate used)

4-4. Precautions for wiring

If the monitor operates on AC or DC power or if an inductive load is used at the alarm contact, wiring work is required.

The following cables are recommended for wiring the monitor with the power supply, signal cable and contact.

<Recommended Cables>

For AC power	Solid wire/stranded wire: 0.2 - 1.5 mm ²
For DC power	CVVS: 0.2 - 1.5 mm ²
For signal cable (4 - 20 mA/0 - 1 V)	CVVS: 0.2 - 1.5 mm ²
For contact	Cable such as CVV (0.2 - 1.5 mm ²) Up to 4 cores



CAUTION

- Be careful not to damage the internal electronic circuit when wiring. In addition, be careful not to apply stresses on the monitor when (overweight) cables are installed.
- The power and signal cables must be wired separately from the motor power cables.
- When stranded wires are used, prevent wires from contacting each other.

<Cable Connection Conditions>

Connectable cable, bare wire length and connection tools are as follows:

- Cable: 0.2 - 1.5 mm²
- Bare wire length: 10 - 11 mm
- Connecting tools: Dedicated screwdrivers manufactured by WAGO and equivalent (edge width 3.0 to 4.5 mm x 0.5 mm)



CAUTION

The specified bare wire length must be observed when the wire insulation is peeled off.

- Improper clamping of the wire due to a shorter bare wire length may cause defective electric conduction or heating.
- Catching the wire insulation due to a shorter bare wire length may cause defective electric conduction or heating.
- Exposing the wire due to a longer bare wire length may cause defective insulation or a short circuit.
- Be careful not to break up the wire. If the wire is broken up when inserted to the terminal, this may cause defective insulation or heating.

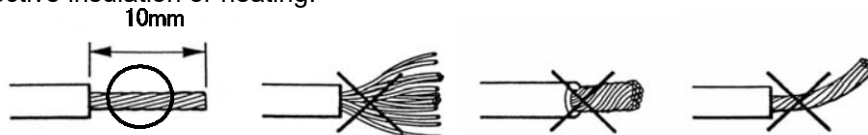

<Compatible Bar Terminal>

For a bar terminal, the following items are available. See the spare parts list for RKI part numbers.

- Bar terminal (ferrule): Model 216 Series (manufactured by WAGO)
- Crimping tool: Model VarioCrimp 4 (206-204) (manufactured by WAGO)



CAUTION

- A bar terminal of the specified model must be used. Using other bar terminals invalidates the warranty of the performance.

How to connect to terminal plate

When cables (wires) are connected to the terminal plate inside the main unit, use the dedicated screwdriver or a compatible flathead screwdriver.

When connecting a stranded wire, be sure to press the push button and open the spring while connecting the wire.

- 1 Push the push button straight downward using the compatible screwdriver or equivalent to open the spring.**
- 2 Insert a wire with a specified bare wire length (10 mm) until the end of it reaches the deepest point.**

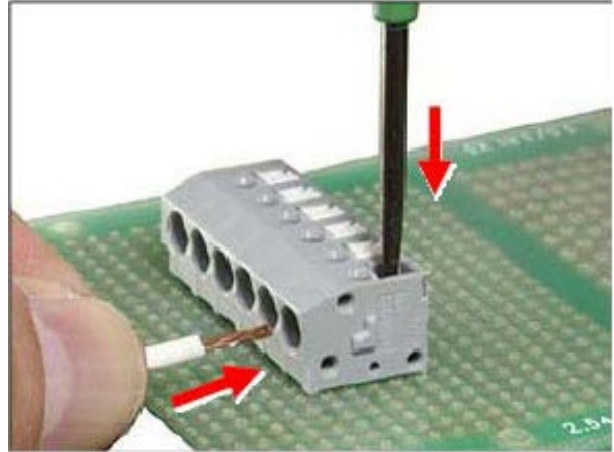

- 3 Release the screwdriver.**
The wire is connected.



CAUTION

- Never fail to use the correct tool.
- Do not insert more than one wire into one wiring hole. If the total size (mm²) of two or more wires is within the maximum wire connection range of the terminal plate, it may cause reduced spring clamping force, defective insulation due to clogged wire sheath, defective contact or coming off of wires.

NOTE**<Compatible Screwdriver>**

- When opening the spring, use the compatible screwdriver manufactured by WAGO or equivalent (a screwdriver with an edge width of 3.0 to 4.5 mm x 0.5 mm which can fully open the spring: See the table below). In doing this work, be careful not to apply excessive force. Ignoring this may damage the housing/push buttons or cause dropping off of the push buttons.

Compatible screwdriver manufactured by WAGO	
Screwdriver (M) straight type	210-120J
Screwdriver (M) straight type (short shaft & grip)	210-350/01 210-657
Screwdriver (M) straight type (insulated shaft type)	210-720



5

How to Use

5-1. Before using the monitor

Follow the operating precautions.
Ignoring the precautions may damage the monitor, resulting in inaccurate gas detection.



CAUTION

- After you receive the monitor, start using the monitor within the specified operation start limit of its sensor.

5-2. Preparation for start-up

Check the following points before starting oxygen concentration monitoring.

- Before turning on the power, check that the monitor is installed properly and that external wiring is done properly.
- Check that the power supply voltage is compliant with the specifications.
- Because the external contact may be activated during the adjustment, take measures to prevent an activated contact from having influences on external circuits.

5-3. Power-on

- 1 Turn on the power switch.

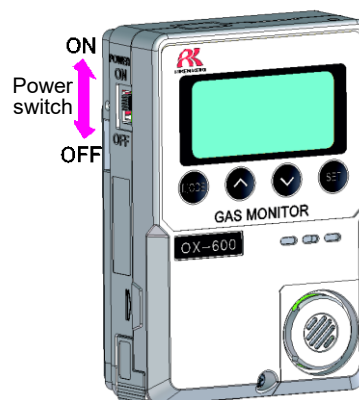

The LCD turns on.

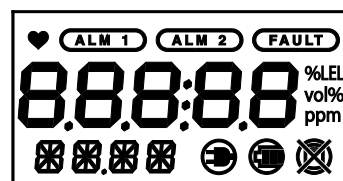

The monitor goes through a 25-second warmup.

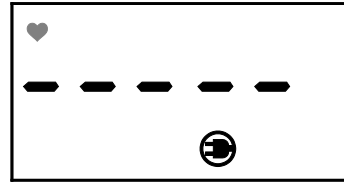

The monitor is in the measurement state. The LCD backlight for AC and 24 VDC versions will be on under non-alarm conditions. The LCD backlight for the battery powered version will be off under non-alarm conditions in order to conserve battery.



CAUTION

- Do not turn off the monitor during the warmup. When turning it on again, abnormal operation may occur.
- After initial warmup, perform air calibration.
- Air calibration must be performed within one hour of power-on.

NOTE

- External output during initial clear is as follows:
 - 4 - 20 mA: About 17.4 mA fixed
 - 0 - 1 V: About 0.84 V fixed
- To turn off the power, slide the power switch down.

5-4. User mode

The user mode allows for performing air calibration and checking setting values.

- 1 While in the measuring state, press and hold the MODE button for three seconds.**

The user mode is displayed.

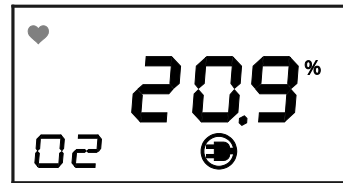

- 2 In the user mode, press the \downarrow or \uparrow button to scroll through the items.**

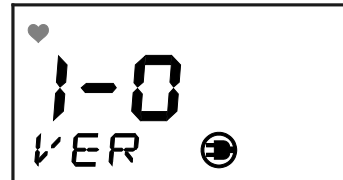

- 3 After making desired changes, hold down the MODE button.**



The monitor returns to the measuring state.



WARNING

- After air calibration, hold down the MODE button to return to the measuring state. The monitor automatically returns to the measuring state in 10 hours.

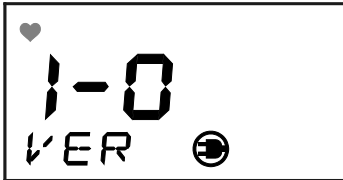
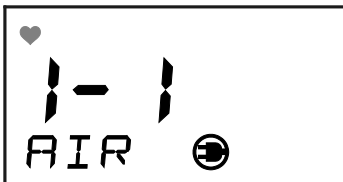
Items that can be checked and set in user mode

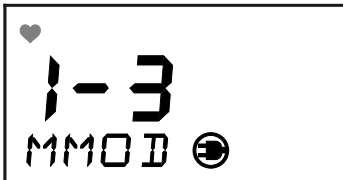
Item	Details	LCD display	Remarks
Program version	Show the current program version.		
Air calibration	Perform the air calibration.		Press the SET button to go to the air calibration screen. (P. 26)
Setting value check	Check settings such as alarm setpoint, zero suppression value, and air pressure correction.		Press the SET button to go to the setting confirmation screen. (P. 27)
Maintenance mode access	Access maintenance mode.		

5-5. Air calibration

An air calibration sets the fresh air reading to 20.9%. By default, the OX-600 automatically does an air calibration once a month. See 6-6. Auto Air Cal Function on page 34 for more discussion.

- 1 In the user mode, press the **▲** button once.

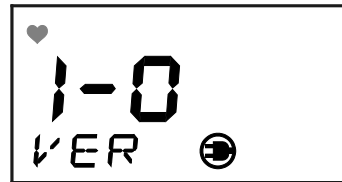

- 2 Press the **SET** button.
Press the **SET** button to display the current concentration.



- 3 Press the **SET** button again.
The concentration display blinks.



- 4 Press the **▼** or **▲** button to adjust the concentration value to "20.9%".

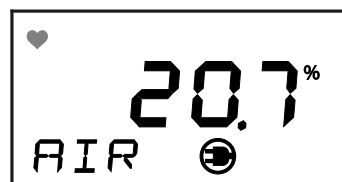

- 5 Press the **SET** button.
Air calibration is performed.
After air calibration is completed, "PASS" is displayed and the monitor returns to the display in step 2.

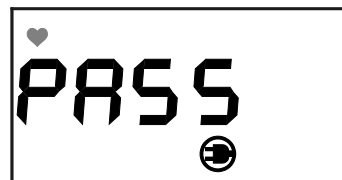

- * If air calibration fails, "FAIL" is displayed.

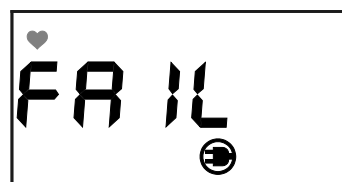

- 6 After checking the setting value, hold down the **MODE** button.
The monitor returns to the measuring state.



CAUTION

- When turning on the power, check the atmosphere for freshness and never fail to perform air calibration.



5-6. Setting value check

Typical setting values can be checked by the following procedure.

In the user mode, setting values cannot be changed. To change setting values, you must enter the maintenance mode as described on P.37.

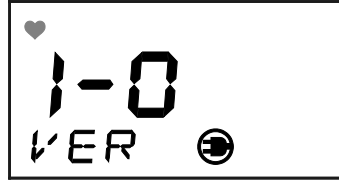
- 1 In the user mode, press the  button twice.



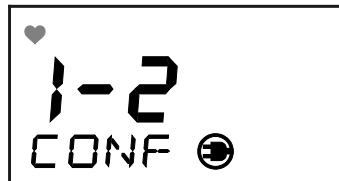

- 2 Press the  button.
Press the  button to display the first alarm setpoint.

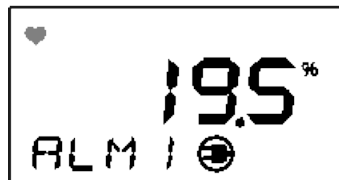

<First Alarm Setpoint Display>



- 3 Press the  or  button to check the setting value.

<Second Alarm Setpoint Display>

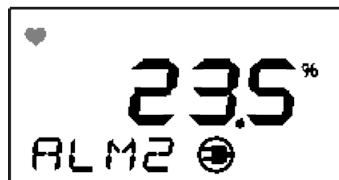

<Alarm Delay Time Display (seconds)>



<Zero Suppression Value Display>
The zero suppression value is displayed.

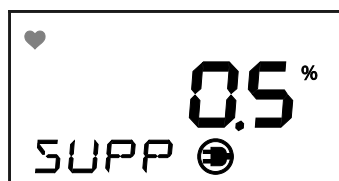

<Zero Follower ON/OFF Display>
 Not used.

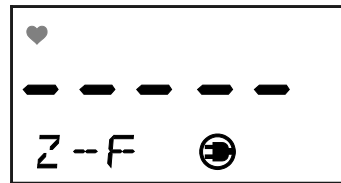

<Air Pressure Correction ON/OFF Display>
 Whether air pressure correction is enabled (ON) or disabled (OFF) can be checked.

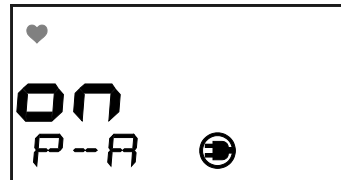

<Alarm Summary Display>
 Press the **SET** button to display the gas concentration and date/time alternately as the alarm history (up to 10 entries).

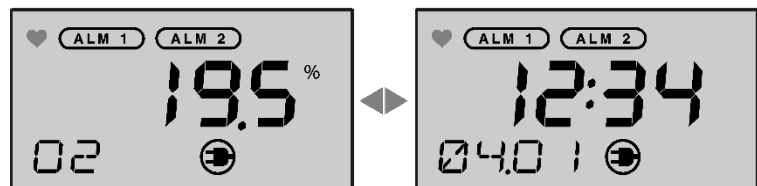
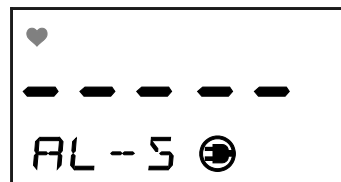

- 5** After checking the setting value, hold down the **MODE** button.
 The monitor returns to the measuring state.

5-7. Power-off

Slide the power switch down to power off.

After turning off the power switch of the monitor, turn off the power supply of the monitor.



CAUTION

- When the monitor is turned off, an alarm may be triggered on the upper (central) system. Before turning off the monitor, the inhibit (point skip) on the upper (central) system must be activated.
- Decide whether the power can be turned off by checking the operation of the devices connected to the external output or external contact output terminal of the monitor.

6

Alarm Activation and Functions

6-1. Gas alarm activation

A gas alarm is activated when detected gas concentration reaches the preset alarm setpoint.

NOTE

- The alarm setpoint (first alarm and second alarm) is factory-set. The setting values can be changed in the maintenance mode (P.37).
- Although the alarm delay time (standard: 2 seconds) is set to prevent a false activation, it can be changed in the maintenance mode (P.37).

Display operation

The LCD backlight for AC and 24 VDC versions will be on under non-alarm conditions. The LCD backlight for the battery powered version will be off under non-alarm conditions in order to conserve battery.

<Gas Alarm Display (In case of oxygen deficiency state)>

The alarm display is a two-step alarm consisting of the first alarm display (ALM1) and the second alarm display (ALM2).

It lights up in orange when the concentration drops below the first alarm state (ALM1: 19.5%) or reaches its alarm setpoint and in red when concentration drops below the second alarm state (ALM2: 23.5%) or reaches its alarm setpoint.

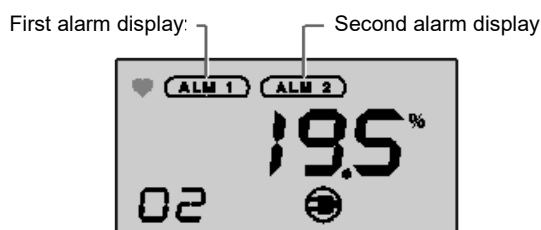

<Alarm Display at Over Scale>

If a gas alarm is activated when the concentration display is over scale (oxygen concentration exceeds 25.0%), the alarm display lights up as follows:

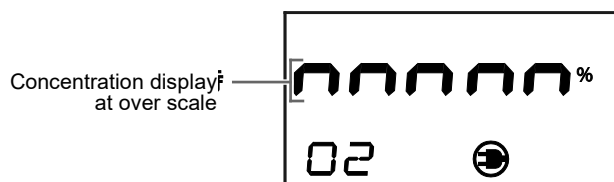

Contact activation

The contact is activated when the gas concentration drops below the alarm setpoint value. The contact activation is reset automatically when the gas concentration exceeds the alarm setpoint value (except for the dry battery type).

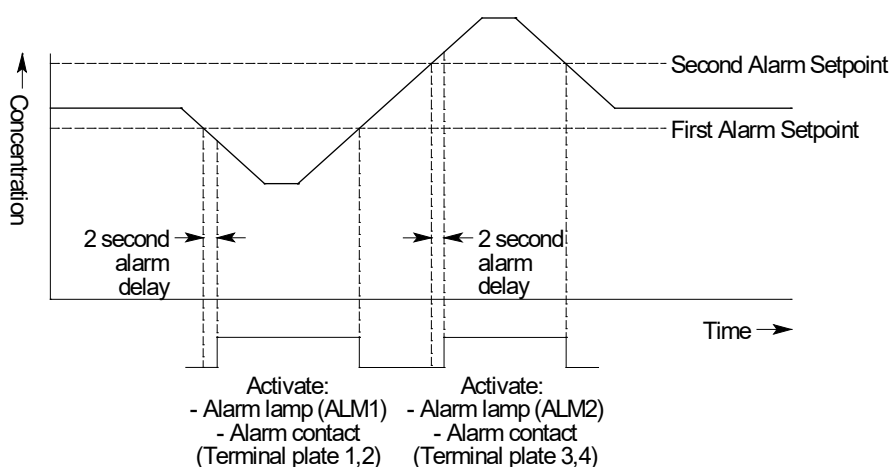

WARNING

- If the **MODE** or **SET** button is pressed to enter another mode while an alarm is triggered, the contact activation is reset.

Response to gas alarm (In case of responding to leaked gas)

When a gas alarm is triggered, take actions in accordance with your management rules of gas alarm. Normally, take the following actions.

- Check the reading of the monitor.
- If the gas alarm display continues to be displayed, close the main valve of the gas, and then check that the oxygen concentration reading is back to normal.

NOTE

- If an oxygen deficiency is momentary, the reading may already have returned to normal when checking it. In addition, when the alarm is triggered by noise or other incidental conditions other than a gas, the reading may have already returned to normal.

6-2. Fault alarm activation

A fault alarm is triggered when the monitor detects abnormalities. When a fault alarm is triggered, "FAULT" in the LCD display lights up in red.

An error message is displayed in the LCD. Determine the cause and take appropriate action.

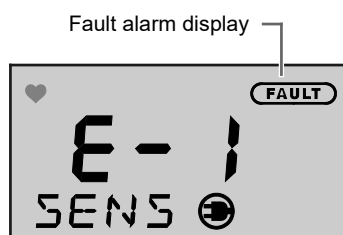

After the monitor is successfully returned from the fault, it enters the 25 second warmup period. If the monitor has problems and is repeatedly malfunctioning, contact RKI immediately.

NOTE

- For information on malfunctions (error messages), see "Troubleshooting" (P. 64).

6-3. External output operation

<4 - 20 mA Output Table>

Status	External output (4 - 20 mA)	External output (0 - 1 V)	Remarks
Initial	17.4mA	0.84V	Fixed values
Normal	4.0 - 20.0mA	0 - 1V	Depending on gas concentration
Scale over	20.1mA -	1V -	Depending on gas concentration
Trouble	21.5mA	1.1V	Fixed values
Maintenance mode menu	17.4mA	0.84V	Fixed values
Air calibration	4.0 - 20.0 mA	0 - 1V	Depending on gas concentration
Alarm setpoint check	4.0 - 20.0 mA	0 - 1V	Depending on gas concentration
Alarm summary check	4.0 - 20.0 mA	0 - 1V	Depending on gas concentration
Date/time check and setting	4.0 - 20.0 mA	0 - 1V	Depending on gas concentration
Alarm test	4.0 - 20.0 mA	0 - 1V	Depending on test value

* External output 4 - 20 mA can be adjusted in the maintenance mode "2-48 MA20".
0 - 1 V cannot be adjusted.

6-4. Suppression function

The monitor is influenced by environmental changes (temperature, humidity and other characteristics), which affects the reading.

Therefore, the reading might fluctuate because of the atmosphere, even in a normal environment. The suppression function is used to hide (suppress) the fluctuation of the reading under the setting value, indicating a level that can obscure influences by environmental changes in the atmosphere. This function can be set in the maintenance mode (P.37).

<Suppression Disabled>

The reading is displayed with the fluctuation near the atmosphere level included.

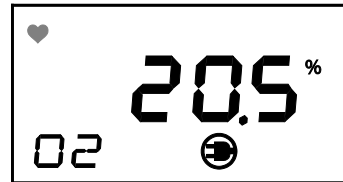

<Suppression Enabled>

The atmosphere level can be displayed within the standard setting ($\pm 0.5\%$).



6-5. Air Follower Function

OX-600s manufactured after mid-2019 have a DIP switch that turns the air follower function on (default) or off.

If the air follower function is turned on (default) the OX-600 automatically adjusts the reading to 20.9% every hour if the indicated value is within $\pm 0.5\%$ of 20.9%.

The DIP switch is located on the sensor board. To adjust the switch, either open the main unit or the sensor unit (if using a remote-mounted sensor). The air follower switch is the leftmost of the two switches. When the switch is up, the air follower is on. When the switch is down, the air follower is off.

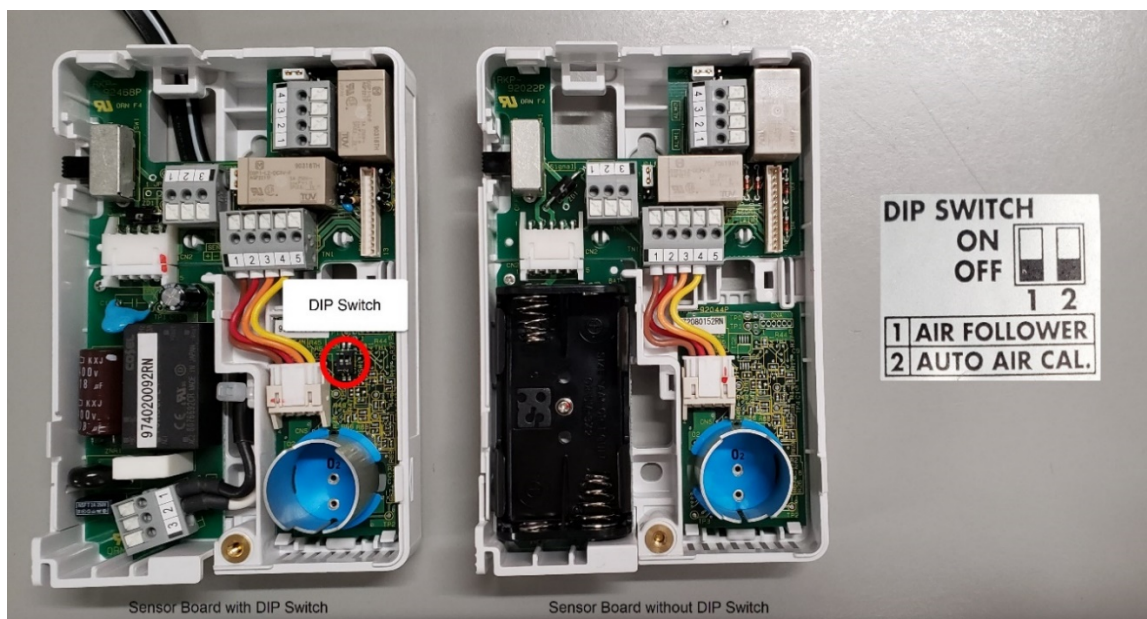

6-6. Auto Air Cal Function

OX-600s manufactured after mid-2019 have a DIP switch that turns the auto air cal function on (default) or off.

If the auto air cal function is turned on (default), the OX-600 automatically performs an air calibration once a month. *If the OX-600 is not in a fresh air environment, the air calibration will be inaccurate.*

The DIP switch is located on the sensor board. To adjust the switch, either open the main unit or the sensor unit (if using a remote-mounted sensor). The auto air cal switch is the rightmost of the two switches. When the switch is up, the auto air cal function is on. When the switch is down, the auto air cal function is off.

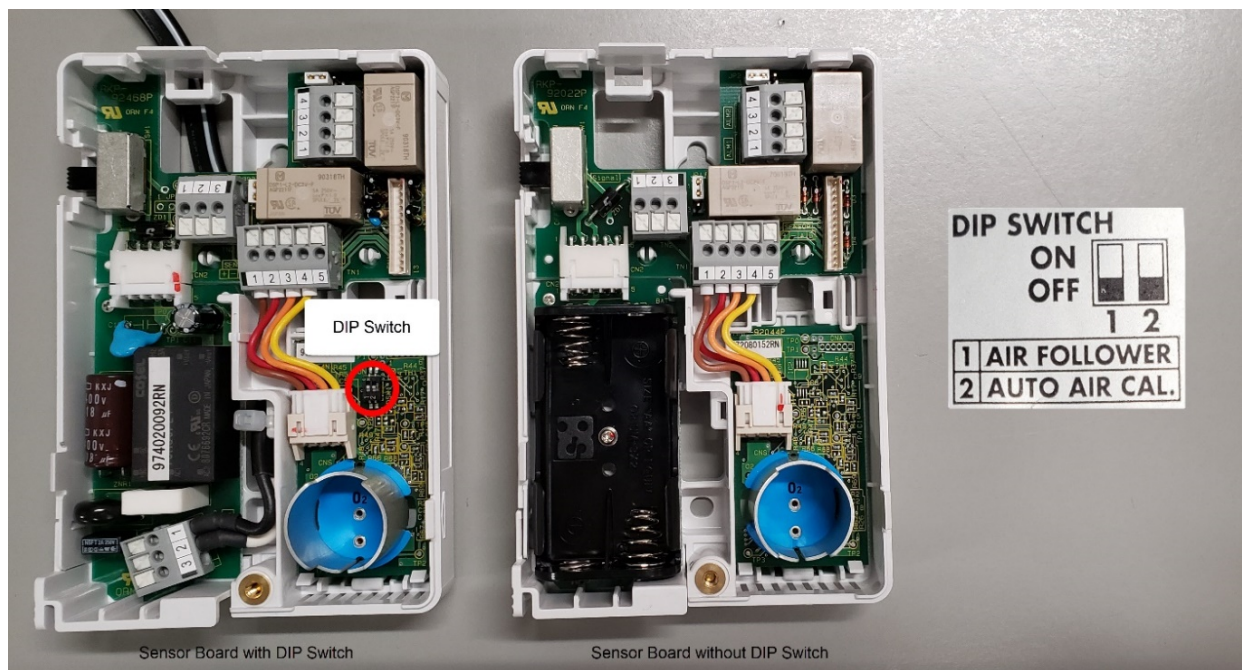

7

Maintenance

The monitor is an important instrument for the purpose of safety. To maintain the performance of the monitor and improve the reliability of safety, perform regular maintenance.

7-1. Maintenance intervals and items

This is a safety unit. Never fail to perform daily and regular maintenance before use.

- Daily maintenance: Perform maintenance before commencing each work.
- Regular maintenance: Perform maintenance once or more for every six months to maintain the performance as a safety unit.

Maintenance item	Maintenance content	Daily maintenance	Monthly maintenance	Regular maintenance
Power supply check	Check that the LCD display lights up.	○	○	○
Concentration display check	Check that the concentration display value is "20.9%". When the reading is incorrect, perform the air calibration after ensuring that no other gases exist around it.	○	○	○
Alarm test	Inspect the alarm circuit by using the alarm test function.	–	○	○
Span Adjustment	Perform span adjustment using a calibration gas.	–	–	○
Gas alarm check	Check the gas alarm using a calibration gas.	–	–	○



WARNING

- If an abnormality is found in the monitor, contact RKI immediately.

NOTE

- The built-in sensor of the monitor has a validity period and must be replaced regularly.
-

About maintenance services

We provide services on regular maintenance including span adjustment, other adjustments, and maintenance.

Our qualified service engineers have expertise and knowledge on the dedicated tools used for services, along with other products.

To maintain the safety operation of the monitor, please use our maintenance service. Typical maintenance services are listed as follows. Please contact RKI for more information.

<Typical Maintenance Services>

Item	Services
Power supply check	Checks the power supply voltage. Checks that the LCD display lights up. (Verifies that relevant points can be identified on the system.)
Concentration display check	Verifies that the concentration display value is "20.9%" at the atmosphere level. Performs the air calibration if the reading is incorrect.
Alarm test	Inspects the alarm circuit by using the alarm test function. Checks the alarm display (Checks the activation each for ALM1 and ALM2.) Checks the alarm activation such as a buzzer.
Span adjustment	Performs span adjustment using a calibration gas.
Gas alarm check	Checks the gas alarm by using the calibration gas. Checks the alarm. (Checks triggering of alarm when the alarm setpoint is reached.) Checks the delay time. (Checks time to delay until the alarm is triggered.) Checks the alarm display (Checks the activation each for ALM1 and ALM2.) Checks the alarm activation such as a buzzer.
Cleaning and repair of the unit	Checks dust or damage on the surface, cover or internal parts of the unit, and cleans or repairs such parts as needed. (Visual diagnosis) Replaces parts which are cracked or damaged.
Unit operation check	Operates the buttons to check the operation of functions and parameters, etc.
Replacement of consumable parts	Replaces consumable parts, such as a sensor.

7-2. Maintenance (regular maintenance) mode

The maintenance mode allows for checking the status of the monitor and adjusting and changing the settings.

How to enter maintenance mode

To enter the maintenance mode, use the following procedure.

- 1 While in the measuring state, press and hold the **MODE** button for three seconds.
The user mode is displayed.

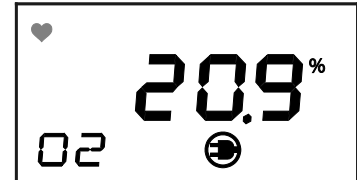

- 2 In the user mode, press the **▲** button three times.

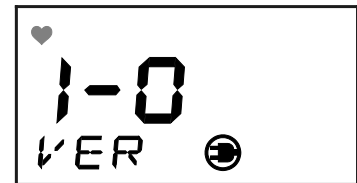

- 3 Press the **SET** button.

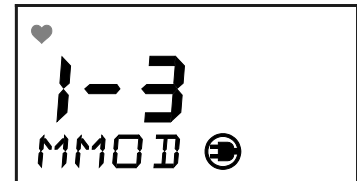

- 4 Hold down the **SET** button for three seconds.
The monitor enters the maintenance mode.

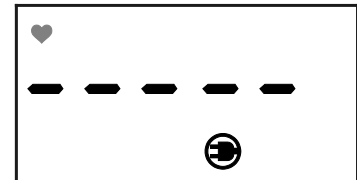

- 5 To select items in the maintenance mode, press the **▼** or **▲** button to display setting and check items.

<Test Functions (2-0 TEST)>



Perform the following tests.

- 2-00: Gas test
- 2-01: Alarm test
- 2-02: Fault alarm test
- 2-03: Display test
- 2-04: Not used.

Refer to "Test functions" (P.40) for details.

<Air Calibration (2-1 ZERO)>

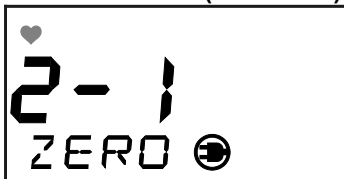

Perform the air calibration.

Refer to "Zero adjustment" (P.43) for details.

<Span Adjustment
(2-2 SPAN)>



Perform the span adjustment.
Refer to "Span adjustment" (P.44) for details.

<Zero/Span Initialization
(2-3 SDEF)>

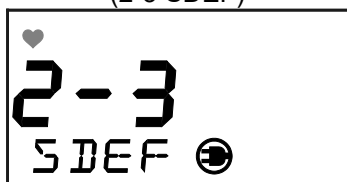

Not used.

<Environmental Setting
(2-4 SET)>

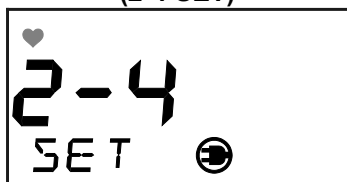

Specify the environmental settings.

2-40: Not used.

2-41: Not used.

2-42: Alarm Value Setting (AL-P)

2-43: Alarm Delay Time Setting (AL-D)

2-44: Alarm Pattern Setting (AL-T)

2-45: Zero Suppression Type Setting (SP-T)

2-46: Zero Suppression Value Setting (SAPP)

2-47: Not used.

2-48: External Output Adjustment (MA20)

2-49: Sensor Operation Start Setting (SSET)

2-4A: Date/Time Setting (DATE)

2-4b: Air Pressure Correction Setting ON/OFF (P-A)

2-4C: Not used.

2-4d: Buzzer ON/OFF Setting (BZZR)

2-4E: Gas Alarm Contact Functionality ON/OFF (AL-R)

2-4F: External Output Signal ON/OFF

2-4H: LCD Backlight ON/OFF (LCD)

2-4J: Alarm Pattern Setting

2-4L: Not used.

Press the **SET** button and refer to "Environmental setting" (P.45) for details.

<Display Setting (2-5 DISP)>

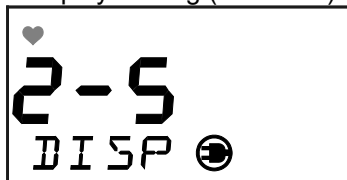

Not used.

<Factory Mode Switching
(2-6 FMODE)>



Not used.

<User Mode Switching
(2-7 UMODE)>

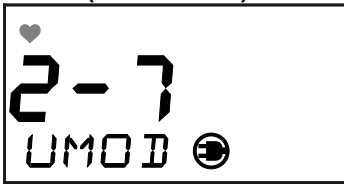

The monitor returns to the user mode.
Press the **SET** button twice to return to the user mode.
Refer to "Return to user mode" (P.52) for details.

6 After making the necessary adjustments, hold down the **MODE** button.

The monitor returns to the measuring state.



WARNING

- After air calibration, **hold down** the **MODE** button to return to the measuring state.
The monitor automatically returns to the measuring state in 10 hours.

Test functions

2-0 TEST

Press the **SET** button to enter the test mode.



SET

2-00 GAS

Press the **SET** button to perform a gas test. Similar to the detection condition, the reading changes and an alarm is displayed after the gas is introduced, but the contact is not activated.

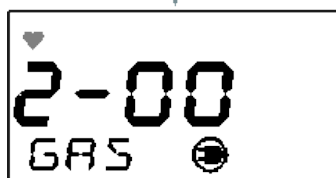

SET



⏴ ⏵

2-01 ALM

Press the **SET** button to perform an alarm test.

Use the **▽** button to decrease the display value to the alarm setpoint to trigger an alarm.

The external output signal and contact activation are enabled. To disable them, specify the activation setting for each in 2-4E and 2-4F.

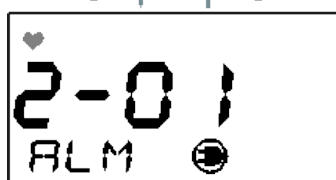

SET

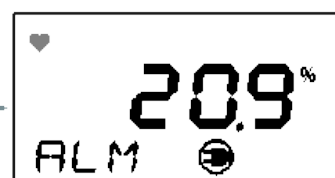

⏴ ⏵

MODE

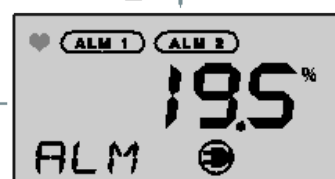

2-02 FALT

Press the **SET** button to perform a fault alarm test.

Use the **▽** or **▲** button to enable the function to trigger an alarm.

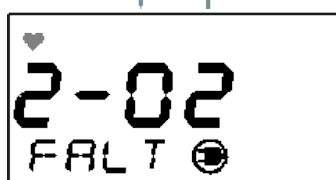

SET



⏴ ⏵

⏴ ⏵



SET

MODE



2-03 LCD

Press the **SET** button to perform a LCD display test.

To disable the enabled function, use the **▼** or **▲** button to select it and press the **SET** button.

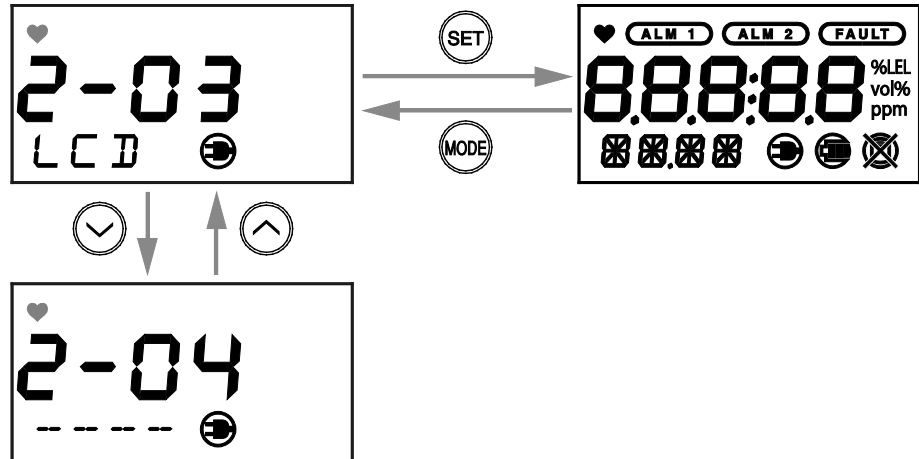

2-04 LCD

Not used.

7-3. Preparation for zero and span adjustment

Perform zero and span adjustment of sensors using a calibration gas more than once every six months. The zero and span adjustment requires dedicated equipment and a calibration gas. Please contact RKI.

<Required Equipment/Material>

Equipment	Calibration cup, fixed flow regulator, sample tubing	
Zero adjustment	N2 (99.9 vol% or more): Zero adjustment, reading accuracy 1, response time check O2 (10.0 - 11.0 vol%): Reading accuracy check 2, alarm delay time check	For details about operation, refer to "Zero adjustment" (P.43).
Span adjustment	Fresh air or zero air if a fresh air environment cannot be verified	For details about operation, refer to "Span adjustment" (P.44).

1. Screw the fixed flow regulator into the calibration cylinder.
2. Use the calibration tubing to connect the regulator to the calibration cup's inlet.
3. Attach the calibration cup to the OX-600.

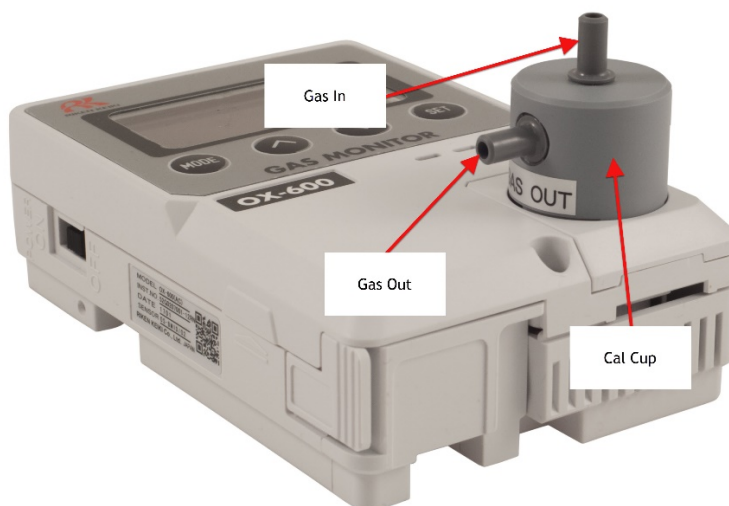
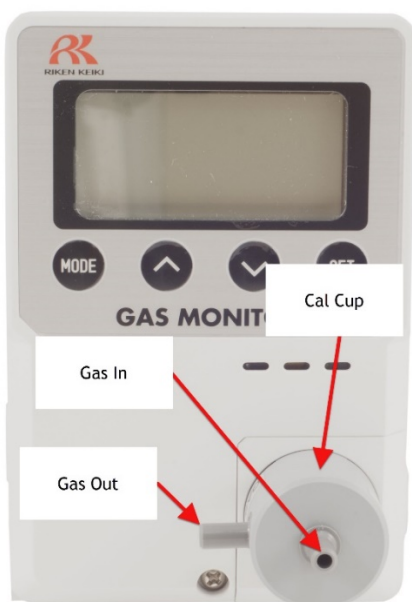

7-4. Zero adjustment

Perform the preparation (P.42) before performing a zero adjustment.

2-1 ZERO

Navigate to the zero adjustment screen.

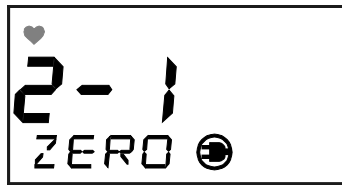

Press the **SET** button to display the current concentration.

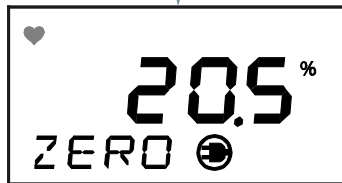

Turn the regulator's knob counterclockwise to open the regulator. Allow gas to flow to the sensor for 2 minutes.

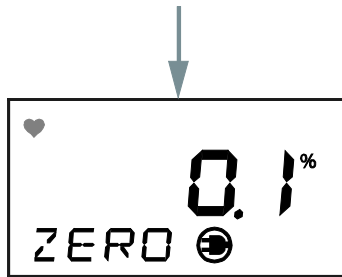

Press the **SET** button.

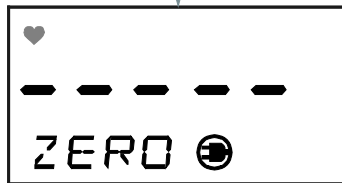

"PASS" is displayed when adjustment is successful, and "FAIL" is displayed when it fails.



or

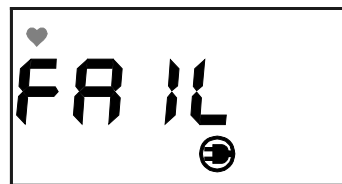

If "FAIL" is displayed, perform zero adjustment again.

Zero adjustment will end.

Turn the regulator's knob clockwise to close it.

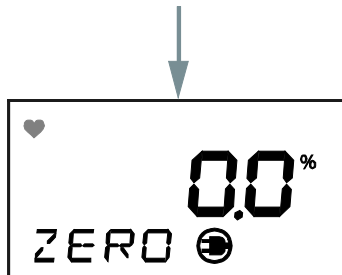

7-5. Span adjustment

Perform the preparation (P.42) before performing a span adjustment. If a fresh air environment cannot be verified, a cylinder of zero air will have to be used.

2-2 SPAN

Navigate to the span screen.

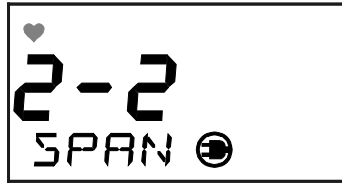

Press the **SET** button to display the current concentration. Turn the regulator's knob counterclockwise to open the regulator. Allow zero air to flow for 2 minutes.

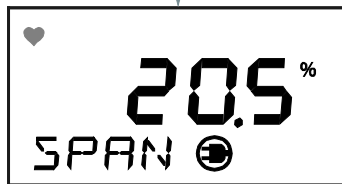

Press the concentration **SET** button again. While the concentration display is blinking, use the **▼** or **▲** button to adjust the reading to "20.9%".



Press the **SET** button.

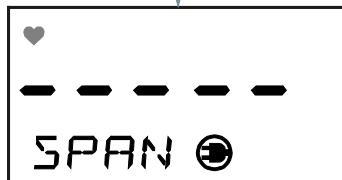

"PASS" is displayed when adjustment is successful, and "FAIL" is displayed when it fails.



or

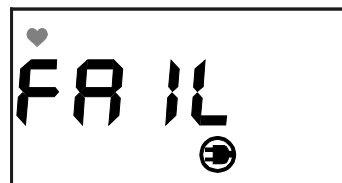

If "FAIL" is displayed, perform span adjustment again.

Span (fresh air) adjustment will end.

Turn the regulator's knob clockwise to close it.

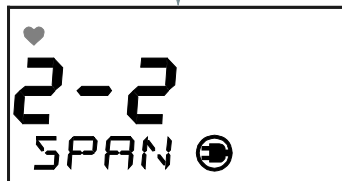

7-6. Environmental setting

2-4 SET

Specify the environmental settings.



2-40

Not used.

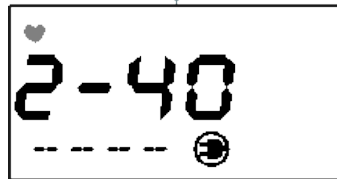

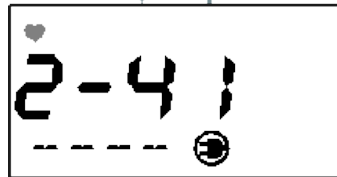

2-41

Not used.



2-42 AL-P

Set the alarm setpoint (first, second). Use the  or  button to set the alarm setpoint and press the  button to confirm it.

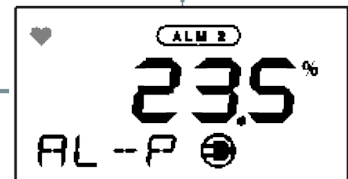
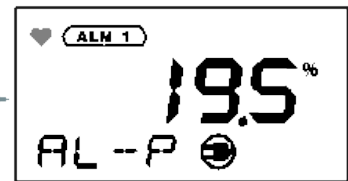
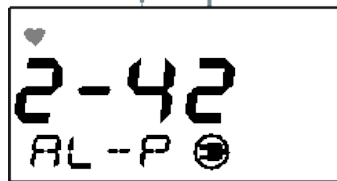

2-43 AL-D

Sets the alarm delay time (seconds).
Use the \downarrow or \uparrow button to set the time and press the **SET** button to confirm it.

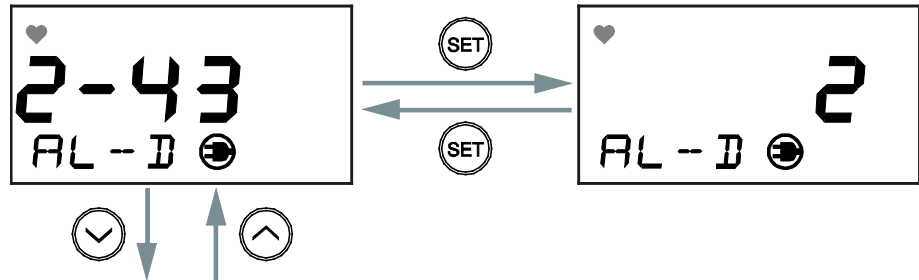

2-44 AL-T

Set the alarm pattern setting.

nL: Non latching
(Self-resetting)
L: Latching

Use the \downarrow or \uparrow button to select the setting and press the **SET** button to confirm it.

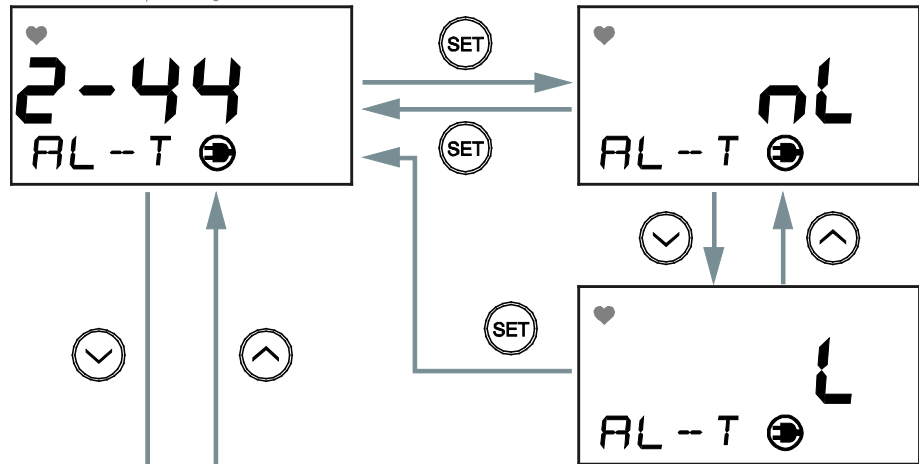

2-45 SP-T

Set the suppression type.

Use the \downarrow or \uparrow button to select the type and press the **SET** button to confirm it.

Slop: when the reading comes out of zero suppression range, the change is gradual.

Cut: when the reading comes out of zero suppression range, the change is a step jump.

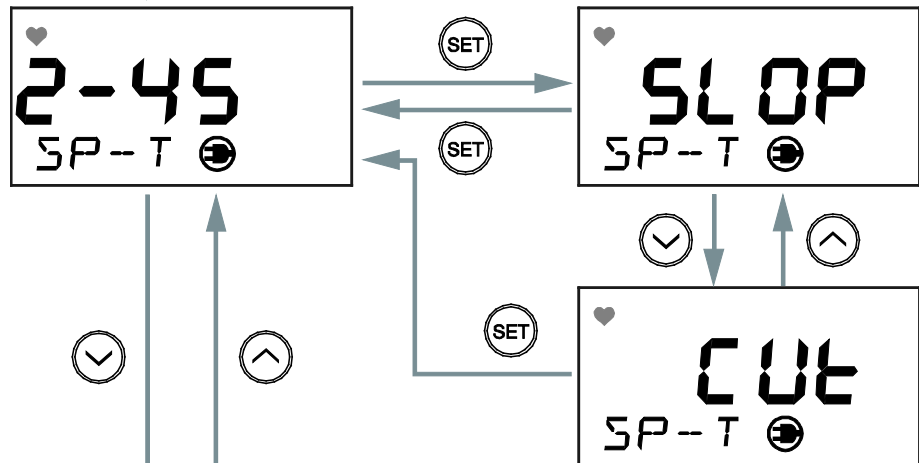

2-46 SAPP

Set the suppression value (%).
Use the \downarrow or \uparrow button to set the value and press the **SET** button to confirm it.

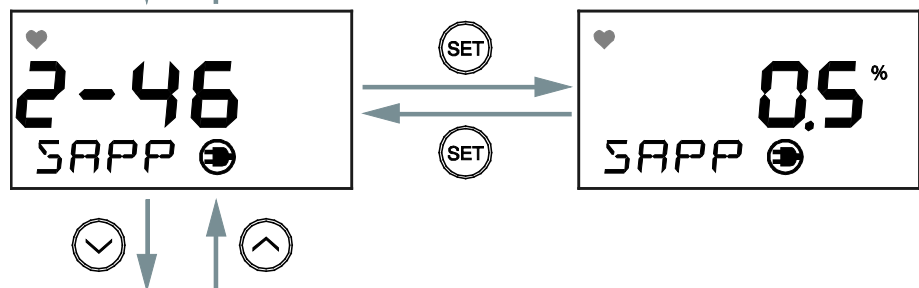

2-47
Not used.

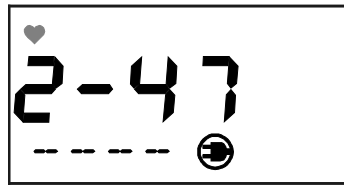

2-48 MA20
Adjust the external output (4 mA, 20 mA). Use the \leftarrow or \rightarrow button to set the value and press the **SET** button to confirm it.

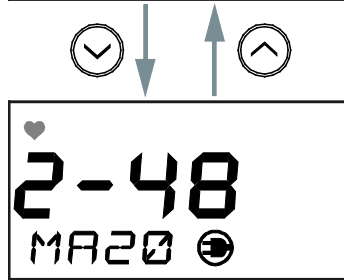

When "Adj" is displayed, connect an ammeter. Then, use the \leftarrow or \rightarrow button to adjust the value to 4 mA or 20 mA and press the **SET** button to confirm it.

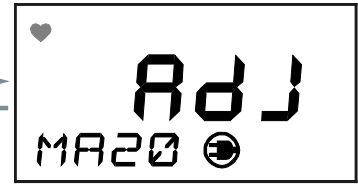
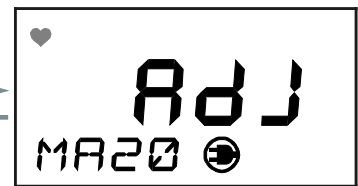

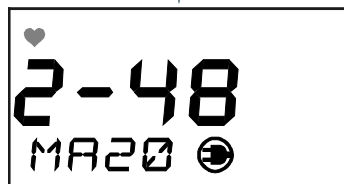

2-48 MA20
The monitor returns to MA20.



2-49 SSET
Set the sensor operation start.



2-4A DATE

Set the date/time.
Use the  or  button to change the year, month, day, hour and minute and press the  button to confirm it.

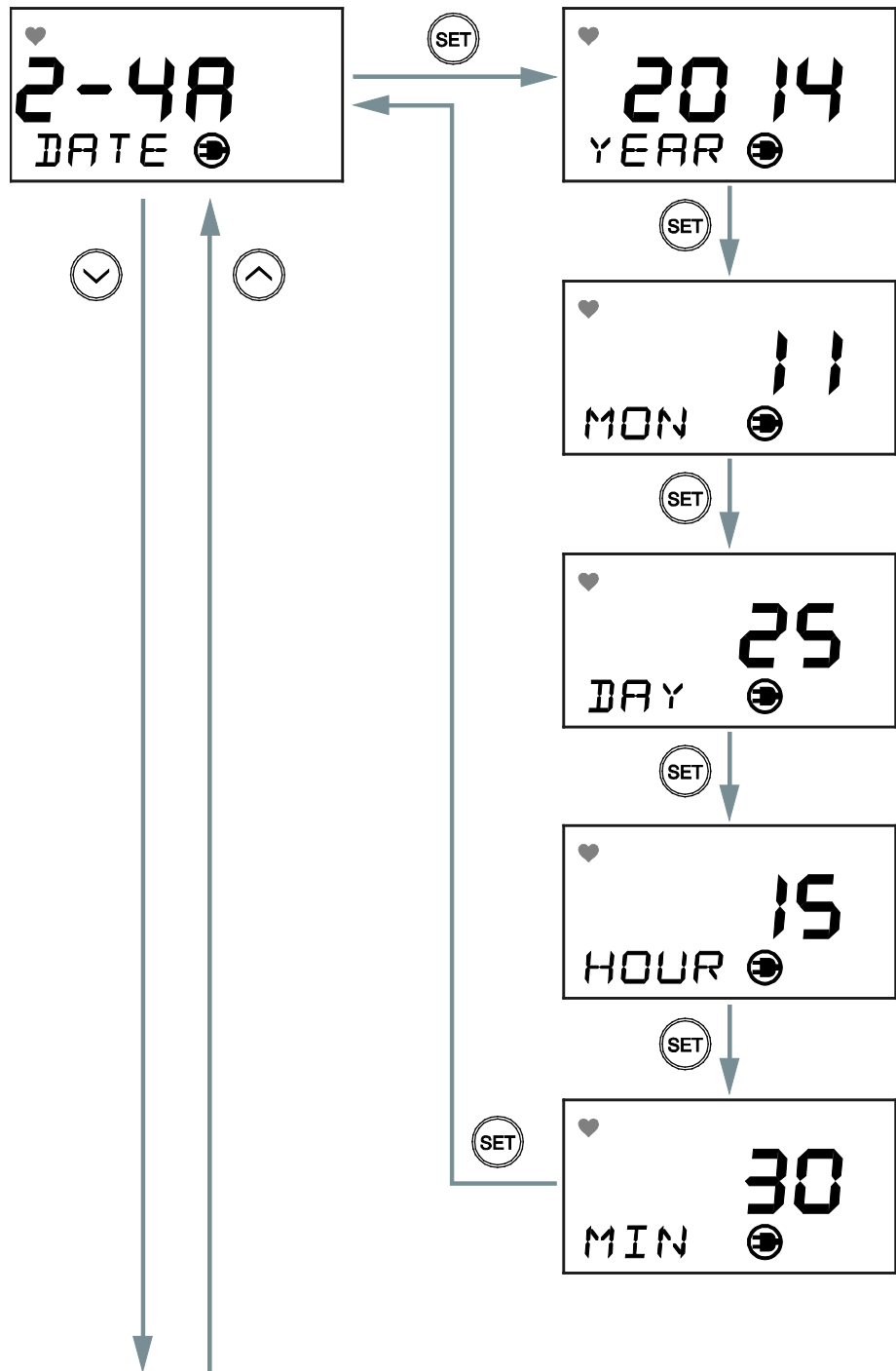

2-4b P-A
Set the air pressure correction to ON/OFF.

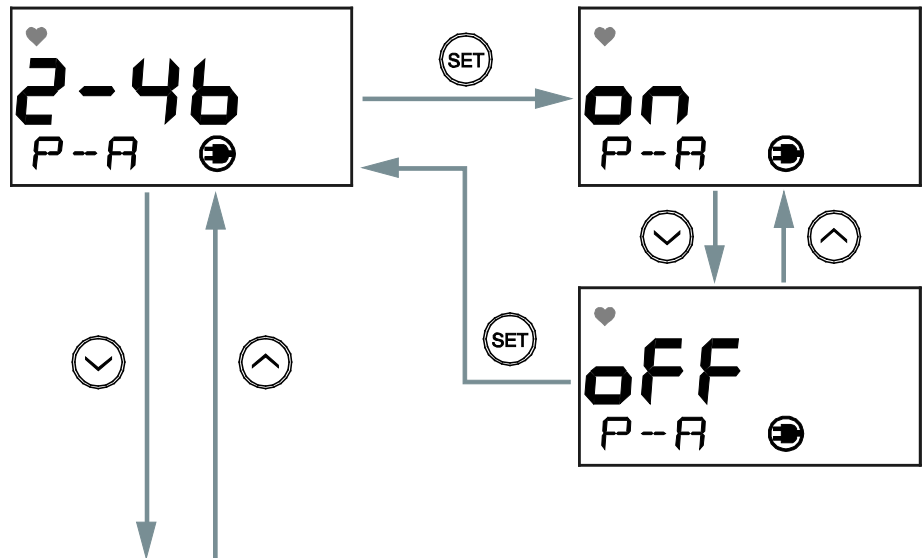

2-4C
Not used.

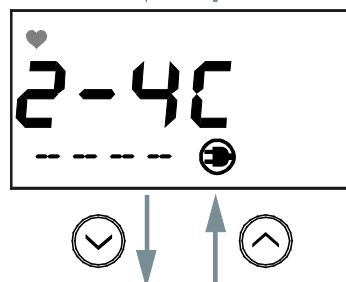

2-4d BZZR
Set each of the first and second alarm buzzers to ON/OFF.

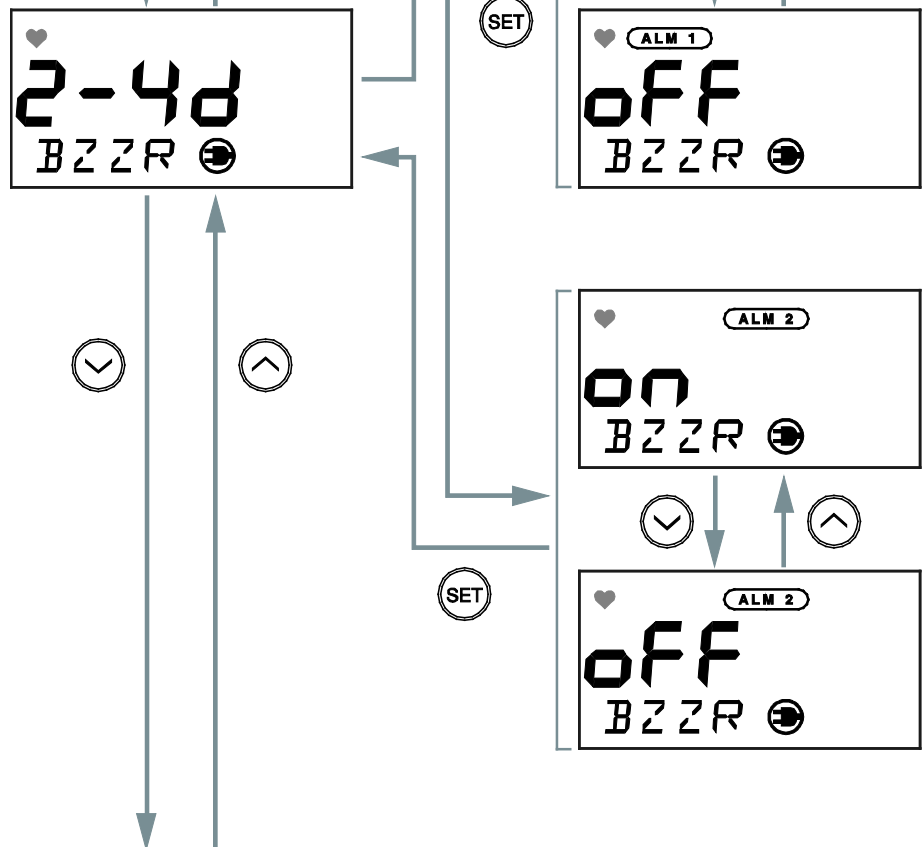

2-4E AL-R

Turn the relay contact functionality on or off.

If set to on, the relay will change state during an alarm condition.

If set to off, the relay will not change state when an alarm condition occurs.

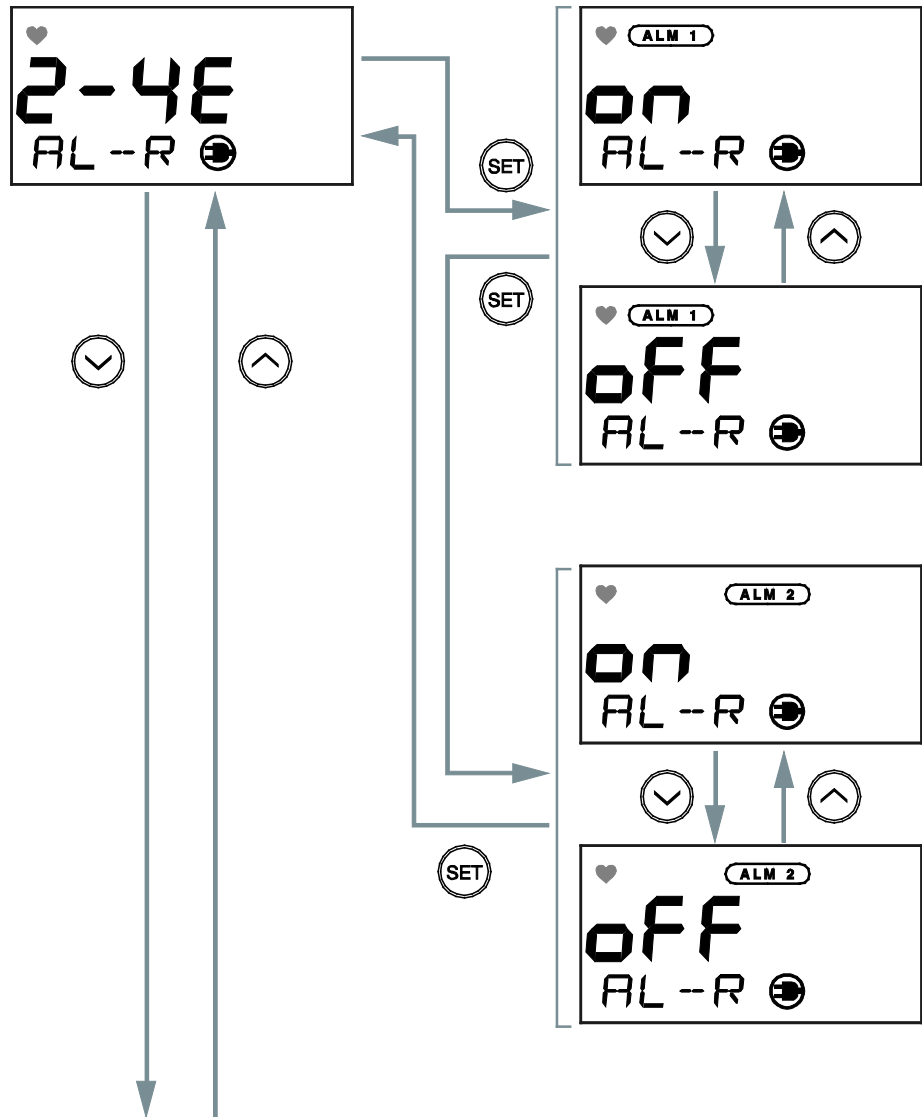

2-4F MA-O

Set the external output signal during an alarm test to ON/OFF.

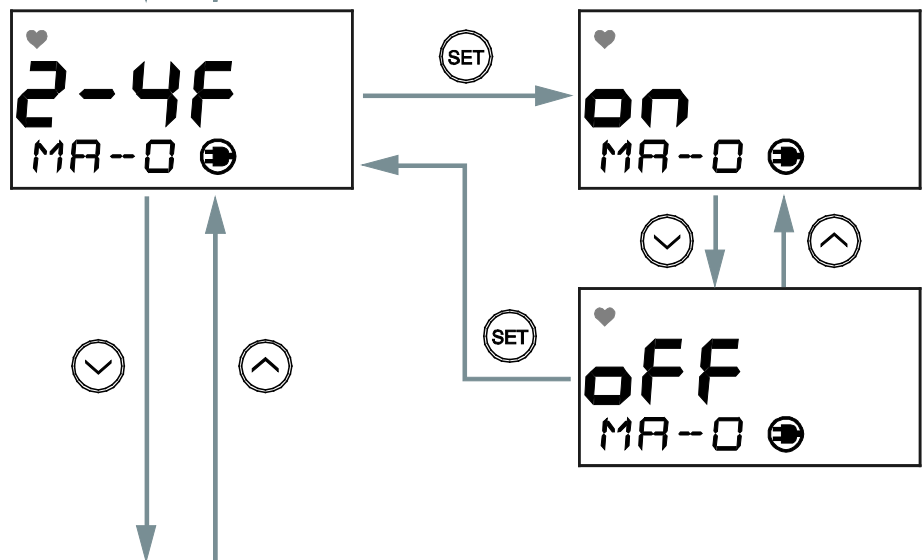

2-4H LCD

Set the LCD backlight to ON/OFF.

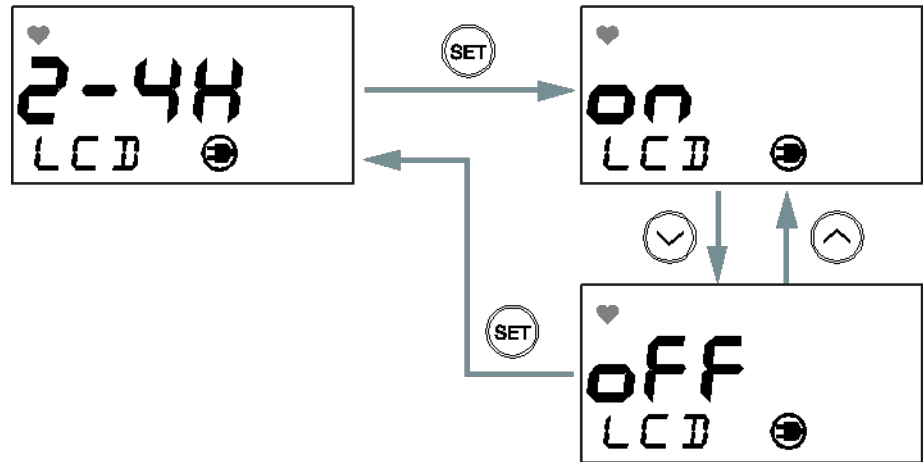

2-4J Alarm Pattern Setting

Change the alarm pattern to L-LL (both alarms decreasing), L-H (first alarm decreasing, second alarm increasing), or H-HH (both alarms increasing).

7-7. Return to user mode

2-7 UMOD

The monitor returns to the user mode.

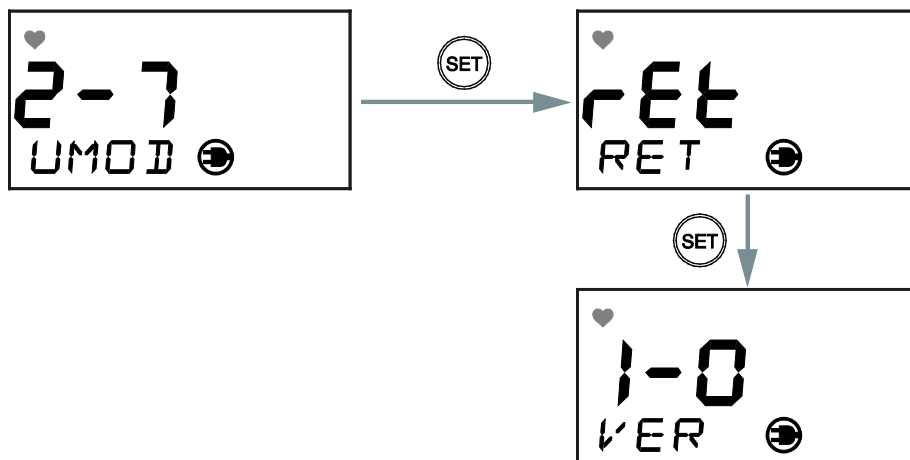

7-8. Component Replacement

<Replacing the Batteries (for dry battery type)>

Refer to "Installation of batteries (for dry battery type)"(P.10) for instructions to replace the batteries.

<Replacing the Sensor (Integrated Sensor Type)>

- 1 Remove the sensor cover of the sensor part.

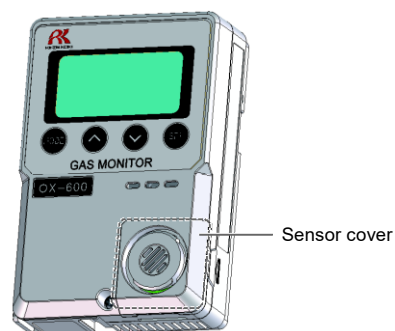

- 2 Insert a coin straight to the recessed area at the lower right of the monitor to release the sensor cover's latch.

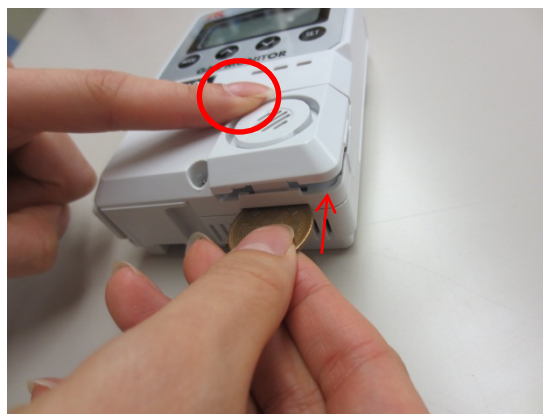

3 Remove the sensor cover.



4 Remove the old sensor.

5 Install the new sensor.
Be sure the sensor pins are lined up with the board's sockets.



6 Put the sensor cover back on.



CAUTION

- When installing the sensor, be sure the pins are lined up with the sockets before pushing in the sensor. Ignoring this may bend and damage the sensor pins.
- After the sensor is installed, always perform a calibration (zero adjustment and span adjustment).
- Do not disassemble the sensor because it contains electrolyte. If contact occurs, rinse the area immediately with a large quantity of water.
- The sensor must be stored under normal temperature/humidity in a clean place away from direct sunlight.

<Replacing the Sensor (Remote Sensor Type)>

1 Remove the sensor cover of the sensor unit.

Push the tabs on the both sides with your fingers to release the sensor cover latch.

Remove the sensor cover to check the sensor.



2 Remove the old sensor.

3 Install the new sensor.

Be sure the sensor's pins are lined up with the board's sockets.

4 Put the sensor cover back on.

7-9. Replacing a Sensor Cable

NOTE

- The wire colors in the extender cable may vary depending on the type of cable used. The Type A cable has red/green/white/black wires, and the Type B cable has white/yellow/white/blue wires. The pictures in this section show the Type A cable.

1 Turn off or disconnect power to the OX-600.

2 Remove the sensor cover of the old cable's remote sensor housing.

Push the tabs on both sides of the sensor cover with your fingers to release the sensor cover latch.

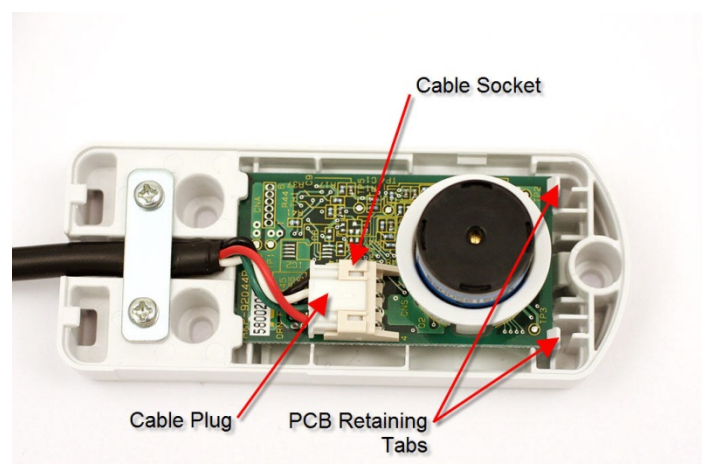

- 3 Remove the cable plug from the cable socket on the sensor board.**
Press the tab on the plug to release it and pull it away from the socket.



- 4 Push the PCB retaining tabs back, grasp the cable socket, and lift the sensor board out of the housing. Set the sensor board aside.**

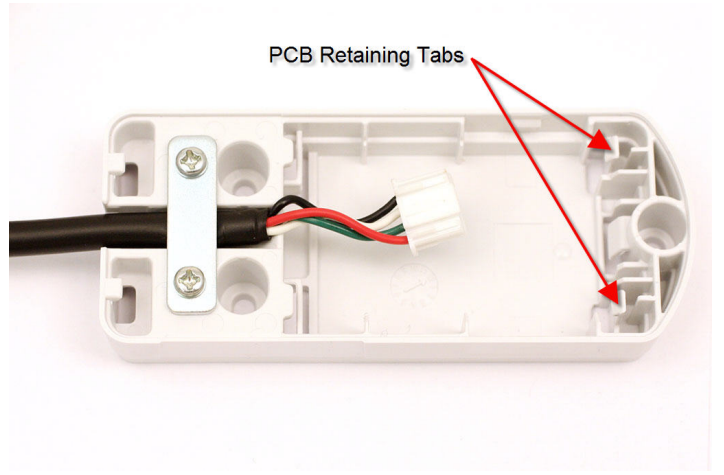

- 5 Remove the top half of the main unit's housing to access the wiring at the other end of the cable.**

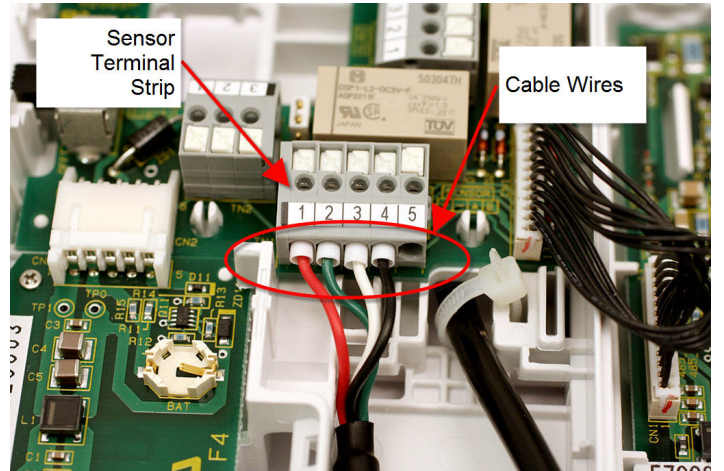

- 6 Remove the old cable's wiring leads from the sensor terminal strip.**

For each terminal strip position:

- Push the push button straight downward using the compatible screwdriver or equivalent to open the spring.
- Remove the wire.
- Release the screwdriver.

- 7 Pull the old cable out of the housing.**

- 8** Route the new cable's wires through the hole in the housing to the right of the sensor terminal strip and install a zip tie in the case and around the cable as shown in this picture but do not tighten it yet.

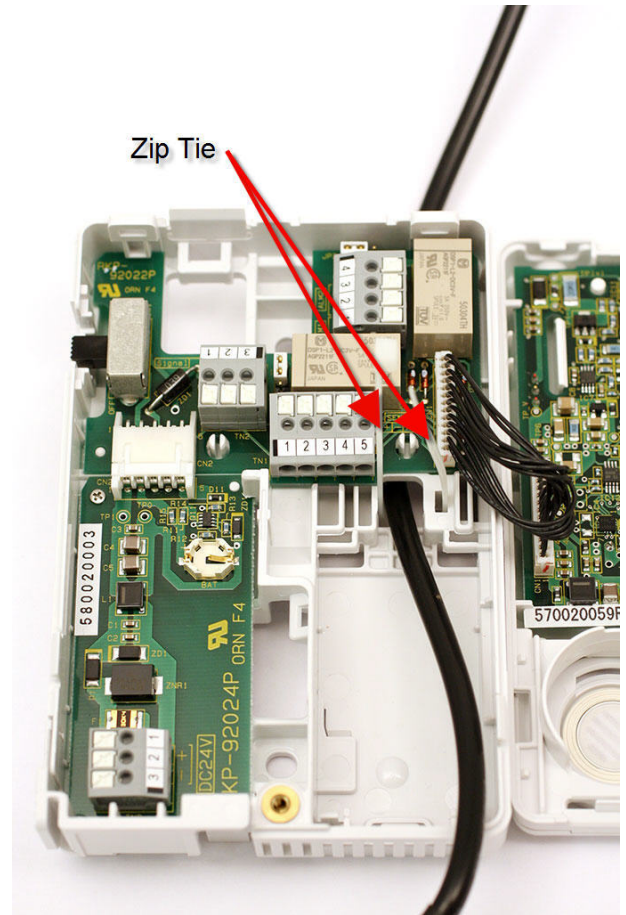

- 9** Connect the cable's wires to the sensor terminal strip. See the table below for the wire colors. Type A wire colors are shown in the pictures below. Note that the Type B cable has two pairs of wires extending from the cable. Tighten the zip tie to secure the cable in place.

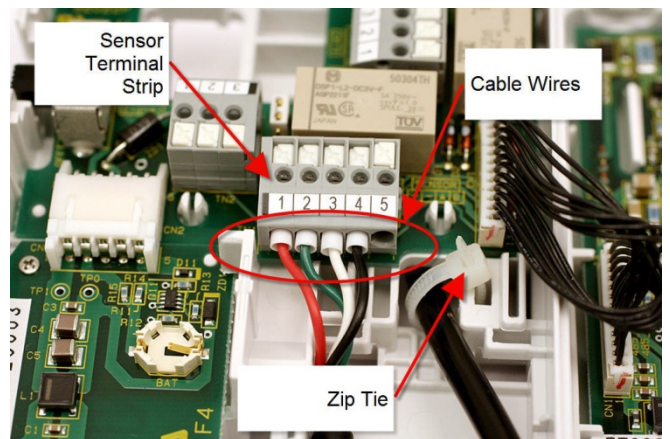

	Terminal 1	Terminal 2	Terminal 3	Terminal 4
Type A	Red	Green	White	Black
Type B	White wire of white/yellow pair	Yellow wire of white/yellow pair	White wire of white/blue pair	Blue wire of white/blue pair

10 Secure the top half of the main unit's housing to the bottom half.

11 Remove the sensor cover of the new cable's remote sensor housing and install the sensor board. The board will click into place.

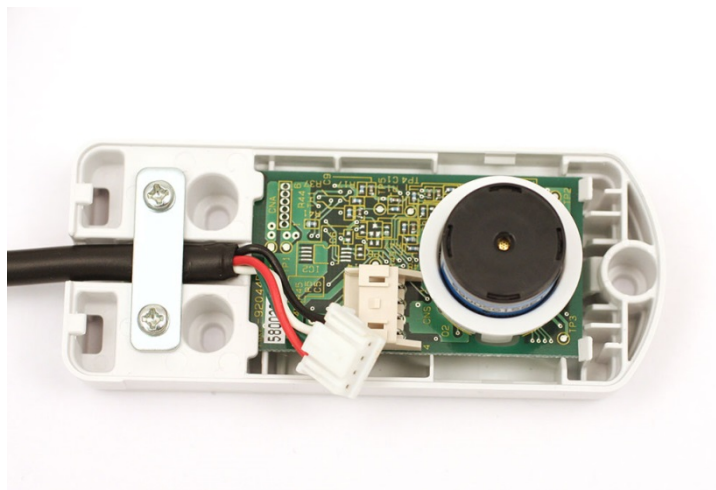

12 Connect the new cable's connector to the sensor board.

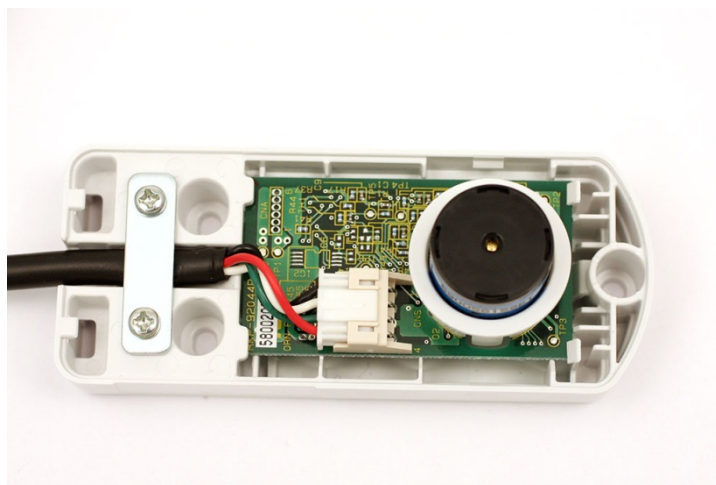

13 Secure the sensor cover of the new cable's remote sensor housing.

7-10. Adding a Sensor Cable

NOTE

- The wire colors in the extender cable may vary depending on the type of cable used. The Type A cable has red/green/white/black wires, and the Type B cable has white/yellow/white/blue wires. The pictures in this section show the Type A cable.

- 1 Turn off or disconnect power to the OX-600.
- 2 Remove the top half of the main unit's housing.

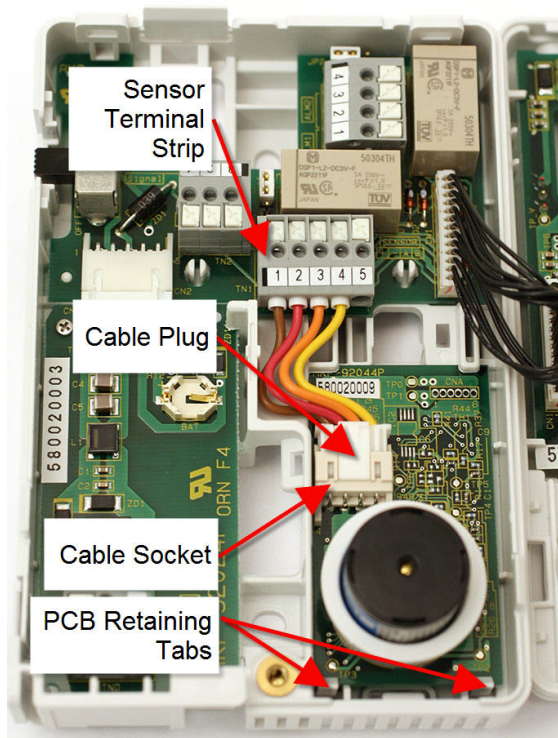

3 Remove the cable plug from the cable socket on the sensor board.

Press the tab on the plug to release it and pull it away from the socket.

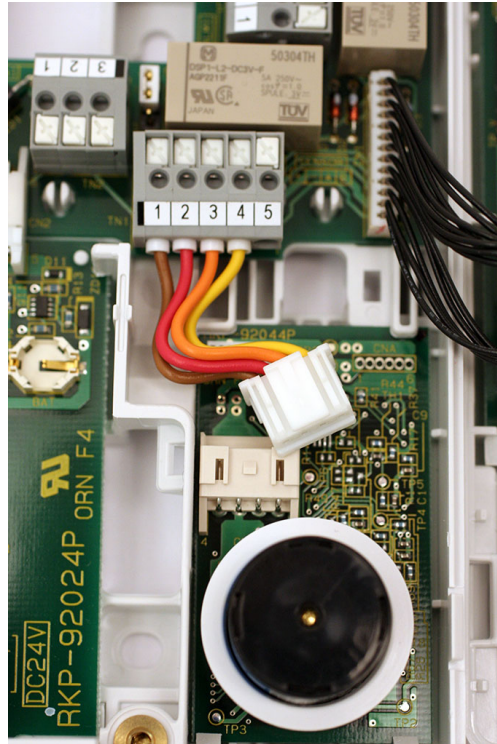

4 Unplug the wires from the sensor terminal strip.

For each terminal strip position:

- Push the push button straight downward using the compatible screwdriver or equivalent to open the spring.
- Remove the wire.
- Release the screwdriver.

The cable connector with the short length of wires will not be needed once the cable is installed.

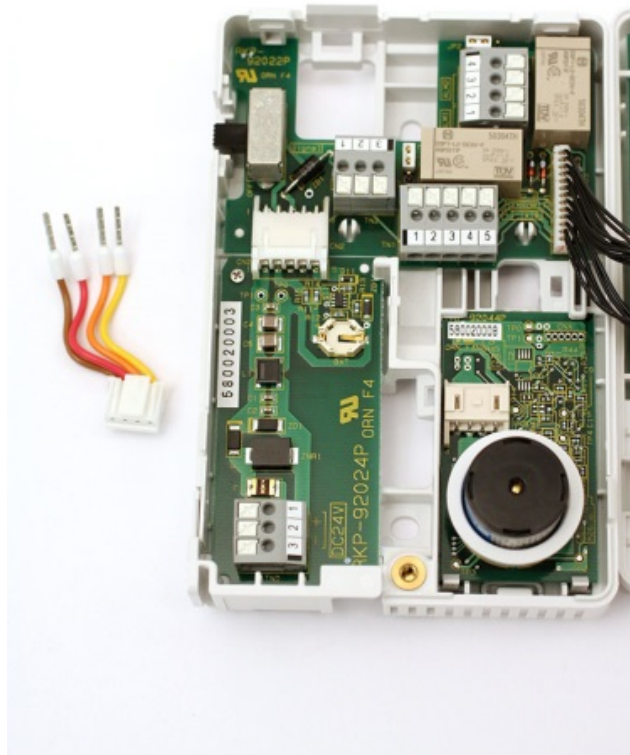

- 5** Push the PCB retaining tabs back, grasp the cable socket, and lift the sensor board out of the housing. Set the sensor board aside.

- 6** Remove the sensor cover of the cable's remote sensor housing. Push the tabs on both sides of the sensor cover with your fingers to release the sensor cover latch.

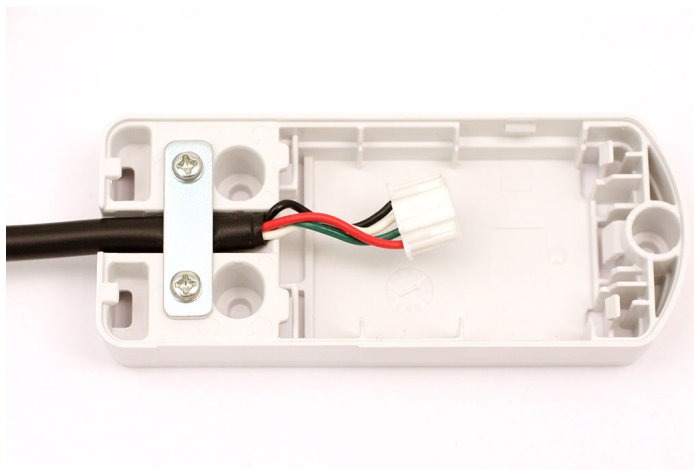

- 7** Install the sensor board. The board will click into place.

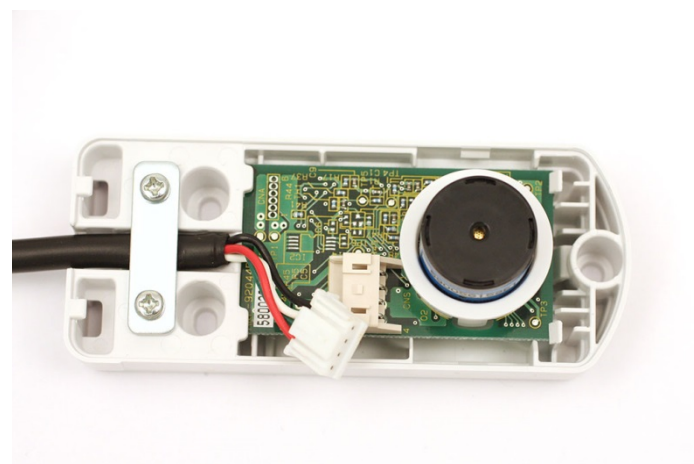

- 8** Connect the cable's connector to the sensor board.

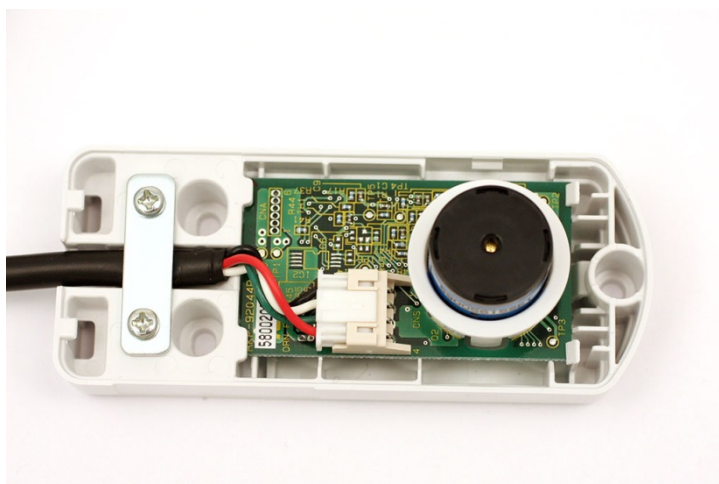

- 9** Secure the sensor cover of the new cable's remote sensor housing.

- 10** Route the new cable's wires through the hole in the housing to the right of the sensor terminal strip and install a zip tie in the case and around the cable as shown in this picture but do not tighten it yet.

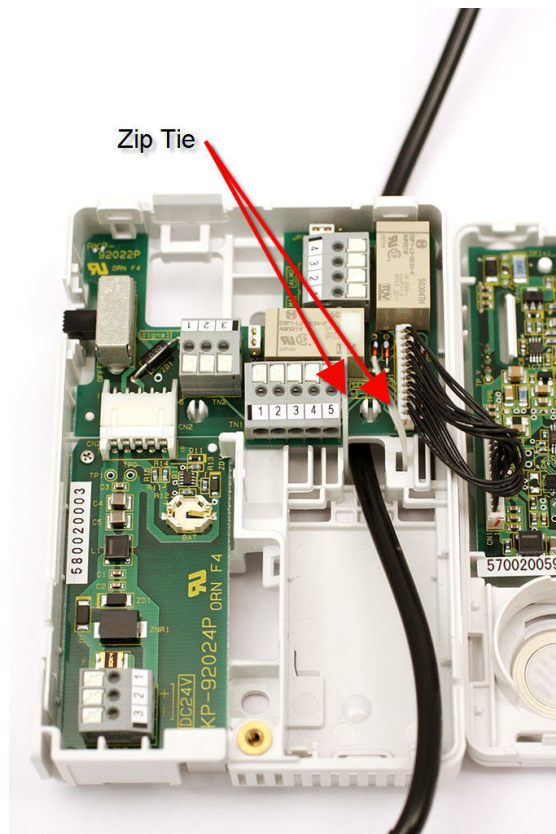

- 11** Connect the cable's wires to the sensor terminal strip. See the table below for the wire colors. Type A wire colors are shown in the pictures below. Note that the Type B cable has two pairs of wires extending from the cable. Tighten the zip tie to secure the cable in place.

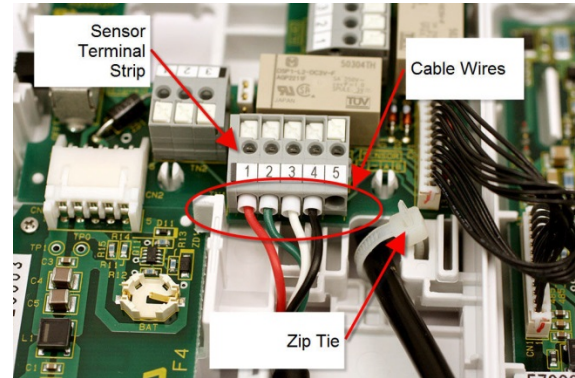

	Terminal 1	Terminal 2	Terminal 3	Terminal 4
Type A	Red	Green	White	Black
Type B	White wire of white/yellow pair	Yellow wire of white/yellow pair	White wire of white/blue pair	Blue wire of white/blue pair

- 12** Secure the top half of the main unit's housing to the bottom half.

8

Storage and Disposal

8-1. Procedures to store the monitor or leave it for a long time

The monitor must be stored under the following environmental conditions.

- In a dark place with normal temperature and humidity and away from direct sunlight
- In a place where gases, solvents, vapors, etc. are not present

Store the monitor in a shipping carton, in which the product was delivered, if possible.

Store the monitor away from dust, etc. if the shipping carton is not available.



CAUTION

- If the monitor operating on dry batteries is not used for a long time, store it after removing the batteries. Battery leaks may result in fire, injury, etc.

8-2. Procedures to relocate the monitor or use it again

When the monitor is relocated, refer to "How to Install" for relocation sites and wiring work. The unpowered time must be minimized when the monitor is relocated.

When the monitor is used again after long-term storage, perform a calibration.



CAUTION

- Contact RKI for information on readjustment including calibration.

8-3. Disposal of products

When the monitor is disposed of, it must be treated properly as an industrial waste in accordance with the local regulations, etc.

If liquid leaks from the sensor, do not touch the liquid. The sensor must be put into a plastic bag to prevent the liquid from leaking to the outside. If any liquid leaked from the sensor is found in the monitor unit, turn off the power and contact RKI immediately.



WARNING

- Do not disassemble the galvanic cell type sensor because it contains electrolyte. Electrolyte may cause severe skin burns if it contacts skin and may cause blindness if it contacts eyes. If electrolyte gets on clothing, the material will discolor or deteriorate. If contact occurs, rinse the area immediately with a large quantity of water.
- Dispose of batteries in accordance with a procedure specified by the local authority.

9

Troubleshooting

This Troubleshooting section does not explain the causes of all the malfunctions which could occur on the monitor. This simply helps to find the causes of malfunctions which frequently occur.

If the monitor shows a symptom which is not explained in this manual or still has malfunctions even though remedial actions are taken, please contact RKI.

Symptom/Display	Causes	Actions
The power cannot be turned on.	The power switch is turned off.	Turn on the power switch.
	Abnormalities/momentary blackout of power supply system	Provide the rated voltage. Take measures such as checking or adding the UPS, power supply line filter and insulation transformer.
	The main unit is not installed properly.	Check whether the main unit is properly attached to the wall-mounted unit.
	Cable abnormalities (open circuit/not connected/short circuit)	Check the wiring of the monitor and related devices around it.
	The batteries are dead. *Only for the dry battery type	Replace the two dry batteries.
Abnormal operations	Disturbances by sudden surge noise, etc.	Turn off and restart the monitor. If a symptom like this is observed frequently, take appropriate measures to eliminate the noise.
Sensor abnormalities E-1	The sensor is not connected or improperly connected.	Check that the sensor is connected and the connectors of the sensor unit board are securely fastened.
	Errors in communication with the unit	Replace the sensor unit board with a new one.
Clock abnormalities E-9	Abnormalities of the clock inside the monitor	Make a setting of date/time. If a symptom like this is observed repeatedly, the built-in clock is seemingly malfunctioning. Thus, it must be replaced. Please contact RKI.
System abnormalities E-9 SYSTEM	The rated voltage is not supplied to the monitor.	Check the power supply, and supply the rated voltage.
	Abnormalities of ROM, RAM or EEPROM inside the monitor	Please contact RKI.
The reading drops and remains low.	Drifting of sensor output	Perform the air calibration.
	Presence of interference gas	Disturbances by interference gases, such as solvents, cannot be eliminated completely. For information on actions, such as removal filter, please contact RKI.
	Environmental changes	Perform the air calibration. In particular, the galvanic cell type is affected by the air pressure.
An oxygen deficiency alarm is triggered even though there are no	Presence of interference gas	Disturbances by interference gases, such as solvents, cannot be eliminated completely. For information on actions, such as removal filter, please contact RKI.

Symptom/Display	Causes	Actions
abnormalities at the detection point.	Disturbance by noise	Turn off and restart the monitor. If a symptom like this is observed frequently, take appropriate measures to eliminate the noise.
	Sudden change in the environment	When the environment (temperature, etc.) changes suddenly, the monitor cannot adjust to it and is affected by it. In some cases, the monitor triggers an indication alarm. Because the monitor cannot be used under sudden and frequent environmental changes, the user should take some preventive actions to eliminate them.
	Deteriorated sensor sensitivity	Replace the sensor with new one.
Span adjustment impossible	Improper calibration gas concentration	Use the proper calibration gas.
	Deteriorated sensor sensitivity	Replace the sensor with new one.

10

Product Specifications

10-1. List of specifications

Detection principle	Galvanic cell type
Gas to be detected	Oxygen
Concentration display	LCD digital display (Three-digit, seven-segment/green, orange and red backlight) *No backlight during normal operation for the dry battery type
Detection range	0 - 25 vol%
Display resolution	0.1 vol%
Detection method	Diffusion type or remote detection method
Alarm setpoint	19.5 vol% (first)/23.5 vol% (second) [Standard setting]
Accuracy of the reading (under the same conditions)	Within ± 0.7 vol%
Response time (under the same conditions)	90% response: within 30 seconds
Gas alarm type	(L-H)
Gas alarm display	First: Lights up the concentration display and backlight (orange), buzzer Second: Lights up the concentration display and backlight (red), buzzer
Gas alarm pattern	Self-latching or non-latching (Auto-reset)
Gas alarm contact*1	No-voltage contact 1a or 1b and normally de-energized (energized in response to an alarm)
Fault alarm/self diagnosis	System abnormalities/sensor connection abnormalities
Fault alarm display	Alarm detail display and backlight blinking (red), buzzer
Fault alarm pattern	Non latching (auto-reset)
Contact capacity*1	125 VAC - 1 A or 30 VDC - 1 A (Resistance load)
Transmission specifications	4 - 20 mA DC (no-insulation/load resistance under 300 Ω) or 0 - 1 VDC (no-insulation) *Only 0 -1 VDC for the dry battery type
Cable for gas detector head	Dedicated cable for remote (3, 5, 10 or 20 m)
Power supply	100 - 120 VAC $\pm 10\%$ (50/60 Hz), 24 VDC $\pm 10\%$ or AA alkaline dry battery (2 pcs.)
Power consumption	AC specification: Max. 5 VA/DC specification: Max. 3 W
Dry battery	Approx. one year (25°C, no alarm and no backlight)
Continuous operating time	*When using two AA alkaline dry batteries
Initial clear	Approx. 25 seconds
Operating temperatures	-10 - +40°C (at a constant condition)
Operating humidities	Below 90%RH (Non-condensing)
Structure	Wall mounting type, sensor integrated type or remote type
Outline dimensions	Main unit: Approx. 80 (W) x 120 (H) x 35.5 (D) mm Remote sensor: Approx. 40 (W) x 96 (H) x 35.5 (D) mm (projection portions excluded)
Weight	AC specification: Approx. 200 g/DC specification: Approx. 180 g/Dry battery type: Approx. 230 g Remote sensor part: Approx. 55 g (cable excluded)

*Specifications subject to changes without notice

**Some operations are different between the dry battery type and DC/AC specification

*1 No contact for dry battery type

10-2. List of accessories

- 3.2 m AC power cable (1 pc.) *Supplied only with AC specification
- Cross-recessed pan head machine screw (2 pcs.)
- Cross-recessed round head wood screw (2 pcs.)
- Operating manual (1 pc.)

11

Spare Parts List

Part Number	Description
06-1248RK-03	Calibration tubing, 3 foot length
21-1927	Mounting plate for instrument removal
45-0443RK	Bar terminal with red insulation, for 18 AWG
45-0444RK	Bar terminal with black insulation, for 16 AWG
45-0445RK	Bar terminal with blue insulation, for 14 AWG
45-0446RK	Bar terminal with gray insulation, for 12 AWG
46-5100RK	Lever, wiring tool
47-1556-03	Extender cable with remote box, 3 meters
47-1556-05	Extender cable with remote box, 5 meters
47-1556-10	Extender cable with remote box, 10 meters
47-1556-20	Extender cable with remote box, 20 meters
49-1120RK	AA size alkaline battery
81-0078RK-01	Calibration cylinder, 100% N2, 34 liter
81-1050RK	Regulator, fixed flow, 0.5 LPM, with gauge and knob, for 17- and 34-liter cylinders
81-1153	Calibration cup
81-OX600-LV	Calibration kit with calibration cup, 0.5 LPM fixed flow regulator, 100% N2 cylinder, and calibration tubing
OS-BM1D	Oxygen sensor

12

Appendix

12-1. Detection principle of galvanic cell type

By immersing precious metal and lead in electrolyte and connecting them with a lead wire, a battery can be made (galvanic cell).

When oxygen passes through the barrier, deoxidizing reaction occurs at the precious metal electrode while oxidizing reaction occurs at the lead electrode.

The electric current generated by this reaction goes through load resistance (thermister), where it is converted into voltage so that it can be read. When the oxygen concentration is decreased, deoxidizing reaction at the precious metal electrode is also decreased, thus lowering the voltage at both ends of the thermister.

<Structure Diagram>

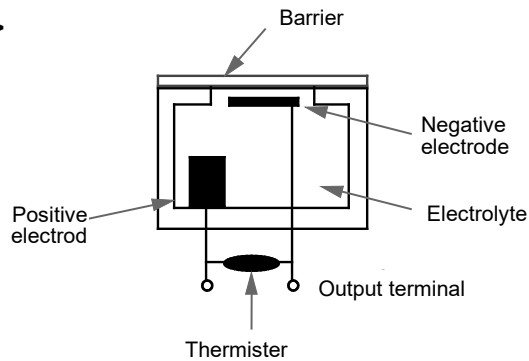

Important precautions

1. The readings of the monitor fluctuate slightly in response to changes in the air pressure. In particular, be careful of alarm activation when a low air pressure is brought in by typhoon, etc. In addition, it may be fluctuated by environmental (temperature, humidity, etc.) changes in the installation site.
2. The alarm must be set within a range where the performance of the monitor can be ensured. The standard alarm setpoint values are 18 vol% for the first and 19 vol% for the second.
3. This is a safety unit. This is not a control unit. The alarm contact output of the monitor must be used for an external alarm lamp/buzzer, while the analog signal output must be used for an indicator or external recorder. If these outputs are used to control other units, we shall not be responsible for any malfunctions.
4. For maintenance of the monitor, it must go through a regular maintenance, including replacement and adjustment of the regular replacement parts as specified in the operating manual. In addition, because this is a safety unit, it is recommended that a regular maintenance and span adjustment are performed every six months.

12-2. Definition of terms

vol%	Gas concentration indicated in the unit of one-hundredth of the volume
Calibration	Find relationship of the readings, display values or setpoints with the actual values by using the calibration gas.
Maintenance mode	When maintenance is performed on the monitor, the alarm contact is disconnected, and a signal to indicate the maintenance mode status is sent out to the external output signal. As a result, maintenance can be performed on a single unit of the monitor.
Initial clear	The reading is unstable for seconds after the power is turned on. To prevent malfunctions for that period, the alarm contact is deactivated. In addition, a signal to indicate the initial clear status is sent out to the external output.
Zero suppression	A function to cut off the influences of environmental changes, interference gases, etc.
Alarm delay time	A function which temporarily suspends activation to prevent a false alarm caused by noise from its outside.