

Technical Information

Tankvision NXA820, NXA821, NXA822

Tank Gauging

Inventory Management System with completely integrated software for operation via standard web browser



Application

Tankvision is a dedicated tank inventory system which is operated by a standard web browser and does not require proprietary software or licensing costs.

Tankvision is based on a distributed architecture on a Local Area Network (LAN). Due to its modular structure it can be adjusted to any application. It is ideally suited for small tank farms with only a couple of tanks, but also for large refineries with hundreds of tanks.

Tankvision consists of the following components:

- **Tankvision Tank Scanner NXA820**
scans parameters from tank gauges and performs tank calculations (option)
- **Tankvision Data Concentrator NXA821**
summarizes data from various Tank Scanners NXA820
- **Tankvision Host Link NXA822**
provides data to host systems (such as PLC or DCS) via Modbus

Your benefits

- License-free, with access for up to 10 users
- Approved for custody transfer applications according to NMI, PTB and others
- Modular design; easily adjustable to any application; can be upgraded as required
- Configuration, commissioning and operation via web browser; no proprietary software required
- Common hardware platform for all components; no hard disc or fans to wear out
- Volume calculations and correction included according to international standards (API/ASTM/IP tables) in Tank Scanner NXA820 (optional)
- Includes OPC Data Access server for Windows PC

Table of contents

| | | | |
|---|-----------|---|-----------|
| Applications | 3 | Ordering information | 15 |
| Inventory control | 3 | Operability | 15 |
| Inventory calculations (option) | 3 | Operating concept | 15 |
| Remote configuration of measuring equipment | 3 | Languages | 15 |
| Application areas | 3 | Certificates and approvals | 15 |
| Function and system design | 3 | Metrological approvals | 15 |
| System design | 3 | Supplementary documentation | 16 |
| System configuration | 5 | Operating Instructions | 16 |
| Features | 5 | Description of Instrument Functions | 16 |
| Security | 6 | Registered trademarks | 16 |
| Typical system configuration | 7 | Microsoft Corporation | 16 |
| Wiring example for NXA820/821/822 | 7 | Schneider Electric | 16 |
| Wiring example for NXA820 "Interface only" | 8 | Oracle Corporation | 16 |
| Wiring examples for a wireless connection of NXA820 | 8 | Legal notice concerning trademarks | 17 |
| Function of the components | 9 | | |
| Tankvision Tank Scanner NXA820 | 9 | | |
| System limitations | 9 | | |
| Tankvision OPC Server | 10 | | |
| Tankvision Alarm Pop-Up-Agent | 10 | | |
| Tankvision Printer Agent | 10 | | |
| Tankvision Data Concentrator NXA821 | 10 | | |
| Tankvision Host Link NXA822 | 11 | | |
| NXA820 "Interface only" | 11 | | |
| Inputs and outputs | 11 | | |
| Galvanic isolation | 11 | | |
| LAN connections | 11 | | |
| Fieldbus protocols (NXA820) | 12 | | |
| Host connection (NXA822) | 12 | | |
| NXA Status Relay | 12 | | |
| Power supply | 12 | | |
| Power supply NXA 82x | 12 | | |
| Installation | 12 | | |
| Mounting location | 13 | | |
| Installation instructions | 13 | | |
| System requirements of user PC | 13 | | |
| Network requirements | 13 | | |
| Shielding and Grounding | 13 | | |
| Environment | 14 | | |
| Ambient temperature range | 14 | | |
| Storage temperature | 14 | | |
| Humidity | 14 | | |
| Operating height | 14 | | |
| Degree of protection | 14 | | |
| Electromagnetic compatibility (EMC) | 14 | | |
| Mechanical construction | 14 | | |
| Dimensions | 14 | | |
| Materials | 14 | | |

Applications

Inventory control

By using Tankvision to monitor the tank level and stored volume of valuable liquids remotely, owners or operators of tank farms or terminals for petroleum products and chemicals (liquids) can visualize the volume of the stored medium in real time. The data can be used to plan the inventory and distribution. The data can also be used to manage tank farm operations like pumping or transferring products.

Tankvision has its unique concept using network technology. Without using proprietary software, the users can visualize and manage their valuable liquids stored in the tanks by a web browser. Tankvision is a flexible and cost effective solution due to its scalable architecture. The application coverage goes from small depots with only a few tanks up to refineries.

Choosing the "Interface only" option in Tank Scanner it becomes a fit-for-purpose interface unit to the tank gauges for Tankvision Professional.

Inventory calculations (option)

Based on measured variables and tank capacity tables, Tankvision calculates:

- Gross volumes
- Net volumes
- Mass

Volumes and density of products like the following are processed:

- Hydrocarbons
- LPGs
- Asphalt
- Alcohols

Volumes and density are corrected according to international standards, including API/ASTM tables 5A, 5B/6, 53A, 53B/54, 23/24, LPG according to tables GPA TP-25 Table 24E, GPA TP-27 Table 24E, GPA TP-27 Table 54E, GPA TP-27 Table 60E, M B & Redwood VCF, alcoholometric tables according to OIML R22 tables I, II, IIIA, IVA, VI, VII. This includes temperature corrections at 15 °C, 60 °F and alternative temperatures. Additionally, available pumpable volumes and water volume are calculated.

Up to 200000 strapping points in sum over all tanks are supported for vertical, spherical and bullet tanks.

More standards are added continuously. Please ask Endress+Hauser for an updated list.

Remote configuration of measuring equipment

Tankvision does not only acquire the current measured level or volume from the tanks. The configuration of device settings from the control room is also possible by using FieldCare, the operating software from Endress+Hauser, for the connected Endress+Hauser devices. Tankvision passes on the device setting information transparently, so that all device functions for the respective operating software are available from the control room. Some on-site operations can be avoided using this feature during commissioning or maintenance. (The availability of this feature may depend on the system configuration.)

Application areas

- Tank farms in refineries
- Ship loading terminals
- Marketing and distribution terminals
- Pipeline terminals
- Logistic terminals for tanks storing products like crude oils, refined white and black products, chemicals, LPGs, fuels, biofuels, alcohols

Function and system design

System design

Tank management visualization without proprietary software

Tankvision is the first tank management visualization system providing its functionality without the need to have proprietary software installed and maintained on a PC. The main functionality is realized by embedded web pages in the Tankvision components. Tankvision uses an industrial proven operating system and provides high availability. Tankvision is not based on a PC platform and runs independent of connected PCs. This eliminates the need to maintain a specialized PC with a Windows operating system and necessary updates and hot fixes. Tankvision web pages can be

accessed from a standard PC with a web browser and the Java Runtime Environment only. Multiple users with different roles can simultaneously log in to each Tankvision component. Additional users can be added as required. There are no multi-user licence fees.

Please check with Endress+Hauser for recommendations on PC, operating system and web browser.

Examples of operating pages

Tank group

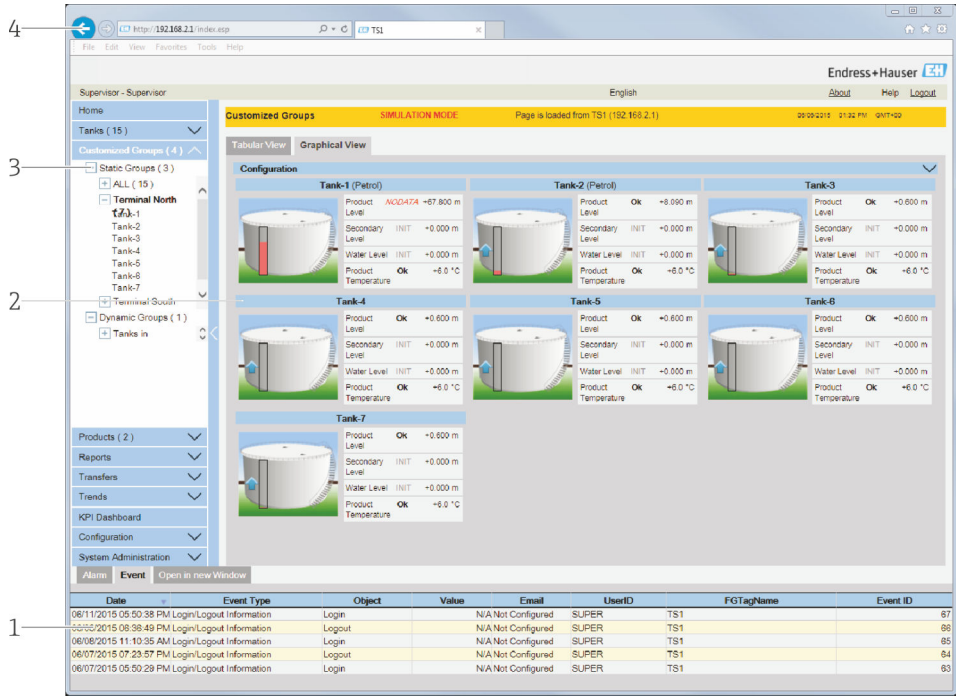

- 1 Alarms and events viewer
- 2 Main window
- 3 Navigation tree
- 4 Internet Explorer menu and symbol bar

Single tank

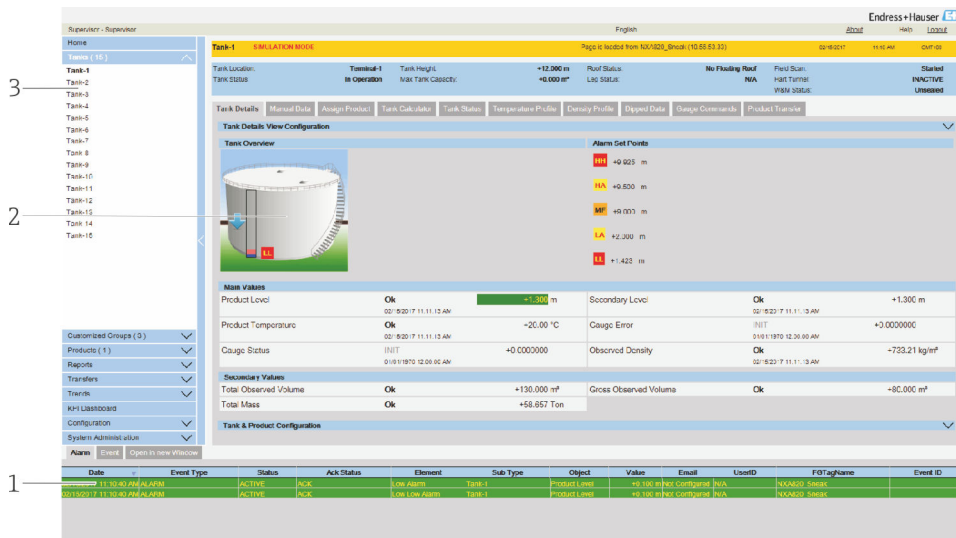

- 1 Alarms and events viewer
- 2 Main window
- 3 Navigation tree

Distributed architecture and scalability

Tankvision is based on a distributed architecture on a Local Area Network (LAN). Coordinated components perform all inventory management tasks. The modular design makes it easy to enlarge the system whenever required and to add further tank areas. Thus, Tankvision is fully scalable and is ideally suited for applications of any size - from small tank farms to large refineries.

Common hardware platform

Tankvision is based on a distributed architecture on a Local Area Network (LAN). Coordinated components perform all inventory management tasks. The modular design makes it easy to enlarge the system whenever required and to add further tank areas. Thus, Tankvision is fully scalable and is ideally suited for applications of any size - from small tank farms to large refineries.

The Tankvision components have dedicated tasks in a system, but have a common architecture, based on a 32 Bit processor. The embedded tank management software uses a multi-threaded real time operating system (RTOS), specifically designed for industrial applications. The hardware is designed without wear-out components like hard discs or fans. This guarantees high reliability.

System configuration

Configuration of the components

Each Tankvision component has its own data base and a web server. The components are connected and exchange data with time stamp and status information. Data is optionally encrypted and secured by a CRC checksum.

The Tankvision components are configured with static IP addresses, which are reserved on a DHCP network.

The configuration pages are embedded in the Tankvision components and allow configuration of Tankvision via a connected web browser without configuration software. No Internet access is necessary, as all pages are loaded from the Tankvision system itself.

Configuration of the connected tank gauges/sensors

Tankvision supports connection of the Endress+Hauser configuration tool, FieldCare, via LAN. This enables configuration of the tank gauges if they support remote configuration (e.g. Proservo, Tank Side Monitor and the level radars Micropilot S and Micropilot).

The tank gauges must be connected to the Tank Scanner NXA820 in one of the following ways:

- via a field protocol
- via HART to the Tank Side Monitor NRF590 (version 02.04) which in turn is connected via one of the following protocols to the Tank Scanner NXA820:
 - MODBUS
 - Sakura V1

Features

Representation of tank data

Tank data can be represented graphically or in tables. The corresponding HTML pages are predefined.

Definition and management of tank groups

The total contents of static or dynamic tank groups (e.g. of tanks containing the same product) can be displayed.

Definition and management of products

Product characteristics can be defined. The defined product can be attributed to a number of tanks.

Trend display

Real time and historical trends of the tank parameters can be displayed. The data is stored in the internal memory.

Archive

Tankvision stores measured and calculated data, log files and alarms on the internal flash memory.

Alarms

Limit alarms (high-high, high, low, low-low) can be defined for measured and calculated tank parameters. An alarm bar visualizes alarms in the browser window. Alarms can be reported by an optional Alarm Popup ¹⁾ window.

Products

A product database allows definition of 50 products per NXA or shared in the system.

1) available for Windows on the device to upload

- **Monitoring of transfers**
Product transfers from and to tanks can be monitored. Pre-alarms can be generated before completion of the transfer. A report is issued after the transfer.
- **Auditing**
An auditing table contains all events such as alarms or configuration changes.
- **Log-In roles**
Log-In roles with different access rights (supervisor, operator, guest) can be assigned to users and user groups.
- **Reports**
Reports are predefined as HTML pages. They can be sent to a printer connected to a computer at scheduled time intervals by an optional Printer Agent ¹⁾.
- **Volume calculation and correction**
Available calculation tables according to API, ASTM and IP can be integrated.
- **Graphical User Interface (GUI)**
Tankvision uses an intuitive and optimized user interface (e.g. automatic creation of dynamic tank groups).
- **Remote access**
Any PC with the specified requirements which is connected to the Intranet can be connected with Tankvision.
- **OPC Server**
Data can be transferred to other systems using the open OPC standard (OPC DA 3.0).

Security**IT security**

We only provide a warranty if the device is installed and used as described in the Operating Instructions. The device is equipped with security mechanisms to protect it against any inadvertent changes to the device settings.

IT security measures in line with operators' security standards and designed to provide additional protection for the device and device data transfer must be implemented by the operators themselves.

Endress+Hauser can be contacted to provide support in performing this task.

Typical system configuration

Wiring example for
NXA820/821/822

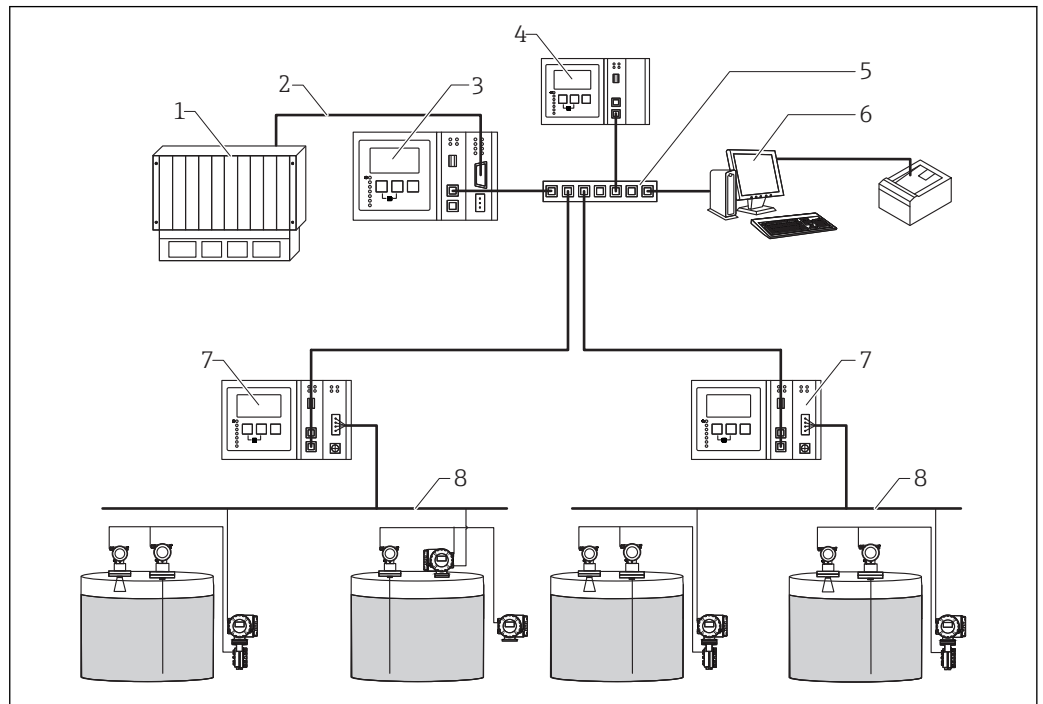

- 1 DCS /PLC (Distributed control system/Programmable logic controller)
- 2 Modbus
- 3 Host Link NXA822
- 4 Data Concentrator NXA821
- 5 Switch
- 6 Operator with Browser/SupplyCare Enterprise (Server)
- 7 Tank Scanner NXA820
- 8 Fieldbus protocol

**Wiring example for NXA820
"Interface only"**

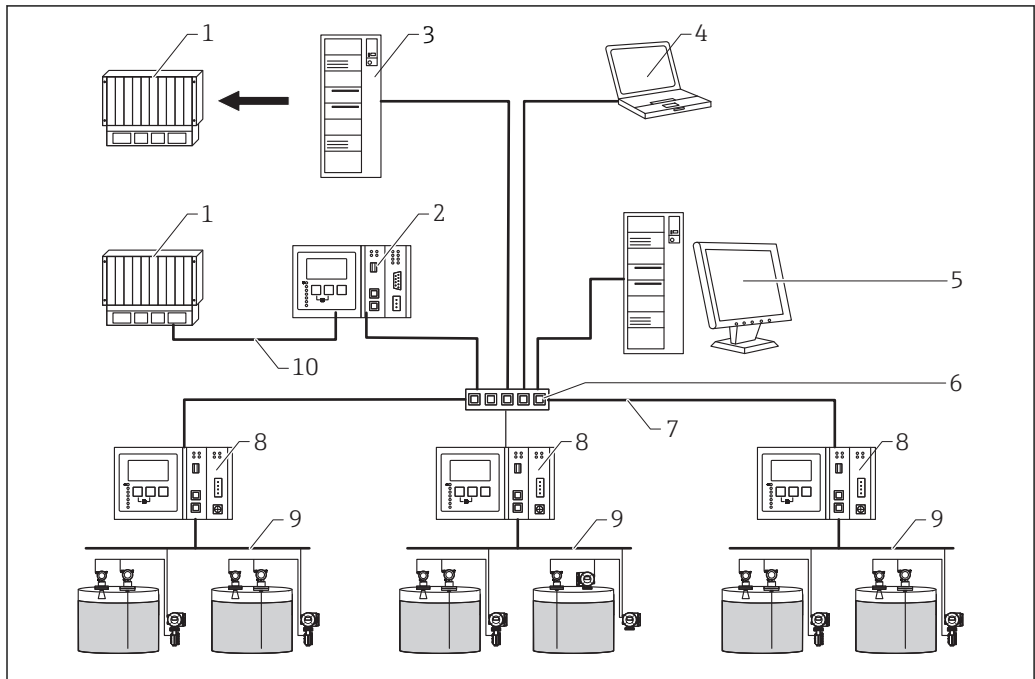

A0034277

- 1 DCS / PLC (Distributed control system / Programmable logic controller)
- 2 Host Link NXA822
- 3 OPC Server (Open Platform Communications)
- 4 FieldCare
- 5 Tankvision Professional NXA85 Workstation/SupplyCare Enterprise (Server)
- 6 Switch
- 7 Ethernet
- 8 Tank Scanner NXA820
- 9 Fieldbus protocol (Modbus, Sakura V1, Whessoe WM550)
- 10 Modbus RTU RS 232/485 or Modbus TCP

**Wiring examples for a
wireless connection of
NXA820**

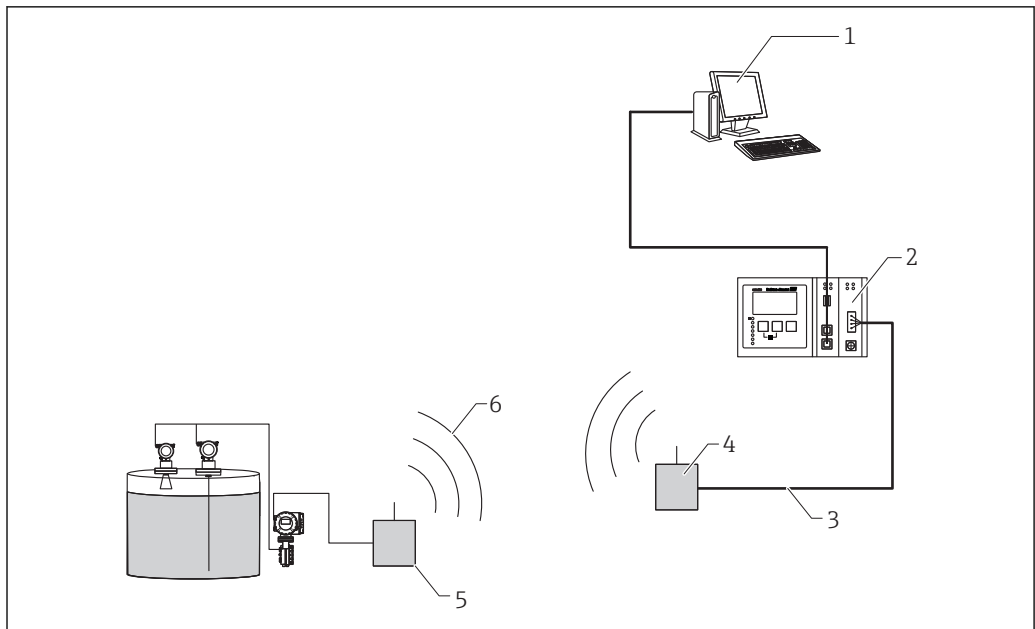

A0034274

- 1 Operator with Browser
- 2 Tank Scanner NXA820
- 3 MODBUS RTU communication RS-485 serial interface
- 4 Endress+Hauser WirelessHART Fieldgate SWG70
- 5 Endress+Hauser WirelessHART Adapter SWA70
- 6 WirelessHART communication interface (IEC 62591)

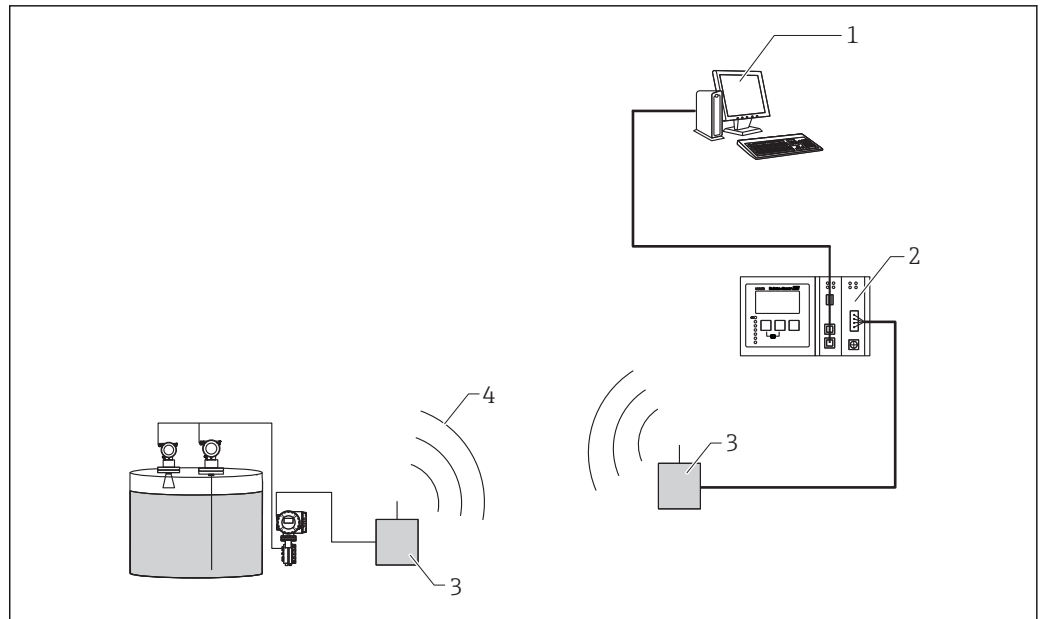



A0034275

- 1 Operator with Browser
- 2 Tank Scanner NXA820
- 3 Banner DX80DR2M-H-13680 or Banner DX80DR2M-H or Banner DX80DR9M-H
- 4 Wireless Modbus RTU RS 232/485 or Modbus TCP

The field instruments can also be connected to Tankvision Tank Scanner with appropriate wireless components.

For custody transfer applications the following components can be applied:

- Banner DX80DR2M-H-13680
- Banner DX80DR2M-H
- Banner DX80DR9M-H

 Certificates and approvals →  15

 For distributed systems special requirements apply. Please contact your local Endress+Hauser representative.

Function of the components

Tankvision Tank Scanner NXA820

- The Tank Scanner NXA820 connects multiple tank gauges from up to 15 tanks via one field-loop. The Tank Scanner NXA820 supports different field protocols (Modbus EIA485, Sakura V1, Whessoematic WM550).
- The measured values are transmitted by the network and visualized on HTML pages.
- The Tank Scanner NXA820 can be used stand-alone for small tank farms, but also be integrated into a large system for use in refineries.
- The Tank Scanner NXA820 is optionally equipped with a full set of tank inventory calculations. The calculations are based on various international standards such as API, ASTM, IP and many others. Measured values are used to calculate volume and mass.

System limitations

In order to ensure the best performance and system stability we recommend following limitations:

- Maximum 2000 parameters can be scanned from the field (all tanks counted together)
- Maximum 100 000 straps can be used for the strapping tables (all tanks counted together)
- Maximum 1 500 points for the TPD tables (all products counted together)
- Maximum 20 parameters can be archived per tank per 5 minutes
- Maximum 20 parameters can be archived per group per 5 minutes
- Maximum 10 groups (Static Group or Dynamic Group) can be defined

- Minimum 1 h between each archive export
- Maximum 10 scheduled reports via the Printer Agent per hour
- Maximum 3 Internet explorer browser pages open

 By reducing the one or the other limit other can be augmented. In order to prevent unstable system it is recommended to configure automated reports or archive exports sequentially, in order to distribute the load.

Tankvision OPC Server

- The OPC Server is a Windows program installed on a PC connecting to NXA820 and allows access to measured and calculated tank parameters.
- The OPC Server connects to OPC clients on the same PC or other PCs via LAN.
- The OPC Server supports browsing tanks and tank parameters on NXA820.
- The OPC Server is included in each NXA820 and can be downloaded.
- The OPC Server is based on OPC DA V3.0

Tankvision Alarm Pop-Up-Agent

- The Alarm Pop-Up-Agent is a Windows program installed on a PC, connecting to NXA820/NXA821.
- The program is running in the background and scans for alarms generated in NXA820/NXA821.
- If an alarm is present, a pop-up window opens displaying the alarm.
- The alarm can be acknowledged within this window.
- The window can only be closed if no alarm is active.

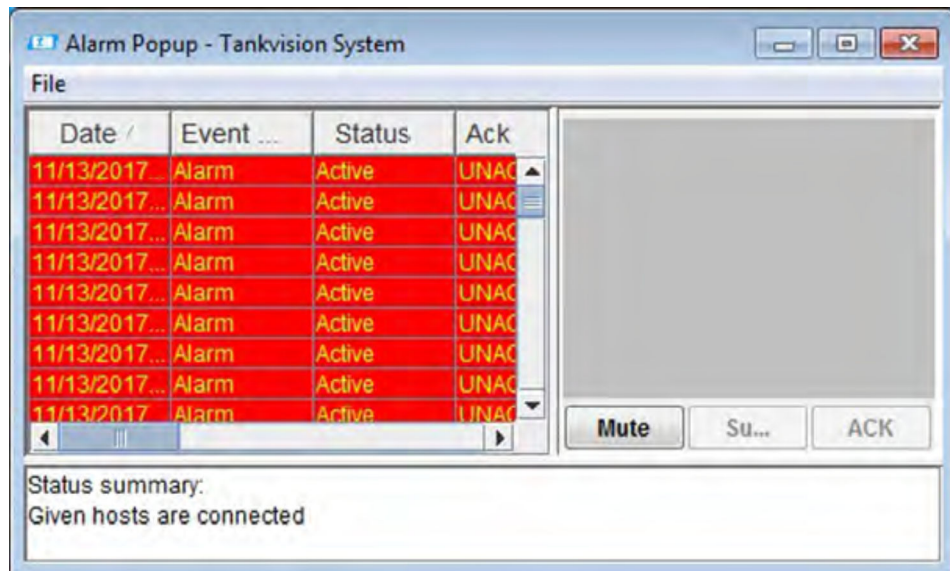

Tankvision Printer Agent

- The Printer Agent is a Windows program installed on a PC, connecting to NXA820/NXA821.
- The program is running in the background and enables printing reports on connected printers.
- Up to 3 printers (directly connected to the PC or network printers) can be assigned to the Printer Agent.
- If a printout can not be performed, a record is kept within the Printer Agent.

Tankvision Data Concentrator NXA821

- The NXA821 Tankvision Data Concentrator is the enhanced solution for large tank farms and refineries. The Data Concentrator is required if:
 - the plant contains more than one field loop (each of which has its own Tank Scanner NXA820)
 - tanks of more than one Tank Scanner NXA820 are to be grouped
- The Data Concentrator collects the data of several Tank Scanner units and enables reconciliation and totalization of the tank data of many or all tanks in structured groups.
- Alarms and events from all connected Tank Scanners NXA820 can be shown in a common screen. Any tank of the system can be assigned to any tank group, regardless of the Tank Scanner it is linked to. This ensures the highest possible flexibility for the plant or tank farm.
- An alarm pop-up shows alarms of all connected Tank Scanners NXA820 even if the web browser is closed.
- 90 tanks (more on request) can be allocated to each Data Concentrator NXA821. Each of these tanks must have been allocated to a Tank Scanner NXA820 beforehand.
- Tanks from up to 6 different Tank Scanners NXA820 (more on request) can be integrated in this way.

**Tankvision Host Link
NXA822**

- The Host Link NXA822 collects data from all Tank Scanners NXA820 on a network and transfers them to the host system.
- The MODBUS option supports serial EIA-232(RS) and EIA-485(RS) or MODBUS TCP/IP. The NXA822 is configured as a MODBUS slave. Supported functions are:
 - Coil Status (#01)
 - Holding Registers (#03)
 - Input Registers (#04)
 - Write Modbus Values (#06)
 - Write Multiple Value (#16)
- The MODBUS register map is described via XML files and can easily be adapted to individual MODBUS master requirements.
- Gauge commands for Servo Gauges
- 90 tanks (more on request) can be allocated to each Host Link NXA822. Each of these tanks must have been allocated to a Tank Scanner NXA820 beforehand.
- Tanks from up to 6 different Tank Scanners NXA820 (more on request) can be integrated in this way.

NXA820 "Interface only"

Operation

- Scans for the tank parameters and their status via Modbus, Sakura V1 or Whessoe WM550 protocol
- Forwards the tank parameters to Tankvision Professional and/or Tankvision OPC Server and/or Tankvision Host Link
- Forwards Gauge commands from the Inventory systems to the tank gauges
- Redundancy capable device, exchanging data between primary and secondary units

Configuration

The configuration is done via a comprehensive web page which can be accessed by standard web browser.

The setup consist of only 3 steps:

- Date and Time setting
- Network settings
- Protocol settings

A variety of scanning routines can be selected which cover most of the typical application needs. In addition those scanning routines can be easily tuned for more specialized application requirements.

Applying the Field Link in Weight & Measure approved systems needs an additional configuration step.

Remote configuration of measuring equipment

Tankvision Field Link does not only acquire the current measured values from the tanks. The configuration of device settings from the control room is also possible by using FieldCare, the Plant Asset Management tool from Endress+Hauser, for the connected Endress+Hauser devices. Tankvision Field Link passes on the device setting information transparently, so that all device functions for the respective operating software are available from the control room. Some on-site operations can be avoided using this feature during commissioning or maintenance. The availability of this feature may depend on the system configuration.

Inputs and outputs

Galvanic isolation

The following terminals are galvanically isolated from each other:

- Alarm relay output
- LAN interfaces
- Fieldbus interface

LAN connections

System LAN port

100 BASE-TX, Full/Half Duplex, 100 Mbit, Shielded RJ45 connector
Connects the NXA82x to the Local Area Network (LAN)

Service LAN port

100 BASE-TX, Full/Half Duplex, 100 Mbit, Shielded RJ45 connector

Connects the NXA82x to a local computer only for local commissioning and service operations. The computer does not become part of the local area network the NXA82x is connected to through the System LAN port.

This port has a fixed IP address and can also provide the connected computer automatically with a compatible IP address using a DHCP server built into the NXA82x. For this automatic IP function to work the computer must be set to obtain its IP address using a DHCP server.

 All LAN ports support Auto-MDIX, this system automatically detects the type of cable connected (either straight or crossed) and adjusts itself to match. With this feature you do not need to obtain special crossed cables to interconnect Tankvision components.

Fieldbus protocols (NXA820)

The Tank Scanner NXA820 is available with the following field protocols:

- MODBUS EIA-master, max. 15 gauges ²⁾
- Sakura V1, max. 10 gauges
- Whessoe 550, max. 15 gauges

Host connection (NXA822)

Modbus ³⁾

- EIA-232 (RS)
- EIA-485 (RS)
- TCP-IP on system LAN port

NXA Status Relay

- Potential free relay, SPDT
- Normally-closed when NXA is operating normally, open when NXA is powered off or fault status exists
- Switching power:
 - 25 V_{DC}, 100 W
 - 250 V_{AC}, 4 A, 1 000 VA



Power supply

Power supply NXA 82x

| Instrument version | Supply voltage | Power consumption | Current consumption | Fuse |
|-----------------------------------|--|-------------------|---------------------------------------|----------|
| AC voltage NXA82# - #1##### | 90 to 250 V _{AC} , (50 to 60 Hz) | max. 23 VA | max. 100 mA at 230 V _{AC} | 400 mA T |
| DC voltage NXA82# - #2##### | 10.5 to 32 V _{DC} | max. 14 W | max. 580 mA at 24 V _{DC} | 2 A T |



The versions are selectable via order code. →  15

Installation

 It is recommended to take the information contained in the Operating Instructions into consideration when designing the system architecture. →  16

2) Consider the "MODBUS over Serial Line Specification and Implementation Guide V1.02" (Dec. 2006)

3) Consider the "MODBUS over Serial Line Specification and Implementation Guide V1.02" (Dec. 2006) and the "MODBUS Messaging on TCP/IP Implementation Guide V1.0b" (Oct. 2006)

| | |
|---------------------------------------|---|
| Mounting location | <p>Cabinet or protective housing</p> <ul style="list-style-type: none">  When installed in wet locations, cabinet should be at least IP67.  When installed in wet locations, cabinet should only be opened when temperature is 5 to 40 °C (41 to 104 °F) and maximum relative humidity is 80 % for temperatures up to 31 °C (88 °F) decreasing linearly to 50 % relative humidity at 40 °C (104 °F). |
| Installation instructions | <p>Tankvision Tank Scanner NXA820, Data Concentrator NXA821 and Host Link NXA822 are designed to be installed in a cabinet, using a standard 35 mm (1.38 in) DIN (top-hat) rail conforming to EN50022 (BS5584) (IEC 60715).</p> |
| System requirements of user PC | <p>Check the latest information on hardware and software requirements. Please contact your local Endress+Hauser Sales Center.</p> |
| Network requirements | <ul style="list-style-type: none"> ▪ Network switches must always be used to interconnect Tankvision components. Network hubs must never be used. ▪ Only use screened cables (Category 5 or higher). <p> Network settings</p> <p>The address range 192.168.1.xxx cannot be configured for the NXA82x devices as it is reserved for the service (ethernet) port.</p> <p>NOTICE</p> <p>EMC requirements</p> <p>The legal EMC requirements are fulfilled only when</p> <ul style="list-style-type: none"> ▶ a screened LAN cable is used and ▶ the cable screen is properly terminated to screened RJ45 connectors. <p>NOTICE</p> <p>Harsh environments</p> <p>Most commercial and IT infrastructure networking switches (and components) are not designed to be used within harsh environments (e.g. temperatures below +5 °C (+41 °F), dusty or with high levels of EMC or electrical noise).</p> <ul style="list-style-type: none"> ▶ It is therefore recommended that only networking components specifically designed for industrial control purposes be used within the control room (or control cabinet) environment as part of the Tankvision system. |
| Shielding and Grounding | <p>When planning the shielding and grounding for a fieldbus system, there are three important points to consider:</p> <ul style="list-style-type: none"> ▪ Electromagnetic compatibility (EMC) ▪ Explosion protection ▪ Safety of the personnel <p>To ensure the optimum electromagnetic compatibility of systems, it is important that the system components and above all cables, which connect the components, are shielded and that no portion of the system is unshielded. Ideally, the cable shields are connected to the normally metal housings of the connected field devices. Since these are generally connected to the protective earth, the shield of the bus cable is grounded many times. Keep the stripped and twisted lengths of cable shield to the terminals as short as possible.</p> <p>This approach, which provides the best electromagnetic compatibility and personnel safety, can be used without restriction in systems with good potential equalization.</p> <p>In the case of systems without potential equalization, a power supply frequency (50/60 Hz) equalizing current can flow between two grounding points which, in unfavourable cases, e.g. when it exceeds the permissible shield current, may destroy the cable.</p> <p>To suppress the low frequency equalizing currents on systems without potential equalization, it is therefore recommended to connect the cable shield directly to the building ground (or protective earth) at one end only and to use capacitive coupling to connect all other grounding points.</p> <p>The NXA820 provides two grounding points for the shield, close to the fieldbus interface connector:</p> <ul style="list-style-type: none"> ▪ The “)” terminal, which should already be connected directly to ground ▪ The “S” terminal (13), which provides capacitive connection to the “)” terminal |

NOTICE**EMC requirements**

The legal EMC requirements are fulfilled only when

- ▶ the cable shield is grounded on both sides!

Environment

| | |
|--|--|
| Ambient temperature range | -40 to +60 °C (-40 to +140 °F) |
| Storage temperature | -40 to +85 °C (-40 to +185 °F) |
| Humidity | Max. 90 % at 25 °C (77 °F) (non-condensing) |
| Operating height | Device shall only be operated at maximum altitude of 2 000 m (6 600 ft) above MSL |
| Degree of protection | <ul style="list-style-type: none"> ▪ IP20 (as per IEC/EN 60529) ▪ IK06 (as per IEC/EN 62262) |
| Electromagnetic compatibility (EMC) | EMC according to the requirements of the EN 61326-series and the NAMUR-recommendation EMC (NE21). Details can be found in the Declaration of Conformity. |

Mechanical construction

Dimensions

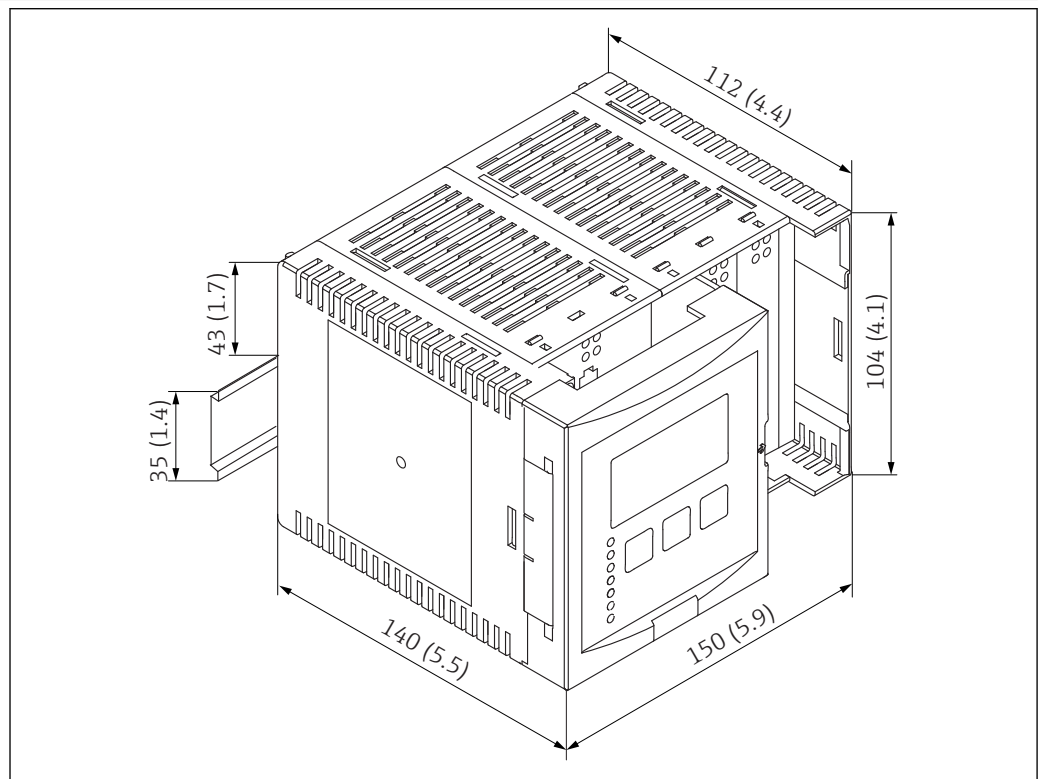

1 Dimensions in mm (inch)

Materials

Housing

Polycarbonate

Colour: light grey

Front cover

Polyamide PA6

Colour: grey

Ordering information

Detailed ordering information is available from the following sources:

- In the Product Configurator on the Endress+Hauser website: www.endress.com -> Click "Corporate" -> Select your country -> Click "Products" -> Select the product using the filters and search field -> Open product page -> The "Configure" button to the right of the product image opens the Product Configurator.
- From your Endress+Hauser Sales Center: www.addresses.endress.com

 **Product Configurator - the tool for individual product configuration**

- Up-to-the-minute configuration data
- Depending on the device: Direct input of measuring point-specific information such as measuring range or operating language
- Automatic verification of exclusion criteria
- Automatic creation of the order code and its breakdown in PDF or Excel output format
- Ability to order directly in the Endress+Hauser Online Shop

Operability

Operating concept

Tankvision is operated by a standard web browser (e.g. Microsoft Internet Explorer).

The Tankvision components contain predefined operating pages. If required, they can be adjusted by the user.

Languages

The operating pages are available in the following languages:

- Chinese
- English
- French
- German
- Japanese
- Polish
- Russian
- Spanish

 Check with Endress+Hauser for the latest information on available languages.

Certificates and approvals

Metrological approvals

OIML R85 (2008)

Compliance tested by NMI

NMI

Test certificate TC 7445

PTB

Innerstaatliche Bauartzulassung 4.454-08.10

 Due to legislative regulations, the connection to other systems (via Host Link NXA822 or Tankvision OPC Server) is not included in the approvals listed above.

RCM-Tick marking

The supplied product or measuring system meets the ACMA (Australian Communications and Media Authority) requirements for network integrity, interoperability, performance characteristics as well as health and safety regulations. Here, especially the regulatory arrangements for electromagnetic compatibility are met. The products are labelled with the RCM- Tick marking on the name plate.



A0029561

Supplementary documentation

Operating Instructions**BA00340G**

Installation Instructions for NXA820, NXA821 and NXA822.

Describes installation, electrical connection and first setup.

BA00424G

Operator Manual for NXA820, NXA821 and NXA822.

Describes user interface, user access rights and operation.

BA00426G

System Description for NXA820, NXA821 and NXA822.

Describes the connection to gauges and host systems and the calculations the Tank Scanner can perform.

BA01137G

Operating Instructions for Tankvision NXA820 OPC Server.

Describes installation, configuration and usage.

Description of Instrument Functions**BA00339G**

Description of Instrument Functions for Tank Scanner NXA820, Data Concentrator NXA821 and Host Link NXA822.

Contains a detailed description of all instrument functions.

Registered trademarks

Microsoft Corporation

The following trademarks are either registered trademarks or trademarks of Microsoft Corporation in the United States and/or other countries:

Microsoft®

Windows®

Schneider Electric

The following trademark is a registered trademark of Schneider Electric or its affiliates in the United States and/or other countries:

Modbus™

Oracle Corporation

The following trademarks are registered trademarks of Oracle and/or its affiliates:

Oracle®

Java®

**Legal notice concerning
trademarks**

All company/product names and/or all company logos may be trade names, trademarks and/or registered trademarks of Endress+Hauser, its affiliates or of their respective owners with which they are associated.





www.addresses.endress.com
