

Micro Motion[®] F-Series Coriolis Flow and Density Meters



Detailed specifications

F-Series flow and density accuracy options

	Liquid mass flow accuracy			Gas mass flow accuracy	Density accuracy (g/cm ³)		
	0.20%	0.15%	0.10%	0.5%	0.002	0.001	0.0005
F025	•	•	•	•	•	•	
F050	•	•	•	•	•	•	•
F100	•	•	•	•	•	•	•
F200	•	•	•	•	•	•	•
F300	•	•	•	•	•	•	•

Note

High temperature and high pressure models (base model codes A, B, and P, for example, F050A) are not capable of enhanced density accuracy of 0.0005 g/cm³ (0.5 kg/m³).

Flow tube information

Model	Number of tubes	Tube inside diameter inches	Tube inside diameter mm	Tube length inches	Tube length mm
F025	2	0.21	5.3	14.6	370
F050	2	0.35	8.8	18.8	478
F100	2	0.65	16	25.1	637
F200	2	1.1	27	23.5	598
F300	2	1.6	40	34.4	874

ASME B16.5 specification flange compatibility

Model	1/2"	3/4"	1"	1-1/2"	2"	3"	4"
F025	•	•	•				
F050	•	•	•				
F100			•	•	•		
F200				•	•	•	
F300						•	•

DIN specification flange compatibility

Model	DN15	DN25	DN40	DN50	DN80	DN100
F025	•					

Model	DN15	DN25	DN40	DN50	DN80	DN100
F050	•	•				
F100		•				
F200			•	•		
F300					•	•

EN1092-1 specification flange compatibility

Model	DN15	DN25	DN40	DN50	DN80	DN100
F025	•	•				
F050	•	•				
F100		•				
F200			•	•		
F300					•	•

JIS B 2220 specification flange compatibility

Note

Sensors with JIS process connections do not meet ASME B31.1 power piping code.

Model	15mm	25mm	40mm	50mm	80mm	100mm
F025	•					
F050	•					
F100		•				
F200			•	•		
F300					•	•







VCO/VCR specification flange compatibility and Tri-clamp compatible flanges

Model	VCO specification				Tri-clamp compatible					
	#4	#8	#12	#16	1/2"	3/4"	1"	1-1/2"	2"	3"
F025		•	•		•	•				
F050		•	•		•	•				
F100				•			•			
F200								•	•	
F300										•

Namur NE132 compliant flanges

Model	DN15	DN25	DN50	DN80	DN100
F025	•				
F050	•	•			
F100		•			
F200			•		
F300				•	•

Transmitter compatibility

Sensor model	Transmitter model or series						
	1500/2500	1700/2700	2200S	2400S	3000 series	FMT	5700
							
All F-Series models	•	•	•	•	•	F025, F050, F100	•

Process pressure ratings

Sensor maximum working pressure reflects the highest possible pressure rating for a given sensor. Process connection type and environmental and process fluid temperatures may reduce the maximum rating. Refer to the Technical Data Sheet for common sensor and fitting combinations.

All sensors comply with Council Directive 2014/68/EU on pressure equipment.

Note

F-Series sensors with JIS process connections do not comply with ASME B31.1 power piping code.

Sensor maximum working pressure for all models: 316L stainless steel (S/A), nickel alloy C22 (H/B), and high pressure (P)

Model ⁽¹⁾	Pressure
F025S/A, F050S/A, F100S/A, F200S, F300S	1,450 psig (100 barg)
F025H/B, F050H/B, F100H/B, F200H, F300H	2,160 psig (149 barg)
F025P	2,320 psig (160 barg)
F050P	5,800 psig (400 barg)
F100P	6,250 psig (431 barg)

(1) Higher pressure ratings may be available. Contact factory for further information.

Temperature and pressure de-ratings

Note

- The ratings in this section apply to the combined sensor and process connection to ensure that the meter does not exceed the limits of either component.
- The temperature and pressure de-ratings graphs do not represent all possible model and fitting combinations. For combinations not listed here, contact a sales representative or the factory.

F025S–F300S—ASME B16.5 F316/F316L

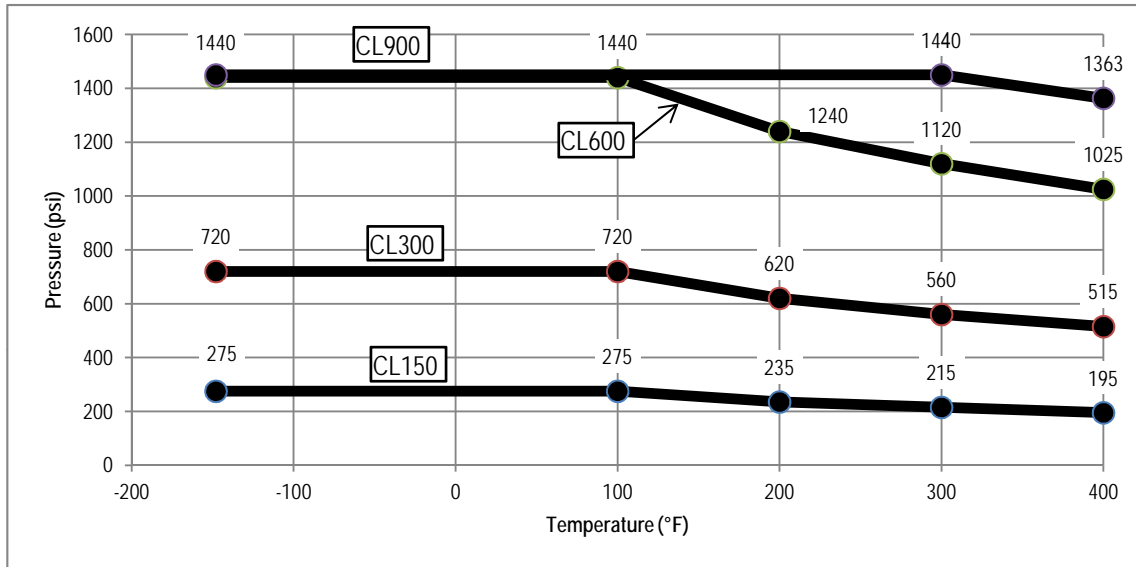

CL1500: F025S–F200S—ASME B16.5 F316/F316L

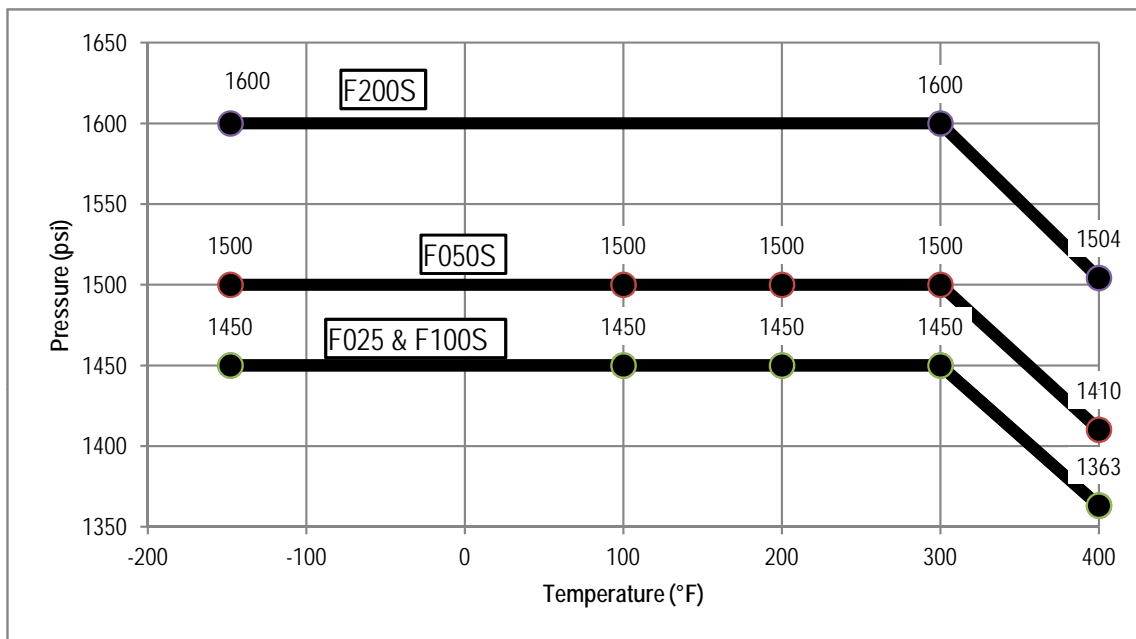

F025H–F300H—ASME B16.5 F304/F304L

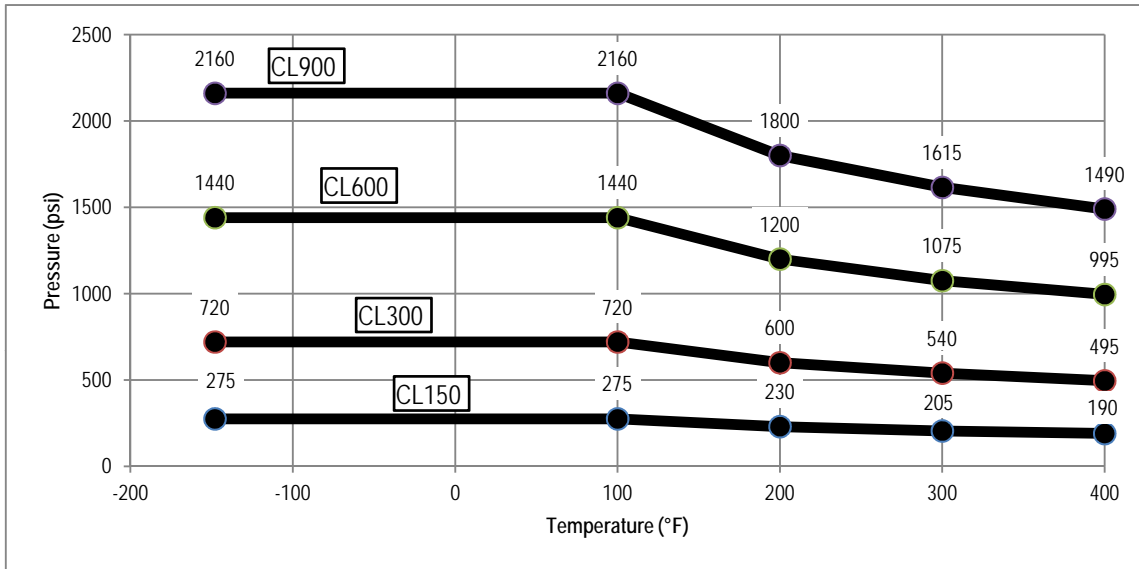

CL900/1500: F025H–F200H—ASME B16.5 F304/F304L

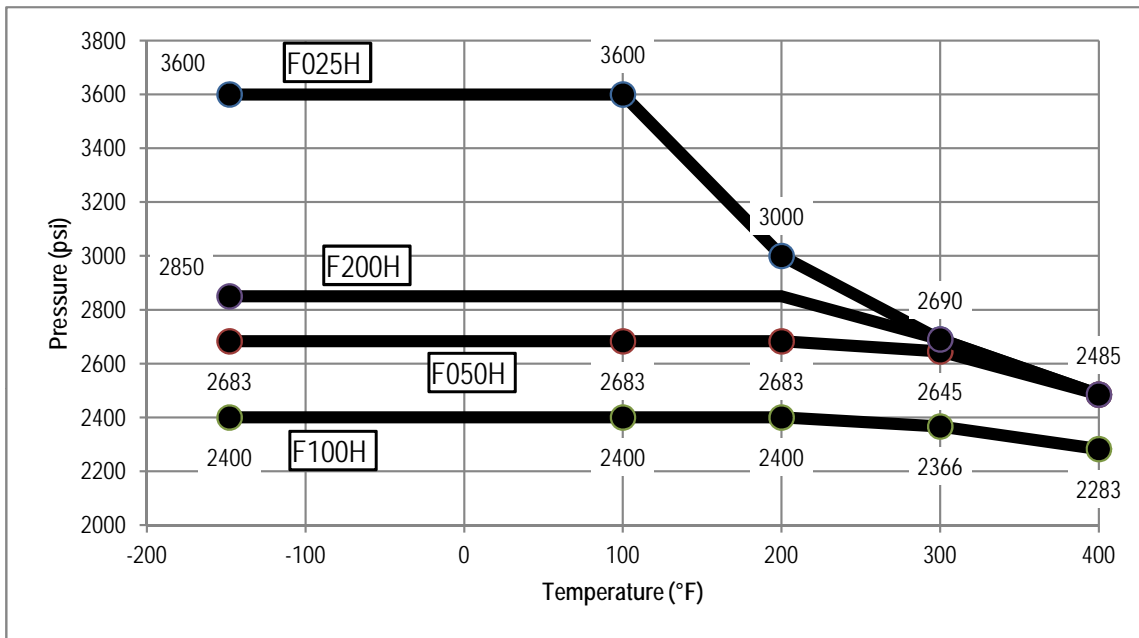

F025A-F100A-ASME B16.5 F316/F316L

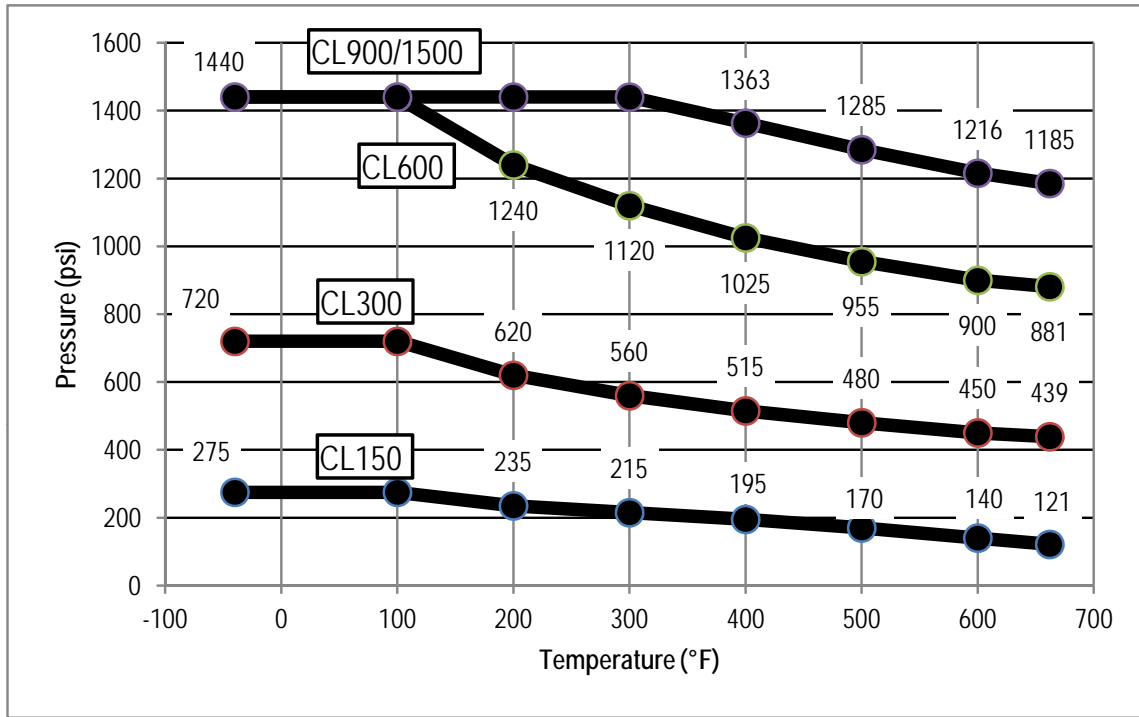

F025B-F100B-ASME B16.5 F304/F304L

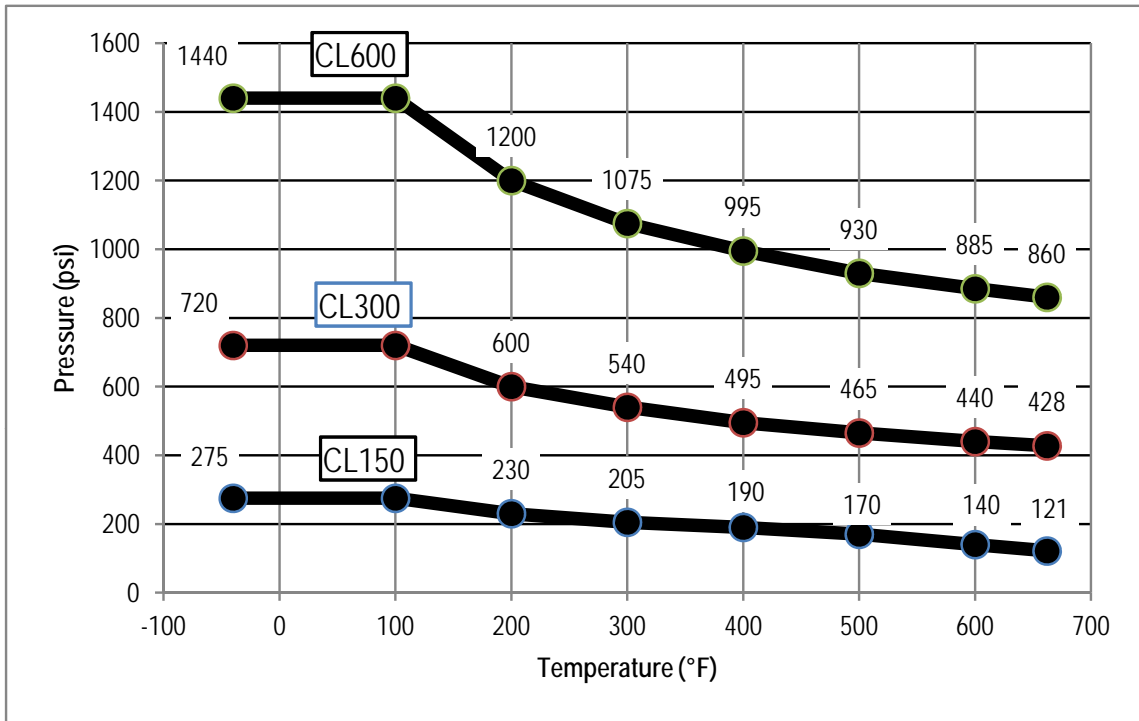

CL900/1500 F025B-F100B - ASME B16.5 F304/F304L

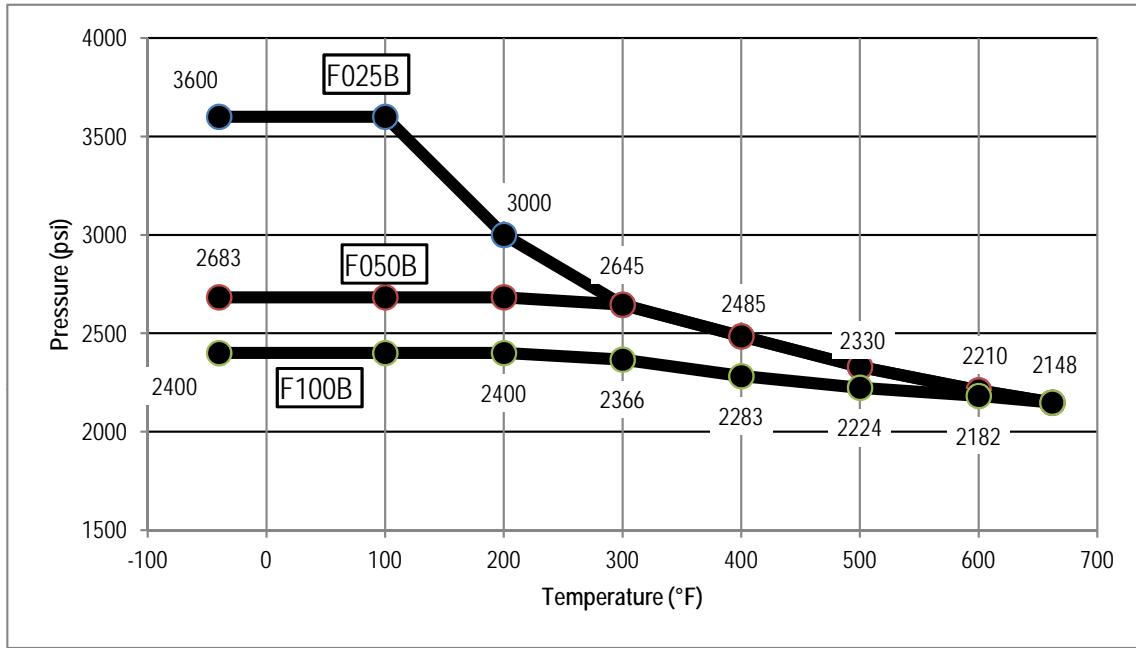

DIN 2635, 2637, 2638 F316/F316L

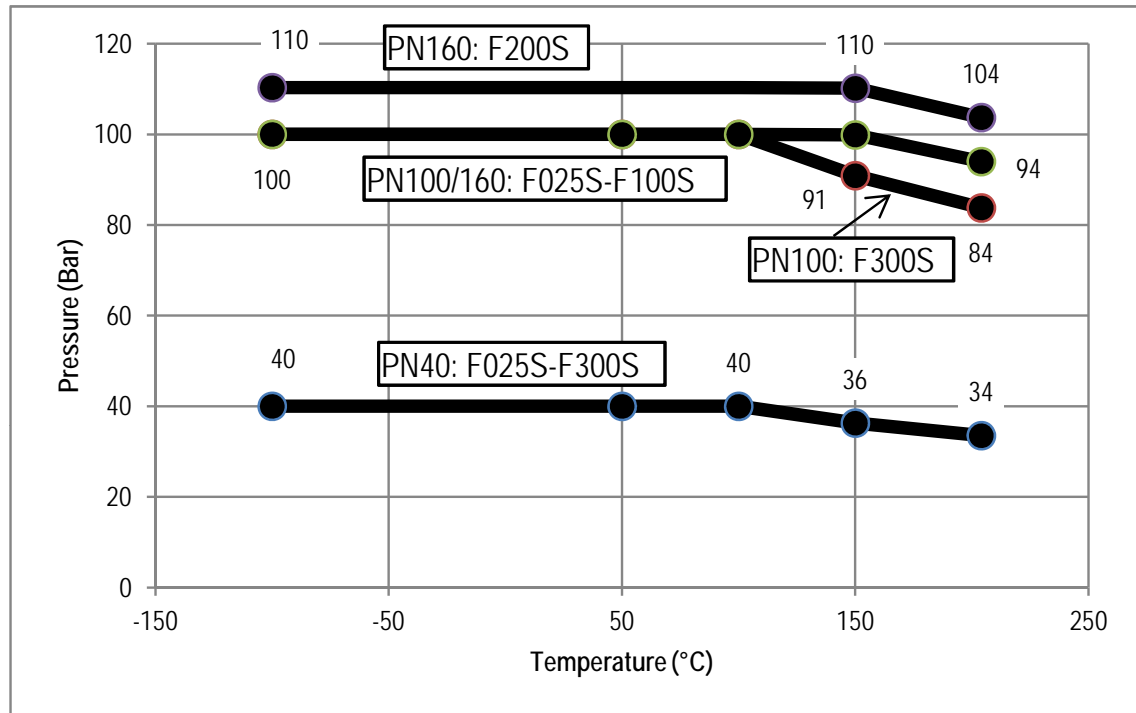

EN 1092-1 F316/F316L and F304/304L

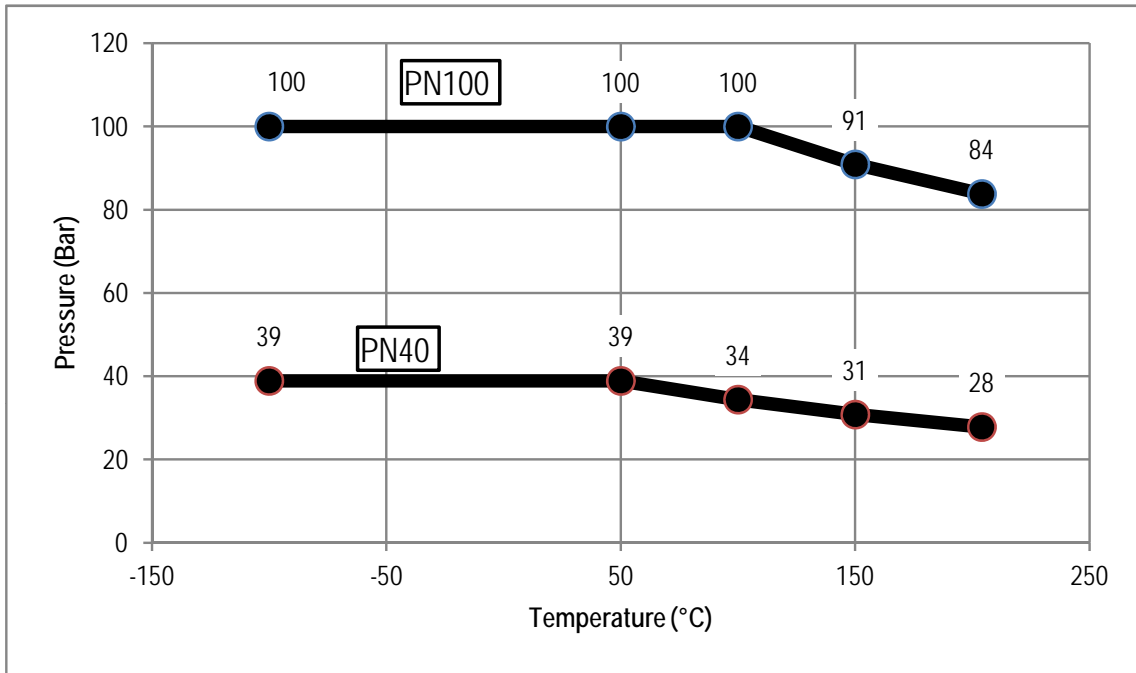

EN 1092-1 F316/F316L and F304/F304L

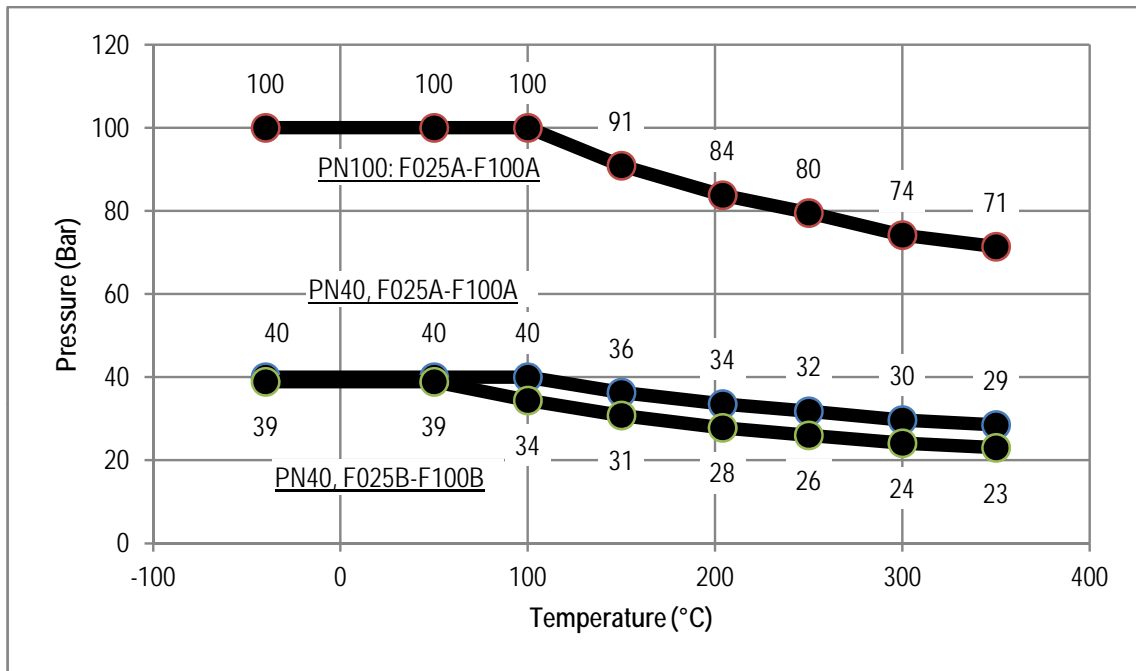

JIS B 2220 F316/316L and F304/304L

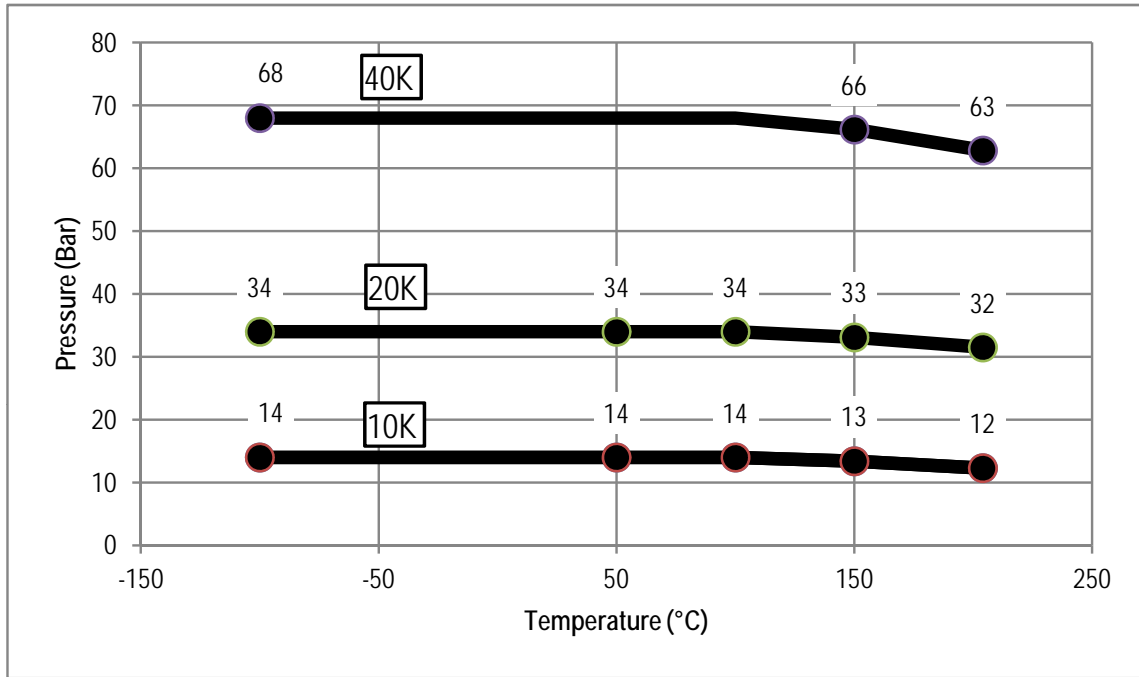

Note

Sensors with JIS process connections do not comply with ASME B31.1 power piping code.

JIS B 2220 F316/F316L and F304F/304L—High temperature

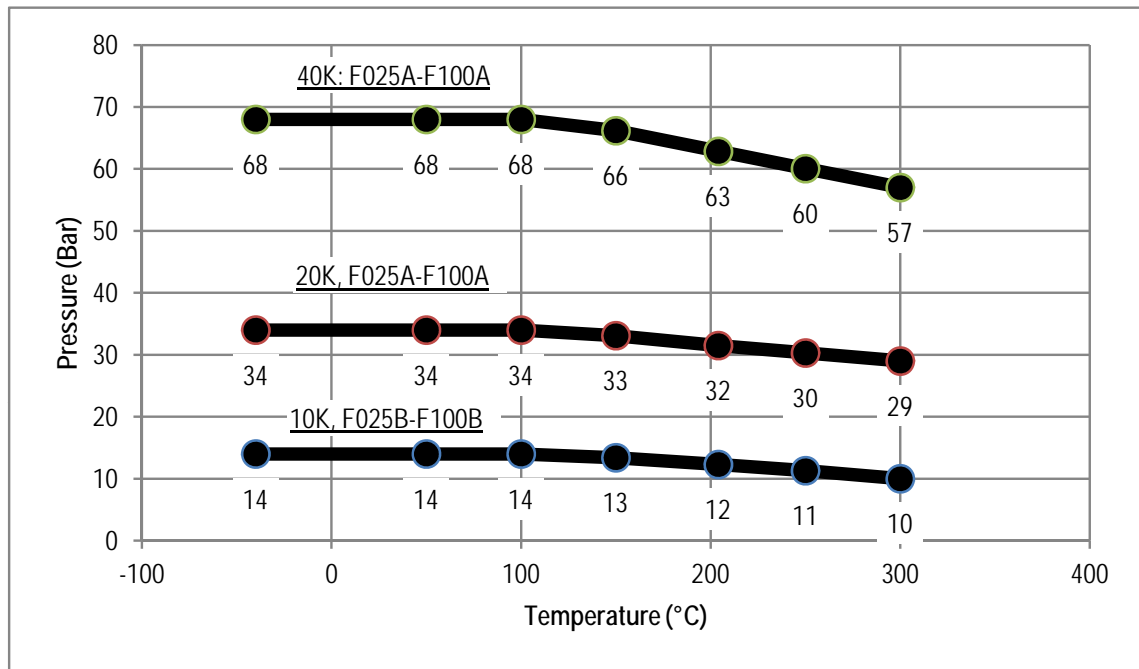

Tri-Clamp compatible 316L and N06022

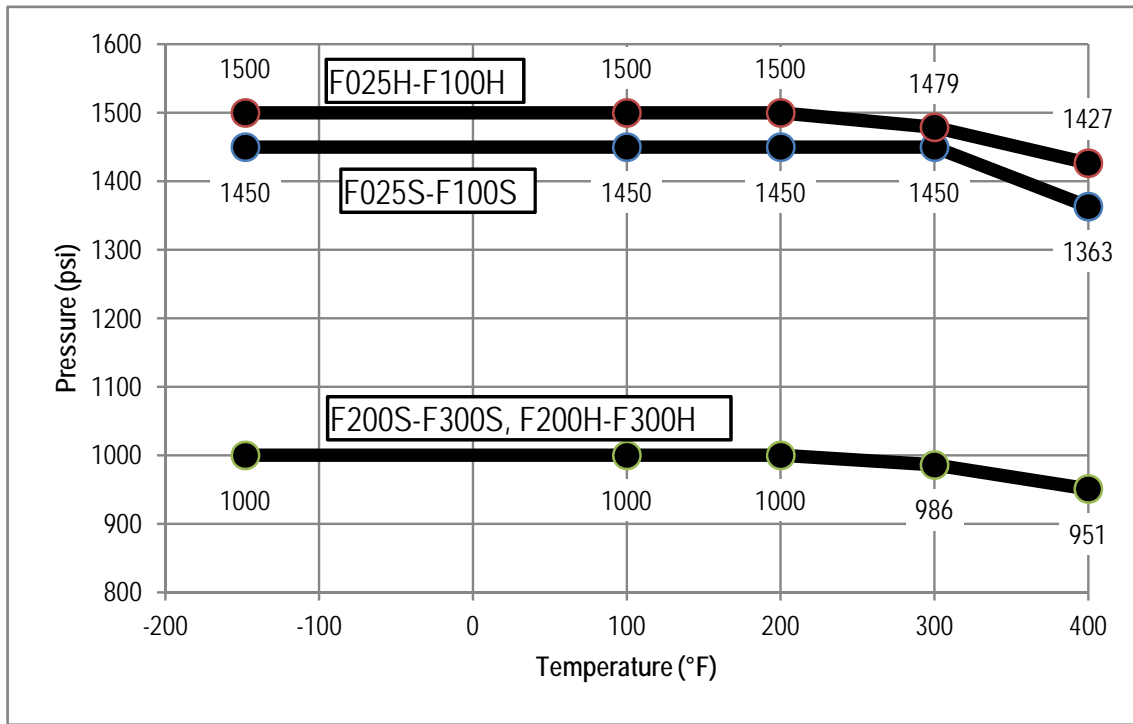

VCO/VCR 316/316L and 3-inch grooved coupling 316L

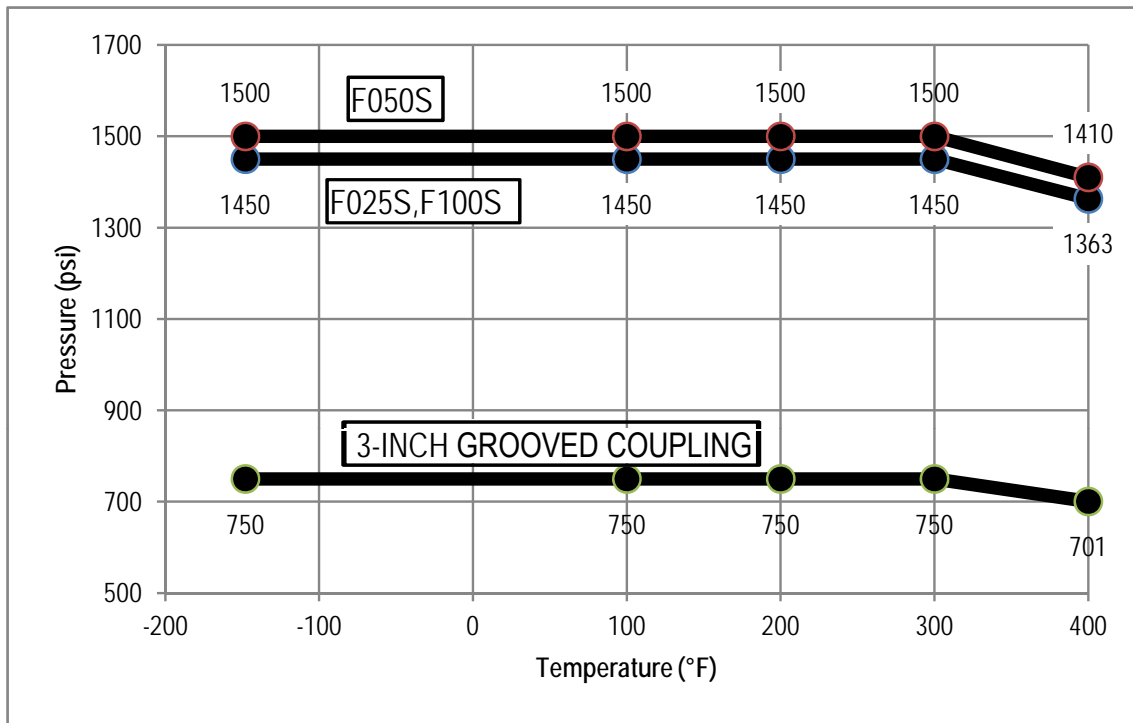

VCO and VCR 316/316L—High pressure

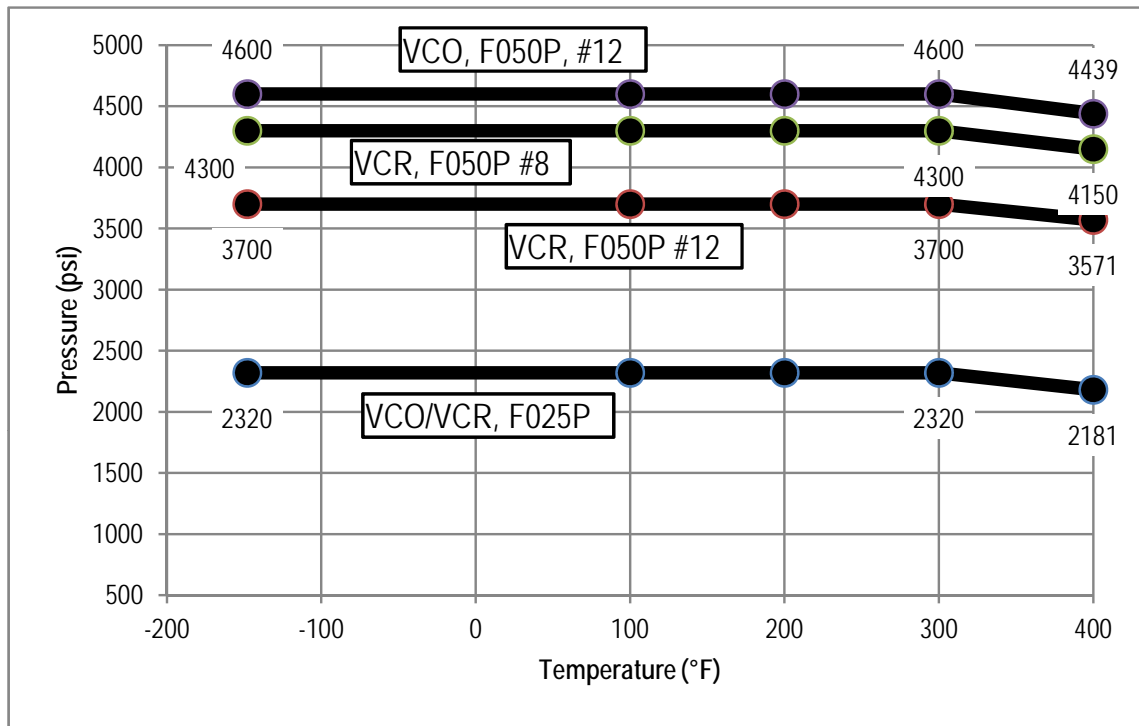





















Hazardous area classifications

Detailed classifications

Note

All information and approvals may change depending on sensor/transmitter configurations and operating conditions. Please reference appropriate certificates for exact approvals.

CSA and CSA C-US	
Models F025, F050, F100, and F200 with junction box	Ambient temperature: +140 °F max. (+60 °C max.)
	Class I, Div. 1, Groups C and D Class I, Div. 2, Groups A, B, C, and D Class II, Div. 1, Groups E, F, and G
All models with Model 2400S transmitter	Ambient temperature: –40 to +140 °F (–40 to +60 °C)
	Class I, Div. 2, Groups A, B, C, and D Class II, Div. 2, Groups F and G
Models F025, F050, F100, and F200 with core processor, Model 2200S, or Model 1700/2700 transmitter	Ambient temperature: –40 to +140 °F (–40 to +60 °C)
	Class I, Div. 1, Groups C and D Class I, Div. 2, Groups A, B, C, and D Class II, Div. 1, Groups E, F, and G
Models F300S and F300H with junction box	Ambient temperature: +140 °F max. (+60 °C max.)
	Class I, Div. 1, Groups C and D Class I, Div. 2, Groups A, B, C, and D Class II, Div. 1, Groups E, F, and G
Models F300S and F300H with core processor, Model 2200S, or Model 1700/2700 transmitter	Ambient temperature: –40 to +140 °F (–40 to +60 °C)
	Class I, Div. 1, Groups C and D Class I, Div. 2, Groups A, B, C, and D Class II, Div. 1, Groups E, F, and G
All high-temperature models with junction box	Ambient temperature: +140 °F max. (+60 °C max.)
	Class I, Div. 1, Groups C and D Class I, Div. 2, Groups A, B, C, and D Class II, Div. 1, Groups E, F, and G
IECEX	
Models F025, F050, F100, F200 with core processor or Model 1700/2700 transmitter	Ex ib IIC T1–T5
Models F025, F050, F100, F200 with Model 1700/2700 transmitter with THUM adapter	Ex ib IIC T1–T4
Models F025, F050, F100 and F200 with junction box	Ex ib IIC T1–T6
Model F300S and F300H with core processor or Model 1700/2700 transmitter	Ex ib IIB T1–T5
Model F300S and F300H with Model 1700/2700 transmitter with THUM adapter	Ex ib IIB T1–T4
Models F300S and F300H with junction box	Ex ib IIB T1–T6
Models F025, F050, F100, F200 with Model 2200S transmitter	Ex ib IIC T1–T4
Model F300S and F300H with Model 2200S transmitter	Ex ib IIB T1–T4

NEPSI	
All models with Model 2400S transmitter	Ex nA II T1–T5
Models F025, F050, F100, F200 with core processor or Model 1700/2700 transmitter	Ex ib IIC T1–T5
Models F025, F050, F100 and F200 with junction box	Ex ib IIC T1–T6
Model F300S and F300H with core processor or Model 1700/2700 transmitter	Ex ib IIB T1–T5
Models F300S and F300H with junction box	Ex ib IIB T1–T6
ATEX	
All models with Model 2400S transmitter	  II 3G Ex nA IIC T1–T5 Gc II 3D Ex tc IIIC T ⁽¹⁾ °C Dc IP66
Models F025, F050, F100, and F200 with integral core processor or Model 1700/2700 transmitter	Max. ambient for core processor is +60 °C
	Transmitter with THUM adapter and display   0575 II 3G Ex nA IIC T1–T5 Gc
	Transmitter with THUM adapter, without display   0575 II 2G Ex ib IIC T1–T4
	Transmitter with display   0575 II 2G Ex ib IIB+H2 T1–T5 II 2D Ex tD A21 IP65 T ⁽¹⁾ °C
	Core processor or transmitter without display   0575 II 2G Ex ib IIC T1–T5 II 2D Ex tD A21 IP65 T ⁽¹⁾ °C
Models F025, F050, F100, and F200 with junction box when connected to MVD transmitter	  0575 I 2G Ex ib IIC T1–T6 II 2D Ex tD A21 IP65 T ⁽¹⁾ °C
Models F025, F050, F100, and F200 with Model 2200S transmitter ⁽²⁾	  0575 II 2G Ex ib IIC T1–T4 II 2D Ex ibD 21 T ⁽¹⁾ °C
Model F300 with integral core processor or Model 1700/2700 transmitter (max. ambient for core processor is +60 °C) ⁽²⁾	  0575 II 2G Ex ib IIB T1–T5 II 2D Ex tD A21 IP65 T ⁽¹⁾ °C
Model F300 with junction box connected to MVD transmitter	  0575 II 2G Ex ib IIB T1–T6 II 2D Ex tD A21 IP65 T ⁽¹⁾ °C
Model F300 with Model 2200S transmitter ⁽²⁾	  0575 II 2G Ex ib IIB T1–T4 II 2D Ex ibD 21 T ⁽¹⁾ °C

- (1) For ambient and process temperature limits, refer to the appropriate approval certificate.
- (2) For transmitter with THUM adapter, the ATEX approval is 0575 II 2G Ex ib IIB T1-T4.

Process connections

Note

The tables in this section do not represent all possible model and flange combinations. For combinations not listed here, contact a sales representative or the factory.

Dimensions with process connections

Dimension A is provided for each process fitting type, when available. It is the finished face-to-face dimension of the sensor with the process connection ± 0.125 in (± 3.18 mm).

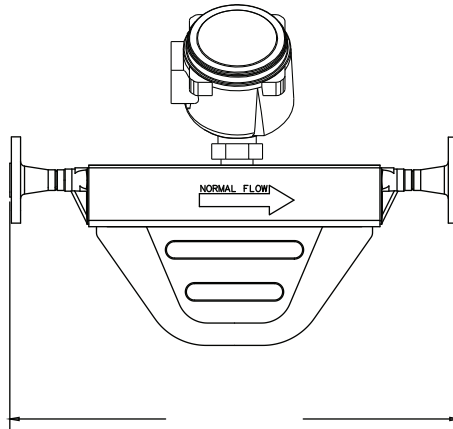

Weight with process connections

Product weights in this section include the weight of the sensor with the process connection and integral core processor, except where noted. Values are rounded to ± 1 lb (± 0.5 kg). Contact the factory for product shipping weight.

Standard fitting options

Model F025S

Code	Description						Dim A inch (mm)	Weight lb (kg)
113	1/2-inch	CL150	ASME B16.5	F316/F316L	Weld neck flange	Raised face	16.0 (406)	14 (6.5)
114	1/2-inch	CL300	ASME B16.5	F316/F316L	Weld neck flange	Raised face	16.4 (416)	15 (7)
115	1/2-inch	CL600	ASME B16.5	F316/F316L	Weld neck flange	Raised face	16.9 (428)	16 (7)
116	DN15	PN40	DIN 2635	F316/F316L	Weld neck flange	Form C face	15.3 (387)	15 (7)

Code	Description						Dim A inch (mm)	Weight lb (kg)
120	DN15	PN100/ 160	DIN 2638	F316/F316L	Weld neck flange	Form E face	15.8 (401)	17 (8)
121	1/2- inch		Tri-Clamp compatible	316L	Hygienic fitting		14.0 (355)	12 (5.5)
122	15mm	20K	JIS B 2220	F316/316L	Weld neck flange	Raised face	15.4 (392)	15 (7)
150	½-inch	CL900/ 1500	ASME B16.5	F316/316L	Weld neck flange	Raised face	17.5 (445)	18 (8)
170	DN15	PN100/ 160	EN 1092-1	F316/F316L	Weld neck flange	Type B2	15.4 (391)	17 (8)
172	DN25	PN40	EN 1092-1	F316/F316L	Weld neck flange	Type B1	15.3 (387)	17 (8)
176	DN15	PN40	EN 1092-1	F316/F316L	Weld neck flange	Type B1	15.2 (387)	15 (7)
178	DN15	PN100	EN 1092-1	F316/F316L	Weld neck flange	Type D	15.4 (391)	17 (7.5)
183	DN25	PN40	EN 1092-1	F316/F316L	Weld neck flange	Type D	13.9 (353)	17 (8)
221	15mm	40K	JIS B 2220	F316/316L	Weld neck flange	Raised face	16.5 (419)	19 (9)
222	DN15		DIN11851	316/316L	Hygienic coupling		15.3 (387)	12 (5.5)
310	DN15	PN40	EN 1092-1	F316/F316L	Weld neck flange	Type D	14.0 (355)	15 (7)
319	#8		VCO	316/316L	Swagelok compatible fitting	1/2-inch NPT female adapter	15.8 (401) ⁽¹⁾	12 (5.5)
A94	1/2- inch	CL150	ASME B16.5	F316/F316L	Weld neck flange	Raised face 63-125 RA face finish	16.0 (406)	14 (6)
A95	1/2- inch	CL300	ASME B16.5	F316/F316L	Weld neck flange	Raised face 63-125 RA face finish	16.4 (416)	16 (7)
A96	1/2- inch	CL600	ASME B16.5	F316/F316L	Weld neck flange	Raised face 63-125 RA face finish	16.9 (429)	14 (6)
A97	1/2- inch	CL900/ 1500	ASME B16.5	F316/F316L	Weld neck flange	Raised face 63-125 RA face finish	17.5 (445)	21 (10)
A99	3/4- inch	CL150	ASME B16.5	F316/F316L	Weld neck flange	Raised face	16.0 (406)	14 (6)

Code	Description						Dim A inch (mm)	Weight lb (kg)
B01	3/4-inch	CL300	ASME B16.5	F316/F316L	Weld neck flange	Raised face	16.5 (419)	18 (8)
B02	3/4-inch	CL600	ASME B16.5	F316/F316L	Weld neck flange	Raised face	17.3 (438)	18 (8)
B03	3/4-inch	CL900/ 1500	ASME B16.5	F316/F316L	Weld neck flange	Raised face	18.3 (464)	23 (10)
B04	1-inch	CL150	ASME B16.5	F316/F316L	Weld neck flange	Raised face	16.3 (413)	16 (7)
B05	1-inch	CL300	ASME B16.5	F316/F316L	Weld neck flange	Raised face	16.6 (422)	19 (9)
B06	1-inch	CL600	ASME B16.5	F316/F316L	Weld neck flange	Raised face	17.1 (435)	20 (9)
B07	1-inch	CL900/ 1500	ASME B16.5	F316/F316L	Weld neck flange	Raised face	18.0 (457)	28 (13)
B09	1/2-inch	CL300	ASME B16.5	F316/F316L	Weld neck flange	RTJ face	16.8 (427)	16 (7)
B10	1/2-inch	CL600	ASME B16.5	F316/F316L	Weld neck flange	RTJ face	16.8 (427)	16 (7)
B11	1/2-inch	CL900/ 1500	ASME B16.5	F316/F316L	Weld neck flange	RTJ face	17.5 (445)	21 (10)
B77	#8	[blank]	VCR	F316/F316L	Swagelok compatible fitting	Swagelok compatible fitting	17.2 (437)	13 (6)
B78	#12	[blank]	VCR	F316/F316L	Swagelok compatible fitting	3/4-inch 316 NPT female adapter	15.4 (391)	14 (6)
C73	DN15	PN40	EN 1092-1	F316/F316L	Weld neck flange	Type F	15.3 (387)	15 (7)

(1) Dimension specified in table does NOT include fitting length. For installation, modify Dim. A value to include fitting.

Model F025A

Code	Description						Dim A inch (mm)	Weight lb (kg) ⁽¹⁾
113	1/2-inch	CL150	ASME B16.5	F316/F316L	Weld neck flange	Raised face	16.0 (406)	12 (5.5)
114	1/2-inch	CL300	ASME B16.5	F316/F316L	Weld neck flange	Raised face	16.4 (416)	13 (6)
115	1/2-inch	CL600	ASME B16.5	F316/F316L	Weld neck flange	Raised face	16.9 (428)	13 (6)

Code	Description						Dim A inch (mm)	Weight lb (kg) ⁽¹⁾
122	15mm	20K	JIS B 2220	F316/F316L	Weld neck flange	Raised face	15.4 (392)	13 (6)
150	1/2- inch	CL900/ 1500	ASME B16.5	F316/F316L	Weld neck flange	Raised face	17.5 (444)	15 (7)
170	DN15	PN100/ 160	EN 1092-1	F316/F316L	Weld neck flange	Type B2	15.8 (401)	15 (7)
172	DN25	PN40	EN 1092-1	F316/F316L	Weld neck flange	Type B1	15.4 (391)	15 (7)
176	DN15	PN40	EN 1092-1	F316/F316L	Weld neck flange	Type B1	15.3 (387)	13 (6)
178	DN15	PN100	EN 1092-1	F316/F316L	Weld neck flange	Type D	15.8 (401)	15 (7)
183	DN25	PN40	EN 1092-1	F316/F316L	Weld neck flange	Type D	15.4 (391)	15 (7)
310	DN15	PN40	EN 1092-1	F316/F316L	Weld neck flange	Raised face	15.3 (387)	13 (6)

(1) Weight shown includes the sensor, process fitting, and painted aluminum junction box, no electronics or transmitter.

Model F025P

Code	Description						Dim A inch (mm)	Weight lb (kg)
120	DN15	PN100/ 160	DIN 2638	F316/F316L	Weld neck flange	Form E face	15.8 (401)	17 (8)
150	1/2- inch	CL900/ 1500	ASME B16.5	F316/F316L	Weld neck flange	Raised face	17.5 (444)	17 (8)
170	DN15	PN100/ 160	EN 1092-1	F316/F316L	Weld neck flange	Type B2	15.8 (401)	17 (8)
178	DN15	PN100	EN 1092-1	F316/F316L	Weld neck flange	Type D	15.8 (401)	17 (7.5)
180	DN25	PN100	EN 1092-1	F316/F316L	Weld neck flange	Type B2	16.8 (427)	24 (10.5)
319	#8		VCO	316/316L	Swagelok compatible fitting	1/2-inch NPT female adapter	14.0 (355) ⁽¹⁾	12 (5.5)

(1) Dimension specified in table does NOT include fitting length. For installation, modify Dim. A value to include fitting.

Model F025B

Code	Description						Dim A inch (mm)	Weight (¹) lb (kg)
517	1/2- inch	CL600	ASME B16.5	F304/F304L	Lap joint flange	N06022 stub	16.4 (417)	13 (6)
520	1/2- inch	CL150	ASME B16.5	F304/F304L	Lap joint flange	N06022 stub	16.1 (408)	17 (8)
521	1/2- inch	CL300	ASME B16.5	F304/F304L	Lap joint flange	N06022 stub	16.4 (417)	18 (8)
522	15mm	10K	JIS B 2220	F304/F304L	Lap joint flange	N06022 stub	15.5 (394)	13 (6)
524	DN15	PN40	EN 1092-1	F304/F304L	Lap joint flange	Type B1, N06022 stub	15.3 (388)	13 (6)

(1) Weight shown includes the sensor, process fitting, and painted aluminum junction box, no electronics or transmitter.

Models F025H

Code	Description						Dim A inch (mm)	Weight lb (kg)
517	1/2- inch	CL600	ASME B16.5	F304/F304L	Lap joint flange	N06022 stub	16.4 (417)	15 (7)
520	1/2- inch	CL150	ASME B16.5	F304/F304L	Lap joint flange	N06022 stub	16.1 (408)	19 (9)
521	1/2- inch	CL300	ASME B16.5	F304/F304L	Lap joint flange	N06022 stub	16.4 (417)	20 (9)
522	15mm	10K	JIS B 2220	F304/F304L	Lap joint flange	N06022 stub	15.5 (394)	15 (7)
524	DN15	PN40	EN 1092-1	F304/F304L	Lap joint flange	Type B1, N06022 stub	15.3 (388)	15 (7)

Model F050S

Code	Description						Dim A inch (mm)	Weight lb (kg)
113	1/2- inch	CL150	ASME B16.5	F316/F316L	Weld neck flange	Raised face	18.1 (460)	15 (7)
114	1/2- inch	CL300	ASME B16.5	F316/F316L	Weld neck flange	Raised face	18.5 (469)	16 (7.5)
115	1/2- inch	CL600	ASME B16.5	F316/F316L	Weld neck flange	Raised face	19.0 (482)	17 (7.5)
116	DN15	PN40	DIN 2635	F316/F316L	Weld neck flange	Form C face	17.4 (441)	16 (7.5)

Code	Description						Dim A inch (mm)	Weight lb (kg)
120	DN15	PN100/ 160	DIN 2638	F316/F316L	Weld neck flange	Form E face	17.9 (455)	18 (8.5)
122	15mm	20K	JIS B 2220	F316/316L	Weld neck flange	Raised face	17.6 (446)	18 (8)
131	DN25	PN40	DIN 2635	F316/F316L	Weld neck flange	Form C face	17.5 (444)	18 (8.5)
150	½-inch	CL900/1 500	ASME B16.5	F316/F316L	Weld neck flange	Type F	19.7 (498)	18 (8.5)
170	DN15	PN100/ 160	EN 1092-1	F316/F316L	Weld neck flange	Type B2	17.9 (455)	18 (8.5)
172	DN25	PN40	EN 1092-1	F316/F316L	Weld neck flange	Type B1	17.5 (445)	18 (8.5)
176	DN15	PN40	EN 1092-1	F316/F316L	Weld neck flange	Type B1	17.4 (441)	16 (7.5)
178	DN15	PN100	EN 1092-1	F316/F316L	Weld neck flange	Type D	17.9 (455)	18 (8)
183	DN25	PN40	EN 1092-1	F316/F316L	Weld neck flange	Type D	17.5 (445)	18 (8.5)
221	15mm	40K	JIS B 2220	F316/316L	Weld neck flange	Raised face	18.6 (473)	19 (9)
222	DN15		DIN11851	316/316L	Hygienic coupling		16.0 (407)	13 (6)
239	#12		VCO	316/316L	Swagelok compatible fitting	3/4-inch NPT female adapter	16.4 (415)	14 (6)
310	DN15	PN40	EN 1092-1	F316/F316L	Weld neck flange	Type D	17.4 (441)	16 (7.5)
322	3/4- inch		Tri-Clamp compatible	316L	Hygienic fitting		15.9 (403)	13 (6)
A94	1/2- inch	CL150	ASME B16.5	F316/F316L	Weld neck flange	Raised face 63-125 RA face finish	18.1 (460)	16 (7)
A95	1/2- inch	CL300	ASME B16.5	F316/F316L	Weld neck flange	Raised face 63-125 RA face finish	18.5 (470)	17 (8)
A96	1/2- inch	CL600	ASME B16.5	F316/F316L	Weld neck flange	Raised face 63-125 RA face finish	19.0 (483)	17 (8)
A97	1/2- inch	CL900/1 500	ASME B16.5	F316/F316L	Weld neck flange	Raised face 63-125 RA face finish	19.6 (498)	22 (10)

Code	Description						Dim A inch (mm)	Weight lb (kg)
A99	3/4-inch	CL150	ASME B16.5	F316/F316L	Weld neck flange	Raised face	18.3 (464)	16 (7)
B01	3/4-inch	CL300	ASME B16.5	F316/F316L	Weld neck flange	Raised face	18.6 (473)	19 (9)
B02	3/4-inch	CL600	ASME B16.5	F316/F316L	Weld neck flange	Raised face	19.4 (492)	19 (9)
B03	3/4-inch	CL900/1500	ASME B16.5	F316/F316L	Weld neck flange	Raised face	20.4 (517)	25 (11)
B04	1-inch	CL150	ASME B16.5	F316/F316L	Weld neck flange	Raised face	18.4 (467)	17 (8)
B05	1-inch	CL300	ASME B16.5	F316/F316L	Weld neck flange	Raised face	18.8 (476)	20 (9)
B06	1-inch	CL600	ASME B16.5	F316/F316L	Weld neck flange	Raised face	19.3 (489)	21 (10)
B07	1-inch	CL900/1500	ASME B16.5	F316/F316L	Weld neck flange	Raised face	20.1 (511)	29 (13)
B09	1/2-inch	CL300	ASME B16.5	F316/F316L	Weld neck flange	RTJ face	18.9 (481)	17(8)
B10	1/2-inch	CL600	ASME B16.5	F316/F316L	Weld neck flange	RTJ face	18.9 (481)	17(8)
B11	1/2-inch	CL900/1500	ASME B16.5	F316/F316L	Weld neck flange	RTJ face	19.6 (498)	22(10)
B77	#8	[blank]	VCR	F316/F316L	Swagelok compatible fitting	3/4-inch 316 female adapter	19.3 (489)	14(6)
B78	#12	[blank]	VCR	F316/F316L	Swagelok compatible fitting	3/4-inch 316 female adapter	17.5(445)	15(7)
C73	DN15	PN40	EN 1092-1	F316/F316L	Weld neck flange	Type F	17.4 (441)	17(8)

F050A

Code	Description						Dim A inch (mm)	Weight (¹) lb (kg)
113	1/2-inch	CL150	ASME B16.5	F316/F316L	Weld neck flange	Raised face	18.1 (460)	13 (6)
114	1/2-inch	CL300	ASME B16.5	F316/F316L	Weld neck flange	Raised face	18.5 (469)	14 (6.5)
115	1/2-inch	CL600	ASME B16.5	F316/F316L	Weld neck flange	Raised face	19.0 (482)	15 (6.5)

Code	Description						Dim A inch (mm)	Weight (¹) lb (kg)
122	15mm	20K	JIS B 2220	F316/F316L	Weld neck flange	Raised face	17.6 (446)	14 (6.5)
150	1/2- inch	CL900/ 1500	ASME B16.5	F316/F316L	Weld neck flange	Raised face	19.6 (498)	16 (7.5)
170	DN15	PN100/ 160	EN 1092-1	F316/F316L	Weld neck flange	Type B2	17.9 (455)	16 (7.5)
172	DN25	PN40	EN 1092-1	F316/F316L	Weld neck flange	Type B1	17.5 (445)	16 (7.5)
176	DN15	PN40	EN 1092-1	F316/F316L	Weld neck flange	Type B1	17.4 (441)	14 (6.5)
178	DN15	PN100	EN 1092-1	F316/F316L	Weld neck flange	Type D	17.9 (455)	16 (7)
183	DN25	PN40	EN 1092-1	F316/F316L	Weld neck flange	Type D	17.5 (445)	16 (7.5)
221	15mm	40K	JIS B 2220	F316/316L	Weld neck flange	Raised face	18.6 (473)	22 (10)
310	DN15	PN40	EN 1092-1	F316/F316L	Weld neck flange	Type D	17.4 (441)	14 (6.5)

(1) Weight shown includes the sensor, process fitting, and painted aluminum junction box, no electronics or transmitter.

Model F050P

Code	Description						Dim A inch (mm)	Weight lb (kg)
113	1/2- inch	CL150	ASME B16.5	F316/F316L	Weld neck flange	Raised face	18.1 (460)	15 (7)
114	1/2- inch	CL300	ASME B16.5	F316/F316L	Weld neck flange	Raised face	18.5 (469)	16 (7.5)
115	1/2- inch	CL600	ASME B16.5	F316/F316L	Weld neck flange	Raised face	19.0 (482)	17 (7.5)
116	DN15	PN40	DIN 2635	F316/F316L	Weld neck flange	Form C face	17.4 (441)	16 (7.5)
120	DN15	PN100/ 160	DIN 2638	F316/F316L	Weld neck flange	Form E face	17.9 (455)	18 (8.5)
122	15mm	20K	JIS B 2220	F316/F316L	Weld neck flange	Raised face	17.6 (446)	16 (7.5)
131	DN25	PN40	DIN 2635	F316/F316L	Weld neck flange	Form C face	17.5 (444)	18 (8.5)

Code	Description						Dim A inch (mm)	Weight lb (kg)
150	1/2- inch	CL900/ 1500	ASME B16.5	F316/F316L	Weld neck flange	Raised face	19.6 (498)	18 (8.5)
170	DN15	PN100/ 160	EN 1092-1	F316/F316L	Weld neck flange	Type B2	17.9 (455)	18 (8.5)
178	DN15	PN100	EN 1092-1	F316/F316L	Weld neck flange	Type D	17.9 (455)	18 (8)
180	DN25	PN100	EN 1092-1	F316/F316L	Weld neck flange	Type B2	18.9 (481)	25 (11)
222	DN15		DIN11851	316/316L	Hygienic coupling		16.0 (407)	13 (6)
239	#12		VCO	316/316L	Swagelok compatible fitting	3/4-inch NPT female adapter	16.4 (415) ⁽¹⁾	14 (6)
322	3/4- inch		Tri-Clamp compatible	316L	Hygienic fitting		15.9 (403)	13 (6)

(1) Dimension specified in table does NOT include fitting length. For installation, modify Dim. A value to include fitting.

Model F050B

Code	Description						Dim A inch (mm)	Weight (¹) lb (kg)
517	1/2- inch	CL600	ASME B16.5	F304/F304L	Lap joint flange	N06022 stub	18.6 (471)	14 (6.5)
520	1/2- inch	CL150	ASME B16.5	F304/F304L	Lap joint flange	N06022 stub	18.2 (462)	18 (8.5)
521	1/2- inch	CL300	ASME B16.5	F304/F304L	Lap joint flange	N06022 stub	18.6 (471)	19 (8.5)
522	15mm	10K	JIS B 2220	F304/F304L	Lap joint flange	N06022 stub	17.6 (447)	14 (6.5)
524	DN15	PN40	EN 1092-1	F304/F304L	Lap joint flange	Type B1, N06022 stub	17.4 (442)	14 (6.5)

(1) Weight shown includes the sensor, process fitting, and painted aluminum junction box, no electronics or transmitter.

Model F050H

Code	Description						Dim A inch (mm)	Weight lb (kg)
517	1/2- inch	CL600	ASME B16.5	F304/F304L	Lap joint flange	N06022 stub	18.6 (471)	17 (7.5)
520	1/2- inch	CL150	ASME B16.5	F304/F304L	Lap joint flange	N06022 stub	18.2 (462)	20 (9.5)

Code	Description						Dim A inch (mm)	Weight lb (kg)
521	1/2- inch	CL300	ASME B16.5	F304/F304L	Lap joint flange	N06022 stub	18.6 (471)	21 (9.5)
522	15mm	10K	JIS B 2220	F304/F304L	Lap joint flange	N06022 stub	17.6 (447)	16 (7.5)
524	DN15	PN40	EN 1092-1	F304/F304L	Lap joint flange	Type B1, N06022 stub	17.4 (442)	17 (7.5)

Model F100S

Code	Description						Dim A inch (mm)	Weight lb (kg)
128	1-inch	CL150	ASME B16.5	F316/F316L	Weld neck flange	Raised face	22.7 (576)	24 (11)
129	1-inch	CL300	ASME B16.5	F316/F316L	Weld neck flange	Raised face	23.2 (588)	27 (12)
130	1-inch	CL600	ASME B16.5	F316/F316L	Weld neck flange	Raised face	23.7 (601)	27 (12.5)
131	DN25	PN40	DIN 2635	F316/F316L	Weld neck flange	Form C face	21.4 (544)	25 (11.5)
137	DN25	PN100/160	DIN 2638	F316/F316L	Weld neck flange	Form E face	22.8 (580)	31 (14)
179	DN25	PN40	EN 1092-1	F316/F316L	Weld neck flange	Type B1	21.4 (544)	25 (11.5)
180	DN25	PN100	EN 1092-1	F316/F316L	Weld neck flange	Type B2	22.9 (580)	31 (14)
181	DN25	PN100	EN 1092-1	F316/F316L	Weld neck flange	Type D	22.9 (580)	31 (14)
209	2-inch	CL150	ASME B16.5	F316/F316L	Weld neck flange	Raised face	23.1 (585)	32 (14.5)
229	25mm	40K	JIS B 2220	F316/316L	Weld neck flange	Raised face	22.9 (582)	31 (14)
230	DN25		DIN11851	316/316L	Hygienic coupling		20.6 (522)	20 (9)
311	DN25	PN40	EN 1092-1	F316/F316L	Weld neck flange	Type D	21.4 (544)	25 (11.5)
928	1-inch	CL900/1500	ASME B16.5	F316/F316L	Weld neck flange	Raised face	24.6 (624)	36 (16)

Code	Description						Dim A inch (mm)	Weight lb (kg)
B14	1-inch	CL150	ASME B16.5	F316/F316L	Weld neck flange	Raised face 63-125 Ra face finish	22.7 (576)	24 (11)
B15	1-inch	CL300	ASME B16.5	F316/F316L	Weld neck flange	Raised face 63-125 Ra face finish	23.2 (589)	27 (12)
B16	1-inch	CL600	ASME B16.5	F316/F316L	Weld neck flange	Raised face 63-125 Ra face finish	23.7 (602)	28 (13)
B17	1 1/2- inch	CL150	ASME B16.5	F316/F316L	Weld neck flange	Raised face	22.9 (583)	27 (12)
B18	1 1/2- inch	CL300	ASME B16.5	F316/F316L	Weld neck flange	Raised face	23.4 (594)	32 (15)
B19	1 1/2- inch	CL600	ASME B16.5	F316/F316L	Weld neck flange	Raised face	24.3 (616)	35 (16)
B20	1 1/2- inch	CL900/1500	ASME B16.5	F316/F316L	Weld neck flange	Raised face	24.8 (630)	46 (21)
B21	1 1/2- inch	CL900/1500	ASME B16.5	F316/F316L	Weld neck flange	Raised face	23.6 (598)	34 (15)
B22	1 1/2- inch	CL900/1500	ASME B16.5	F316/F316L	Weld neck flange	Raised face	24.3 (616)	38 (17)
B23	1 1/2- inch	CL900/1500	ASME B16.5	F316/F316L	Weld neck flange	Raised face	26.8 (679)	65 (29)
B24	1 -inch	CL300	ASME B16.5	F316/F316L	Weld neck flange	RTJ face	23.7 (602)	27 (12)
B25	1 -inch	CL600	ASME B16.5	F316/F316L	Weld neck flange	RTJ face	23.7 (602)	28 (13)
B26	1 1/2- inch	CL900/1500	ASME B16.5	F316/F316L	Weld neck flange	RTJ face	23.5 (641)	46 (21)
B81	#16	[blank]	VCO	F316/F316L	Swagelok compatible fitting	1-inch 316 NPT female adapter	20.3 (514)	22 (10)
B82	#16	[blank]	VCR	F316/F316L	Swagelok compatible fitting	1-inch 316 NPT female adapter	23.5 (641)	23 (10)
C74	DN25	PN40	EN 1092-1	F316/F316L	Weld neck flange	Type F	21.4 (545)	25 (11)

Model F100A

Code	Description						Dim A inch (mm)	Weight (1) lb (kg)
128	1-inch	CL150	ASME B16.5	F316/F316L	Weld neck flange	Raised face	22.7 (576)	22 (10)
129	1-inch	CL300	ASME B16.5	F316/F316L	Weld neck flange	Raised face	23.2 (588)	32 (14.5)
130	1-inch	CL600	ASME B16.5	F316/F316L	Weld neck flange	Raised face	23.7 (601)	25 (11.5)
139	25mm	20K	JIS B 2220	F316/F316L	Weld neck flange	Raised face	21.7 (550)	23 (10.5)
179	DN25	PN40	EN 1092-1	F316/F316L	Weld neck flange	Type B1	21.4 (544)	23 (10.5)
209	2-inch	CL150	ASME B16.5	F316/F316L	Weld neck flange	Raised face	23.1 (585)	30 (13.5)
229	25mm	40K	JIS B 2220	F316/316L	Weld neck flange	Raised face	22.9 (582)	31 (14)
311	DN25	PN40	EN 1092-1	F316/F316L	Weld neck flange	Type D	21.4 (544)	23 (10.5)
928	1-inch	CL900	ASME B16.5	F316/F316L	Weld neck flange	Raised face	24.6 (623)	34 (15.5)

(1) Weight shown includes the sensor, process fitting, and painted aluminum junction box, no electronics or transmitter.

Model F100B

Code	Description						Dim A inch (mm)	Weight (1) lb (kg)
530	1-inch	CL150	ASME B16.5	F304/F304L	Lap joint flange	N06022 stub	22.7 (577)	24 (10.5)
531	1-inch	CL300	ASME B16.5	F304/F304L	Lap joint flange	N06022 stub	23.2 (590)	26 (12)
532	25mm	10K	JIS B 2220	F304/F304L	Lap joint flange	N06022 stub	21.8 (552)	25 (11)
534	DN25	PN40	EN 1092-1	F304/F304L	Lap joint flange	Type B1, N06022 stub	21.5 (546)	25 (11)
535	1-inch	CL600	ASME B16.5	F304/F304L	Lap joint flange	N06022 stub	23.2 (590)	26 (12)

(1) Weight shown includes the sensor, process fitting, and painted aluminum junction box, no electronics or transmitter.

Model F100H

Code	Description						Dim A inch (mm)	Weight lb (kg)
530	1-inch	CL150	ASME B16.5	F304/F304L	Lap joint flange	N06022 stub	22.7 (577)	26 (11.5)
531	1-inch	CL300	ASME B16.5	F304/F304L	Lap joint flange	N06022 stub	23.2 (590)	28 (13)
532	25mm	10K	JIS B 2220	F304/F304L	Lap joint flange	N06022 stub	21.8 (552)	27 (12)
534	DN25	PN40	EN 1092-1	F304/F304L	Lap joint flange	Type B1, N06022 stub	21.5 (546)	27 (12)
535	1-inch	CL600	ASME B16.5	F304/F304L	Lap joint flange	N06022 stub	23.2 (590)	28 (13)

Model F100P

Code	Description						Dim A inch (mm)	Weight lb (kg)
C55	1-inch	CL2500	ASME B16.5	Nickel alloy C22	Weld neck flange	RTJ	25.8 (655)	46 (21)
C56	1-1/2-inch	CL2500	ASME B16.5	Nickel alloy C22	Weld neck flange	RTJ	27.6 (701)	76 (34.5)
C57	1-inch	CL2500 (360 bar)	ASME B16.5	F316/F316L	Weld neck flange	RTJ	25.8 (655)	44 (20)
C58	1-1/2-inch	CL2500 (360 bar)	ASME B16.5	F316/F316L	Weld neck flange	RTJ	27.6 (701)	71 (32)
C64	1-inch	CL2500	ASME B16.5	F316/F316L	Weld neck flange	RTJ	25.8 (655)	44 (20)
C65	1-1/2-inch	CL2500	ASME B16.5	F316/F316L	Weld neck flange	RTJ	27.6 (701)	71 (32)

Model F200S

Code	Description						Dim A inch (mm)	Weight lb (kg)
312	DN40	PN40	EN 1092-1	F316/F316L	Weld neck flange	Type D	23.4 (595)	48 (21.5)
316	DN50	PN40	EN 1092-1	F316/F316L	Weld neck flange	Type D	23.7 (601)	51 (23)
341	1-1/2-inch	CL150	ASME B16.5	F316/F316L	Weld neck flange	Raised face	24.8 (629)	46 (21)

Code	Description						Dim A inch (mm)	Weight lb (kg)
342	1-1/2-inch	CL300	ASME B16.5	F316/F316L	Weld neck flange	Raised face	25.3 (642)	52 (23.5)
343	1-1/2-inch	CL600	ASME B16.5	F316/F316L	Weld neck flange	Raised face	25.8 (654)	55 (25)
351	1-1/2-inch		Tri-Clamp compatible	316L	Hygienic fitting		23.3 (591)	39 (17.5)
352	2-inch		Tri-Clamp compatible	316L	Hygienic fitting		22.9 (581)	39 (18)
353	DN40		DIN11851	316/316L	Hygienic coupling		23.2 (589)	46 (21)
363	DN40	PN100	EN 1092-1	F316/F316L	Weld neck flange	Type B2	24.8 (629)	56 (25.5)
365	DN50	PN100	EN 1092-1	F316/F316L	Weld neck flange	Type B2	25.3 (641)	64 (29)
366	DN40	PN100	EN 1092-1	F316/F316L	Weld neck flange	Type D	24.8 (629)	56 (25.5)
367	DN50	PN100	EN 1092-1	F316/F316L	Weld neck flange	Type D	25.3 (641)	64 (29)
368	DN40	PN40	EN 1092-1	F316/F316L	Weld neck flange	Type B1	23.4 (595)	48 (21.5)
369	DN50	PN40	EN 1092-1	F316/F316L	Weld neck flange	Type B1	23.7 (601)	51 (23)
378	DN50	PN100	DIN 2637	F316/F316L	Weld neck flange	Form E face	25.4 (646)	64 (29)
381	DN40	PN40	DIN 2635	F316/F316L	Weld neck flange	Form C face	23.6 (599)	48 (21.5)
382	DN50	PN40	DIN 2635	F316/F316L	Weld neck flange	Form C face	23.8 (605)	51 (23)
385	40mm	10K	JIS B 2220	F316/F316L	Weld neck flange	Raised face	23.4 (595)	46 (21)
386	50mm	10K	JIS B 2220	F316/316L	Weld neck flange	Raised face	23.7 (602)	48 (22)
387	40mm	20K	JIS B 2220	F316/F316L	Weld neck flange	Raised face	23.4 (595)	47 (21)
388	50mm	20K	JIS B 2220	F316/316L	Weld neck flange	Raised face	23.7 (602)	48 (22)
418	2-inch	CL150	ASME B16.5	F316/F316L	Weld neck flange	Raised face	24.9 (632)	50 (22.5)

Code	Description						Dim A inch (mm)	Weight lb (kg)
419	2-inch	CL300	ASME B16.5	F316/F316L	Weld neck flange	Raised face	25.4 (645)	54 (24.5)
420	2-inch	CL600	ASME B16.5	F316/F316L	Weld neck flange	Raised face	26.1 (664)	58 (26)
A31	1-1/2- inch	CL900/1 500	ASME B16.5	F316/F316L	Weld neck flange	Raised face	26.9 (683)	65(29)
A32	1-1/2- inch	CL150	ASME B16.5	F316/F316L	Weld neck flange	Raised face 63-125 Ra face finish	24.8 (629)	46(21)
A33	1-1/2- inch	CL300	ASME B16.5	F316/F316L	Weld neck flange	Raised face 63-125 Ra face finish	25.3 (641)	52(24)
A34	1-1/2- inch	CL600	ASME B16.5	F316/F316L	Weld neck flange	Raised face 63-125 Ra face finish	25.9 (657)	54(24)
A35	2-inch	CL900/1 500	ASME B16.5	F316/F316L	Weld neck flange	Raised face	27.4 (695)	83(38)
A36	3-inch	CL150	ASME B16.5	F316/F316L	Weld neck flange	Raised face	25.3 (641)	60(27)
A37	3-inch	CL300	ASME B16.5	F316/F316L	Weld neck flange	Raised face	25.9 (657)	68(61)
A38	3-inch	CL600	ASME B16.5	F316/F316L	Weld neck flange	Raised face	26.6 (676)	75(34)
A39	2-inch	CL150	ASME B16.5	F316/F316L	Weld neck flange	Raised face 63-125 Ra face finish	24.8 (629)	50(23)
A40	2-inch	CL300	ASME B16.5	F316/F316L	Weld neck flange	Raised face 63-125 Ra face finish	25.3 (641)	53(24)
A41	2-inch	CL600	ASME B16.5	F316/F316L	Weld neck flange	Raised face 63-125 Ra face finish	26.18 (664)	57(26)
A42	2-inch	CL150	ASME B16.5	F316/F316L	Weld neck flange	RTJ face	25.3 (641)	51(23)
A43	2-inch	CL300	ASME B16.5	F316/F316L	Weld neck flange	RTJ face	26.0 (660)	55(25)
A44	2-inch	CL600	ASME B16.5	F316/F316L	Weld neck flange	RTJ face	26.3 (667)	58(26)
A45	2-inch	CL900/1 500	ASME B16.5	F316/F316L	Weld neck flange	RTJ face	27.5 (699)	84(38)

Code	Description						Dim A inch (mm)	Weight lb (kg)
B55	2-inch	CL600	ASME B16.5	A105 Carbon Steel	Lap joint flange	316/316L stub	24.8 (629)	57(26)
B85	50mm	10K	JIS B 2220	A105 Carbon Steel	Lap joint flange	316/316L stub	23.7 (602)	50 (23)
B86	50mm	20K	JIS B 2220	A105 Carbon Steel	Lap joint flange	316/316L stub	23.7 (602)	50 (23)
C75	DN40	PN40	EN 1092-1	F316/F316L	Weld neck flange	Type F	23.4 (595)	48 (22)
C76	DN50	PN40	EN 1092-1	F316/F316L	Weld neck flange	Type F	23.7 (629)	51 (23)

Model F200H

Code	Description						Dim A inch (mm)	Weight lb (kg)
537	1-1/2- inch	CL600	ASME B16.5	F304/F304L	Lap joint flange	N06022 stub	25.3 (641)	64 (29)
540	1-1/2- inch	CL150	ASME B16.5	F304/F304L	Lap joint flange	N06022 stub	24.8 (628)	46 (21)
541	1-1/2- inch	CL300	ASME B16.5	F304/F304L	Lap joint flange	N06022 stub	25.3 (641)	52 (23.5)
542	40mm	10K	JIS 2220	F304/F304L	Lap joint flange	N06022 stub	23.4 (595)	52 (23.5)
544	2-inch	CL150	ASME B16.5	F304/F304L	Lap joint flange	N06022 stub	24.8 (628)	51 (23.5)
545	2-inch	CL300	ASME B16.5	F304/F304L	Lap joint flange	N06022 stub	25.3 (641)	56 (25.5)
546	50mm	10K	JIS B 2220	F304/F304L	Lap joint flange	N06022 stub	23.7 (601)	55 (25)
548	DN40	PN40	EN 1092-1	F304/F304L	Lap joint flange	Type B1, N06022 stub	23.6 (599)	50 (23)
549	DN50	PN40	EN 1092-1	F304/F304L	Lap joint flange	Type B1, N06022 stub	23.8 (605)	56 (25.5)

F300S

Code	Description						Dim A inch (mm)	Weight lb (kg)
326	DN80	PN40	EN 1092-1	F316/F316L	Weld neck flange	Type D	35.9 (912)	138 (63)
333	DN100	PN40	EN 1092-1	F316/F316L	Weld neck flange	Type D	36.5 (926)	166 (75.5)
355	3-inch	CL150	ASME B16.5	F316/F316L	Weld neck flange	Raised face	36.9 (935)	167 (76)
356	3-inch	CL300	ASME B16.5	F316/F316L	Weld neck flange	Raised face	37.6 (954)	167 (76)
357	3-inch	CL600	ASME B16.5	F316/F316L	Weld neck flange	Raised face	38.4 (974)	174 (79)
358	3-inch	CL900	ASME B16.5	F316/F316L	Weld neck flange	Raised face	37.7 (958)	123 (56)
359	DN100	PN100	EN 1092-1	F316/F316L	Weld neck flange	Type D	38.4 (976)	196 (89)
361	3-inch		Tri-Clamp compatible	316L	Hygienic fitting		35.1 (893)	196 (89)
371	DN80	PN40	EN 1092-1	F316/F316L	Weld neck flange	Type B1	35.9 (912)	158 (72)
372	DN100	PN40	EN 1092-1	F316/F316L	Weld neck flange	Type B1	36.5 (926)	146 (66.5)
373	DN80	PN100	EN 1092-1	F316/F316L	Weld neck flange	Type B2	37.5 (952)	176 (80)
374	DN100	PN100	EN 1092-1	F316/F316L	Weld neck flange	Type B2	38.4 (976)	198 (90)
375	DN80	PN100	EN 1092-1	F316/F316L	Weld neck flange	Type D	37.5 (952)	174 (79)
391	DN80	PN40	DIN 2635	F316/F316L	Weld neck flange	Form C face	36.0 (915)	137 (62)
392	DN100	PN40	DIN 2635	F316/F316L	Weld neck flange	Form C face	36.5 (926)	147 (66.5)
393	DN80	PN40	DIN 2635	F316/F316L	Weld neck flange	Form N grooved face	36.0 (915)	158 (71.5)
394	DN100	PN40	DIN 2635	F316/F316L	Weld neck flange	Form N grooved face	36.5 (926)	166 (75.5)
395	DN80	PN100	DIN 2637	F316/F316L	Weld neck flange	Form E face	37.8 (958)	176 (80)
396	DN100	PN100	DIN 2637	F316/F316L	Weld neck flange	Form E face	38.8 (983)	196 (89)

Code	Description						Dim A inch (mm)	Weight lb (kg)
397	DN80	PN100	DIN 2637	F316/F316L	Weld neck flange	Form N grooved face	37.8 (958)	175 (79.5)
398	DN100	PN100	DIN 2637	F316/F316L	Weld neck flange	Form N grooved face	38.8 (983)	195 (89)
400	80mm	10K	JIS B 2220	F316/F316L	Weld neck flange	Raised face	36.5 (927)	154 (70)
401	100mm	10K	JIS B 2220	F316/F316L	Weld neck flange	Raised face	36.7 (932)	158 (72)
402	80mm	20K	JIS B 2220	F316/F316L	Weld neck flange	Raised face	36.5 (927)	158 (71.5)
410	3-inch		Grooved coupling	316L	Hygienic coupling		36.9 (935)	196 (89)
425	4-inch	CL150	ASME B16.5	F316/F316L	Weld neck flange	Raised face	37.3 (945)	145 (66)
426	4-inch	CL300	ASME B16.5	F316/F316L	Weld neck flange	Raised face	38.1 (969)	184 (83.5)
427	4-inch	CL600	ASME B16.5	F316/F316L	Weld neck flange	Raised face	39.9 (1012)	212 (96.5)

Model F300H

Code	Description						Dim A inch (mm)	Weight lb (kg)
539	3-inch	CL600	ASME B16.5	F304/F304L	Lap joint flange	N06022 stub	36.0 (914)	167 (76)
550	3-inch	CL150	ASME B16.5	F304/F304L	Lap joint flange	N06022 stub	37.5 (953)	159 (72.5)
551	3-inch	CL300	ASME B16.5	F304/F304L	Lap joint flange	N06022 stub	36.8 (934)	167 (76)
552	80mm	10K	JIS B 2220	F304/F304L	Lap joint flange	N06022 stub	37.5 (953)	154 (70)
554	DN80	PN40	EN 1092-1	F304/F304L	Lap joint flange	Type B1, N06022 stub	36.5 (926)	145 (66)

Namur NE132 compliant flanges

Sensor	ETO#	Description						Dim A inch (mm)	Weight lb (kg)
F025S999	13998	DN15	PN40	EN 1092-1	F316/F316L	Weld neck flange	Form B1	20.1 (510)	11.7 (5.8)
F050S999	20589	DN15	PN40	EN 1092-1	F316/F316L	Weld neck flange	Form B1	20.1 (510)	13.4 (6.1)
F050S999	17157	DN25	PN40	EN 1092-1	F316/F316L	Weld neck flange	Form B1	23.6 (600)	13.9 (6.3)
F100S999	13999	DN25	PN40	EN 1092-1	F316/F316L	Weld neck flange	Form B1	23.6 (600)	23.8 (11.3)
F200S999	14000	DN50	PN40	EN 1092-1	F316/F316L	Weld neck flange	Form B1	28.2 (715)	48.4 (22.9)
F300S999	17159	DN80	PN40	EN 1092-1	F316/F316L	Weld neck flange	Form B1	36.0 (915)	11 (5)
F300S999	17158	DN100	PN40	EN 1092-1	F316/F316L	Weld neck flange	Form B1	39.7 (1000)	171 (77.8)
F300S999	20590	DN100	PN16	EN 1092-1	F316/F316L	Weld neck flange	Form B1	39.7 (1000)	162.8 (74)

Emerson Automation Solutions

Worldwide Headquarters
7070 Winchester Circle
Boulder, Colorado USA 80301
T: +1 800-522-6277
T: +1 303-527-5200
F: +1 303-530-8459
Mexico: 52 55 5809 5300
Argentina: 54 11 4837 7000
Brazil: 55 15 3413 8147
Chile: 56 2 2928 4800

Emerson Automation Solutions

Central Europe: +41 41 7686 111
Eastern Europe: +41 41 7686 111
Dubai: +971 4 811 8100
Abu Dhabi: +971 2 697 2000
Austria: +43 2236 607-0
France: 0800 917 901
Germany: +49 (0) 2173 3348 0
Italy: 8008 77334
The Netherlands: +31 (0) 70 413 6666
Belgium: +32 2 716 77 11
Spain: 900 901 986
U.K.: 0870 240 1978
Russian/CIS: +7 495 981 9811

Emerson Automation Solutions

Australia: (61) 3 9721 0200
China: (86) 21 2892 9000
India: (91) 22 6662 0566
Japan: (81) 3 5769 6803
South Korea: (82) 31 8034 0000
Singapore: (65) 6 363 7766

©2019 Micro Motion, Inc. All rights reserved.

The Emerson logo is a trademark and service mark of Emerson Electric Co. Micro Motion, ELITE, ProLink, MVD and MVD Direct Connect marks are marks of one of the Emerson Automation Solutions family of companies. All other marks are property of their respective owners.