



# S8000

## Chilled Mirror Hygrometer

### User's Manual



97488 Issue 4  
August 2018

Please fill out the form(s) below for each instrument that has been purchased.

Use this information when contacting Michell Instruments for service purposes.

Instrument	
Code	
Serial Number	
Invoice Date	
Location of Instrument	
Tag No	

Instrument	
Code	
Serial Number	
Invoice Date	
Location of Instrument	
Tag No	

Instrument	
Code	
Serial Number	
Invoice Date	
Location of Instrument	
Tag No	



## S8000

For Michell Instruments' contact information please go to  
[www.michell.com](http://www.michell.com)

© 2018 Michell Instruments

This document is the property of Michell Instruments Ltd. and may not be copied or otherwise reproduced, communicated in any way to third parties, nor stored in any Data Processing System without the express written authorization of Michell Instruments Ltd.

---

## Contents

Safety .....	ix
Electrical Safety .....	ix
Pressure Safety .....	ix
Toxic Materials .....	ix
Repair and Maintenance .....	ix
Calibration .....	ix
Safety Conformity .....	ix
Abbreviations .....	x
Warnings .....	x
<b>1 INTRODUCTION .....</b>	<b>1</b>
1.1 Operating Principle .....	2
<b>2 INSTALLATION .....</b>	<b>3</b>
2.1 Safety .....	3
2.2 Unpacking the Instrument .....	3
2.3 Operating Requirements .....	5
2.3.1 Environmental Requirements .....	5
2.3.2 Electrical Requirements .....	5
2.4 Exterior Layout .....	5
2.5 Rear Panel Connections (All Versions) .....	8
2.5.1 Power Supply Input .....	9
2.5.2 Analog Output Connections .....	10
2.5.3 Alarm Output Connections .....	11
2.5.4 Remote PRT Probe (Optional) .....	13
2.5.5 4-Wire PRT Output (Optional) .....	14
2.5.6 USB Communications Port Connector .....	14
2.5.7 Ethernet Port (Optional) .....	15
2.5.8 RS232/485 Port (Optional) .....	15
2.5.9 Connection of Gas Supplies .....	17
2.6 Internal Sample Pump (Optional) .....	19
2.7 Conversion of S8000 to Rack Mount .....	20
<b>3 OPERATION .....</b>	<b>21</b>
3.1 General Operational Information .....	21
3.2 Instrument Display .....	22
3.2.1 Main Screen .....	23
3.2.2 Customizable Readouts .....	24
3.2.3 Operational Status Display .....	24
3.2.4 Setup Menu Screen .....	25
3.2.5 Menu Structure .....	27
3.2.6 DCC .....	28
3.2.7 LOGGING .....	29
3.2.8 OUTPUTS .....	31
3.2.9 ALARM .....	31
3.2.10 DISPLAY .....	32
3.2.11 CLOCK .....	33
3.2.12 ABOUT (Network Settings) .....	33
3.3 Operational Functions .....	34
3.3.1 Operating Cycle .....	34
3.4 Operating Guide .....	35
3.4.1 DCC - Dynamic Contamination Control .....	35
3.4.2 MAXCOOL Function .....	36
3.4.3 Pressure Compensation .....	36

3.4.4	Data Logging .....	36
3.4.5	Frost Assurance System Technology (FAST) .....	37
3.4.6	STANDBY Mode.....	37
4	APPLICATION SOFTWARE .....	38
4.1	Installation.....	38
4.2	Establishing Communications .....	38
4.2.1	USB Communication.....	39
4.2.2	RS232/485 Communication.....	40
4.2.3	Ethernet Communication .....	40
4.3	Data Acquisition or Edit Variables Mode.....	41
4.3.1	Data Acquisition.....	42
4.3.2	Variable Edit .....	44
5	MAINTENANCE .....	46
5.1	Safety.....	46
5.2	Fuse Replacement .....	47
5.3	Sensor Mirror Cleaning.....	48
5.3.1	Releasing optics window .....	49
5.3.2	Fitting the Microscope (Optional).....	50
6	GOOD MEASUREMENT PRACTICE .....	51
6.1	Sampling Hints.....	52
7	CALIBRATION.....	55
7.1	Traceability .....	55
8	PREPARATION FOR SHIPPING .....	56

## Tables

Table 1	Front Panel Controls and Indicators .....	6
Table 2	Rear Panel Controls and Indicators .....	8
Table 3	Main Screen Description.....	23
Table 4	Operational Status Display .....	24
Table 5	DCC Parameters .....	28
Table 6	Logging Parameters.....	29
Table 7	SD Card Status Indicators .....	30
Table 8	Outputs Parameters.....	31
Table 9	Alarm Parameters.....	31
Table 10	Display Parameters.....	32
Table 11	Clock Parameters.....	33
Table 12	Network Parameters .....	33
Table 13	Data Acquisition Control Description .....	42
Table 14	Graph Control Description .....	43
Table 15	Status Bar Description .....	43
Table 16	Modbus Holding Register Map .....	69
Table 17	Register Configuration A .....	70
Table 18	Register Configuration B1.....	70
Table 19	Register Configuration B2.....	70
Table 20	Register Configuration D Status Word .....	71
Table 21	Register Configuration E Units .....	71
Table 22	Register Configuration F Display Setting A.....	71
Table 23	Register Configuration F Display Setting B.....	72
Table 24	Register Configuration H .....	72
Table 25	Register Configuration J.....	72
Table 26	Register Configuration K .....	72
Table 27	Register Configuration L.....	73
Table 28	Register Configuration M.....	73
Table 29	Register Configuration N .....	73
Table 30	Register Configuration P.....	74

## Figures

Figure 1	S8000.....	1
Figure 2	Operating Principle .....	2
Figure 3	S8000 Packing.....	3
Figure 4	Front Panel .....	6
Figure 5	Rear Panel .....	7
Figure 6	Power Supply Input .....	9
Figure 7	Analog Output Connectors .....	10
Figure 8	Alarm Output Connectors.....	12
Figure 9	Remote PRT Connection.....	13
Figure 10	Internal PRT Output (Optional).....	14
Figure 11	USB Port Connection.....	14
Figure 12	Ethernet Port (Optional).....	15
Figure 13	RS232/485 Port (Optional) .....	15
Figure 14	Gas Connections.....	17
Figure 15	Gas Connections when Pump is Fitted.....	19
Figure 16	Rack Fixing Method .....	20
Figure 17	Initialising Overlay Screen .....	22
Figure 18	Main Screen.....	22
Figure 19	Main Screen Layout .....	23
Figure 20	Setup Menu Screen .....	25
Figure 21	Virtual Keyboard .....	26
Figure 22	Menu Structure .....	27
Figure 23	DCC Screen.....	28
Figure 24	Logging Screen .....	29
Figure 25	Outputs Screen .....	31
Figure 26	Alarm Screen .....	31
Figure 27	Display Screen .....	32
Figure 28	Clock Screen .....	33
Figure 29	Network Settings Screen .....	33
Figure 30	Typical Operating Cycle.....	34
Figure 31	Communications Setup Screen .....	38
Figure 32	Windows Device Manager Screen .....	39
Figure 33	Network Settings Screen.....	40
Figure 34	Options Screen.....	41
Figure 35	Data Acquisition Screen .....	42
Figure 36	Variables Editor Screen .....	45
Figure 37	Power Supply Fuse Replacement .....	47
Figure 38	Sensor Mirror Cleaning.....	48
Figure 39	Releasing Optics Window .....	49
Figure 40	Fitting the Microscope.....	50
Figure 41	Typical Calibration Certificate.....	55
Figure 42	Instrument Packing Details.....	56
Figure 43	Select Format.....	62
Figure 44	Set Format Properties .....	62
Figure 45	Format Disc .....	62
Figure 46	Modbus Connection .....	67

---

---

## Appendices

Appendix A	Technical Specifications.....	58
	A.1 Dimensions .....	60
Appendix B	Formatting SD cards .....	62
Appendix C	Calculations .....	64
	C.1 Water Content.....	64
	C.2 Temperature - Dew Point .....	64
	C.3 °C to °F Calculation .....	64
	C.4 % RH Calculation .....	64
	C.5 Conversion of bara to psia and kPa .....	65
Appendix D	Modbus RTU Communications .....	67
	D.1 Introduction .....	67
	D.2 Basic Modbus Operation .....	67
	D.3 Modbus RTU Connections and Protocol.....	68
	D.4 Register Map .....	68
Appendix E	Default Values.....	76
Appendix F	Quality, Recycling & Warranty Information.....	78
Appendix G	Return Document & Decontamination Declaration.....	80



## Safety

The manufacturer has designed this equipment to be safe when operated using the procedures detailed in this manual. The user must not use this equipment for any other purpose than that stated. Do not apply values greater than the maximum value stated.

This manual contains operating and safety instructions, which must be followed to ensure the safe operation and to maintain the equipment in a safe condition. The safety instructions are either warnings or cautions issued to protect the user and the equipment from injury or damage. Use qualified personnel and good engineering practice for all procedures in this manual.

### Electrical Safety

The instrument is designed to be completely safe when used with options and accessories supplied by the manufacturer for use with the instrument. The input power supply voltage limits are 85 to 264 V AC, 47/63 Hz. Refer to Appendix A - Technical Specifications.

### Pressure Safety



**Before pressurizing, the user must ensure through appropriate protective measures that the system or the device will not be over-pressurized. When working with the instrument and pressurized gases safety glasses should be worn.**

DO NOT permit pressures greater than the safe working pressure to be applied to the instrument. The specified maximum safe working pressure is 1 barg (14.5 psig) for the low pressure version, or 20 barg (290 psig) for the high pressure version. This instrument is not designed to accept gas pressures higher than the specified maximum working pressure.

Application of gas pressures higher than the specified maximum will result in potential damage and may render the instrument unsafe and in a condition of incorrect functionality. Only personnel trained in the safe handling of high pressure gases should be allowed to operate this instrument. Refer to Appendix A - Technical Specifications in this manual.

### Toxic Materials

The use of hazardous materials in the construction of this instrument has been minimized. During normal operation, it is not possible for the user to come into contact with any hazardous substance, which might be employed in the construction of the instrument. Care should, however, be exercised during maintenance and the disposal of certain parts.

### Repair and Maintenance

The instrument must be maintained either by the manufacturer or an accredited service agent. Refer to [www.michell.com](http://www.michell.com) for details of Michell instruments' worldwide offices contact information.

### Calibration

The recommended calibration interval for the S8000 is one year, unless otherwise specified by Michell Instruments Ltd. The instrument should be returned to the manufacturer, Michell Instruments, or one of their accredited service agents for re-calibration (go to [www.michell.com](http://www.michell.com) for contact information).

### Safety Conformity

This product meets the essential protection requirements of the relevant EU directives. Refer to Appendix A - Technical Specifications - for details.

## Abbreviations

The following abbreviations are used in this manual:

DCC	Dynamic Contamination Correction
FAST	Frost Assurance System Technology
MAXCOOL	Maximum Sensor Cooling
AC	alternating current
atm	pressure unit (atmosphere)
barg	pressure unit (=100 kP or 0.987 atm) gauge
bara	pressure unit (absolute)
°C	degrees Celsius
°F	degrees Fahrenheit
COM	common
dp	dew point
EU	European Union
g/Kg	grams per kilogram
g/m <sup>3</sup>	grams per cubic meter
HMI	Human Machine Interface
Hz	Hertz
IEC	International Electrotechnical Commission
NI/min	normal liters per minute
lb	pound
mA	milliampere
max	maximum
min	minute(s)
mV	millivolt(s)
N/C	normally closed
N/O	normally open
No	number
ppm <sub>v</sub>	parts per million (by volume)
ppm <sub>w</sub>	parts per million (by weight)
PRT	Platinum resistance thermometer (typically type Pt 100)
psig	pound(s) per square inch (gauge)
psia	pound(s) per square inch (absolute)
RH	relative humidity
RTU	Remote Terminal Unit
scfh	standard cubic feet per hour
SD	storage device card (memory card for storing datalog files)
temp	temperature
USB	Universal Serial Bus
V	Volts

## Warnings

The following general warnings listed below are applicable to this instrument. They are repeated in the text in the appropriate locations.



**Where this hazard warning symbol appears in the following sections, it is used to indicate areas where potentially hazardous operations need to be carried out.**



**Where this symbol appears in the following sections it is used to indicate areas of potential risk of electric shock.**

## 1 INTRODUCTION

The S8000 is a high precision instrument used for the measurement of dew point in air and other gases. Relative humidity, moisture content, and other calculated parameters based on dew point, pressure and temperature of the sample gas can also be displayed.

The S8000 is capable of measuring dew points as low as  $-60^{\circ}\text{C}$  ( $-76^{\circ}\text{F}$ ); it can measure dew points up to (but not including) the point of condensation (maximum  $+40^{\circ}\text{C}$  ( $+104^{\circ}\text{F}$ )).

Two models of the S8000 instrument are available:

- Low Pressure (1 barg (14.5 psig) max)
- High Pressure (20 barg (290 psig) max)



Figure 1 *S8000*

## 1.1 Operating Principle

The system operates on the chilled mirror principle, whereby a gas sample is passed into the sensor housing and flows over the surface of the chilled mirror contained within. At a temperature dependent upon the moisture content in the gas, and the operating pressure, the moisture in the gas condenses out on the surface of the mirror.

An optical system is used to detect the point at which this occurs, and this information is used to control the mirror temperature and maintain a constant thickness of the condensation layer on the mirror surface.

A beam of light from an LED (1) is focused on the mirror surface (2) with a fixed intensity. As the mirror is cooled, less light is reflected due to the scattering effect of the condensate formed on the mirror surface. The levels of reflected and scattered light are measured by two photo-detectors (3 & 4) and compared against a third reference detector (5) measuring the intensity of light from the LED.

The signals from this optics system are used to precisely control the drive to a solid state thermoelectric cooler (TEC) (6), which heats or cools the mirror surface. The mirror surface is then controlled in an equilibrium state whereby evaporation and condensation are occurring at the same rate. In this condition, the temperature of the mirror, measured by a platinum resistance thermometer (7), is equal to the dew-point temperature of the gas.

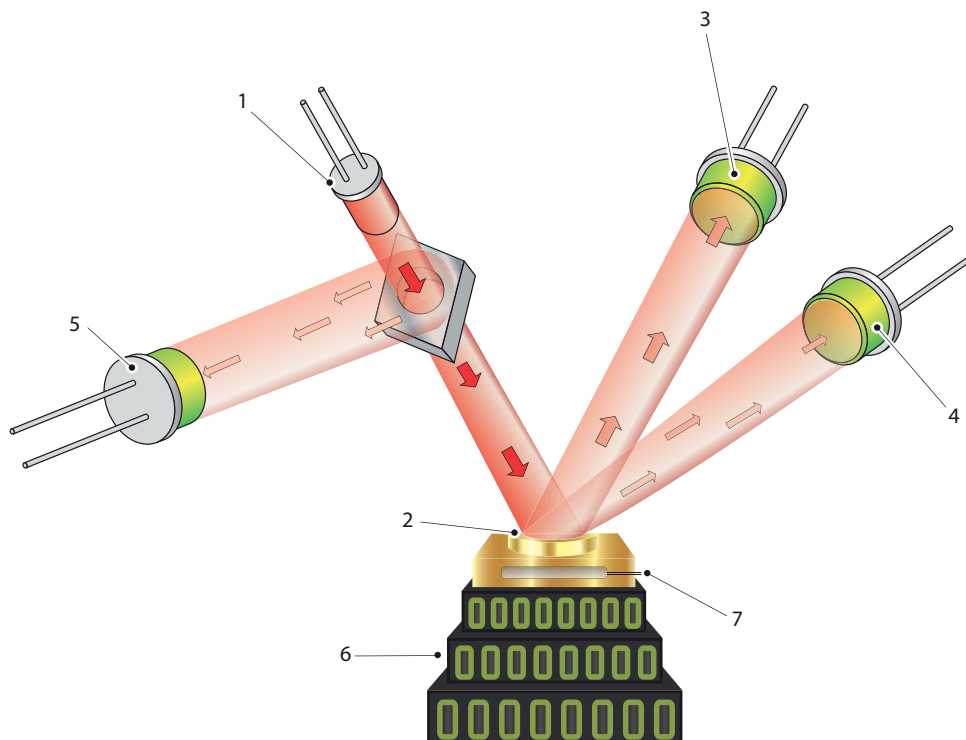

Figure 2 *Operating Principle*

## 2 INSTALLATION

### 2.1 Safety



**It is essential that the installation of the electrical and gas supplies to this instrument be undertaken by competent personnel.**

### 2.2 Unpacking the Instrument

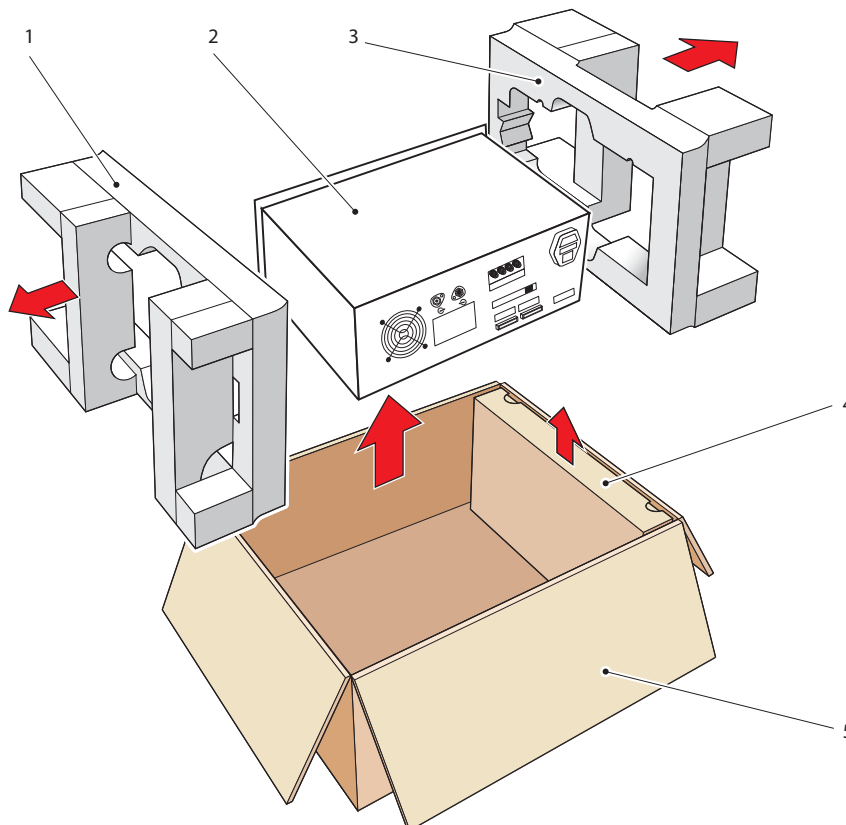

Figure 3 *S8000 Packing*

Open the box (5) and unpack carefully as follows (see *Figure 3*) :

1. Remove the accessories box (4).
2. Lift out the instrument (2) together with its end packing pieces (1) and (3).
3. Remove the end packing pieces (1) and (3) set the instrument down at the site of installation.
4. Save all the packing materials for the purpose of returning the instrument for re-calibration or any warranty claims.

The accessories box should contain the following items:

1. Traceable calibration certificate
2. User's manual
3. IEC power cable
4. SD memory storage card
5. Optics cleaning kit
6. Allen Key SMM
7. USB communications cable
8. Pt100 temperature probe (optional)
9. CAT5 ethernet cable (optional)
10. Microscope (optional)

**If there are any shortages, please notify Michell Instruments immediately (see [www.michell.com](http://www.michell.com) for contact information).**

## 2.3 Operating Requirements

### 2.3.1 Environmental Requirements

The S8000 instrument should either be placed on a firm and level surface in a laboratory environment, or mounted into a standard 19" rack. Recommended ambient temperature +20 to +25°C (+68 to +77°F) although the instrument will operate, within specification, at elevated ambient temperatures of up to +40°C (+104°F), providing the cooling vents are kept clear and unrestricted. **It is essential however that this upper temperature limit (+40°C (+104°F)) is not exceeded.**

A free flow of air around the instrument is required at all times.

The instrument is suitable for mounting in a standard 19" rack.



**For rack mounted instruments, forced air cooling of the rack should be considered if operating at high ambient temperatures.**

### 2.3.2 Electrical Requirements

All versions of the instrument require the following electrical supply:

- 85 to 264 V AC, 47/63 Hz, 100 VA max
- Alarm outputs for all instrument types comprise two sets of changeover relay contacts, one set for a **PROCESS** alarm and one set for an **INSTRUMENT FAULT**. Both sets of contacts are rated at 24 V, 1 A. **NOTE: THIS RATING MUST NOT BE EXCEEDED.**

## 2.4 Exterior Layout

The controls and indicators relating to the operator interface are located on the front panel.

The external PRT connection, mains power IEC socket, analog output connector, remote temperature probe connector, alarm relay connector, the USB socket, and the Ethernet socket (optional) are located on the rear panel.

*Figures 5 and 6* show the layout of these controls for both the rack mount/horizontal and vertical versions of the instrument. Tables 1 and 2 detail the controls and indicators and the function key operations.

Front Panel



Figure 4 Front Panel

Item	Name	Description
1	<b>Microscope Blanking Plug</b>	Used to cover the microscope port when not in use. Also to be used as a key to remove optics window (see Section 5.3).
2	<b>Sensor Housing</b>	Exterior housing of the sensor. See Section 5.3 for information about the sensor head.
3	<b>Touch Screen Display</b>	Displays measured values and enables the user to control the operation of the instrument. See Section 3.2 for information about the touch screen and menu system.

Table 1 Front Panel Controls and Indicators



## Rear Panel

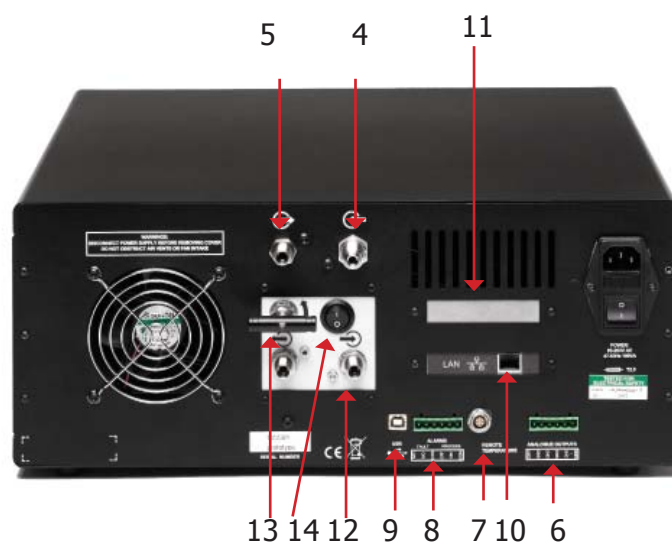

Figure 5 Rear Panel

Item	Name	Description
4	<b>Gas Input Port</b>	Usually slightly above atmospheric pressure in order to maintain flow rate over the mirror, but can be up to a maximum of 20 barg depending upon application.
5	<b>Gas Output Port</b>	Usually vented to atmosphere.
6	<b>Analog Output Connector</b>	Three, 2-wire output channels, CH1, CH2 and CH3, each of which may be configured to give either a 0-20 mA or a 4-20 mA current loop output or a 0 to 1 V voltage signal representing any one of the measured or calculated output parameters selected.  Spans for each signal output are separately configurable. Refer to Section 2.5.2.
7	<b>Remote Temperature Probe (optional)</b>	6-Pin Lemo socket for connection of remote Pt100 temperature probe.
8	<b>Alarms</b>	Process and Fault alarm outputs. Each alarm has one set of potential free, changeover, relay contacts, common (COM), normally closed (N/C) and normally open (N/O).  The Process alarm can be configured to operate at a specified level on any of the measured or calculated parameters. Refer to Section 2.5.3.
9	<b>USB Communications Port</b>	Used for connection to an external computer system for running application software (optional).

10	<b>RJ45 Ethernet Socket (Optional)</b>	Used for communication with the instrument over a network connection. See Section 4.2.3 for details on how to configure the network settings. See Section 4 for information on using and installing the application software.
11	<b>4-wire PRT bridge output (Optional)</b>	Banana sockets for external 4-wire measurement of the internal PRT. Active only when PRT set to External from Display options, and instrument is in the MEASURE phase. In this mode the dew-point display is set to read zero, DCC is set to OFF and manual DCC is also disabled.
12	<b>Flow Control Valve (Optional)</b>	Used to regulate flow through the sensor when pump is in use.
13	<b>Pump Input Port (Optional)</b>	Can be linked to Gas Output port with supplied tubing for operation with sample pump - <b>NOT TO BE USED ABOVE ATMOSPHERIC PRESSURE.</b>
14	<b>Pump Output Port (Optional)</b>	Vented to atmosphere when pump is in use.

Table 2 Rear Panel Controls and Indicators

## 2.5 Rear Panel Connections (All Versions)



**These tasks should be undertaken only by competent personnel.**



**DANGER**  
Electric Shock Risk

**All the connections to the rear panel are electrical connections.**

**Exercise due caution, particularly when connecting to external alarm circuits which could be at high potential.**

Connections to the rear panel of the instrument are explained in the following sections.

### 2.5.1 Power Supply Input

The AC power supply is a push fit into the power input socket as shown in *Figure 7*. The method of connection is as follows:

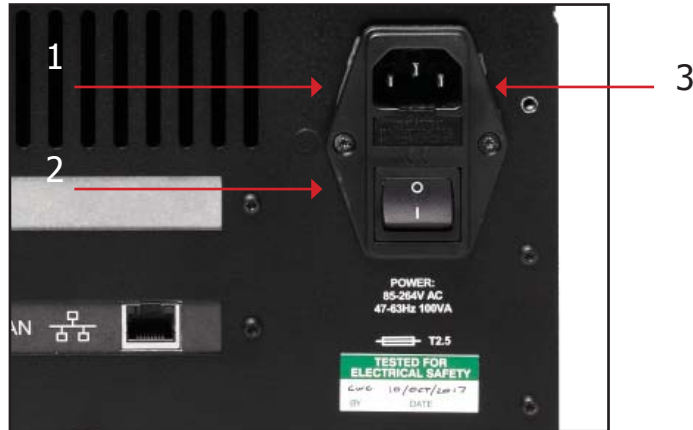

1. Ensure that both ends of the power cable are potential free i.e. not connected to an AC power supply.
2. Check that the **ON/OFF** switch (1) on the power supply connector is switched to **OFF**.
3. Push the IEC connector (3) firmly into the power input socket (2).
4. Connect the free end of the power cable to a suitable AC power supply source (voltage range 85 to 264 V AC, 47/63 Hz) and switch on the AC supply. The instrument may then be switched on, as required, using the **ON/OFF** switch.

Figure 6 *Power Supply Input*

2.5.2 Analog Output Connections

The three analog outputs can be configured to represent any of the directly measured or calculated output parameters. They are provided as 2-wire signals from a 6-way connector located on the rear panel of the instrument.

Each of these outputs can be set up as either a current loop signal (4-20 mA or 0-20 mA) or alternatively, as a 0-1 V voltage signal. The configuration of these outputs, i.e. parameter represented, output type (current loop or voltage) and upper/lower span levels are set up via the **SETUP** Menu Screen (refer to Section 3.2.4).

These signals may be used to control external systems. During a **DCC** cycle, and for the **HOLD** period following a **DCC** cycle, they are held at the level that they were at immediately prior to the start of the cycle. When the dew-point measurement is stable, or if the maximum **HOLD** period has expired, they are released and will track the selected parameter throughout the measurement cycle.

The default settings of these analog outputs are:

**Channel 1:** 4-20 mA, dew point, -60 to +20°C

**Channel 2:** 4-20 mA, ppm<sub>v</sub>, 0 to 3000

**Channel 3:** 4-20 mA, flow, 0 to 1000ml

**NOTE: The analog outputs are only active during the MEASURE phase. They will, therefore, be off after switch-on and remain off until the system enters the MEASURE phase.**

The three analog output ports connections are made via a single, 6-way, push fit connector block as shown in *Figure 8*. All outputs are 2-wire signals referenced to a common 0 V line. To differentiate between the outputs it is recommended that a black lead be used for each of the COM (common) lines and a separate color for each of the positive lines.

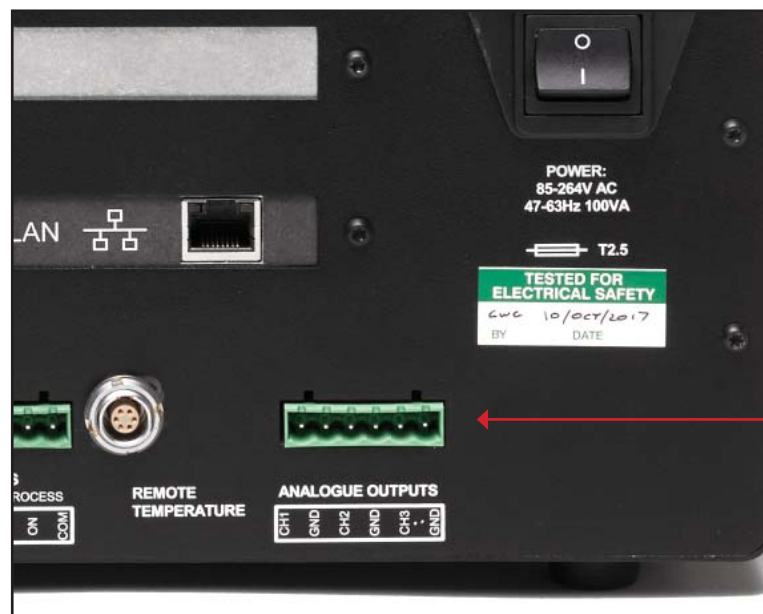

Figure 7 Analog Output Connectors

For each output:

1. Remove the terminal block fitted into the analog output socket.
2. Strip back the wire for the common (black) connection to the **CH1** output, exposing approximately 6mm (0.25"). Insert the wire into the **COM1** terminal way and screw into the block. **Do not overtighten the screw.**
3. Strip back the wire for the signal (e.g. red) connection to the **OP1** output, exposing approximately 6mm (0.25"). Insert the wire into the **OP1** terminal way and screw into the block. **Do not overtighten the screw.**
4. Repeat operations 1 and 2 for the other analog outputs, selecting a different color for the **OP2** and **OP3** outputs.
5. Locate the terminal block over the connector labelled **ANALOGUE OUTPUTS** and push the terminal block firmly into the connector.

### 2.5.3 Alarm Output Connections

Two alarm outputs are provided from a terminal block (Item 9, *Figure 6*), located on the rear panel of the instrument as two pairs of potential free, change-over relay contacts. These are designated as a **PROCESS** alarm and a **FAULT** alarm.

Under the **SETUP** menu, (refer to Section 3.2.4), the **PROCESS** alarm can be configured to represent any one of the measured or calculated parameters and set-up to operate when a pre-set parameter threshold level is exceeded. By default, the **PROCESS** alarm is set to monitor the dew-point parameter.

The **FAULT** alarm is a non-configurable alarm which continuously monitors the degree of contamination of the chilled mirror. During normal operational conditions, this alarm will be off. If the optics or the mirror contamination exceeds 100% of the film thickness, or if a fault exists on the Pt100, the alarm is triggered, and the relay contacts will change state.

This fault is also reported to the status area of the display.

The two alarm output ports are connected to the instrument via a single 6-way, push-fit connector block as shown in *Figure 9*. Each output comprises a 3-wire set of potential free, change-over relay contacts.

Each contact set is labelled **COM** (common 0 V), **N/O** (normally open with respect to **COM**) and **N/C** (normally closed with respect to **COM**).

To differentiate between the alarm output channels, it is recommended that a black lead be used for each of the **COM** (common) lines and a separate color for each of the **N/O** and **N/C** lines.



**WARNING: Alarm leads MUST be potential free when wiring to connector block.**

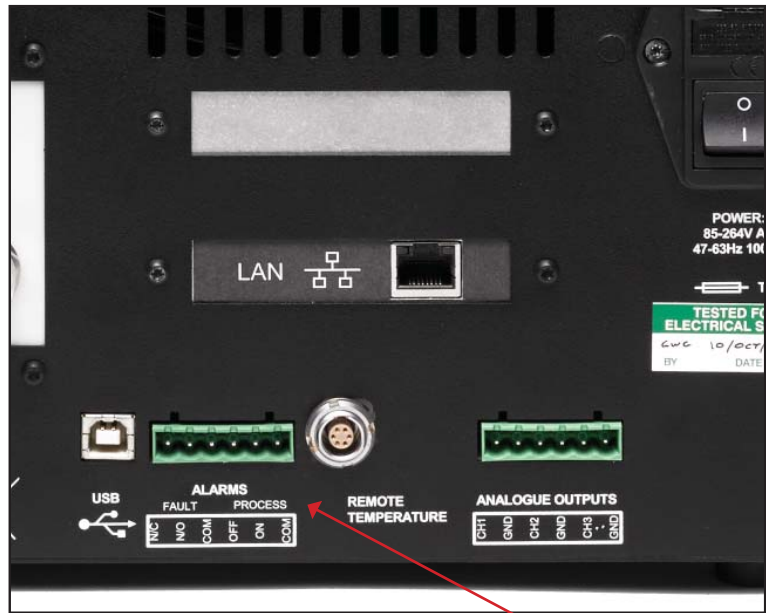

Figure 8 Alarm Output Connectors

For each output:

1. Strip back the wire for the common (black) connection to the **COM** connector way for the **FAULT** alarm contact set, exposing approximately 6mm (0.25") wire and clamp into the screw block **COM** terminal way. **Do not overtighten the screw.**
2. Strip back the wire for the **N/O** (e.g. green) connection to the **N/O** connector way for the **FAULT** alarm contact set, exposing approximately 6mm (0.25") wire and clamp into the screw block **N/O** terminal way. **Do not overtighten the screw.**
3. Strip back the wire for the **N/C** (e.g. blue) connection to the **N/C** connector way for the **FAULT** alarm contact set, exposing approximately 6mm (0.25") wire and clamp into the screw block **N/C** terminal way. **Do not overtighten the screw.**
4. Repeat operations 1 to 3 for the **PROCESS** alarm contact set, using appropriate colored wires.
5. Locate the terminal block over the connector labelled **ALARMS** and push the terminal block firmly into the connector.

### 2.5.4 Remote PRT Probe (Optional)

1. Rotate the body of the PRT probe connector until it locates in the socket labelled **REMOTE TEMPERATURE** (see *Figure 10*).
2. Push the connector into the socket until it locks. **Do not attempt to force it into the socket. If it will not fit in, rotate it until the key locks and it pushes in easily.**
3. To remove the connector, slide the connector's body collar (1) back along its axis, away from the instrument to release the lock and then gently pull the connector body out of the socket. **Do not attempt to pull it out with the cable - make sure that the collar is first released.**

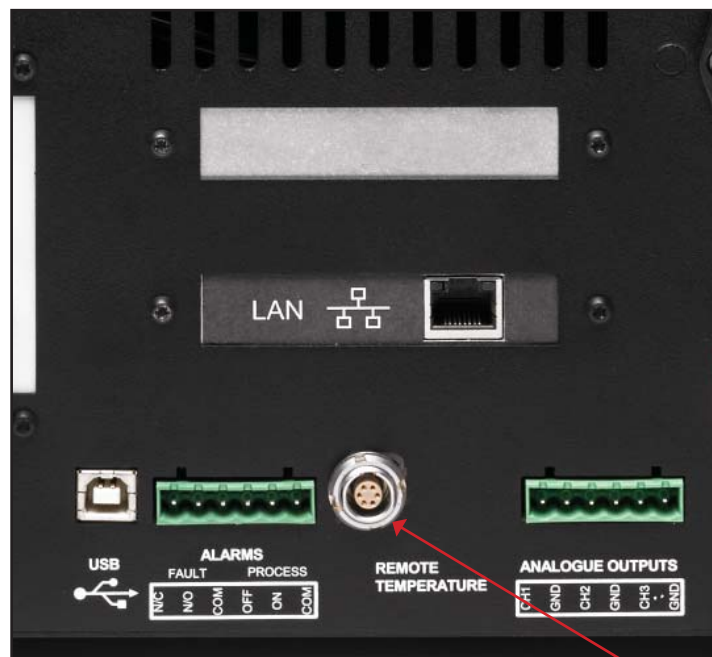

Figure 9 *Remote PRT Connection*

**2.5.5 4-Wire PRT Output (Optional)**

These four terminal binding posts (Item 1, *Figure 11*), are provided for calibration and external monitoring purposes.

Two pairs of lines are provided, two drive and two sense lines. One black (low) and one red (high) for the drive lines, and one black (low) and one red (high) for the sense lines.

Connections to these terminal posts can be made either via 4mm plugs pushed into the ends of the terminal posts or, alternatively, as shown, wires (5) connected round the posts and clamped down by screw action.

To set-up the system for PRT output refer to Section 3.2.10.



Figure 10 Internal PRT Output (Optional)

**2.5.6 USB Communications Port Connector**

The instrument features a USB port for communication with the Application Software. The appropriate cable will be supplied with the instrument.

1. Check the orientation of the connector and gently push it into the socket labelled **USB** (see *Figure 12*).
2. To remove the connector, pull it out of the socket by holding the connector body. Do not attempt to remove it from the socket by pulling on the cable.

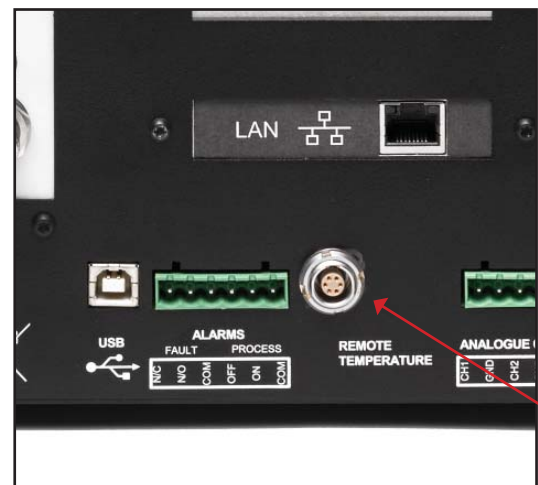

Figure 11 USB Port Connection

For more information on how to configure the Application Software go to Section 4.



### 2.5.7 Ethernet Port (Optional)

The instrument features an optional RJ45 port for communication with the Application Software.

1. Check the orientation of the connector and gently push it into the socket labelled **LAN**.

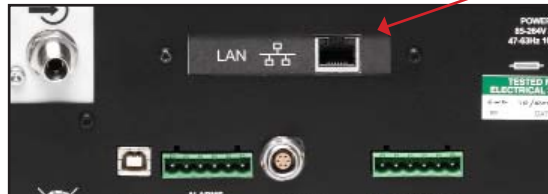

Figure 12 *Ethernet Port (Optional)*

2. To remove the connector, depress the small locking tab on the top and pull it out of the socket by holding the connector body.

For more information on how to configure the Application Software go to Section 4.

### 2.5.8 RS232/485 Port (Optional)

The instrument features an optional RS232/485 port for communication with the application software. This is designed to be used with a standard 9-pin D-sub connector.

1. Check the orientation of the connector and gently push it into the socket labelled **RS232** or **RS485**, and tighten the retaining screws.



Figure 13 *RS232/485 Port (Optional)*

2. Loosen the retaining screws, and pull the connector out of the socket by holding the connector body.

**RS232**

Pin 1	N/C
Pin 2	TXD
Pin 3	RXD
Pin 4	N/C
Pin 5	GND
Pin 6	N/C
Pin 7	N/C
Pin 8	N/C
Pin 9	N/C

RS232 Pinout (9-pin female)

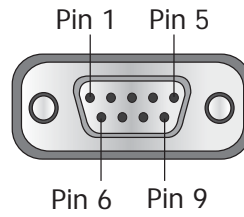

**RS485**

Pin 1	N/C
Pin 2	N/C
Pin 3	A
Pin 4	N/C
Pin 5	GND
Pin 6	N/C
Pin 7	N/C
Pin 8	B
Pin 9	N/C

RS485 Pinout (9-pin female)

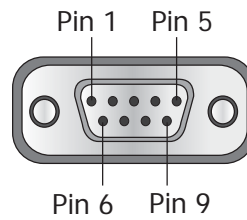

## 2.5.9 Connection of Gas Supplies



**POSSIBLE INJURY!** The tubing, valves and other apparatus attached to this instrument must be adequate for the maximum pressure which will be applied, otherwise physical injury to the operator or bystander is possible.



**Before connection or disconnection of the instrument to and from the gas line it is essential to vent the system to atmospheric pressure, otherwise severe injury could result.**

Sample gas connections are made via the **GAS OUT** port (7) and the **GAS IN** port (8) located on the rear panel.

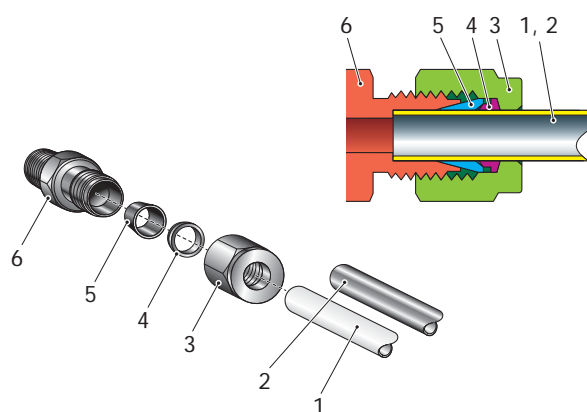
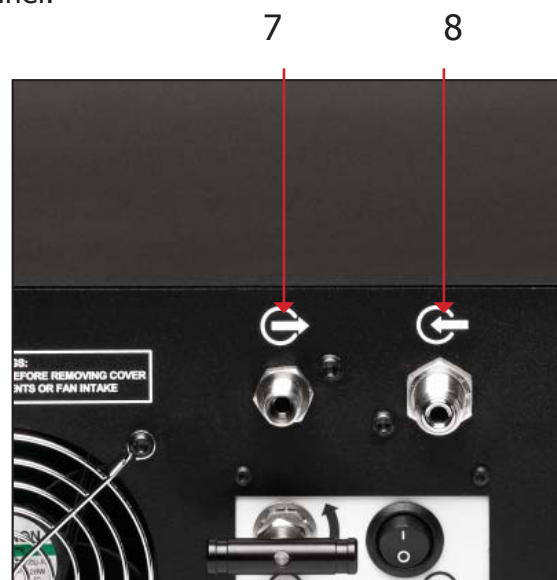

Figure 14 *Gas Connections*

The sample inlet and outlet connections are either 6mm or ¼" Swagelok® tube couplings (optional). The gas input connection must be made with 6mm or ¼" stainless steel tubing (the appropriate size for the connectors fitted). The gas output connection for most applications can just be exhausted to atmosphere via 300mm (11.8") of PTFE tubing (1).

The method of connection to the **GAS IN** port (8) is as follows.

1. Cut appropriate diameter stainless steel tubing (2) to the correct length and, if necessary, bend to shape to suit the location of the instrument.  
**NOTE: To facilitate ease of connection to the port, at least 75mm (3") of the tubing coming out of the GAS IN port should be straight.**
2. Clean off any burrs or metal shavings adhering to the tubing.
3. Pass the tubing (2) through the Swagelok nut (3).
4. Fit the back ferrule (4) over the tubing (2) with the bevelled end facing the back of the front ferrule (5).
5. Place the front ferrule (5) over the tubing (2), bevelled end towards the adaptor (6).
6. Push the tubing as far as it will go into the fitting and tighten up the locking nut (3) finger tight.
7. Hold the adaptor (6) flats with a wrench and tighten up the locking nut (3) 1¼ turns. This action compresses the front ferrule (5) and back ferrule (4) onto the tubing to form a gas tight seal. **CAUTION: Do not overtighten as this could cause the ferrules to crack and destroy the integrity of the seal.**
8. Connect up the **GAS OUT** port (7) in a similar manner to that described in operations 1 - 8 above optionally using PTFE tubing (1) in place of stainless steel (2).

## 2.6 Internal Sample Pump (Optional)

The internal sample pump can be used to allow measurement of static samples at atmospheric pressure. The pump can be be routed in to the sample loop or bypassed, depending on whether it is connected via the external tube link.

The instrument can be configured for operation with a pressurized sample by following the instructions in Section 2.6.

To configure the instrument for sample pump operation (Atmospheric input pressure only):

1. Connect the external tube link from the **GAS OUT** port, to the **PUMP IN** port, and tighten to form a gas-tight seal
2. Connect the sample line to the **GAS IN** port
3. Use the needle valve on the pump panel to control the flow rate to 500ml/min, as indicated on the display



Figure 15 Gas Connections when Pump is Fitted

## 2.7 Conversion of S8000 to Rack Mount

Figure 17 illustrates the method for fitting a rack mount instrument into a standard 19" rack. To fit the unit proceed as follows:



Figure 16 *Rack Fixing Method*

1. Turn the unit on its left hand end and remove the four screws and washers from the side panel.
  2. Line up the fixing holes on the right hand side of the instrument with the corresponding holes in the right hand wing (flange facing outwards).
  3. Insert the four screws and washers through the wing and tighten finger tight.
  4. Ensure that the front flange is square to the front of the instrument and tighten the screws.
  5. Turn the unit on its right hand end and repeat operations 1 to 4.
- To remove from the rack wings follow these directions above, in reverse.

### 3 OPERATION

As supplied, the S8000 is ready for operation and a set of default parameters has been installed. This section describes both the general operation of the instrument and the method of setting it up and changing the default parameters (see Appendix E) - should this become necessary.

#### 3.1 General Operational Information

While the instrument can physically operate in a flowing gas stream of between 0.3 and 1 NI/min, (0.6 and 2.1 scfh), Michell Instruments recommends operating at 0.5 NI/min (1.06 scfh) which is the flow-rate used during calibration. Operating at an alternative rate could impact the instrument's response time.

For all applications, the sample gas is taken into the instrument via the **GAS IN** port located on the rear panel, from where it passes into a sample chamber. The gas flow rate is then measured on the exhaust side of the sample chamber, prior to being exhausted from the instrument via the **GAS OUT** port.

Within the sample chamber, the gas is passed over a Peltier chilled, gold-plated mirror. The instrument's internal control system maintains the drive to the Peltier heat pump to ensure, by controlling the mirror temperature, that a level of condensate is maintained on the mirror surface. The temperature of the mirror is then measured as the dew point.

After passing over the mirror, the sample gas is then typically exhausted to atmosphere via the **GAS OUT** port.

The sampling chamber is available in two different configurations; low pressure and high pressure. The low pressure version is designed to operate up to 1 barg (14.5 psig) max and the high pressure version up to 20 barg (290 psig) max. When operating in high pressure applications, a relevant gas sample line, representative of the product, would be taken and fed into the instrument. In these applications, a metering valve can be installed after the output port to maintain flow rate to within the instruments operational limits.

When the sample to be measured is at atmospheric pressure, the [optional] sample pump can be used to draw it through the instrument. Using the tube link provided, the **GAS OUT** port can be connected to the **PUMP IN** port. The flow rate can then be adjusted using the integrated metering valve. The **PUMP OUT** port then becomes the outlet.

The S8000 is suitable for the measurement of moisture content in a wide variety of clean, non-corrosive gases. It will not contaminate high purity gases and is safe for use in critical semi-conductor and fiber optic manufacturing applications.

### 3.2 Instrument Display

The S8000 features a 5.7" color touch screen display.

When the instrument is switched on an **Initialising** overlay will be shown while the menu system loads.

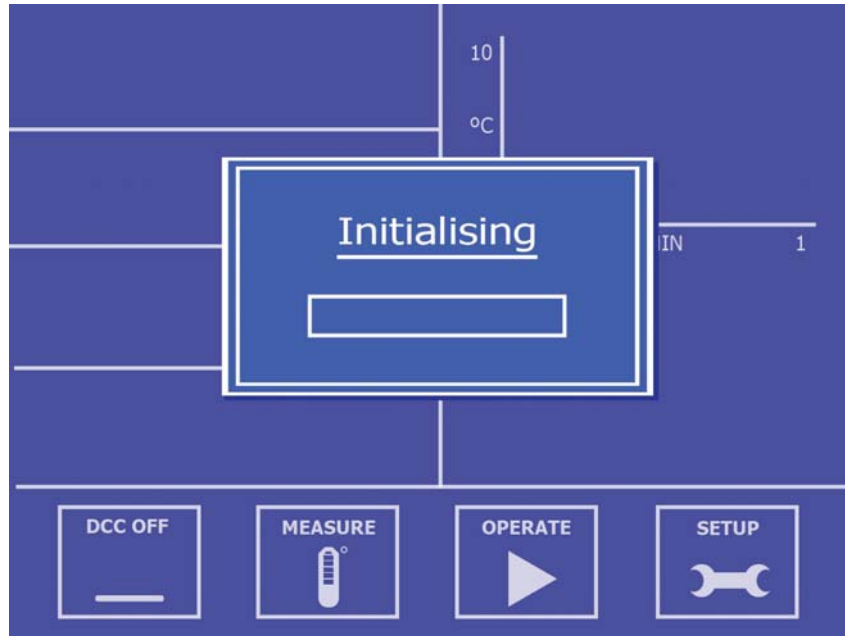

Figure 17 Initialising Overlay Screen

After the menu system has loaded, the Main Screen will show.

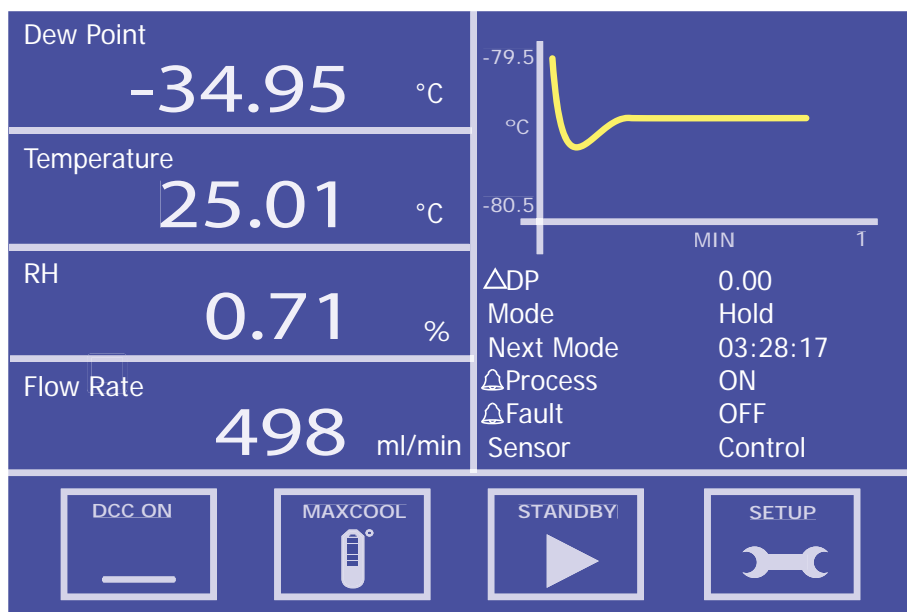

Figure 18 Main Screen



3.2.1 Main Screen

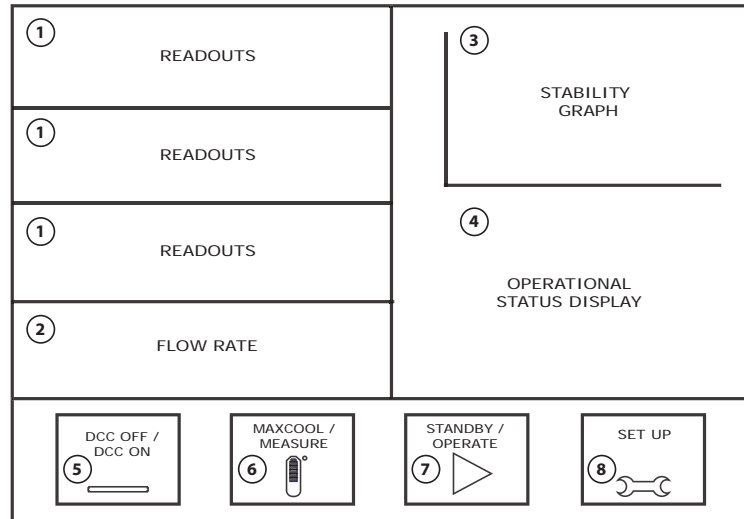

Figure 19 Main Screen Layout

No	Name	Description
1	<b>Readouts (Customizable)</b>	These readouts display measured instrument parameters. See Section 3.2.2 for additional information.
2	<b>Flow Readout</b>	Displays flow rate in chosen units.
3	<b>Stability Graph</b>	Displays a plot of the dew point over time. Touch the readout once to enter full screen mode.
4	<b>Operational Status Display</b>	A detailed description of each item displayed in this area is in Section 3.2.3.
5	<b>DCC Button</b>	Initiate a DCC cycle. See Section 3.4.1 for a detailed explanation of the DCC function. See Section 3.2.6 for DCC setup parameters.
6	<b>MAXCOOL Button</b>	Toggle <b>MAXCOOL</b> mode. See Section 3.4.2 for a detailed explanation of the <b>MAXCOOL</b> function.
7	<b>STANDBY Button</b>	Switch between <b>MEASURE</b> and <b>STANDBY</b> mode. When switching to <b>MEASURE</b> mode a DCC cycle will be initiated. See Section 3.4.6 for a detailed explanation of <b>STANDBY</b> mode.
8	<b>SETUP Button</b>	Access to the Setup Menu. See Section 3.2.4 for more information about the setup menu system.

Table 3 Main Screen Description

### 3.2.2 Customizable Readouts

The three readouts on the Main Screen can be configured by the user to show any of the following parameters:

- Dew point
- Temperature
- Temperature – Dew point
- Relative Humidity, %RH
- Water Content (ppm<sub>v</sub>; ppm<sub>w</sub>; g/Kg; g/m<sup>3</sup>)
- Pressure \*

\* Pressure is only available as an option if a pressure transducer is installed in the instrument

The parameters displayed by default are Dew point, ppm<sub>v</sub> and g/m<sup>3</sup>.

Follow these instructions to change the parameter:

1. Touch the readout once to enable parameter selection
2. Touch the left or right arrows to select the parameter to be displayed
3. Touch the center of the readout to confirm selection

#### Full Screen Mode

Any of the readouts can be shown in full screen mode by touching and holding the readout.

### 3.2.3 Operational Status Display

The Operational Status display includes the following:

	Indicates data logging is enabled. Refer to Sections 3.2.7 and 3.4.4.
<b>ADP</b>	Represents the change in dew point over the stability time of the graph.
<b>Mode</b>	Reports current operational mode. This will either be <b>MEASURE</b> , <b>STANDBY</b> , <b>DCC</b> , <b>HOLD</b> or <b>MAXCOOL</b> .
<b>Next Mode</b>	Shows the time (in Hours:Minutes:Seconds) remaining until the transition to the next mode of operation.
<b>Process</b>	This two-state, <b>ON/OFF</b> notification indicates whether a parameter process alarm is either <b>ON</b> or <b>OFF</b> . The process alarm can be set on any parameter (refer to Section 2.5.3).
<b>Fault</b>	Used to monitor the optical system and the degree of mirror contamination. During normal operation, with no fault conditions, this will read <b>OFF</b> . It will be set to <b>ON</b> if there is either a fault with the optics or dp temperature measurement or if the mirror contamination exceeds 100% of the film thickness.
<b>Sensor</b>	Indicates the operational mode of the sensor. This can be either <b>CONTROL</b> , <b>HEATING</b> or <b>COOLING</b> .

Table 4 Operational Status Display

### 3.2.4 Setup Menu Screen

The Setup Menu is used to adjust the operational parameters of the instrument, change the display setup and start or stop the data logging feature.

Initially, when the Setup Menu Screen is opened a set of labelled icons is displayed. Touching one of these icons will take you to the appropriate submenu.

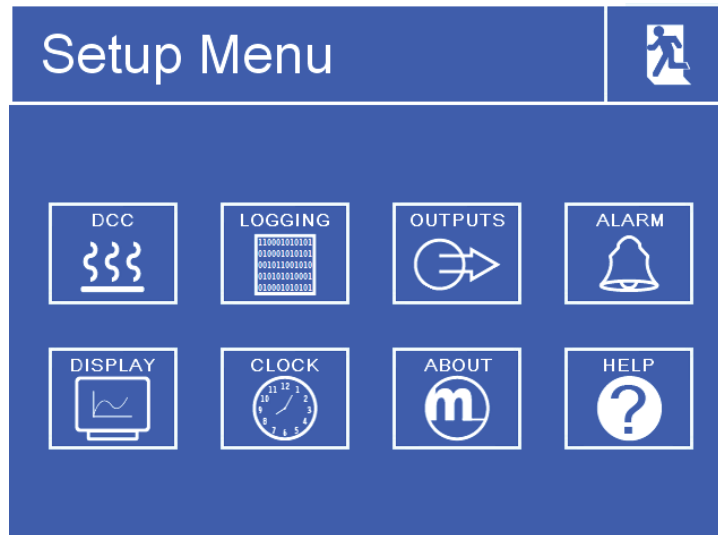

Figure 20 *Setup Menu Screen*

Once a submenu has been entered, parameters can be changed by touching the outlined values. There are three types of input for editable values:

- Toggle Button – Touching the outlined value will switch between predefined states, i.e. On/Off or Auto/manual.
- List Selection – A list of options will be displayed for the user to select.
- Numeric Input – Touching the outlined value will bring up the numeric keypad (see following page).

### Numeric Input

When entering a numeric value a virtual keypad will be displayed.

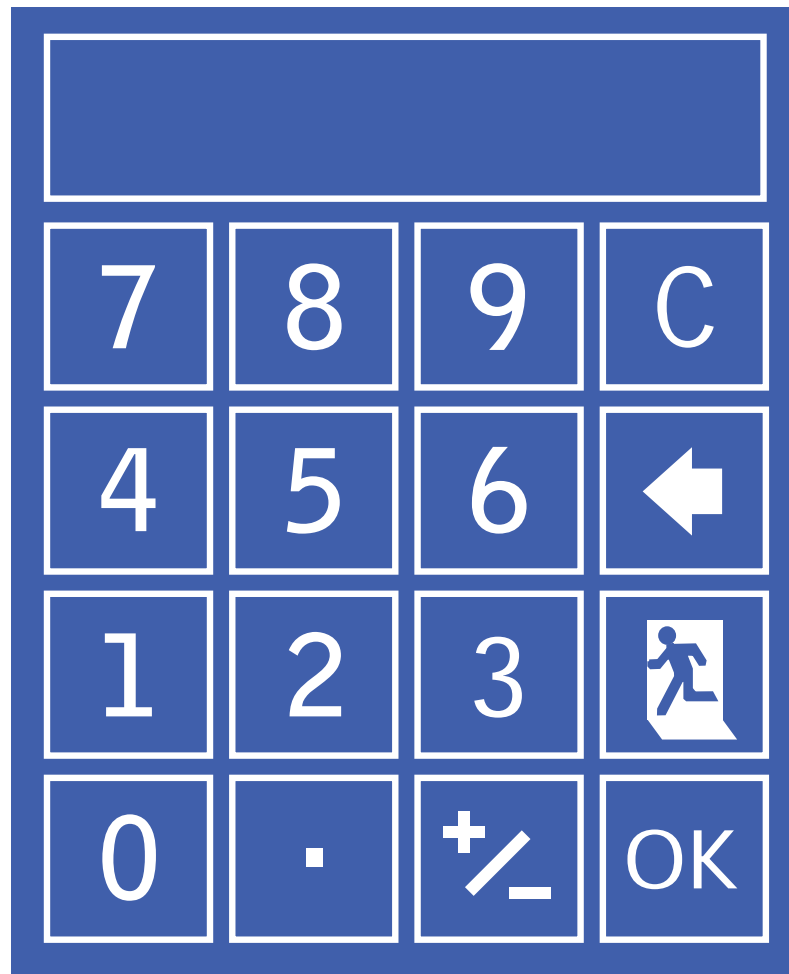







Figure 21 *Virtual Keyboard*

The allowable range will initially be shown at the top of the keypad, e.g. 0 → 50

Some parameters can be disabled by entering a value of 0, this will be indicated by 0[off] → 50

-  Clear Input
-  Backspace
-  Cancel input
-  Save input

### Leaving Menus

 To return from a menu or to cancel a numeric input, touch the exit icon.

3.2.5 Menu Structure

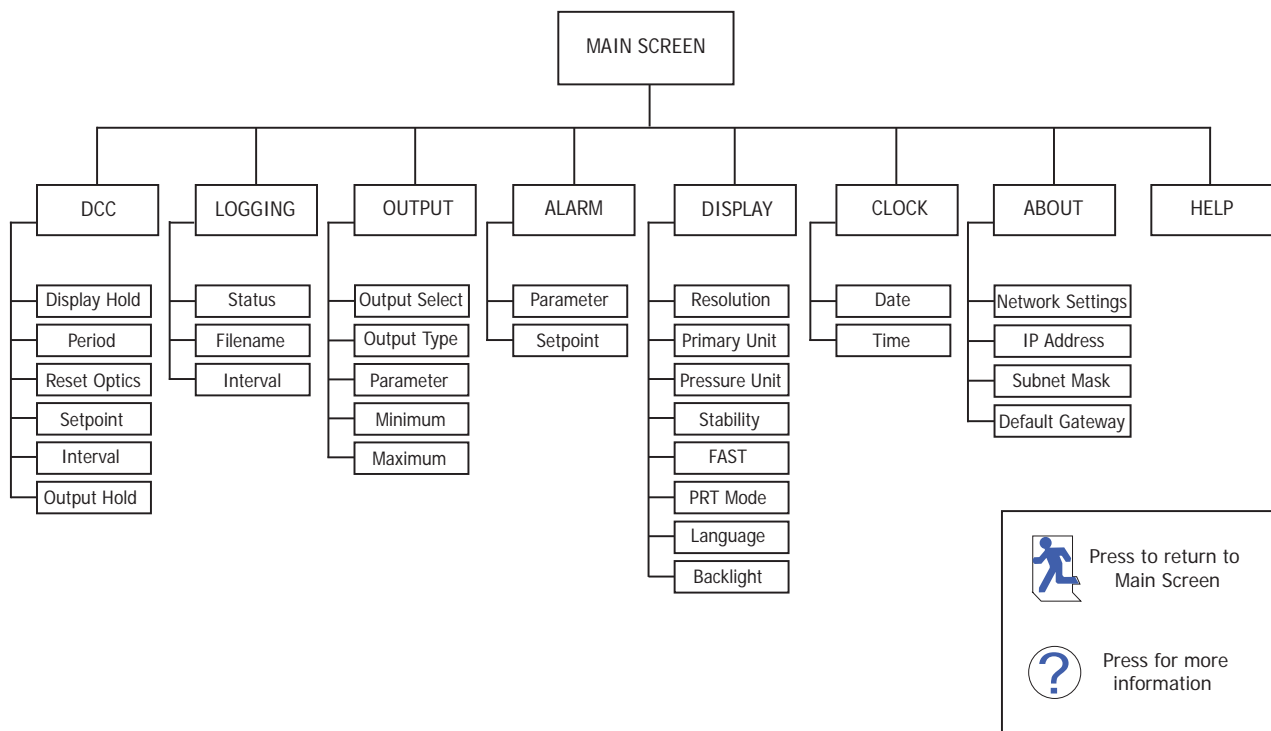

Figure 22 Menu Structure

## 3.2.6 DCC

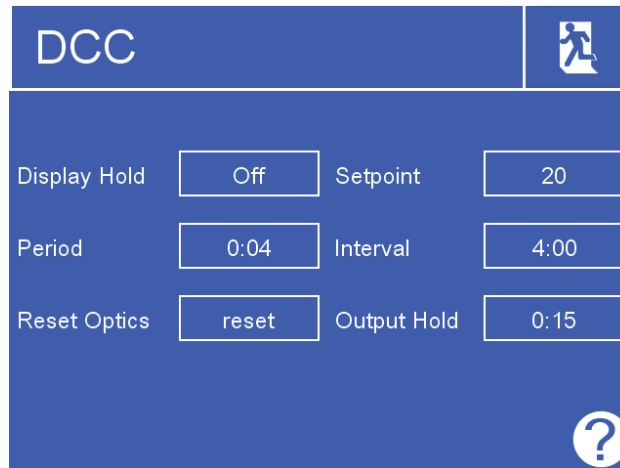

Figure 23 DCC Screen

Parameter	Description
<b>Display Hold</b>	Holds the values on the display while the instrument is in <b>HOLD</b> mode. <b>Available Input:</b> On/Off
<b>Period</b>	Duration of the DCC cycle. <b>Available Input:</b> 1 to 59 minutes
<b>Reset Optics</b>	Triggers a reset of the optical signal level on the next DCC cycle.
<b>Set point</b>	Mirror heating temperature above measured dew point during DCC cycle. <b>Available Input:</b> 10 to 40°C (50 to 104° F)
<b>Interval</b>	Time between automatic DCC cycles. <b>Available Input:</b> 1-99 hours. Set to 0 to disable automatic DCCs
<b>Output Hold</b>	Time to hold the output at the last measured value after finishing a DCC cycle. <b>Available Input:</b> 1 to 59 minutes

Table 5 DCC Parameters

## 3.2.7 LOGGING

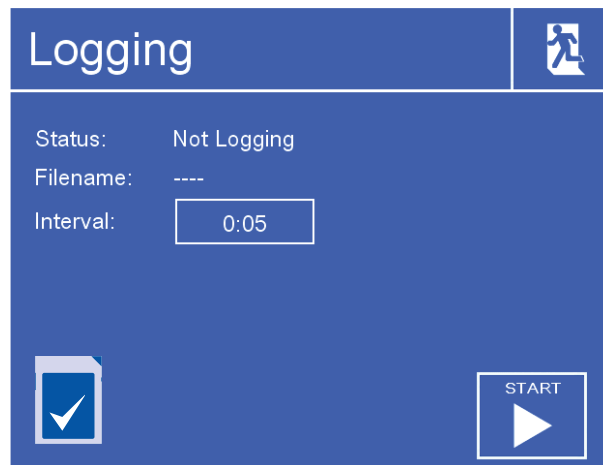

Figure 24 Logging Screen

Parameter	Description
<b>Status</b>	Displays the status of the current logging operation.
<b>Filename</b>	Displays the filename of the current log file.
<b>Interval</b>	Time in seconds between recording readings in the log file. <b>Available Input:</b> 5 to 600 seconds
<b>SD Card Icon</b>	Shows the SD card status - refer to Table 7.
<b>START/STOP Button</b>	Automatically generates a new file name based on current time and date - Starts logging at specified interval.

Table 6 Logging Parameters

The table below explains the status of the SD card. The icon is shown in the bottom left hand corner of the Logging screen.







Icon	Description
	SD Card not fitted Insert SD Card
	Initializing SD Card Wait before attempting to start logging
	SD Card ready to start logging
	SD Card locked/write protected Remove the SD Card and set the write-protect switch on the top left side of the card to the <b>UP</b> position
	SD Card is currently being written to Do not remove the SD Card or power off the instrument
	Logging in progress Do not remove the SD Card or power off the instrument
	SD Card error
	Hardware error Contact Michell Instruments' service department

Table 7 SD Card Status Indicators



3.2.8 OUTPUTS

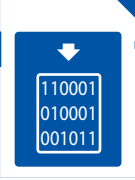
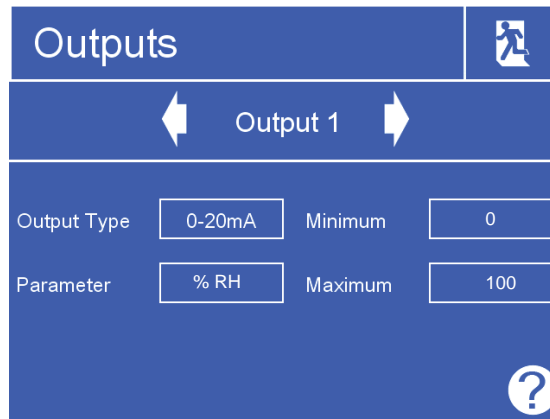

Figure 25 Outputs Screen

Parameter	Description
<b>Output Select</b>	Selects the output to be adjusted. <b>Available Input:</b> Output 1, 2 or 3
<b>Output Type</b>	Selects the type of analog output signal to use. <b>Available Input:</b> 4-20 mA/0-20 mA/0-1 V
<b>Parameter</b>	The parameter used to control the selected output. <b>Available Input:</b> g/m <sup>3</sup> , g/Kg, T-DP, DP, %RH, ppm <sub>v</sub> , ppm <sub>w</sub> , T, psig, barg, kPa, MPa, ml/min
<b>Minimum</b>	The minimum output range for the selected parameter. <b>Available Input:</b> Dependent on parameter
<b>Maximum</b>	The maximum output range for the selected parameter. <b>Available Input:</b> Dependent on parameter

Table 8 Outputs Parameters

3.2.9 ALARM



Figure 26 Alarm Screen

Parameter	Description
<b>Parameter</b>	The parameter used to control the process alarm. <b>Available Input:</b> g/m <sup>3</sup> , g/Kg, T-DP, DP, %RH, ppm <sub>v</sub> , ppm <sub>w</sub> , T, psig, barg, kPa, MPa, ml/min
<b>Set point</b>	Set point that triggers the alarm relay to activate. <b>Available Input:</b> Dependent on parameter

Table 9 Alarm Parameters

## 3.2.10 DISPLAY

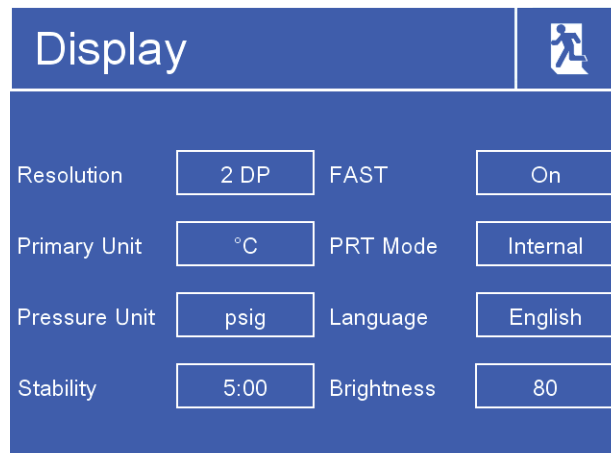

Figure 27 Display Screen

Parameter	Description
<b>Resolution</b>	Number of decimal places used when displaying parameters on the Main Screen. <b>Available Input:</b> 1, 2, 3
<b>Primary Unit</b>	Temperature unit to be used on the display and menus. <b>Available Input:</b> °C / °F
<b>Pressure Unit</b>	Pressure unit to be used on the display and menus. <b>Available Input:</b> psig, barg, kPa, MPa
<b>Stability</b>	Time scale in minutes for the Stability Graph on the Main Screen. <b>Available Input:</b> 1 to 600 minutes
<b>FAST</b>	Enables or disables the Frost Assurance System Technology. See Section 3.4.5. <b>Available Input:</b> OFF / ON
<b>PRT Mode</b>	If required for the calibration process or for external monitoring, the internal PRT (optional) can be made available for external connection via the 4 banana sockets on the back of the instrument. Please note that this will disable the internal PRT measurement circuit of the instrument. <b>Available Input:</b> INTERNAL / EXTERNAL
<b>Language</b>	Selects the language used for the menu screens. <b>Available Input:</b> English / German / Spanish / French / Italian / Portuguese / American / Russian / Chinese / Japanese
<b>Backlight</b>	The brightness of the backlight. <b>Available Input:</b> 5 to 100%

Table 10 Display Parameters

## 3.2.11 CLOCK

The screenshot shows a blue interface titled "Clock" with a person icon in the top right. The date is set to Day: 1, Month: 1, and Year: 12. The time is set to Hour: 17 and Minute: 11.

Figure 28 Clock Screen

Parameter	Description
<b>Date</b>	Current date.
<b>Time</b>	Current time.

Table 11 Clock Parameters

## 3.2.12 ABOUT (Network Settings)

When using an S8000 that is fitted with an Ethernet module this page is accessible via the About Screen.

The screenshot shows a blue interface titled "Network Settings" with a person icon in the top right. The IP Address is 192.168.1.2, the Subnet Mask is 255.255.255.0, and the Default Gateway is 192.168.1.1.

Figure 29 Network Settings Screen

Parameter	Description
<b>IP Address</b>	The IP address of the instrument.
<b>Subnet Mask</b>	The subnet mask that determines what subnet the IP address is on.
<b>Default Gateway</b>	The default gateway for network communication.

Table 12 Network Parameters

### 3.3 Operational Functions

#### 3.3.1 Operating Cycle

The default parameters set up for the instrument define an operating cycle, see *Figure 31*.

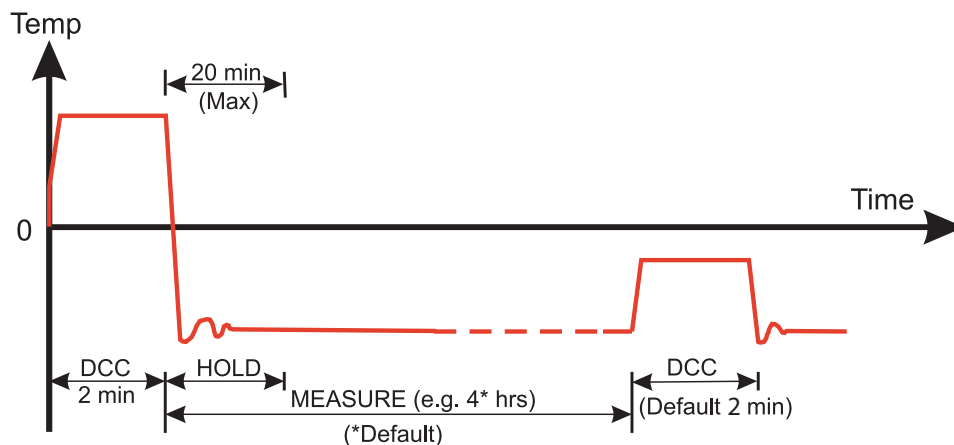

Figure 30 *Typical Operating Cycle*

At initial switch-on, the instrument enters a DCC cycle for 2 minutes. This heats the mirror to a default temperature of +20°C (+36°F) above the previously measured value - at the time of switch on this will be ambient temperature. This ensures that all moisture is driven off the surface of the mirror.

The mirror is maintained at this temperature for the DCC duration (default 2 minutes) or 2 minutes on switch-on. During the DCC process, Data Hold fixes the analog outputs at the value(s) read before DCC commenced. Data Hold typically lasts 4 minutes from the end of a DCC cycle, or until the instrument has reached the dew point. This procedure is in place to prevent any system which is connected to the outputs from receiving a 'false' reading.

After the DCC period has finished, the measurement (**MEASURE**) period commences, during which the control system decreases the mirror temperature until it reaches the dew point. The sensor will take a short amount of time to settle on the dew point. The length of this stabilization time depends upon the temperature of the dew point. When the measurement is stable the Status area of the display will indicate **CONTROL**.

The end of a DCC cycle re-sets the interval counter, meaning that another DCC will start (by default) in 4 hours time. Once the measurement is stable, **HOLD** will release, and the analog outputs will resume their normal operation. At this point the **STATUS** area of the display will change to **MEASURE**.

## 3.4 Operating Guide

### 3.4.1 DCC - Dynamic Contamination Control

Dynamic Contamination Control (**DCC**) is a system designed to compensate for the loss of measurement accuracy which results from mirror surface contamination.

During the **DCC** process the mirror is heated to a default temperature of 20°C above the dew point to remove the condensation which has formed during measurement. The surface finish of this mirror, with the contamination which remains, is used by the optics as a reference point for further measurements. This ensures the accuracy of the instrument is unaffected by any loss of reflectivity due to wear or contamination of the mirror.

After switch-on, the mirror is assumed to be clean, therefore the instrument will only run a **DCC** for 2 minutes to quickly establish a clean mirror reference point. By default, every subsequent **DCC** is 4 minutes in duration and will automatically occur every 4 hours.

At certain times it may be desirable to disable the **DCC** function in order to prevent it from interrupting a measurement cycle, e.g. during a calibration run. However, the **DCC** functionality is important to the continued accuracy and stability of the instrument and should not be permanently disabled.

A manual **DCC** can be initiated or cancelled by touching the **DCC** button on the Main Screen. The **DCC** button is context sensitive, i.e. if **DCC** is on, the Main Screen shows **DCC OFF** as being selectable. Similarly if **DCC** is off, **DCC ON** is shown.

It is possible to change the parameters relating to the **DCC** cycle on the **DCC** Setup Screen, refer to Section 3.2.6.

### 3.4.2 MAXCOOL Function

The **MAXCOOL** function over-rides the dew-point control loop and applies maximum cooling drive to the Peltier heat pump. It can be used to determine:

- the lowest temperature the mirror can be driven down to with reference to the sensor body. This temperature is indicated on the display.
- whether or not the instrument is controlling at the dew point and whether it is able to reach it. This situation could, for instance, arise when attempting to measure very low dew points where, possibly due to a high ambient temperature, the Peltier heat pump is unable to depress the mirror temperature low enough to reach the dew point.
- whether the instrument is controlling by switching **MAXCOOL** on for a short period and then switching back to **MEASURE**. This will depress the mirror temperature briefly and when it is switched back to **MEASURE** the control loop should be able to stabilize the mirror temperature at the dew point again.

The **MAXCOOL** function can be turned on by touching the **MAXCOOL** button on the Main Screen.

### 3.4.3 Pressure Compensation

As an option, the S8000 instrument can be fitted with an internal pressure sensor that measures the sample gas pressure. The pressure measured by this sensor is then used internally as the basis for compensation for all of the pressure related parameters, ppm<sub>v</sub>, ppm<sub>w</sub>, g/m<sup>3</sup> and g/Kg. If a pressure transducer is not fitted 101.3 kPa is used as the basis of all these calculations. The internal pressure transducer is ranged 0 to 25 bara (0 to 363 psia).

### 3.4.4 Data Logging

The data logging function allows all of the measured parameters to be logged at a user specified interval on the supplied SD card via the SD card slot on the front of the instrument. The filename for each log file is generated automatically from the instrument date and time.

Log files are saved in CSV (comma separated value) format. This allows them to be imported easily into Excel or other programs for charting and trend analysis. To set-up data logging refer to Section 3.2.7.

### 3.4.5 Frost Assurance System Technology (FAST)

Theoretically, it is possible for water to exist as a super-cooled liquid at temperatures down to  $-40^{\circ}\text{C}$  ( $-40^{\circ}\text{F}$ ).

A gas in equilibrium with ice is capable of supporting a greater quantity of water vapor at a given temperature than a gas in equilibrium with liquid water. This means that a measurement below  $0^{\circ}\text{C}$  taken over water will read approximately 10% lower than the same measurement taken over ice.

When turned on and **FAST** is enabled, the S8000 makes an initial dew point measurement. If the initial measurement is between  $0^{\circ}\text{C}$  and  $-40^{\circ}\text{C}$  then the mirror is driven down to below  $-40^{\circ}\text{C}$  to ensure the formation of ice on the mirror surface. The instrument then continues operation as normal – once ice has formed it will remain as ice until the temperature is raised above  $0^{\circ}\text{C}$  ( $+32^{\circ}\text{F}$ ).

If required, the instrument's **FAST** function can be switched on and off. To enable or disable the **FAST** function, refer to Section 3.2.10.

### 3.4.6 STANDBY Mode

This function is used for applications where the dew point of the sample gas changes very quickly from dry to wet, creating conditions which may cause the sensor to saturate. Alternatively it may be used in applications requiring infrequent manual measurements to be taken, where it is preferable to have the sensor disabled between measurements.

In **STANDBY** mode, drive to the Peltier heat pump is removed. While **STANDBY** mode is enabled the sensor temperature will remain constant.

The main use for this feature is during set up (when measurements are not required), i.e. when flow rates are being adjusted and the analog outputs are being configured.

## 4 APPLICATION SOFTWARE

The S8000 features Modbus over USB, RS232/485 or Ethernet, depending on which option was ordered. A copy of the application software is supplied on a CD with the instrument.

The application software is also available from the support section of the Michell Instruments' website at: <http://www.michell.com/uk/support/sware-downloads.htm>

### 4.1 Installation

1. Extract the contents of the supplied zip file to a suitable location.
2. Close all currently running Windows programs.
3. Launch the installer and follow the on-screen instructions.
4. The installer will ask for an authorization code, enter **7316-MIL1-8000**.
5. Restart the PC to complete the installation.

### 4.2 Establishing Communications

When launching the application software, the Communications Setup screen will be displayed. The following sections explain how to establish communication with the S8000, depending on whether it is fitted with a USB, RS232/485 or Ethernet module.

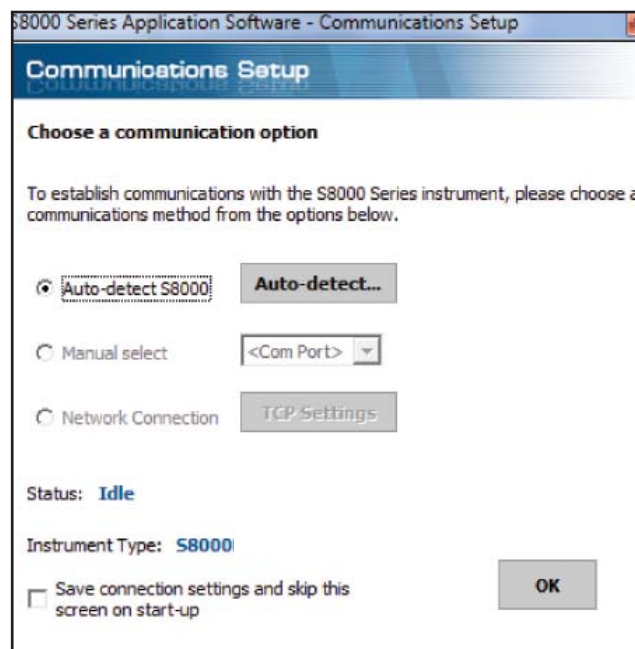

Figure 31 Communications Setup Screen



### 4.2.1 USB Communication

1. Connect the S8000 to the PC using the supplied USB cable.
2. Windows will recognize the instrument and automatically install the relevant drivers. If the driver installation has been successful then the Windows Device Manager will list the following driver (see *Figure 33*):

Michell Instruments USB to UART Bridge Controller

3. Launch the application software and choose one of the following types of connection:

**Auto Detect** – The application software will attempt to find the correct COM port automatically.

**Manual** – Choose the appropriate COM port from the drop down list, as shown in the Windows Device Manager Screen.

4. Click the **OK** button to proceed to the next screen.

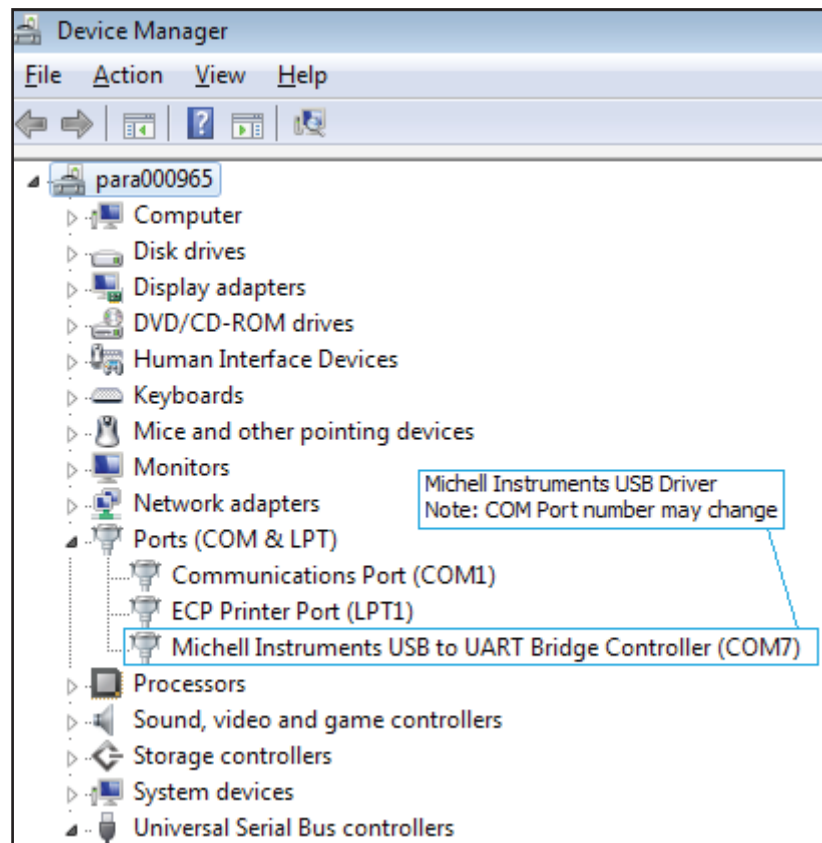

Figure 32 Windows Device Manager Screen

### 4.2.2 RS232/485 Communication

1. Connect the instrument to the PC using the supplied RS232/485 cable.
2. If an RS232/485 port is present locally on the PC, then its COM port can be identified using Windows Device Manager. If an RS232/485 to USB converter is being used, then it will be assigned its own COM port.
3. Launch the application software and choose **manual**.
4. Choose the appropriate COM port from the drop down list, as shown in the Windows Device Manager Screen.
5. Click the **OK** button to proceed to the next screen.

### 4.2.3 Ethernet Communication

1. Configure the network settings of the instrument. Refer to Section 3.2.12.
2. Connect the S8000 to the network using the supplied Ethernet cable.
3. Launch the application software and choose the Network Connection option.
4. Click the **TCP Settings** button to enter the IP address of the instrument.
5. Click the **Test** button. If communication with the instrument is successful then proceed to the next screen by clicking the **OK** button, otherwise check network settings and try again.

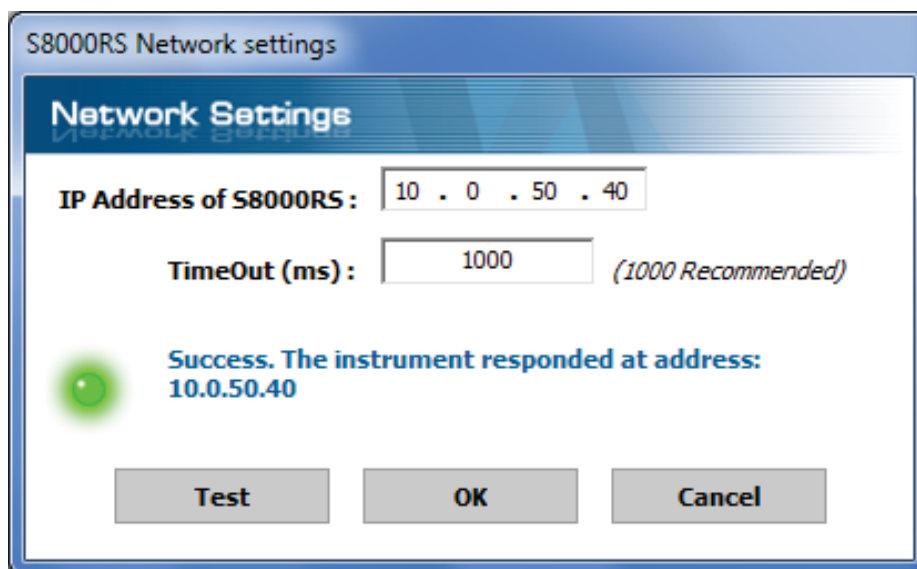

Figure 33 Network Settings Screen

### 4.3 Data Acquisition or Edit Variables Mode

Once communication has been established, the Options Screen is displayed.

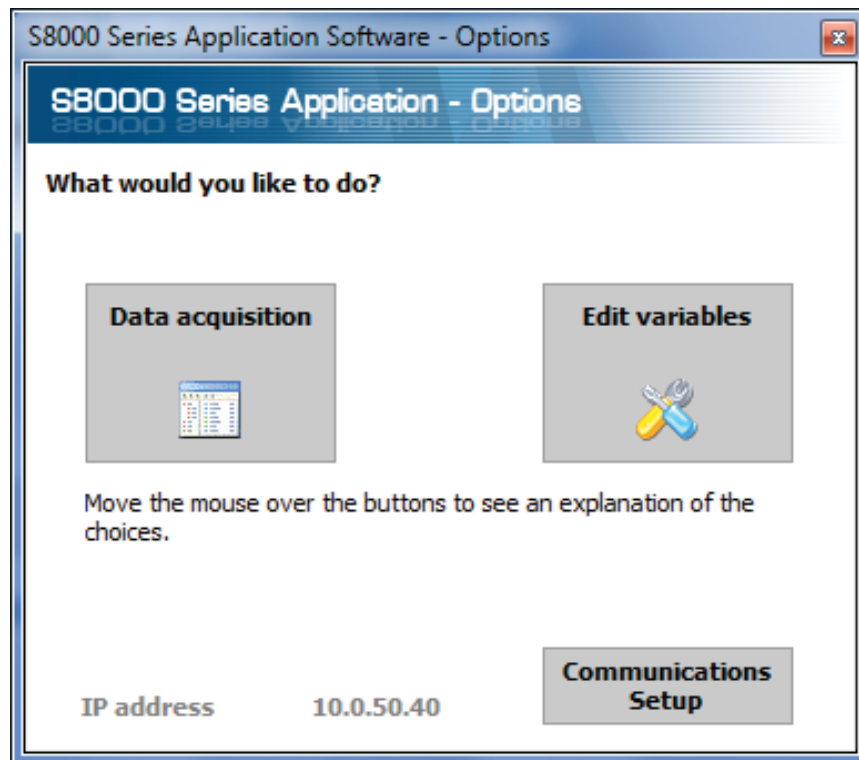

Figure 34 Options Screen

4.3.1 Data Acquisition

This mode of operation allows all measured instrument parameters to be graphed and logged in real time.

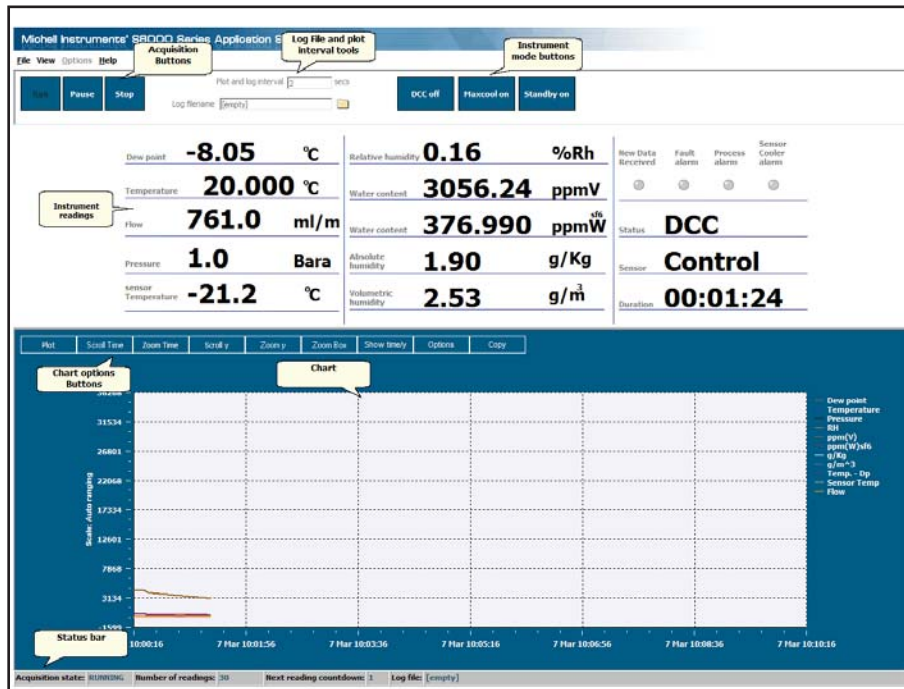

Figure 35 Data Acquisition Screen

Data Acquisition Control Toolbar

Name	Description
<b>Run</b>	Begin data acquisition and logging A filename must be first be selected to enable data logging
<b>Pause</b>	Pause data acquisition
<b>Stop</b>	Stop data acquisition
<b>Plot and log interval</b>	Time in seconds between graph and log file updates
<b>Log filename</b>	Path and filename of the log file Click the small folder icon next to this text box to create a new log file
<b>DCC</b>	Initiate a DCC cycle Refer to Section 3.4.1 for detailed information on the DCC function
<b>MAXCOOL</b>	Toggle between <b>MAXCOOL</b> and <b>MEASURE</b> mode Refer to Section 3.4.2 for detailed information on the <b>MAXCOOL</b> function
<b>STANDBY</b>	Toggles between <b>STANDBY</b> and <b>MEASURE</b> mode Refer to Section 3.4.6 for detailed information on the <b>STANDBY</b> function

Table 13 Data Acquisition Control Description

## Instrument readings and status

This area displays all measured instrument parameters and shows the status of the Fault, Process and Sensor Cooler Alarm.

### Graph Controls

Name	Description
<b>Plot</b>	Automatically advances the graph as new data is acquired
<b>Scroll Time</b>	Dragging the mouse on the graph scrolls along the time axis Drag to the left to scroll forwards Drag to the right to scroll backwards
<b>Zoom Time</b>	Dragging the mouse on the graph changes the scale of the time axis Drag to the left to increase the scale size Drag to the right to decrease the scale size
<b>Scroll Y</b>	Dragging the mouse on the graph scrolls along the Y axis Drag down to scroll up Drag up to scroll down
<b>Zoom Y</b>	Dragging the mouse on the graph changes the scale of the Y axis Drag up to increase the scale size Drag down to decrease the scale size
<b>Zoom Box</b>	Zooms in on both axes in the user selected area
<b>Show time/Y</b>	Select a parameter from the legend on the right hand side of the graph Dragging the mouse along the graph will move the vertical cursor along the time axis The Y value for the selected parameter at the position of the cursor will be displayed above the graph
<b>Options</b>	Displays the chart options window
<b>Copy</b>	Copies the chart to the clipboard as a bitmap file

Table 14 Graph Control Description

### Graph

Plots the parameters selected by the user in the chart options window.

### Status Bar

Name	Description
<b>Acquisition state</b>	Indicates whether data acquisition is running, paused or stopped, with the messages RUNNING, PAUSED or IDLE
<b>Number of readings</b>	Number of readings taken since starting the current acquisition session
<b>Next reading countdown</b>	Countdown timer (in seconds), which indicates when the next reading will be taken
<b>Log file</b>	Full path of the log file (if specified)

Table 15 Status Bar Description

### 4.3.2 Variable Edit

The variable edit mode allows the instrument configuration to be changed through the application software. On launch, it will automatically read and display the current values of each of the instrument variables.

**Note: The variables are not periodically updated on-screen. To obtain up-to-date values, click the Read button.**

#### Editing variables

To edit a variable, first click on it to highlight it.

If the variable has a fixed list of options, a drop-down arrow will appear in the right-hand column. Choose a new value from the drop-down list provided.

If the variable does not have a fixed list of options, type the new value into the right-hand column text input area.

**NOTE: The variable background colour will turn pink to indicate it has been changed on-screen and is pending upload to the instrument.**

Click the Write button to upload changed values to the instrument.

**NOTE: Variable values and formatting are checked by the application software before they are uploaded to the instrument.**

A message box will report any errors found.

Once a modified value has been written to the instrument, the background colour will return to white.

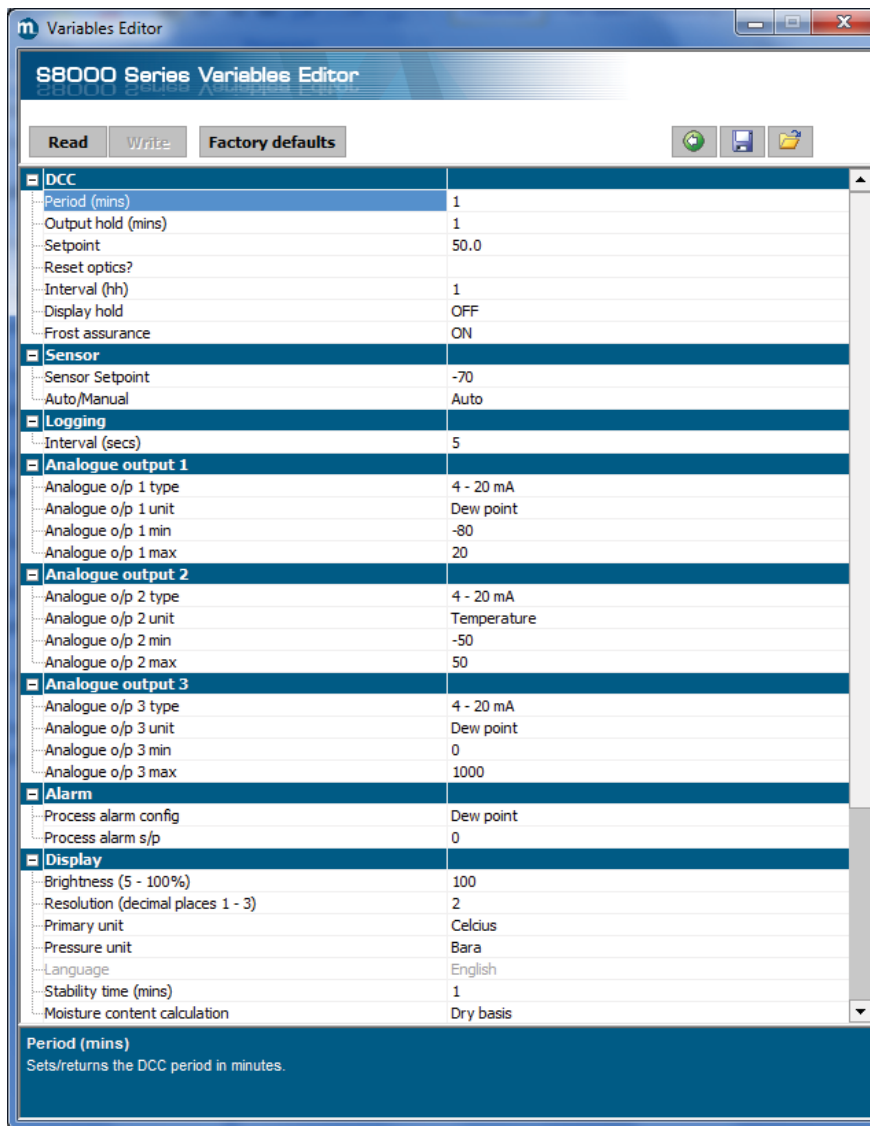

Figure 36 Variables Editor Screen

## 5 MAINTENANCE

There are no user-serviceable parts on the S8000, other than the removal and replacement of the AC power supply fuse and cleaning the mirror in the sensor.

### 5.1 Safety



**This equipment operates from power supply voltages that can be lethal and at pressures (depending upon application) that could cause injury.**

**Ensure that any test installation meets the standards described in Section 2.3 of this manual.**

**Under NO circumstances should the instrument case be removed or the air vents covered or in any way restricted.**

**Maintenance and repair, other than that described in this section, must only be carried out by trained personnel and the instrument should be returned to the manufacturer for this purpose.**



## 5.2 Fuse Replacement

If the instrument fails to operate after it has been connected to an AC power supply (85 to 264 V AC, 47/63 Hz) and switched on, proceed as follows:

1. If the power supply cable is fitted with a fused plug, switch off the power supply, remove the plug, check and, if necessary, replace the fuse. If the instrument still fails to operate, after fitting the fuse and switching the power supply on, proceed as follows (see *Figure 38*).

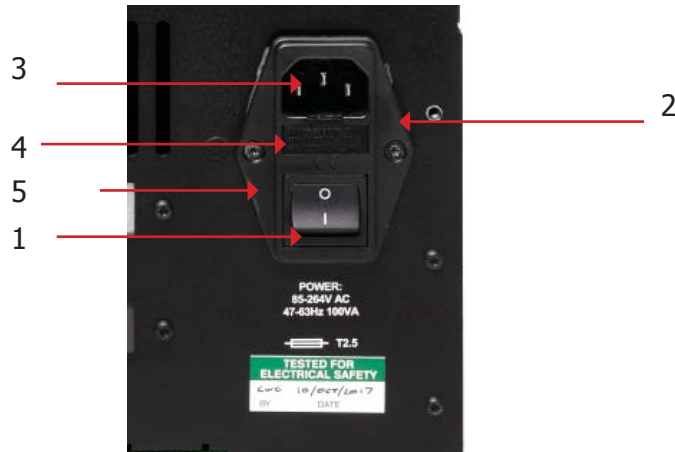

Figure 37 Power Supply Fuse Replacement

2. Switch the instrument's ON/OFF switch (1) to OFF, isolate the external power supply and remove the IEC power connector (2) from the instrument's power socket (3). **NOTE: If access to the rear of the instrument is restricted, e.g. if the instrument is a rack mounted model, it may be necessary to remove the instrument from the rack (refer to Section 2.77).**
3. Locate the fuse carrier (4) and pull it out of the connector housing (5). A small screwdriver inserted under the lip may be useful in order to lever it out.
4. Replace the fuse cartridge (6). **NOTE: It is essential that a fuse of the correct type and rating is fitted to the instrument (20mm, T-type (2.5 A anti-surge)).**
5. Fit a new fuse cartridge (6) into the fuse carrier (4) and push the fuse carrier (4) back into the power connector housing (5).
6. Push the IEC power connector (2) back into the power socket (3), turn on the external power supply and switch on the instrument (1). Check that the instrument is now operational. If the fuse blows immediately on switch-on either contact the manufacturer or their service agent. **DO NOT ATTEMPT ANY FURTHER SERVICING PROCEDURES.**

### 5.3 Sensor Mirror Cleaning

**WARNING**

**Before removing the safety strap or opening the sensor housing it is essential to vent the system to atmospheric pressure, otherwise severe injury or damage to the equipment could result.**

Throughout the life of the instrument, periodic cleaning of the mirror surface and optics window may be required. The frequency of this depends upon operating conditions and the potential in the application for contaminants to be deposited on the mirror. Sensor cleaning is mandatory if the instrument indicates an optics fault. The cleaning procedure is as follows:

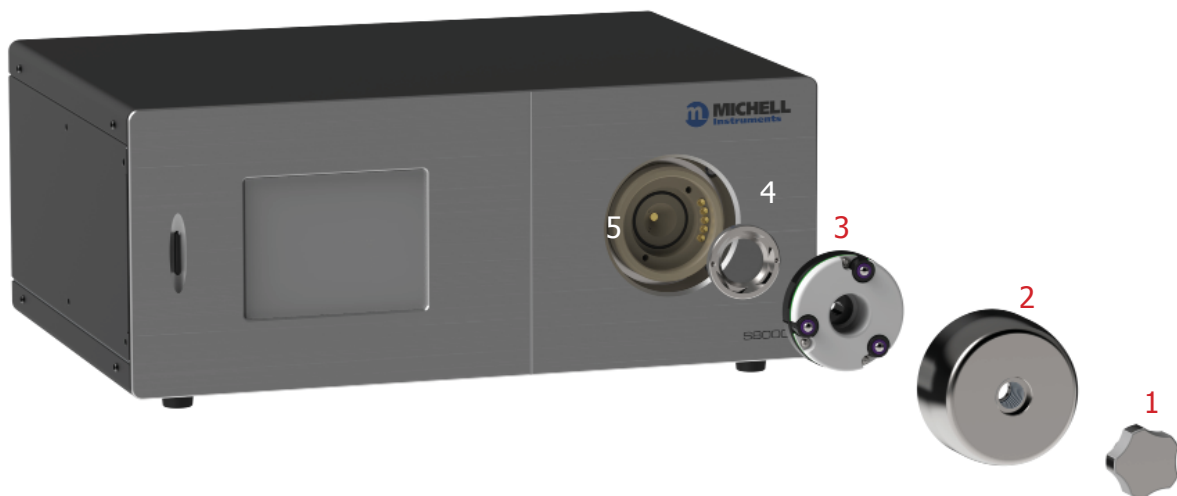

Figure 38 *Sensor Mirror Cleaning*

The cleaning procedure is as follows:

1. Switch off the instrument and unscrew the blanking plug from the stainless steel sensor cover (1) on the front of the instrument.
2. Remove unscrew the large stainless steel cover (2).
3. Carefully remove the optics block (3) to reveal the mirror window (4).
4. Insert the blanking plug (1) into the mirror window (4) to remove it.



5. Clean the mirror surface and optics window with a cotton bud/Q-Tip soaked in distilled water. If the sensor has been exposed to oil based contamination then use one of the following solvents: methanol, ethanol, or isopropyl alcohol. To avoid damage to the mirror surface do not press too firmly on the cotton bud/Q-Tip when cleaning. Allow enough time for the cleaning solvent to fully evaporate before reassembly.
6. Replace the items in the reverse order. Make sure when refitting the optics block to align the gold contacts on the block with the gold contacts on the instrument.
7. Replace the large stainless steel cover, screwing it in firmly but taking care not to overtighten it.

### 5.3.1 Releasing optics window

If the optics window is too tight to unscrew by hand (with the blanking plug) then use the Allen key supplied to loosen.



Figure 39 *Releasing Optics Window*



**WARNING**  
**Never use the Allen key to tighten the optics window as this may result in permanent damage to the instrument.**

### 5.3.2 Fitting the Microscope (Optional)

To observe the frost formation on the chilled mirror surface, an optional microscope (Part No. S8K-RS-MCI) can be provided. The microscope allows direct viewing of the mirror surface, providing assurance that ice crystals have formed and that supercooled water is not present at temperatures below 0°C.

When the instrument is controlling at a dew point, condensation is seen as small, bright red specks against a dark background. Liquid water is seen as rounded droplets and ice as sharp edged crystals.

1. Remove the blanking plug and screw the microscope unit into the sensor cap until about 6 threads remain showing.



Figure 40 *Fitting the Microscope*

2. If the instrument is not operating, switch it **ON** and rotate the microscope body until the mirror surface is brought into sharp focus. Two or three extra turns either way are usually sufficient.
3. To prevent stray light effects, always replace the blanking plug after removing the microscope.

## 6 GOOD MEASUREMENT PRACTICE

The S8000 is designed to operate in a flowing gas stream. The sampling chamber, which enables a small sample of gas to be passed over a Peltier chilled, plated copper mirror, is designed to operate at pressures up to 1 barg (14.5 psig) (low pressure version), and up to 20 barg (290 psig) max (high pressure version). For many applications, or when the internal sample pump is in use, the sample chamber operates at atmospheric pressure with the sample gas being exhausted to atmosphere.

The sensor is designed for operation with flow rates of 0.3 and 1 NI/min (0.6 and 2.1 scfh), although it will operate successfully at flow rates as low as 0.1 NI/min (0.2 scfh). It is important to ensure that the flow rate through the sample line, connecting the source to the S8000, is high enough to avoid log time lags in response to humidity changes at the sample source.

Ideally therefore, the flow rate should be set between 0.3 and 0.7 NI/min (0.6 and 2.1 scfh), 0.5 NI/min (1.06 scfh) [ $\pm 0.2$  NI/min ( $\pm 0.4$  scfh) being the recommended optimum]. For flow regulation purposes, by default, the **FRONT** page is configured to read **FLOW**. Should the **FRONT** page not be showing **FLOW**, Section 3.2.2 details the method of setting-up the instrument to display this parameter.

Unless the optional sample pump is fitted, flow regulation is not provided within the S8000 instrument. Gas flow must therefore be regulated outside the instrument, typically on the **GAS IN** side for atmospheric measurements, by means of a precision needle valve. Always use high quality valve gear, coupling connections and pipework.

Avoid pressure gradients in the system by placing excessive flow restriction on the **GAS OUT** side of the system. In applications where the test gas has a very high flow rate, an instrument by-pass arrangement is preferable to a flow restrictor after the sensor.

## 6.1 Sampling Hints

Measurement of moisture content is a complex subject, but does not need to be difficult. This section aims to explain the common mistakes made in measurement situations, the causes of the problem, and how to avoid them. Mistakes and bad practices can cause the measurement to vary from the expectation; therefore a good sampling technique is crucial for accurate and reliable results.

### Transpiration and Sampling Materials

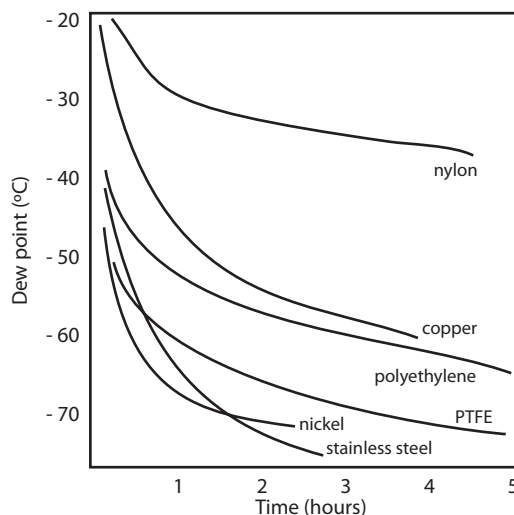

All materials are permeable to water vapor, as the water molecule is extremely small compared to the structure of solids, even when compared to the crystalline structure of metals. The graph above shows the dew point inside tubing of different materials when purged with very dry gas, where the exterior of the tubing is in the ambient environment.

Many materials contain moisture as part of their structure, particularly organic materials (natural or synthetic), salts (or anything which contains them) and anything which has small pores. It is important to ensure that the materials used are suitable for the application.

If the partial water vapor pressure exerted on the outside of a compressed air line is higher than on the inside, the atmospheric water vapor will naturally push through the porous medium causing water to migrate into the pressurized air line. This effect is called transpiration.

### Adsorption and Desorption

Adsorption is the adhesion of atoms, ions, or molecules from a gas, liquid, or dissolved solid to the surface of a material, creating a film. The rate of adsorption is increased at higher pressures and lower temperatures.

Desorption is the release of a substance from or through the surface of a material. In constant environmental conditions, an adsorbed substance will remain on a surface almost indefinitely. However, as the temperature rises, so does the likelihood of desorption occurring.

In practical terms, as the temperature of the environment fluctuates, water molecules are adsorbed and desorbed from the internal surfaces of the sample tubing, causing small fluctuations in the measured dew point.

### Sample Tubing Length

The sample point should always be as close to the critical measurement point as possible, in order to obtain a truly representative measurement. The length of the sample line to the sensor or instrument should be as short as possible. Interconnection points and valves trap moisture, so using the simplest sampling arrangement possible will reduce the time it takes for the sample system to dry out when purged with dry gas.

Over a long tubing run, water will inevitably migrate into any line, and the effects of adsorption and desorption will become more apparent. It is clear from the graph shown above that the best materials to resist transpiration are stainless steel and PTFE.

### Trapped Moisture

Dead volumes (areas which are not in a direct flow path) in sample lines, hold onto water molecules which are slowly released into the passing gas; this results in increased purge and response times, and wetter than expected readings. Hygroscopic materials in filters, valves (e.g. rubber from pressure regulators) or any other parts of the system can also trap moisture.

### Sample Conditioning

Sample conditioning is often necessary to avoid exposure of sensitive measuring components to liquids and other contaminants which may cause damage or affect the accuracy over time, depending on the measurement technology.

Particulate filters are used for removing dirt, rust, scale and any other solids that may be in a sample stream. For protection against liquids, a coalescing filter should be used. The membrane filter is a more expensive but highly effective alternative to a coalescing filter. It provides protection from liquid droplets, and can even stop flow to the analyzer completely when a large slug of liquid is encountered.

### Condensation and Leaks

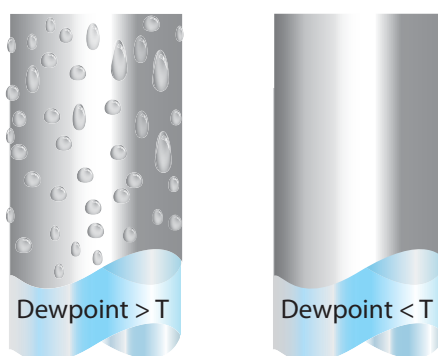

Maintaining the temperature of the sample system tubing above the dew point of the sample is vital to prevent condensation. Any condensation invalidates the sampling process as it changes the water vapor content of the gas being measured. Condensed liquid can alter the humidity elsewhere by dripping or running to other locations where it may re-evaporate.

The integrity of all connections is also an important consideration, especially when sampling low dew points at an elevated pressure. If a small leak occurs in a high pressure line, gas will leak out but vortices at the leak point and a negative vapor pressure differential will also allow water vapor to contaminate the flow.

## Flow Rates

Theoretically flow rate has no direct effect on the measured moisture content, but in practice it can have unanticipated effects on response speed and accuracy. The optimal flow rate varies depending on the measurement technology, and can always be found in the instrument or sensor manual.

An inadequate flow rate can:

- Accentuate adsorption and desorption effects on the gas passing through the sampling system.
- Allow pockets of wet gas to remain undisturbed in a complex sampling system, which will then gradually be released into the sample flow.
- Increase the chance of contamination from back diffusion: ambient air that is wetter than the sample can flow from the exhaust back into the system. A longer exhaust (sometimes called a pigtail) can also help alleviate this problem.
- Slow the response of the sensor to changes in moisture content.

An excessively high flow rate can:

- Introduce back pressure, causing slower response times and unpredictable effects on equipment such as humidity generators.
- Result in a reduction in depression capabilities in chilled mirror instruments by having a cooling effect on the mirror. This is most apparent with gases that have a high thermal conductivity such as hydrogen and helium.



**POSSIBLE INJURY! The tubing, valves and other apparatus attached to this instrument must be adequate for the maximum pressure which will be applied, otherwise physical injury to the operator or bystander is possible.**



**Before disconnecting the S8000 from the gas line it is essential to vent the system to atmospheric pressure, otherwise severe injury could result.**



## 7 CALIBRATION

### 7.1 Traceability

The calibration of this instrument is traceable to national standards. For this reason the instrument can only be calibrated in an accredited e.g. NIST or UKAS accredited, standards laboratory.

If these facilities do not exist, the instrument must be returned to the manufacturer, Michell Instruments, or an approved agent (for contact information go to [www.michell.com](http://www.michell.com)).

If required for the calibration process, the instrument's internal PRT can be made available for external connection as described in Section 3.2.10.

The DCC function can be disabled for calibration purposes (refer to Section 3.2.6).

A calibration certificate bearing a three point calibration is issued with each instrument. If required, an option is available to add further specific calibration points. Contact Michell Instruments for further information (for contact information go to [www.michell.com](http://www.michell.com)).

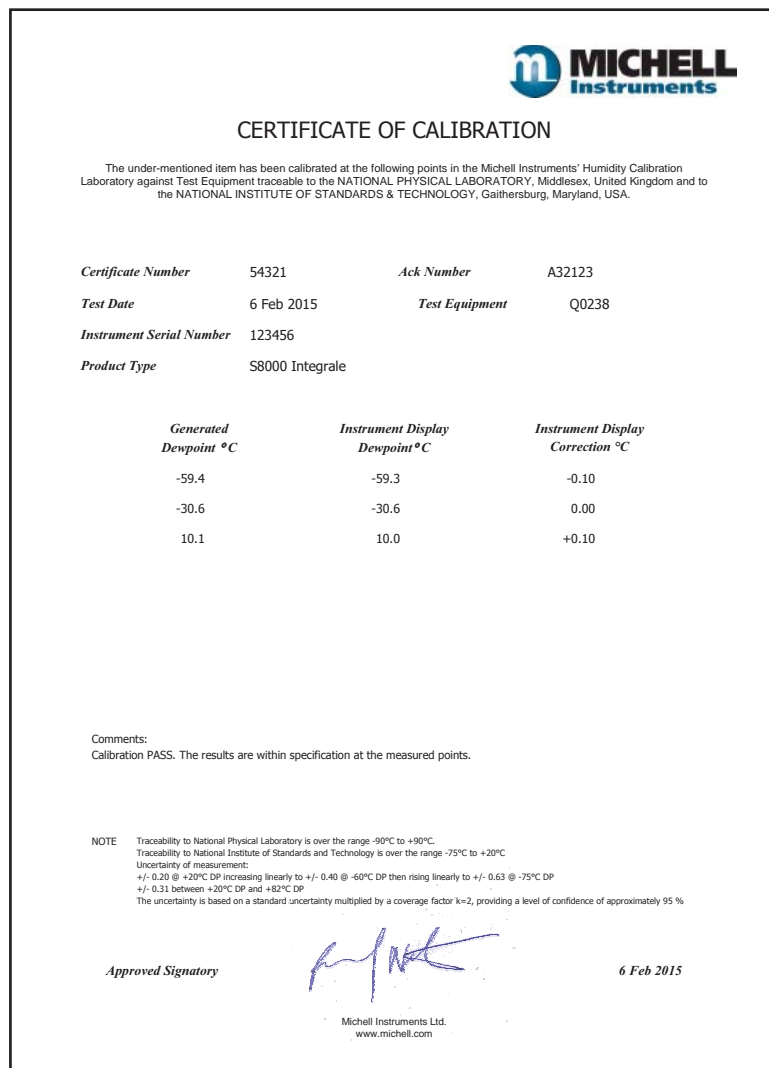

Figure 41 Typical Calibration Certificate

8 PREPARATION FOR SHIPPING

For shipping purposes, the instrument should be packed into its original carton, the latter providing the recommended degree of protection during transit. To prepare the instrument for shipping, proceed as follows.

1. Switch off the instrument and remove the power supply cable (see Section 2.5.1). If the instrument is rack mounted, first remove it from the rack, and remove the rack mount wings.
2. Remove the (optional) microscope and re-fit the blanking plug.
3. Remove the (optional) remote PRT (see Section 2.5.4).
4. If fitted, remove the USB communications cable (see Section 2.5.6).
5. Remove the analog and alarm output connectors (see Section 2.5.2 and Section 2.5.3).
6. Remove any connections to the 4-wire PRT output binding posts (see Section 2.5.5).
7. Remove the connections to the **GAS IN** and **GAS OUT** ports (see Section 2.5.99).
8. Pack the instrument in its original case as shown in *Figure 41*. **NOTE: The accessories should be packed in the box (4). Unless returning for repair, it is not necessary to return either the microscope or the analog and alarm connectors. All cables and the remote PRT probe (if supplied) should be returned for checking.**
9. Enclose a packing list detailing all equipment contained in the box and seal the box. Ideally, for extra security, the box should be banded.

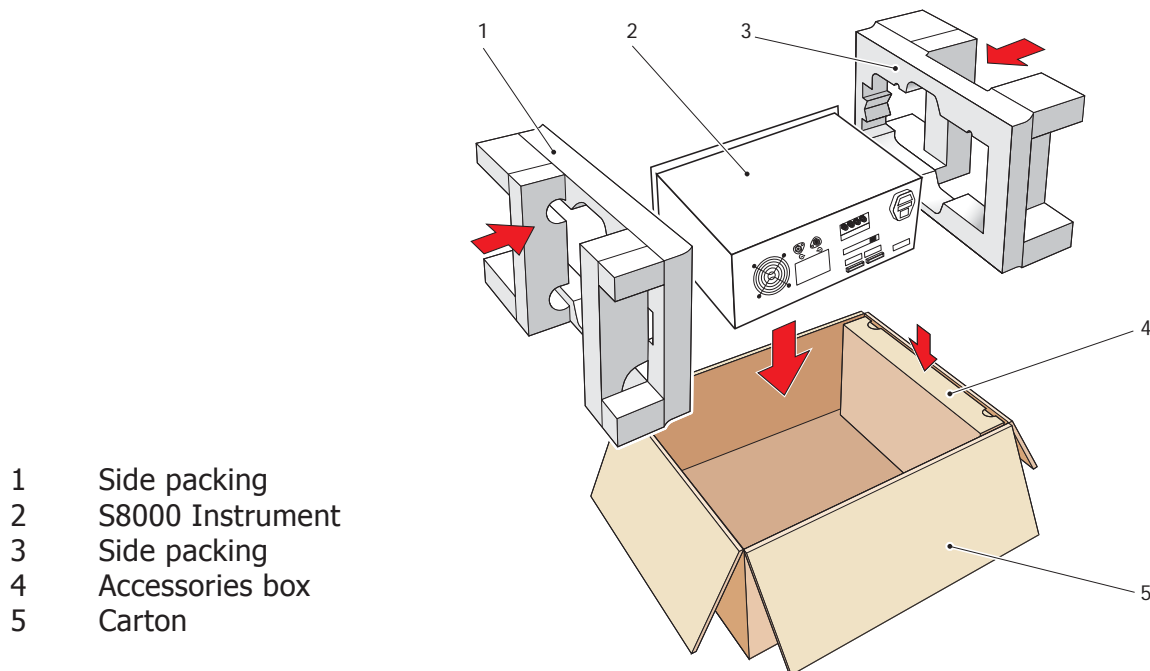
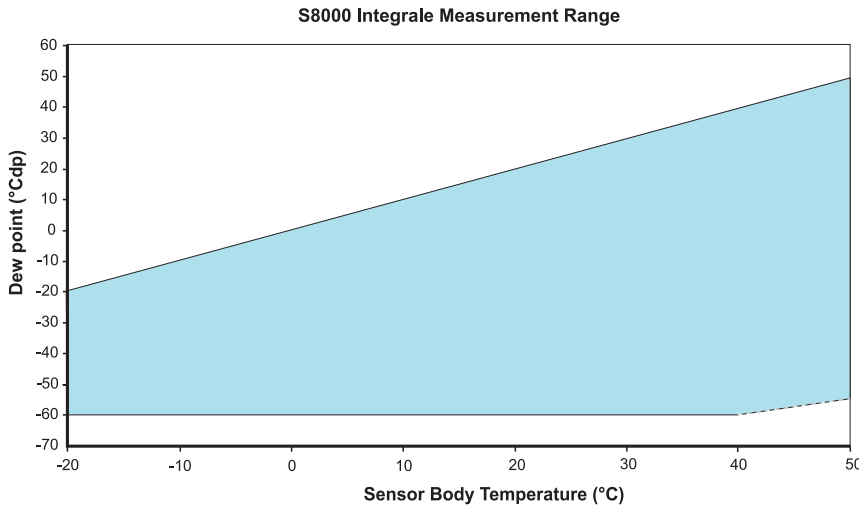

Figure 42 Instrument Packing Details

# Appendix A

## Technical Specifications

Appendix A Technical Specifications

<b>Dew-Point Sensor Performance</b>	
Measurement Technology	Chilled Mirror
Accuracy	±0.1 °C (±0.18 °F)
Reproducibility	±0.05°C (±0.09°F)
Measurement Range	-60 to +40°Cdp (-76 to +104 °Fdp) 
Operating Temperature Range	-20 to +40°C (-4 to +104 °F)
Operating Pressure	Low Pressure Version: 0 to 1 barg (0 to 14.5 psig) High Pressure Version: 0 to 20 barg (0 to 290 psig)
Sample Flow Rate	0.1 to 1 NI/min (0.2 to 2.1 scfh)
Detection System	RRS Triple Detection
<b>Remote PRT Probe (Optional)</b>	
Temperature Measurement	4 wire Pt 100, 1/10 DIN class B
Measurement Accuracy	±0.1 °C (±0.18 °F)
Cable Length	2m (6.6ft) (250m (820ft) max)
<b>Flow Sensor</b>	
Measurement Accuracy	Typical ±5% uncalibrated
Measurement Range	0 to 1000 ml/min
<b>Integrated Pressure Sensor (Optional)</b>	
Measurement Range	0 to 25 bara (0 to 377 psia)
Measurement Accuracy	0.25% Full Scale
Measurement Units	psia, bara, KPa or MPag

<b>Monitor</b>	
Resolution	User-selectable to 0.001 dependant on parameter
Measurement Units	°C and °F for dew point and temperature %RH, g/m <sup>3</sup> , g/kg, ppm <sub>v</sub> , ppm <sub>w</sub> (SF <sub>6</sub> ), for calculated humidities
Outputs	<b>Analog:</b> 3 channels, user-selectable 4-20 mA, 0-20 mA or 0-1 V <b>Digital:</b> Modbus RTU over USB, and optional Modbus RTU over RS232, RS485 or Modbus TCP over Ethernet <b>Alarm:</b> Two volt free changeover contacts, one process alarm, one fault alarm; 1 A @ 30 V DC
HMI	5.7" LCD touchscreen with white on blue graphics
Data Logging	SD Card (512 Mb supplied) and USB interface SD Card (FAT-32) - 32Gb max. that allows 24 million logs or 560 days, logging at 2 second intervals
Environmental Conditions	-20 to +40°C (-4 to +104° F)
Power Supply	85 to 264 V AC, 47/63 Hz
Power Consumption	100 VA
EMC - Class A Emissions Industrial Location Immunity	Complies with EN61236:1997 (+A1/A2/A3)
<b>Mechanical Specifications</b>	
Dimensions	184 x 440 x 343mm (7.3 x 19 x 14.5") h x w x d
Weight	11.4kg (25.1lb)
<b>General</b>	
Process connections	6mm Swagelok® (MALE) or 1/4" Swagelok® (MALE)
Storage Temperature	-40 to +50°C (-40 to +122 °F)
Calibration	3-point traceable in-house calibration as standard UKAS accredited calibrations optional - please consult Michell

A.1 Dimensions

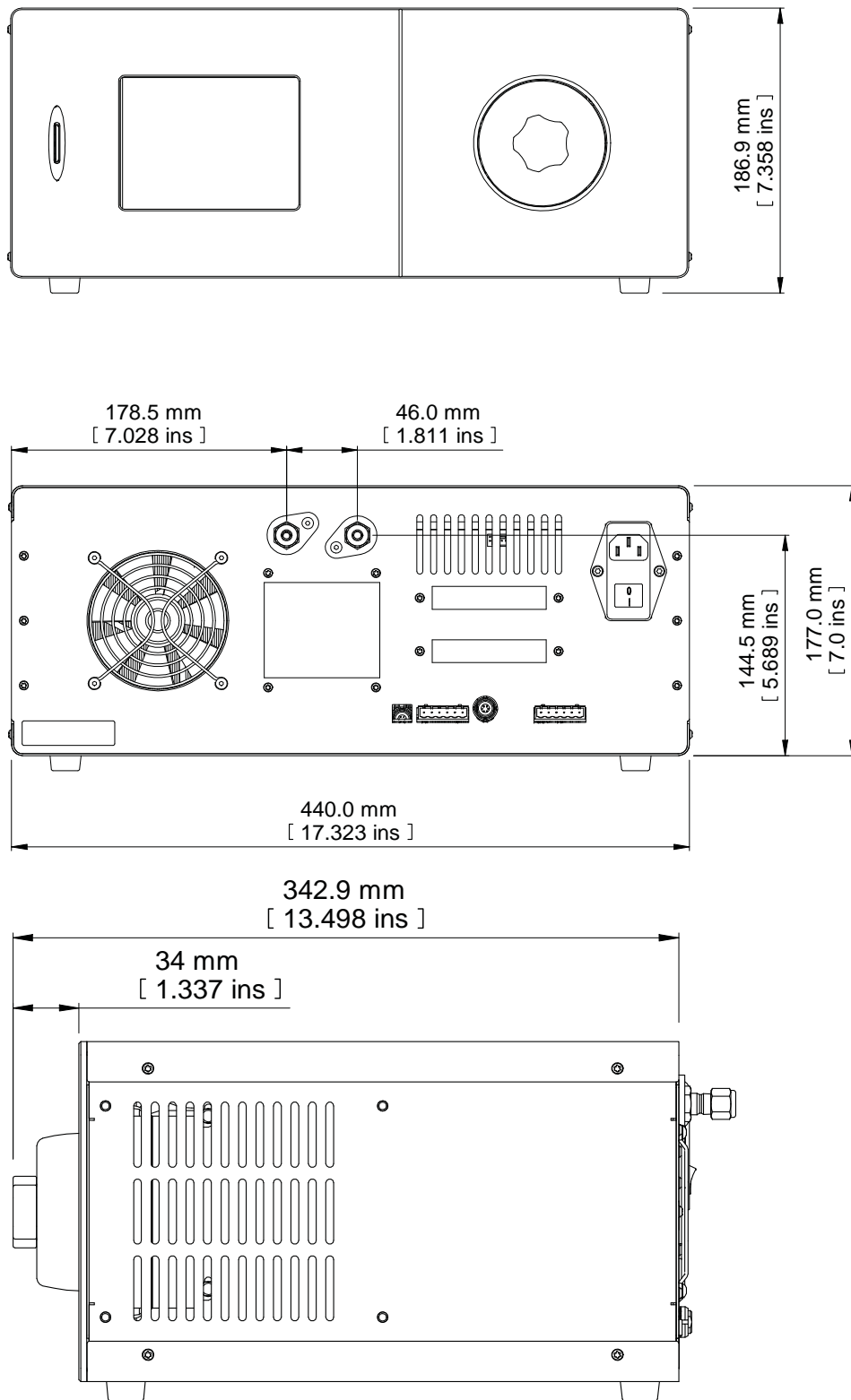

# Appendix B

## Formatting SD Cards

## Appendix B Formatting SD cards

Before an SD card can be used for the storage of datalog results it must first be formatted. Initially the card must be connected to a card reader which must, in turn, be connected to the host computer. Most proprietary card readers connect to the host via a USB port. Almost all laptop/notebook PC's are equipped with an SD card reader slot.

The formatting procedure is as follows:

1. Insert the card into the card reader and open Windows Explorer. The card will be reported as Removable storage device.
2. Right click on the card icon and select **Format** from the pop-up menu (refer to *Figure 42*).
3. The **Format** dialogue box is now presented as shown in *Figure 43*, and the disk capacity is reported on the top line (1). This will depend upon the type of disk used (470 MB in this example).
4. In the **File system** box (2), *Figure 43*, select **FAT32**.
5. In the **Allocation unit size** box (3), leave this set to Default allocation size.
6. If required, in the **Volume label** box (4), enter a volume label e.g. S8000.
7. The SD card requires a full format so leave the **Quick format** box (5) unchecked.
8. Click the **Start** button (6). The message (*Figure 44*) will now appear. Click **OK** to proceed.

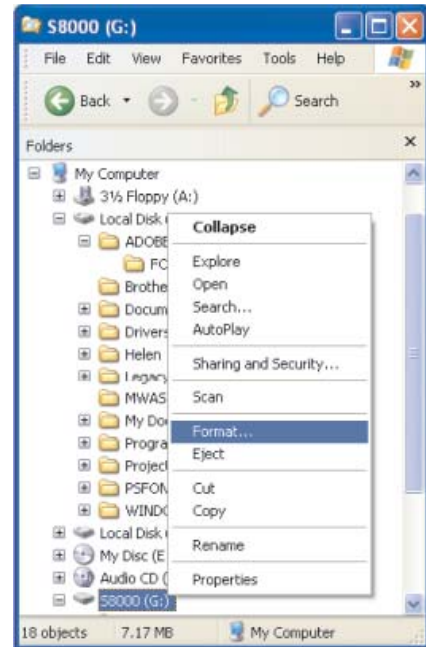

Figure 43 Select Format

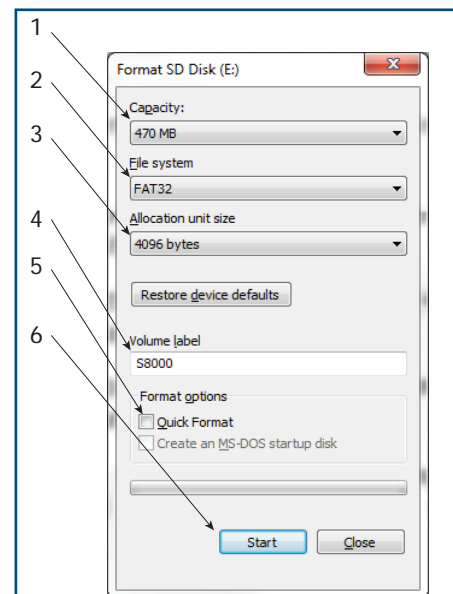

Figure 44 Set Format Properties



Figure 45 Format Disc



# Appendix C

## Calculations

## Appendix C Calculations

### C.1 Water Content

The accuracy of the humidity calculations was determined by comparing the displayed value to corresponding values calculated from the formulae below, using a PRT simulator to set a dew-point value and the Michell Humidity Calculator to calculate the water vapor pressure (wvp).

$$\begin{aligned} \text{ppm}_v (\text{dry}) &= (\text{wvp}/(101325-\text{wvp}) * 10^6 \\ \text{ppm}_v (\text{wet}) &= (\text{wvp}/101325) * 10^6 \\ \text{ppm}_w \text{ SF}_6 (\text{wet \& dry}) &= \text{ppm}_v * 0.12334954 \\ \text{g/kg} &= \text{ppm}_v * 0.0006212138 \\ \text{g/m}^3 &= (217/(273.15 + Dp)) * (\text{wvp}/100) \end{aligned}$$

**Note:**  $\text{ppm}_v$  can be calculated on a dry or wet basis depending upon bit 10 in the units command register, which can be set via the Application software.

### C.2 Temperature - Dew Point

PRT simulators are used to simulate the dew-point and ambient temperature sensors. For each pair of temperature readings the instrument display is read and the actual t-dp readings recorded. Each of these readings is then compared against calculated t-dp, readings using the same input parameters to the Michell Humidity Calculator.

### C.3 °C to °F Calculation

PRT simulators are used to input simulated temperatures, measured in °C, into both measurement channels.

For each measurement channel, the corresponding display is set to read the input temperature in °F. For each channel the temperature reading on the instrument display, corresponding to the series of simulated PRT inputs, is read and recorded. Each of these readings is then compared against a corresponding temperature calculated from the following formula.

$$\text{Conversion formula. } ^\circ\text{F} = ((^\circ\text{C}*9)/5) + 32$$

### C.4 % RH Calculation

PRT simulators are used to input simulated dew-point and ambient temperatures, measured in °C, into both measurement channels.

For each pair of inputs, the reading on the instrument's % RH display is recorded. Each of these readings is then compared against a corresponding % RH value calculated by inputting the same parameters to the Michell Humidity Calculator.

**C.5 Conversion of bara to psia and kPa**

Use a calibrated 4-20 mA source (Q0356) to simulate a range of applied pressures covering the instruments' full pressure measurement span of 0 to 25 bara (0 to 377 psia) (1.56 bar/mA).

For each input current, record the display reading for all three units.

For each display reading, calculate the corresponding pressure in the relevant units from the following formula.

$$\text{Psia} = ((\text{bara}-1)*14.5) + 14.7$$

$$\text{Kpa} = \text{bara}*100$$

# Appendix D

## Modbus

**Appendix D Modbus RTU Communications**

**D.1 Introduction**

S8000 instruments have a Modbus communications interface via the USB port that enables remote access to the instrument’s configuration and data logging facilities. This protocol offers two-way communication between a host (PC), (known as the master unit), and one or more instruments, (known as slave units).

Once communication is established by the master unit, reading or writing to holding registers within an addressed slave unit is possible. The master unit can obtain measured values and status information by reading registers and can respond to data contained within these registers by writing back.

The tables in this Appendix list these registers, as they apply to the S8000 instrument, and specify the number and data formats that apply to each register.

**D.2 Basic Modbus Operation**

There are two possible Modbus transmission modes - ASCII and RTU (Remote Terminal Unit). The S8000 instrument is classed as an RTU.

Communication between a host system (e.g. PC) operates on a Query-Response Cycle (see *Figure 45*), where a specific Modbus function code, embedded in the query message, tells the addressed slave device what actions to perform using the information contained in the data bytes.

An error checkfield provides a method for the slave to validate the integrity of the message contents. If the slave makes a normal response, the function code in the response is an echo of the function code in the query and the data bytes will contain data collected by the slave e.g. holding register values or status information. If an error occurs, the function code is incremented by 80H (most significant bit set to 1) to indicate that the response is an error response, and the associated data bytes contain a code to define the error.

The error check field, CRC (Cyclic Redundancy Check), allows the master to confirm that the message contents are valid.

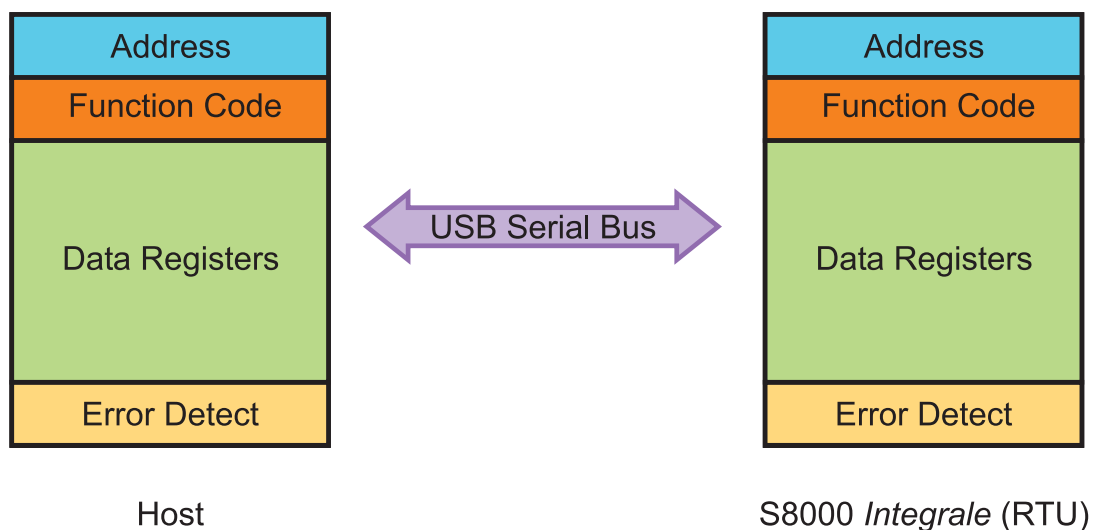

Figure 46 Modbus Connection

### D.3 Modbus RTU Connections and Protocol

The physical connection from the master to the S8000 uses a USB connection cable between the host and the instrument's communications connector. Refer to Section 2.5.6 for details of the connection of this cable.

The serial port protocol is as follows:

Baud Rate: 9600  
 Start Bits: 1  
 Data bits: 8  
 Parity: None  
 Stop bits: 2

Typically, a Modbus RTU message is structured as follows:

Byte 1	Slave Address	Value 1-247
Byte 2	Modbus Function Code	Value 3 (e.g read register)
Byte 3	Start Address (Low byte)	Value 0 - 255
Byte 4	Start Address (High byte)	Value 0 - 255
Byte 5	No. Registers to read (Low byte)	Value 0 - 255
Byte 6	No. Registers to read (Low byte)	Value 0 - 255
Byte 7	Error Check Value	

### D.4 Register Map

All the data values relating to the S8000 are stored in holding registers. Each of these registers is two bytes (16-bits wide). Some of these registers contain instrument specific values e.g. its own unique system address, emitter drive values etc. and others are used to hold specific real time data e.g. measured dew-point temperature.

Each Modbus message has a two part address code, one for the low byte (bits 0 through 7) and one for the high byte (bits 8 through 15). The facility exists for multiple registers, specified by a high and low byte contained in the query message, to be addressed and read by the same message.

Table 16 describes the instruments' registers with their respective address locations, together with their relevant register configurations and register map definitions. **NOTE: Hexadecimal (Hex) addresses marked with an asterisk denote instrument specific parameters stored in the instrument's flash memory.**

The register maps, Tables 17 to 29, define the data allocated to each bit/byte of that specific register.

Address dec	Address hex	Function	Read/Write	Default Value Hex	Register Config.	Register Map Definition
0	0000*	Instrument Address	R/W	0001H	H	INSTID
1	0001	Dew point Value – Hi Word	R		N	HUMIDITY_HI
2	0002	Dew point Value – Lo Word	R		N	HUMIDITY_LO
3	0003	Ambient Temperature – Hi Word	R		N	AMBTMP_HI
4	0004	Ambient Temperature – Lo Word	R		N	AMBTMP_LO
5	0005	RH	R		A	RH
6	0006	Pressure Value	R		J	PRESSURE
7	0007	PpmV – Hi Word	R		N	PPMV_HI
8	0008	PpmV – Lo Word	R		N	PPMV_LO
9	0009	PpmW(sf6) – Hi Word	R		N	PPMWSF_HI
10	000A	PpmW(sf6) – Lo Word	R		N	PPMWSF_LO
11	000B	g/m3 - Hi Word	R		N	GM3_HI
12	000C	g/m3 - Lo Word	R		N	GM3_LO
13	000D	g/kg – Hi Word	R		N	GKG_HI
14	000E	g/Kg – Lo Word	R		N	GKG_LO
15	000F	Flow Value	R		H	FLOW_RATE
16	0010	Mirror Condition	R		J	MIRROR_COND
17	0011	Heat Pump Drive	R		H	HP_DRIVE
18	0012	Status	R		D	STATUS
19	0013*	DCC duration + Hold Time Duration minutes	R/W		K	DCC_HOLD_TIME
20	0014*	Measurement Time Hours + Minutes	R/W		K	MEASURE_TIME
21	0015*	Phase Time Hours	R		H	PHASE_TIME_HRS
22	0016	Phase Time Minutes + Phase Time Seconds	R		K	PHASE_TIME_MIN_SEC
23	0017*	Film thickness setting	R/W		A	FILM_THICKNESS
24	0018	Live film thickness value	R		A	LIVE_FILM_THICKNESS
25	0019*	Analog 1 output maximum value	R/W		M	MAX_MA1
26	001A*	Analog 1 output minimum value	R/W		M	MIN_MA1
27	001B*	Analog 2 output maximum value	R/W		M	MAX_MA2
28	001C*	Analog 2 output minimum value	R/W		M	MIN_MA2
29	001D*	Analog 3 output maximum value	R/W		M	MAX_MA3
30	001E*	Analog 3 output minimum	R/W		M	MIN_MA3
31	001F*	Analog output configuration 1	R/W		B1	OP_SELECTION1
32	0020*	Analog output configuration 2	R/W		B2	OP_SELECTION2
33	0021*	Logging Interval	R/W		H	LOG_INTERVAL
34	0022*	Units/ Command	R/W		E	UNITSCOMMAND
35	0023*	Mirror Temp Set-Point during DCC	R/W		M	MIRROR_TEMP_SETP
36	0024*	Emitter Drive	R/W		H	EMITTERDRIVE
37	0025	Stability Time	R/W		H	STABILITY_TIME
38	0026	RTC Year(val1) + Month (val2)	R/W		K	YEARMONTH
39	0027	RTC Date (val1) + Hours(val2)	R/W		K	DATEHRS
40	0028	RTC Mins(val1) + Secs (val2)	R/W		K	MINSSECS
41	0029*	Display Setting 1	R/W		F	DISPLAY_SETTING1
42	002A*	Display Setting 2	R/W		F	DISPLAY_SETTING2
43	002B	N/A				
44	002C	N/A				
45	002D	N/A				
46	002E	Filename DDMM or MMDD	R		L	FILENAME_DDMM
47	002F	Filename HHMM	R		L	FILENAME_HHMM
48	0030*	Firmware Version Number	R		A	FIRM_VER
49	0031*	N/A				
50	0032*	N/A				
51	0033*	N/A				
52	0034*	Process Alarm Configuration / Display Contrast	R/W		P	ALARMCONFIG_DISPCONT
53	0035*	Process Alarm Set Point	R/W		M	PROCESSALARM_SP_HI

Table 16 Modbus Holding Register Map

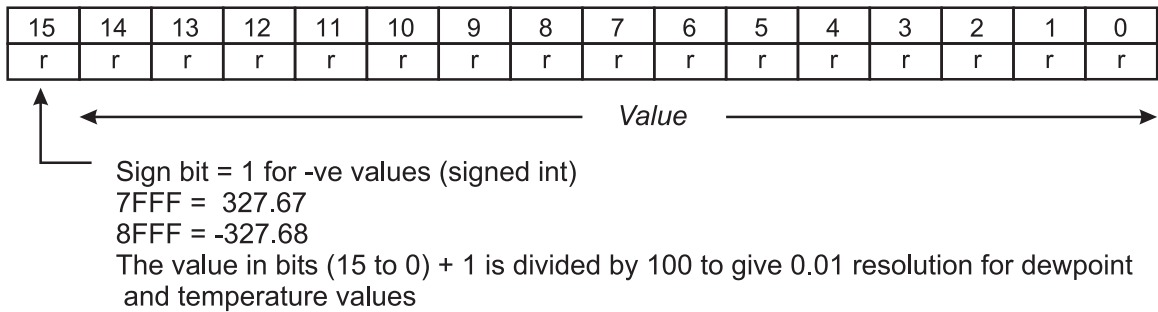

Table 17 Register Configuration A

Analogue O/P 2								Analogue O/P 1							
r/w	r/w	r/w	r/w	r/w	r/w	r/w	r/w	r/w	r/w	r/w	r/w	r/w	r/w	r/w	r/w
DP = 00000000 Temp = 00000001 ppm(v) = 00000010 ppm(w) sf6 = 00000011 g/kg = 00000100 g/m <sup>3</sup> = 00000101 pressure = 00000110 flow = 00000111 rh = 00001000 temp difference = 00001001								DP = 00000000 Temp = 00000001 ppm(v) = 00000010 ppm(w) sf6 = 00000011 g/kg = 00000100 g/m <sup>3</sup> = 00000101 pressure = 00000110 flow = 00000111 rh = 00001000 temp difference = 00001001							

Table 18 Register Configuration B1

								Analogue O/P 3											
r/w	r/w	r/w	r/w	r/w	r/w	r/w	r/w	r/w	r/w	r/w	r/w	r/w	r/w	r/w	r/w				
<b>Analogue O/P 3</b> 00 = 0 - 20mA 01 = 4 - 20mA 10 = 0 - 1V				<b>Analogue O/P 2</b> 00 = 0 - 20mA 01 = 4 - 20mA 10 = 0 - 1V				<b>Analogue O/P 1</b> 00 = 0 - 20mA 01 = 4 - 20mA 10 = 0 - 1V				DP = 00000000 Temp = 00000001 ppm(v) = 00000010 ppm(w) sf6 = 00000011 g/kg = 00000100 g/m <sup>3</sup> = 00000101 pressure = 00000110 flow = 00000111 rh = 00001000 temp difference = 00001001							

Table 19 Register Configuration B2



15	14	13	12	11	10	9	8	7	6	5	4	3	2	1	0
r/w	r/w	r/w	r/w	r	r	r	r	r/w	r/w	r	r	r	r	r	r
1 = Optics Reset	1 = Display Hold	1 = Max Cool Initiate	1 = DCC Initiate	1 = Start Logging 0 = Stop Logging	1 = FAST (Frost Assurance)	1 = Fault Alarm	1 = Humidity Alarm	1 = External PRT	1 = Initiate Standby	In Control = 00H Heating = 01H Cooling = 10H	Measurement = 0000H DCC = 0001H Data Hold = 0010H Max Cool = 0100H Standby = 1000H				

Table 20 Register Configuration D Status Word

15	14	13	12	11	10	9	8	7	6	5	4	3	2	1	0
r/w	r/w	r/w	r/w	r/w	r/w	r/w	r/w	r/w	r/w	r/w	r/w	r/w	r/w	r/w	r/w
<b>Language</b> English = 0000 Chinese = 1111				Reset Defaults	1 = FAST Enable	1 DP = 00H 2 DP = 01H 3 DP = 10H	N/A	N/A	Psig = 00H Barg = 01H kPa = 10H	Measurement = 0000H DCC = 0001H Data Hold = 0010H Max Cool = 0100H Standby = 1000H					

Table 21 Register Configuration E Units

15	14	13	12	11	10	9	8	7	6	5	4	3	2	1	0
Display 2								Display 1							
r/w	r/w	r/w	r/w	r/w	r/w	r/w	r/w	r/w	r/w	r/w	r/w	r/w	r/w	r/w	r/w
DP = 00000000 Temp = 00000001 ppm(v) = 00000010 ppm(w) sf6 = 00000011 g/kg = 00000100 g/m <sup>3</sup> = 00000101 pressure = 00000110 flow = 00000111 rh = 00001000 temp difference = 00001001								DP = 00000000 Temp = 00000001 ppm(v) = 00000010 ppm(w) sf6 = 00000011 g/kg = 00000100 g/m <sup>3</sup> = 00000101 pressure = 00000110 flow = 00000111 rh = 00001000 temp difference = 00001001							

Table 22 Register Configuration F Display Setting A

15	14	13	12	11	10	9	8	7	6	5	4	3	2	1	0
<b>Main Value to Log</b>								<b>Display 3</b>							
r/w	r/w	r/w	r/w	r/w	r/w	r/w	r/w	r/w	r/w	r/w	r/w	r/w	r/w	r/w	r/w
<p>DP, Temp, Press and Flow are logged by default</p> <p>ppm(v) = 00000010                      ppm(w) sf6 = 00000011                      g/kg = 00000100                      g/m<sup>3</sup> = 00000101                      pressure = 00000110                      flow = 00000111                      rh = 00001000                      temp difference = 00001001</p>								<p>DP = 00000000                      Temp = 00000001                      ppm(v) = 00000010                      ppm(w) sf6 = 00000011                      g/kg = 00000100                      g/m<sup>3</sup> = 00000101                      pressure = 00000110                      flow = 00000111                      rh = 00001000                      temp difference = 00001001</p>							

Table 23 Register Configuration F Display Setting B

15	14	13	12	11	10	9	8	7	6	5	4	3	2	1	0
r/w	r/w	r/w	r/w	r/w	r/w	r/w	r/w	r/w	r/w	r/w	r/w	r/w	r/w	r/w	r/w

Unsigned Integer range 65535

Table 24 Register Configuration H

15	14	13	12	11	10	9	8	7	6	5	4	3	2	1	0
r	r	r	r	r	r	r	r	r	r	r	r	r	r	r	r

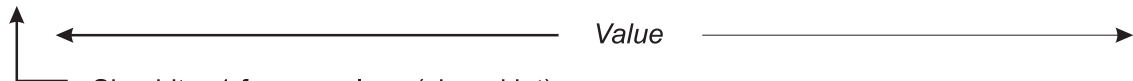

Sign bit = 1 for -ve values (signed int)  
 7FFF = 3276.7  
 8FFF = -3276.8  
 The value in bits (15 to 0) + 1 is divided by 10 to give 0.1 resolution for dewpoint and temperature values

Table 25 Register Configuration J

15	14	13	12	11	10	9	8	7	6	5	4	3	2	1	0
r/w	r/w	r/w	r/w	r/w	r/w	r/w	r/w	r/w	r/w	r/w	r/w	r/w	r/w	r/w	r/w



Val1 & 2 are in BCD, therefore 10H = 10, 58H = 58 and 09H = 9, so as a result, A to F are not valid values

Table 26 Register Configuration K

15	14	13	12	11	10	9	8	7	6	5	4	3	2	1	0
r/w	r/w	r/w	r/w	r/w	r/w	r/w	r/w	r/w	r/w	r/w	r/w	r/w	r/w	r/w	r/w



Values in HEX i.e. 17th March = 11H for Val1 and 03H for Val 2.

Table 27 Register Configuration L

15	14	13	12	11	10	9	8	7	6	5	4	3	2	1	0
r	r	r	r	r	r	r	r	r	r	r	r	r	r	r	r

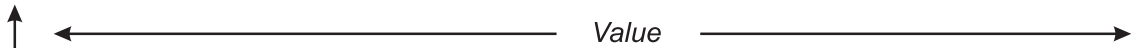

Sign bit = 1 for -ve values (signed int)  
 7FFF = 32767  
 8FFF = -32768

Table 28 Register Configuration M

The humidity values for sensors 1 & 2 are represented in IEEE-754 single precision floating point format, in order to cater for the wide range in the value of ppm<sub>v</sub>. This format is 'Big Ended' which means that the high byte is at a lower address in memory than the Lo byte, and is represented as such in the register memory map. The IEEE-754 format is shown below.

<b>Bit 31</b> Sign bit 0 = + 1 = -	<b>Bits 30 to 23</b> Exponent Field Has +127 bias value	<b>Bits 22 to 0</b> Mantissa Decimal representation of binary, where 1.0 ≤ value < 2.0
---	---	--

Table 29 Register Configuration N

15	14	13	12	11	10	9	8	7	6	5	4	3	2	1	0
Process Alarm Configuration								Display Contrast							
r/w	r/w	r/w	r/w	r/w	r/w	r/w	r/w	r/w	r/w	r/w	r/w	r/w	r/w	r/w	r/w
DP = 00000000 Temp = 00000001 ppm(v) = 00000010 ppm(w) sf6 = 00000011 g/kg = 00000100 g/m <sup>3</sup> = 00000101 pressure = 00000110 flow = 00000111 rh = 00001000 temp difference = 00001001								0 - 255							

Table 30 Register Configuration P

# Appendix E

## Default Values

## Appendix E Default Values

The default values for the HMI Settings are as follows:

### Main Page

Top	Dew point
Middle	ppm <sub>v</sub>
Bottom	g/m <sup>3</sup>
Flow	Fixed

### Outputs

1	4-20 mA, dew point, -60 to +20 °C
2	4-20 mA, ppm <sub>v</sub> , 0 to 3000
3	4-20 mA, flow, 0 to 1000 ml

<b>Alarm</b>	0°Cdp
--------------	-------

### Display

Resolution	2 decimal places
Primary Unit	°C
Pressure unit	bara
Stability	0:01
FAST	ON
PRT Mode	Internal
Language	English
Brightness	100

### DCC

Display Hold	OFF
Period	0:02
Reset Optics	reset
Set point	Δ 20°C
Interval	4:00
Output Hold	0:20

<b>Logging Interval</b>	0:05
-------------------------	------

# Appendix F

## Quality, Recycling & Warranty Information

## Appendix F      Quality, Recycling & Warranty Information

Michell Instruments is dedicated to complying to all relevant legislation and directives. Full information can be found on our website at:

**[www.michell.com/compliance](http://www.michell.com/compliance)**

This page contains information on the following directives:

- ATEX Directive
- Calibration Facilities
- Conflict Minerals
- FCC Statement
- Manufacturing Quality
- Modern Slavery Statement
- Pressure Equipment Directive
- REACH
- RoHS2
- WEEE2
- Recycling Policy
- Warranty and Returns

This information is also available in PDF format.



# Appendix G

## Return Document & Decontamination Declaration

Appendix G Return Document & Decontamination Declaration

**Decontamination Certificate**

**IMPORTANT NOTE:** Please complete this form prior to this instrument, or any components, leaving your site and being returned to us, or, where applicable, prior to any work being carried out by a Michell engineer at your site.

Instrument			Serial Number	
Warranty Repair?	YES	NO	Original PO #	
Company Name			Contact Name	
Address				
Telephone #			E-mail address	
Reason for Return /Description of Fault:				
Has this equipment been exposed (internally or externally) to any of the following? Please circle (YES/NO) as applicable and provide details below				
Biohazards			YES	NO
Biological agents			YES	NO
Hazardous chemicals			YES	NO
Radioactive substances			YES	NO
Other hazards			YES	NO
Please provide details of any hazardous materials used with this equipment as indicated above (use continuation sheet if necessary)				
Your method of cleaning/decontamination				
Has the equipment been cleaned and decontaminated?			YES	NOT NECESSARY
Michell Instruments will not accept instruments that have been exposed to toxins, radio-activity or bio-hazardous materials. For most applications involving solvents, acidic, basic, flammable or toxic gases a simple purge with dry gas (dew point <-30°C) over 24 hours should be sufficient to decontaminate the unit prior to return. <b>Work will not be carried out on any unit that does not have a completed decontamination declaration.</b>				
<b>Decontamination Declaration</b>				
I declare that the information above is true and complete to the best of my knowledge, and it is safe for Michell personnel to service or repair the returned instrument.				
Name (Print)			Position	
Signature			Date	



F0121, Issue 2, December 2011

Manufacturer: **Michell Instruments Limited**  
**48 Lancaster Way Business Park**  
**Ely, Cambridgeshire**  
**CB6 3NW. UK.**



On behalf of the above named company, I declare that, on the date that the equipment accompanied by this declaration is placed on the market, the equipment conforms with all technical and regulatory requirements of the directives. The product:

## S8000 Chilled Mirror Hygrometer

complies with all the essential requirements of the EU directives listed below.

**2014/30/EU EMC Directive**  
**2014/35/EU Low Voltage Directive (LVD)**  
**2011/65/EU Restriction of Hazardous Substances Directive (RoHS2)**

and has been designed to be in conformance with the relevant sections of the following standards or other normative documents.

EN61326-1:2013 Electrical equipment for measurement, control and laboratory use – EMC requirements –Class A (emissions) and Industrial Locations (immunity).

EN61010-1:2010 Safety Requirements for Electrical Equipment for Measurement, Control, and Laboratory Use - Part 1: General Requirements

### **2014/68/EU PE Directive**

This product and sample systems & accessories that may be supplied with it do not bear CE marking for the Pressure Equipment Directive, and are supplied in accordance with Article 4, paragraph 3 of 2014/68/EU by using SEP (sound engineering practice) in the design and manufacturer and are provided with adequate instructions for use.



---

Mr. Mike Bannister, Managing Director  
Ely UK

August 2018



<http://www.michell.com>