

## High-Speed Pressure Controller

# CPC3000

mentor





**Warning**

**This Warning symbol indicates that danger of injury for persons and the environment and/or considerable material damage (mortal danger, danger of injury) will occur if the respective safety precautions are not taken.**



**Caution**

**This Caution symbol indicates danger for the system and material if the respective safety precautions are not taken.**



**Notice**

**This Notice symbol does not indicate safety notices but information for a better understanding of the facts.**

# Table of Contents

<b>1. General information</b>	<b>7</b>
1.1 Warranty	7
1.2 Important notice	7
1.3 FCC radio frequency emission notice	8
1.4 European radio frequency emission notice	8
1.5 Trademarks and copyrights	8
1.6 Software license agreement	8
1.7 Accreditations	9
1.8 Packaging for shipment	9
<b>2. Safety notices</b>	<b>9</b>
2.1 User responsibilities	9
2.2 General safety notices	10
2.3 Warnings and caution notices	10
<b>3. Product description</b>	<b>13</b>
3.1 Proper use	13
3.2 Features	14
3.3 Turning on the CPC3000	15
3.4 Front panel	15
3.5 Main menu	16
3.5.1 Keys, tabs, check boxes, labels/graphics	16
3.6 Front panel navigation and variations	17
3.6.1 Operating mode	17
3.7 Main menu setpoint entry options	19
<b>4. Specifications</b>	<b>21</b>
<b>5. Installation</b>	<b>23</b>
5.1 Introduction	23
5.2 Unpacking the system	23
5.3 Mounting (Rack mount kit option)	23
5.4 Installation	24
5.5 Rear panel	25
5.6 Pressure connections	25
5.7 Function of pressure connections	26
5.8 Electrical connections	27
5.8.1 Connecting the power supply and turning on the instrument	27
5.8.2 Connecting the communications interfaces	27

<b>6. Starting operation</b>	<b>29</b>
<b>7. Local operation</b>	<b>31</b>
7.1 Setting the operating language	31
7.2 Display configuration	31
7.3 Setpoint entry	33
7.4 Operating modes	36
7.5 Data entry	39
7.6 Pressure unit, pressure mode and emulation mode	39
7.7 Bar chart	40
7.8 Setup menus	40
7.8.1 Setup display	41
7.8.2 Setup control	42
7.8.3 Setup remote	43
7.8.4 Setup info	44
7.8.5 Setup service	45
7.8.5.1 Zero (non-password protected)	45
7.8.5.2 Unlock setup for calibration and regulator adjustment	46
7.8.5.3 Change Password	47
7.8.5.4 Calibrate sensor or optional barometer	48
7.8.5.4.1 Calibration data	49
7.8.5.4.2 Edit calibration	50
7.8.5.4.3 Live calibration	51
<b>8. Remote Operation</b>	<b>52</b>
8.1 Remote setup	52
8.2 Remote setup - Ethernet	52
8.3 Remote setup - USB	53
8.4 Remote setup - IEEE-488	53
8.5 Remote command set	54
8.5.1 Mensor command set	54
8.5.2 PCS 400 commands emulated	61
8.5.3 PCS 200 commands emulated	63
8.5.4 DPI 510 commands emulated	64
8.5.5 IEEE 488.2 commands	65
8.5.6 SCPI commands	66
8.5.7 Output Formats	68
<b>9. Trouble-shooting measures</b>	<b>69</b>

9.1 Table: fault description and measures	69
<b>10. Re-calibrating and servicing</b>	<b>71</b>
<b>11. Removal of the system</b>	<b>72</b>
<b>12. Transport of the system</b>	<b>73</b>
<b>13. Storage of the system</b>	<b>74</b>
<b>14. Placing out of service</b>	<b>75</b>
<b>15. Appendix</b>	<b>76</b>
Sales and service international	77
Measurement units	81
Conversion factors, pascal	82

**NOTES**

## 1. General information

### 1.1 Warranty

All products manufactured by Mensor are warranted to be free of defects in workmanship and materials for a period of one year from the date of shipment. No other express warranty is given, and no affirmation of Seller, by words or actions, shall constitute a warranty. SELLER DISCLAIMS ANY IMPLIED WARRANTIES OF MERCHANTABILITY OR FITNESS FOR ANY PARTICULAR PURPOSES WHATSOEVER. If any defect in workmanship or material should develop under conditions of normal use and service within the warranty period, repairs will be made at no charge to the original purchaser, upon delivery of the product(s) to the factory, shipping charges prepaid. If inspection by Mensor or its authorized representative reveals that the product was damaged by accident, alteration, misuse, abuse, faulty installation or other causes beyond the control of Mensor, this warranty does not apply. The judgment of Mensor will be final as to all matters concerning condition of the product, the cause and nature of a defect, and the necessity or manner of repair. Service, repairs or disassembly of the product in any manner, performed without specific factory permission, voids this warranty.

MENSOR MAKES NO WARRANTY OF ANY KIND WITH REGARD TO THIS MANUAL, INCLUDING, BUT NOT LIMITED TO, THE IMPLIED WARRANTIES OF MERCHANTABILITY AND FITNESS FOR A PARTICULAR PURPOSE. Mensor shall not be liable for errors contained herein or for incidental or consequential damages in connection with the furnishing, performance, or use of this material.

### 1.2 Important notice

Since product improvement is a continuous process at Mensor, we reserve the right to change specifications and other information contained in this manual without notice.

Mensor has made a concerted effort to provide complete and current information for the proper use of the equipment. If there are questions regarding this manual or the proper use of the equipment, contact either Mensor or WIKA:

Mensor  
201 Barnes Drive  
San Marcos, Tx 78666

TEL: 1.512.396.4200  
1.800.984.4200 (USA only)  
WEB SITE: [www.mensor.com](http://www.mensor.com)  
FAX: 1.512.396.1820  
E-MAIL: [sales@mensor.com](mailto:sales@mensor.com)  
[tech.support@mensor.com](mailto:tech.support@mensor.com)  
[quality@mensor.com](mailto:quality@mensor.com)

WIKA Alexander Wiegand SE & Co. KG  
Alexander-Wiegand-Straße 30  
D-63911 Klingenberg / Germany

TEL: (+49) 93 72/132-9986  
WEB SITE: [www.wika.de](http://www.wika.de)  
FAX: (+49) 93 72/132-8767  
E-MAIL: [testequip@wika.de](mailto:testequip@wika.de)

## 1.3 FCC radio frequency emission notice



Warning

This equipment has been tested and found to comply with the limits for a Class A digital device, pursuant to Part 15 of the FCC Rules. These limits are designed to provide reasonable protection against harmful interference when the equipment is operated in a commercial environment. This equipment generates, uses, and can radiate radio frequency energy and, if not installed and used in accordance with the instruction manual, may cause harmful interference to radio communications. Operation of this equipment in a residential area is likely to cause harmful interference in which case the user will be required to correct the interference at his or her own expense.

Use shielded cables to connect external devices to this instrument to minimize RF radiation.

## 1.4 European radio frequency emission notice



Warning

**EN 55022 (or CISPR 22)**

**WARNING!** This is a class A emission device. This equipment may cause radio interferences in residential environments. The operator may be required to make appropriate corrective measures.



Warning

**EN 55011 (or CISPR 11)**

**WARNING!** This is a class A emission device intended for operation in an industrial environment. It can cause interference under certain circumstances if operated in other environments e.g. residential or commercial areas. The operator may have to take appropriate corrective measures.

## 1.5 Trademarks and copyrights

WIKA is a registered trademark of WIKA Alexander Wiegand SE & Co. KG. Mensor is a registered trademark of Mensor.

© 2006, Mensor. All rights reserved.



Notice

**All other brand and product names are trademarks or registered trademarks of their respective companies.**

## 1.6 Software license agreement

This product contains intellectual property, i.e., software programs, that are licensed for use by the end user/customer (hereinafter “end user”).

This is not a sale of such intellectual property.

The end user shall not copy, disassemble or reverse compile the software program.





Notice

**The software programs are provided to the end user “as is” without warranty of any kind, either expressed or implied, including, but not limited to, warranties of merchantability and fitness for a particular purpose. The entire risk of the quality and performance of the software program is with the end user.**

WIKA, Mensor and its suppliers shall not be held to any liability for any damages suffered or incurred by the end user (including, but not limited to, general, special, consequential or incidental damages including damages for loss of business profits, business interruption, loss of business information and the like), arising from or in connection with the delivery, use or performance of the software program.

## 1.7 Accreditations

Mensor is registered to ISO 9001:2008. The calibration program at mensor is accredited by A2LA, as complying with both the ISO/IEC 17025:2005 and the ANSI/NCSL Z540-1-1994 standards. All Mensor primary standards are traceable to NIST.

## 1.8 Packaging for shipment

If the product must be shipped to a different location or returned to Mensor for any reason through a common carrier it must be packaged properly to minimize the risk of damage.

The recommended method of packing is to place the instrument in a container, surrounded on all sides with at least four inches of shock attenuation material such as styrofoam peanuts.

## 2. Safety notices

### 2.1 User responsibilities

To ensure safety, the user must make sure that:

- The system is used properly (refer to "3.1 Proper use" in the section "Product description"), no dangerous media are used and that all technical specifications are observed.
- Safety mechanisms exist, which exclude any danger to persons or machinery through improper pressurization.
- The system is operated in perfect operating condition.
- This operation manual is legible and accessible to the user at the system's location.
- The system is operated, serviced and repaired only by staff who are authorized and qualified to do so.
- The operator receives instruction on industrial safety and environmental protection, and is knowledgeable of the operating instructions and the safety notices contained therein.
- The power cord is the disconnection device. Its outlet should be accessible and contain a protected earth ground.

## 2.2 General safety notices



Caution

The system should only be operated by trained personnel who are familiar with this manual and the operation of the instrument.

A condition for trouble-free and safe operation of this system is proper transport, proper storage, installation, assembly and proper use as well as careful operation and maintenance.



Warning

Any operation not described in the following instructions should be prohibited. The system must be handled with the care required for an electronic precision instrument (protect from humidity, impacts, strong magnetic fields, static electricity and extreme temperatures). Do not insert any objects into the instrument.

The system is powered via the power cable with a voltage that can cause physical injury. Even after disconnecting the system from the power supply, dangerous voltages can temporarily occur due to capacitance.

Although the contacts of the integrated relays located at the back of the instrument are only approved for small electric currents, dangerous voltages or currents can occur in the case of faults or failures.

Extreme care must be taken with pressure connections when using hazardous or toxic media.

Repairs must only be performed by authorized service personnel.

Additional safety notices are found throughout this manual.

## 2.3 Warnings and caution notices



Warning

**HIGH PRESSURE!** High pressure gases are potentially hazardous. Energy stored in these gases can be released suddenly and with extreme force. High pressure systems should be assembled and operated only by personnel who have been trained in proper safety practices.



Warning

**POSSIBLE INJURY!** The tubing, valves and other apparatus attached to the controller must be adequate for the maximum pressure which will be applied, otherwise physical injury to the operator or bystander is possible.



Caution

**Caution:** use the proper pressure medium. Use only clean, dry non-corrosive gases. This instrument is not designed for oxygen use.



Warning

The user must use caution when controlling from a very high pressure down to a very low pressure when a vacuum pump is connected to the exhaust port. Large volumes of gas may be present in the device under test and will exhaust through the Exhaust/Vacuum port in excess of the capacity of the internal relief valve, possibly causing damage to the vacuum pump.



Warning

**HIGH SOUND LEVELS!** Pressures from 600 psig and up can generate sound levels above 100 db for brief periods when they are exhausted directly to atmosphere. If no muffling devices are attached to the exhaust or vent port, then ear protection is advised for personnel in the vicinity of the instruments that will be operated under such conditions.



Warning

**NOT EXPLOSION PROOF!** Installation of this instrument in an area requiring devices rated as intrinsically safe is not recommended.



Caution

**Caution: ESD protection required.** The proper use of grounded work surfaces and personal wrist straps are required when coming into contact with exposed circuits (printed circuit boards) to prevent static discharge damage to sensitive electronic components.



Warning

Before the system is switched on, the user must verify that the system was installed correctly and that all connections meet current regulations. The user must ensure that all specifications such as supply voltage, operating temperature, humidity, sensor-specific pressure media and pressure ranges are observed.



Warning

Before pressurizing, the user must ensure through appropriate protective measures that the system or the device will not be overpressurized. When working with or on an instrument, safety glasses should be worn.



Warning

In areas where the system is operated there must be sufficient air ventilation due to inert gases that will escape during use.



Warning

High pressure can accelerate parts in a manner that could be hazardous and cause physical injury.

Additional warning and caution notes are included throughout this manual.

**NOTES:**

## 3. Product description

### 3.1 Proper use

The CPC3000 High Speed Pressure Controller is a bench top or rack mounted Digital Pressure Calibrator/Controller used for test and calibration of mechanical pressure gauges, pressure switches, sensors, transducers, transmitters and any pressure related devices where time to set point is the most critical requirement.



Warning

**Only dry clean air or nitrogen should be used as the pressure medium. Shop air should be avoided and corrosive, oxidizing, condensing, explosive gases should be strictly avoided.**

**The maximum permissible supply pressure at the supply port should be 10% over full scale value of the sensor installed.**



Warning

**Very fast pressure changes can damage the sensor, due to mechanical stress on the sensor; especially if the fast pressure change leads to an internal pressure which is higher than the full scale of the internal sensor (even if it is only for a fraction of a second). In some cases, the internal relief valves cannot react quickly enough to protect the sensor.**

The Internal pressure sensors have a calibration certificate for the entire measuring chain.



Warning

**The system is not suitable for use in areas with an explosion hazard.**

**If the CPC3000 is not used according to this manual, safe operation of the system is not guaranteed.**

**The user of the system and not the manufacturer is responsible for all physical and material damage resulting from improper use!**

## 3.2 Features

Below is a short list of significant features designed into the CPC3000:

1. The CPC3000 will control (up scale or down scale) into a 150 ml volume, to within 0.025% of the set point, in 3 seconds or less.
2. Uncertainty of 0.025% FS or optional 0.025% IS-50, 365 day calibration interval.
3. Lightweight compact case with handle.
4. Manual operation via the color touch screen and easy access to auxiliary screens allow quick changes to the set point using the "step" and "jog" screens.
5. Remote operation over IEEE-488, USB, or Ethernet.
6. Emulation of other qualified controllers.
7. An optional internal high accuracy barometric reference sensor for emulation of gauge pressure and absolute pressure.
8. A large color LCD display with a touch screen for intuitive operator interface.
9. Multiple languages.



## 3.3 Turning on the CPC3000

The power switch is located on the rear of the instrument as shown in Figure - "Rear Panel".



Figure - Rear Panel

## 3.4 Front panel

The CPC3000 front panel, shown in Figure - "Front Panel", includes a 7 inch color display featuring touch screen technology. Operator input is accomplished by pressing the number, words or symbols presented on the display. There are no mechanical keypads or switches on the front panel.



Figure - Front Panel

## 3.5 Main menu

When the CPC3000 is powered up it takes about 40 seconds for initialization, then displays a screen similar to the Figure - "Initial Screen" below.

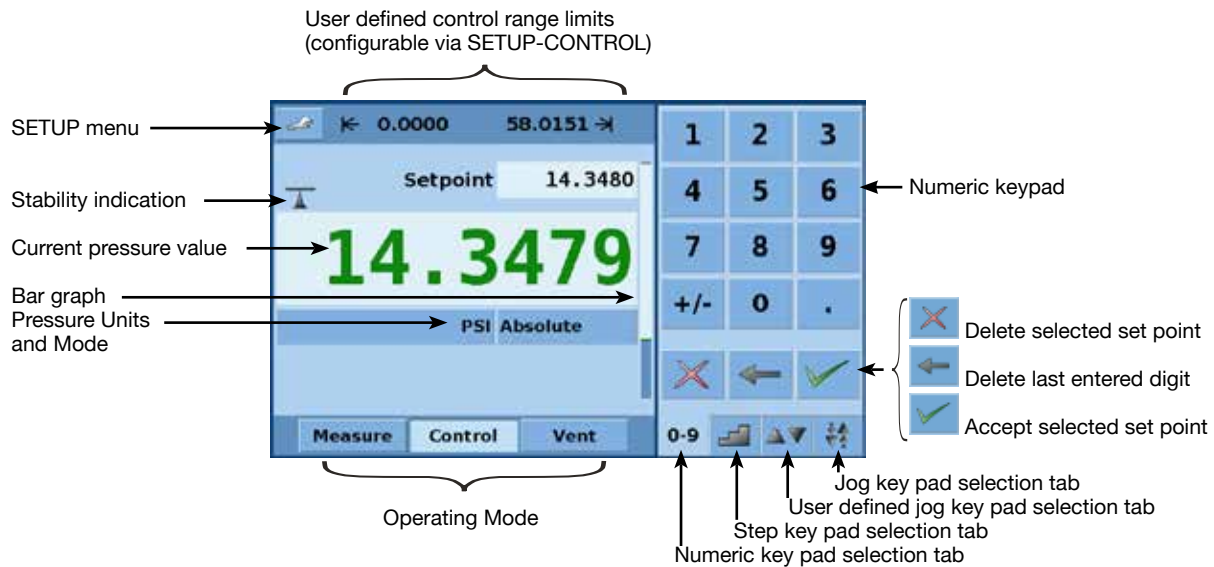



Figure - Initial Screen

### 3.5.1 Keys, tabs, check boxes, labels/graphics

- Keys:** There are two types of keys: those that act as a switch to change a condition and those that open a data entry screen when pressed. Keys have borders with a three dimensional, shadowed effect (examples: **Measure**, **Control**, **Vent**, **0.004**). Throughout this manual keys are represented with the displayed characters enclosed in brackets ( Example: **[MEASURE]** ) or a description and the actual graphic icon (example: **[SETUP]** ). Pressing a key will have one of the following results: 1) instant, single step response, 2) continuously repeating steps while the key is held down, 3) the key will change colors indicating that the associated function is active or 4) a data entry dialog box will open. Operators will quickly become accustomed to the particular characteristics of the frequently used keys.
- Tabs:** Tabs are analogous to tabs in a notebook that allow switching quickly between related screens. Tabs are keys that allow the operator to switch between a group of screens that have a similar purpose, for example the **0-9** tabs allow the operator to quickly switch between four screens used to enter the setpoint.
- Check Boxes:** Check Boxes  allow for the inclusion or exclusion of specific elements or conditions.
- Labels and Graphics:** Labels and Graphics are text, or graphics that display information, but do not respond to being touched (examples: **← 0.00 3092.27 →**). They indicate choices that have been made in the setup menus or indicate existing conditions as pressure is controlled or measured.



## 3.6 Front panel navigation and variations

**Screen Hierarchy:** Navigation within the CPC3000 is similar to a computer file system or a web page. Keys or tabs activate sub-menus. Within the sub-menus there may be related sub-menus or selections. To return back through the hierarchy of screens the **[BACK]**  key is provided. Throughout this manual screen hierarchy will be designated using the following convention: "main->sub-menu->selection" or "main->sub-menu->tab->selection". Sometimes, a reference to a key will be made in the context of a specific screen by simply giving the key name in bold square brackets **[KEY NAME]** or by using the key name along with the actual graphic icon. The Hierarchical menu structure is very intuitive and will become more obvious after reviewing following examples.

**Bar Graph:** The bar graph shows the relative indication of the range of the internal sensor, the user defined limits on the internal sensor, the unused portion of the internal pressure sensor range, the setpoint and the magnitude of the actual controlled pressure. The user defined control limits can be selected in the **Main->Setup->Control** screen and can be set to correspond to the range of the device under test. **It is important to note that when the STEP keypad is active in percent mode, each step is a percent of the user defined limit not the full scale of the internal sensor.** This is useful when calibrating or testing various range devices. Figure - "Bar Graph" shows the bar graph when the CPC3000 is in vent mode with a setpoint of 2.5 psig. The user defined range is 0 to 4 and there is an unused portion of the internal sensor.

Figure - Bar Graph

Bar graph shows relative indication of:

- Range of the Internal sensor
- User defined limits
- Unused portion of the internal sensor range
- Setpoint
- Current pressure reading



### 3.6.1 Operating mode (press to select mode):

#### ■ MEASURE

In MEASURE mode, the instrument measures the pressure connected to the measure port (on changing from CONTROL mode: the last controlled pressure will be held/sealed in the connected test assembly).

#### ■ CONTROL

In CONTROL mode the instrument provides a very precise pressure at the measure port.

#### ■ VENT

VENT opens measure port to atmospheric pressure.

**Optional elements** can be chosen in the **Main->Setup->Display** screen explained in section 7.8.1 of this manual. Each optional element is displayed in the area below the pressure units.

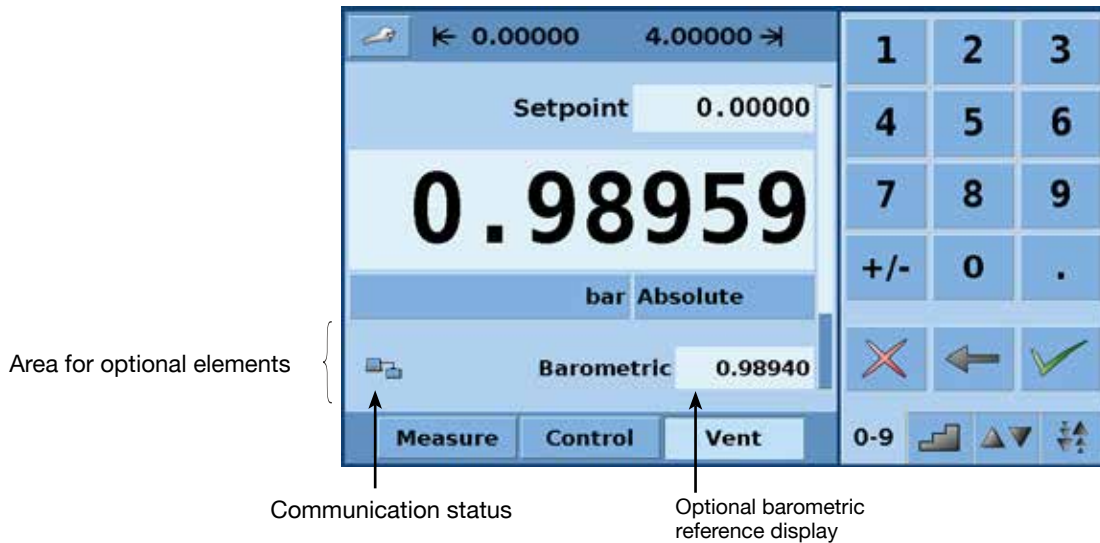

Figure - Optional Display elements

**Navigation to the SETUP screens** is achieved pressing the icon. Setup Figure - "Main Setup Screen" shows the setup screen with the display tab activated. Other tabs at the bottom are used to navigate to additional setup screens. Setup screens will be discussed in detail in section 7.8 of this manual.



Figure - Main Setup Screen

### 3.7 Main menu setpoint entry options

There are four different ways to enter the setpoint in the CPC3000. Each setpoint entry method is explained in detail in section 7.3 Setpoint Entry.

Pressure setpoint entry options are chosen using the tab keys . Pressing each tab will open the respective screen for setpoint entry.



Figure - Numeric Keypad

Figure - "Numeric Keypad" shows the main menu with the numeric keypad selected.



Figure - Step Keypad

Figure - "Step Keypad" shows the main menu with the step keypad selected.

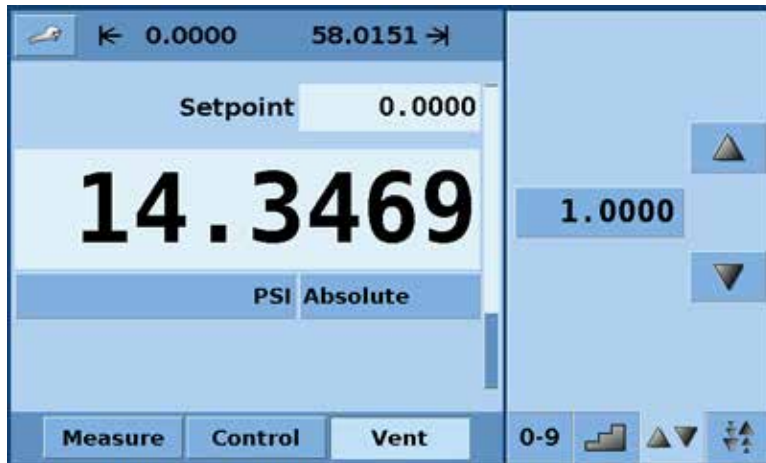

Figure - User Defined Jog Keypad

Figure - "User Defined Jog Keypad" shows the main menu with the user defined jog keypad selected

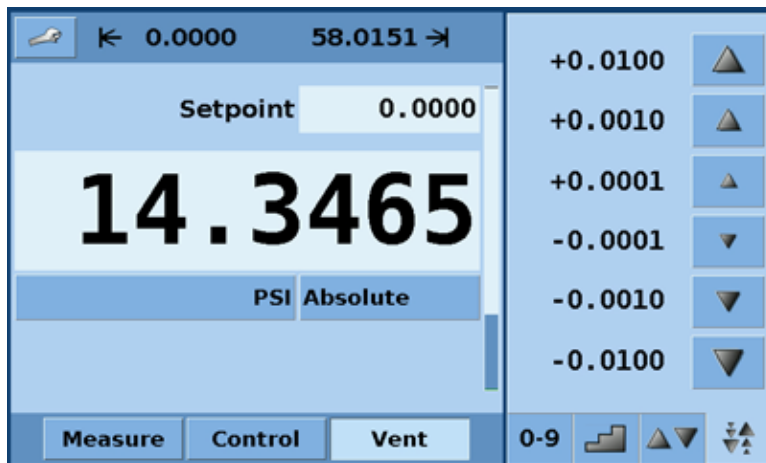

Figure - Jog Keypad

Figure - "Jog Keypad" shows the main menu with the jog keypad selected.

## 4. Specifications

Specifications	Unit	CPC3000																				
Pressure ranges, standard	psi	Gauge: 0 ... 5 up to 0 ... 1500 psig (0 ... 0.35 to 0 ... 100 bar) Absolute: 0 ... 14.5 to 0 ... 1515 psia (0 ... 1 to 0 ... 101 bar) Bi-directional: $5 \leq \text{span} \leq 1515$																				
Pressure types		Absolute, gauge, and bi-directional ranges																				
Uncertainty		0.025% full span for all standard pressure ranges specified above..																				
Definitions pertaining to uncertainty		<p>Max = the maximum value of a range, also known as the full scale value. Example, for a range of -15 ... 145, Max = 145.</p> <p>Min = the minimum value of a range. Example, for a range of -15 ... 145, Min = -15</p> <p>Full Span (FS) = Max - Min. Example, for 0 ... 145 the Full Span is 145, for -15 ... 145 the Full Span is 160</p> <p>Reading = the value of the sensor output</p> <p>IS = IntelliScale is a combination of %Max range and %Reading</p> <p>Total Uncertainty (k=2) includes hysteresis, linearity, repeatability, reference standard, drift and temperature effects over the calibrated range for the calibration interval specified, with periodic re-zeroing.</p>																				
Optional IntelliScale uncertainty		<table border="1" style="width: 100%; border-collapse: collapse;"> <thead> <tr> <th colspan="2" style="text-align: center;">Gauge</th> </tr> </thead> <tbody> <tr> <td style="width: 60%;">Transducer Range (psig)</td> <td style="width: 40%;">Total Uncertainty <sup>(1)</sup> (cal interval)</td> </tr> <tr> <td>0 ... 14.5 to 0 ... 1500</td> <td>0.025% IS-50 <sup>(1)</sup> (365 days)</td> </tr> <tr> <th colspan="2" style="text-align: center;">Absolute</th> </tr> <tr> <td>Transducer Range (psia)</td> <td>Total Uncertainty <sup>(1)</sup> (cal interval)</td> </tr> <tr> <td>0 ... 14.5 to 0 ... 1515</td> <td>0.025% IS-50 <sup>(1)</sup> (365 days)</td> </tr> <tr> <th colspan="2" style="text-align: center;">Bi-directional</th> </tr> <tr> <td>Transducer Range (psi)</td> <td>Total Uncertainty <sup>(1)</sup> (cal interval)</td> </tr> <tr> <td>-15 ... 145 to -15 ... 1500</td> <td>0.025% IS-50 <sup>(1)</sup> (365 days)</td> </tr> <tr> <td><math>5 \leq \text{span} &lt; 145</math></td> <td>0.025% of Full Span (365 days)</td> </tr> </tbody> </table> <p>(1) 0.025% IntelliScale-50 (0.025% IS-50): Uncertainty from Min to 50% of Max = <math>(0.025\% \times 50\% \times \text{Max})</math> or 0.025% of Reading from 50% to 100% of Max.</p>	Gauge		Transducer Range (psig)	Total Uncertainty <sup>(1)</sup> (cal interval)	0 ... 14.5 to 0 ... 1500	0.025% IS-50 <sup>(1)</sup> (365 days)	Absolute		Transducer Range (psia)	Total Uncertainty <sup>(1)</sup> (cal interval)	0 ... 14.5 to 0 ... 1515	0.025% IS-50 <sup>(1)</sup> (365 days)	Bi-directional		Transducer Range (psi)	Total Uncertainty <sup>(1)</sup> (cal interval)	-15 ... 145 to -15 ... 1500	0.025% IS-50 <sup>(1)</sup> (365 days)	$5 \leq \text{span} < 145$	0.025% of Full Span (365 days)
Gauge																						
Transducer Range (psig)	Total Uncertainty <sup>(1)</sup> (cal interval)																					
0 ... 14.5 to 0 ... 1500	0.025% IS-50 <sup>(1)</sup> (365 days)																					
Absolute																						
Transducer Range (psia)	Total Uncertainty <sup>(1)</sup> (cal interval)																					
0 ... 14.5 to 0 ... 1515	0.025% IS-50 <sup>(1)</sup> (365 days)																					
Bi-directional																						
Transducer Range (psi)	Total Uncertainty <sup>(1)</sup> (cal interval)																					
-15 ... 145 to -15 ... 1500	0.025% IS-50 <sup>(1)</sup> (365 days)																					
$5 \leq \text{span} < 145$	0.025% of Full Span (365 days)																					
Optional barometer		8 ... 17 psia (0.55 ... 1.17 bar)																				
Optional barometer uncertainty		0.02% R from 8.5 to 17 psia for 365 days.																				
Uncertainty in emulation mode		RSS of the uncertainty of the pressure sensor and the uncertainty of the barometer.																				
Compensated temperature range	°C	15 ... 45																				
Calibration Interval	days	365																				
Pressure units: English		psi, psf, osi, tsi, tsf, atm, inHg 0°C, inHg 60°F, mtorr, torr, inSW, ftSW, inH <sub>2</sub> O 4°C, inH <sub>2</sub> O 20°C, inH <sub>2</sub> O 60°F, ftH <sub>2</sub> O 4°C, ftH <sub>2</sub> O 20°C, ftH <sub>2</sub> O 60°F																				
Pressure units: Metric		mbar, bar, gm/cm <sup>2</sup> , kg/cm <sup>2</sup> , kg/m <sup>2</sup> , Dy/cm <sup>2</sup> , pascal, hPa, kPa, MPa, mmHg 0°C, cmHg 0°C, mHg 0°C, mSW, mmH <sub>2</sub> O 4°C, cmH <sub>2</sub> O 4°C, mH <sub>2</sub> O 4°C, mmH <sub>2</sub> O 20°C, cmH <sub>2</sub> O 20°C, mH <sub>2</sub> O 20°C																				
Pressure units user defined		2 (multiplier from psi or Pascal)																				
Slew rate		3 seconds to stable flag (+/-0.025% full scale pressure) for a 10% pressure change typical into 150cc volume at pressures greater than 5 PSI. Larger volumes can lengthen this time. Controlling to pressures less than atmosphere can lengthen this time. 4 seconds to stable flag for pressure ranges >70 bar or 1000 psi.																				
Overshoot	% FS	<1 in high speed mode																				
Pressure ports		7/16-20 Female SAE threaded ports for Measure/Control, Exhaust, Reference, and Supply. Barometric Reference port is a hose barb.																				

# High-Speed Pressure Controller CPC3000

Filter elements		40 micron filter element included in each pressure port (excluding the optional barometer and the reference port on a gauge sensor)
Permissible pressure media		Clean, dry, non-corrosive gases
Parts exposed to pressure media		6000 series aluminum, 316 SS, brass, Teflon, Urethane, Silicone, RTV, Silicone grease, PVC, Epoxy, Ceramics
Overpressure protection		Pressure relief valves
Instrument mounting		Desk top with bezel and handle, or optional rack mount kit.
Display		7.0" color LCD
Resolution	digits	Six significant digits
Warm-up time	min	approx. 15
Digital Interface		IEEE-488, Ethernet, USB
Power Supply		100- 240 VAC, 50/60 Hz, 700 mA max
Maximum pressure - supply port	% FS	110 ... 120
Pneumatic overpressure protection		internal relief valves
Operating temperature	°C	0 ... 50
Storage temperature	°C	0 ... 70
Air humidity	%	0 ... 95 (relative humidity without moisture condensation)
Operating position		Negligible, can be removed with re-zeroing
Weight	lbs. (kg)	<20 (<9.1) with all internal options
Dimensions	in.(mm)	5¼ x 8¾ x 12 (133 x 213 x 305). See "Figure - Dimensions" shown below.
CE-mark		Conformity certificate
Calibration		NIST traceable calibration certificate included, A2LA certification standard.

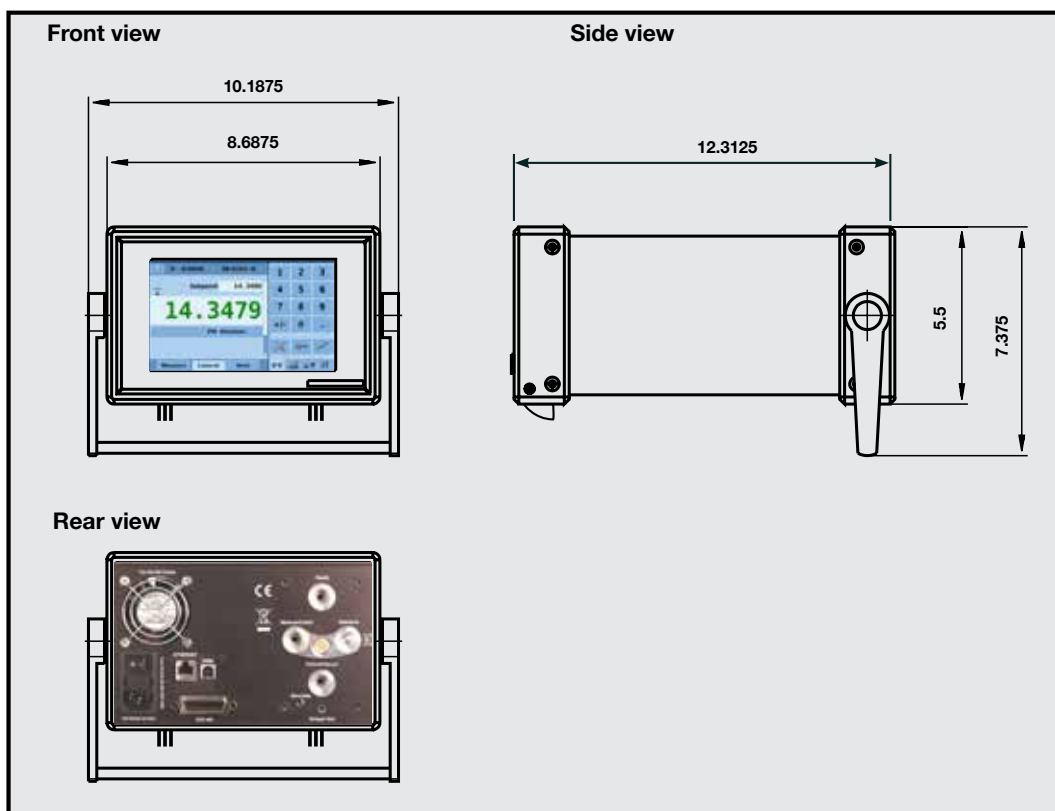

Figure - Dimensions (shown in inches)

## 5. Installation

### 5.1 Introduction

The initial installation of the CPC3000 includes the following steps: Unpack the system, place it in a suitable workspace, connect it, switch it on and configure.

### 5.2 Unpacking the system

Unpack all components of the CPC3000 carefully and check for damage. Report any damage to the carrier immediately.

Apart from any additional components ordered, a shipment consists of:

- CPC3000 controller
- Pressure adapter fittings
- Power cable
- Manual
- Calibration certificate
- Optional: Rack mount kit or any other accessories ordered

### 5.3 Mounting (Rack mount kit option)

Your new instrument can be set up on a table top or it can be rack-mounted. Rack mount adapters are optional on the CPC3000.

A rack mount kit (part number 0018055001) allows the customer to install a CPC3000 into a standard 19" instrument rack. The kit includes rack mount angles as well as rack mount adapter panels and hardware to mount the instrument.

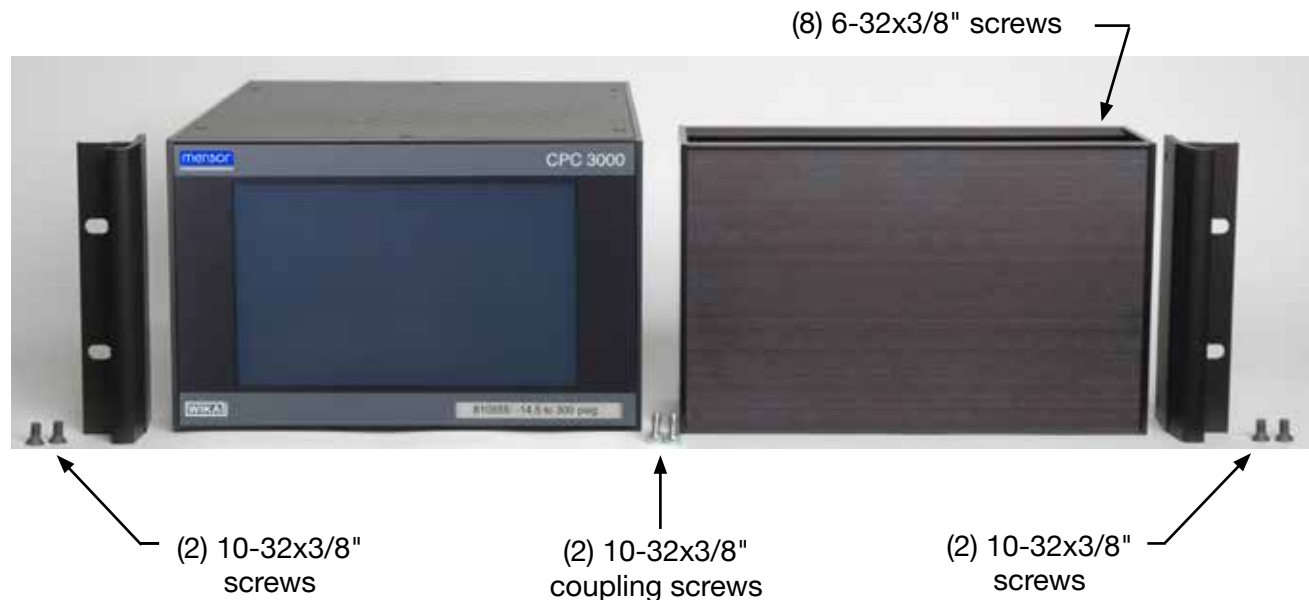

Figure - Rack mount kit

## 5.4 Installation

### The installation site must meet the following conditions:

- Operating Temperature: 0 to 50°C
- Humidity: 0 to 95 % relative humidity non-condensation
- Flat, horizontal location; secure fixed working surface (desk top model) or installation in a 19" rack mount.
- At the back of the instrument sufficient air circulation must be provided to avoid an accumulation of the heat conducted to the outside by the fan.
- During operation, pressure escapes through the vent port in the back of the instrument. Personnel should not have access to the rear vent and exhaust port during operation.
- The power cord is the disconnection device. Its outlet should be accessible and contain a protected earth ground.

### Avoid the following influences:

- Direct sunlight or proximity to hot objects
- Unstable installation position
- Mechanical vibration
- Proximity to sources of strong electromagnetic fields, such as high tension appliances, mobile telephones or mains
- Soot, steam, dust and corrosive gases
- Environment with explosion hazard, flammable atmospheres

### Pressure supply requirements:

- Stable supply pressure 10% higher than the full scale of the internal transducer
- Permissible media: dry, clean air or nitrogen
- Vacuum: minimum 50 litres/min (if required)

An angle of inclination of the system of more than 3 degrees can cause a deviation in the measured pressure and should be avoided. Zeroing the unit at the angle of inclination will nullify this deviation.



Warning

**Applying supply pressure higher than the recommended pressure can cause permanent damage to the controller!**



## 5.5 Rear panel

Five pneumatic pressure ports are located on the rear panel (see labels shown in Figure - "Rear panel"). Positioned on the left are the the off/on switch, the line fuses, a protective grill covering the ventilating fan, Ethernet, USB and IEEE-488 connector.

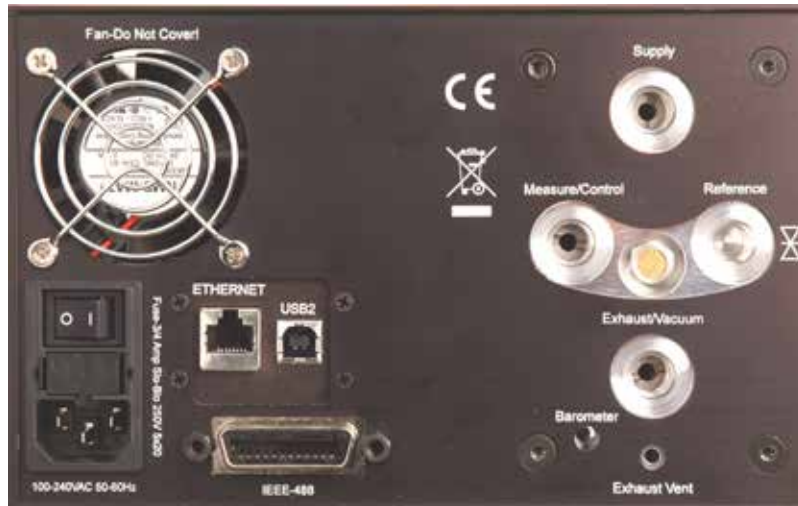

Figure - Rear Panel

## 5.6 Pressure connections



Warning

**The pressure connections must be installed according to the following instructions, observing the relevant regulations. The installation should be performed by persons familiar with, and who can work according to, the safety regulations for working on pneumatic/hydraulic systems.**



Notice

When making up a connection to an o-ring adapter port use a back-up wrench to prevent over-stressing the threads in the manifold block.

All of the pressure ports on the rear are female 7/16 - 20 SAE/MS straight threads per MS16142 and SAE J514 table 14. They require a tube fitting boss seal with an o-ring per MS33656. Mensor provides female pressure adapter fittings with the instrument. The pressure connections can be made to these adapters with the proper mating hardware. Do not use sealant on fittings sealed with an o-ring.

## 5.7 Function of pressure connections

### ■ MEASURE/CONTROL port

Below the label "MEASURE/CONTROL" is a pressure port. In MEASURE mode this port connects a pressure, applied externally or previously generated by the controller, to the internal sensor where the pressure is measured (within the range of the internal sensor). In CONTROL mode this port supplies an output pressure controlled by the internal regulator at the commanded setpoint.

### ■ SUPPLY port

Below the label "SUPPLY" is a pressure port. This port should be supplied with a pressure that is between 110% and 120% of the full scale pressure of the internal sensor. In other words, 10% to 20% above the full scale pressure of the internal sensor (see "Maximum pressure - supply port") in the specifications section and pressure media requirements.)

### ■ EXHAUST/VACUUM port

Below the label "EXHAUST/VACUUM" is a pressure port. If a sub-atmospheric control pressure is required a vacuum pump must be connected to this port. Otherwise, this port may be left open to atmosphere.



Warning

**The user must use caution when controlling from a very high pressure down to a very low pressure when a vacuum pump is connected to the exhaust port. Large volumes of gas may be present in the device under test and will exhaust through the Exhaust/Vacuum port in excess of the capacity of the internal relief valve, possibly causing damage to the vacuum pump.**

### ■ VENT outlet

Between the MEASURE/CONTROL port and the REFERENCE port is the pressure outlet. In VENT mode the pressure within the system is released through this outlet.



Warning

**HIGH SOUND LEVELS! Pressures from 600 psig and up can generate sound levels above 100 db for brief periods when they are exhausted directly to atmosphere. If no muffling devices are attached to the exhaust or vent port, then ear protection is advised for personnel in the vicinity of the instruments that will be operated under such conditions.**

### ■ REFERENCE port

On gauge units this port is connected to the reference side of the transducer, and on absolute units it is internally capped. This port is normally left open to atmosphere but may be attached to a snubber assembly on very low pressure instruments.



Warning

**The controller must be protected from overpressure.**

**Pipes, couplings and other components used for connecting the supply, exhaust/vacuum and the measure/control port must be suitable for the application and rated for the applied pressures.**

**The user must ensure that the pressure media is clean and dry. If necessary, the internal sensors and mechanisms must be protected by using a liquid trap or coalescing filter.**

## 5.8 Electrical connections



Warning

The electrical installation has to be performed according to the following instructions while observing the relevant regulations. It is to be carried out by a qualified electrician.

### 5.8.1 Connecting the power supply and turning on the instrument



Warning

Before connecting the power supply, make sure that the supply voltage agrees with the specification of the power unit. Switch off the system before connecting the power via the power switch at the rear of the instrument.

Only the power cable supplied should be used.

The 3-pin power cable supplied is fitted with a ground lead. Operate the system only from a 3-pin socket, making sure that the ground lead is properly connected.

The power input socket is to be connected according to the regulations with the country-specific connection cable supplied to a power supply that lies within the required specification. To power-on the instrument switch the power switch ON (located on the rear of the instrument; also see section 6, Starting operation).

### 5.8.2 Connecting the Communications interfaces

#### USB 2.0 FS Interface

The USB 2.0 FS connection on the rear panel of the CPC3000 is a USB-B Type connector. The USB driver can be downloaded at [http://www.mensor.com/download\\_software\\_instrument\\_en\\_um.WIKA](http://www.mensor.com/download_software_instrument_en_um.WIKA).

#### IEEE-488 Interface (GPIB)

The connection of the IEEE-488 interface is designed as a 24-pin IEEE-488-socket.

The manufacturer of the host IEEE-488 interface board provides software to allow communication between the board and various programming languages.

An interactive program for debugging is usually provided as well. Refer to the board manufacturer's documentation for more information.

## ETHERNET Interface

The ethernet communication port allows the CPC3000 to communicate with computers using 10/100 Based-T specifications.



**Warning**

**Please consult your Computer Resources Department prior to connecting this instrument to your network to verify there are no conflicts with existing IP addresses.**

Ethernet communications are transmitted over a standard RJ-45 cable. Connecting directly to a PC requires a crossover Ethernet cable. Hub or router connections require a straight Ethernet cable.

Prior to first time use of ethernet communication, the four parameters, IP, Netmask, Gateway, and Port must be setup. These are configured in the communications setup screen.

## 6. Starting operation



Warning

**Before the system is switched on, verify that the system was installed according to the instructions of the previous section and that all connections installed are fitted according to the current regulations.**

**Operators must ensure that all specifications that apply to supply voltage, operating temperature, humidity, pressure media and pressure ranges are observed.**

**Condensation can occur inside the system when the temperature changes abruptly. Give the system sufficient time for acclimation in such cases.**

**Before pressurizing, the operator must ensure that the system and the device under test will not be over pressurized. When working with or on the instrument, safety glasses should be worn.**

**In the rooms in which the CPC3000 is operated sufficient air ventilation has to be ensured.**

When the above points have been met you can switch on the system, (the switch is located on the rear of the instrument) and configure it as required after you have familiarized yourself with the operation (see section 7, Local Operation). After turning the power switch to ON, the instrument will go through a brief initialization process and system check, which will take about 40 seconds. As soon as the system check is completed the system will default to an operating screen similar to Figure - "Initial Screen" in section 3.5. Allow at least 15 minutes of warm up time to achieve thermal equilibrium between the controller and its environment before performing critical pressure measurements.

**NOTES:**

## 7. Local Operation

This section describes the procedures for operating the CPC3000 from the front panel.



### ■ Tabs, Keys, Value Entry and Check Boxes:

Local operation is accomplished by observing the data presented in the display menus, then pressing the on-screen **tab**, **key**, **value entry** or **check box** for the desired sub-menu, function or selection. Tabs are used to access the subset of a menu. Keys open new menus, make selections or change a parameter. Value entry opens a keypad to enter a value. Check boxes allow choice of associated display option.

### ■ Screen Hierarchy:

Navigation within the CPC3000 is similar to a computer file system or a web page. Keys or tabs activate sub-menus. Within the sub-menus there may be related sub-menus or selections. To return back through the hierarchy of screens the **[BACK]**  key is provided. Throughout this manual screen hierarchy will be designated using the following convention: "**main->sub-menu->selection**" or "**main->sub-menu->tab->selection**". A reference to a key, in the context of a specific screen, will be made by simply giving the key name in bold square brackets **[KEY NAME]** or by using the key name along with the actual graphic icon.

### 7.1 Setting the operating language

In the upper left corner of the main display is the **[SETUP]** key . To change the language select the **[SETUP]** key and select the **[DISPLAY]** tab if not already active. In the box labelled "view" on the upper right side of the resulting **main->setup->display** screen there is a **[FLAG]**  key. Press the **[FLAG]** key and a selection of language keys will appear. Select the desired language. Then press the **[BACK]** key to return to the main menu which will now display in the selected language. Using our convention, selecting English would be described by the following: **main->setup->display->flag->english**.

### 7.2 Display configuration

The Figure - "Main Menu" shows the CPC3000 main menu screen that appears when the unit is turned on. A point by point description of each element is shown in this figure. The **[SETUP]** key  opens the setup menu where changes can be made and information viewed. Each sub-menu in the setup menu can be activated by pressing the **[DISPLAY]**, **[CONTROL]**, **[REMOTE]**, **[INFO]** or **[SERVICE]** tab. Each of these setup sub-menus will be discussed in detail in chapter 7.8.

The points on the main menu that are independent of the setup menus are the setpoint indication, the actual pressure reading, the units of measure and the control modes (measure, control and vent), plus the three tab menus  used for selecting a setpoint. The **[PRESSURE UNIT]** key indicates the currently chosen pressure unit and can be pressed to open a menu that allows selection of English, metric, or user defined pressure units.

The CPC3000 main menu shown in Figure - "Optional Elements" shows elements that can be displayed on the main menu and describes the three choices available for setpoint entry (Numeric Keypad, Step and Jog). Optional elements include the Communication status icon which indicates a connection or disconnection from a remote computer, and the barometric reference indication showing the value of the atmospheric pressure measured by the optional internal barometric reference sensor.

# High-Speed Pressure Controller CPC3000

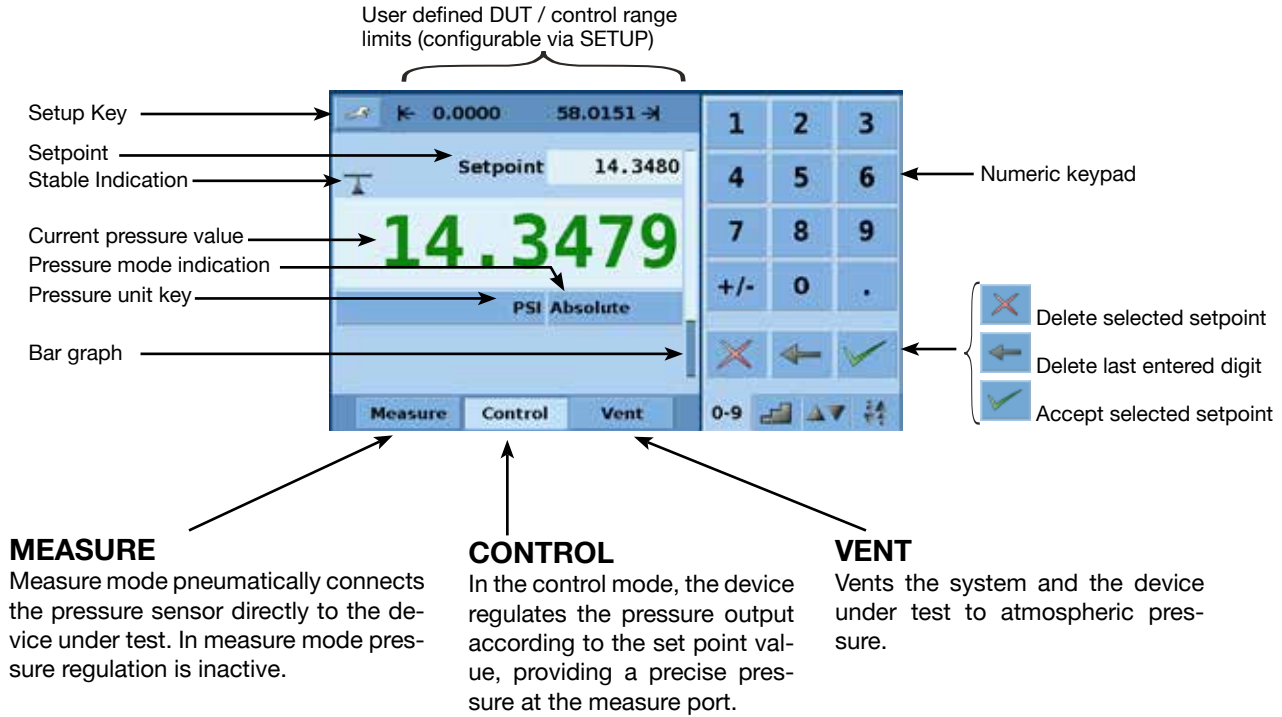

Figure - Main Menu

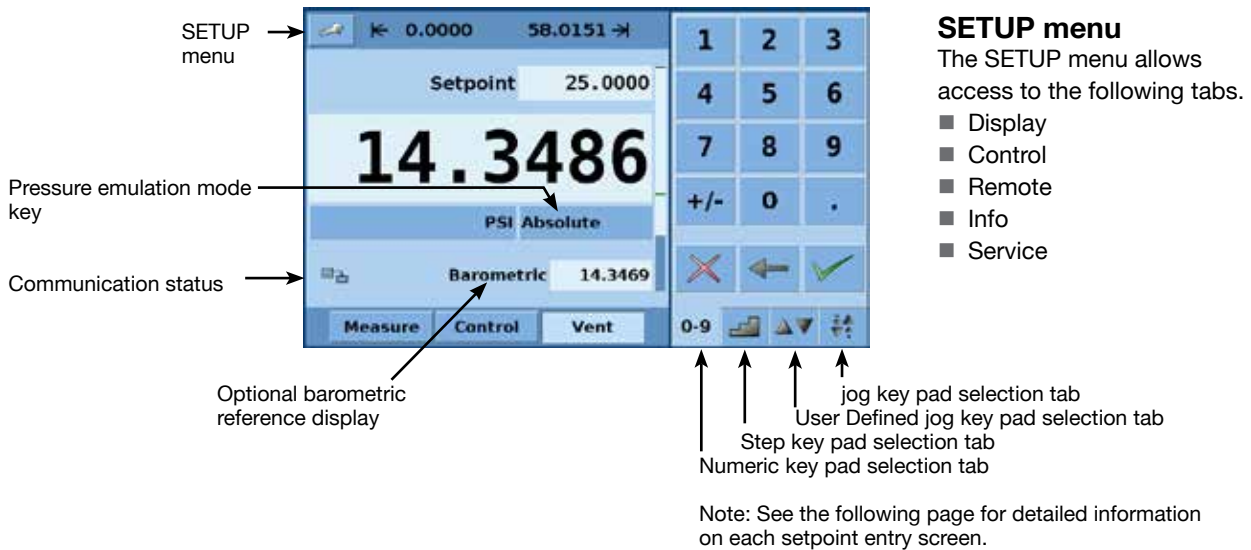









Figure - Optional Elements



## 7.3 Setpoint entry

The control setpoint can be entered using the default Numeric Keypad or the alternate Step or Jog keypads that appear on the right side of the main menu when selected using the **[SETPOINT ENTRY SIDE-MENU]** tabs     on the lower right hand side of the main menu. These alternative methods of entering the setpoint have advantages in different situations and have been designed to increase ease of use and productivity.



The Numeric Keypad shown in Figure - "Numeric Keypad" to the left is the default keypad that appears every time the unit is turned on or can be activated using the **[0-9]** tab. A setpoint value can be entered directly using this keypad. As the value of the setpoint is entered the setpoint field will turn blue and the entered value will appear in the field. The setpoint value can be deleted completely using the **[DELETE]**  key, the last digit of the entered setpoint can be deleted using the **[CLEAR ENTRY]**  key or the setpoint value can be accepted using the **[ACCEPT ENTRY]**  key. When the

**[ACCEPT ENTRY]** key is pressed the setpoint field will turn white and the new setpoint will become active. In control mode, the controller output will ramp to the entered setpoint. **Caution:** If the **[ACCEPT ENTRY]** key is not pressed the previously entered setpoint will remain active.

Figure - Numeric Keypad

### Application:

Direct entry of setpoint using the numeric keypad: enter the setpoint value and press . In Control Mode the controller will then ramp up the setpoint.

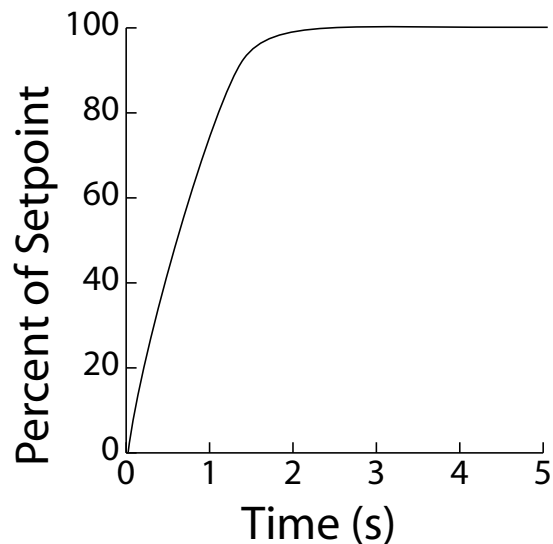



The step keypads shown in Figure - "Step Keypads" provide a way to increment the setpoint by defined steps. Steps are a percent of the user defined limits set in the **main->setup->control** or actual pressure values. A total of 12 steps are provided. When a step is pressed the related setpoint is immediately entered as the active setpoint. In control mode, the controller output will ramp to this setpoint. The Step Keypad can be modified in the **main->setup->control** menu discussed in section 7.8.2.

Figure - Step Keypads

## Application:

Setpoint entry using the step keypad:

Step changes, automatically calculated as a percent of the user defined full scale limit, or in pressure units, can be entered by pressing step keys ( **80.000** ) in any sequence.

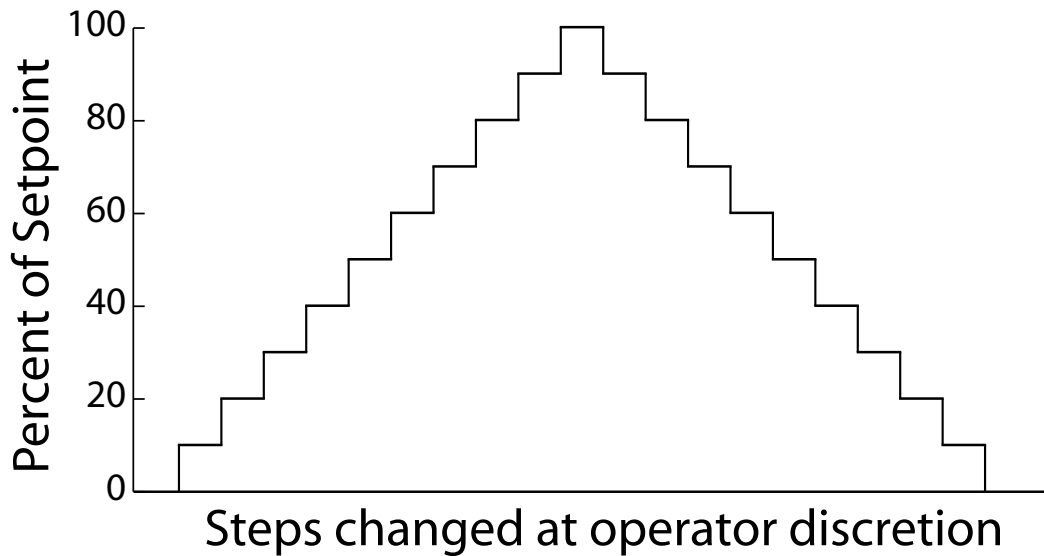

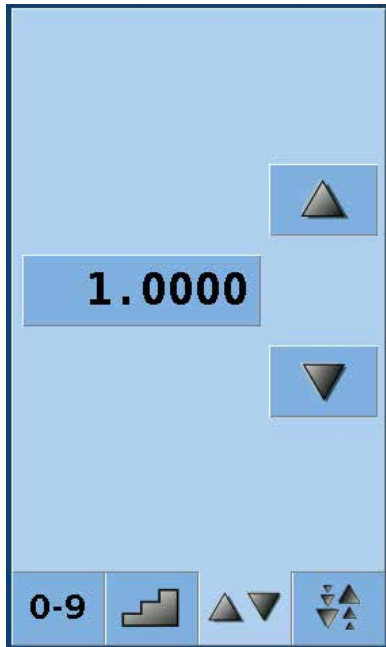



Figure - User Defined Jog

The user defined jog keypad shown in Figure - "User Defined Jog" provides a way to change the setpoint by a user defined step. The step is defined by pressing the button showing the current step value. This opens a number keypad where a new step value can be entered.

Pressing the  button will increase the setpoint by the defined step and pressing the  will decrease the setpoint by the defined step.

### Application:

Setpoint entry using user defined jog or jog keypad:

Use the user defined jog keypad for quick setpoint changes.

Use the jog keypad to increase or decrease the setpoint to reach a cardinal point on a dial gauge.

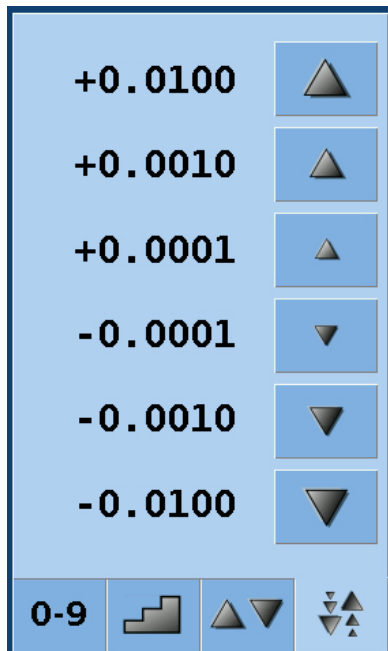
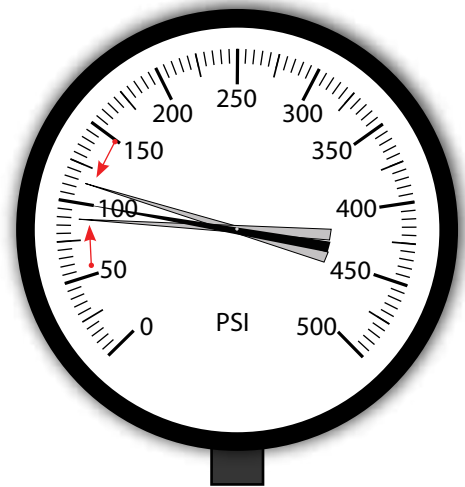

Figure - Jog Keypad

The jog keypad shown in Figure - "Jog Keypad" provides a way to jog the setpoint up or down by small steps. The step size is determined by the resolution, the maximum control limit and/or the units of measure. For example, if the resolution is set to display four decimals then the small triangle pointing up will change the setpoint by 0.0001 and the small triangle pointing down will change the setpoint by -0.0001. In the same way, the medium triangles will change the setpoint by +/- 0.0010 and the large triangles will change the setpoint by +/- 0.0100 as shown in the figure. When the resolution, the maximum control limit or the units of measure are changed so that three decimals are displayed, then the jog functions will change to +/- 0.001, +/- 0.010 and +/- 0.100 respectively. This is useful when adjusting the controller to reach a cardinal point on a dial gauge.

## 7.4 Operating modes

The selection keys for the operating modes Measure, Control and Vent are located at the bottom of the main menu.

### ■ [MEASURE]:

In measure mode, the instrument measures the pressure connected to the **MEASURE/CONTROL** port. Figure -"Measure Mode" shows the state of the isolation valves in measure mode.



Warning

**When the CPC3000 is turned off all the valves close and could trap pressurized gas within the pneumatics. It is safe practice to vent after use and before connecting any devices to the Measure/Control port.**

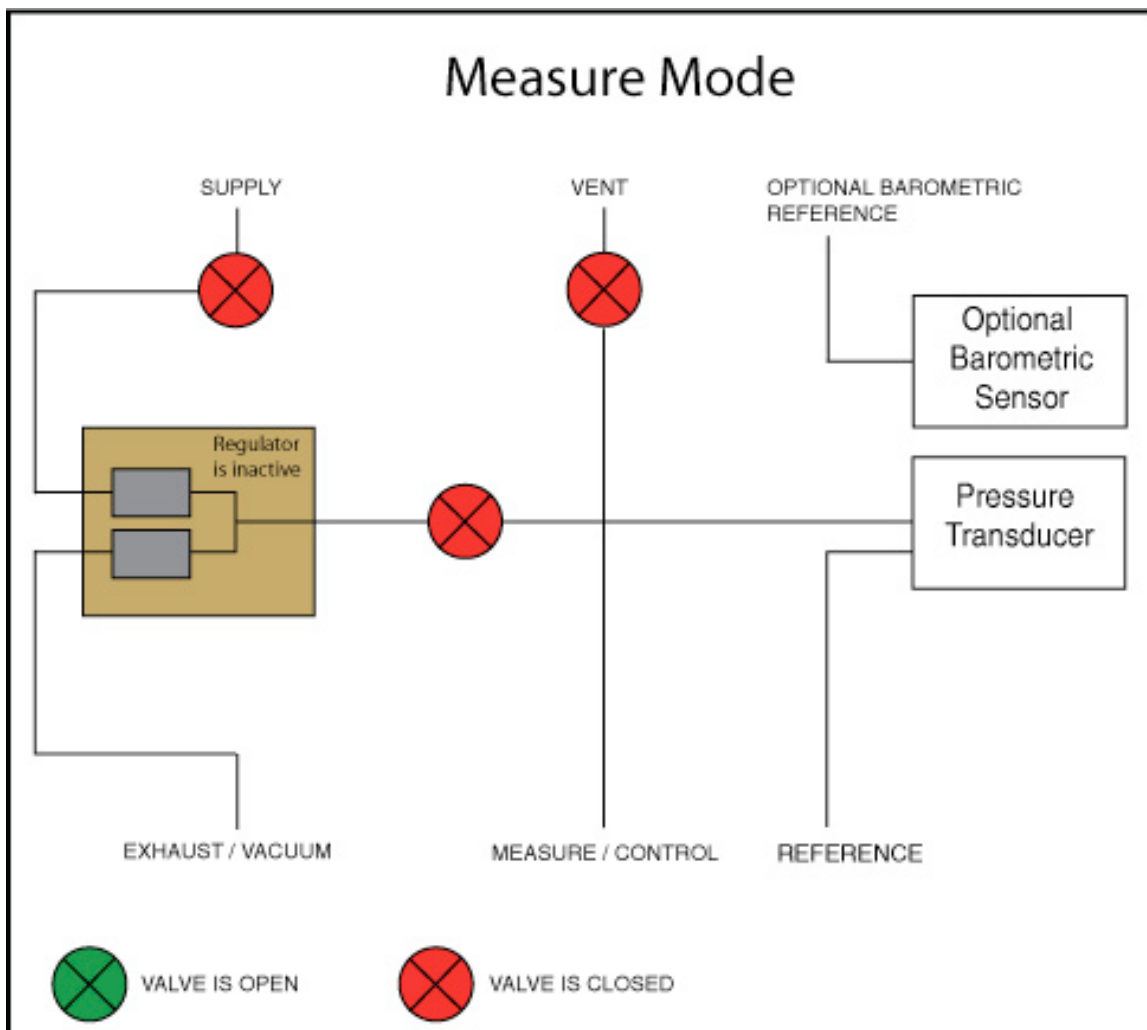

Figure - Measure Mode

■ **[CONTROL]:**

In control mode, the instrument provides a precise pressure output at the Measure/Control port. The indication of the current pressure value will turn green when the setpoint has been reached and the stable window settings have been satisfied. Figure - "Control Mode" shows the state of the isolation valves in measure mode. Notice that the regulator is active in the control mode.

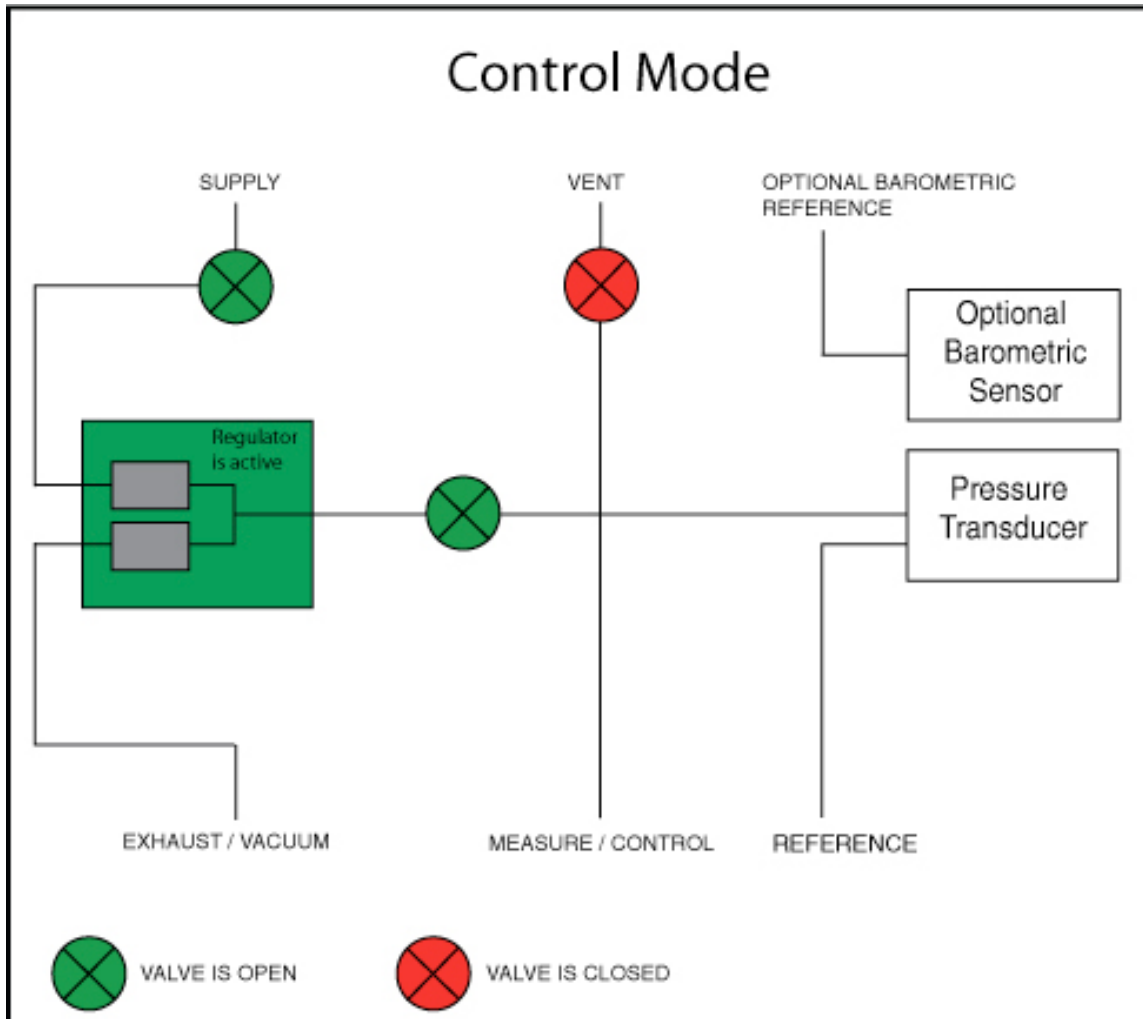

Figure - Control Mode

## ■ [VENT]:

Vent mode vents the pneumatic system and shuts off the supply. Figure - "Vent Mode" shows the state of the isolation valves in vent mode.

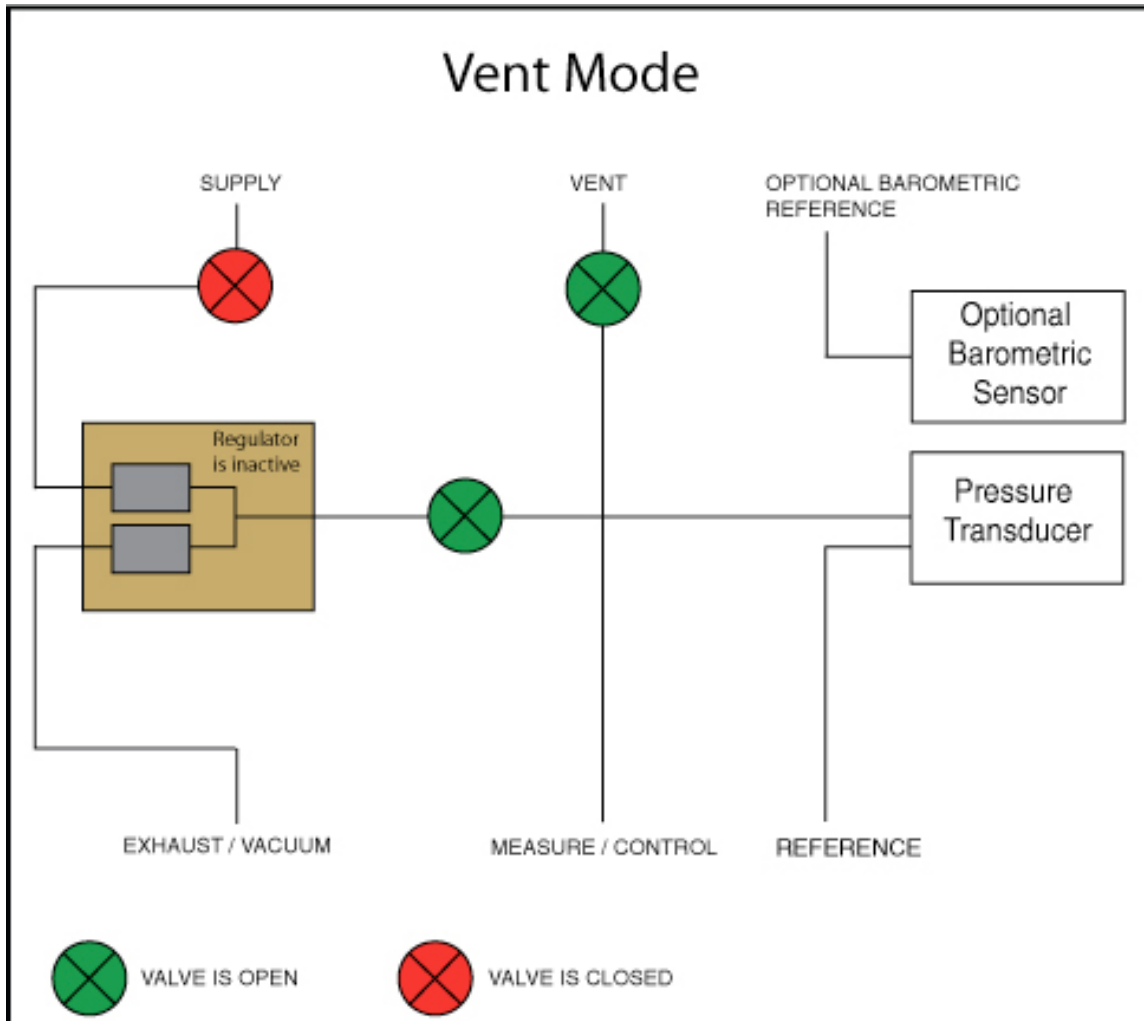





Figure - Vent Mode

## 7.5 Data entry

When there is a requirement to enter specific numeric or alpha values into the system, the method of entry is consistent for all instances. When a **[VALUE ENTRY]** key is pressed a dialog box will appear similar to Figure - "Value Entry". This value entry dialog box will have a numeric or alpha keypad, when appropriate minimum and maximum value limits, current value and a window that shows the new value entered. The value can be deleted completely using the **[DELETE]**  key, the last digit of the entered setpoint can be deleted using the **[CLEAR ENTRY]**  key or the setpoint value can be accepted using the **[ACCEPT ENTRY]**  key.

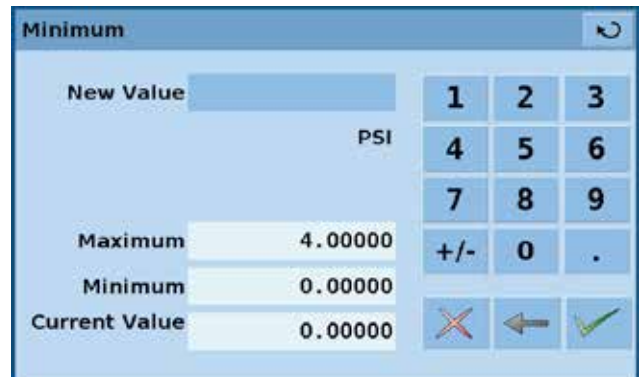

Figure - Value Entry

## 7.6 "Pressure unit", "pressure mode" and "emulation mode"

The Pressure **[UNIT]** key is shown on the main menu screen below the current pressure value and displays the most recently chosen pressure units and the mode (absolute or gauge). If the optional barometric reference is installed a **[MODE]** key replaces the mode indication to the right of the units key. This **[MODE]** key indicates absolute or gauge mode. When the key is pressed it will switch between the "native mode" of the internal sensor to the emulation mode. The "native mode" is the mode of the sensor that is installed and is either absolute or gauge. Emulation mode uses the value of the barometric reference to emulate the mode that is alternate to the native mode. The CPC3000 can emulate gauge from a native absolute sensor or absolute from a native gauge sensor. The **[MODE]** key indicates the native mode with a blue key background and emulation mode with a light blue key background. The units and mode chosen remain the same when the CPC3000 is turned off and then back on.

<b>PSI Gauge</b>	Native sensor is gauge, no barometric reference installed.
<b>PSI Gauge</b>	Native sensor is gauge, barometric reference installed.
<b>PSI Absolute</b>	Native sensor is gauge, barometric reference installed and absolute emulation active.

Pressing the **[UNITS]** key will open a dialog box that shows the available pressure units with tabs for **[ENGLISH]**, **[METRIC]** and **[USER UNITS]**. Pressing a tab will open a menu with the related set of units available. The **[USER UNITS]** tab menu includes **[USER 1]** and **[USER 2]** keys and allows the user to enter customized pressure units. Press the **[MULTIPLIER VALUE]** key to enter a multiplier that defines the user unit as the multiplier times one psi or one Pascal, whichever is currently pressed.

A light blue background on a **[PRESSURE UNITS]** key indicates that it is the current selection. Touch any other **[PRESSURE UNITS]** key, and press the **[BACK]** key to enable change and return to the previous operation screen. All of the displayed pressure values will have changed to correspond to the newly selected units.

## 7.7 Bar chart

The bar chart shows the relative indication of the current pressure value with respect to the full scale value of the internal sensor and the user defined minimum and maximum limits (see section 7.8.2 for setup of user defined limits). The full height of the bar graph is proportional to the internal sensor range. The green line indicates the magnitude of the setpoint. The blue column indicates the magnitude of the current pressure. The cross hatched section indicates the portion of the internal sensor above or below the user defined limits that is not being used.

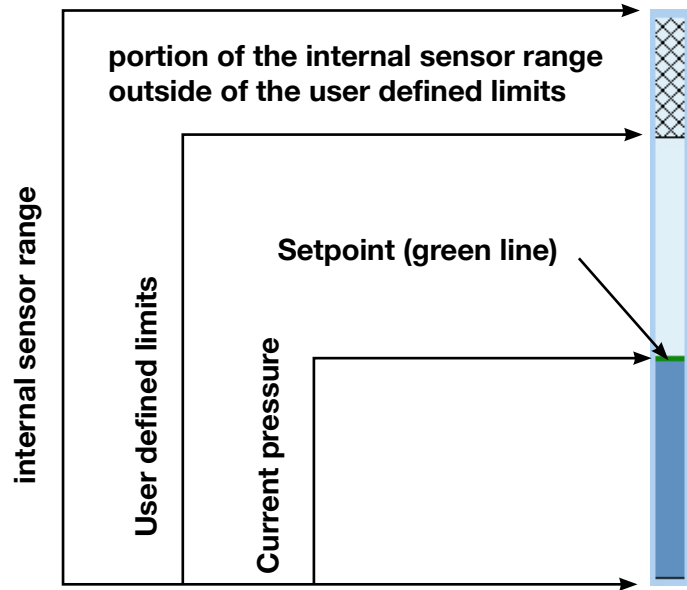

## 7.8 Setup menus

The setup menus are opened by pressing the **[SETUP]**  key. This opens the menu shown in Figure - "Setup". The setup menu has five tabs: **[DISPLAY]**, **[CONTROL]**, **[REMOTE]**, **[INFO]** and **[SERVICE]**. Each tab is described in detail in the following sections. The screen below has the **[DISPLAY]** tab active.

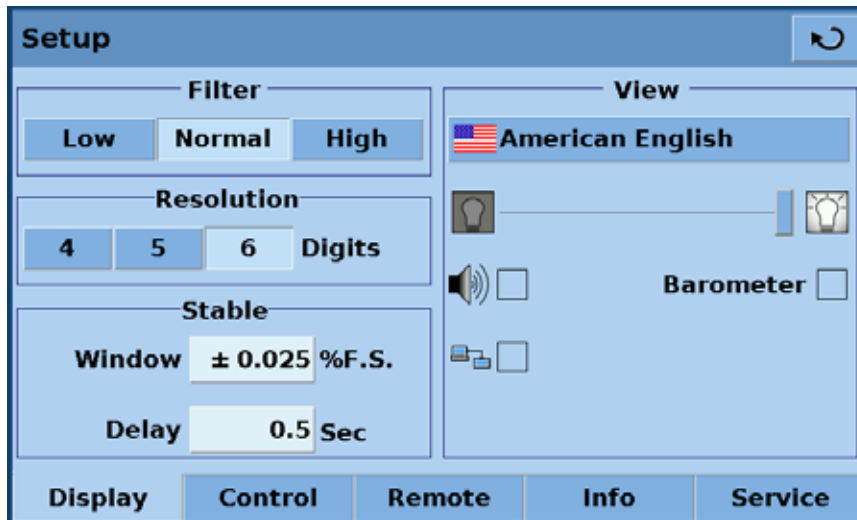

Figure - Setup



## 7.8.1 Setup display

The **main->setup->display** menu contains elements that change the appearance and function of components displayed on the main menu. Following is a description of the elements of this menu.

- **Filter:** The filter selection keys **[LOW]**, **[NORMAL]**, and **[HIGH]** dampen the pressure display to reduce the affect of pneumatic noise associated with the device under test or the test environment.
- **Resolution:** The resolution section of the Setup Display menu allows the user to change the resolution of the current pressure reading to be **[4]**, **[5]** or **[6]** digits.
- **Stable window and delay:** The stable window is the percentage of the full scale value of the internal sensor that the current pressure can deviate +/- from the setpoint and still display a stable indication. The stable delay is the number of seconds that the instrument must remain within the stable window before the stable indication is displayed.
- **Language:** The "View" section of the setup display menu shows a flag, and a language on a key. This is the current language. Press this key to access a menu containing other languages that are available. Figure - "Languages" below shows the language selection screen with the currently available languages shown.

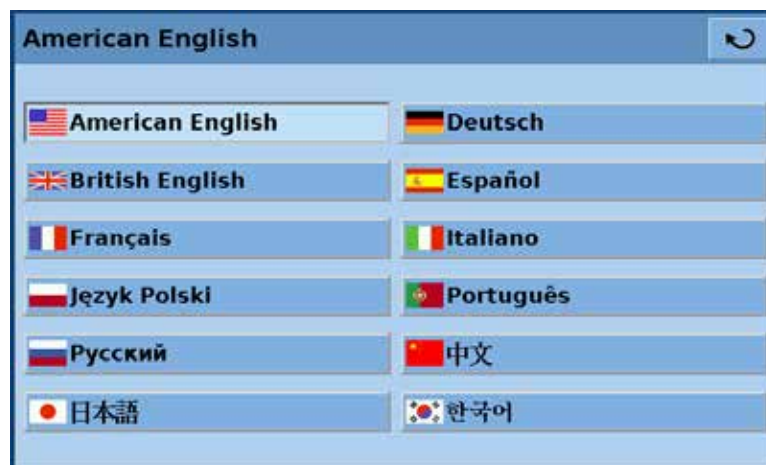

Figure - Languages

- **Brightness setting:** The brightness slide control provides a way to adjust the screen brightness.
- **Speaker check box:** This check box enables or disables an audio feedback when pushing any button. One "beep" audibly designates a legal entry and a double "beep" audibly designates an attempt to enter an illegal value.
- **Remote status check box:** The Remote status check box enables or disables the remote status icon on the main menu. This icon will show a broken wire when there is no connection to a remote computer or a connected wire if the computer is connected.
- **Barometer (optional):** The Barometer check box is under the "View" section and enables or disables the indication of the barometric pressure on the main menu.

## 7.8.2 Setup Control

Configuration of parameters associated with setting limits and adjusting parameters used to control pressure are configured in the **Main->Setup->Control** menu shown in Figure - "Setup Control".



Figure - Setup Control

- **Maximum and minimum control limits:** The **[DATA ENTRY]** keys above the "Step Range" label in Figure - "Setup Control" allow the operator to enter a "user defined range" within the full scale range of the internal sensor. For example, if the CPC3000 has a 0-100 psi internal sensor, the user can define a range of 0-50 psi. When the user defined range is changed, the step menu automatically adjusts so that the percent step equals a percentage of the user defined range. Example: 80% value of a 0-50 psi user defined range is 40 psi; for a user defined range of 0-100 the 80% value equals 80 psi. **The user defined range can be set to the same range as the pressure device being tested. This is useful when there is a test that requires calibration at intervals equal to a percentage of the range.** Each individual step can also be changed by pressing the **[step]** **80.000** key and entering a new value.
- **PSI or %F.S.:** The **[SELECTED UNITS]** and **[%F.S.]** **PSI** **%F.S.** keys switch the step keypad display in the main menu and on the setup screen from the user selected units to percent of the full scale of the user defined range. The values when shown in the **[SELECTED UNITS]** mode correspond to the values in the **[%F.S.]** mode. For example, in Figure - "PSI Mode", the **[PSI]** key is pressed and the value shown in the 100% step is 50, corresponding to the maximum limit chosen in this same screen. Individual steps in "%F.S." or "Selected Units" mode can be included or excluded from the step menu by changing the **[CHECK BOX]**  next to the step.

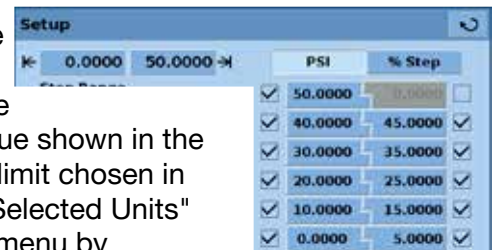

Figure - PSI Mode

- **[Preset Points]** key allows the operator to select the number of points that appear as steps. For example, in Figure - "Preset Points" **[5]** is entered as the preset points value. This automatically configures 5 points from 0 to 100% of user defined range. It automatically calculates the steps that populate the step keypad in the main menu.

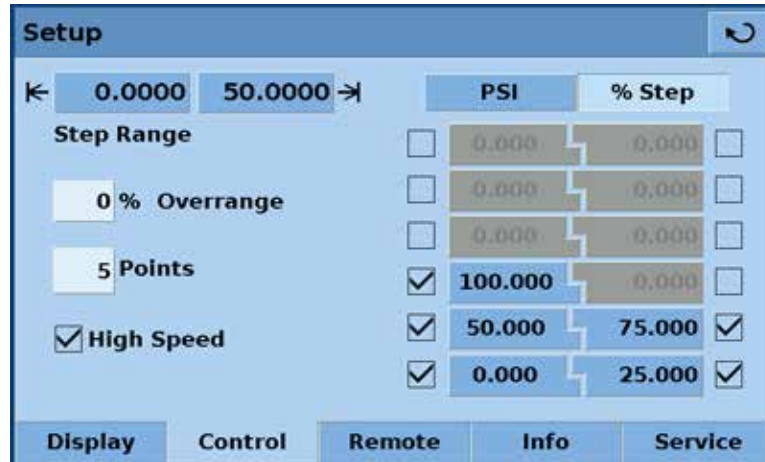

Figure - Preset Points

- **[Percent Overage]** The percent overrange key allows a step or control input point to within a set percentage outside of the user defined range. This is useful when a pressure gauge is reading low and the controller must be set higher to reach a cardinal point on the gauge.
- **[High Speed]** When checked the controller will control the pressure output to the setpoint as quickly as conditions allow. When unchecked the controller will control to the setpoint more slowly but will have minimal or no overshoot.

### 7.8.3 Setup remote

Configuration of parameters associated with remote communication are set up in the **Main->Setup->Remote** screen. Detailed information on setup of Ethernet USB and IEEE-488 are given in section 8, Remote Operation.

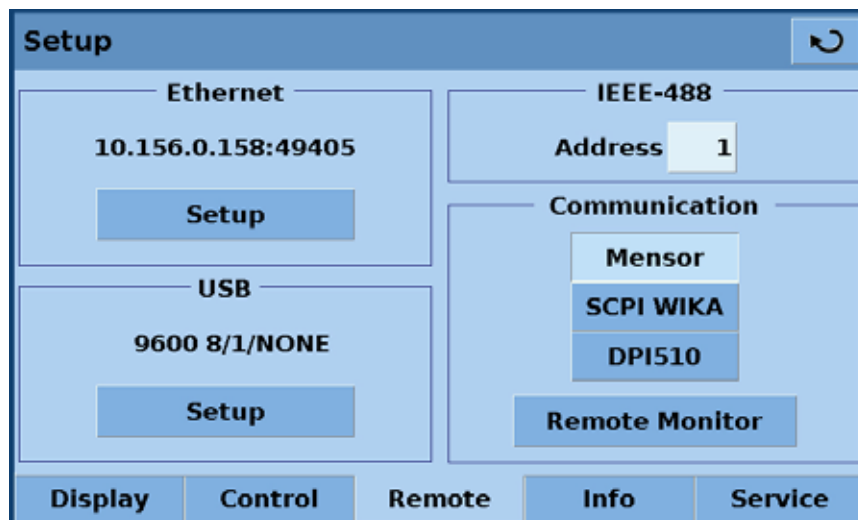

Figure - Setup Remote

- The **[ETHERNET SETUP]** key opens a dialog box where host name, IP, netmask, gateway, port, and client IP can be entered. There is also a check box that will activate (checked) or deactivate (unchecked) Dynamic Host Configuration Protocol (DHCP). DHCP is a protocol used by networked devices (clients) to obtain the parameters necessary for operation in an Internet Protocol network. This protocol reduces system administration workload, allowing devices to be added to the network with little or no manual configuration.
- The **[USB SETUP]** key opens a dialog box where baud rate (9600, 19200, 38400, 57600, or 115200), data bit (7 or 8), stop bit (1 or 2), and parity (none, odd or even) can be chosen. There is also a check box that turns echo on (checked) or off (unchecked).
- The **[IEEE ADDRESS DATA ENTRY]** key opens a data entry dialog box where the IEEE address can be entered.
- In the Communication section there are three remote "command set" emulation settings. The **[MENSOR]** key enables the standard Mensor command set, the **[SCPI WIKA]** key enables the WIKA SCPI (Standard Commands for Programmable Instrumentation) command set structure, and the **[DPI510]** key enables the command set that will communicate with the Druck DPI 500 series of controllers. In this section there is also a **[REMOTE MONITOR]** key that will open a screen that shows the most recent commands and responses sent and received plus any errors. Details of each command set are given in section 8.5.

## 7.8.4 Setup info

The **Main->Setup->Info** screen, Figure - "Setup Info", provides Mensor contact information plus the model number, serial number, min and max range and the native pressure units of the internal sensor, date of calibration and the software version installed. This is an information screen only and does not contain any interactive keys.



Figure - Setup Info

## 7.8.5 Setup service

The **Main->Setup->Service** screen is a password protected area where calibration of the sensor and setup of the regulator is accomplished.

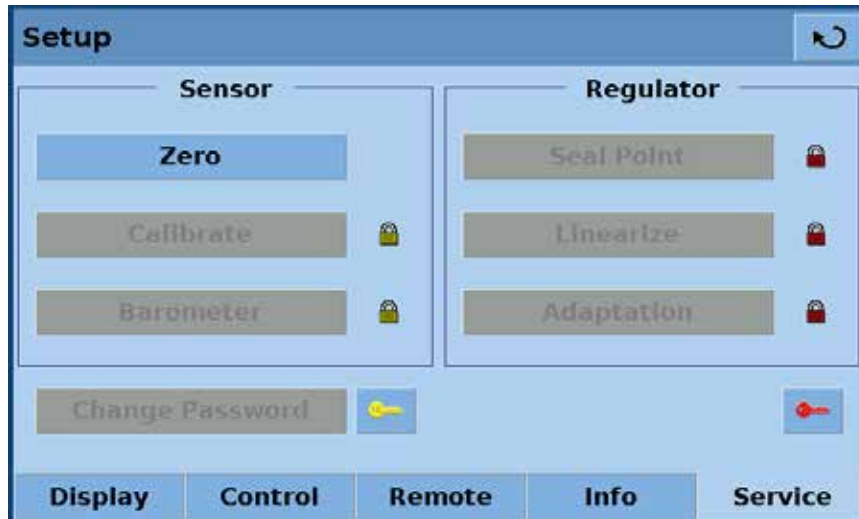

Figure - Setup Service

### 7.8.5.1 Zero (non password protected)

The **Main->Setup->Service** screen allows zero adjustment without entering the password. For an absolute sensor a zero adjustment screen, Figure - "Zero", opens when the **[Zero]** button is pressed. A new zero value corresponding to a true pressure applied at the Measure/Control port can be entered in this screen. For gauge sensors, the sensor is automatically vented and "zeroed" at the current atmospheric pressure. In the latter case the zero adjustment screen does not appear.

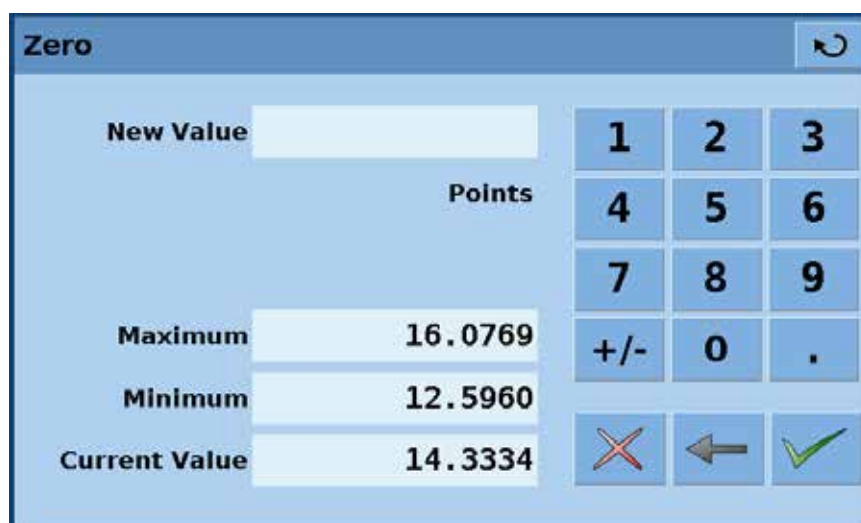



Figure - Zero

## 7.8.5.2 Unlock setup for calibration and regulator adjustment

To access the password protected portion of the **Main->Setup->Service** screen press the yellow [KEY] icon  to unlock the sensor section to perform calibration of the internal sensors. The red [KEY] icon  is available to unlock the regulator section, however, the regulator parameters can only be accessed using a factory supplied password. Adjustment of the regulator Seal Point, Linearization and Adaptation should only be necessary in situations where external conditions are outside of the specified limits (example: high volume applications). Adjustment of these parameters should only be done with supervision from Mensor Customer Service.

Both [KEY] icons open a password entry screen, Figure - "Password". The Sensor section default password is 123456. Entering the sensor section password will open the **Main->Setup->Service** screen with the buttons unlocked indicating free access to these selections, Figure - "Setup Service Unlocked".



**Consult factory before changing any Seal Point, Linerization or Adaptation parameters.**



Figure - Password

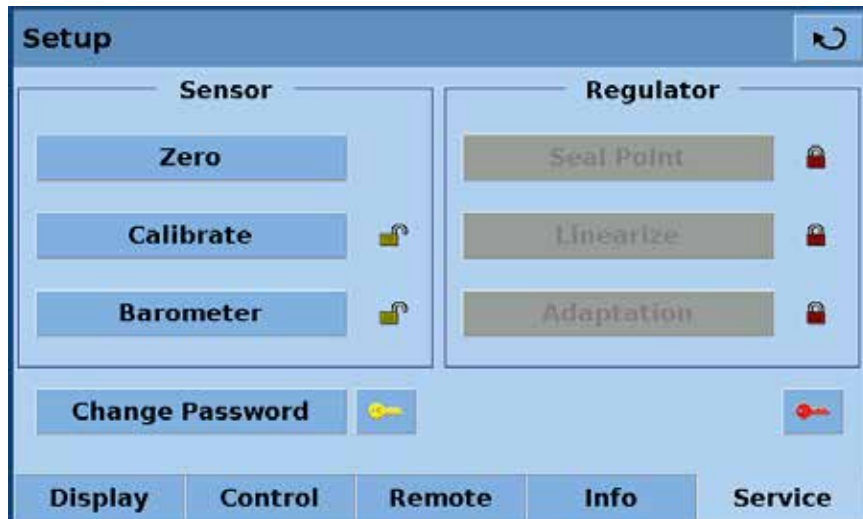

Figure - Setup Service Unlocked

### 7.8.5.3 Change Password

The **[CHANGE PASSWORD]** opens the Change Password screen, Figure - "Change Password" which allows the owner to change the default password (123456) to a "user" password. This "user" password should be recorded in a safe location to allow authorized changes and secure the instrument from unauthorized changes to the calibration parameters.

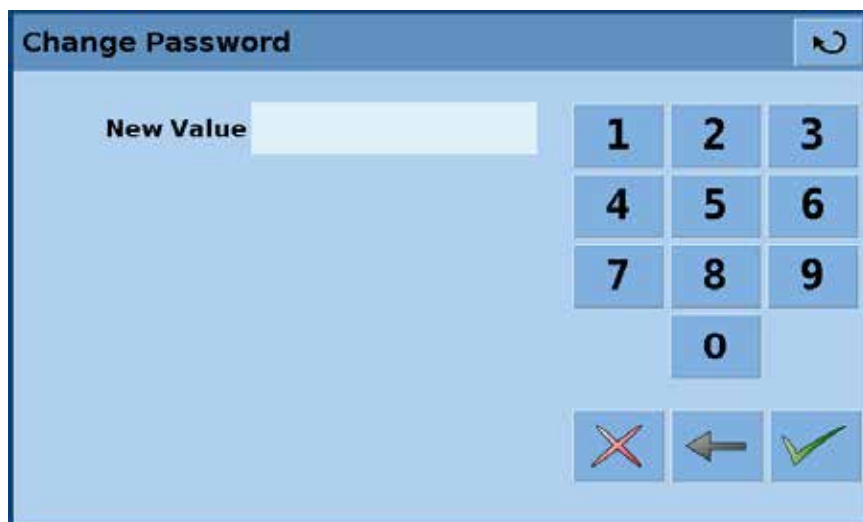



Figure - Change Password

Enter a new value in the Change Password screen and accept the value by pressing the **[ACCEPT ENTRY]**  key. This new value deletes and replaces the default password.

## 7.8.5.4 Calibrate sensor or optional barometer

The **[CALIBRATE]** key provides access to the calibration screen for the internal sensor. If the optional barometer is installed the **[BAROMETER]** key provides access to the barometer calibration screen (see Figure - "Setup Service Unlocked" for key location). **Both processes are identical except for the range of the sensor.**

Figure - "Calibration Setup" is a pneumatic schematic for a typical calibration.

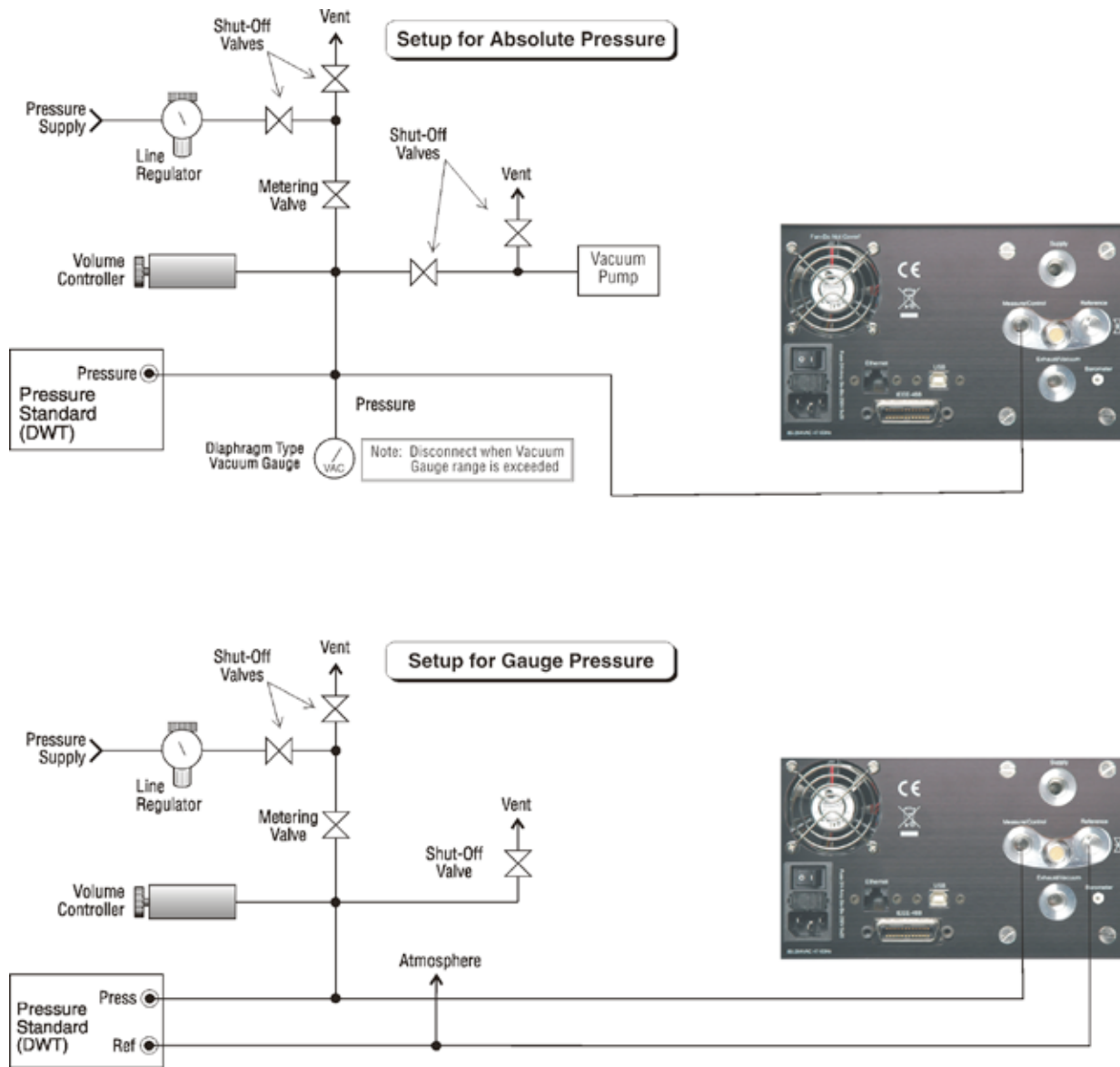

Figure - Calibration Setup



7.8.5.4.1 Calibration data

Figure - "Calibrate Data" shows the screen that appears when the **[CALIBRATE]** key is pressed.

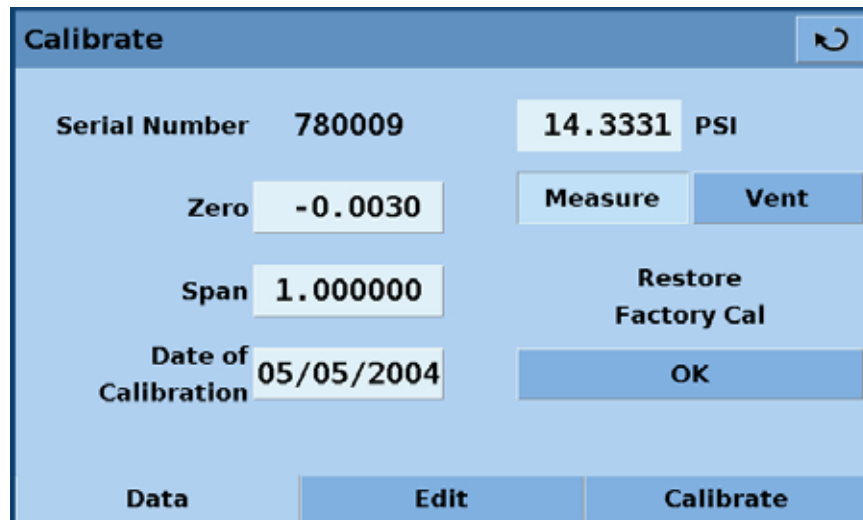

Figure - Calibrate Data

The Calibrate screen contains three tabs: **[DATA]**, **[EDIT]** and **[CALIBRATE]**. When entering the calibrate screen the first time the **[DATA]** tab is the default. The Data screen allows changes to be made to the **[ZERO]**, **[SPAN]**, **[DATE OF CALIBRATION]** and displays the sensor reading and the serial number. It also allows the mode to be changed between **[MEASURE]** and **[VENT]**.

## 7.8.5.4.2 Edit calibration

The screen accessed by pressing the **[Edit]** Tab, Figure - "Calibration Edit", allows calibration using data available from a previous calibration. An example of this is when an "as-found calibration" is performed. Data from the "as-found calibration" can be used to make a "zero and span" adjustment to the sensor. The data indicating the pressure applied by the primary standard and the pressure measured by the CPC3000 transducer from the as-found calibration must be available. The lower pressure applied by the standard (the "zero") should be less than 20% FS and the high pressure applied by the standard (the "span") should be greater than 80% FS.

To edit the calibration from the as-found calibration data:

1. Enter the pressures applied by the standard in the "Desired" column by pressing the corresponding number on the screen (use row 1 for the "zero" value and row 2 for "span" value).
2. Enter the pressure measured by the CPC3000 sensor in the "Actual" column by pressing the corresponding number on the screen (use row 1 for the "zero" value and row 2 for "span" value).
3. When the values are changed, an **[Apply]** key will appear on the screen. Press the **[Apply]** key to save the calibration data and apply the correction to the "zero" and "span".

The screenshot shows a software interface titled "Calibrate" with a refresh icon in the top right corner. It features a table with two columns: "Desired" and "Actual". There are two rows of data. Below the table is an "Apply" button. At the bottom of the screen are three tabs: "Data", "Edit", and "Calibrate".

	Desired	Actual
1	0.0000	1.0000
2	0.0000	0.0000

Figure - Calibration Edit

## 7.8.5.4.3 Live calibration

The Screen accessible by pressing the **[Calibrate]** tab, Figure - "Calibrate Calibrate", allows the operator to perform a live calibration while connected directly to a primary standard. The primary standard should be able to generate a "zero" pressure that is less than 20% of the full scale value of the sensor in the CPC3000 and a "span" pressure that is greater than 80% of the full scale value of the sensor in the CPC3000. For best results, the two points should be as close to the end points of the sensor's range as possible.

To perform a live "zero" and "span" calibration:

1. Put the CPC3000 in Measure mode by pressing the **[MEASURE]** key.
2. Using row 1 for the "zero" value and row 2 for "span" value, enter the pressure generated by the primary standard in the "Desired" column (pressing the number in the "Desired" column will open a data entry screen). This is the value of the pressure applied to the CPC3000 Measure/Control Port. For a gauge sensor the "zero" point can be accomplished simply by pressing the **[VENT]** key thus venting the CPC3000 sensor to atmospheric pressure.
3. The CPC3000 will display the measured pressure in the "Actual" column, but only *after* the measured pressure is within +/- 3.0 % FS of the value in the "Desired" column. At this point the row number highlight will turn yellow and the value will be displayed in a key.
4. When the pressure displayed on the key in the "actual" column is stable, press this key. This action serves to accept the value; as a result, the key will change to a label and display the accepted data. In addition, the row number highlight will change from yellow to green indicating that the number has been accepted.
5. After the "zero" (row 1) and "span" (row 2) have been accepted, press the **[APPLY]** key to save changes.

	Desired	Actual	
1	0.0000	-0.0008	15.0138 PSI
2	15.0000	15.0138	Measure Vent

Apply

Data Edit Calibrate

Figure - Calibrate Calibrate



Notice

When calibrating an absolute transducer, set the low calibration point at or above a pressure of 600 millitorr. At or above that pressure the system will have a viscous flow so that the entire system should have the same pressures after a few minutes.

## 8. Remote operation

### 8.1 Remote setup

To set up any of the remote communication protocols start in the **Main->Setup->Remote** screen, Figure - "Setup Remote".

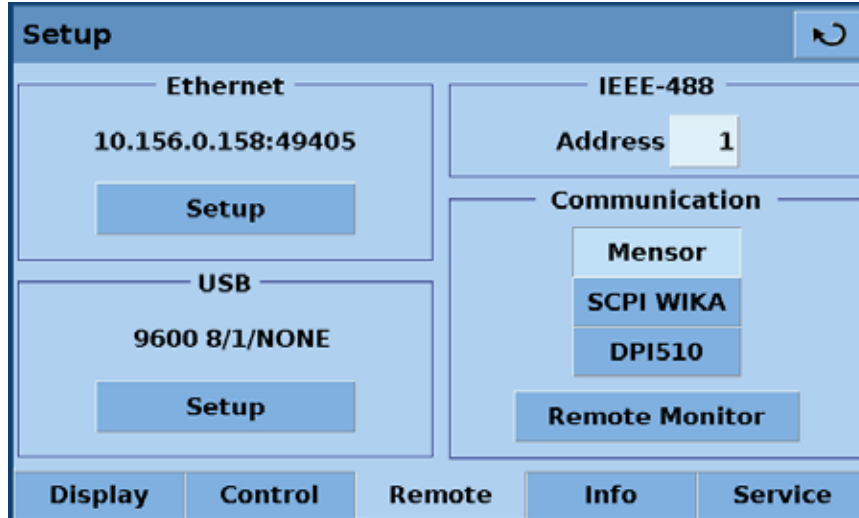

Figure - Setup Remote

### 8.2 Remote setup – Ethernet

The Ethernet communication port allows the CPC3000 to communicate with computers using 10/100 Bases-T specification. Ethernet communications are transmitted over a standard RJ-45 cable. Connecting directly to a PC requires a crossover Ethernet cable. Hub or router connections require a straight Ethernet cable.

Before using Ethernet communication, four parameters must be set up: IP, Netmask, Gateway and Port. In Figure - "Ethernet Setup" the **Main->Setup->Remote->Ethernet** setup screen is shown. Each value entry key opens an alpha or numeric data entry screen to change values of the Ethernet parameters.

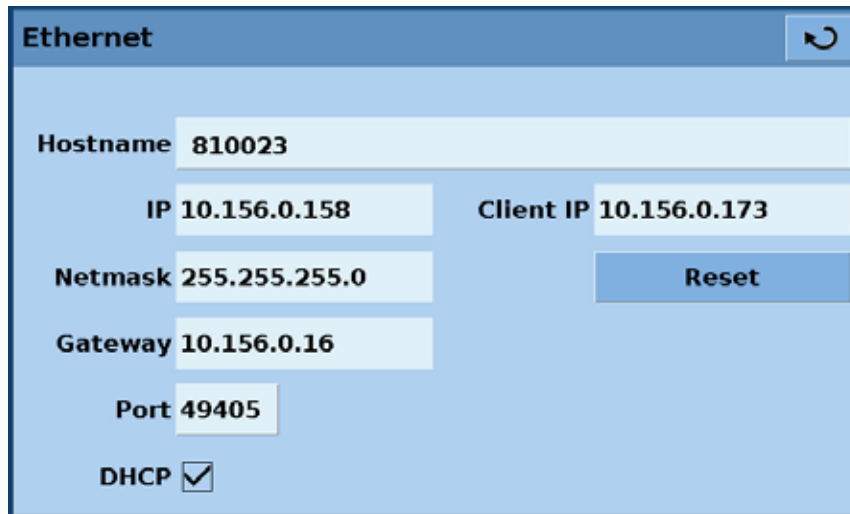

Figure - Ethernet Setup

### 8.3 Remote setup – USB

The USB communication port allows the CPC3000 to communicate with computers using a USB cable. The connection on the back panel of the CPC3000 is a Type B receptacle. The USB Driver can be downloaded at [http://www.mensor.com/download\\_software\\_instrument\\_en\\_um.WIKA](http://www.mensor.com/download_software_instrument_en_um.WIKA).

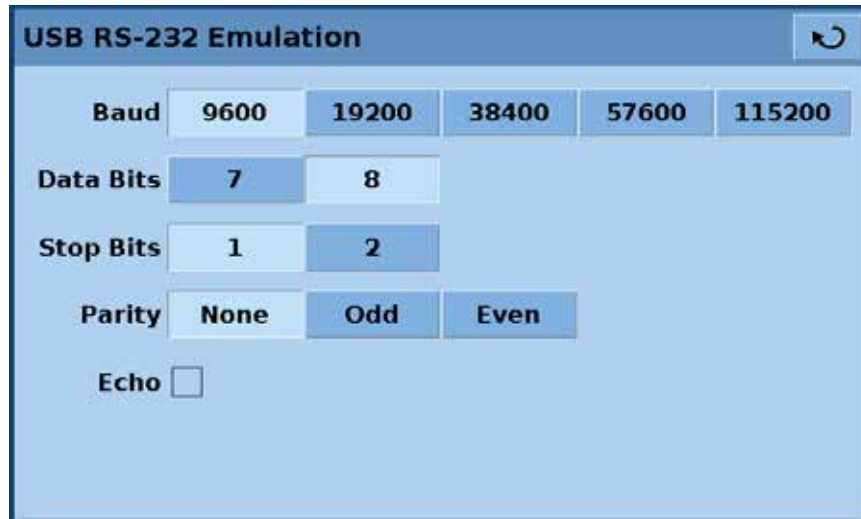

Figure - USB Setup

### 8.4 Remote setup – IEEE-488

The IEEE-488 communication port allows the CPC3000 to communicate with computers using an IEEE-488 cable. This screen, Figure - "IEEE-488 Address", is accessed by pressing the IEEE-488 numeric value box in the **Main->Setup->Remote** screen. After pressing the numeric value box a number entry keypad will appear for entering the new IEEE-488 address. The manufacturer of the host IEEE-488 interface board provides software to allow communication between the board and various programming languages. An interactive program for debugging is usually provided as well. Refer to the board manufacturer's documentation for more information.

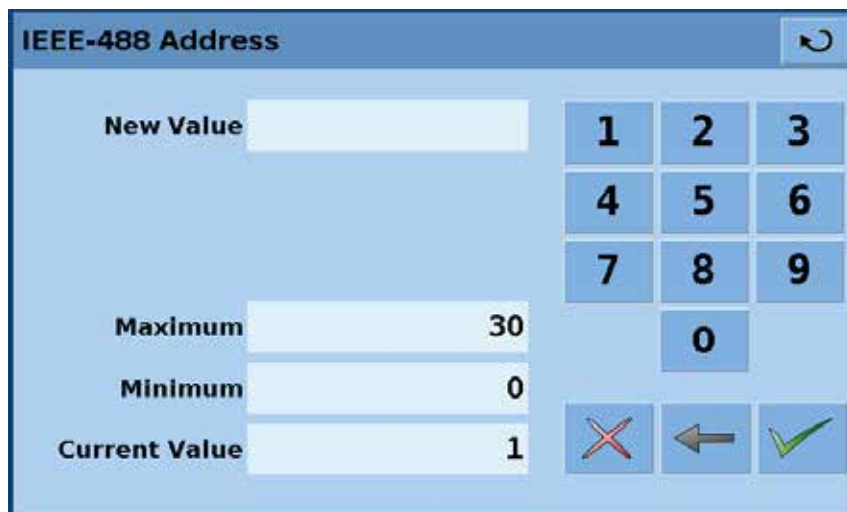

Figure - IEEE-488 Address

## 8.5 Remote command set

This remote command set is the default set available on the CPC3000. All CPC3000 remote operation commands are included in the lists below. All commands must be terminated with a <cr> or a <lf>.

For a query command (ends with a ?), the Data column represents the response of the CPC3000. All response strings begin with a space character or an “E” representing that there is an error in the CPC3000 error queue. All response strings are terminated with a <cr> and a <lf>. The error queue holds the last 10 errors identified by the CPC3000.

For all commands without a question mark (?), the data column represents the required parameters to be sent to the CPC3000 following the string in the command column. For any command that requires multiple parameters to be sent to the CPC3000, the parameters must be separated by commas.

### 8.5.1 Mensor command set

Command	Data	Response/Function
?	See Table Below	Returns data per the current output format.
Acquire?	15 char string. Ex: Acquire? Test_stand_1  Returns: <sp>(Yes or No), CCC... CCC<cr><lf>	This command is used when multiple computers would like to control the instrument. Yes if acquisition is successful, No if instrument is being controlled with another computer. CCC... = name of controlling computer See: Release? and Unlock
Address	0-31	Sets the GPIB Address.
Address?	<sp>xx<cr><lf>	Returns the GPIB Address.
A?	<sp>n.nnnnnE+nn<cr><lf>	Returns the A channel pressure reading.
AR?	<sp>n.nnnnnE+nn<cr><lf>	Returns the A channel rate.
ARS?	<sp>(Yes or No)<cr><lf>	Returns the A channel rate stable flag.
AS?	<sp>(Yes or No)<cr><lf>	Returns the A channel stable flag.
Baro?	<sp>n.nnnnnE+nn<cr><lf>	Returns reading from barometric sensor. (Note: barometric sensor is optional).
Barocaldisable	Yes or No	Sets whether or not the calibration of the barometric sensor is disabled. (Note: barometric sensor is optional).

Barocaldisable?	<sp>(Yes or No)<cr><lf>	Returns whether or not the calibration of the barometric sensor is disabled. (Note: barometric sensor is optional).
Caldisable	Yes or No	Sets whether or not calibration of the active sensor is disabled.
Caldisable?	<sp>(Yes or No)<cr><lf>	Returns whether or not calibration of the active sensor is disabled.
Cerr	None	Clears the error queue.
CID?		Returns the ID string of the regulator for the active channel.
Cmdset	Mensor, DPI510, DPR60c, SCPI	Activates remote command set for instrument emulation modes.
Cmdset?	<sp>X<cr><lf>	Returns active command set identifier.
Control		Instrument placed in Control Mode.
Control?	<sp>(Yes or No)<cr><lf>	Returns Yes if instrument is in control, No if otherwise.
Ctype?	<sp>HSPC<cr><lf>	Returns the type of regulator for the active channel.
Decpt?	<sp>n<cr><lf>	Returns the number of decimal points for the active channel. (see Resolution)
Default	None	Sets the default values.
DHCP		Reserved for DHCP setup
DHCP?		Reserved for DHCP setup
DIO	Integer	2 turns on digital output, 0 turns it off.
DIO?		Bit 0 = input, bit 1 = output
DOC	mm/dd/yyyy	Sets the date of cal for the active sensor and turndown.
DOC?	<sp>mm/dd/yyyy<cr><lf>	Returns the date of cal for the active sensor and turndown.
DOM?	<sp>mm/dd/yyyy<cr><lf>	Returns the date of manufacture.
Error?	<sp>text message<cr><lf>	Returns the next error in the error queue.
Errorno?	<sp>Enn-text<cr><lf>	Returns pcs400 error code and text.

# High-Speed Pressure Controller CPC3000

Filter	Off, Low, Normal, High	Sets the reading filter 0, 80%, 92%, 95%.
Filter?	<sp>(filter)<cr><lf>	Returns the reading filter.
Gateway	nnn.nnn.nnn.nnn	Sets the Ethernet gateway address.
Gateway?	<sp>nnn.nnn.nnn. nnn<cr><lf>	Gets the Ethernet gateway address.
Id?	<sp>MENSOR,CPC3000, ssssss,v.v.vv	Ssssss is the serial number, v.v.vv is the CPC3000 software version.
Install		Start software installer.
IP	nnn.nnn.nnn.nnn	Sets the IP address of the instrument.
IP?	<sp>nnn.nnn.nnn. nnn<cr><lf>	Returns the IP address of the instrument.
Keylock	Yes or No	Locks or unlocks keyboard.
Keylock?	<sp>(Yes or No)<cr><lf>	Returns Yes or No.
List?	<sp>Pri,X,X;Sec,X,X;Bar,1<c r><lf>	Returns list of available turn- downs on installed sensors in the active channel. X will be non-existent if the turndown isn't available.
Listrange?	<sp>PRI,1, min,max,2, min, max;SEC,1, min,max,2, min,max,Bar,min,max<cr><lf>	Returns the ranges of the installed sensors for the active channel.
LowerLimit	Value inside primary xducer Range on turndown #1 in current units.	Sets the lower control limit for the instrument.
LowerLimit?	<sp>n.nnnnnE+nn<cr><lf>	Returns the lower control limit for the instrument in current units.
Measure	None	Instrument placed in Measure Mode.
Measure?	<sp>(Yes or No)<cr><lf>	Returns YES if instrument is in measure, No if otherwise.
Mode	Standby, measure, control, vent	Sets the operation mode of the active channel.
Mode?	<sp>Xxxxxx<cr><lf>	Returns the operation mode of the active channel.
Netmask	nnn.nnn.nnn.nnn	Sets the Ethernet network mask.
Netmask?	<sp>nnn.nnn.nnn. nnn<cr><lf>	Gets the Ethernet network mask.
Outform	1 to 7	Sets the output format. (See "8.5.7 - Output Format")



Outform?	<sp>X<cr><lf>	Returns the output format. (See "8.5.7 - Output Format")
Overrange	value	Sets overrange to value.
Overrange?	<sp>n.nnnnnE+nn<cr><lf>	Returns overrange value.
Peakmax?	<sp>n.nnnnnE+nn<cr><lf>	Returns the max. pressure since peakreset was sent.
Peakmin?	<sp>n.nnnnnE+nn<cr><lf>	Returns the min. pressure since peakreset was sent.
Peakreset	None	Resets the peak values.
Port	nnnnnn	Sets the Ethernet port of the instrument.
Port?	<sp>nnnnn<cr><lf>	Returns the Ethernet port of the instrument.
Ptype	Absolute or Gauge	Sets the instrument pressure type – gauge only works if the optional barometric sensor is installed.
Ptype?	<sp>CCCC<cr><lf>	Returns “Absolute” or “Gauge” for the pressure type
RangeMax?	<sp>XXXXXXX<cr><lf>	Returns the maximum range of the active transducer and turndown in the current units.
RangeMin?	<sp>XXXXXXX<cr><lf>	Returns the minimum range of the active transducer and turndown in the current units.
Rate?	<sp>XXXXXXX<cr><lf>	Returns the rate reading of the instrument in current units/second.
Rdecpt?	<sp>n<cr><lf>	Returns the number of rate decimal points for the active channel. (see: Resolution)
Release?	15 char string. Ex: Release? Test_stand_1  Returns: <sp>(Yes or No), CCC... CCC<cr><lf>	This command is used to release control of the instrument in a multiple computer environment. Yes if release is successful. No if instrument is being controlled with another computer. CCC... = name of controlling computer or AVAILABLE See: Acquire? and Unlock
Resolution	n	Sets the number of significant digits. See decpt?.
Resolution?	<sp>n<cr><lf>	Returns the number of significant digits. See decpt?.
Rfilter	Value in %	Sets the % of the rate filter.

# High-Speed Pressure Controller CPC3000

Rfilter?	<sp>n.nnnnnE+nn<cr><lf>	Returns the rate filter.
Rsetpt	Value in current units	Sets the rate setpoint.
Rsetpt?	<sp>n.nnnnnE+nn<cr><lf>	Returns the rate setpoint.
Rfreq	Value in frequency	Sets rate Butterworth corner frequency.
Rfreq?	<sp>n.nnnnnE+nn<cr><lf>	Returns rate Butterworth corner frequency.
Rwindow	Value in current units	Sets rate exponential filter window.
Rwindow?	<sp>n.nnnnnE+nn<cr><lf>	Returns rate exponential filter window.
Sbaud	9600, 19200, 38400, 57600	Sets the serial baud rate.
Sbaud?	<sp>XXXX<cr><lf>	Returns the serial baud data.
Sdata	7 or 8	Sets the serial data bits.
Sdata?	<sp>X<cr><lf>	Returns the serial data bits number.
Sensor	C,X	Sets the active sensor where C = Primary or Secondary and X = the turndown.
Sensor?	<sp>C,X<cr><lf>	Returns active sensor as above.
Sensorid?	<sp>Mensor QRS,SN XXXXXX,VER V.VV<cr><lf>	Returns the active sensor's serial number and firmware version.
Setpt	Value inside upper and lower limits and inside the range of the active sensor and turndown.	Sets the control setpoint for the instrument.
Setpt?	<sp>XXXXXXXX<cr><lf>	Returns the control setpoint in current units.
Setpt%	Value in % of current range	Sets the control setpoint in % of current range.
Setptpct	Value in % of current range	Sets the control setpoint in % of current range.
Setptpct?	<sp>n.nnnnnE+nn<cr><lf>	Returns the current setpoint in % of current range.
Span	desired pressure or ?	Sets span on active transducer or for ?, clears previous value, must be > 50% FS and has a 1% limit.
Span?	<sp>XXXXXXXX<cr><lf>	Returns span scale factor for active transducer.
Sparity	Even, Odd, None	Sets the serial parity.
Sparity?	<sp>CCCC<cr><lf>	Returns the serial parity.
Sstop	1 or 2	Sets the serial stop bits.

Sstop?	<sp>X<cr><lf>	Returns the serial stop bits.
Stable?	<sp>(Yes or No)<cr><lf>	Returns YES if instrument is stable, or No.
Stabledelay	0 to 65535	Sets the stable time to the number of seconds specified.
Stabledelay?	<sp>XXXXXXXX<cr><lf>	Returns the stable time.
stabletime	0 to 65535	Sets the stable time to the number of seconds specified.
Stabletime?	<sp>XXXXXXXX<cr><lf>	Returns the stable time.
StableWin	%fs value	Sets the stable window as a %FS for the active sensor and turndown.
StableWin?	<sp>XX<cr><lf>	Returns the stable window.
Standby	None	Instrument placed in Standby Mode.
Standby?	<sp>(Yes or No)<cr><lf>	Returns Yes if instrument is in Standby, No if otherwise.
Step	value inside upper and lower limits and inside the range of the active sensor and turndown.	Sets the control step size for the instrument.
Step-	Optional value	Jogs the setpoint down one step.
Step+	Optional value	Jogs the setpoint up one step.
Step?	<sp>XXXXXXXX<cr><lf>	Returns the control step for the instrument.
Step%	Value in % of current range	Sets the control step in % of current range.
Steppct	Value in % of current range	Sets the control step in % of current range.
Steppct?	<sp>n.nnnnnE+nn<cr><lf>	Returns the current step in % of current range.
Step.prog	nn	Go to step nn.
Step.prog.en	Nn,(Yes or No)	Enables step nn.
Step.prog.en? nn	<sp>(Yes or No)<cr><lf>	Returns step nn enable state.
Step.prog.pct	Yes or No	Sets step units.
Step.prog.pct?	<sp>(Yes or No)<cr><lf>	Returns step units (% step or pressure units).
Step.prog.val	Nn,value	Sets step nn value.
Step.prog.val? nn	<sp>n.nnnnne+nn<cr><lf>	Returns step nn value.
Step.prog.min	value	Sets step min range
Step.prog.min?	<sp>n.nnnnne+nn<cr><lf>	Returns step min range.

# High-Speed Pressure Controller CPC3000

Step.prog.max	value	Sets step max range.
Step.prog.max?	<sp>n.nnnnne+nn<cr><lf>	Returns step max range.
Units	Units code or text in table	Sets the instrument engineering units. See: "Measurement Units Table" in section 11, Appendix.
Units?	<sp>CCCC<cr><lf>	Returns the instrument units in a text string.
Unlock	None	Releases Acquire locks. See: Acquire? and Release?
UpperLimit	Value inside primary xducer Range on turndown #1 in current units.	Sets the Upper control limit for the active transducer.
UpperLimit?	<sp>xxxxxxx<cr><lf>	Returns the upper control limit for the active transducer.
Vent	None	Instrument placed in Vent Mode.
Vent?	<sp>(Yes or No)<cr><lf>	Returns Yes if instrument is in Vent, No if otherwise.
Window	Value in current units	Sets the exponential filter window for the active sensor.
Window?	<sp>n.nnnnnE+nn<cr><lf>	Returns the exponential filter-window for the active sensor.
Zero	desired pressure or ?	Sets zero to set pressure or for ?, clears previous value.
Zero?	<sp>xxxxxxx<cr><lf>	Returns zero offset for active transducer.

## 8.5.2 PCS 400 commands emulated

Command	Data	Response/Function
_pcs4 autorange <value>	0 or 1	Not applicable.
_pcs4 autorange?		Not applicable.
_pcs4 cal a/d		Not applicable.
_pcs4 cal atm		Performs pcs400 1 pt cal.
_pcs4 cal span <value>		Sets the span of the active transducer to <value>.
_pcs4 cal zero <value>		Sets the zero of the active transducer to <value>.
_pcs4 cal_disable_off		Enables zero or span calibrations if previously disabled.
_pcs4 cal_disable_on		Prevents zero or span calibrations.

_pcs4 ctrl <value><sp><unitno>	Sets control value – will take effect immediately if instrument is in control mode.
_pcs4 ctrl?	Returns the current control point in current engineering units.
_pcs4 ctrlmax <value>	Sets maximum control value.
_pcs4 ctrlmax?	Returns current maximum control pressure.
_pcs4 ctrlmin <value>	Sets minimum control value.
_pcs4 ctrlmin?	Returns current minimum control pressure.
_pcs4 emul?	Returns ptype emulation mode.
_pcs4 default	Sets default values into instrument.
_pcs4 err?	Returns the error number and description.
_pcs4 exhaustp?	Returns exhaust pressure.
_psc4 filtersetting	Sets the filter %.
_pcs4 filtersetting?	Returns the filter %.
_pcs4 filterwindow	Sets the filter window.
_pcs4 filterwindow?	Returns the filter window.
_pcs4 func ctrl <value> <unitno>	Instrument placed in control mode at <value> pressure in <unitno> units.
_pcs4 func emul	Toggles ptype emulation mode.
_pcs4 func F1	Toggles ptype emulation mode.
_pcs4 func meas	Instrument placed in measure mode.
_pcs4 func stby <unitno>	Instrument placed in standby mode in <unitno> units.
_pcs4 func vent <unitno>	Instrument placed in vent mode in <unitno> units.
_pcs4 id?	Returns instrument ID.
_pcs4 lang PCS2	Sets command set to PCS 200.
_pcs4 list?	Returns range list.
_pcs4 opt?	Returns option list (old PCS 400 format).
_pcs4 option?	Returns option list.
_pcs4 outform <digit>	Sets output format.
_pcs4 outform?	Returns the current output format.
_pcs4 peakreset	Resets peak readings.
_pcs4 peakunit	Selects Peak+ or Peak-.
_pcs4 peakunit?	Returns Peak+ or Peak-.
_pcs4 rangemax?	Returns the maximum pressure of the active transducer.

_pcs4 rangemin?		Returns the minimum pressure of the active transducer.
_pcs4 rate		Sets the control rate.
_pcs4 rate?		Returns the pressure rate.
_pcs4 rateunit		Selects the rate units (SEC or MIN).
_pcs4 rateunit?		Returns the rate units.
_pcs4 reading?		Returns the current pressure.
_pcs4 sourcep?		Returns the supply pressure.
_pcs4 span?		Returns the stored multiplication factor from the active transducer & turndown.
_pcs4 stabledelay <value>	1 to 255	Sets the number of consecutive readings that the pressure must remain within the stable window for a pressure stable indication.
_pcs4 stabledelay?		Returns the number of readings that must be within the stable window before a stable pressure is indicated.
_pcs4 stablewindow <value>		Sets the pressure window that is used to indicate pressure is stable.
_pcs4 stablewindow?		Returns the pressure tolerance allowed for a stable pressure indication as a % of span of the active transducer.
_pcs4 stat?		Returns Mode and stable flag status "mode, stable CR LF".
_pcs4 unit <unitno>		Sets the instrument to specified engineering units.
_pcs4 unit?		Returns the current engineering units and the type of transducer (A, G, D).
_pcs4 xducer?		Returns the number of the currently active transducer.
_pcs4 xducerid?		Returns information on active sensor.
_pcs4 zero?		Returns the stored zero offset of the active transducer and turndown in the current pressure units.

### 8.5.3 PCS 200 commands emulated

Command	Response/Function
CX	Control Pressure at last control point and units
C\$nnnnnnnX	Control Pressure at n in units \$
C\$nnnnnnnsX	Control Pressure at n in units \$
D#X	CAL POINT CONTROL MODE NOT SUPPORTED
EX	Clear Error/Clear Service Request

E?X	Return error code and clear error
F\$nnnnnnn1X	Re-initialize; \$,n ignored
F\$nnnnnnn2X	RETURN CAL DATA NOT SUPPORTED
F\$nnnnnnn3X	Return Unit ID string; \$,n ignored
F\$nnnnnnn5X	RETURN QPS TEMPERATURE NOT SUPPORTED
F\$nnnnnnn6X	RETURN NULL METER READING NOT SUPPORTED
F\$nnnnnnn1X	RETURN VACUUM GAUGE READING NOT SUPPORTED
F\$nnnnnnn1X	Return Clock Reading (Time); \$,n ignored
F\$nnnnnnn1X	Return Pressure Control Limits; \$,n ignored
MX	Measure Pressure in current pressure units
M\$X	Measure Pressure in units specified by \$
M\$nnnnnnnX	Measure Pressure in units specified by \$; n ignored
M\$nnnnnnnsX	Measure Pressure in units specified by \$; n,s ignored
Q#X	SEQ FUNCTIONS NOT SUPPORTED
R0X	Return to Standard Output Format
R1X	Re-initialize
R2X	RETURN CAL DATA NOT SUPPORTED
R3X	Return unit ID string
R5X	RETURN QPS TEMPERATURE NOT SUPPORTED
R6X	RETURN NULL METER READING NOT SUPPORTED
R7X	RETURN VACUUM GAUGE READING NOT SUPPORTED
R8X	Return Clock Reading (Time)
R9X	Return Pressure Control Limits (Min and Max)
SX	Standby Mode
S\$X	Standby Mode; \$ ignored
S\$nnnnnnnX	Standby Mode; \$,n ignored
S\$nnnnnnnsX	Standby Mode; \$,n,s ignored
U\$X	Change Units to units specified by \$
VX	Vent Mode in current units
V\$X	Vent Mode in units specified by \$
V\$nnnnnnnX	Vent Mode in units specified by \$; n ignored
V\$nnnnnnnsX	Vent Mode in units specified by \$; n,s ignored
ZX	AUTO RE-ZERO NOT SUPPORTED

## 8.5.4 DPI 510 commands emulated

Command	Response/Function
Q	Return data in output format
A	Make the A channel active
M	Go to local
R	Select active range
S	Select preset units
U	Set units
D	Select output data
F	Select function
N	Set output format
I	Set interrupt conditions
C	Select control mode
P	Set the control setpoint
/	Setpoint ratio NOT EMULATED
*	Setpoint preset NOT EMULATED
W	Set the stable time
@	Error Report
V	Set rate setpoint
J	Rate setpoint preset NOT EMULATED
O	Set zero offset
Q (baro)	Get baro reading (secondary address 9)
A (baro)	Select absolute
G (baro)	Select gauge
DCL	Device clear
GTL	Go to local
IFC	Interface clear



### 8.5.5 IEEE 488.2 commands

Command	Response/Function
*IDN?	Return identification string
*RST	Reset to known state (DEFAULT+PSI)
*TST?	Returns OK
*OPC	Operation completed
*WAI	Returns operation completed state
*CLS	Clear status and error queue
*ESE	Enable status event
*ESE?	Returns enable status event value
*ESR	Event status register
*ESR?	Returns event status register value
*SRE	Service request enable
*SRE?	Returns service request enable value
*STB?	Returns status byte

## 8.5.6 SCPI commands

Note:

If Wika option is enabled, SCPI units are BARS, otherwise SCPI units are the currently selected unit.

Command	Response/Function
<b>MEASure</b>	
:PRESSure[R]?	Returns the pressure from range R
:TEMPerature[R]?	Returns the temperature from range R
:RATE[R]?	Returns the rate/sec from range R
:BAROmetric?	Returns the barometric pressure
[:PRESSure][R]	
:MODE?	Returns 1=calibrated or 0=not calibrated
:DATE?	Returns date of cal "DD,MM,YY"
:DATE <i,i,i>	Sets date of cal YYYY,MM,DD
:ZERO?	Returns zero offset
:ZERO <n>	Sets the zero offset
:ZERO:RUN	Same as CAL:ZERO 0
:ZERO:INITiate?	Returns zero status
:ZERO:INITiate	No function
<b>SENSe</b>	
[:PRESSure][R]	
:NAME?	Returns sensor name string
:MODE?	Returns "ABSOLUTE" or "GAUGE"
:MODE ABS GAUGE	Sets pressure type
:ABS?	Returns native sensor type 0=GAUGE 1=ABSOLUTE
:RESolution?	Returns resolution (float)
:RANGe	
:UPPer?	Returns maximum range
:LOWer?	Returns minimum range
:UNIT	
:NAME?	Returns ASCII units (mixed case)
:VALue?	Returns the units conversion factor
:REFerence	
:HEIGHT <n>	Sets the head pressure height
:MODE?	Returns "OFF", "GAS", or "LIQUIT"
:MODE OFF   GAS   LIQUIT	Sets the head pressure mode
:MEDium <n>	Sets the medium density

## SYSTEM

:DATE <i,i,i>	Sets sytem date YY,MM,DD
:TIME <i,i,i>	Sets system time HH,MM,SS
:ERRor[:NEXT]?	Returns error code, description
:KLOCK ON   OFF   1   0	Sets the keylock state
:PRESet	Load known state values
:SAVe	No function (not needed)
:VERSion?	Returns SCPI version 1994.0

## TEST

:ELECtronic?	Returns "OK"
:RELay <n>?	Returns status of digital output <n> ignored
:RELay <n> ON   OFF	Turns the digital output on or off <n> ignored

## UNIT

:NAME <n>?	Returns the units string for units code <n>
:FACTor <n>?	Returns the units conversion for units code <n>

## OUTPut

:STATe ON   OFF   1   0	ON or 1 = Control OFF or 0 = Measure
:STATe?	Returns 0 for measure 1 for control
:MODE MEASure   CONTrol   VENT	Sets the mode indicated
:MODE?	Returns the mode string
:STABLE?	Returns 1 if stable 0 if not
:AUTOvent ON   OFF   1   0	Puts the unit in the Vent mode if true
:AUTOvent?	Returns the state of the Vent mode

## [SOURce]

:PRESsure	
[:LEVel]	
[:IMMediate]	
[:AMPLitude] <n>	Sets the setpoint
[:AMPLitude]?	Returns the setpoint
:SLEW <n>	Sets the rate setpoint
:SLEW?	Returns the rate setpoint
:TOLerance?	Returns the stable window
:TOLerance <n>	Sets the stable window

## CALCulate

### :LIMit

:LOWer <n> Set the minimum control limit

:LOWer? Set the minimum control limit

:UPPer <n> Set the maximum control limit

:UPPer? Set the maximum control limit

### :SYSTEM

:DETECT SLOW | FAST | CANCEL Control autotune (NOT USED NOW)

:DETECT? Returns state of control autotune

## 8.5.7 Output formats

1. <sp> pressure value <cr><lf>
2. <sp> pressure, units number, mode <cr><lf>
3. <sp> pressure, pressure rate <cr><lf>
4. <sp> pressure, minimum peak, maximum peak<cr><lf>
5. <sp> pressure, active sensor (P or S) active turndown (1-4)<cr><lf>
6. <sp> pressure, control point, “stable” or “slewing”<cr><lf>
7. <sp> pressure, “no barometer” or baro reading<cr><lf>

## 9. Trouble-shooting measures

If faults cannot be repaired, the system must be taken out of operation immediately and protected against unintentional restarting. This information should be reported to authorized service personnel.

Repairs must only be performed by Mensor or authorized service personnel.

Work on electrical or pneumatic/hydraulic equipment must only be performed by qualified and authorized service personnel, observing the corresponding safety regulations.

### 9.1 Table: Fault description and measures

Type of fault	Measures
I. After the system is switched for 60 seconds, no measurement(s) appears, and the entire area of the screen is white or dark.	Switch off the system and then switch back on again after 5 seconds.
II. The screen is dark and the measures for faults of type I are without effect.	Check that the power cable is connected properly and have authorized technical staff check that the supply voltage is correct.
III. The screen is dark and the measures for faults of type II are without effect.	<p>First pull out the power cable from the power socket and then from the power supply input socket of the system. Then pull out the fuse holder and check the fuses.</p> <div style="text-align: center;">  <p style="margin-left: 100px;">← Fuse holder</p> <p>Power supply input socket</p> </div>
IV. Malfunction during operation	Switch off the system and switch on again after 5 seconds.
V. The set value is not reached.	Check whether the value of the supply pressure at the SUPPLY port is the value required and leak-test the pipe connections.



Warning

**If the fuses of the power supply input socket have to be replaced, use 3/4 amp Slo-Blo 250V.**

**If you require further help please contact Mensor or WIKA at:**

Mensor  
201 Barnes Drive  
San Marcos, Tx 78666

TEL: 512.396.4200  
800.984.4200 (USA only)  
WEB SITE: [www.mensor.com](http://www.mensor.com)  
FAX: 512.396.1820  
E-MAIL: [sales@mensor.com](mailto:sales@mensor.com)  
[tech.support@mensor.com](mailto:tech.support@mensor.com)  
[quality@mensor.com](mailto:quality@mensor.com)

WIKA Alexander Wiegand SE & Co. KG  
Alexander-Wiegand-Straße 30  
D-63911 Klingenberg / Germany

TEL: (+49) 93 72/132-9986  
WEB SITE: [www.wika.de](http://www.wika.de)  
FAX: (+49) 93 72/132-8767  
E-MAIL: [testequip@wika.de](mailto:testequip@wika.de)

## 10. Re-calibrating and servicing

We recommend having the system re-calibrated periodically by the manufacturer. Initially, the recommended period between calibration is as specified (365 days). This period may be extended as confidence is gained in the span stability.

During the first re-calibration a service file is started automatically in which every re-calibration and service is recorded.

The CPC3000 requires almost no maintenance, because all moving parts are extremely robust. There are no parts which have to be serviced by the user.



Warning

**Before cleaning the surface of the instrument, make sure the instrument is not pressurized, that the power is off and the power supply has been disconnected.**



Caution

**To clean the touch-screen use only customary plastic or glass cleaning agents in compliance with the guidelines of the manufacturer.**

## 11. Removal of the system



Warning

**Work on electrical or pneumatic/hydraulic equipment must only be carried out by qualified and authorized service personnel, observing the corresponding safety regulations.**

**When dismantling the system proceed as follows:**

1. Vent the system and make sure that there is no positive or negative pressure on the system and that all parts of the instrument are at room temperature.
2. Switch the system off by pressing the power switch located at the rear of the instrument.
3. First pull out the power cable from the power socket and then from the power supply input.
4. Disconnect the pressure connections.

**If a connection to a SWAGELOK® - connection is to be disconnected, overturning or loosening the SWAGELOK® - connection must be prevented with suitable tools.**

5. Remove the system as necessary.
6. Protect connections with the protective caps supplied.



## 12. Transport of the system



Warning

**Before the system is shipped it must be clean and free of dirt and debris. This is particularly important if the medium is a health hazard such as a corrosive, toxic, carcinogenic, radioactive, etc.**

The CPC3000 must only be shipped in an appropriate transport box. If necessary, please ask for a proper transport box:

Mensor  
Phone 512.396.4200  
800.984.4200 in USA and Canada  
Fax 512.396.1820  
E-mail tech.support@mensor.com

WIKA Alexander Wiegand SE & Co. KG  
Phone +49 - (0) 93 72 / 132-9986  
Fax +49 - (0) 93 72/132-8767  
E-mail testequip@wika.de

### Follow these instructions to prevent damage:

1. Wrap the system in anti-static plastic foil.
2. Place the system in the box assuring the instrument is packed tight with insulating material surrounding the instrument on all sides.
3. If possible add a bag of desiccant to the box.
4. Make sure that the shipment is marked as transport of a highly sensitive measuring instrument.

### The shipping address for Mensor and WIKA:

Mensor  
201 Barnes Drive  
San Marcos, Texas 78666-5994

WIKA Alexander Wiegand SE & Co. KG  
Abteilung: Kalibriertechnik CT  
Alexander-Wiegand-Straße  
D-63911 Klingenberg / Germany

### **13. Storage of the system**

**Before the system is stored it must be clean and free of dirt and debris. This is particularly important if the medium is a health hazard such as a corrosive, toxic, carcinogenic, radioactive, etc.**

**The storage place must satisfy the following conditions:**

- Storage temperature: 0 to 70 °C
- Humidity: 0 to 95% relative humidity without condensation

**Avoid the following influences:**

- Direct sunlight or vicinity to hot objects
- Mechanical vibration
- Soot, steam, dust and corrosive gases
- Explosion-hazard environment, flammable atmosphere

The system should be stored in its original transport box, in a place that meets the conditions listed above.

**Follow these instructions to avoid damage:**

1. Wrap the system in anti-static plastic foil.
2. Using the insulating material, place the system in the box.
3. If the system is to be stored for a longer period of time (more than 30 days) add a bag with desiccant to the box.

## 14. Placing out of service



Warning

**Before the system is shipped it must be clean and free of dirt and debris. This is particularly important if the medium is a health hazard such as a corrosive, toxic, carcinogenic, radioactive, etc.**

When placing the system out of service, please dismantle it according to the instructions in the manual in section 11: "Removal of the system".



Notice

When disposing of the system please observe the legal and local regulations in force.  
For the final disposal of the system a special firm qualified for this is to be commissioned.

## **15. Appendix**

Sales and Service International

Table – Measurement Units

Table – Conversion Factors, Pascal

## Sales and Service International (Service centers shown in bold text)

Europe	Europe	Europe	Europe
<p><b>Germany</b> Headquarters: WIKA Alexander Wiegand GmbH &amp; Co. KG Alexander-Wiegand-Str. 63911 Klingenberg Tel. (+49) 93 72-1 32-0 Fax (+49) 93 72-1 32-406 E-mail: info@wika.de www.wika.de</p> <p><b>Austria</b> WIKA Messgerätevertrieb Ursula Wiegand GmbH &amp; Co. KG Perfektastr. 13 1230 Wien Tel. (+43) 1- 869 16 31 Fax (+43) 1- 869 16 34 E-mail: info@wika.at www.wika.at</p> <p><b>Benelux</b> WIKA Benelux Industrial estate De Berk Newtonweg 12 6101 WX Echt Tel. (+31) 475-53 55 00 Fax (+31) 475-53 54 46 E-mail: info@wika.nl www.wika.nl</p> <p><b>Bosnia</b> GRIZELJ d.d. Nikole Sopa 46, Ilizda 71000 Sarajevo Tel. (+387) 33-542992 Fax (+387) 33-457141 E-Mail: grizelj@grizelj.com www.grizelj.com</p> <p>RUDEL PROJEKT Rate Dugojonica 10 75000 Tuzla Tel. (+387) 35 267 067 Fax (+387) 35 267 067 E-Mail: rudelpro@bih.net.ba</p> <p><b>Bulgaria</b> WIKa Bulgaria EOOD Blvd. „Al. Stamboliyski“ Nr. 205 1309 Sofia Tel. (+359) 2 82138-10 Fax (+359) 2 82138-13 E-mail: t.antonov@wika.bg</p> <p><b>Croatia</b> WIKa Croatia d.o.o. Hrastovicka 19 10250 Zagreb-Lucko Tel. (+385) 1 6531 034 Fax (+385) 1 6531 357 E-mail: info@wika.hr</p> <p><b>Cyprus</b> Theseas Savva 118, Franklin . Roosevelt Avenue P.O. Box 114 3601 Limassol Tel. (+357) 5 - 56 58 99 Fax (+357) 5 - 56 29 17 E-mail: theseas@cytanet.com.cy</p> <p><b>Czech Republic</b> WIKa Representative Office Dipl.Ing. Rainer Artl Ul. Mora Krausza C. 13 SK-94504 Komarno 4 Tel. (+421) 35-7782215 Fax (+421) 35-7852020 E-mail: r.artl@nexta.sk</p>	<p>ARMEX Holding a.s. Folknarska 21 40502 Decin II Tel. (+420) 412-526 500 Fax (+420) 412-526 501 E-mail: obchod@armex.cz</p> <p>Tertec spol. s.r.o. Cihelni 95/1191 70200 Ostrava Tel. (+420) 596-623 157 Fax (+420) 596-613 913 E-mail: info@tertec.cz</p> <p>Manag a.s. Stitarska 154 28002 Kolin Tel. (+420) 321-71 12 94 Fax (+420) 321-72 26 98 E-mail: jiri.novak@manag.com</p> <p>MaR Systems s.r.o. Ivana Olbrachta 3998/5A 69503 Hodonin Tel. +420 518 321669 Fax +420 518 321669 E-mail: obchod@marsystems.cz</p> <p>G.A.S.a.s U Kyjovky c. 3928/1 69501 Hodonin Tel. (+420) 518-700-162 Fax (+420) 518-700-222 E-mail: gas@gas-as.cz</p> <p><b>Denmark</b> Carl A. Plesner A/S Klintehoej Vaenge 6 Postbox 119 3460 Birkerød Tel. (+45) 45 81 96 00 Fax (+45) 45 81 96 22 E-mail: carl@plesner.dk</p> <p><b>Finland</b> WIKa Finland Oy Melkonkatu 24 00210 Helsinki Tel. (+358) 9-682 49 20 Fax (+358) 9-682 49 270 E-mail: info@wika.fi www.wika.fi</p> <p><b>France</b> WIKa Instruments s.a.r.l. Parc d'Affaires des Bellevues „Eragny Parc“ Immeuble Colorado 8, Rue Rosa Luxembourg 95610 Eragny-sur-Oise B.P. 261 95615 Cergy Pontoise Cedex Tel. (+33) 1-34 30 84 84 Fax (+33) 1-34 30 84 94 E-mail: info@wika.fr www.wika.fr</p> <p><b>Greece</b> Deka S.A. Aristidou 21 GR 18531 Pireas Tel. (+30) 210- 422 23 25 Fax (+30) 210- 411 81 07 E-mail: deka@otenet.gr www.deka.gr</p>	<p><b>Hungary</b> ID. VASILESCU JANOS KFT. Ipari Meresi Technikai Export-Import Schwartz F. u. 4 1123 Budapest Tel. (+36) 1-212-3822 Fax (+36) 1-213-8205</p> <p>Component Kft. Galamboc u. 45 1119 Budapest Tel. (+36) 1-206 67 31 Fax (+36) 1-204 01 56 E-mail: info@componentkft.hu</p> <p><b>Iceland</b> Sturlaugur Jonsson &amp; Co. ehf. Fiskisloo 26 P.O. Box 605 121 Reykjavik Tel. (+354) 551 46 80 Fax (+354) 552 63 31 E-mail: sturlaugur@sturlaugur.is</p> <p><b>Ireland, Republic of</b> Instrument Technology Ltd. Unit 6 Dunboyne Business Park Dunboyne Co. Meath Tel. (+353) 1-801 37 70 Fax (+353) 1-801 37 71 E-mail: info@itldub.ie</p> <p><b>Italy</b> WIKa Italiana SRL Via G. Marconi 8 20020 Arese (Milano) Tel. (+39) 02-93 86 11 Fax (+39) 02-93 86 174 E-mail: info@wika.it www.wika.it</p> <p><b>Lithuania</b> Uzdaroji Akcine Bendrove „Lintera“ Ukmerges Str. 22 LT - 5000 Jonava Tel. (+370) 349 - 611 61/614 48 Fax (+370) 349 - 612 97 E-mail: lintera@is.lt</p> <p><b>Macedonia</b> TEGA INZENERING d.o.o. Ul. Kozle 88 B3 mezanin lokal 7 1000 Skopje Tel. (+389) 2308 6094 Fax (+389) 2308 6095 E-mail: poposki@tegaing.com.mk</p> <p><b>Malta</b> Salvo Grima &amp; Sons Ltd. 12 Barriera Wharf Valetta Tel. (+356) 23 22 75</p> <p><b>Montenegro</b> FILCOM Danila Bojovica BB 81400 Niksic Tel. (+382) 83 212374 Fax (+382) 83 212374 E-mail: filcom@cg.yu</p>	<p><b>Norway</b> Ax Flow-Norsk Pumpe &amp; Gregersen AS Lilleakerveien 10 P.O. Box 98 0216 Oslo Tel. (+47) 22 73 67 00 Fax (+47) 22 7367 86 E-mail: arne.vagn.petersen@axflow.no</p> <p><b>Poland</b> WIKa Polska S.A. Ul. Legska 29/35 87-800 Wloclawek Tel. (+48) 542 30 11 00 Fax (+48) 542 30 11 01 E-mail: info@wikapolska.pl www.wikapolska.pl</p> <p><b>Romania</b> WIKa Instruments Romania S.R.L. Bucuresti, Sector 5 Calea Rahovei Nr. 266-268 Corp 61, Etaj 1 Tel. (+40) 21 4048 327 Fax (+40) 21 4563 137 E-mail: m.anghel@wika.ro</p> <p><b>Russia</b> ZAO WIKa MERA Wjatskaya Str. 27, Building 17 Office 205/206 127015 Moscow Tel. (+7) 495-648 01 80 Fax (+7) 495-648 01 81 E-mail: info@wika.ru www.wika.ru</p> <p><b>Serbia</b> WIKa Merna Tehnika d.o.o. Sime Solaje 15 11060 Beograd Tel. (+381) 11 27 63 722 Fax (+381) 11 75 36 74 E-mail: info@wika.co.yu www.wika.co.yu</p> <p><b>Slovakia</b> WIKa Representative Office Dipl.-Ing. Rainer Artl Ul. Mora Krausza c. 13 94504 Komarno 4 Tel. (+421) 35-778 22 15 Fax (+421) 35 78 52 020 E-mail: r.artl@nexta.sk</p> <p>MICROWELL spol.s.r.o. Ul. SNP 2018/40 92700 Sala Tel. (+421) 31-770 70 82 Fax (+421) 31-770 75 88 E-mail: microwell@microwell.sk</p> <p>EL-TECHNIK, spol.s r.o. Budovatelská 63 08001 Presov Tel. (+421) 51 7733 890 Fax (+421) 51 7733 890 E-mail: fortuna@eltechnik.sk</p> <p><b>Slovenia</b> Matern d.o.o. Morje 159 b 2313 Fram Tel. (+386) 2 6089 014 Fax (+386) 2 6089 018 E-mail: m.zgajin@siol.net</p> <p>Termocenter d.o.o. Zaloska Cesta 149</p>

## Sales and Service International

(Service centers shown in bold text)

Europe	North America	Central/South America	Central/South America
<p>1000 Ljubljana Tel. (+386) 1 5406581 Fax (+386) 1 5400408 E-mail: info@termocenter-tps.si</p> <p><b>Spain</b> Instrumentos WIKA, S.A. C/Josep Carner, 11-17 08205 Sabadell (Barcelona) Tel. (+34) 902 902 577 Fax (+34) 933 938 666 E-mail: info@wika.es www.wika.es</p> <p><b>Sweden</b> AB Svenska Industri Instrument Exportgatan 38D Box 8923 40273 Göteborg Tel. (+46) 31-742 56 00 Fax (+46) 31-742 56 01 E-mail: info@sini.se www.sini.se</p> <p><b>Switzerland</b> Manometer AG Industriestrasse 11 6285 Hitzkirch Tel. (+41) 41-919 72 72 Fax (+41) 41-919 72 73 E-mail: info@manometer.ch www.manometer.ch</p> <p><b>Ukraine</b> WIK A Pribor GmbH Ul. Kujbischeva 63-A 83016 Donetsk Tel. (+38) 062 / 345 34 17 Fax (+38) 062 / 345 34 16 E-mail: info@wika.donetsk.ua www.wika.donetsk.ua</p> <p><b>United Kingdom</b> WIK A Instruments Ltd 4 Gattton Park Business Centre Wells Place Merstham, Redhill RH1 3LG Tel. (+44) 1737 644 008 Fax (+44) 1737 644 403 E-mail: info@wika.co.uk www.wika.co.uk</p>	<p><b>Canada</b> WIK A Instruments Ltd. Head Office 3103 Parsons Road Edmonton, Alberta, T6N 1C8 Tel. (+1) 780-463 70 35 Fax (+1) 780-462 00 17 E-mail: info@wika.ca www.wika.ca</p> <p><b>USA</b> WIK A Instrument Corporation 1000 Wiegand Boulevard Lawrenceville, GA 30043 Tel. (+1) 770-513 82 00 Fax (+1) 770-338 51 18 E-mail: info@wika.com www.wika.com</p> <p><b>Mensor (Sales and Service)</b> <b>201 Barnes Drive</b> <b>San Marcos, TX 78666</b> <b>Tel. (+1) 512-396 4200-15</b> <b>Fax (+1) 512-396 1820</b> <b>E-mail: sales@mensor.com</b> <b>www.mensor.com</b></p>	<p><b>Argentina</b> WIK A Argentina S.A. Gral. Lavalle 3568 (B1603AUH) Villa Martelli Buenos Aires Tel. (+54) 11 4730 18 00 Fax (+54) 11 4761 00 50 E-mail: info@wika.com.ar www.wika.com.ar</p> <p><b>Brazil</b> Wika do Brasil Ind. e Com. Ltda. Av. Ursula Wiegand, 03 Poligono Industrial CEP 18560-000 Iperó - SP Tel. (+55) 15-3459 9700 Fax (+55) 15-3266 1650 E-mail: marketing@wika.com.br www.wika.com.br</p> <p><b>Chile</b> Veto y Cia Ltda. San Eugenio N°567 Nunoa - Santiago, Zip Code 7780008 P. O. Box 10289 Tel. (+56) 2 355 44 00 Fax (+56) 2 355 44 55 E-mail: andres.veto@veto.cl www.veto.cl</p> <p><b>Colombia</b> Flexilatina de Colombia Ltda. Transversal 40, No. 20 - 53 Apartado Aéreo 20216 Santafé de Bogotá Tel. (+571) 269 09 50 Fax (+571) 283 49 74 E-mail: ventas@flexilatina.com</p> <p><b>Costa Rica</b> Central de Mangueras, S.A. 150 Metros Oeste de La Plaza de Deportes de La Uruca San José P.O. Box 241-1150 La Uruca Tel. (+506) 256-1111 Fax (+506) 222-8513 E-mail: ventas@centraldemangueras.com</p> <p>FLOTEC SA P.O. Box 774-1007, San Jose-Costa Rica Tel. (+506) 221-5559 Fax (+506) 223-8457 E-Mail: flotec@racsaco.cr</p> <p><b>Dominican Republic</b> Garlas Controls Euclides Morillo No. 55 Aroyo Hondo Santo Domingo Tel. (+809) 563-3226 Fax (+809) 563-3498 E-mail: juangarcia@garlascontrol.com</p>	<p><b>El Salvador</b> Valvulas y Equipos/Indelpin S.A. de C.V. Res. Escalon Nte. Calle El Escorial y Avenida Los Encinos Block B, No. 14 San Salvador Tel. (+503) 262-2680 Fax (+503) 262-0361 E-mail: valvulasyequipos@integra.com.sv</p> <p><b>Ecuador</b> Disetec Av. Eloy Alfaro N52-225 y Capitan Ramon Borja Quito Tel. (+593) 2-328 12 55 Fax (+593) 2-328 12 77 E-mail: disetec@interactive.net.ec</p> <p><b>Guatemala</b> Maquinara e Insumos Industriales, S.A (MAQUINSA) 10 Calle 0-78 Zona 14 Plaza San Judas Oficina 201 01014 Guatemala Tel. (+502) 363-19 86 Fax (+502) 363-20 26 E-mail: maquina@inteln.net.gt</p> <p><b>Jamaica</b> B.J. Hanna &amp; Sons Ltd. 7 Retirement Crescent Kingston, Jamaica W.I. Tel. (+876) 960-48 90 Fax (+876) 960-48 95</p> <p>T.M. &amp; T. Associates Ltd. 33 Ward Ave. P.O. Box 322 Mandeville, Jamaica W.I. Tel. (+876) 962-53 44 Fax (+876) 962-94 09 E-mail: heavent@cwjamaica.com</p> <p><b>Mexico</b> Instrumentos WIK A Mexico S.A. de C.V. Av. Santa Fe 170 oficina 6-2-18 Lomas de Santa Fe Alvaro Obregon 01210, Mexico D.F. Tel. (+52) 55-5020 5300 Fax (+52) 55-5020 5301 E-Mail: ventas@wika.com www.wika.com.mx</p> <p><b>Nicaragua</b> Buhler Bandas y Mangueras C. Norte, Cerveceria Victoria 2 1/2 c. Arriba P.O. Box 2358 Managua Tel. (+505) 249-36 16 Fax (+505) 276-00 44 E-mail: buhler@ns.tmx.com.ni</p>

## Sales and Service International

(Service centers shown in bold text)

### Central/South America

#### **Panama**

Accesorios Industriales  
AV. Ricardo J. Alfaro, EDIF. Metales, APDO  
0819-08369  
Panama City  
Tel. (+507) 230-1444  
Fax (+507) 230-1413  
E-Mail: Accindsa@cableonda.net

#### **Paraguay**

Petersen Industria & Hogar S.A.  
Santo Tomás e/ Av. Artigas y Vía Férrea  
Asunción  
Tel. (+595) 21 - 20 61 31  
Fax (+595) 21 - 20 61 31  
E-mail: petersen@hpetersen.com.py

#### **Peru**

Logindustrias S.R.L.  
Marques de Torre Tagle 357  
Pisos 6 y 7  
Miraflores, Lima 18  
Tel. (+51-1) 444-23 89  
Fax (+51-1) 446-39 14  
E-mail: logindus@terra.com.pe

#### **Puerto Rico**

Herpla Engineering Corp.  
Calle del Parque 865  
Santurce, PR 00907  
Tel. (+1) 787-727-9500  
Fax (+1) 787-727-9510  
E-Mail: bobby.herrera@herpla.com

#### **Trinidad & Tobago**

Trinidad Valve & Fitting  
P.O. Box Pointe.A.Pierre Rd.  
San Fernando, Trinidad & Tobago W.I.  
Tel. (+868) 652-48 89  
Fax (+868) 652-26 51  
E-mail: trinval@tstt.net.tt

#### **Venezuela**

Grupo Instrucontrol, C.A.  
P.O. Box 14467  
Caracas 1011-A  
Tel. (+58) 212 - 576 33 20  
Fax (+58) 212 - 576 18 42  
E-mail: info@grupoinstrucontrol.net

#### **Australia**

WIKI Australia Pty. Ltd.  
Unit N, 10-16 South Street  
Rydalmere, NSW 2116  
Tel. (+61) 2- 8845 5222  
Fax (+61) 2- 9684 4767  
E-mail: sales@wika.com.au  
www.wika.com.au

WIKI Australia Pty. Ltd.  
Unit 3, 24 Lakeside Drive  
Burwood East, Victoria, 3159  
Tel. (+61) 3 - 8847 2000  
Fax (+61) 3 - 9802 9559  
E-mail: sales@wika.com.au  
www.wika.com.au

#### **New Zealand**

Process Instruments Ltd.  
P.O. Box 57-051  
60 Stoddard Road, Mt. Roskill  
Auckland 1004  
Tel. (+64) 9 - 620 4169  
Fax (+64) 9 - 620 8253  
E-mail: process@iti-pil.co.nz  
www.processi.co.nz

### Africa

#### **Egypt**

WIKI Alexander Wiegand GmbH & Co. KG  
Representative Office  
El-Serag City Towers  
Tower #2, Office #67  
Nasr City, Cairo  
Tel. (+20) 2 2287 6219  
Fax (+20) 2 2287 6219  
E-mail: ahmed.azab@wika.de

#### **Kenya**

Markmann & Company Limited  
Off Enterprise Road  
Industrial Area  
P.O. Box 18404  
Nairobi  
Tel. (+254) 20 - 651431  
Fax (+254) 20 - 650176  
E-mail: info@markmann.co.ke

#### **South Africa**

WIKI Instruments (Pty.) Ltd.  
P.O. Box 75225  
Gardenvue, 2047  
Tel. (+27) 11-621 0000  
Fax (+27) 11-621 0059  
E-mail: sales@wika.co.za  
www.wika.co.za

## Sales and Service International (Service centers shown in bold text)

Asia	Asia	Asia	Asia
<p><b>Brunei</b> Joffren Omar Co. Sdn Bhd Lot No. 23, G-25 area, Simpang 81-4, P.O. Box 105 Seria KB 1133 Negara Brunei Darussalam Tel. (+673) 3 - 22 21 83 Fax (+673) 3 - 22 33 09 E-mail: josks@brunet.bn</p> <p><b>China</b> WIKa International Trading (Shanghai) Co., Ltd. Harbour Ring Plaza, Rm. 1101-1103 Xizang Zhong Road 18 200001 Shanghai Tel. (+86) 21 - 53 85 25 72 Fax (+86) 21 - 53 85 25 75 E-mail: wikash@online.sh.cn</p> <p>WIKa Instrumentation (Suzhou) Co., Ltd. Intersection 81, Ta Yuan Road 215011 Suzhou Tel. (+86) 512 - 68 25 98 41 Fax (+86) 512 - 6825 44 62 E-mail: public@wikachina.com</p> <p>Beijing Laisen Co. LTD Room 3-9D, C Bldg of IN DO Mansion No. 48 Zhichunlu Haidian District Beijing 100086 Mrs. Xie Yunfeng Tel: 011 86 10 58731870 Fax: 011 86 10 58731875 E-Mail: xyf@laisen.com</p> <p><b>Hong Kong</b> PTC International Limited. Unit 1712, Kodak House II 39 Healthy Street East North Point, Hong Kong Tel. (+852) 28 27 99 77 Fax (+852) 25 19 61 80 E-mail: general@ptc.com.hk</p> <p><b>India</b> WIKa Instruments India Pvt. Ltd. Plot No. 40, GAT No. 94 + 100 High Cliff Industrial Estate Village Kesnand Pune - 412 207 Tel. (+91) 20 - 270 52 901 Fax (+91) 20 - 270 51 925 E-mail: sales@wika.co.in www.wika.co.in</p>	<p><b>Iran</b> WIKa Instrumentation Pars (KFZ) Ltd. Unit 15, 4th Floor, Building No. 19, 4th Alley, Ghaem Magham Ave., Upper Mottahari St. Postal code: 1586833944 Tehran Tel. (+98) 21 8854 0252 - 55 Fax (+98) 21 8875 7351 E-Mail: info@wika.ir www.wika.ir</p> <p><b>Israel</b> Technomad Ltd. 19 Hashikma St., Azor P.O. Box 161 Azor 58009 Tel. (+972) 3 - 558 55 50 Fax (+972) 3 - 558 50 90 E-mail: info@technomadtd.co.il</p> <p><b>Japan</b> WIKa Japan K. K. MG Shibaura Bldg. 6F 1-8-4, Shibaura, Minato-ku Tokyo 105-0023 Tel. (+81) 3-5439-6673 Fax (+81) 3-5439-6674 E-mail: t-shimane@wika.co.jp</p> <p>WIKa Japan K. K. Osaka Branch MF Sakurabashi Bldg. 3F 2-6-23 Sonezakishinchi, Kita-ku Osaka 530-0002 Tel. (+81) 6 - 63 47 - 15 33 Fax (+81) 6 - 63 47 - 15 34 E-mail: t-otsuka@wika.co.jp</p> <p>Sankyo International Corp. 9-14, Nihonbashi-Yokoyamacho Chuo-ku, Tokyo 103-0003 Ayumu Komatsuzaki Susumu Miyamoto Tel: 011 81 3 3662 8100 Fax: 011 81 3 3662 8050 E-Mail: a.komatsuzaki@sankyointernational. co.jp</p> <p><b>Jordan + Syria</b> Ramallah Engineering &amp; Chemical Est. P.O.Box 925 682 Amman 11110 Jordan Tel. (+962) 6 - 553 82 56 Fax (+962) 6 - 551 82 57 E-mail: ramallah@wanadoo.jo</p> <p><b>Kazakhstan</b> TOO WIKa Kazakhstan 050050, Almaty Raimbekstr. 169, 3rd floor Tel. (+7) 727 233 08 48 - 49 Fax (+7) 727 278 99 05 E-mail: info@wika.kz</p>	<p><b>Korea</b> WIKa Korea Ltd. #704 DaeRyung Technotown II 569-21, Gasan-dong Kumcheon-gu Seoul 153-023 Tel. (+82) 2 - 869 0505 Fax (+82) 2 - 869 0525 E-mail: info@wika.co.kr</p> <p>WIKa Korea Ltd. (Ulsan Office) #201, DaeSung Bldg., 1550-1 Samsan-Dong, Nam - Gu Ulsan 680-815 Tel. (+82) 52 - 257 88 44 Fax (+82) 52 - 257 88 47 E-mail: info@wika.co.kr</p> <p>Samsawon Inc. K.P.O. Box 707 Seoul 110-607 Tel. (+82) 2 - 395 34 00 Fax (+82) 2 - 396 03 40 E-mail: samsawon@samsawon.co.kr www.samsawon.co.kr</p> <p>Jung Jin Pressure Systems Dae Wond B/D 5F, 174-28 Karak-Dong Songpa-Gu Seoul 138-811 J. U. Lee Tel: 011 82 2 3402 2633 Fax: 011 82 2 3402 2635 E-Mail: jjsys@hanafos.com</p> <p><b>Lebanon</b> Al-Husam Generae Trading + Contracting Est. Zalka - Amaret Chalhoub Audi Building P.O. Box 90/286 Beirut Tel. (+961) 1-88 50 61 Fax (+961) 1-88 50 61 E-mail: alhusam@inco.com.lb</p> <p><b>Malaysia</b> WIKa Instrumentation (M) Sdn. Bhd. No. 27 &amp; 29 Jalan Puteri 5/20 Bandar Puteri Puchong 47100 Puchor, Selangor Tel. (+603) - 8063 1080 Fax (+603) - 8063 1070 E-mail: info@wika.com.my www.wika.com.my</p> <p><b>Philippines</b> Nasa Trading Phil. Co., Inc. Rm. 606 Pacific Bank Bldg. Gandara cor. Q. Paredes Sts. 1006 Binondo - Manila Tel. (+63) 2-743-3469 Fax (+63) 2-740-5773 E-mail: nasatrad@i-manila.com.ph</p>	<p><b>Singapore</b> WIKa Instrumentation Pte.Ltd. Block 4008, #04-11/15 Ang Mo Kio Avenue 10 Techplace 1 569625 Singapore Tel. (+65) 68 44 55 06 Fax (+65) 68 44 55 07 E-mail: info@wika.com.sg www.wika.com.sg</p> <p><b>SINGAPORE (Sales and Service)</b> <b>TIS Instruments (S) PTE LTD</b> <b>7 Toh Guan Road East</b> <b>#08-08 Alpha Industrial Bldg</b> <b>Singapore 608599</b> <b>Gwee Cheng Yong</b> <b>Tel: 011 65 6779 9272</b> <b>Fax: 011 65 6873 8262</b> <b>E-Mail: gweecy@tisinstruments.com</b></p> <p><b>Taiwan</b> WIKa Instrumentation Taiwan Ltd. No. 26, Alley 53, Lane 118, Sec. Shuang-Lien 2, Min-Tsu Road, Pinjen, Taoyuan Tel. (+886) 3 4 20 60 52 Fax (+886) 3 4 90 00 80 E-mail: info@wika.com.tw www.wika.com.tw</p> <p><b>Thailand</b> Kanit Engineering Corporation Ltd. 800/3-4 Asoke - Dindaeng Road Dindaeng Bangkok 10400 Tel. (+66) 2 - 245 04 19 Fax (+66) 2 - 246 32 14 E-mail: sales1@kanitengineering.co.th www.kanit.co.th</p> <p>MB Sales and Services Co., LTD Dr. Gerhard Link Bldg 88 Krungthepkreetha Road Huamark, Bangkok Bangkok 10240 Mike Bailey Tel: 011 66 2 379 4152, 731, 6990 Fax: 011 66 2 379 4153 Cell: 011 66 81 835 0920 E-Mail: mikebailey@mb-th.com info@mb-th.com</p> <p><b>Turkey</b> WIKa Türkiye irtibat bürosu, Zümrütevler Hanımeli Cad. No. 4 Kat 4 İstanbul - Maitepe E-mail: H.Kizilkaya@wika.de</p> <p><b>United Arab Emirates</b> WIKa Middle East FZE Warehouse No. RB08JB02 P.O. Box 17492 Jebel Ali, Dubai Tel. (+971) 4 - 883 90 90 Fax (+971) 4 - 883 91 98 E-mail: wikame@emirates.net.ae</p>



## Measurement units

The Units command selects the measurement units to be output on the bus and the display.

**Table – Measurement Units (unit no)**

Code	Description	Output Format
2	inches of mercury @ 0 °C	inHg 0 °C
3	inches of mercury @ 60 °F	inHg 60 °F
4	inches of water @ 4 °C	inH <sub>2</sub> O 4 °C
5	inches of water @ 20 °C	inH <sub>2</sub> O 20 °C
6	inches of water @ 60 °F	inH <sub>2</sub> O 60 °F
7	feet of water @ 4 °C	ftH <sub>2</sub> O 4 °C
8	feet of water @ 20 °C	ftH <sub>2</sub> O 20 °C
9	feet of water @ 60 °F	ftH <sub>2</sub> O 60 °F
10	millitorr	mTorr
11	inches of seawater @ 0 °C 3.5 % salinity	inSW
12	feet of seawater @ 0 °C 3.5 % salinity	ftSW
13	atmospheres	atm
14	bars	bar
15	millibars	mbar
16	millimeters of water @ 4 °C	mmH <sub>2</sub> O 4 °C
17	centimeters of water @ 4 °C	cmH <sub>2</sub> O 4 °C
18	meters of water @ 4 °C	mH <sub>2</sub> O 4 °C
19	millimeters of mercury @ 0 °C	mmHg 0 °C
20	centimeters of mercury @ 0 °C	cmHg 0 °C
21	torr	Torr
22	kilopascals	kPa
23	pascals	PA
24	dyne per square centimeter	dy/cm <sup>2</sup>
25	grams per square centimeter	gm/cm <sup>2</sup>
26	kilograms per square centimeter	kg/cm <sup>2</sup>
27	meters of seawater @ 0 °C 3.5 % salinity	m SW
28	ounce per square inch	OSI
29	pounds per square foot	PSF
30	tons per square foot	TSF
31	percent of full scale	% FS
32	micron HG @ 0 °C	μHg 0 °C
33	ton per square inch	tsi
34	n/a	n/a
35	hectopascals	hPa
36	megapascals	MPa
37	millimeters of water @ 20 °C	mmH <sub>2</sub> O 20 °C
38	centimeter of water @ 20 °C	cmH <sub>2</sub> O 20 °C
39	meters of water @ 20 °C	mH <sub>2</sub> O 20 °C
n/a	User Units 1	User defined
n/a	User Units 2	User defined

## Conversion factors, pascal

The following table lists factors which should be used as multipliers when converting other pressure units to or from Pascal.

**Table – Conversion Factors, Pascal**

Unit No.	Pressure Unit	To Convert from Pascal	To Convert to Pascal
1	psi	1.450377E-04	6.894757E+03
2	inHG @ 0 °C	2.952997E-04	3.386390E+03
3	inHG @ 60 °F	2.961339E-04	3.376850E+03
4	inH <sub>2</sub> O @ 4 °C	4.014741E-03	2.490820E+02
5	inH <sub>2</sub> O @ 20 °C	4.021862E-03	2.486410E+02
6	inH <sub>2</sub> O @ 60 °F	4.018645E-03	2.488400E+02
7	ftH <sub>2</sub> O @ 4 °C	3.345622E-04	2.988980E+03
8	ftH <sub>2</sub> O @ 20 °C	3.351551E-04	2.983692E+03
9	ftH <sub>2</sub> O @ 60 °F	3.348871E-04	2.986080E+03
10	mTORR	7.500636E+00	1.333220E-01
11	inSW @ 0 °C 3.5% sal	3.904899E-03	2.560885E+02
12	ftSW @ 0 °C 3.5% sal	3.254082E-04	3.073062E+03
13	atm	9.869230E-06	1.013250E+05
14	bar	1.00000E-05	1.00000E+05
15	mbar	1.00000E-02	1.00000E+02
16	mmH <sub>2</sub> O @ 4 °C	1.019744E-01	9.806378E+00
17	cmH <sub>2</sub> O @ 4 °C	1.019744E-02	9.806378E+01
18	mH <sub>2</sub> O @ 4 °C	1.019744E-04	9.806378E+03
19	mmHG @ 0 °C	7.500636E-03	1.333220E+02
20	cmHG @ 0 °C	7.500636E-04	1.333220E+03
21	TORR	7.500636E-03	1.333220E+02
22	KPA	1.00000E-03	1.00000E+03
23	Pa	1.00000E+00	1.00000E+00
24	DYNE/SQ cm	1.00000E+01	1.00000E-01
25	g/sq cm	1.019716E-02	9.806647E+01
26	kg/sq cm	1.019716E-05	9.806647E+04
27	mSW @ 0 °C 3.5% sal	9.918444E-05	1.008222E+04
28	OSI	2.320603E-03	4.309223E+02
29	PSF	2.088543E-02	4.788025E+01
30	TSF	1.044271E-05	9.576052E+04
32	MICRON HG @ 0 °C	7.500636E+00	1.333220E-01
33	TSI	7.251885E-08	1.378951E+07
35	hPA	1.00000E-02	1.00000E+02
36	MPA	1.00000E-06	1.00000E+06
37	mmH <sub>2</sub> O @ 20 °C	1.021553E-01	9.789017E+00
38	cmH <sub>2</sub> O @ 20 °C	1.021553E-02	9.789017E+01
39	mH <sub>2</sub> O @ 20 °C	1.021553E-04	9.789017E+03

**NOTES**



**Mensor**

201 Barnes Drive  
San Marcos, Texas 78666  
Phone: 512.396.4200  
Fax: 512.396.1820  
Web site: [www.mensor.com](http://www.mensor.com)  
E-mail: [sales@mensor.com](mailto:sales@mensor.com)



**WIKAI Alexander Wiegand SE & Co. KG**

Alexander-Wiegand-Straße 30  
D-63911 Klingenberg / Germany  
Tel: +49 - (0) 93 72/132-9986  
Fax: +49 - (0) 93 72/132-8767  
E-mail: [testequip@wika.de](mailto:testequip@wika.de)  
[www.wika.de](http://www.wika.de)