

# Portable multimeters with digital display

## *ASYC-IV*

**MTX 3290 - 6000 cts**

**MTX 329 I - 60000 cts**

### Operating instructions



# Contents

<b>General directions</b> .....	<b>3</b>
Introduction, Precautions and safety measures.....	3
Special functions.....	4
Symbols on the instrument.....	5
Warranty, Maintenance, metrological verification, Repair under warranty.....	6
Maintenance.....	7
Replacing the fuse.....	7
Rechargeable and primary batteries.....	7
Communication interface.....	7
<b>Description of the instruments</b> .....	
<b>MTX 3290</b> frontal panel, back, terminal block.....	8
<b>MTX 3291</b> frontal panel, back, terminal block.....	9
Display unit.....	10
Switch.....	13
Keypad.....	15
<b>Getting started</b> .....	<b>18</b>
Preparation for use.....	18
<b>Functional description</b> .....	<b>19</b>
1. MAX MIN AVG mode.....	19
2. PEAK mode.....	22
3. $\Delta$ REL mode.....	23
4. "CLAMP" function.....	25
Functions of the switch and keys.....	26
<b>How are the various quantities measured?</b> .....	<b>28</b>
1. Voltage measurement.....	28
2. Current measurement.....	29
3. Frequency measurement.....	31
4. Resistance measurement.....	31
5. Audible continuity measurement.....	32
6. Diode test.....	32
7. Capacitance measurement.....	33
8. Temperature measurement.....	34
9. Measurement on an MLI type speed variator.....	35
10. Resistive power ( <b>MTX 3291</b> ).....	37
11. dBm decibels in power ( <b>MTX 3291</b> ).....	38
<b>SX-DMM software</b> .....	<b>39</b>
<b>Technical characteristics of MTX 3290</b> .....	<b>40</b>
<b>Technical characteristics of MTX 3291</b> .....	<b>50</b>
<b>General characteristics</b> .....	<b>61</b>
Environmental conditions.....	61
Power supply.....	61
Display.....	61
Safety, CEM.....	61
<b>Mechanical characteristics</b> .....	<b>61</b>
Housing.....	61
<b>Supply</b> .....	<b>62</b>

## General directions

### Introduction



**Congratulations!** You have just acquired a **portable multimeter with a display digital**.

We thank you for this sign of confidence in the quality of our products.

The line of instruments to which it belongs comprises the following models:

	<b>MTX 3290</b>	<b>MTX 3291</b>
Display	digital, monochrome, (70x52)	digital, monochrome, backlit (70x52)
Power supply	4 R6 primary batteries (AA format) or 4 rechargeable batteries	
Counts	6000	60000
Communication	-	IR/USB

It complies with safety standard NF EN 61010-1 + NF EN 61010-2-030 concerning electronic measuring instruments.

For best results, read this manual closely and observe the precautions of use.

Failure to observe these warnings and/or directions may damage the instrument and/or its components and may endanger the user.

### Precautions and safety measures



- This instrument is been designed to be used as follows:
  - indoors
  - in an environment of pollution degree 2
  - at an altitude of less than 2000m
  - at a temperature between -10°C and 55°C
  - at a relative humidity below 80% up to 31°C.
- The safety of any system incorporating the instrument is the responsibility of the system integrator.
- Can be used for measurements on circuits:
  - **MTX 3290**: 600V, CAT III and 300V, CAT IV.
  - **MTX 3291**: 1000V CAT III and 600 CAT IV.

However, some accessories may lead to the use of this instrument on circuits of a lower voltage and category.

#### before use

- Comply with the environmental and storage conditions.
- Check the integrity of the guards and insulation of the accessories. Any item of which the insulation is deteriorated (even partially) must be removed from service and scrapped. A change of colour of the insulation is a sign of deterioration.

#### during use

- Read closely all notes preceded by the  symbol.
- As a safety measure, use only the appropriate leads and accessories supplied with the instrument or approved by the manufacturer.

## General directions (continued)

### Safety feature

- It is impossible to open the battery or fuse compartment without first disconnecting the measurement leads.
- During a measurement exceeding 60V<sub>DC</sub> or 25V<sub>AC</sub> the  symbol blinks on the display unit
- Automatic detection of a connection to the "Ampere" terminal (for both voltage and current measurements)
- When the maximum permanent voltage or current that can be measured is exceeded, an intermittent audible signal warns of the risk of an electric shock.

### Features protecting the measurement inputs

These multimeters have several features to protect them:

- varistor protection that clips transient voltage surges on the measurement terminals.
- PTC (Positive Temperature Coefficient) protection against permanent overvoltages less than or equal to 1000V during resistance, capacitance, and diode test measurements. This protection is reset automatically after the overload.
- a fuse that provides protection during current measurements.
  - **MTX 3290**: 10A
  - **MTX 3291**: 11A

### Special functions

#### Automatic detection

The number of input terminals is limited to 3: **V**, **COM**, **A**. Connecting the lead to the "Ampere" terminal automatically selects the corresponding function.

 **When a change of function by the command keypad is incompatible with the connection of the lead, it triggers an audible or visual (LEADS) alert.**

The current measurement is made with automatic peak range full-scale. During a current measurement, an audible alert is triggered in the event of a prolonged absence of current.

#### Automatic switching off

If the function is validated () **P**), the device is automatically switched off after 30 mn of operation if there has been no action on the front panel during this time.

 **Automatic switching off is disabled:**

- **in the MAX, MIN, AVG, PEAK Surveillance mode**
- **in the Communication mode**
- **if there is a voltage >60V<sub>DC</sub> or 25V<sub>AC</sub> on the terminals of the multimeter.**

#### Warning signals

An intermittent audible signal is emitted in all "Voltage" and "Current" settings if the max. permanent value the device can measure is exceeded. It is accompanied by display of the "O. L" acronym and of the  symbol on the display unit.



This symbol is activated when the voltage on the "V" input exceeds 60V<sub>DC</sub> or 25V<sub>AC</sub> in the "Voltage" setting or when the current injected between the **A** and **COM** terminals exceeds 10A.

## General directions (continued)

### Definitions of the measurement categories



**CAT II:** Test and measurement circuits directly connected to the points of use of the low-voltage network (power outlets and other similar points).  
*E.g.: Measurements on the network circuits of household appliances, portable tools, and similar devices.*

**CAT III:** Test and measurement circuits connected to parts of the low-voltage network of the building.  
*E.g.: Measurements on distribution panels (including secondary meters), circuit-breakers, wiring including cables, bus bars, branch boxes, disconnecting switches, power outlets in the fixed installation, and industrial appliances and other equipment, such as motors permanently connected to the fixed installation.*

**CAT IV:** Test and measurement circuits connected to the source of the low-voltage network of the building.  
*E.g.: Measurements on devices installed before the main fuse or the circuit-breaker of the building installation.*

**Warning!** *Using a measuring instrument, a lead, or an accessory belonging to a lower measurement or voltage category derates the resulting system (instrument + leads + accessories) to the lowest measurement category and/or service voltage of any of the components.*

### Symbols on the instrument



Risk of electric shock: directions for connection and disconnection of the inputs. Always connect the probes or adapters to the instrument before connecting them to the measurement points. Always disconnect the probes or cords from the measurement points before disconnecting them from the instrument. These directions apply before the instrument is cleaned.



Warning: Hazard. The operator must refer to the manual each time this danger symbol is encountered.



Device entirely protected by double insulation or reinforced insulation.



Earth



In the European Union, this product is subject to selective collection for the recycling of electrical and electronic equipment waste in accordance with Directive WEEE 2002/96/EC: this equipment must not be treated as ordinary waste. The spent batteries must not be treated as ordinary waste. Take them in to the appropriate collection point for recycling.



The CE marking indicates conformity with the European "Low Voltage", "EMC", "WEEE" and "RoHS" directives.



USB (*MTX 3291*)



IP67

## General directions (continued)

### Warranty



This equipment is warranted for 3 years against any defect of materials or workmanship, in accordance with the general terms of sale. During the warranty period, the instrument may be repaired only by the manufacturer, who reserves the right to repair the instrument or to replace it or part of it. If the equipment is returned to the manufacturer, the cost of transport to the manufacturer is borne by the customer.

The **warranty** does not apply following:

- improper use of the equipment or use in association with incompatible equipment
- modification of the equipment without the explicit permission of the manufacturer's technical staff
- maintenance done by a person not approved by the manufacturer
- adaptation to a particular application not anticipated in the definition of the equipment or by the user manual
- a shock, a fall, or flooding.

### Maintenance, metrological verification



Before opening the instrument, you must disconnect it from line power and from the measurement circuits and make sure that you are not charged with static electricity, which might destroy internal components. An adjustment, maintenance, or repair of the live instrument must be undertaken only by personnel who are qualified and have familiarized themselves with the directions in this manual.

We recommend a verification of this instrument at least once a year. For checking and calibration, contact one of our accredited metrology laboratories (information and contact details available on request), at our Chauvin Arnoux subsidiary or the branch in your country.

### Unpacking, repacking



All of the equipment has undergone mechanical and electrical checks before being dispatched. When you receive it, carry out a quick check to detect any deterioration that may have occurred during transport. Should the need arise, immediately contact our sales department and notify the carrier of the customary reservations.

Use the original packaging to reship the equipment, if possible. Indicate as clearly as possible, by a note attached to the equipment, the reasons for the transfer.

### Repair under warranty and post warranty

For all repairs before or after expiry of warranty, please return the device to your distributor.

## General directions (continued)

### Maintenance

- Disconnect everything connected to the instrument and press the **ON/OFF** key (  ).
- Use a soft cloth, moistened with soapy water.
- Rinse with a damp cloth and dry rapidly with a dry cloth or forced air.
- Make sure that no foreign objects interfere with the operation of the device by which the leads are snapped into place.

### Replacing the fuse



- Before replacing the fuse (reached by opening the bottom compartment), disconnect the instrument from any source of current. During the replacement, make sure that only a fuse of the appropriate rating and specified type is used. Using another type of fuse and shorting the fuse holder are strictly forbidden.

- Checking the current fuse:

Fuse: SIBA/5019906

**MTX 3291:** 11A: 10x38 – 1,000V - F  
breaking capacity: >20kA

**MTX 3290:** 10A: 6x32 - 600V - F  
breaking capacity: >50kA

### Rechargeable and primary batteries

The multimeter is powered by primary or rechargeable batteries (see above).

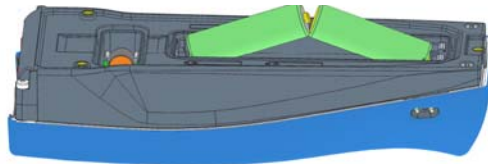

To charge the rechargeable batteries (set of 4 NI-MH LSD batteries), use an external rapid charger, available as an [accessory](#).

 **After replacing the batteries, wait 10s before switching the instrument back on.**

### Active communication interface (MTX 3291 only)



The multimeter can communicate with a PC via the USB link.

The basic version includes a USB link using an isolated optical USB cord (type HX0056Z) and SX-DMM software, plus Labview and Labwindows drivers to program the devices.

-  **MTX 3291: They can also be programmed via the SCPI protocol:**
- to program via Labview/LW
  - to recover data or program the instrument using the software
  - to calibrate the MTX 3291

## Description of the instruments

### MTX 3290

Frontal panel  
Back



Prop



Terminal block

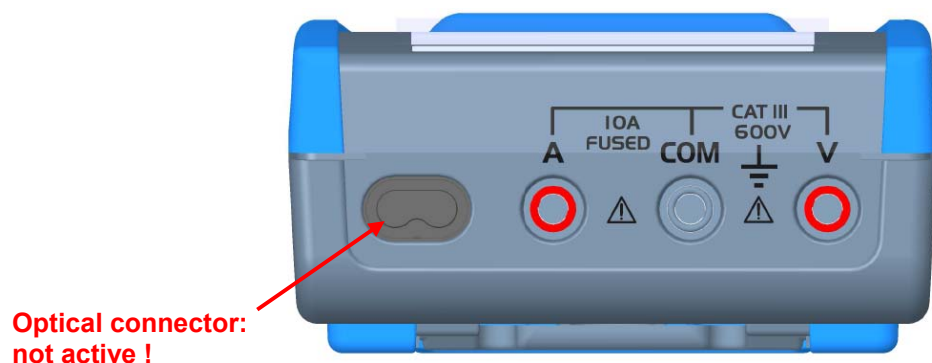



## Description of the instruments (continued)

### MTX 3291

Frontal panel  
Back



Prop



Terminal block

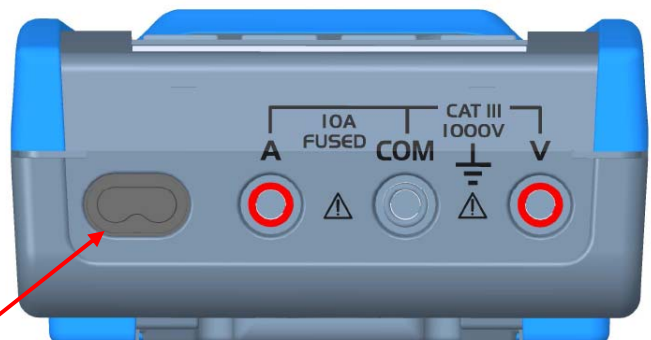

Optical connector: active!

## Description of the instruments (continued)

### Display unit

The display is in two parts:

- A digital display for convenient reading of the digits:
  - main display unit: 12.7mm
  - secondary display unit: 9.7mm
- The "bargraph" display (61 segments) with scale (indication of the measurement range) for an analogue reading

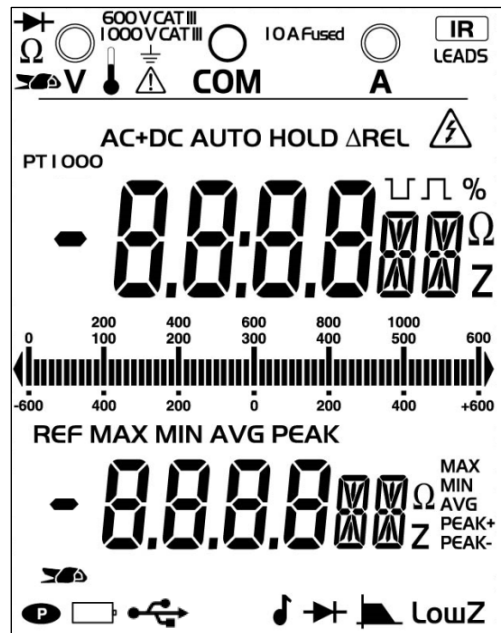

**MTX3290**  
double 6,000-pts display

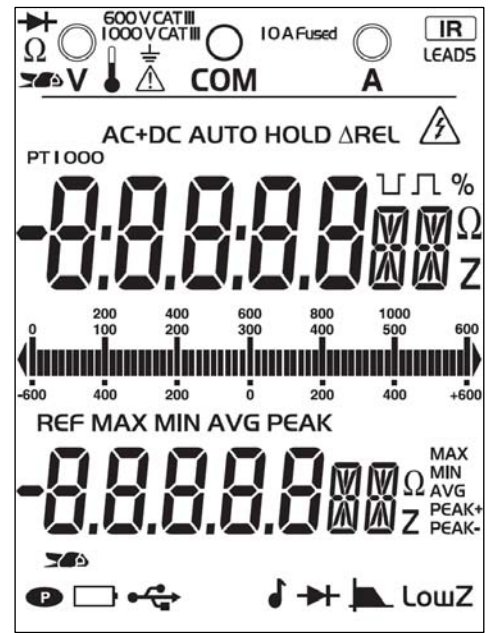

**MTX 3291**  
double 60,000-pts display









### Quantities measured

- $V_{LowZ}$  AC voltage measurement at low impedance ( $V_{LowZ}$ )
- $V_{AC}$  AC voltage measurement
- $V_{AC/DC}$  DC or AC+DC voltage measurement at high impedance (V)
- A Current measurement A
- Hz Frequency measurement
- $\Omega$  Resistance measurement
- $\mu F$  Capacitance measurement
- $T^{\circ}$  Temperature measurement
- ms Measurement of the period
- % Measurement of relative value

### Units

- V Volt
- A Ampere
- Hz Hertz
- $\Omega$  Ohm
- F Farad
- $^{\circ}F$  Degree Fahrenheit
- $^{\circ}C$  Degree Celsius
- ms millisecond
- k kilo k $\Omega$ -kHz
- M Mega M $\Omega$ -MHz
- n nano nF
- $\mu$  micro  $\mu V$ - $\mu A$  - $\mu F$
- m milli mV-mA -mF
- % Percentage

## Description of the instruments (continued)

Symbols	Designation
AC	Measurement of the AC signal
DC	Measurement of the DC signal
AC+DC	Measurement of the AC and DC signal
AUTO	Automatic range switching
$\Delta$ REL	Values relative to a reference
REF	Reference value
HOLD	Storage and display of stored values
MAX MIN AVG	Value (surveillance)
MAX	Maximum value
MIN	Minimum value
AVG	Mean value
PEAK	Peak value
PEAK+	Maximum peak value
PEAK-	Minimum peak value
.run r.un ru.n	Capacitance meter, acquisition in progress
----	Frequency measurement impossible
O.L	Overshoot of the measurement capacities
USER	USER mode (on main display unit)
BASIC	BASIC mode (on main display unit)
Z	Hertz symbol (main display unit)
Z	Hertz symbol (secondary display unit)
$\Omega$	Ohm (main display unit)
$\Omega$	Ohm (secondary display unit)
%	Percentage
	Positive pulse
	Negative pulse
PT100	Symbol for temperature measurement using a Pt100 probe
PT1000	Symbol for temperature measurement using a Pt1000 probe
	Symbol for measurement using a current clamp
LEADS	Function selected incompatible with the connection of the lead
LowZ	Low-impedance voltage measurement
	Symbol of the audible continuity measurement
	Symbol of the measurement and testing of a semiconductor junction
	Warning, possibility of electric shock (*)
	USB communication ( <i>MTX 3291</i> )
	300Hz filter
	Auto power OFF deactivated (permanent mode)

## Description of the instruments (continued)



This symbol indicates the battery charge level.



Volt, Ohm, temperature, etc. measurement input



COM measurement input



Ampere measurement input

**600V CAT III**

Input indication

**1000V CAT III**

Input indication



Isolated optical link (USB) input



Display of unit on the main display unit (2x14 segments)



Display of unit on the secondary display unit (2x14 segments)

Identifies the reminder of the display zone connection

(\* ) When voltages exceeding 60 VDC or 25 VAC are measured, the symbol flashes on the display unit.

## Description of the instruments (continued)

### Switch

Orange LEDs around the highly reliable virtual switch indicate the measurement function chosen. The keys of the switch have priority over the action of the keys of the keypad. The change from one function to another resets the configuration of the measurement mode.

#### MTX 3290

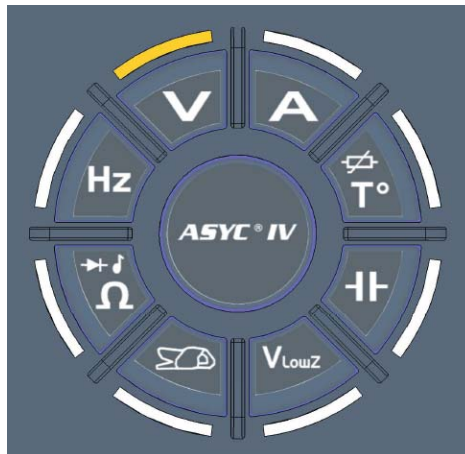

### Keys of the switch

	Short press	Successive short presses
	Current measurement	
	Temperature measurement	Selection of the type of probe: Pt100, Pt1000
	Capacitance measurement	
	Low-impedance AC voltage measurement (VLowZ)	
	Current measurement using a current clamp	Selection of the transformation ratios 1, 10, 100, 1,000mV/A
	Resistance measurement, audible continuity measurement, diode test	Selection of the continuity, diode functions
	Frequency measurement	
	Voltage measurement	

## Description of the instruments (continued)

**MTX 3291**

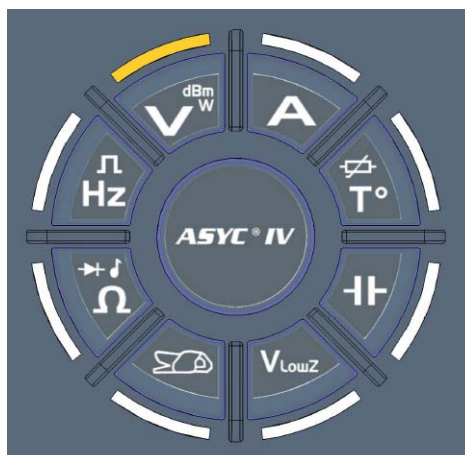

### Keys of the switch

	Short press	Successive short presses
	Current measurement	
	Temperature measurement	Selection of the type of probe: Pt100, Pt1000
	Capacitance measurement	
	Low-impedance AC voltage measurement (VLowZ)	
	Current measurement using a current clamp	Selection of the transformation ratios 1, 10, 100, 1,000mV/A
	Resistance measurement, audible continuity measurement, diode test	Selection of the continuity, diode functions
	Frequency measurement	Selection of the functions: - Positive duty cycle - Negative duty cycle - Positive pulse width - Negative pulse width
	Voltage measurement	Selection of the functions: dBm, W

## Description of the instruments (continued)

### Keypad

The keypad has the following function keys:

The keys are taken into account and applied when pressed. If the key press is validated, the instrument beeps.

Two types of action are possible:

- Short press → press lasting <2 seconds, validated by a beep as soon as the key press is detected.
- Long press → press lasting >2 seconds, validated by a beep as soon as the key press is detected.





MTX 3290







MTX 3291

### Function keys



	Successive short presses	Long press
	Activation/deactivation of storage of the measurements and of the quantities at a given time: <ul style="list-style-type: none"> <li>- Hold of the display without stopping the acquisitions. The bargraph continues to operate normally.</li> <li>- Exit from the HOLD mode</li> </ul> <i>In the MAX/MIN/AVG PEAK mode, when the HOLD is active, the blinking of the "MAX MIN AVG PEAK" symbol indicates that acquisition continues as a background task.</i>	<ul style="list-style-type: none"> <li>- Hold of the display after stabilization of the measurement (Auto HOLD)</li> <li>- Exit from the Auto HOLD mode</li> </ul>
	Choice of coupling <b>AC</b> , <b>DC</b> , <b>AC+DC</b> : <ul style="list-style-type: none"> <li>- Access to various parameters</li> <li>→ In dBm: change of impedance 50Ω, 75Ω, 90Ω, 600Ω (<b>MTX 3291</b> only)</li> <li>→ In temperature: the main display unit indicates the temperature in °C, the other in °F</li> <li>→ In the ΔREL mode, the key is used to change from (present value – reference value) to               <div style="border: 1px solid black; padding: 5px; margin: 10px 0;"> <math display="block">\frac{\text{Present value} - \text{reference value}}{\text{Reference value}} \times 100</math> </div>               The value is displayed in %. (<b>MTX 3291</b> only)             </li> </ul>	Activation/deactivation of auto power off (APO) ( <b>MTX 3291</b> only)
	Activation/deactivation of the low-pass filter ≈ 300Hz: <p>The low-pass filter (4th order) makes it possible to measure the RMS voltage delivered by an MLI type speed controller (for asynchronous motor).</p> <p>See <a href="#">curve</a>, p. 49 and 60.</p>	Activation/deactivation of the key-press beep

## Description of the instruments (continued)

	<p>Manual selection of measurement range: the range defines the maximum measurement range the instrument can cover.</p> <p><b>The Auto Range mode is default.</b></p>	<p>Used to return to Auto Range mode.</p>
<p>(*) </p> <p>(*) see <a href="#">example p. 22.</a></p>	<p>Activation of the <b>Peak+ Peak-</b> measurements:</p> <ul style="list-style-type: none"> <li>- <b>Peak+</b>: displays the maximum instantaneous peak value of the measurement.</li> <li>- <b>Peak-</b>: displays the minimum instantaneous peak value of the measurement.</li> <li>- 1<sup>st</sup> press: recording of PEAK+, PEAK- (on the 2nd display unit). The PEAK+ value is displayed as default.</li> <li>- Subsequent presses: look-up of stored values (volatile).</li> </ul>	<p>Exit from the <b>Peak</b> mode</p>
<p>(*) </p> <p>(*) see <a href="#">example p. 19.</a></p>	<p>Activation of the <b>MAX, MIN, AVG</b> measurements:</p> <ul style="list-style-type: none"> <li>- <b>MAX</b> and <b>MIN</b> inform the highest and lowest values of the effective measurement</li> <li>- <b>AVG</b>: displays the mean value of the signal since the key press</li> </ul> <p>Time-stamped value for the min and the max [temporary display (4s) on the main display unit, followed by return to present value]</p> <p>If the time (h:min:sec) exceeds (9:59:59), is displayed ----.</p> <p><b>(MTX 3291 only)</b></p> <ul style="list-style-type: none"> <li>- 1<sup>st</sup> press: recording of the MAX, MIN, AVG (on the 2nd display unit). The max. value is displayed by default.</li> <li>- Subsequent presses: look-up of the stored values (volatile).</li> </ul>	<p>Exit from the <b>MAX, MIN, AVG</b> mode</p>
<p>(*) </p> <p>(*) see <a href="#">example p. 23.</a></p>	<p>Activation of the relative display mode:</p> <ul style="list-style-type: none"> <li>- Display and storage of the reference and differential values in the unit of the quantity measured.</li> <li>- 1<sup>st</sup> press: activates the relative mode ΔREL</li> </ul> <p><math display="block">\frac{\text{present value} - \text{reference value}}{\text{reference value}}</math></p> <p>and stores the measured value that will be used as reference.</p> <ul style="list-style-type: none"> <li>- "REF" indicates the storage of the reference.</li> <li>- Subsequent presses: toggles the display between the measured value and the relative measurement ΔREL.</li> </ul>	<p>Exit from the Δ<b>REL</b> mode</p>



## Description of the instruments (continued)

	Activation of the Backlight: - successive presses to increase the brightness - circular operation: brightness 1 → brightness 2 → brightness 3 → brightness 1	Deactivation of the Backlight
	Activation/Deactivation of the zero centre bargraph: <b>MTX 3290</b> only	
	Activation/Deactivation of auto power off: <b>MTX 3290</b> only	

**Remark 1** - The 0 centre bargraph is managed automatically in Idc and Vdc (**MTX 3291** only).

When the multimeter is switched on:

- 1st press on **Hold** (sustained press)+press on **ON/OFF**  → display of all segments of the display unit.
- 2<sup>nd</sup> press → display of model and version (US/Europe)
- 3<sup>rd</sup> press → software version (display unit 1) and keyboard and display unit board versions (display unit 2)
- 4<sup>th</sup> press → normal operation. An audible beep acknowledges key presses.

**Remark 2** USER/BASIC mode: During power up, the device is in **BASIC** mode (default configuration Volt AC+DC).

- If, when you power up your multimeter, you want to activate the **USER** mode to recover the configuration when the multimeter was switched off, press the **Range** key, hold it down, then press **ON/OFF** ().
- After an automatic power down, the device restarts in **USER** mode.

The main display unit indicates, for 3s, the change to **USER** or **BASIC** mode.

**In the Volt and Ampere functions, the multimeter starts up in AC+DC, as in the USER mode.**

### Connection

*in Volt  
and other functions*



*in Ampere*



# Getting started

## Preparation for use

### Instructions before starting up

When you use this multimeter, you must observe the usual safety rules, which:

- protect you from electrical hazards,
- protect the multimeter from operator errors.

For your safety, use only the leads and accessories (clamp meter, etc.) supplied with the instrument. Before each use, make sure that they are in perfect condition.

### Power supply

The devices operate with:

- 4 1.5V alkaline batteries (LR6-AM3-AA) or
- 4 1.2V NI-MH rechargeable batteries of the same type.

The rechargeable batteries cannot be recharged in the multimeter.

### Powering up, down



Press **ON/OFF**  to power up the device.

 **Reminder: after replacing the batteries, wait 10s before powering the device back up.**

**If the multimeter malfunctions, a long press (>2s) on this key can be applied to power down the instrument and then restore normal operation.**

### Power-up configuration

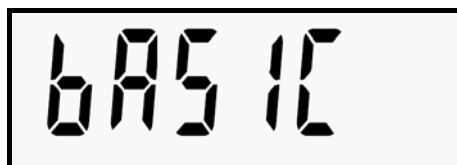

In the **BASIC** mode, as default, the device starts up in its elementary configuration (default values) and in the  $V_{AC+DC}$  function.

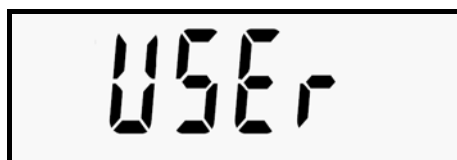

**MTX 3291 only:** in the **USER** mode, the device restarts in the configuration and function selected when it was powered down.

In the Volt and Ampere functions, the instrument restarts in AC+DC.

### Automatic power down

The multimeter automatically switches itself off after 30 minutes if there has been no action on the front panel of the multimeter.

Auto power off is disabled:

- in the **MAX, MIN, AVG, PEAK** mode and in communication
- when the measured quantity (voltage, current) on the input exceeds the danger thresholds, for the user's safety.

# Functional description

**The examples described in this chapter use an**

**1. MAX MIN AVG mode** A beep indicates an overshoot or a change of quantity.

*Displays in the VAC+DC function*

Measured signal: 230V, 50Hz:

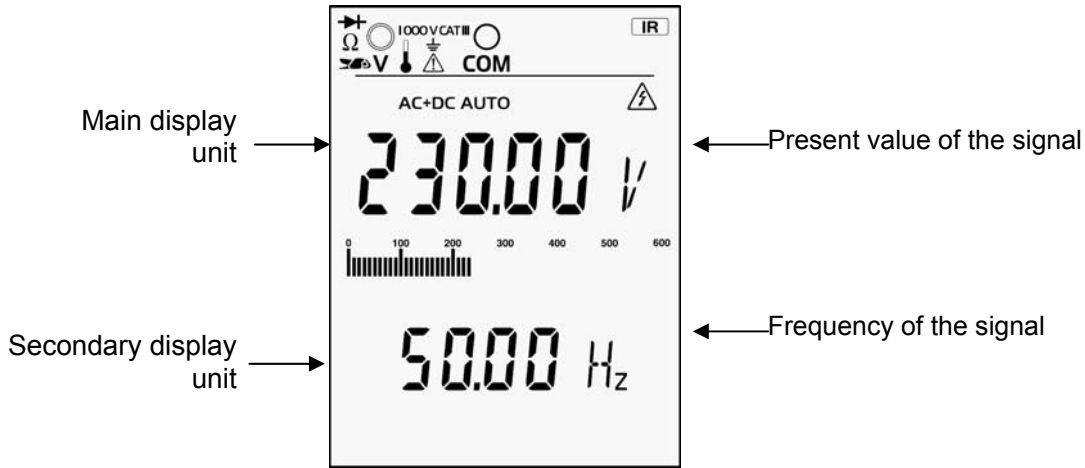

*for the MAX value:* 1<sup>st</sup> press on **MAX/MIN AVG** :

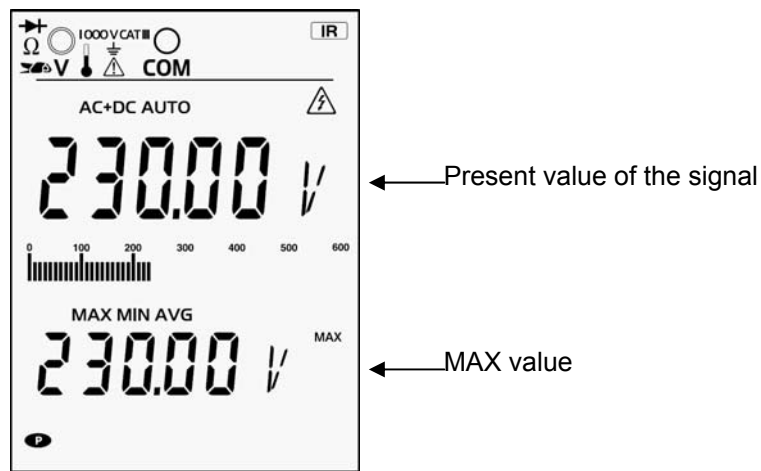

The measured signal changes to 250V, 50Hz:

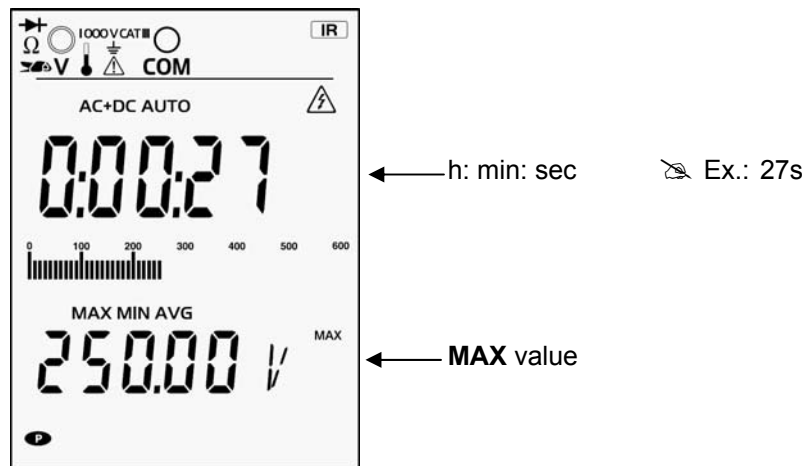

Momentary screen (4s) indicating the time-stamped max. value, if the value changes or if the value is looked up.

## Functional description (continued)

The display then becomes:

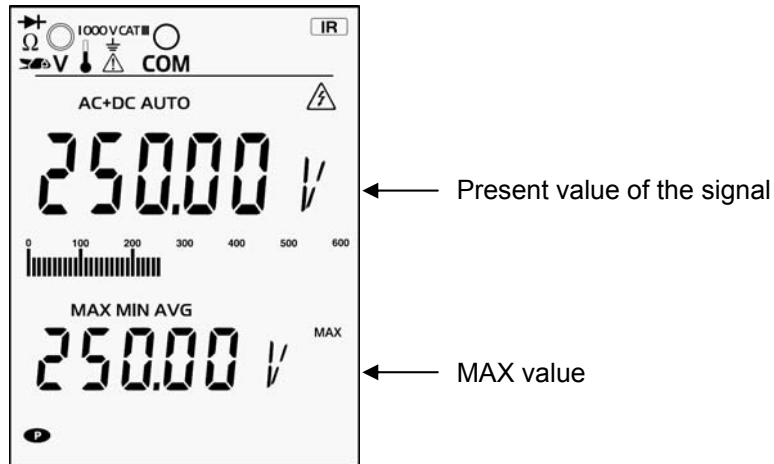

for the MIN value: 2<sup>nd</sup> press **MAX/MIN AVG** :

*Ex.: 3s*

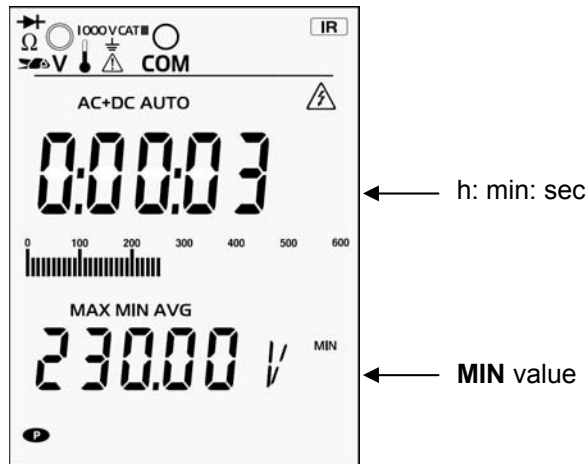

Momentary screen (4s) indicating the time-stamped max. value, if the value changes or if the value is looked up.

The display then becomes:

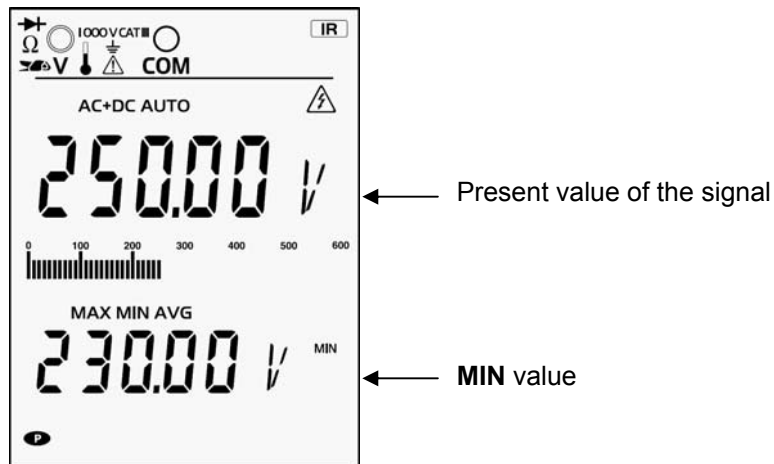

## Functional description (continued)

*for the AVG value:* 3<sup>rd</sup> press on **MAX/MIN  
AVG**:

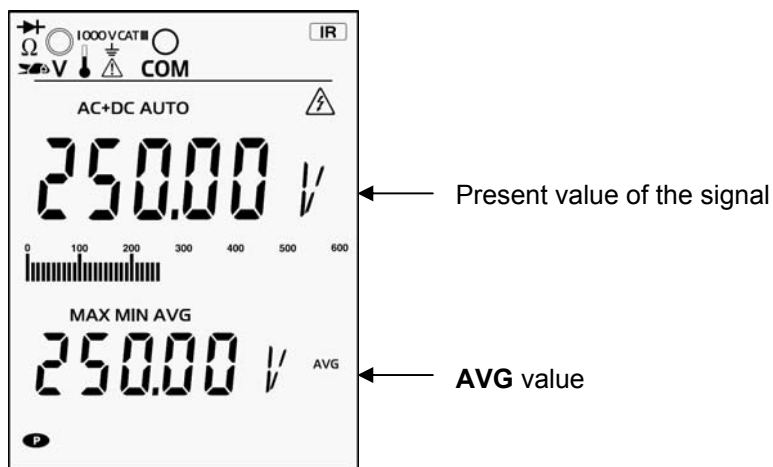

**De-activation** By a long press on the key.

## Functional description (continued)

### 2. PEAK mode

*Displays in the VAC+DC function*

A beep indicates an overshoot or a change of quantity.

Measured signal: 250V, 50Hz:

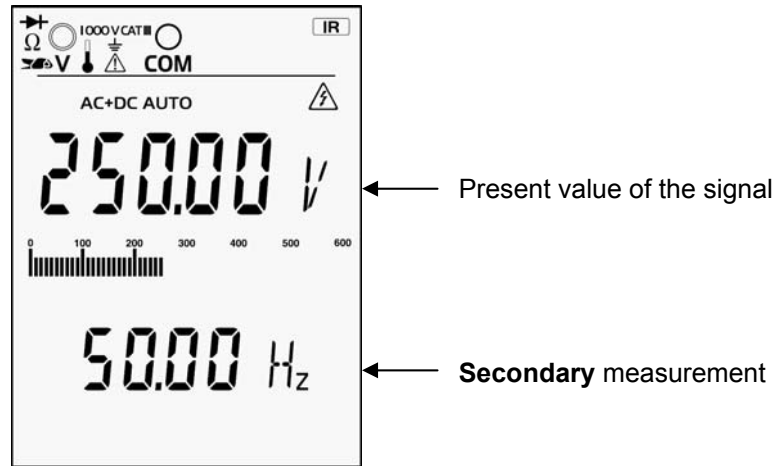

*for the Peak+ value:*

First press on **Peak ±**:

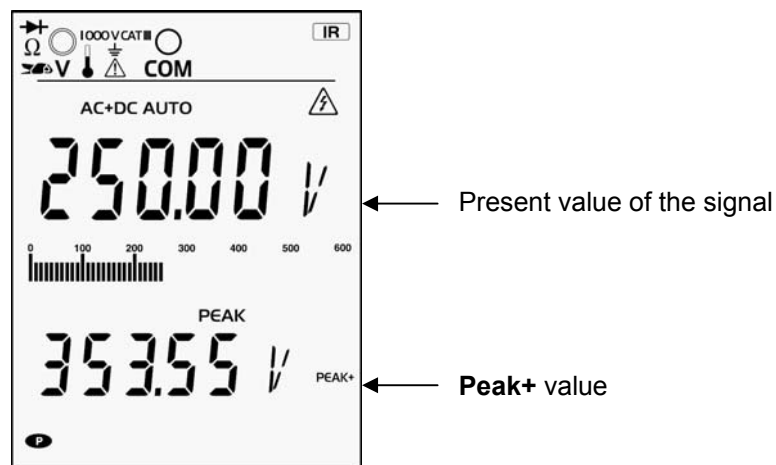

*for the Peak- value:*

Second press on **Peak ±**:

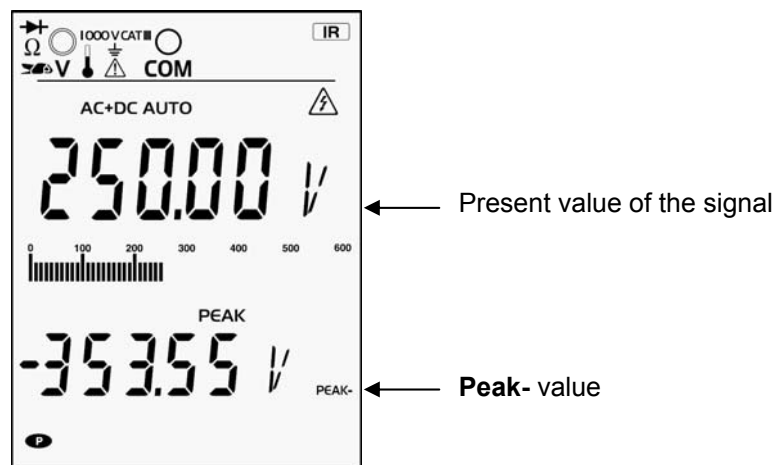

**De-activation** By a long press on the key.

## Functional description (continued)

### 3. $\Delta$ REL mode

*Displays in the VAC+DC function*

Measured signal: 1V, 100Hz:

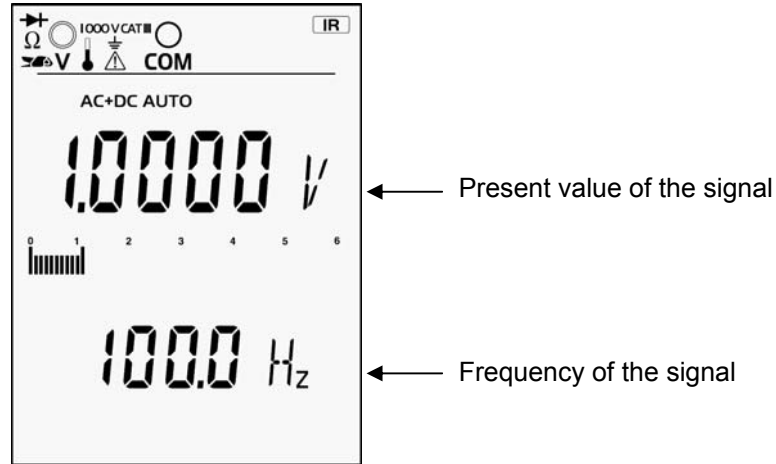

*Activation of the  $\Delta$ REL mode by*

Short press on the  **$\Delta$ Rel** key:

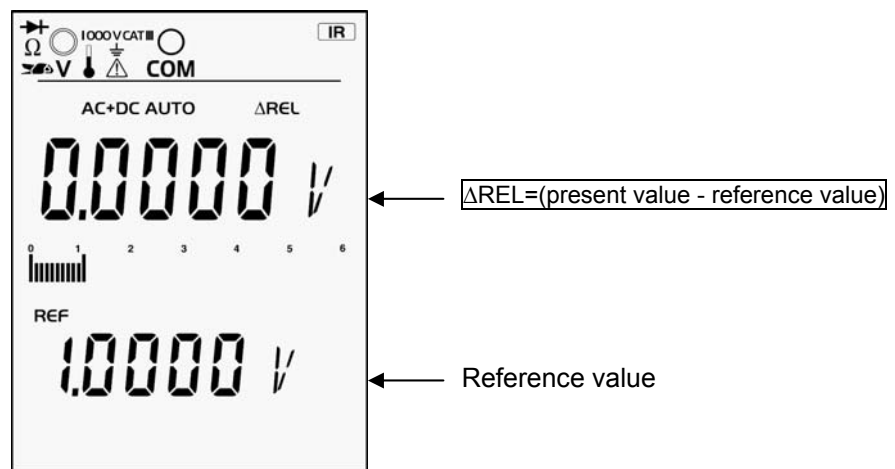

The measured signal changes to 1.5V:  
 $(\Delta\text{REL} = 1.5\text{V} - 1\text{V} = 0.5\text{V})$

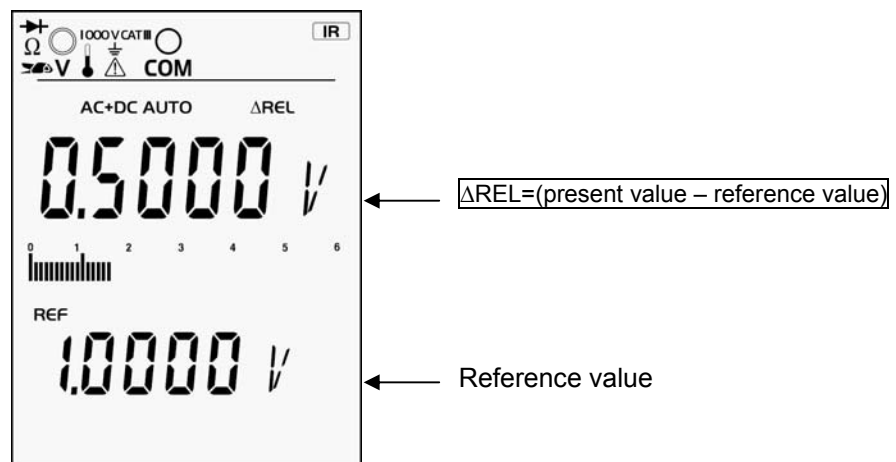

## Functional description (continued)

Short press, in the  $\Delta$ REL mode, on

**MODE**  
**AC/DC** :



$$\Delta\text{REL} (\%) = \frac{\text{Present value} - \text{reference value}}{\text{Reference value}} \times 100$$

Reference value



A long press on the  **$\Delta$ Rel** key erases the reference value.

**De-activation** By a long press on the key.



## Functional description (continued)

### 4. "Clamp" function

 **Ex.: 10mV/A**



← Present value of the signal

← Transformation ratio, selected by















successive presses on  :

- press 1: 1mV/A
- press 2: 10mV/A
- press 3: 100mV/A
- press 4: 1,000mV/A

















## Functional description (continued)

Serial operation of  
the keys of the  
switch

### MTX 3290

	Press 1	Press 2	Press 3	Press 4	Press 5	Short press
	V	V	V	V	V	... 
	I	I	I	I	I	... 
	Pt100	Pt1000	Pt100	Pt1000	Pt100	... 
	Capa	Capa	Capa	Capa	Capa	... 
	VLowZ	VLowZ	VLowZ	VLowZ	VlowZ	... 
	R=1	R=10	R=100	R=1000	R=1	... 
	Ω	Continuity	Diode	Ω	Continuity	... 
	Frequency	Frequency	Frequency	Frequency	Frequency	... 

### MTX 3291



	Press 1	Press 2	Press 3	Press 4	Press 5	Press 6	Short press
	V	dBm	W	V	dBm	W	... 
	I	I	I	I	I	I	... 
	Pt100	Pt1000	Pt100	Pt1000	Pt100	Pt1000	... 
	Capa	Capa	Capa	Capa	Capa	Capa	... 
	VLowZ	VLowZ	VLowZ	VLowZ	VLowZ	VLowZ	... 
	R=1	R=10	R=100	R=1000	R=1	R=10	... 
	Ω	Continuity	Diode	Ω	Continuity	Diode	... 
	Frequency	- Pos. duty cycle	- Neg. duty cycle	- Width of pos. pulse	- Width of neg. pulse	Frequency	... 

## Functional description (continued)

### Functions of the switch and keys

To access the , , , , , , , , dBm, W, continuity, diode, duty cycle, and pulse duration functions, press the button of the switch corresponding to the chosen function.

Here are the possible combinations according to the type of measurement:

Type of measurement	MAX/MIN/ AVG	PEAK ±	ΔREL		RANGE		HOLD	
					Auto.	Manu.		
Voltage V <sub>LowZ</sub> Voltage V <sub>AC</sub> Voltage V <sub>AC+DC</sub> Current A <sub>AC</sub> , A <sub>AC+DC</sub>	✓	✓	✓	in ΔREL <i>only</i>	✓	✓	✓	✓
Voltage V <sub>DC</sub> Current A <sub>DC</sub>	✓	-	✓	✓	✓	✓	✓	-
Voltage 60mV <sub>DC</sub>	✓	-	✓	✓	-	✓	✓	-
Voltage 60mV <sub>AC</sub> Voltage 60mV <sub>AC+DC</sub>	✓	✓	✓	in ΔREL <i>only</i>	-	✓	✓	✓
Temperature	✓	-	✓	-	✓	✓	✓	-
Ohmmeter	✓	-	✓	in ΔREL <i>only</i>	✓	✓	✓	-
Capacitance	✓	-	✓		✓	✓	✓	-
Frequency	✓	-	✓		✓	-	✓	✓
Period (1/F)	✓	-	✓	-	✓	-	✓	✓
Continuity	-	-	-	-	✓	-	-	-
Diode	-	-	-	-	✓	-	✓	-
dBm	-	-	-	-	✓	-	✓	-
W	-	-	-	-	✓	-	✓	-
Duty cycle (DC+, DC-)	-	-	-	-	✓	-	✓	-
Pulse duration (Pw+, Pw-)	-	-	-	-	✓	-	✓	-

## How are the various quantities measured?



The connections illustrated in this chapter were made with an MTX 3290 multimeter (6,000 points). They would be the same with an MTX 3291 (60,000 pts).

### 1. Voltage measurement



: AC voltage measurement, or measurement of an AC voltage superposed on a DC voltage, or DC voltage measurement at high impedance.



: This position is provided to allow measurements in electrical installations. The input impedance  $<1\text{M}\Omega$  serves to avoid measuring "phantom" voltages due to couplings between the lines.

In all cases, "O.L" is displayed above 1050V (**MTX 3291**) or 620V (**MTX 3290**) and a beep sounds when the measurement exceeds 1000V (**MTX 3291**) or 600V (**MTX 3290**).

1. Press:  or .

2. Select AC+DC, AC or DC coupling of the signal by pressing

**MODE**  
**AC/DC**

Depending on what you select, the screen displays DC, AC or AC+DC.

3. Connect the black lead to the "COM" terminal and the red lead to "V".  
 ⚠ *If the connection is not correct, an audible beep and a visible signal (LEADS) are activated.*

4. Place the test probes on the terminals of the circuit to be measured:

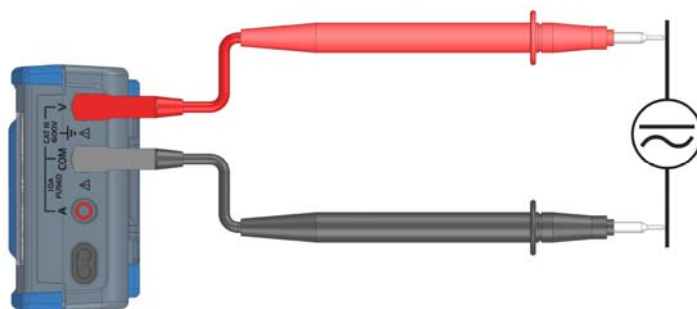

5. Read the measurement value indicated on the display unit.

6. As default, the 2<sup>nd</sup> display unit indicates the frequency, except in DC.



⚠ *It is possible to activate the  filter in V<sub>LowZ</sub>, V<sub>AC+DC</sub>, V<sub>AC</sub>. The cutoff frequency of the filter is  $\leq 300\text{Hz}$ .*

*When a voltage having a frequency above 150Hz is measured, it is heavily attenuated, and so a large error may be observed. It is necessary in this case to deactivate the filter to have the full passband.*

## How are the various quantities measured? (continued)

### 2. Current measurement

as an ammeter

1. Press: .
2. Select the type of signal, AC+DC, AC, or DC, by pressing . Depending on what you select, the screen displays AC, DC, or AC+DC.
3. Connect the black lead to the "COM" terminal and the red lead to "A".  
*If the connection is not correct, an audible beep and a visible signal (LEADS) are activated.*
4. Place the test probes in series between the source and the load:

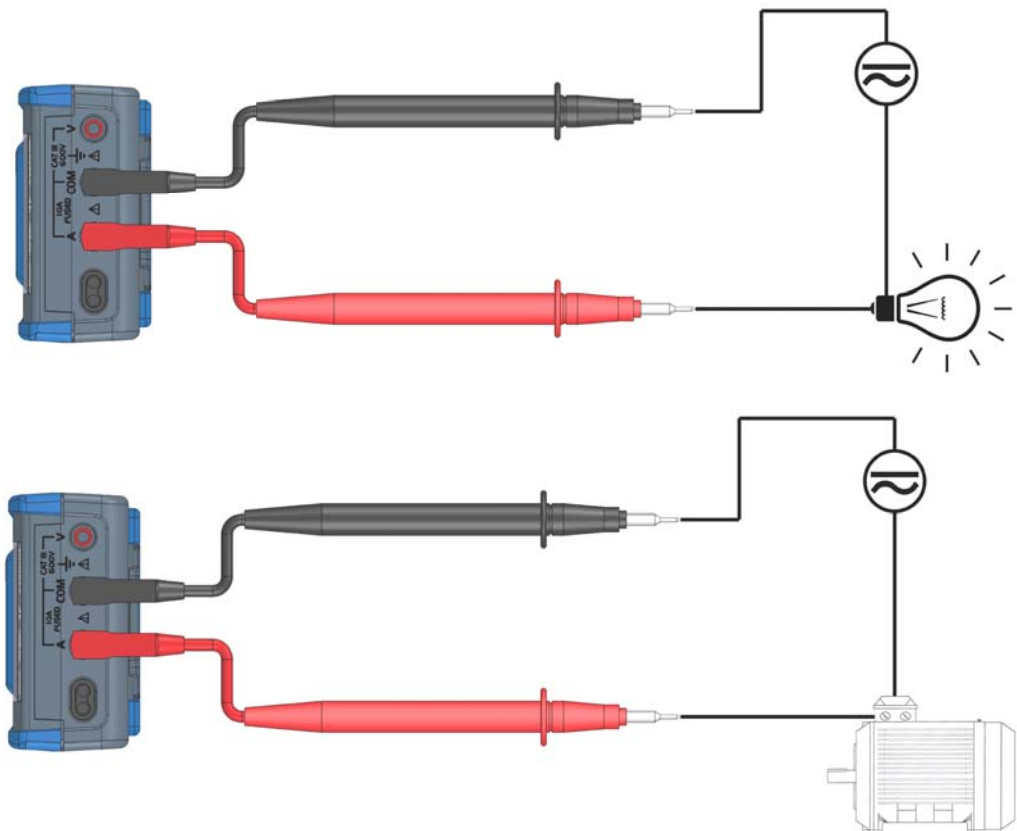



5. Read the measurement value indicated on the display unit.  
"O.L." is displayed, if  $I > 20A$ .
6. As default, the 2<sup>nd</sup> display unit indicates the frequency, except in DC.

*It is possible to activate the  filter in AAC+DC, AAC. The cutoff frequency of the filter is  $\leq 300Hz$ . When a voltage having a frequency above 150Hz is measured, it is heavily attenuated, and so a large error may be observed. It is necessary in this case to deactivate the filter to have the full passband.*



## How are the various quantities measured? (continued)

with a current clamp

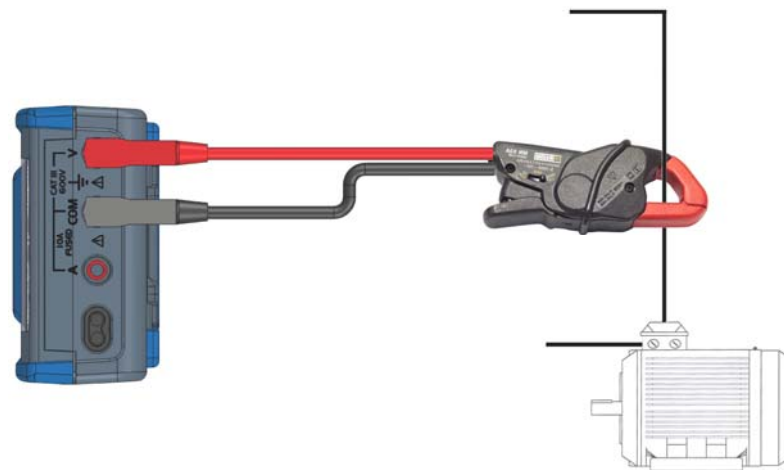
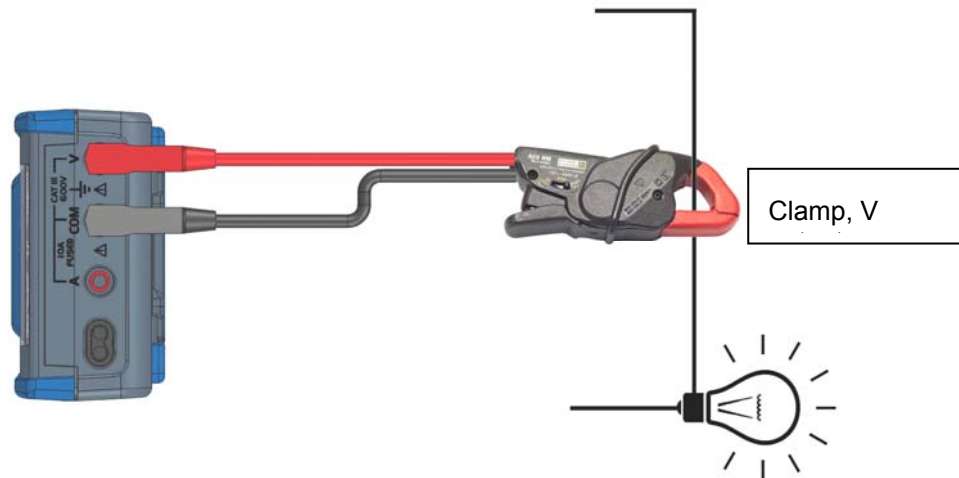
1. Press:  .
2. Select the type of signal, AC+DC, AC, or DC, by pressing  .  
Depending on what you select, the screen displays AC, DC, or AC+DC.
3. Connect the black lead of the clamp to the "COM" terminal and the red lead of the clamp to "V".
4. Select the transformation ratio (the same as that of the clamp) - 1mV/A, 10mV/A, 100mV/A, or 1000mV/A - by pressing on "clamp" (  ) to have a direct reading of the current.
5. Place the clamp around the conductor:







7. **Read the measurement value indicated on the display unit.** The measurement accuracy is indicated in "Technical characteristics", §. "Clamp" p. 46.
8. As default, the 2<sup>nd</sup> display unit indicates the transformation ratio in mV/A.



 **It is possible to activate the  filter in AAC+DC, AAC. The cutoff frequency of the filter is  $\leq 300\text{Hz}$ . When a voltage having a frequency above 150Hz is measured, it is heavily attenuated, and so a large error may be observed. It is necessary in this case to deactivate the filter to have the full passband.**

## How are the various quantities measured? (continued)

### 3. Frequency measurement

1. Press:  .
  2. Connect the black lead to the “COM” terminal and the red lead to “V”.
  3. Place the test probes on the terminals of the circuit to be measured.
-  **Connect the instrument as for a resistance measurement.**
4. Read the measurement value indicated on the display unit. The second display unit indicates the period of the signal, 1/F.
5. Press  several times to obtain (*MTX 3291* only):
    - positive duty cycle (DC+)
    - negative duty cycle (DC-)
    - positive pulse duration (Pw+)
    - negative pulse duration (Pw-)
-  **It is possible to activate the  filter in AAC+DC, AAC. The cutoff frequency of the filter is  $\leq 300\text{Hz}$ .**

### 4. Resistance measurement

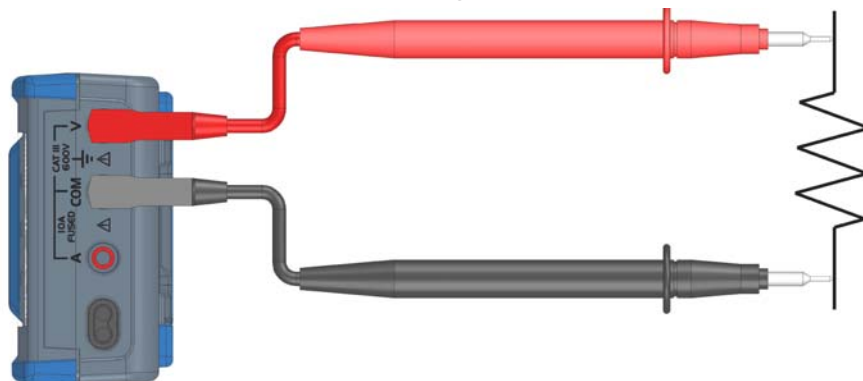

1. Press the  button of the switch.
  2. Connect the black lead to the “COM” terminal and the red lead to “V”.
  3. Place the test probes on the terminals of the component.
-  **Resistance measurements must be made with power off. However, while the presence of a voltage will prevent or throw off the measurement, it will not damage the instrument.**





4. Read the measurement value indicated on the display unit.
5. “O.L.” is displayed, if the circuit is open.

## How are the various quantities measured? (continued)

### 5. Audible continuity measurement

1. Press:  .
  2. Press  again; the "♪" symbol is displayed.
  3. Connect the black lead to the "COM" terminal and the red lead to «V».
  4. Place the test probes on the terminals of the circuit to be measured.
-  **Connect the instrument as for a resistance measurement.**
5. Read the measurement value indicated on the display unit.
  6. The continuity beep sounds when  $R < 30\Omega \pm 5\Omega$ .
  7. "O.L" is displayed, if the circuit is open.

### 6. Diode test

1. Press:  .
2. Press two times  ; the "▶|—" symbol is displayed.
3. Connect the black lead to the "COM" terminal and the red lead to "V".
4. Place the test probes on the terminals of the component:

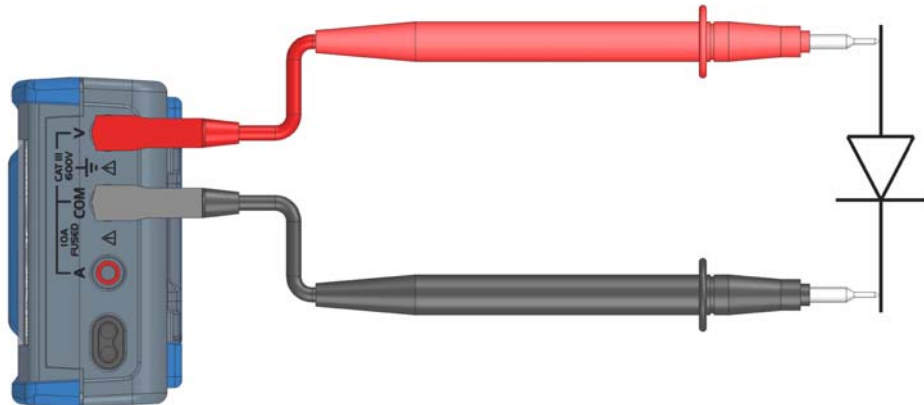

5. Read the measured threshold voltage of the junction indicated on the display unit.  
If the value is  $< 40\text{mV} \pm 10\text{mV}$  an audible signal is triggered.
6. "O.L" is displayed, if the circuit is open or the threshold of the diode  $> 3\text{V}$ .



## How are the various quantities measured? (continued)

### 7. Capacitance measurement

1. Press:  .
2. Connect the black lead to the “COM” terminal and the red lead to “V”.
3. Place the test probes on the terminals of the component:

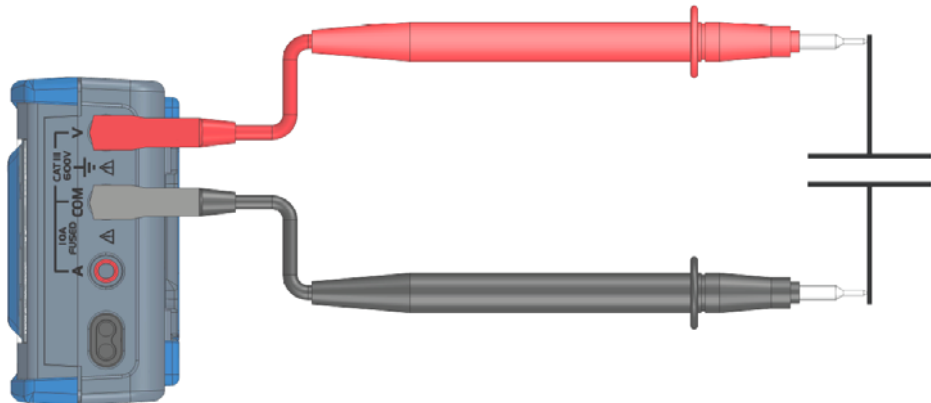

4. Read the measurement value indicated on the display unit.
- “O.L.” is displayed, if the value to be measured exceeds the capacitance of the range.
  - “O.L.” is displayed, if the capacitor is short-circuited.
  - For high values, the measurement cycle includes the display of “run” with a “chaser” decimal point. This means that acquisition is in progress; wait for the display of the digital result.





***“Run” is displayed immediately, if the previous measurement was in a small range.***

- The prior discharge of very high capacitances helps shorten the measurement time.

## How are the various quantities measured? (continued)

### 8. Temperature measurement

1. Press:  .
2. Press  to select the type of probe: Pt100 or Pt1000
3. Press  to switch the temperature unit (°C or °F) between the two display units.

 **The unit displayed as default on the main display unit is °C.**

4. Connect the adapter of the Pt100 or Pt1000 temperature probe (\*) to the "COM" and "V" terminals, making sure that the polarity is correct:

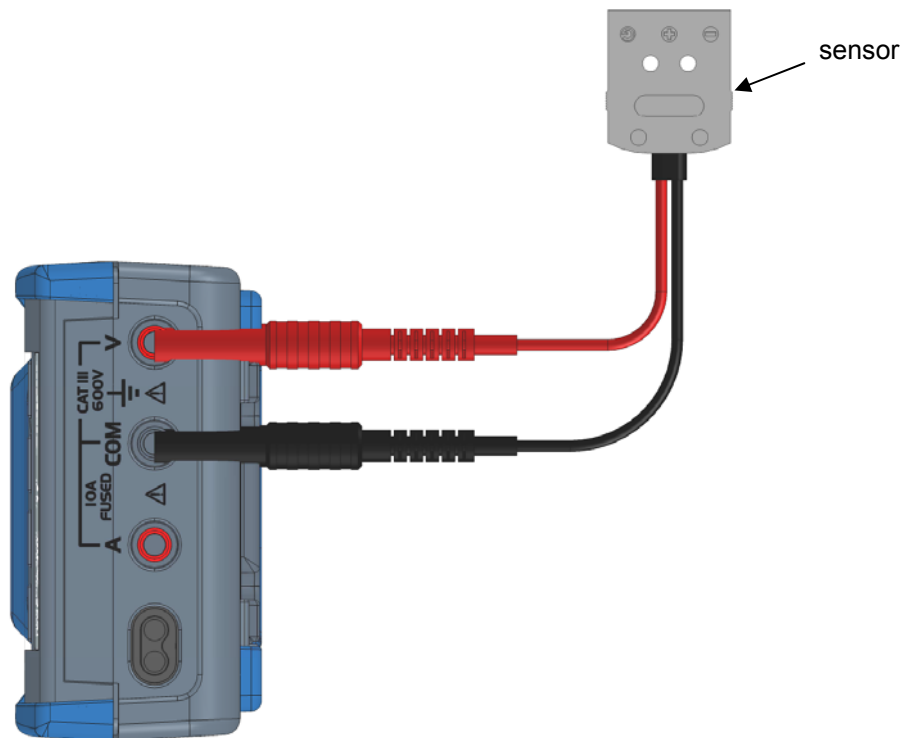

5. Read the measurement value indicated on the display unit.

If "O.L" is displayed, the probe is open-circuit or short-circuited or the value to be measured exceeds the range.



 **For greater accuracy, avoid exposing the instrument to sudden changes of temperature.**

- (\*) You will find a list of accessories in the CHAUVIN-ARNOUX catalogue.

## How are the various quantities measured? (continued)

### 9. Measurement on an MLI type speed variator

#### Voltage measurement

1. Press:  .
2. Select the type of signal, AC+DC, AC, or DC, by pressing  .  
Depending on what you select, the screen displays AC, DC, or AC+DC.
3. Select the filter by pressing  .
4. Connect the black lead to the “COM” terminal and the red lead to “V”.
5. Place the test probes between two phases of the circuit to be measured:

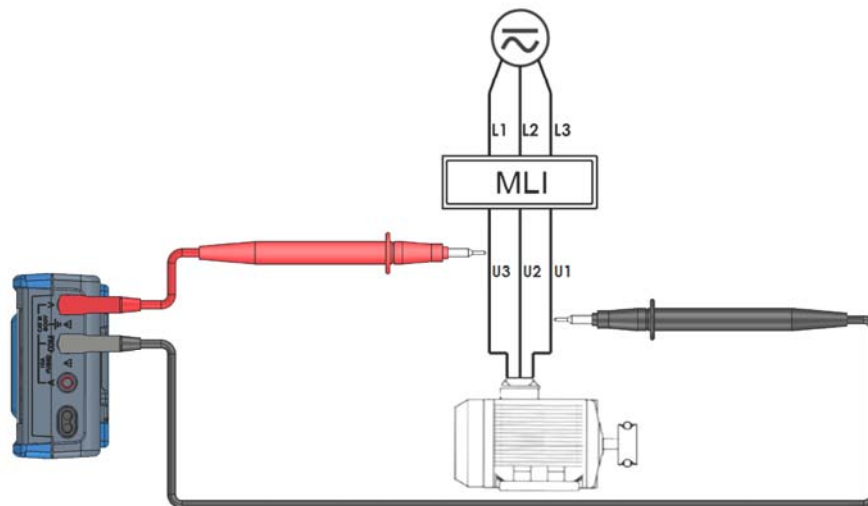

6. Read the measurement values indicated on the display unit (voltage and frequency):



In all cases, “O.L.” is displayed above 1050V (**MTX 3291**) or 620V (**MTX 3290**) and a beep sounds when the measurement exceeds 1000V (**MTX 3291**) or 600V (**MTX 3290**).

The presence of the  symbol indicates that the 300Hz filter is active.

 **It is very important to leave the filter activated to measure the voltage and frequency of the signal without being perturbed by the MLI.**

## How are the various quantities measured? (continued)

### Current measurement

1. Press: .
2. Select the type of signal, AC+DC, AC, or DC, by pressing . Depending on what you select, the screen displays AC, DC, or AC+DC.
3. Select the filter by pressing .
4. Connect the black lead to the "COM" terminal and the red lead to "A".
5. Place the test probes in series between the source and the load:

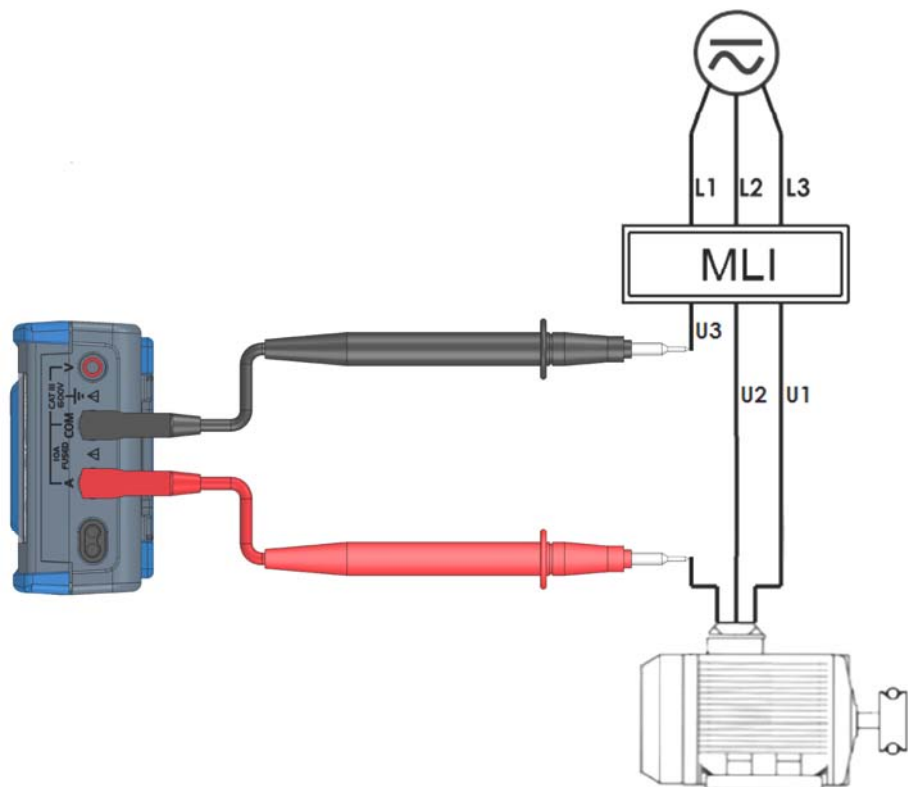

6. Read the measurement value indicated on the display unit.

"O.L." is displayed, if  $I > 20A$ .

The presence of the  symbol indicates that the filter is active.



***It is very important to leave the filter activated to measure the voltage and frequency of the signal without being perturbed by the MLI.***

7. As default, the 2<sup>nd</sup> display unit indicates the frequency, except in DC.

***It is possible to make the current measurement using a current clamp in conjunction with the multimeter (see §. 2. [Current measurement](#))***

## How are the various quantities measured? (continued)

### 10. Resistive power (MTX 3291 only)



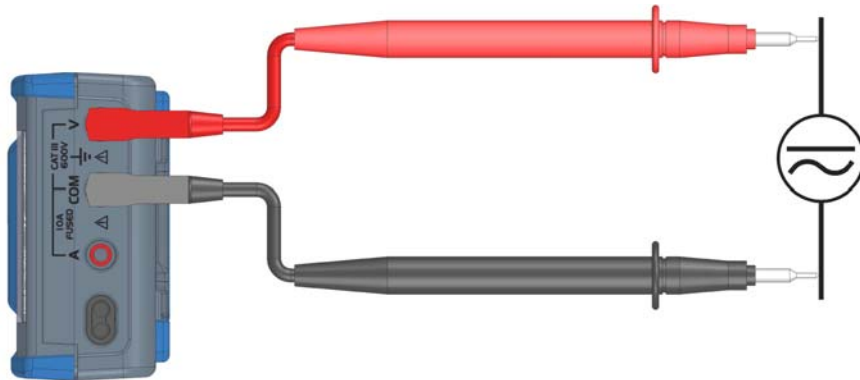

1. Press  three times.
2. Select AC+DC, AC or DC coupling of the signal by pressing  (the default coupling is AC+DC).  
Depending on what you select, the screen displays DC, AC or AC+DC.
3. Connect the black lead to the "COM" terminal and the red lead to "V".
4. Place the probes tips on the terminals of the resistive load:



5. As default, the main display unit indicates the power in W delivered to a  $600 \Omega$  resistive load ( $U^2/600$ ).



*For a load  
 $\neq 600 \Omega$*

### *How to measure the resistance*

1. Start by applying power to the load.
2. Press . The display unit indicates the resistance.
3. Press  to store the resistance, which will be used to calculate the power.
4. Press  three times.
5. Select AC+DC, AC or DC coupling of the signal by pressing  (the default coupling is AC+DC).  
Depending on what you select, the screen displays DC, AC or AC+DC.
6. Apply power to the load.
7. Read the measurement value indicated on the display unit:
  - the main display unit indicates the power in W ( $U^2/R$ )
  - the secondary display unit indicates the resistance measured on the installation ( $600 \text{ Ohm}$  by default).

## How are the various quantities measured? (continued)

### 11. dBm decibels in power (MTX3291, only)

1. Press:  .
2. Press  again.
3. Press  to select the reference resistance, 50, 75, 90, or 600 Ohm.
4. Connect the black lead to the "COM" terminal and the red lead to "V".
5. Place the test probes on the terminals of the circuit to be measured.



**Connect the instrument as for a voltage measurement.**

6. Read the measurement value indicated on the display unit:
  - the main display unit indicates the value in dBm
  - the secondary display unit indicates the resistance measured on the installation (50 Ω, by default).

#### Reminder

R	0dBm (VRef) en
50 Ω	223.6mV
75 Ω	273.86mV
90 Ω	300mV
600 Ω	774.6mV

$$XdBm = 20 \text{ Log } \frac{V_{\text{measured}}}{V_{\text{Ref}}}$$

## SX-DMM software

### SX-DMM: Processing software

These multimeters can be interfaced directly with a PC or other computer using "SX-DMM" acquisition software:

The transmission rate is 9600 Bauds.

The transmission parameters are fixed (8 data bits, 1 stop bit, no parity).

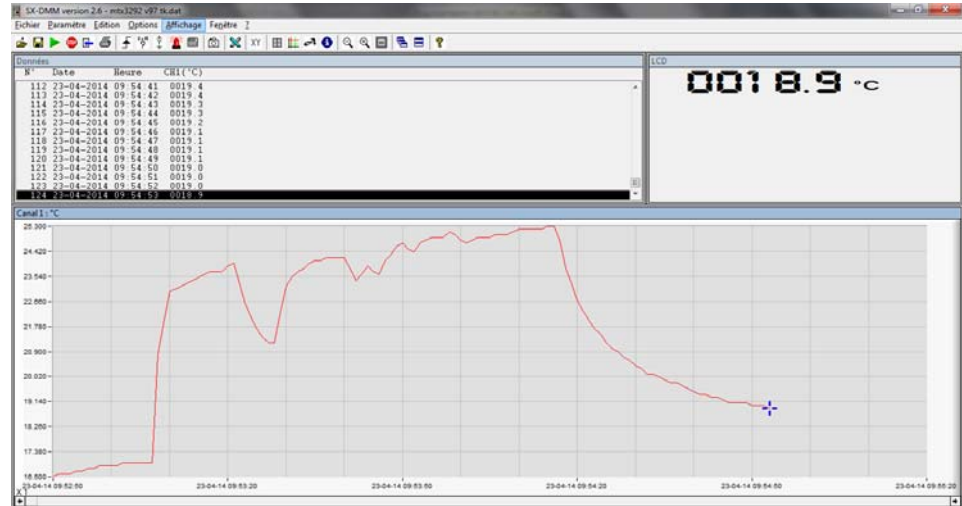

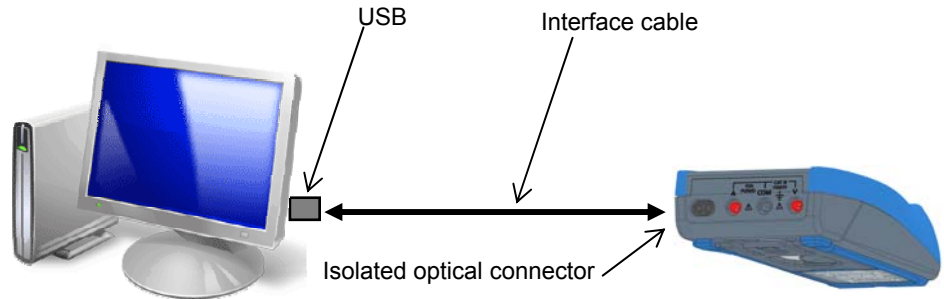

### Connection of the isolated USB optical lead supplied

1. Connect the isolated optical lead to the isolated optical input of the multimeter (on the side of the multimeter). Mechanical polarization prevents connection in reverse. Connect the USB lead to one of the USB ports of the PC.
2. Install the USB driver on your PC (see the data sheet on the CD provided).



### Installing the "SX-DMM" software

1. Install the "SX-DMM" software on the PC using the CD.
2. Start the software for data acquisition and study the various display possibilities (curves, tables, etc.).

 **The  symbol appears on the display unit when the instrument is controlled from the PC (REMOTE mode).**

For more information, refer to the "Help" menu of the software.

## Technical characteristics of the MTX 3290

**Accuracy:** Only values with tolerances or limits are guaranteed values.  
 "n% L+n D" means Values without tolerances are given for guidance (standard NFC42670).  
 "n% of the reading + n Digit" The technical specifications are guaranteed only after 30 minutes of warming up.  
 (see CEI 485) Except as otherwise indicated, they are valid from 10% to 100% of the measurement range.

### DC voltage

In the "DC" mode, you measure a direct voltage or the DC component of an AC voltage (**filter activated**).

Range	Specified measurement range	Resolution	Intrinsic error	Input impedance
600mV	0 to 600.0mV	0.1mV	0.6% L+2D	10.9MΩ
6V	0 to 6.000V	0.001V	0.3% L+2D	10.9MΩ
60V	0 to 60.00V	0.01V		10.082MΩ
600V (*)	0 to 600.0V	0.1V		10.008MΩ

(\*) The display indicates "+OL" above +620V and "-OL" above - 620V. Protection: 850Vpk

Secondary measurements and displays: MAX, MIN, AVG

### AC and AC+DC voltages

With this function, the user can measure the true RMS (TRMS) value of an AC voltage with its DC component (no capacitive coupling) or without its DC component.

**VAC RMS** Protection: 850Vpk

Range	Operating range	Specified measurement range <sup>3)</sup>	Resolution	Uncertainty (±)	Additional uncertainty F (Hz) <sup>1)</sup>	Pass band	@ 1kHz Input impedance // <50 pF	Peak factor
600mV	0 to 600.0mV	60.0 to 600.0mV	0.1mV	2% L+ 0.25%x [F(kHz)-1]L ±5D	45<F<65Hz 0.3% L typ.	10Hz to 20kHz	10.9 MΩ	3 to 500mV
6V	0 to 6.000V	0.600 to 6.000V	0.001V	2% L+ 0.18%x [F(kHz)-1]L ±3D	at 100Hz 0.7% L typ.	10Hz to 20kHz	10.9 MΩ	3 to 5V
60V	0 to 60.00V	6.00 to 60.00V	0.01V		at 150Hz 1.8% L typ.		10.082 MΩ	3 to 50V
600V <sup>2)</sup>	0 to 600.0V	60.0 to 600.0V	0.1V		at 300Hz 30% L typ.		10.008 MΩ	3 to 500V

1) See the typical curve of the 300Hz filter.

2) The LCD indicates "+OL" above +620V, "-OL" below -620V or above 620VRMS.

3) From 1kHz, the measurement must exceed 15% of the range.

Secondary measurements and displays: FREQ (AC coupling), MAX, MIN, AVG, PEAK



## Technical characteristics of the MTX 3290 (continued)

### V<sub>AC+DC TRMS</sub> Protection: 850Vpk

Range	Operating range	Specified measure. range <sup>3)</sup>	Resolution	Uncertainty DC (±)	Uncertainty AC (±)	Additional uncertainty F (Hz) <sup>1)</sup>	Pass band	Input impedance // <50 pF	Peak factor
600mV	0 to 600.0mV	60.0 to 600.0mV	0.1mV	0.8% L ±10D	2% L + 0.18% x [F(kHz)-1]L ±5D	45<F<65Hz 0.3% L typ.	10Hz to 20kHz	10.9MΩ	3 to 500mV
6V	0 to 6.000V	0.600 to 6.000V	0.001V		2% L + 0.18% x [F(kHz)-1]L ±3D	at 100Hz 0.7% L typ.	10Hz to 20kHz	10.9MΩ	3 to 5V
60V	0 to 60.00V	6.00 to 60.00V	0.01V		at 150Hz 1.8% L typ.	at 300Hz 30% L typ.		10.082MΩ	3 to 50V
600V <sup>2)</sup>	0 to 600.0V	60.0 to 600.0V	0.1V		10.008MΩ	3 to 500V			

1) See the typical curve of the 300Hz filter.

2) The LCD indicates “+OL” above +620V, “-OL” below -620V or above 620VRMS.

3) From 1kHz, the measurement must exceed 15% of the range.

Secondary measurements and displays: FREQ (AC coupling), MAX, MIN, AVG, PEAK

### V<sub>LowZ AC</sub> Protection: 850Vpk

The pass band is reduced to 300Hz if the filter is activated. The frequency measurement is made like the measurement in a 300Hz pass band.

Range	Operating range	Specified measurement range <sup>3)</sup>	Resolution	Uncertainty (±)	Additional uncertainty F (Hz) <sup>1)</sup>	Input impedance // <50 pF	Peak factor
600mV	0 to 600.0mV	60.0 to 600.0mV	0.1mV	2.2% L+ 0.25% x [F(kHz)-1]L ±5D	45<F<65Hz 0.3% L typ.	≅300kΩ	3 to 500mV
6V	0 to 6.000V	0.600 to 6.000V	0.001V	2.2% L+ 0.18% x [F(kHz)-1]L ±3D	at 100Hz 0.7% L typ.		3 to 5V
60V	0 to 60.00V	6.00 to 60.00V	0.01V		at 150Hz 1.8% L typ.		3 to 50V
600V <sup>2)</sup>	0 to 600.0V	60.0 to 600.0V	0.1V		at 300Hz 30% L typ.		3 to 500V

1) See the typical curve of the 300Hz filter.

2) The LCD indicates “+OL” above +620V, “-OL” below -620V or above 620VRMS.

3) From 1kHz, the measurement must exceed 15% of the range.

Secondary measurements and displays: FREQ (AC coupling), MAX, MIN, AVG, PEAK

## Technical characteristics of the MTX 3290 (continued)

### Currents

Three possible modes: DC, AC, AC+DC

In DC mode, you can measure a direct current or the DC component of an alternating current.

In the AC and AC+DC modes, you can measure the true RMS (TRMS) value of an alternating current with/without its direct component (no capacitive coupling in "DC" mode).

### DC current

Particular reference conditions:

**6mA range:** Measuring a strong current for a long time can cause a temperature rise in some components. In this case, it is necessary to wait some time for the metrological characteristics specified in 6mA to be restored.

Range	Operating range	Specified measurement range	Resolution	Uncertainty (±)	Voltage drop	Protection
6mA	0 to 6.000mA	0.002 to 6.000mA	1µA	1.2% L ± 5D	25mV/mA	Fuse 10A/600V >50kA
60mA	0 to 60.00mA	0.02 to 60.00mA	0.01mA	1.2% L ± 2D	3mV/mA	
600mA	0 to 600.0mA	0.2 to 600.0mA	0.1mA	1.2% L ± 2D	0.58mV/mA	
6A	0 to 6.000A	0.200 to 6.000A	0.001A	1.2% L ± 3D	0.05V/A	
10 A/20A (*)	0 to 20.00A	0.20 to 20.00A	0.01A	1.2% L ± 2D	0.05V/A	

The display indicates "OL" above 19.99A. The  symbol blinks and a beep sounds above 10A.

(\*) Acceptable overload: 10A to 15A for 30s max. with a pause of 5min between 2 measurements. Ambient temp. 35°C max.

Secondary measurements and displays: MAX, MIN, AVG

### AAC RMS current

Range	Operating range	Specified measurement range	Resolution	Uncertainty (±) 40Hz to 20kHz (**)	Peak factor	Voltage drop	Protection
6mA	0 to 6.000mA	0.600 to 6.000mA	1µA	1.7% L ± 5D	2.6 to 5mA	25mV/mA	Fuse 10A/600V >50kA
60mA	0 to 60.00mA	6.00 to 60.00mA	0.01mA	1.5% L ± 3D	2.6 to 50mA	3mV/mA	
600mA	0 to 600.0mA	60.0 to 600.0mA	0.1mA		2.6 to 500mA	0.58mV/mA	
6A	0 to 6.000A	0.600 to 6.000A	0.001A	1.7% L ± 5D	2.8 to 5A	0.05V/mA	
10A/20A (*)	0 to 20.00A	1.00 to 10.00A	0.01A	1.5% L ± 3D	3.7 to 8A	0.05V/mA	

The display indicates "OL" above 19.99A. The  symbol blinks and a beep sounds above 10A.

Secondary measurements and displays: FREQ (AC coupling) MAX, MIN, AVG, PEAK

(\*) Acceptable overload: 10A to 15A for 30s max. with a pause of 5min between 2 measurements. Ambient temp. 35°C max.

(\*\*) Additional uncertainty with the 300Hz filter.

## Technical characteristics of the MTX 3290 (continued)

### AAC+DC TRMS current

**Warning:** The sum AC+DC must never exceed the range, 600mA, or 60mA, or 6mA, or 6A, or 10A, as the case may be.

Range	Operating range	Specified measurement range	Resolution	Uncertainty AC 40Hz at 20kHz (±) (**)	Additional uncertainty DC (±)	Peak factor	Voltage drop	Protection
6mA	0 to 6.000mA	0.060 to 6.000mA	1µA	1.7% L +[0.08%x (FkHz-1)] L ±5D	±15D	2.6 to 5mA	25mV/mA	Fuse 10A/600V >50kA
60mA	0 to 60.00mA	6.00 to 60.00mA	0.01mA	1.5% L +[0.08%x (FkHz-1)] L ±3D	±13D	2.6 to 50mA	3mV/mA	
600mA	0 to 600.0mA	60.0 to 600.0mA	0.1mA			2.6 to 500mA	0.58mV/mA	
6A	0 to 6.000A	0.600A to 6.000A	0.001A	1.7% L+[0.08%x (FkHz-1)] L ±5D	±10D	2.8 to 5A	0.05V/mA	
10A /20A*	0 to 20.00A	0.60A to 20.00A	0.01A	1.5% L+ [0.08%x (FkHz-1)] L ±3D	±10D	3.7 to 8A	0.05V/mA	

The display indicates “OL” above 19.99A. The  symbol blinks and a beep sounds above 10A.

(\*) Acceptable overload: 10A to 15A for 30s max. with a pause of 5min between 2 measurements. Ambient temp. 35°C max.

Secondary measurements and displays: F (AC coupling), MAX, MIN, AVG, PEAK

(\*\*) Additional uncertainty with the 300Hz filter.

## Technical characteristics of the MTX 3290 (continued)

### Frequency

#### Main frequency measurement

In this setting, you can measure the frequency of a voltage.

Particular reference conditions: 150mV <U <600V

When the switch is set to Hz, the 300Hz filter is not in service.

Protection: 850Vpk

Range	Operating range	Specified measurement range	Resolution	Intrinsic error
60Hz	10.00 to 60.00Hz	10.00 to 60.00Hz	0.01Hz	0.1% L ±1D
600Hz	10.0 to 600.0Hz	10.00 to 600.0Hz	0.1Hz	
6kHz	0 to 6.000kHz	0.010 to 6.000kHz	0.001kHz	
60kHz	0 to 60.00kHz	0.01 to 60.00kHz	0.01kHz	
600kHz	0 to 200.0kHz	0.1 to 200.00kHz	0.1kHz	

Below 10Hz, or if the signal detection level is inadequate, the reading is forced to zero.

 **The measured period in ms is available on the second display unit.**

#### Secondary frequency measurement

You can measure the frequency and magnitude of a voltage or of a current simultaneously.

Same accuracy as in the "Hz" setting

Particular reference conditions: 150mV <U <600V  
0.15A <I <10A

Max. frequency measurable in volts: 20kHz

Max. frequency measurable in amperes: 20kHz

When the switch is set to VLowZ, Volts or Ampere, if the 300Hz filter is activated, the measurable frequency remains within the limits of the PB of the filter.

Below 10Hz, or if the signal detection level is inadequate, the reading is forced to "----".

## Technical characteristics of the MTX 3290 (continued)

### Resistance

**Ohmmeter** In this setting, the user can measure a resistance.

Particular reference conditions:

The (+COM) input must not have been overloaded following the accidental application of a voltage to the input terminals with the switch set to  $\Omega$  or  $T^\circ$ . If this happens, the return to normal may take about ten minutes.

Protection: 850Vpk

Range	Specified measurement range	Resolution	Uncertainty	Measurement current	Open-circuit voltage
600 $\Omega$	0 to 600.0 $\Omega$ *	0.1 $\Omega$	0.5% L $\pm$ 2D	$\approx$ 850 $\mu$ A	<5V
6k $\Omega$	0 to 6.000k $\Omega$	0.001k $\Omega$	0.5% L $\pm$ 2D	$\approx$ 126.6 $\mu$ A	
60k $\Omega$	0 to 60.00k $\Omega$	0.01k $\Omega$		$\approx$ 12.6 $\mu$ A	
600k $\Omega$	0 to 600.0k $\Omega$	0.1k $\Omega$		$\approx$ 1.26 $\mu$ A	
6M $\Omega$	0 to 6.000M $\Omega$	0.001M $\Omega$	1.5% L $\pm$ 3D	$\approx$ 240nA	
60M $\Omega$	0 to 60.00M $\Omega$	0.01M $\Omega$	3% L $\pm$ 3D	$\approx$ 29nA	

(\*) REL measurements

### Capacitance

**Capacitance meter** In this setting, the user can measure the capacitance of a capacitor.

Range	Operating range	Specified measurement range	Resolution	Intrinsic error	Measurement current	Measurement time
6nF	0.100 to 6.000nF	0.100 to 6.000nF	0.001nF	2.5% L $\pm$ 30D	$\approx$ 1.26 $\mu$ A	$\approx$ 400ms
60nF	0 to 60.00nF	0 to 60.00nF	0.01nF	1.5% L $\pm$ 8D	$\approx$ 1.26 $\mu$ A	$\approx$ 400ms
600nF	0 to 600.0nF	0 to 600.0nF	0.1nF	1.5% L $\pm$ 5D	$\approx$ 1.26 $\mu$ A	$\approx$ 400ms
6 $\mu$ F	0 to 6.000 $\mu$ F	0 to 6.000 $\mu$ F	0.001 $\mu$ F	1.5% L $\pm$ 5D	$\approx$ 12.6 $\mu$ A	$\approx$ 0.125 s/ $\mu$ F
60 $\mu$ F	0 to 60.00 $\mu$ F	0 to 60.00 $\mu$ F	0.01 $\mu$ F	1.5% L $\pm$ 5D	$\approx$ 126.6 $\mu$ A	$\approx$ 0.125 s/ $\mu$ F
600 $\mu$ F	0 to 600.0 $\mu$ F	0 to 600.0 $\mu$ F	0.1 $\mu$ F	3.5% L $\pm$ 5D	$\approx$ 850 $\mu$ A	$\approx$ 0.125 s/ $\mu$ F
6mF	0 to 6.000mF	0 to 6.000mF	1 $\mu$ F	4.5% L $\pm$ 5D	$\approx$ 850 $\mu$ A	$\approx$ 17 s/mF
60mF	0 to 60.00mF	0 to 60.00mF	10 $\mu$ F	6.5% L $\pm$ 5D	$\approx$ 850 $\mu$ A	$\approx$ 17 s/mF

The use of wires that are very short and shielded is strongly recommended.

Protection: 850Vpk

## Technical characteristics of the MTX 3290 (continued)

### Diode Test

Range	Resolution	Accuracy	Open-circuit voltage	Measurement current
3V	1mV	2% L ±3D	<5V	<1.1mA

Audible signal triggered if <40mV ±10mV

Protection: 850Vpk

### Audible continuity

Range	Resolution	Accuracy	Open-circuit voltage	Measurement current	Protection
600Ω	0.1Ω	0.5% L ±3D	<5V	<1.1mA	850Vpk

Response time <100ms

Triggering threshold: <30Ω ±5Ω

Protection: 850Vpk

### Clamp

You can measure a current using various current clamps and obtain a direct reading of the current by selecting the correct transformation ratio, which must be the same as that of the clamp.

If the signal detection level is insufficient, the value is forced to "-----"

The input impedance is approximately 10MΩ.

☝ **Add the error of the clamp to the intrinsic error of the multimeter, specified in the tables below.**

### DC current

Range Ratio		600mA	6A	60A	600A	6000A
	1mV/A	Resolution			0.01A	0.1A
Accuracy				0.6%L ±2D	0.6%L ±2D	0.3%L ±2D
10mV/A	Resolution		0.001A	0.01A	0.1A	
	Accuracy		0.6%L ±2D	0.6%L ±2D	0.3%L ±2D	
100mV/A	Resolution	0.1mA	0.001A	0.01A		
	Accuracy	0.6%L ±2D	0.6%L ±2D	0.3%L ±2D		
1000mV/A	Resolution	0.1mA	0.001A			
	Accuracy	0.6%L ±2D	0.3%L ±2D			

Secondary measurements and displays: MAX, MIN, AVG and transformation ratio of the sensor

### AAC RMS current

Range Ratio		600mA	6A	60A	600A	6000A
	1mV/A	Resolution			0.01A	0.1A
Accuracy				2% L ±5D (*)	2% L ±5D	2% L ±3D
10mV/A	Resolution		0.001A	0.01A	0.1A	
	Accuracy		2% L ±5D (*)	2% L ±5D	2% L ±3D	
100mV/A	Resolution	0.1mA	0.001A	0.01A		
	Accuracy	2% L ±5D (*)	2% L ±5D	2% L ±3D		
1000mV/A	Resolution	0.1mA	0.001A			
	Accuracy	2% L ±5D	2% L ±3D			
Peak factor 3		@ 500mA	@ 5A	@ 50A	@ 500A	@ 5000A

Secondary measurements and displays: MAX, MIN, AVG and transformation ratio of the sensor

300Hz filter: if the filter is active, see "300Hz filter" curve for the additional uncertainty. (\*) : see "Frequency response" curve, p. 47.

## Technical characteristics of the MTX 3290 (continued)

### AAC+DC TRMS current

Ratio \ Range		600mA	6A	60A	600A	6000A
1mV/A	Resolution			0.01A	0.1A	1A
	Accuracy			2.8% L ±15D (*)	2.8% L ±15D	2.8% L ±13D
10mV/A	Resolution		0.001A	0.01A	0.1A	
	Accuracy		2.8% L ±15D (*)	2.8% L ±15D	2.8% L ±13D	
100mV/A	Resolution	0.1mA	0.001A	0.01A		
	Accuracy	2.8% L ±15D (*)	2.8% L ±15D	2.8% L ±13D		
1000mV/A	Resolution	0.1mA	0.001A			
	Accuracy	2.8% L ±15D	2.8% L ±13D			
Peak factor 3		@ 500mA	@ 5A	@ 50A	@ 500A	@ 5000A

Secondary measurements and displays: MAX, MIN, AVG and transformation ratio of the sensor

300Hz filter: if the filter is active, see “300Hz filter” curve for the additional uncertainty.

(\*): see “Frequency response” curve, below.

### Frequency response

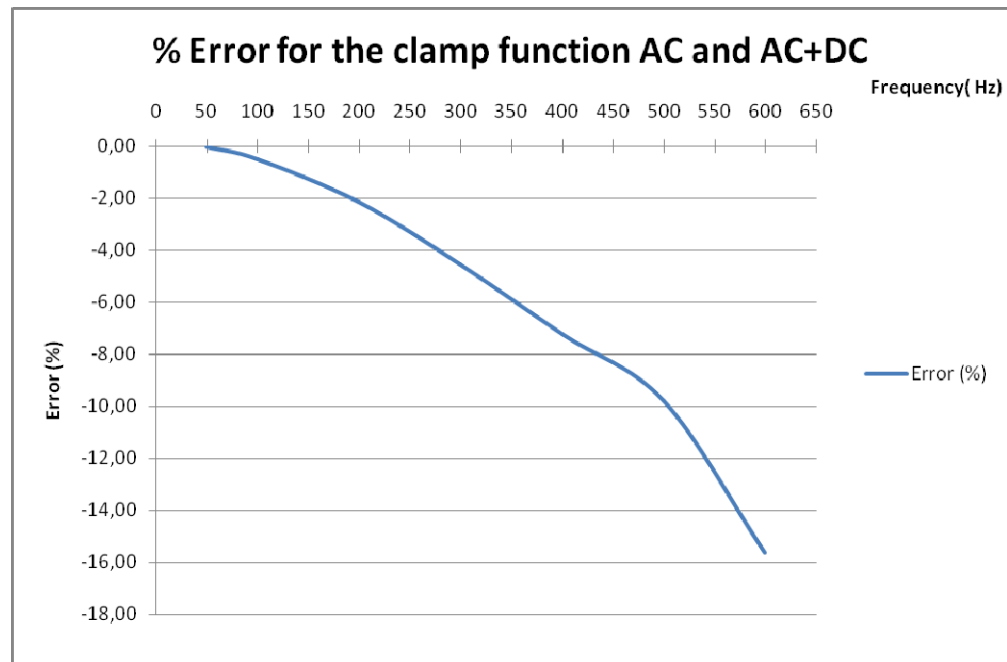

## Technical characteristics of the MTX 3290 (continued)

### Temperature

**Pt100/Pt1000** The user can measure the temperature by means of a Pt100/Pt1000 sensor.

Range	Measurement current	Resolution	Accuracy	Protection
- 125°C to + 75°C	<1mA (Pt100) <0.1mA (Pt1000)	0.1°C ---	± 0.5°C	850Vpk
- 200°C to + 800°C	<1mA (Pt100) <0.1mA (Pt1000)	0.1°C ---	0.1% L ± 1°C 0.07% L ± 1°C	

"Active" protection by PTC thermistor  
Display in °C/°F possible

### Peak

Add 1% L ± 30 D to obtain the accuracy corresponding to the function and the range.

Fmax            1kHz (1ms)  
Protection      850Vpk



### SURV

**MIN, MAX, AVG** Add 0.2% L + 2D to obtain the accuracy corresponding to the function and the range.

Acquisition time of the extrema    approximately 100ms.  
Protection                                850Vpk

### Operation of the audible beep

Beep reporting a valid key	High-pitched sound
Beep reporting an invalid key	Low-pitched sound
Successive beeps reporting an overshoot of the danger threshold (alarm)	High-pitched sound
Successive beeps reporting recording of the MAX, MIN, PEAK	High-pitched sound
Successive beeps (alarm) → current >10A	High-pitched sound
Continuity measurement	Medium-pitched sound



## Technical characteristics of the MTX 3290 (continued)

### Variation in the nominal range of use

Quantity of influence	Range of influence	Quantity influenced	Influence	
			typical	MAX
Battery voltage	4V to 6V	all	< 3D	0.2% L+1D
Temperature	-10°C... 18 28 ... 55°C	VDCmV	0.02% L ±0.2D/1°C	0.04% L ±0.25D/1°C
		VACmV, V <sub>LowZ</sub> mV	0.08% L ±0.2D/1°C	0.15% L ±0.25D/1°C
		VDC	0.01% L ±0.1D/1°C	0.05% L ±0.1D/1°C
		VAC, VAC+DC, V <sub>LowZ</sub>		0.25% L ±0.1D/1°C
		ADC	0.05% L ±0.1D/1°C	0.1% L ±0.1D/1°C
		AAC and AAC+DC	0.08% L ±0.1D/1°C	0.12% L ±0.1D/1°C
			0.01% L ±0.1D/1°C	0.1% L/1°C
		Ω	0.05% L/1°C	0.1% L/1°C
		60 MΩ		0.3% L/1°C
		μF		0.2% L ±0.1D/1°C
		mF		0.6% L ±0.1D/1°C
		Hz		0.01% L/1°C
		Temperature		± 2°C+0.05% L/1°C
Stabilization time		≈ 2 h	2.5 h	
Humidity (without condensation)	10% ... 80% RH	V A  Ω Hz	0	0
Common mode	600V 50Hz	VAC, VAC+DC, V <sub>LowZ</sub>	Range	typical
			60mV, 600mV	>35dB
			6V	>60dB
			60V, 600V, 1000V	>95dB

### Response of the 300Hz filter

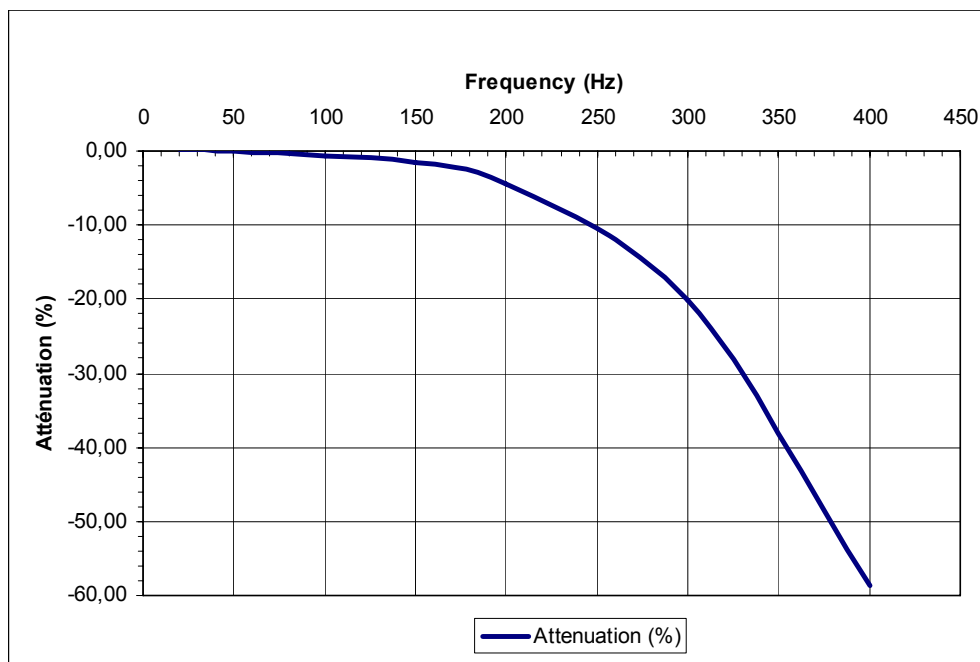

## Technical characteristics of the MTX 3291

**Accuracy:** Only values with tolerances or limits are guaranteed values.  
 "n%L + nD" means Values without tolerances are given for guidance (standard NFC42670).  
 "n% of the reading + n Digit" The technical specifications are guaranteed only after 30 minutes of warming up. Except as otherwise indicated, they are valid from 10% to 100% of the measurement range.  
 (see CEI 485)

### DC voltage

In the "DC" mode, you measure a direct voltage or the DC component of an AC voltage (filter activated).

**60mV range:** Measuring a strong current or measuring a current for a long time may cause a temperature rise of some components.

Protection: 1414 Vpk

Range	Specified measurement range	Resolution	Intrinsic error	Input impedance
60mV <sup>1)</sup>	0 to 60.000mV	0.001mV	0.5% L+35D	10.612MΩ
600mV	0 to 600.00mV	0.01mV	0.5% L+25D	10.9MΩ
6V	0 to 6.0000V	0.0001V	0.05% L+25D	10.9MΩ
60V	0 to 60.000V	0.001V		10.082MΩ
600V	0 to 600.00V	0.01V		10.008MΩ
1000V <sup>2)</sup>	0 to 1000.0V	0.1V	0.07% L+25D	10.008MΩ

1) This range is accessible only with the Range key.

Input impedance: approx. 10.6MΩ // 50 pF

2) The display indicates "+OL" above +1050V and "-OL" below -1050V.

Secondary measurements and displays: MAX, MIN, AVG

### AC and AC+DC voltages

With this function, the user can measure the true RMS (TRMS) value of an AC voltage with its DC component (no capacitive coupling) or without its DC component.

**VAC RMS** **60mV range:** Measuring a strong current or measuring a current for a long time may cause a temperature rise of some components.

Protection: 1414 Vpk

Range	Operating range	Specified measurement range <sup>4)</sup>	Resolution	Uncertainty (±)	Additional uncertainty F(Hz) <sup>1)</sup>	Pass band	@ 1kHz Input impedance // <50 pF	Peak factor
60mV <sup>2)</sup>	0 to 60.000mV	6.000 to 60.000mV	0.001mV	1.5% L ± 35D	45<F<65Hz 0.3% L typ. at 100Hz 0.7% L typ. at 150Hz 1.8% L typ. at 300Hz 30% L typ.	≈ 400Hz	10.612 MΩ	3 to 50.0mV
600mV	0 to 600.00mV	60.00 to 600.00mV	0.01mV	1% L + 0.25%x [F(kHz)-1] L ± 30D		10Hz to 50kHz (≈ 23% @100kHz)	10.9 MΩ	3 to 500.0mV
6V	0 to 6.0000V	0.6 to 6.0000V	0.0001V	0.5% L + 0.18%x [F(kHz)-1] L ± 25D		10.9 MΩ	3 to 5.0V	
60V	0 to 60.000V	6.000 to 60.000V	0.001V			10.082 MΩ	3 to 50.0V	
600V	0 to 600.00V	60.00 to 600.00V	0.01V			10.008 MΩ	3 to 500.0V	
1000V <sup>3)</sup>	0 to 1000.0V	60 to 1000.0V	0.1V			10.008 MΩ	1.42 to 1000.0V	

## Technical characteristics of the MTX 3291 (continued)

### **V<sub>AC RMS</sub>** **(continued)**

- 1) See the typical curve of the 300Hz.
  - 2) This range is accessible only with the Range key  
Input impedance: approx. 10.6MΩ // 50 pF
  - 3) The LCD indicates "+OL" above +1050V, "-OL" below -1050V or above 1050VRMS.
  - 4) From 1kHz, the measurement must exceed 15% of the range.
- Secondary measurements and displays: FREQ (AC coupling), MAX, MIN, AVG, PEAK

### **V<sub>LowZ AC RMS</sub>**

The pass band (between 3dB down points) is reduced to 300Hz, if the filter is activated. In V<sub>LowZ</sub>, there is no 60mV range.  
The frequency measurement is made like the measurement in a 300Hz pass band.

Protection: 1414 Vpk

Range	Operating range	Specified measurement range <sup>3)</sup>	Resolution	Uncertainty (±)	Additional uncertainty F(Hz) <sup>1)</sup>	Pass band	Input impedance // <50 pF
600mV	0 to 600.00mV	60.00 to 600.00mV	0.01mV	1% L + 0.25%x [F(kHz)-1] L ± 30D			3 to 500.0mV
6V	0 to 6.0000V	0.6 to 6.0000V	0.0001V	0.5% L + 0.18%x [F(kHz)-1] L ± 25D	45<F<65Hz 0.3% L typ.	≅ 300 kΩ	3 to 5.0V
60V	0 to 60.000V	6.000 to 60.000V	0.001V		at 100Hz 0.7% L typ.		3 to 50.0V
600V	0 to 600.00V	60.00 to 600.00V	0.01V		at 150Hz 1.8% L typ.		3 to 500.0V
1000V <sup>2)</sup>	0 to 1000.0V	60 to 1000.0V	0.1V		at 300Hz 30% L typ.		
							1.42 to 1000.0V

- 1) See the typical curve of the 300Hz.
  - 2) The LCD indicates "+OL" above +1050V, "-OL" below -1050V or above 1050VRMS.
  - 3) From 1kHz, the measurement must exceed 15% of the range.
- Secondary measurements and displays: FREQ (AC coupling), MAX, MIN, AVG, PEAK

### **V<sub>AC+DC TRMS</sub>**

**60mV range:** Measuring a strong current or measuring a current for a long time may cause a temperature rise of some components.

Protection: 1414 Vpk

Range	Operating range	Specified measurement range <sup>4)</sup>	Resolution	Additional uncertainty DC (±)	Uncertainty AC (±)	Additional uncertainty F(Hz) <sup>1)</sup>	Pass band	Input impedance // <50 pF	Peak factor
60mV <sup>2)</sup>	0 to 60.000mV	6.000 to 60.000mV	0.001mV	± 15D	1.5% L ± 35D		≈ 400Hz	10.612 MΩ	3 to 50mV
600mV	0 to 600.00mV	60.00 to 600.00mV	0.01mV		0.8% L + 0.18%x [F(kHz)-1] L ± 30D	45<F<65Hz 0.3% L typ.	10Hz to 50kHz	10.9 MΩ	3 to 500mV
6V	0 to 6.0000V	0.6 to 6.0000V	0.0001V		at 100Hz 0.7% L typ.	10.9 MΩ	3 to 5V		
60V	0 to 60.000V	6.000 to 60.000V	0.001V		at 150Hz 1.8% L typ.	10.082 MΩ	3 to 50V		
600V	0 to 600.00V	60.00 to 600.00V	0.01V		at 300Hz 30% L typ.	10.008MΩ	3 to 500V		
1000V <sup>3)</sup>	0 to 1000.0V	60 to 1000.0V	0.1V			10.008 MΩ	1.42 to 1000V		

- 1) See the typical curve of the 300Hz.
  - 2) This range is accessible only with the Range key - Input impedance: approx. 10.6MΩ//50 pF
  - 3) The LCD indicates "+OL" above +1050V, "-OL" below -1050V or above 1050VRMS.
  - 4) From 1kHz, the measurement must exceed 15% of the range.
- Secondary measurements and displays: FREQ (AC coupling), MAX, MIN, AVG, PEAK

## Technical characteristics of the MTX 3291 (continued)

### Currents

Three possible modes: DC, AC, AC+DC

In DC mode, you can measure a direct current or the DC component of an alternating current.

In the AC and AC+DC modes, you can measure the true RMS (TRMS) value of an alternating current with/without its direct component (no capacitive coupling in "DC" mode).

### DC current

Particular reference conditions:

600 $\mu$ A and 6mA ranges: Measuring a strong current for a long time may cause a temperature rise of some components. In this case, it is necessary to wait some time for the metrological characteristics specified in these ranges.

Range	Operating range	Specified measurement range	Resolution	Uncertainty ( $\pm$ )	Voltage drop	Protection
600 $\mu$ A	0 to 600.00 $\mu$ A	0.02 to 600.00 $\mu$ A	0.01 $\mu$ A	1% L $\pm$ 25D	10mV/mA	Fuse 11A/1000V >20kA
6mA	0 to 6000.0mA	0.002 to 6.0000mA	0.1 $\mu$ A	0.8% L $\pm$ 25D	25mV/mA	
60mA	0 to 60.000mA	0.020 to 60.000mA	0.001mA	0.8% L $\pm$ 20D	3mV/mA	
600mA	0 to 600.00mA	0.20 to 600.00mA	0.01mA	0.8% L $\pm$ 20D	0.58mV/mA	
6A	0 to 6.0000A	0.2000 to 6.0000A	0.0001A	0.8% L $\pm$ 20D	0.05V/A	
10A/20A (*)	0 to 20.000A	0.200 to 20.000A	0.001A	0.8% L $\pm$ 20D	0.05V/A	

The display indicates "OL" above 19.99A. The  symbol blinks and a beep sounds above 10A.

(\*) Acceptable overload: 10A to 20A for 30s max. with a pause of 5min between 2 measurements. Ambient temp. 35°C max.

Secondary measurements and displays: MAX, MIN, AVG

## Technical characteristics of the MTX 3291 (continued)

### AAC RMS current

Range	Operating range	Specified measurement range	Resolution	Uncertainty (±) 40Hz to 20kHz (**)	Peak factor	Voltage drop	Protection
600µA	0 to 600.00µA	60 to 600.00µA	0.01µA	1.5% L ±30D	2.6 to 500µA	10mV/µA	Fuse 11A /1000V >20kA
6.000mA	0 to 6.0000mA	0.6000 to 6.0000mA	0.1µA	1.2% L+[0.08% x (FkHz-1)] L ±25D	2.6 to 5mA	25mV/mA	
60mA	0 to 60.000mA	6.000 to 60.000mA	0.001mA	1% L+[0.08% x (FkHz-1)] L ±25D	2.6 to 50mA	3mV/mA	
600mA	0 to 600.00mA	60.00 to 600.00mA	0.01mA		2.6 to 500mA	0.58mV/mA	
6A	0 to 6.0000A	0.6000 to 6.000A	0.0001A	1% L +[0.1% x (FkHz-1)] L ±25D	2.8 to 5A	0.05V/mA	
10A/20A (*)	0 to 20.000A	1.000 to 20.000A	0.001A	1.2% L+ [0.1% x (FkHz-1)] L ±25D	3.7 to 8A	0.05V/mA	

The display indicates “OL” above 19.99A. The  symbol blinks and a beep sounds above 10A.

Secondary measurements and displays: FREQ (AC coupling), MAX, MIN, AVG, PEAK

(\*) Acceptable overload: 10A to 20A for 30s max. with a pause of 5min between 2 measurements. Ambient temp. 35°C max.

(\*\*) Additional uncertainty with the 300Hz filter.

### AAC+DC TRMS current

**Warning:** the sum AC+DC must never exceed the range, 600mA, or 60mA, or 6mA, or 600µA or 6A, or 10A, as the case may be.

The AC component must represent at least 5% of the amplitude of the AC+DC total for it to be possible to measure it.

Range	Operating range	Specified measurement range	Resolution	Uncertainty (±) 40Hz to 20kHz (**)	Peak factor	Voltage drop	Protection	Range
600µA	0 to 600.00µA	60 to 600.00µA	0.01µA	1.5% L ±20D	±15D	2.6 to 500µA	10mV/µA	Fuse 11A/1000 V >20kA
6mA	0 to 6.0000µA	0.6000 to 6.0000mA	0.1µA	1% L +[0.08% x (FkHz - 1)]L ±25D		2.6 to 5mA	25mV /mA	
60mA	0 to 60.00mA	6.000 to 60.000mA	0.001mA	1% L +[0.08% x (FkHz - 1)]L ±25D		2.6 to 50mA	3mV/mA	
600mA	0 to 600.00mA	60.00 to 600.00mA	0.01mA			2.6 to 500mA	0.58mV/m A	
6A	0 to 6.0000A	0.6000 to 6.000A	0.0001A	1% L+[0.1% x (FkHz-1)]L ±25D		2.8 to 5A	0.05V /mA	
10A/20A (*)	0 to 20.00A	0.600 to 20.000A	0.001A	1.2% L+ [0.1% x (FkHz-1)]L ±25D		3.7 to 8A	0.05V /mA	

The display indicates “OL” above 19.99A. The  symbol blinks and a beep sounds above 10A.

(\*) Acceptable overload: 10A to 20A for 30s max. with a pause of 5min between 2 measurements. Ambient temp. 35°C max.

Secondary measurements and displays: FREQ (AC coupling), MAX, MIN, AVG, PEAK

(\*\*) Additional uncertainty with the 300Hz filter.

## Technical characteristics of the MTX 3291 (continued)

### Frequency

#### Main frequency measurement

In this setting, you can measure the frequency of a voltage.

Particular reference conditions: 150mV <U <600V

When the switch is set to Hz, the 300Hz filter is not in service.

Protection: 1414 Vpk

Range	Operating range	Specified measurement range	Resolution	Intrinsic error
60Hz	10.00 to 60.00Hz	10.00 to 60.00Hz	0.01Hz	0.1% L ±1D
600Hz	10.0 to 600.0Hz	10.0 to 600.0Hz	0.1Hz	
6kHz	0 to 6.000kHz	0.010 to 6.000kHz	0.001kHz	
60kHz	0 to 60.00kHz	0.01 to 60.00kHz	0.01kHz	
600kHz	0 to 200.0kHz	0.1 to 200.0kHz	0.1kHz	

Below 10Hz, or if the signal detection level is inadequate, the reading is forced to zero.

 **The measured period in ms is available on the second display unit.**

#### Secondary frequency measurement

You can measure the frequency and magnitude of a voltage or of a current simultaneously.

Same accuracy as in the "Hz" setting

Particular reference conditions:

150mV <U <600V

0.15A <I <10A

Max. frequency measurable in volts:

100kHz

(except 60mV range → 400Hz and  
600mV range → 50kHz)

Max. frequency measurable in amperes: 20kHz

When the switch is set to VLowZ, Volts or Ampere, if the 300Hz filter is activated, the measurable frequency remains within the limits of the PB of the filter.

Below 10Hz, or if the signal detection level is inadequate, the reading is forced to "----".

## Technical characteristics of the MTX 3291 (continued)

### Resistance

**Ohmmeter** In this setting, the user can measure a resistance.

Particular reference conditions:

The (+COM) input must not have been overloaded following the accidental application of a voltage to the input terminals with the switch set to  $\Omega$  or T°. If this happens, the return to normal may take about ten minutes.

Protection: 1414 Vpk

Range	Specified measurement range	Resolution	Uncertainty	Measurement current	Open-circuit voltage
600 $\Omega$	0 to 600.00 $\Omega$ (*)	0.01 $\Omega$	0.2% L $\pm$ 20D	$\approx$ 1mA	<5V
6k $\Omega$	0 to 6.0000k $\Omega$	0.0001k $\Omega$	0.2% L $\pm$ 20D	$\approx$ 126.6 $\mu$ A	
60k $\Omega$	0 to 60.000k $\Omega$	0.001k $\Omega$		$\approx$ 12.6 $\mu$ A	
600k $\Omega$	0 to 600.00k $\Omega$	0.01k $\Omega$		$\approx$ 1.26 $\mu$ A	
6M $\Omega$	0 to 6.0000M $\Omega$	0.0001M $\Omega$	1.5% L $\pm$ 30D	$\approx$ 240nA	
60M $\Omega$	0 to 60.000M $\Omega$	0.001M $\Omega$	3% L $\pm$ 30D	$\approx$ 29nA	

(\*) REL measurements

### Capacity

**Capacitance meter** In this setting, the user can measure the capacitance of a capacitor.

Range	Operating range	Specified measurement range	Resolution	Intrinsic error	Measurement current	Measurement time
6nF	0.100 to 6.000nF	0.100 to 6.000nF	0.001nF	2% L $\pm$ 30D	$\approx$ 1.26 $\mu$ A	$\approx$ 400ms
60nF	0 to 60.00nF	0 to 60.00nF	0.01nF	1% L $\pm$ 8D	$\approx$ 1.26 $\mu$ A	$\approx$ 400ms
600nF	0 to 600.0nF	0 to 600.0nF	0.1nF	1% L $\pm$ 5D	$\approx$ 1.26 $\mu$ A	$\approx$ 400ms
6 $\mu$ F	0 to 6.000 $\mu$ F	0 to 6.000 $\mu$ F	0.001 $\mu$ F	1% L $\pm$ 5D	$\approx$ 12.6 $\mu$ A	$\approx$ 0.125 s/ $\mu$ F
60 $\mu$ F	0 to 60.00 $\mu$ F	0 to 60.00 $\mu$ F	0.01 $\mu$ F	1% L $\pm$ 5D	$\approx$ 126.6 $\mu$ A	$\approx$ 0.125 s/ $\mu$ F
600 $\mu$ F	0 to 600.0 $\mu$ F	0 to 600.0 $\mu$ F	0.1 $\mu$ F	3% L $\pm$ 5D	$\approx$ 1mA	$\approx$ 0.125 s/ $\mu$ F
6mF	0 to 6.000mF	0 to 6.000mF	1 $\mu$ F	4% L $\pm$ 5D	$\approx$ 1mA	$\approx$ 17 s/mF
60mF	0 to 60.00mF	0 to 60.00mF	10 $\mu$ F	6% L $\pm$ 5D	$\approx$ 1mA	$\approx$ 17 s/mF

The use of wires that are very short and shielded is strongly recommended.

Protection: 1414 Vpk

## Technical characteristics of the MTX 3291 (continued)

### Diode test

Range	Resolution	Accuracy	Open-circuit voltage	Measurement current
3V	0.1mV	1% L ±30D	<5V	<1.1mA

Audible signal triggered if <40mV ±10mV  
 Protection: 1414 Vpk

### Audible continuity

Range	Resolution	Accuracy	Open-circuit voltage	Measurement current	Protection
600Ω	0.01Ω	0.2% L ±20D	<5V	<1.1mA	1414 Vpk

Response time: <100ms  
 Triggering threshold: <30Ω ±5Ω  
 Protection: 1414 Vpk

### Clamp

You can measure a current using various current clamps and obtain a direct reading of the current by selecting the correct transformation ratio, which must be the same as that of the clamp.

If the signal detection level is insufficient, the value is forced to "-----"

The input impedance is approximately 10MΩ.

 **Add the error of the clamp to the intrinsic error of the multimeter, specified in the tables below.**

### DC current

Ratio \ Range		600mA	6A	60A	600A	6000A
	1mV/A	Resolution			0.01A	0.1A
	Accuracy			0.5% L ±2D	0.5% L ±2D	0.05% L ±2D
10mV/A	Resolution		0.001A	0.01A	0.1A	
	Accuracy		0.5% L ±2D	0.5% L ±2D	0.05% L ±2D	
100mV/A	Resolution	0.1mA	0.001A	0.01A		
	Accuracy	0.5% L ±2D	0.5% L ±2D	0.05% L ±2D		
1000mV/A	Resolution	0.1mA	0.001A			
	Accuracy	0.5% L ±2D	0.05% L ±2D			

Secondary measurements and displays: MAX, MIN, AVG and transformation ratio of the sensor



## Technical characteristics of the MTX 3291 (continued)

### AAC RMS current

Range		600mA	6A	60A	600A	6000A
Ratio						
1mV/A	Resolution			0.01A	0.1A	1A
	Accuracy			1.5% L ±5D (BW ≈ 400Hz)	1% L+0.25% x [F(kHz)-1] L ±5D (BW: 10Hz to 50kHz)	0.5% L+0.18% x [F(kHz)-1] L ±3D (BW: 10Hz to 100kHz)
10mV/A	Resolution		0.001A	0.01A	0.1A	
	Accuracy		1.5% L ±5D (BW ≈ 400Hz)	1% L+0.25% x [F(kHz)-1] L ±5D (BW: 10Hz to 50kHz)	0.5% L+0.18% x [F(kHz)-1] L ±3D (BW: 10Hz to 100kHz)	
100mV/A	Resolution	0.1mA	0.001A	0.01A		
	Accuracy	1.5% L ±5D (BW ≈ 400Hz)	1% L+0.25% x [F(kHz)-1] L ±5D (BW: 10Hz to 50kHz)	0.5% L+ 0.18% x[F(kHz)-1] L ±3D (BW: 10Hz to 100kHz)		
1000mV/A	Resolution	0.1mA	0.001A			
	Accuracy	1% L+0.25% x [F(kHz)-1] L ±5D (BW: 10Hz to 50kHz)	0.5% L+ 0.18% x [F(kHz)-1] L ±3D (BW: 10Hz to 100kHz)			
Peak factor 3		@ 500mA	@ 5A	@ 50A	@ 500A	@ 5000A

From 1kHz, the measurement must exceed 15% of the range

Secondary measurements and displays: MAX, MIN, AVG and transformation ratio of the sensor

300Hz filter: if the filter is active, see “300Hz filter” curve for the additional uncertainty.

### AAC+DC TRMS current

Range		600mA	6A	60A	600A	6000A
Ratio						
1mV/A	Resolution			0.01A	0.1A	1A
	Accuracy			1.5% L ±15D (BW ≈ 400Hz)	0.8% L+0.18% x [F(kHz) -1] L ±15D (BW: 10Hz to 50kHz)	0.5% L+0.18% x [F(kHz) -1] L ±13D (BW: 10Hz to 100kHz)
10mV/A	Resolution		0.001A	0.01A	0.1A	
	Accuracy		1.5% L ± 5D (BW ≈ 400Hz)	0.8% L+0.18% x [F(kHz) -1] L ±15D (BW: 10Hz to 50kHz)	0.5% L+0.18% x [F(kHz) -1] L ±13D (BW: 10Hz to 100kHz)	
100mV/A	Resolution	0.1mA	0.001A	0.01A		
	Accuracy	1.5% L ±5D (BW ≈ 400Hz)	0.8% L+0.18% x [F(kHz) -1] L ±15D (BW: 10Hz to 50kHz)	0.5% L+0.18% x [F(kHz) -1] L ±13D (BW: 10Hz to 100kHz)		
1000mV/A	Resolution	0.1mA	0.001A			
	Accuracy	0.8% L+0.18% x [F(kHz) -1] L ±15D (BW: 10Hz to 50kHz)	0.5% L+0.18% x [F(kHz) -1] L ±13D (BW: 10Hz to 100kHz)			
Peak factor 3		@ 500mA	@ 5A	@ 50A	@ 500A	@ 5000A

From 1kHz, the measurement must exceed 15% of the range

Secondary measurements and displays: MAX, MIN, AVG and transformation ratio of the sensor

300Hz filter: if the filter is active, see “300Hz filter” curve for the additional uncertainty.

## Technical characteristics of the MTX 3291 (continued)

### Temperature

#### Pt100/Pt1000

The user can measure the temperature by means of a Pt100/Pt1000 sensor.

Range	Measurement current	Resolution	Accuracy	Protection
-200°C to +800°C	<1mA (Pt100) <0.1mA (Pt1000)	0.1°C	0.1% L ±1°C	1414 Vpk

"Active" protection by PTC thermistor  
Display in °C/°F possible

### Peak

Add 1% L + 30 D to obtain the accuracy corresponding to the function and the range.

Fmax 1kHz (1ms)  
Protection 1414 Vpk

### SURV

#### MIN, MAX, AVG

Add 0.2% L+2D to obtain the accuracy corresponding to the function and the range.

Acquisition time of the extrema approximately 100ms  
Protection 1414 Vpk

### Resistive power

Display of the resistive power with respect to a reference resistance measured on the installation and saved in memory using the HOLD key (600Ω is the default)

The function determined is:  $(\text{measured AC+DC voltage})^2 / VR_{ref}$

Range DC, AC and AC+DC  
Resolution 1mW  
Accuracy: 2 x accuracy V<sub>AC</sub> (in %)  
Max. measurement voltage 1000V<sub>AC+DC</sub>  
Protection 1414 Vpk  
Unit of display W

### Duty cycle

Display of the measurement in % of a logical signal (TTL, CMOS, etc.) in "AC+DC" mode

DC+ duty cycle  =  $\theta$

DC- Duty cycle  =  $T - \theta$

Resolution 0.01%

Minimum duration for  $\theta$  10 μs

Maximum duration for T 0.8 s

Minimum duration for T 200 μs [5kHz]

Nominal range 5 to 95% typical

Sensitivity (10V range) >10% of the range, Freq <1kHz  
>20% of the range, Freq >1kHz

Absolute error on the duty cycle, expressed in % absolute

Protection 1414 Vpk

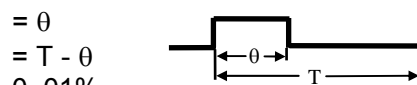

## Technical characteristics of the MTX 3291 (continued)

### Pulse width

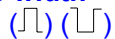

Depending on frequency counter triggering conditions.

Resolution	10µs
Minimum pulse width	100µs
Accuracy	0.1% ±10µs
Maximum duration of a period	1.25s (0.8Hz)
Triggering threshold	20% of the range except 1000VAC range

This threshold is: positive in , negative in .

Additional error on the measurement due to the slope at the zero crossing:  
See §. Measurement of duty cycle.

Protection 1414 Vpk

### dBm

Display of the measurement in dBm with respect to a resistance reference chosen by the user from among 50Ω, 75Ω, 90Ω, and 600Ω, (default value 600Ω)

Resolution	0.1dBm
Absolute error in dBm	0.09 x relative error VAC expressed in %
Additional calculation error	0.1dBm
Measurement range	10mV to 1000V
Protection	1414 Vpk

### Operation of the audible beep

Beep reporting a valid key	High-pitched sound
Beep reporting an invalid key	Low-pitched sound
Successive beeps reporting an overshoot of the danger threshold (alarm)	High-pitched sound
Successive beeps reporting recording of the MAX, MIN, PEAK	High-pitched sound
Successive beeps (alarm) → current >10A	High-pitched sound
Continuity measurement	Medium-pitched sound

## Technical characteristics of the MTX 3291 (continued)

### Variation in the nominal range of use

Quantity of influence	Range of influence	Quantity influenced	Influence	
			typical	MAX
Batt. voltage	4V to 6V	all	<3D	0.2% L+1D
Temperature	-10°C... 18 28 ... 55°C	VDCmV	0.02% L ±0.2D/1°C	0.04% L ±0.25D/1°C
		VACmV, V <sub>LowZ</sub> mV	0.08% L ±0.2D/1°C	0.15% L ±0.25D/1°C
		VDC	0.01% L ±0.1D/1°C	0.05% L ±0.1D/1°C
		VAC, VAC+DC, V <sub>LowZ</sub>		0.25% L ±0.1D/1°C
		ADC	0.05% L ±0.1D/1°C	0.1% L ±0.1D/1°C
		AAC and AAC+DC	0.08% L ±0.1D/1°C	0.12% L ±0.1D/1°C
		→	0.01% L ±0.1D/1°C	0.1% L/1°C
		Ω	0.05% L/1°C	0.1% L/1°C
		60 MΩ		0.3% L/1°C
		μF		0.2% L ±0.1D/1°C
		mF		0.6% L ±0.1D/1°C
		Hz		0.01% L/1°C
		Temp.		± 2°C+0.05% L/1°C
Stabilization time		≈ 2h	2.5h	
Humidity (without condensation)	10%... 80% RH	V	0	0
		A		
		→		
		Ω (*) Hz		
EMC (immunity to the radiated field)	300MHz... 500MHz	Ω clamp		600 pts
	300MHz... 500MHz			450 pts
Common mode	1000V 50Hz	VAC, VAC+DC, V <sub>LowZ</sub>	Range	typical
			60mV 600mV	>35dB
			6V	>60dB
			60V 600V 1000V	>95dB

### Response of the 300Hz filter

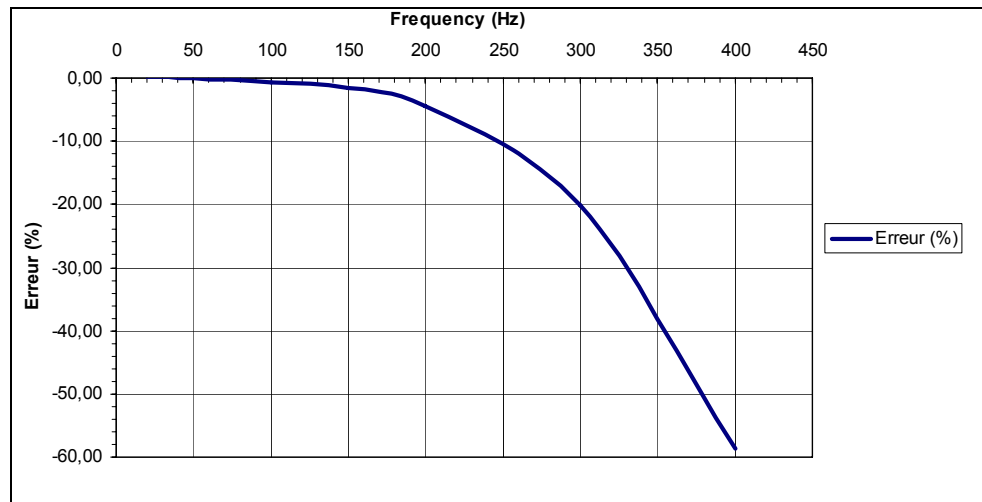

## General characteristics

### Environmental conditions

Altitude	<2000m
Reference range	23°C ±5°C
Specified range of use	-10°C to 55°C
Influence of temperature	see §. Influences
Relative humidity	0% to 80% from 0°C to 31°C 0% to 70% from 40°C to 55°C limited to 70% for the 6 and 60 Ω ranges
Dust- and water-tightness	IP67 (in the event of immersion, under 1m of water for 30 mn, it is necessary to let the water flow off or to let the unit dry before putting it back into service).
Storage range	- 20°C to 70°C

### Power supply

The multimeter is powered by primary or rechargeable batteries:

- Batteries, 4x1.5V nominal – LR6, Alkaline  
Life in VDC:  
**MTX3290**: ≈ 200h  
**MTX3291**: ≈ 300h
- Rechargeable batteries, 4x1.2V, A-A, Ni-MH LSD, 2400mAh  
Life in VDC:  
**MTX3290**: ≈ 140h  
**MTX3291**: ≈ 210h

### Display

The refresh rate of:

- the display unit is 200ms
- the bargraph is 100ms.

CE

### Security

According to NF EN 61010-1:

- Insulation class 2
- Degree of pollution 2
- Use indoor
- Altitude <2000m

Measurement category of the "measurements"

**MTX3290**: 600V CAT III and 300V CAT IV with respect to earth

**MTX3291**: 1000V CAT III and 600V CAT IV with respect to earth

### CEM

This instrument is designed in conformity with the EMC standards in force and its compatibility has been tested in accordance with the following standards:

- Emissions (cl. A) and Immunity NF EN 61326-1

## Mechanical characteristics

### Housing

• Dimensions	196 x 90 x 47.1mm
• Mass	570g
• Materials	Polycarbonate (PC)
• Dust- and water-tightness	IP67, according to NF EN 60529

## Supply

### with the instrument

- Directions for operation in 5 languages, on mini CD
- SX-DMM software on mini CD (**MTX 3291**, only)
- Getting started guide
- 1 set of safety leads (red and black) with double insulation probe tip (Ø4mm) 1000V, CAT III, 20A
- 1 set of 4 AA/R6 batteries
- 1 statement of manufacturer's measurements
- Optical USB communication lead (**MTX 3291**, only)
- 1 carrying case (**MTX 3291**, only)

### optional

- Current clamps (see table below)
- Two-wire Pt100 temperature probe (HX0091)
- Two-wire Pt1000 temperature probe (HA1263)
- Metrology software for Windows (P01196770)
- Set of 4 rechargeable batteries (external charger) (HX0051B)
- External charger for 4 Ni-MH rechargeable batteries (HX0053)
- HV probe (SHT 40kV)
- CMS clamp (HX0064)
- Multifix adapter for DMM (P01102100Z)

- spare**
- **MTX 3291:** Fuse, 11A, 10x38, 1000V - Fast - breaking capacity: >20kA
  - **MTX 3290:** Fuse, 10A: 6x32 - 600V - Fast - breaking capacity: >50kA (Get in touch with our Manumasure Regional Technical Centre).
  - Kit of test accessories for DMM (P01295459Z)
  - Carrying case with Multifix (HX0052B)

List of clamps set to  mV/A	Ratio	To order
<b>Miniflex MA100</b> from 0.5 to 3000 AAC 10Hz to 20kHz	1 or 10 or 100	P0112056X
<b>Ampflex A100</b> from 0.5 to 3000 AAC 10Hz to 20kHz	1 or 10 or 100	P0112050X
<b>MNXX or MN 73 clamps</b> from 0.1 to 240 AAC 40Hz to 10kHz	10	P01120421
<b>E3N-6N clamps</b> from 0.05 to 80 AAC/DC DC to 8kHz	1 or 10 or 100	P0112004XA
<b>PACXX clamps</b> from 0.2 to 1400 AAC/DC DC to 10kHz	1 or 10	P0112006X/P0112007X



01 - 2015  
X04065A02 - Ed. 03

**DEUTSCHLAND - Chauvin Arnoux GmbH**  
Ohmstraße 1, 77694 KEHL am RHEIN  
Tel: (07851) 99 26-0 - Fax: (07851) 99 26-60

**SCHWEIZ - Chauvin Arnoux AG**  
Moosacherstrasse 15 - 8804 AU / ZH  
Tel: 044 727 75 55 - Fax: 044 727 75 56

**UNITED KINGDOM - Chauvin Arnoux Ltd**  
Unit 1 Nelson Ct - Flagship Sq - Shaw Cross Business Pk  
DEWSBURY, West Yorkshire - WF12 7TH  
Tel: 01924 460 494 - Fax: 01924 455 326

**CHINA - Shanghai Pujiang Enerdis Instruments Co. Ltd**  
3 Floor, Building 1 - N° 381 Xiang De Road  
Hongkou District - 200081 SHANGHAI  
Tel: +86 21 65 21 51 96 - Fax: +86 21 65 21 61 07

**中国 - 上海浦江埃纳迪斯仪表有限公司**  
上海市虹口区祥德路381号3号楼3楼  
Tel: +86 21 65 21 51 96 - Fax: +86 21 65 21 61 07

**ITALIA - Amra SpA**  
Via Sant'Ambrogio, 23/25 - 20846 MACHERIO (MB)  
Tel: 039 245 75 45 - Fax: 039 481 561

**ESPAÑA - Chauvin Arnoux Ibérica S.A.**  
C/ Roger de Flor, 293 - 1a Planta - 08025 BARCELONA  
Tel: 902 20 22 26 - Fax: 934 59 14 43

**ÖSTERREICH - Chauvin Arnoux GmbH**  
Slamastrasse 29/24 - 1230 WIEN  
Tel: 01 61 61 9 61-0 - Fax: 01 61 61 9 61-61

**MIDDLE EAST - Chauvin Arnoux Middle East**  
P.O. BOX 60-154 - 1241 2020 JAL EL DIB (Beirut) - LEBANON  
Tel: (01) 890 425 - Fax: (01) 890 424

**SCANDINAVIA - CA Mätssystem AB**  
Sjöflygvägen 35 - SE 18304 TÄBY  
Tel: +46 8 50 52 68 00 - Fax: +46 8 50 52 68 10

**USA - Chauvin Arnoux Inc - d.b.a AEMC Instruments**  
200 Foxborough Blvd. - FOXBOROUGH - MA 02035  
Tel: (508) 698-2115 - Fax: (508) 698-2118

<http://www.chauvin-arnoux.com>

190, rue Championnet - 75876 PARIS Cedex 18 - FRANCE  
Tél. : +33 1 44 85 44 85 - Fax : +33 1 46 27 73 89 - [info@chauvin-arnoux.fr](mailto:info@chauvin-arnoux.fr)  
Export : Tél. : +33 1 44 85 44 86 - Fax : +33 1 46 27 95 59 - [export@chauvin-arnoux.fr](mailto:export@chauvin-arnoux.fr)