

F892

Redundant fieldbus power supply for horizontal DIN-rail mounting

- Redundant fieldbus power for FOUNDATION™ fieldbus cards
- 8-segment redundancy
- High-density, compact design
- Fully isolated
- Hot swappable power modules*
- Low power dissipation
- Zero component carrier
- On-line diagnostics option
- Redundant power & conditioning
- Horizontal DIN-rail mounting
- F801 output 21.5V, 350mA
- F802 output 28V, 500mA



The **F892 fieldbus power system** is designed to provide redundant power for eight FOUNDATION™ fieldbus H1 segments when used with the Emerson DeltaV or another non-proprietary cabled fieldbus system.

Power for the fieldbus segments is provided by two power modules- F801s or F802s- operating in redundant configuration (load sharing). Failure alarms, galvanic isolation, power conditioning and segment termination are incorporated into each F80x module. In simplex applications, a single F80x module may be used. Termination of the fieldbus segments is automatically maintained when single or redundant F80x modules are fitted.

For extreme reliability, the module carrier has no components and only provides interconnections between the power modules and external connections. It is supported in a rigid metal frame that protects the circuit board from mechanical damage. Secure DIN-rail mounting is provided by integrated fixings.

Each F80x module monitors the output of the eight fieldbus segments and indicates an alarm by means of a built-in, normally closed relay if any of the segments is shorted or below the minimum output voltage threshold. Failure of either of the bulk power input supplies is also annunciated. The alarm contacts are volt-free and galvanically isolated from other circuitry. Connections to the alarm relays are made via terminals on the F892-CA carrier. A separate

alarm module is not required for this function. LED indicators also show the status of each F80x module and the eight individual segments. In normal operation, each segment LED is lit, showing that the segment is powered. If a segment is shorted, this LED is extinguished, and the module Alarm LED is lit.

A separate physical layer diagnostics module may be installed on the carrier to automatically collect and distribute additional diagnostic information for each of the eight fieldbus segments. For more information see the F809F product specification.

The F80x module provides galvanic isolation between the 24V DC input power and the fieldbus segments, as required by the IEC61158-2 fieldbus standard and the Fieldbus Foundation™ FF-831 validation test for power conditioners. There is also galvanic isolation between the fieldbus segments, thereby preventing multiple segment failures due to ground faults on more than one segment. Each segment has its own fieldbus power conditioner and current limitation.

Redundant 24V DC (nom.) input power is connected to the F892 carrier using two-part pluggable connectors. Field wiring connections are available with either pluggable screw terminals (F892-PS) or pluggable spring clamp terminals (F892-PC).

FOUNDATION™ fieldbus is a trademark of Fieldbus Foundation™, Austin, Texas.

* Gas clearance certificate needed in Zone 2 hazardous areas

F892 fieldbus power system

September 2016

SPECIFICATION

Location of equipment

Safe area,
Class I Div 2 Groups ABCD T4 or
Class I Zone 2 IIC T4

INPUT	F801	F802
Input voltage (DC)	19.2 - 30.0V	19.2 - 30.0V
Current consumption (24V input, all outputs fully loaded)	3.5A*	6A*
Total Power dissipation (24V input, all outputs fully loaded)	20W*	24W*
* Redundant operation		
OUTPUT	F801	F802
Number of channels	Eight (8)	Eight (8)
Voltage (DC)	21.5V - 24.0V	28.0V - 30.0V
Design current (per segment)	0 to 350mA	0 to 500mA
Current limit	> 370mA	> 520mA
Minimum load	0mA	0mA
Isolation		
Fieldbus to input power:	250V AC rms withstand	
Segment to segment:	200V DC withstand	

ALARMS

Alarm contact rating
1A maximum @ 30V DC maximum

Alarm contact status
Normally closed

Alarm threshold	F801	F802
Segment output	<19V DC	<24V DC

ELECTRICAL CONNECTIONS

System & optional Diagnostics segment terminals

3-way fixed screw terminal connector 0.14 to 2.5 mm²

Field & Power terminals

Pluggable rising cage-clamp screw terminals (-PS)
Conductor size: 0.14 to 2.5 mm²

Pluggable spring-clamp screw terminals (-PC)
Conductor size: 0.2 to 2.5 mm²

Alarm / ground terminals

4-way fixed screw terminal connector 0.14 to 2.5 mm²

Cable screen ground connections (version F.0 or higher)

User-selectable jumper for segment shields: isolated (default) or interconnected and ground connection

Terminators

A single termination is provided automatically when using either 1 or 2 power modules

ENVIRONMENTAL

Ambient temperature	F801	F802
Operating (full load)	-40°C to +65°C	-40°C to +50°C
Operating (60% load)	-40°C to +65°C	-40°C to +65°C
Storage	-40°C to +85°C	-40°C to +85°C

Note: Temperature range applies only when fitted to a horizontal DIN rail mounted on a vertical plane.

Ingress protection

IP20 to BS EN60529 (Additional protection by use of enclosure)

MECHANICAL

Mounting method

Integrated fixings for 'Top hat' DIN rail, 35mm x 7.5mm to EN50022

Weights

F801: 1.45kg
F802: 1.50kg
F892-CA-P*: 1.10kg

F892 - BLOCK DIAGRAM

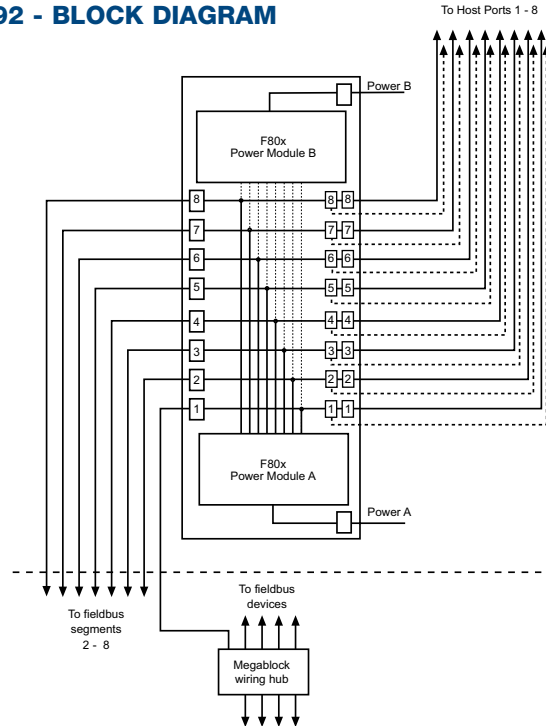

The above diagram shows a block diagram of how the F892 is wired. Note that the Chassis Ground and Alarm connection are not shown. The Diagnostic module is also not shown (see the F809F product specification). For detailed wiring information see the Installation Instructions for the F892 (Document number 502-091). The diagram also shows two sets of 8 connectors for connection to the Host. Early versions of the F892 included only one set of connectors (unit date code 0711, and earlier) and so did not support redundant Host connection. Some host systems such as the Emerson DeltaV provide their own method of connecting the Redundant Host port, in which case a Simplex connection to the F892 is all that is required, or desired.

ELECTRICAL

EMC Compliance

To EN61326:1998 Electrical equipment for measurement, control and laboratory use - EMC requirements

PHYSICAL NETWORKS

IEC61158-2
ISA-S50.02 Part 2-1992
FOUNDATION™ fieldbus H1
Profibus PA

ORDERING INFORMATION

DESCRIPTION	PART NO
Carrier, unpopulated	F892-CA-P*
8-segment power module: 21.5V, 350mA	F801
8-segment power module: 28V, 500mA	F802
F892-CA-P* and two F801 modules	F892-P*
F892-CA-P* and one F801 module	F892-P*-NR
F892-CA-P* and two F802 modules	F892-2-P*
F892-CA-P* and one F802 module	F892-2-P*-NR
Blanking modules included with -NR systems	F800-BLK
Fieldbus diagnostic module	F809F

* = S or C S = Pluggable Screw Terminal Connectors
C = Pluggable Spring Clamp Connectors

F801 PARAMETERS

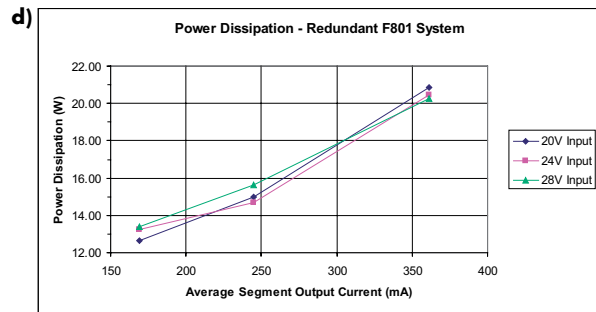
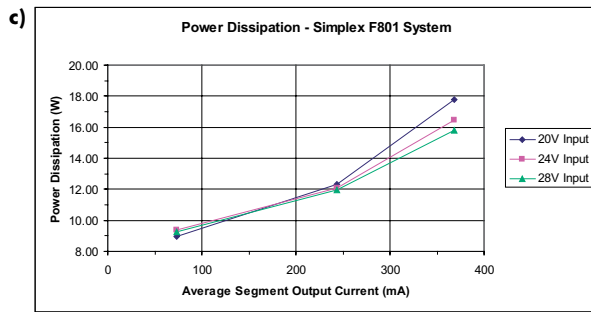
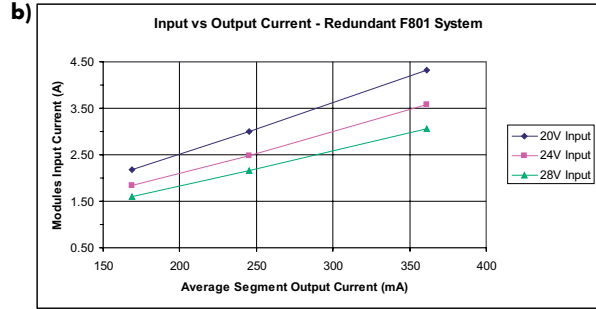
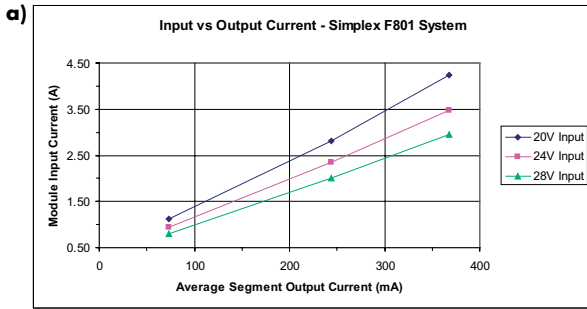

F802 PARAMETERS

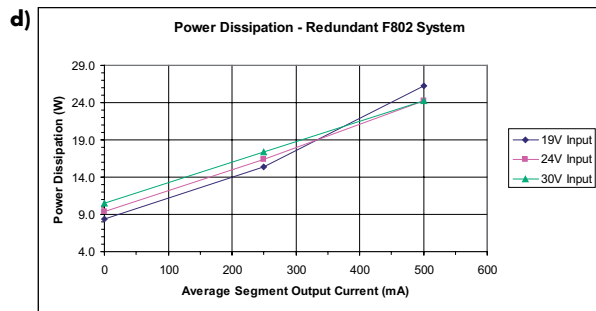
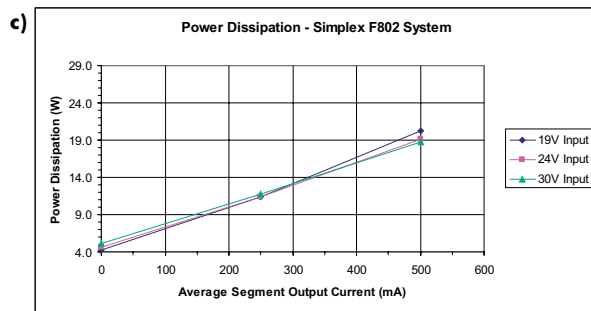
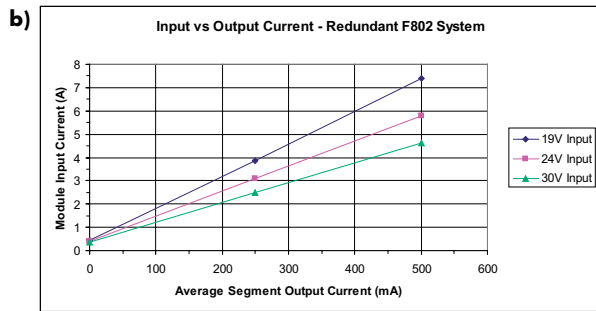
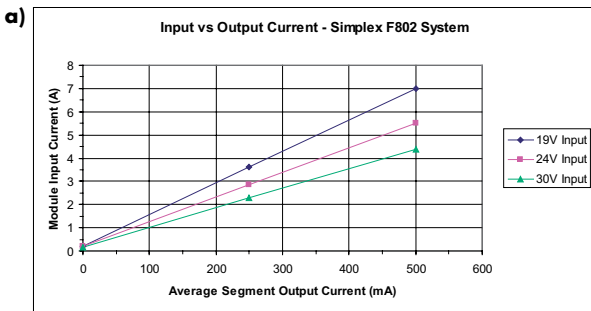

F80x module top panels showing indicators

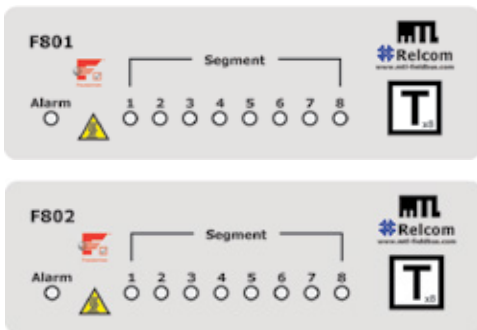

F80x module top panels showing indicators

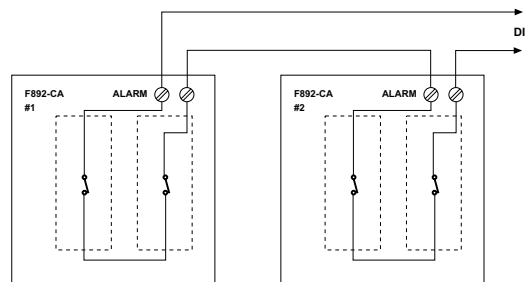

F892 fieldbus power system

September 2016

F892-P* DIMENSIONS

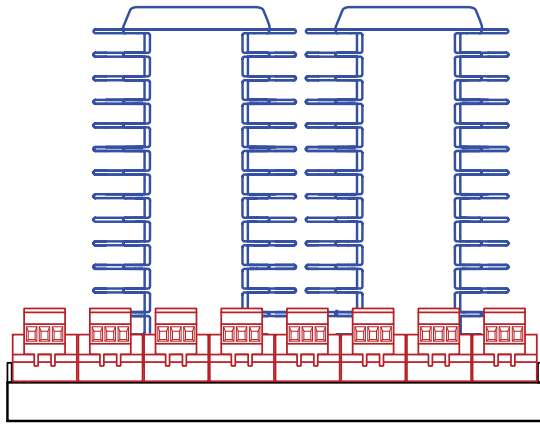

Carriers with date codes 0711 or earlier are only provided with a single row of eight connectors (top).

The Diagnostic Segment Connectors were introduced on carriers with date codes after 1012.

The Shield Ground Option was added with revision F.0 (previous versions did not carry a revision code)

CAD drawings are available on-line at www.mtl-fieldbus.com

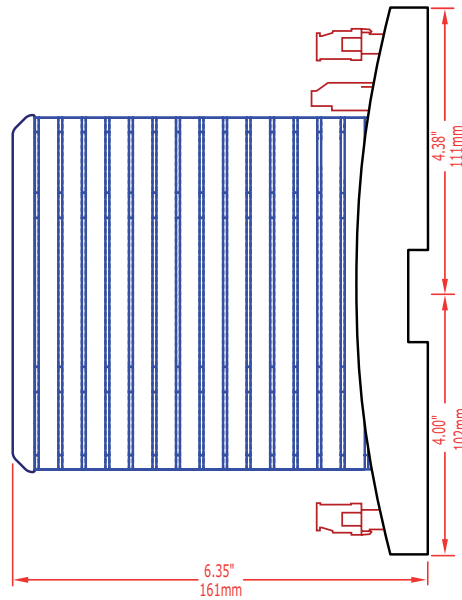
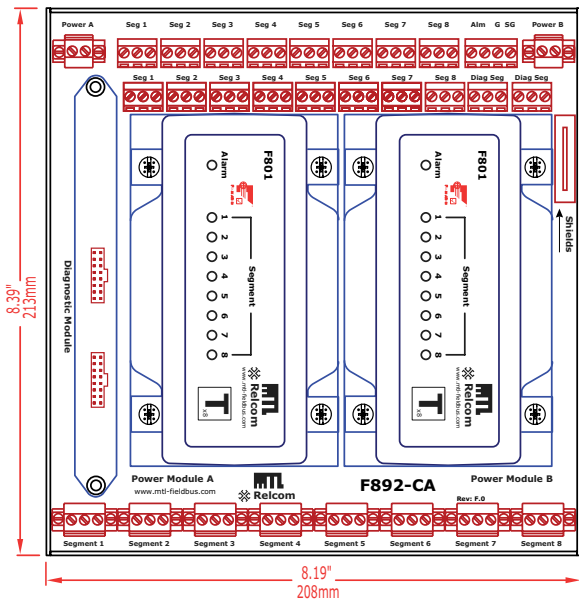

APPROVALS - for the latest certification information visit www.mtl-inst.com/certificates

Region (Authority)	Standard	Certificate	Approved for	Ratings
EU (Relcom)	EN61326		Class A Industrial Locations	CE
(Fieldbus Foundation™)	FF-831	PS001700 - (F801) PS001900 - (F802)		Power Supply Type 132
US (FM)	3600, 3611, 3610	3025124 - (F801) 3033657 - (F802)	Class I, Div 2, ABCD, T4 Class I, Zone 2, IIC, T4	Vmax = 24V (F801) = 30V (F802)
Canada (FM)	C22.2 No. 213 C22.2 No. 142	3025124C - (F801) 3033657C - (F802)	Class I, Div 2, ABCD, T4 Class I, Zone 2, IIC, T4	Vmax = 24V (F801) = 30V (F802)
EU (Relcom)	IEC 60079-0:2004 IEC 60079-15:2005	RELCO7ATEX1002X (F801 + F802)	Ex nA IIC T4	Uo = 24V (F801) = 30V (F802)



Eaton Electric Limited,
Great Marlings, Butterfield, Luton
Beds, LU2 8DL, UK.
Tel: + 44 (0)1582 723633 Fax: + 44 (0)1582 422283
E-mail: mtlenquiry@eaton.com
www.mtl-inst.com

© 2016 Eaton
All Rights Reserved
Publication No. EPS F892 rev 10 200916
September 2016

EUROPE (EMEA):
+44 (0)1582 723633
mtlenquiry@eaton.com

THE AMERICAS:
+1 800 835 7075
mtl-us-info@eaton.com

ASIA-PACIFIC:
+65 6 645 9888
sales.mtlsing@eaton.com

The given data is only intended as a product description and should not be regarded as a legal warranty of properties or guarantee. In the interest of further technical developments, we reserve the right to make design changes.