

F811

Redundant fieldbus power for Foxboro I/A series™ control system

- **Redundant fieldbus power for FBM228 FOUNDATION™ fieldbus modules**
- **8-segment redundancy**
- **High-density, compact design**
- **Fully isolated**
- **Low power dissipation**
- **No components on carrier**
- **Built-in "smart" termination**
- **Physical layer diagnostic option**
- **Vertical DIN-rail mounting**
- **F801 output 21.5V, 350mA**
- **F802 output 28V, 500mA**



The **F811 fieldbus power system** is designed to provide redundant FOUNDATION™ fieldbus power for Foxboro I/A Series control systems using FBM228 modules. The F811 module carrier has system connectors for direct connection to two redundant pairs of FBM228 modules mounted on standard Foxboro baseplates using the standard cables. Eight fieldbus segments are supported. The system comprises a carrier which accommodates two F801 or F802 power modules operating in redundant configuration. Failure alarms, galvanic isolation, power conditioning and segment termination are incorporated into each F80x module. In applications requiring simplex power, a single F80x module may be used.

For extreme reliability, the module carrier has no components and provides only interconnections between the power modules and the external connections.

Each F80x module has indicator LEDs to show both its status and that of the eight segments under power. In normal operation, each green 'Segment' LED is lit, showing that the segment is powered. If a segment is shorted, this LED is extinguished, and the red 'Alarm' LED is lit. In the alarm condition, a normally closed, galvanically-isolated relay contact goes to an open condition. Connections to the alarm relay are made via screw terminals on the F811 carrier. If multiple F811 units are used, a common alarm circuit can be achieved by 'daisy-chaining' the alarm circuits.

The **F80x module provides galvanic isolation** between the 24V DC input power and the fieldbus segments, as required by the IEC61158-2 fieldbus standard and the Fieldbus Foundation™ FF-831 validation test for power conditioners. There is also galvanic isolation between the fieldbus segments, thereby preventing multiple segment failures from ground faults on more than one segment. Each segment has its own fieldbus power conditioner and current limitation. Termination of the fieldbus segment is automatically maintained when single or redundant F80x modules are fitted.

An F809F diagnostic module may optionally be installed on the carrier, to automatically collect and distribute diagnostic information on each of the eight fieldbus segments. Measured parameters may be viewed in the Foxboro control system by either assigning the F809F as a fieldbus device to segment 1 or 8 of the powered segments, or by means of a separate fieldbus segment. Connections for the separate segment are provided on the carrier. For more information see the F809F product specification.

Redundant 24V DC (nom.) input power is connected to the F811 carrier using two-part pluggable connectors.

Field wiring connections are available with either pluggable screw terminals (F811-PS) or pluggable spring clamp terminals (F811-PC).

F811 - BLOCK DIAGRAM

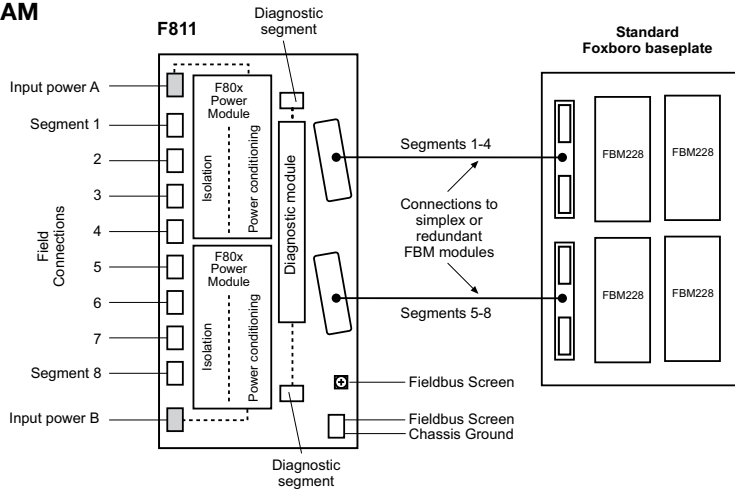

SPECIFICATION

Location of equipment

Safe area

INPUT

| | F801 | F802 |
|---|--------------|--------------|
| Input voltage (DC) | 19.2 - 30.0V | 19.2 - 30.0V |
| Current consumption (24V input, all outputs fully loaded) | 3.5A* | 6.0A* |
| Total Power dissipation (24V input, all outputs fully loaded) | 20W* | 24W* |

* Redundant operation

OUTPUT

| | F801 | F802 |
|------------------------------|---------------|---------------|
| Number of channels | Eight (8) | Eight (8) |
| Voltage (DC) | 21.5V - 24.0V | 28.0V - 30.0V |
| Design current (per segment) | 0 to 350mA | 0 to 500mA |
| Current limit | > 370mA | > 520mA |
| Minimum load | 0mA | 0mA |

Isolation

Fieldbus to input power: 250V AC rms withstand
Segment to segment: 200V DC withstand

ALARMS

Alarm contact rating

1A maximum @ 30V DC maximum

Alarm contact status

Normally closed

Alarm threshold

| | F801 | F802 |
|----------------|-------------|-------------|
| Segment output | <19V DC | <24V DC |

MECHANICAL

Mounting method

Integrated fixings for 'Top hat' DIN rail, 35mm x 7.5mm to EN50022

Weights (approx.)

| | |
|-------------|--------|
| F801: | 1.45kg |
| F802: | 1.50kg |
| F811-C*-P*: | 0.92kg |

ENVIRONMENTAL

| | F801 | F802 |
|----------------------------|----------------|----------------|
| Ambient temperature | | |
| Operating (full load) | -40°C to +65°C | -40°C to +50°C |
| Operating (60% load) | -40°C to +65°C | -40°C to +65°C |
| Storage | -40°C to +85°C | -40°C to +85°C |

Note: Temperature range applies only when mounted on a horizontal DIN rail attached to a vertical surface.

Ingress protection

IP20 to BS EN60529
(For additional protection mount the equipment in an enclosure)

ELECTRICAL

System connectors

Host 1, Host 2, via standard cables to FBM228 modules mounted on standard Foxboro template

Field, Power & Alarm terminals

Pluggable rising cage-clamp screw terminals (-PS)

Conductor size: 0.14 to 2.5 mm²

Pluggable spring-clamp screw terminals (-PC)

Conductor size: 0.2 to 2.5 mm²

Chassis ground

2-way fixed screw terminal connector 0.14 to 2.5 mm²

Terminators

A single termination is provided automatically when using either 1 or 2 power modules

EMC Compliance

To EN61326:1998 Electrical equipment for measurement, control and laboratory use - EMC requirements

PHYSICAL NETWORKS

IEC61158-2
ISA-S50.02 Part 2-1992
FOUNDATION™ fieldbus H1

ORDERING INFORMATION

DESCRIPTION

Left-hand carrier, unpopulated
Right-hand carrier, unpopulated

PART NO.

F811-CL-P*
F811-CR-P*

8-segment power module: 21.5V, 350mA

F801

8-segment power module: 28V, 500mA

F802

Blanking module

(Used in place of an F80x power module for non-redundant operation in order to defeat the failure alarm caused by the absence of the F80x.)

F800-BLK

Fieldbus diagnostic module

F809F

F811-CL-P* and two F80x modules
F811-CR-P* and two F80x modules

with F801
F811-L*
F811-R*

with F802
F811-2-L*
F811-2-R*

F811-CL-P* and one F80x module
F811-CR-P* and one F80x module

F811-L*-NR
F811-R*-NR

F811-2-L*-NR
F811-2-R*-NR

* = S or C

S = Pluggable Screw Terminal Connectors

C = Pluggable Spring Clamp Connectors

F801 PARAMETERS

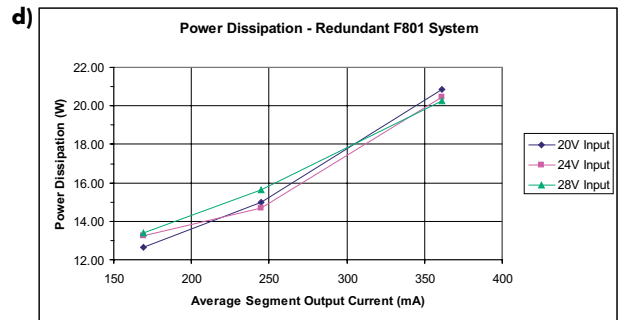
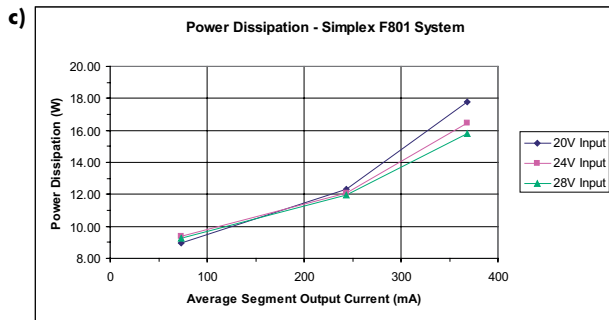
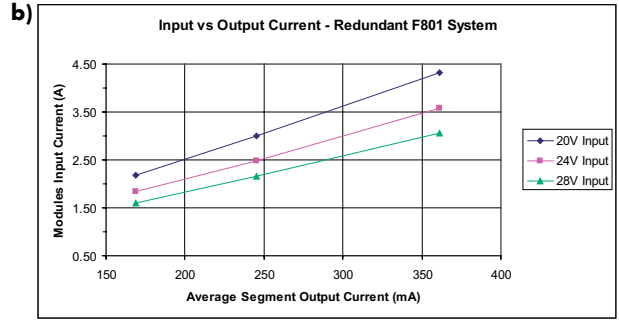
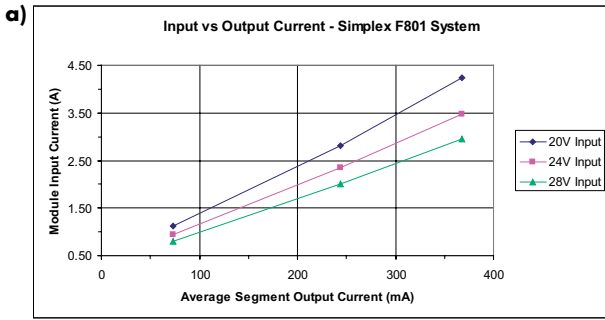

F802 PARAMETERS

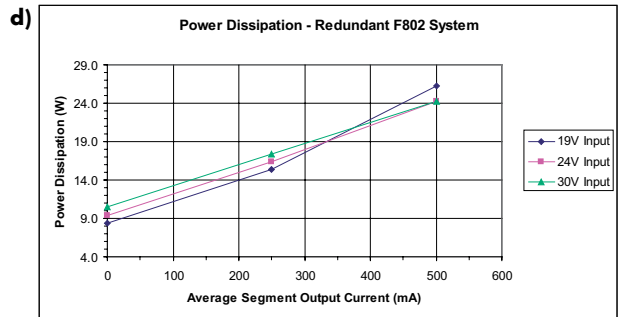
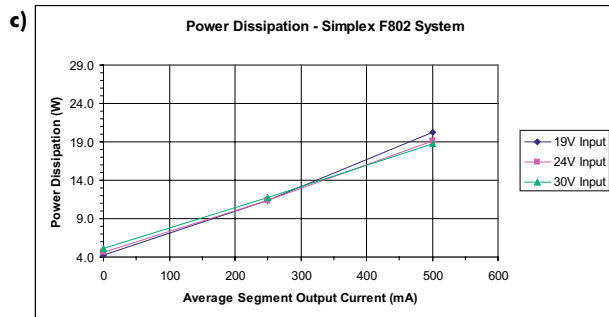
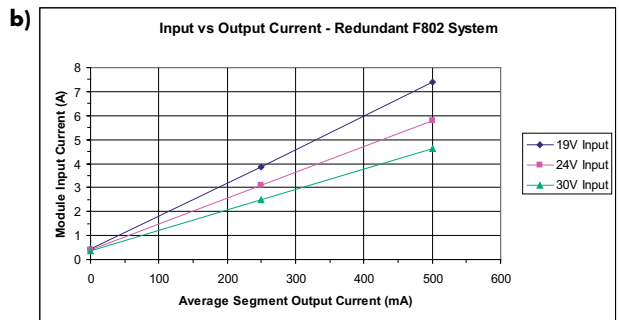
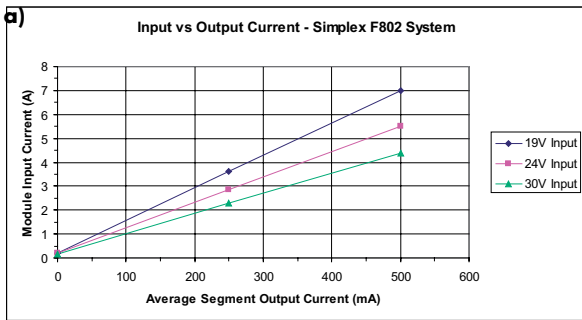

Linking alarm circuits

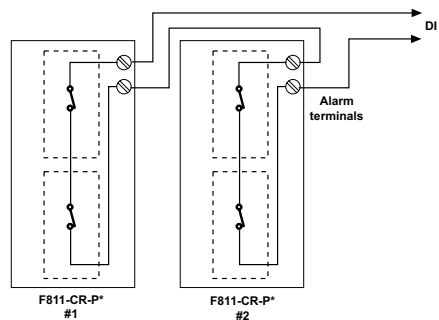

F811

September 2016

DIMENSIONS (mm)

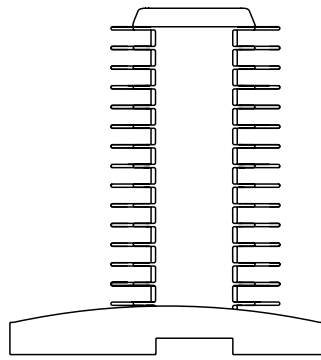
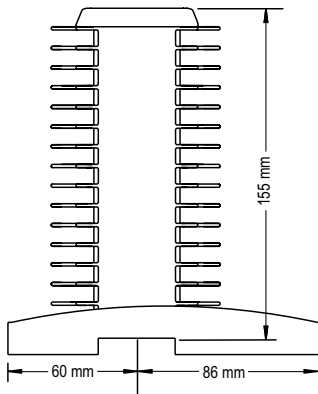
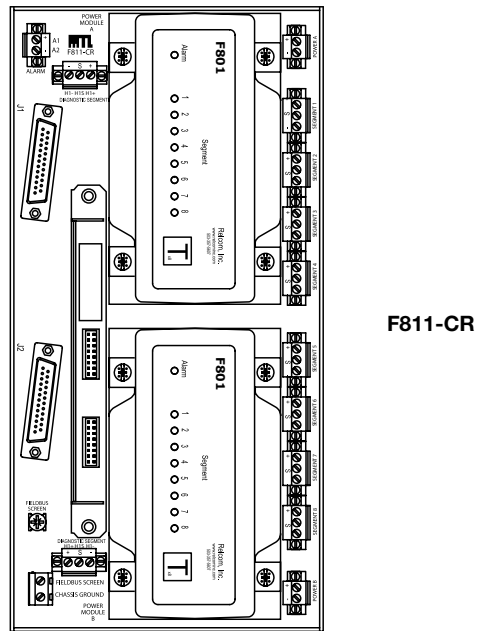
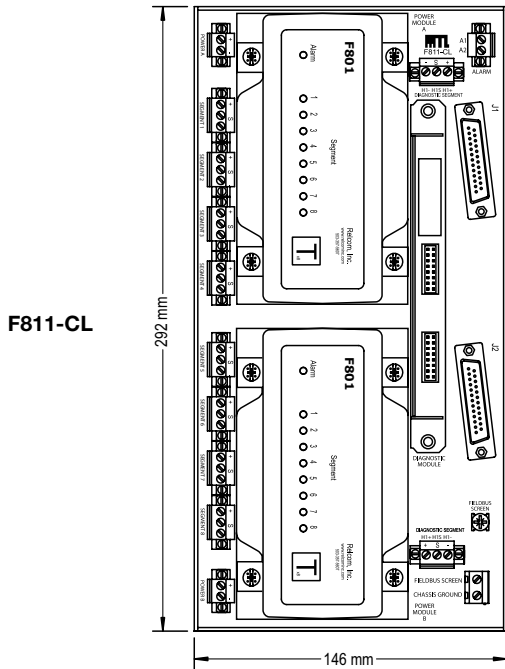

F80x module top panels showing indicators

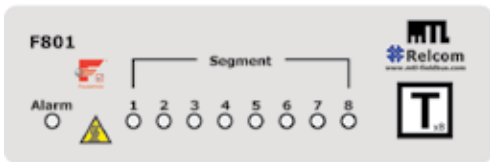

APPROVALS - for the latest certification information visit www.mtl-inst.com/certificates

| Country | Authority | Standard | Certificate | Approved for | Ratings |
|---------|----------------------|----------|------------------------------------|------------------|---------|
| - | Fieldbus Foundation™ | FF-831 | PS001700 (F801) PS001900 (F802) | H1 Profile - 132 | - |



Eaton Electric Limited,
Great Marlings, Butterfield, Luton
Beds, LU2 8DL, UK.
Tel: + 44 (0)1582 723633 Fax: + 44 (0)1582 422283
E-mail: mtlenquiry@eaton.com
www.mtl-inst.com

© 2016 Eaton
All Rights Reserved
Publication No. EPS F811 rev 2 200916
September 2016

EUROPE (EMEA):
+44 (0)1582 723633
mtlenquiry@eaton.com

THE AMERICAS:
+1 800 835 7075
mtl-us-info@eaton.com

ASIA-PACIFIC:
+65 6 645 9888
sales.mtlsing@eaton.com

The given data is only intended as a product description and should not be regarded as a legal warranty of properties or guarantee. In the interest of further technical developments, we reserve the right to make design changes.