

MTL 9188

8-segment redundant fieldbus power supply for
Yokogawa CENTUM VP control systems



Powering Business Worldwide

Declaration of Conformity

A printed version of the Declaration of Conformity has been provided separately within the original shipment of goods. However, you can find a copy of the latest version at <http://www.mtl-inst.com/certificates>

CONTENTS

	DECLARATION OF CONFORMITY	II
	GENERAL SAFETY INSTRUCTIONS	IV
1	OVERVIEW	1
2	DESCRIPTION	2
2.1	Load sharing and output redundancy	2
2.2	Input power redundancy	2
2.3	Alarms	4
2.4	Isolation	4
2.5	Physical layer diagnostics	4
2.6	Surge protection	4
2.7	Connector options	4
3	SYSTEMS AND COMPONENTS	5
4	MECHANICAL	6
4.1	Mounting Orientation	6
4.2	Enclosure Requirements	6
4.3	DIN-rail mounting option	7
4.4	Surface mounting	7
5	ELECTRICAL CONNECTIONS	8
5.1	DC Power Requirements	9
5.2	Power A and Power B	9
5.3	Host connections	10
5.4	Segment connections	10
5.5	Power Modules	10
5.6	Redundancy	10
5.7	Terminator	11
5.8	Alarm connection	11
5.9	Ground connection	12
5.10	Diagnostic segment connections	12
6	TESTING	13
6.1	9191-FP Status and Alarm LEDs	13
7	ROUTINE MAINTENANCE	13
8	ATEX INFORMATION	14
8.1	General	14
8.2	Installation	14
8.3	Inspection and maintenance	14
8.4	Repair	14
8.5	Marking	15

GENERAL SAFETY INFORMATION

Safety instructions for installation and operating personnel

The operating instructions provided here contain **essential safety instructions** for installation personnel and those engaged in the operation, maintenance and servicing of the equipment.

	WARNING ! / AVERTISSEMENT Failure to comply with these instructions can endanger the lives or health of personnel and risk damage to the plant and the environment. Ne pas se conformer à ces instructions peut mettre en danger la vie ou la santé du personnel et faire encourir des préjudices à l'usine et à l'environnement.
---	--

	WARNING ! / AVERTISSEMENT The responsibility for planning, installation, commissioning, operation and maintenance, particularly with respect to applications in explosion-hazard areas, lies with the plant operator. La responsabilité de la planification, de l'installation, de la première mise en service, de l'exploitation et de l'entretien, en particulier en ce qui concerne les applications dans des secteurs présentant un danger d'explosion, relève de l'exploitant de l'installation.
---	--

	WARNING ! / AVERTISSEMENT EXPLOSION HAZARD - Substitution of components may impair suitability for Class 1, Division 2. RISQUE D'EXPLOSION - La substitution de composants peut rendre ce matériel inacceptable pour les emplacements de Classe 1, Division 2.
---	---

	WARNING ! / AVERTISSEMENT EXPLOSION HAZARD - Do not disconnect equipment unless power has been switched off or the area is known to be non-hazardous. RISQUE D'EXPLOSION - Avant de déconnecter l'équipement, couper le courant ou s'assurer que l'emplacement est désigné non dangereux.
---	--

Before commencing installation or commissioning:

- Read and understand the contents of this manual and the related product datasheet
- Ensure installation and operating personnel have received adequate training for this task
- Ensure that any operating instructions are fully understood by the personnel responsible.
- Observe national and local installation and mounting regulations.

	WARNING ! / AVERTISSEMENT These assemblies may not be used in explosion-hazard area applications if they, or any component part, have been used previously in general electrical installations. Ces ensembles ne peuvent pas être utilisés dans les applications pour zones à risque d'explosion s'ils, ou n'importe quel composant, ont été employés précédemment dans des installations d'électricité générale.
---	--

During operation:

Make the relevant instructions available at all times to the operating personnel.

- Observe safety instructions.
- Observe national safety and accident prevention regulations.
- Operate the equipment within its published specification.
- Servicing, maintenance work or repairs not described in this manual must not be performed without prior agreement with the manufacturer.
- No changes to any of the components that might impair their explosion protection are permitted.

If any information provided here is not clear: Contact Eaton's MTL product line or one of its representatives.

Note: Improper installation and operation of the assembly can result in the invalidation of the guarantee.

Note: For US and Canada: This equipment is suitable for use in Class 1, Division 2, Groups A, B, C, D and Class 1, Zone 2, Group IIC or Non-Hazardous locations only.

9188 - Redundant Fieldbus Power Supply 8-segment

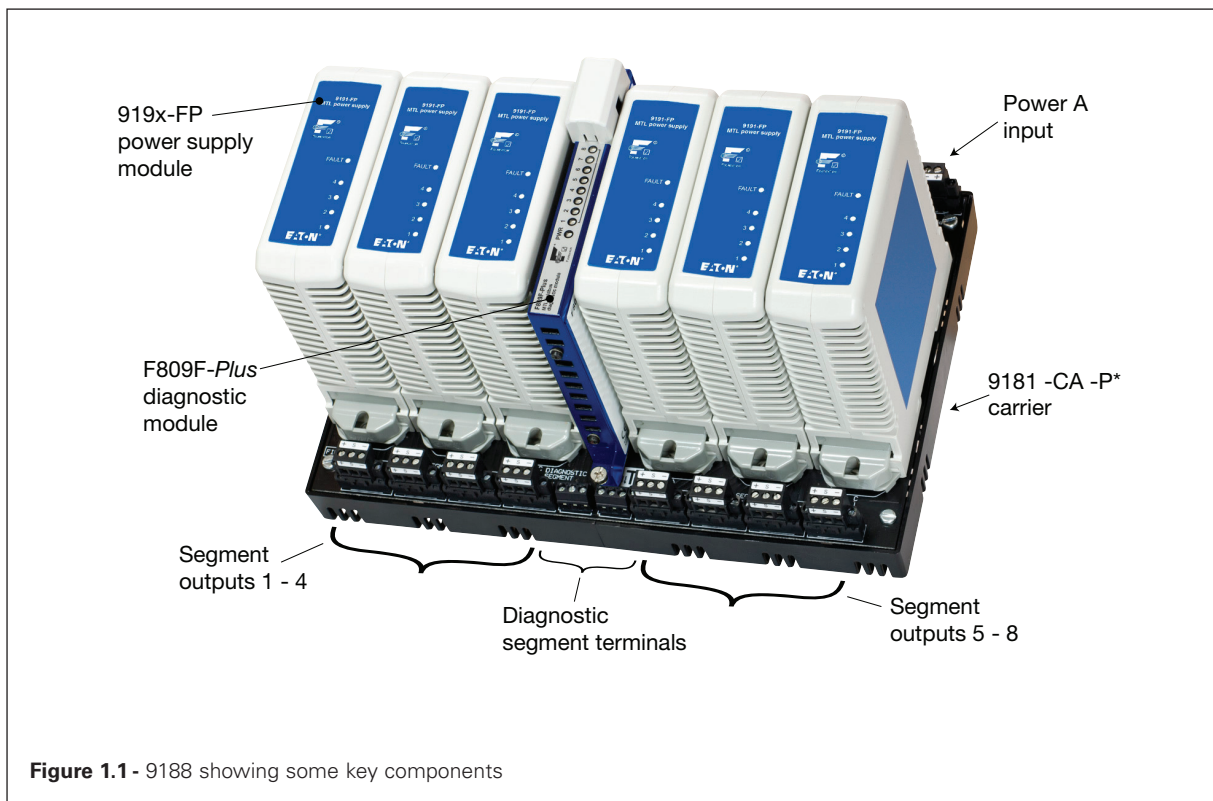

Figure 1.1 - 9188 showing some key components

1 OVERVIEW

This manual explains the installation and maintenance procedures for the 9188 Redundant Fieldbus Power Supplies and must be read in association with the product datasheets that contain the electrical data.

The 9188 fieldbus power system is designed to provide redundant power for eight FOUNDATION™ fieldbus H1 segments on the Yokogawa CENTUM VP control system. It is optimised for use in general purpose and hazardous area High Energy Trunk architectures which, with the appropriate FieldPlus™ wiring components, supports fieldbus devices using all hazardous area protection techniques. The power supply has been designed to optimise cabinet layouts, maximising the number of fieldbus segments powered per cabinet while providing space for installing and maintaining cable connections and minimising the operating temperature.

Various configurations are available by ordering the appropriate model number.

9188-XY-P*

Where **X** = 2 = 250mA, 4-segment redundant supply (or 500mA max. simplex)
 or **X** = 4 = 500mA, 4-segment redundant supply
 or **X** = 6 = 250mA, 8-segment redundant supply (or 500mA max. simplex)
 or **X** = 9 = 500mA, 8-segment redundant supply

(See next page for more information when choosing current capacity)

Y = 1 = 28.0- 32.0V output voltage

Y = 2 = 19.0- 22.0V output voltage, for Ex ic spur applications†

and **P*** = PS (pluggable screw terminal connectors) or
 PC (pluggable spring clamp connectors)

†Refer also to INMF30 and INMF300 for more information on fieldbus installations with Ex ic spurs

2 DESCRIPTION

The system provides segment current capacity in 250mA increments, up to 500mA, and then offers redundancy with the provision of an additional 250mA module, which is connected in a load-sharing manner, to achieve an N+1 type of configuration.

Each 919x-FP module will support 4 segments, so two “groups” of modules are required to support 8-segments. The following diagram explains the options when choosing current capacity and/or redundancy for an 8-segment system.

(* A blanking module is recommended for each unused position- see Section 5.8 on page 11)

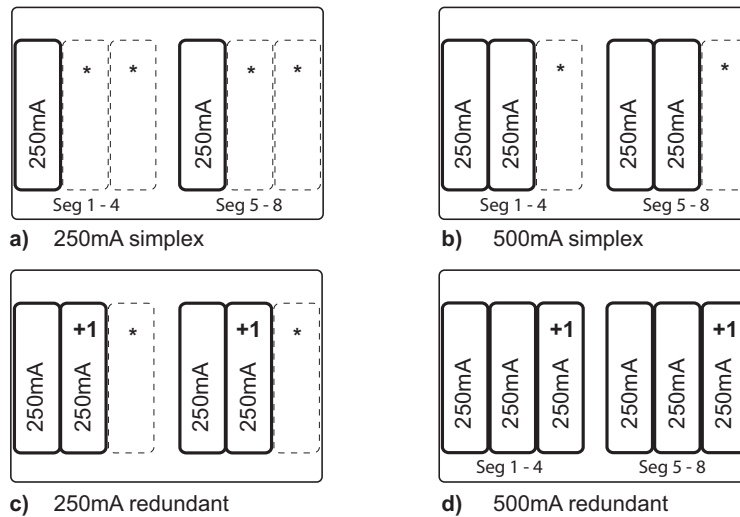

Figure 2.1- Application options

Diagrams b) and c) are the same in their implementation but differ in their function because, while b) can offer 500mA per segment, c) is designed to guarantee 250mA per segment even if one of its power modules should fail.

So, for redundant applications, initially requiring up to 250mA current per segment, two groups of two 919x-FP modules are fitted on the carrier (diagram c), with the option of adding a third power module to each group (diagram d) in the event of future segment expansion.

NOTE

To avoid incompatible output voltages within each block of redundant modules, 9191-FP and 9192-FP module types should not be mixed on a 9188-CA-Px module carrier.

2.1 Load sharing and output redundancy

Each module is designed to supply four output segments, and any additional modules, up to a total of three, operate on a true load-sharing basis, where the current supplied by a module is balanced with that supplied by the other(s).

The module indicated by '+1' in Figure 2.1 is identical to the others, but the '+1' indicates its role of 'redundancy', and that it can maintain power to the segments in the event of a module failure.

2.2 Input power redundancy

Redundancy is also available in the supply of power to the modules. Power A and Power B terminals enable two independent supplies to be connected to the carrier and their power is distributed to the three module positions as indicated in Figure 2.3.

Module 'A' is supplied by Power A, module 'B' is supplied by Power B and module 'C' is powered by diode 'OR'-ing Power A and B. This ensures that output is maintained if one of the Power inputs should fail or be interrupted.

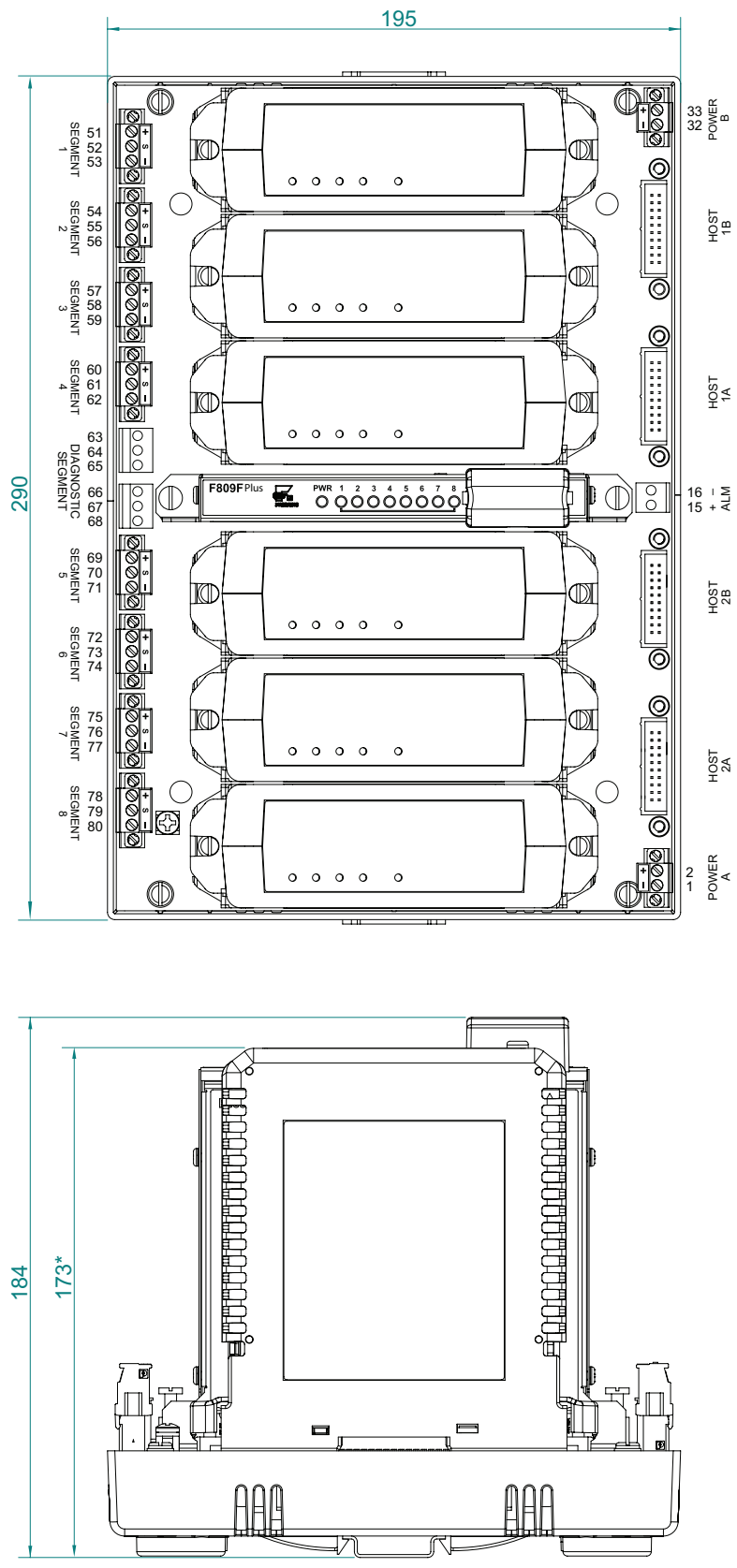

* This dimension applies if the F809F-Plus diagnostic module is not used.

Figure 2.2- Dimension drawing with all modules fitted

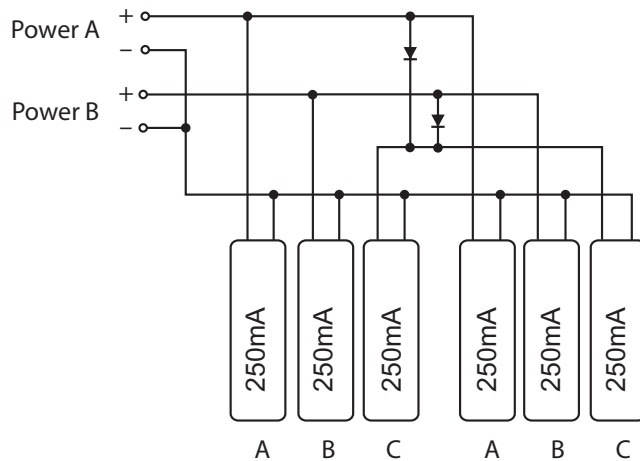

Figure 2.3 - Power distribution to modules

2.3 Alarms

Each 919x-FP module monitors the output of the four fieldbus segments and indicates an alarm (by means of a built-in, normally-closed relay) if any of the segments is shorted, or its output falls below the 'minimum output voltage threshold'. Failure of either of the two bulk power input supplies is also announced.

The alarm contacts are volt-free and galvanically isolated from other circuitry. Connections to the alarm relays are made via terminals on the 9188-CA-Px carrier; a separate alarm module is not required for this function, but see Section 5.8 on page 11 for guidance when power modules are removed from the carrier.

LED indicators show the status of each 919x-FP module and that of the four individual segments. In normal operation each segment LED is lit, showing that the segment is powered. If a segment is shorted, this LED is extinguished, and the module Alarm LED is lit. See Section 5.8 on page 11 for connection details.

2.4 Isolation

The 919x-FP module provides galvanic isolation between the 24V DC input power and the fieldbus segments, as required by the IEC61158-2 fieldbus standard and the Fieldbus Foundation™ FF-831 validation test for power conditioners. There is also galvanic isolation between the fieldbus segments, thereby preventing multiple segment failures due to ground faults on more than one segment.

2.5 Physical layer diagnostics

A separate physical layer diagnostics module - F809F-Plus - may be installed on the carrier to automatically collect and distribute additional diagnostic information for each of the eight fieldbus segments. For more in-depth information see the F809F-Plus product specification and its instruction manual (INM F809F-Plus).

2.6 Surge protection

Pluggable surge-protection components for each fieldbus trunk are available as an option reducing the installed cost of providing surge protection on fieldbus networks.

2.7 Connector options

Redundant 24V DC (nom.) input power is connected to the 9188-CA-Px carrier using two-part pluggable connectors. System connections are compatible with ALF111 fieldbus communication modules, via AKB336 cables, and field wiring connections are available with either pluggable screw terminals (9188-CA-PS) or pluggable spring clamp terminals (9188-CA-PC). The pluggable connections are screw-retained providing a reliable connection in an industrial environment.

3 SYSTEMS AND COMPONENTS

The system and component part numbers and their descriptions are given here.

System

Part No.	Description
9188-21-P*	4-segment system with: 9188-CA-P* carrier + two 9191-FP + four 9197-BLK
9188-41-P*	4-segment system with: 9188-CA-P* carrier + three 9191-FP + three 9197-BLK
9188-61-P*	8-segment system with: 9188-CA-P* carrier + four 9191-FP + two 9197-BLK
9188-91-P*	8-segment system with: 9188-CA-P* carrier + six 9191-FP
9188-22-P*	4-segment system with: 9188-CA-P* carrier + two 9192-FP + four 9197-BLK
9188-42-P*	4-segment system with: 9188-CA-P* carrier + three 9192-FP + three 9197-BLK
9188-62-P*	8-segment system with: 9188-CA-P* carrier + four 9192-FP + two 9197-BLK
9188-92-P*	8-segment system with: 9188-CA-P* carrier + six 9192-FP

Components

Part No.	Description
9191-FP	4-segment power module: 28.0-32.0V, 250mA
9192-FP	4-segment power module: 19.0-22.0V, 250mA
9188-CA-P*	Carrier, unpopulated
9197-BLK	Blanking module
F809F-Plus	Diagnostic module

* = S – Pluggable, screw terminal connectors

= C- Pluggable, spring cage-clamp terminal connectors

4 MECHANICAL

4.1 Mounting Orientation

The optimum orientation for the 9188-CA-P* carrier is mounted on a vertical surface using a horizontally aligned DIN-rail, or surface mounted in the same orientation- see Figure 4.1. This method of mounting ensures optimum heat dissipation from the 919x-FP Power Supply Modules, and an operating temperature range of -20°C to $+60^{\circ}\text{C}$. If the DIN rail is mounted vertically on a vertical surface then the upper temperature limit must be reduced to $+50^{\circ}\text{C}$.

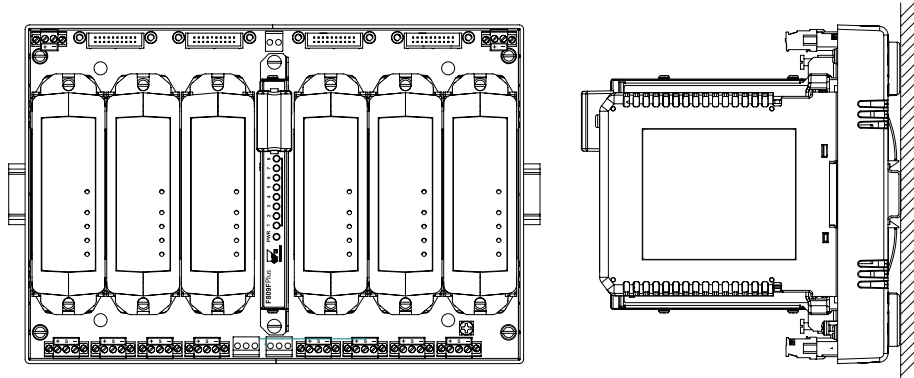

Figure 4.1 - Preferred mounting orientation

4.2 Enclosure Requirements

4.2.1 General Requirements

The assembly may be mounted in Hazardous (classified) areas – see Sections 8. The following conditions must also be satisfied to ensure safe and reliable operation.

- a) The equipment must be installed in an area of not more than pollution degree 2 as defined in IEC 60664-1 and in an enclosure that provides a degree of protection of at least IP54 and meets the relevant requirements of IEC 60079-0 and IEC 60079-15.
- b) Prevent any form of pollution that could compromise the operation of the unit. For example, choose an unpolluted location or a suitable enclosure to protect the assembly.
- c) Provide an adequate level of mechanical protection. This can be achieved by selecting a protected location, a suitable enclosure, or a combination of both.
- d) Ensure that all cable entries and connections are secure by making provision for the careful routing and securing of all cables.
- e) Provide adequate security against unauthorized interference.
- f) Ensure that the permitted ambient temperature range detailed in Section 4.1 is not exceeded. Allow for power dissipation within the enclosure and consider the use of shading against direct sunlight.

4.2.2 Outdoor Mounting

If the power system is mounted in an outdoor location, use a suitable enclosure with a minimum of IP54 ingress protection. A higher level of ingress protection rating will be necessary if the working atmosphere is or can be corrosive or if the enclosure is subject to wet or dusty environments.

All fixing bolts must be suitable for the mounting surface and the environmental conditions. Prepare holes in the mounting surface, on the centres shown in Figure 3.1 or 3.2, to accept suitable screws/bolts for mounting.

4.3 DIN-rail mounting option

The carrier is designed for mounting on 35mm x 7.5mm T-section "top hat" DIN rail to EN50022 and uses four built-in DIN clamp tabs to hold it on the rail.

4.3.1 To mount on DIN rail

The power modules at each end of the carrier must be removed to obtain access to the DIN-rail clamp screws.

Before starting to mount the carrier on the DIN rail, insert a small screwdriver through the access holes in the circuit board (Figure 4.2) and rotate all four of the clamping screws counterclockwise (i.e. unscrew) until the clamping tabs have been swung out of the channel for the DIN rail- as position 'A' in Figure 4.3.

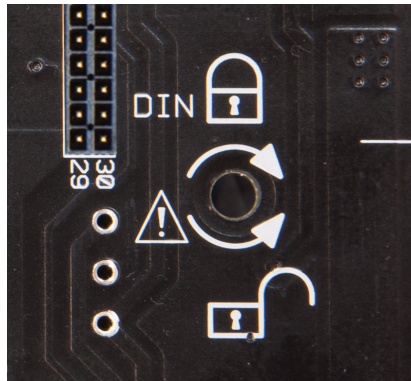

Figure 4.2 - Carrier top showing an access hole and rotation directions for the locking tabs.

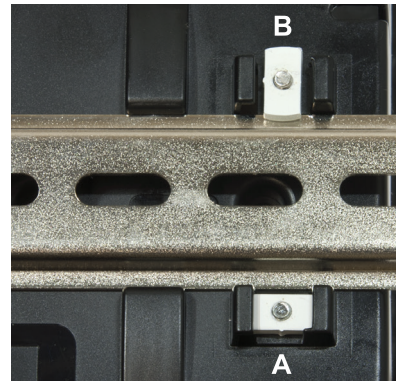

Figure 4.3 - Carrier underside showing tab open position (A) and closed position (B)

Press the carrier onto the DIN-rail and rotate each of the clamping screws clockwise until each of the four tabs is tightened against the DIN-rail- as position 'B' in Figure 4.3. (Recommended torque: 0.5Nm)

4.3.2 Removal from DIN rail

The power modules at each end of the carrier must be removed to obtain access to the DIN-rail clamp screws.

Support the carrier by pressing it to the DIN-rail and unscrew (counterclockwise) the four indicated DIN-rail clamping screws.

NOTE

Turn each screw no more than three full turns when releasing its clamping tab from the rail. Further turns should be unnecessary and could ultimately damage the circuit board or the carrier.

Remove the carrier.

4.4 Surface mounting

The rear face of the carrier has four circular raised feet with slotted holes for mounting the carrier onto a flat surface. See Figure 4.3.

NOTE

The carrier hangs on the fixings and so there must be a minimum of 10mm top clearance above the carrier to enable it to be located over the screw heads before it is lowered onto the M4 fixings.

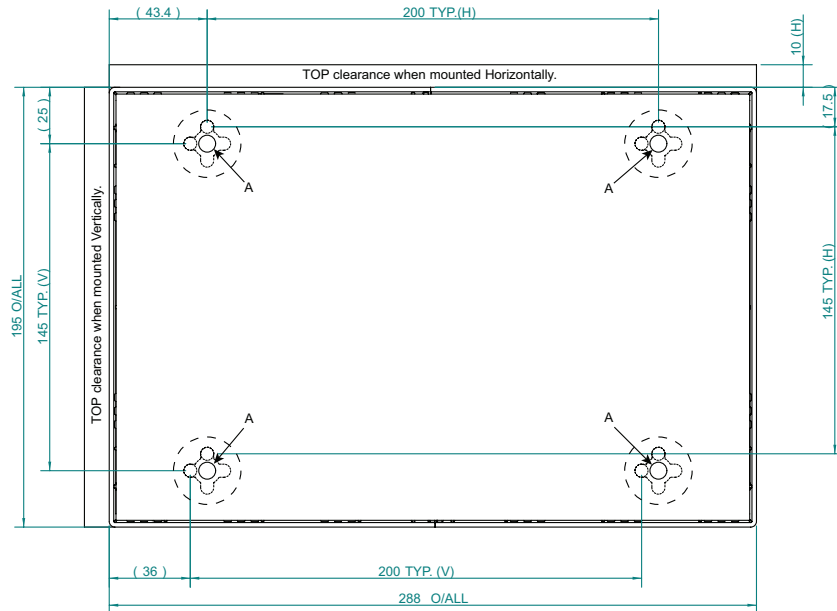

Figure 4.4- Surface-mount hole positions and dimensions

The four M4 fixing screws should be screwed into the (panel) surface leaving approximately 5–6mm of thread visible between the screw head and panel. Mount the carrier over the heads of the screw fixings and then lower it into position.

Four holes in the carrier circuit board, indicated as 'A' in Figure 4.3, provide screwdriver access to the four fixings screw once the carrier is mounted. These holes are always visible and do not require the removal of any modules.

Tighten the screws to the recommended torque of 0.5Nm.

On completing the mounting procedure, confirm:

- that the assembly has not suffered any structural damage,
- the carrier has not been distorted,
- all mounting screws are tightened as recommended.

Removal is the reverse of the fitting procedure.

5 ELECTRICAL CONNECTIONS

The DC power and Field Segment connectors are pluggable and available in a screw terminal version (-PS) or a spring-clamp version (-PC). See Figures 5.1 & 5.2 for details. The terminals can accept the following conductor sizes:

Type	Conductor size
Screw terminals	(-PS) 0.14 to 2.5mm ²
Spring-clamp terminals	(-PC) 0.2 to 2.5mm ²

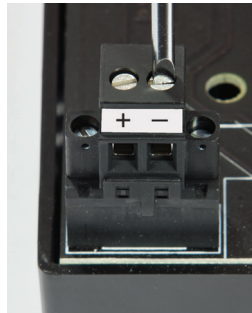

Figure 5.1- Screw terminal

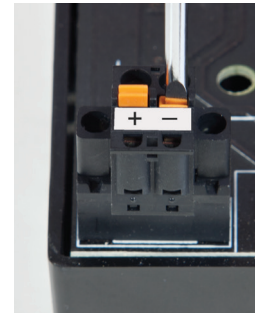

Figure 5.2- Spring-clamp

NOTE

1. A torque screwdriver set between 0.5- 0.6Nm is recommended for tightening all terminal wiring screws and terminal securing screws.
2. When wiring to spring-clamp terminals, use a screwdriver with a 3-4 mm blade and depress the spring-clamp button before inserting the termination cable. See Figure 5.2.

5.1 DC Power Requirements

Dual redundant power terminals, requiring a nominal input voltage of 24VDC, are provided – Power A and Power B – allowing the use of bulk power supplies with a supply range of 19.2–30V DC. Input power cabling and over-current protection devices must be chosen to match the current consumption.

NOTE

The bulk power supply must comply with electrical safety standards IEC 61010 or IEC 60950. Apparatus carrying a CE mark will comply with this requirement.

A 9188-61-P* system, operating with four redundant 9191-FP modules at 24VDC, will require 2.9A in total with all outputs fully loaded. With six redundant 9191-FP modules (9188-91-P* system) at 24VDC, it will require 5.7A.

A 9188-62-P* system, operating with four redundant 9192-FP modules at 24VDC, will require 2.1A in total with all outputs fully loaded. With six 9192-FP modules (9188-92-P* system) at 24VDC, it will require 4.1A.

NOTE

The current demand from Power A or Power B will depend upon the modules inserted. See Section 2.2 for further information on power distribution.

5.2 Power A and Power B

Power A and Power B supplies are distributed on the carrier as described in Section 2.2. DC supply connections are as follows:

Power A	
Pin No.	Connection
1	+ve
2	-ve

Power B	
Pin No.	Connection
32	+ve
33	-ve

Cable lengths on the Power connectors should not exceed 30m.

5.3 Host connections

Connectors are provided to permit direct connection via AKB336 cables to Yokogawa ALF111 cards. Four connectors are fitted to provide the following connections. The host cable length should not exceed 30 metres.

Connector	Function	Segments
Host 1A	Main	1 - 4
Host 1B	Redundant	1 - 4
Host 2A	Main	5 - 8
Host 2B	Redundant	5 - 8

5.4 Segment connections

There are eight Segment connectors, each providing (+), (-) and cable screen (S) connections. See section 5.9 for information on grounding the cable screens.

Connection	Pin No.
Segment 1 (+)	51
Segment 1 (S)	52
Segment 1 (-)	53
Segment 2 (+)	54
Segment 2 (S)	55
Segment 2 (-)	56
Segment 3 (+)	57
Segment 3 (S)	58
Segment 3 (-)	59
Segment 4 (+)	60
Segment 4 (S)	61
Segment 4 (-)	62

Connection	Pin No.
Segment 5 (+)	69
Segment 5 (S)	70
Segment 5 (-)	71
Segment 6 (+)	72
Segment 6 (S)	73
Segment 6 (-)	74
Segment 7 (+)	75
Segment 7 (S)	76
Segment 7 (-)	77
Segment 8 (+)	78
Segment 8 (S)	79
Segment 8 (-)	80

5.5 Power Modules

	<p style="text-align: center;">WARNING !</p> <p>The 919x-FP Power Module can be “hot-swapped” without the risk of electrical damage, but a <u>gas clearance certificate</u> is required to carry out this action in a Zone 2 or Division 2 hazardous area. See “Special conditions for Safe Use” on page 14.</p> <p>Le module de puissance 919x-FP peut être “remplacé à chaud” sans risque de l’endommager, mais un <u>permis de feu</u> est exigé pour effectuer cette action dans une zone de danger classée Zone 2 ou division 2. Voir “Conditions particulières pour une sécurité d’utilisation” en page 14</p>
---	---

The 919x-FP Power Modules are secured to the carrier with two captive screws. Orientate the module to enable it to fit onto the carrier-mounted mating connectors. When mounted, tighten the two captive screws to secure the module.

<p>NOTE</p> <p>A 9197-BLK Alarm Blanking Module is required in any location where a 919x-FP module is not fitted in order to maintain alarm wiring continuity.</p>

5.6 Redundancy

For 250mA per segment requirements, a single 919x-FP module will provide the necessary power for 4 segments. For 500mA per segment, two 919x-FP modules are required. For n+1 redundancy, one additional power module (per four segments) is needed as described in Section 2.2.

Redundant systems are available as:

4-segment	8-segment	Available current
9188-2x-P*	9188-6x-P*	250mA per segment
9188-4x-P*	9188-9x-P*	500mA per segment

5.7 Terminator

Each segment is provided with its own permanent terminator on the circuit board without intervention by the user.

5.8 Alarm connection

See Section 2.3 on page 4 for further details of the alarm function.

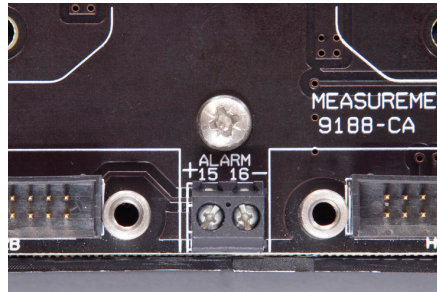

The alarm connections are provided at terminal numbers 15 and 16. Although labelled as '+' and '-' the terminals are not polarity sensitive.

Figure 5.4 illustrates how the switches contained within the 919x-FP modules are interlinked on the carrier.

Figure 5.3- Alarm terminals

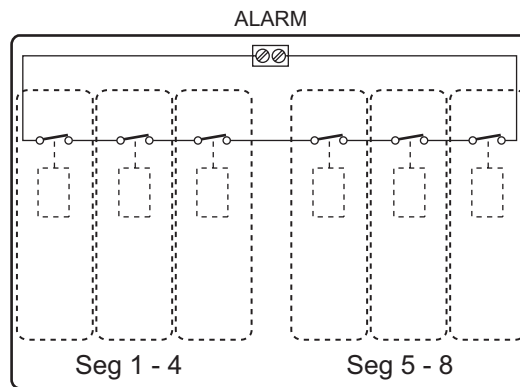

Figure 5.4 - Carrier alarm "circuit"

If a 919x-FP power module is removed or omitted, its position on the carrier should be filled with a blanking module (part number: 9197-BLK). This will maintain continuity of the "alarm circuit" through the carrier by bridging the missing connection that is normally provided by the power module. This prevents a permanent alarm state from existing on the carrier and enables "genuine" alarm events to continue to be signalled.

If multiple 9188 systems are used, a common alarm circuit can be created by connecting the alarm terminals in series ("daisy-chaining")- see Figure 5.5.

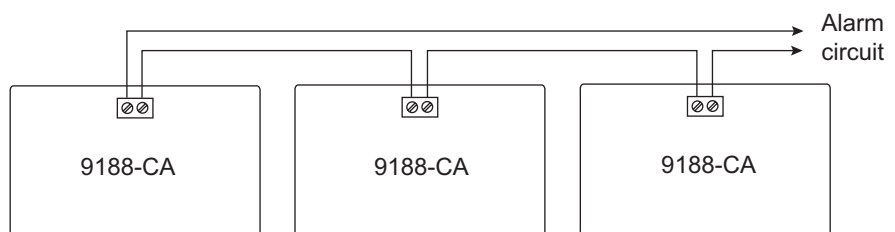

Figure 5.5- Linking alarm connections

5.9 Ground connection

All segment cable screens are linked together and connected to a grounding screw terminal (SG) located close to the Segment 8 connection terminals. See Figure 5.6.

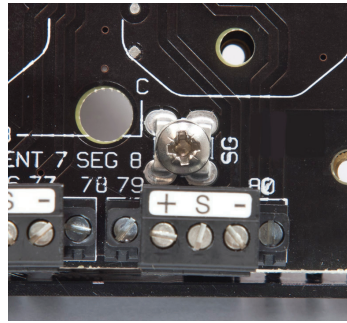

Figure 5.6 - Ground connection

5.9.1 Screen grounding at supply

If the design policy is to ground the fieldbus cable screens at the fieldbus power supply, then the cable screens should be connected to the 'S' terminals on the pluggable field segment connectors. The 'SG' grounding screw (see Figure 5.6) should then be connected to a clean (electrical) ground point in the power supply cabinet. This also provides a ground reference for the F809F-Plus diagnostics module, if it is fitted.

5.9.2 Screen grounding at other location on segment

In this situation, the cable screens should not be connected to the 'S' terminals but cut back and insulated to avoid contact. The 'SG' grounding screw (see Figure 5.6) should then be connected to a clean (electrical) ground point in the power supply cabinet to provide a ground reference for the F809F-Plus diagnostics module, if it is fitted.

5.10 Diagnostic segment connections

If an F809F-Plus fieldbus diagnostic module is mounted on the carrier, terminals 63 to 65 and 66 to 68 enable it to be connected in-line on a segment specifically used for the collection of diagnostic data.



Terminal assignments

63	64	65	66	67	68
+	S	-	+	S	-

Figure 5.7- Diagnostic segment connections

For full details of the diagnostic module, its connections, setup and usage, the user should consult the instruction manual for the F809F-Plus (INM F809F-Plus), which is available on www.mtl-inst.com.

6 TESTING

6.1 919x-FP Status and Alarm LEDs

Each Power Module is fitted with five LEDs, four green ones to indicate the status of individual segments and one red one to signify a Fault/Alarm condition.

FAULT LED	Segment LED(s)	Module location	System status	Alarm contacts
OFF	ON (all)	Any	OK (No Fault)	Closed
ON	OFF	Any	The segment is shorted or the output falls below 16V (9191-FP) or 10V (9192-FP)	Open
	OFF (all)	Slot A	Power A input <4.5V	Open
	OFF (all)	Slot B	Power B input <4.5V	Open

7 ROUTINE MAINTENANCE

Check the general condition of the installation occasionally to make sure that no deterioration has occurred. At least every two years (and more frequently for particularly harsh environments) check:

- the condition of wire connections, terminations, and screens.
- the DC output voltage on each of the eight fieldbus segments is >28V for power supplies fitted with 9191-FP modules or >19V for power supplies fitted with 9192-FP modules. This can be performed using a multi-meter or a MTL FBT-6 Fieldbus Monitor.
- the segment LEDs on the Power Module(s) are ON and the Alarm LED is OFF.
- the Power Module/Blanking Module retaining screws are tight.
- there are no signs of damage or corrosion.

8 ATEX INFORMATION

The Essential Health and Safety Requirements (Annex II) of the EU Directive 2014/34/EC [the ATEX Directive - safety of apparatus] requires that the installation manual of all equipment used in hazardous areas shall contain certain information. This annex is included to ensure that this requirement is met. It complements the information presented in this document and does not conflict with that information. It is only relevant to those locations where the ATEX directives are applicable.

8.1 General

- a) In common with all other electrical apparatus installed in hazardous areas, this apparatus must only be installed, operated and maintained by competent personnel. Such personnel shall have undergone training, which included instruction on the various types of protection and installation practices, the relevant rules and regulations, and on the general principles of area classification. Appropriate refresher training shall be given on a regular basis. [See clause 4.2 of EN 60079-17].
- b) The apparatus has been designed and manufactured so as to provide protection against all the relevant additional hazards referred to in Annex II of the Directive, such as those in clause 1.2.7.
- c) This apparatus has been designed to meet the requirements of electrical apparatus in accordance with EN 60079-0 and EN 60079-15.

8.2 Installation

- a) The installation should comply with the appropriate European, national and local regulations, which may include reference to the IEC code of practice IEC 60079-14. In addition particular industries or end users may have specific requirements relating to the safety of their installations and these requirements should also be met. For the majority of installations the Directive 1999/92/EC [the ATEX Directive - safety of installations] is also applicable.
- b) The apparatus is designed for installation in Zone 2 hazardous areas.
- c) The apparatus must not be subjected to mechanical and thermal stresses in excess of those permitted in the certification documentation, this manual and the product specification.
- d) The apparatus must not be installed in a position where it may be attacked by aggressive substances.

Read also the Special Conditions for Safe Use (below) for any additional or more specific information.

Special Conditions for Safe Use

1. The equipment must be installed in an enclosure or an environment that provides a degree of protection of at least IP54 and meets the relevant material and environmental requirements of IEC 60079-0 and IEC 60079-15.
2. The F809F-Plus Communication Diagnostic Segment connection must be fitted with transient protection devices to ensure that the rated voltage cannot exceed 140% of the peak rated voltage.
3. All external connections to the equipment and internal connections between the modules forming the equipment must not be inserted or removed unless either the area in which the equipment is installed is known to be non-hazardous, or the circuits connected have been de-energised.

8.3 Inspection and maintenance

- a) Inspection and maintenance should be carried out in accordance with European, national and local regulations which may refer to the IEC standard IEC 60079-17. In addition specific industries or end users may have specific requirements which should also be met.

8.4 Repair

This apparatus cannot be repaired by the user and must be replaced with an equivalent certified product.

8.5 Marking

Each certified component is marked in compliance with the Directive and CE marked. This information applies to products manufactured during or after the year 2012. For full certification information visit www.mtl-inst.com/support/certificates/

Product labels (showing certification information)

EATON CROUSE-HINDS SERIES
9188 MTL Fieldbus power supply, Yokogawa
 (-20°C ≤ Ta ≤ +60°C) T4 Ta = -20°C to 60°C
 Ex nA nC IIC T4 Gc Class I, Division 2, Group ABCD
 IECEX BAS 11.0119X C FM US Class I, Zone 2, AEx nA nC IIC
 II 3 G Ex nA nC IIC T4 Ex nA nC IIC T4
 MTL12ATEX9188X D.C. Supply max. 30V, 5.7A @ 24VDC Input (max)
 EATON ELECTRIC LTD, Luton, England, LU2 8DL. Made in England EAC Ex 4185/5

EATON CROUSE-HINDS SERIES
9191-FP
 MTL fieldbus power supply module 28V
 (-20°C ≤ Ta ≤ +60°C)
 II 3 G Ex nA nC IIC T4 Doc. No. MTL12ATEX9191X
 Ex nA nC IIC Gc IECEX BAS 11.0113U
 FM US APPROVED INSTALL PER SCI-1072 Cl 1, Div 2, ABCD T4 Cl 1, Zone 2, IIC T4
 Foundation Fieldbus is a registered trademark of Fieldcomm Group.
 SEE INSTRUCTION MANUAL
 EATON ELECTRIC LTD, Luton, England, LU2 8DL. Made in England. www.mtl-inst.com
 CE 30 424/74

EATON CROUSE-HINDS SERIES
9192-FP
 MTL fieldbus power supply module 19V
 (-20°C ≤ Ta ≤ +60°C)
 II 3 G Ex nA nC IIC T4 Doc. No. MTL12ATEX9192X
 Ex nA nC IIC Gc IECEX BAS 11.0113U
 Foundation Fieldbus is a registered trademark of Fieldcomm Group.
 SEE INSTRUCTION MANUAL
 EATON ELECTRIC LTD, Luton, England, LU2 8DL. Made in England. www.mtl-inst.com
 CE 30 424/72

EATON CROUSE-HINDS SERIES
9197-BLK
 MTL fieldbus blanking module
 (-20°C ≤ Ta ≤ +60°C)
 II 3 G Ex nA nC IIC T4 Doc. No. MTL12ATEX9197X
 Part of IECEX BAS 11.0119X
 SEE INSTRUCTION MANUAL
 EATON ELECTRIC LTD, Luton, England, LU2 8DL. Made in England. www.mtl-inst.com
 CE 30 4188/3

EATON CROUSE-HINDS SERIES
F809F-Plus
 MTL fieldbus diagnostic module
 (-40°C ≤ Ta ≤ +70°C) IECEX BAS 11.0110U
 II 3 G Ex nA nC IIC T4 (-40°C ≤ Ta ≤ +70°C) Doc. No. MTL13ATEXF809FPLUSX
 Class I, Division 2, Group ABCD T4 Ta = -40°C to 70°C
 Class I, Zone 2, AEx nA nC IIC T4 Ta = -40°C to 70°C
 Ex nA nC IIC T4 Ta = -40°C to 70°C
 D.C. Supply max. 30V, 280mA @ 24VDC Input (max)
 Module: WARNING: DO NOT REMOVE OR REPLACE WHILE CIRCUIT IS LIVE WHEN A FLAMMABLE OR COMBUSTIBLE ATMOSPHERE IS PRESENT.
 Avertissement: NE PAS PROCÉDER À UN RETRAIT OU UN REMPLACEMENT ALORS QUE LE CIRCUIT EST SOUS TENSION ET QU'UNE ATMOSPHÈRE INFLAMMABLE OU COMBUSTIBLE EST PRÉSENTE.
 Switch: WARNING: DO NOT OPERATE SWITCH WHILE CIRCUIT IS LIVE WHEN A FLAMMABLE OR COMBUSTIBLE ATMOSPHERE IS PRESENT.
 Avertissement: NE PAS MANIPULER LE COMMUTATEUR ALORS QUE LE CIRCUIT EST SOUS TENSION ET QU'UNE ATMOSPHÈRE INFLAMMABLE OU COMBUSTIBLE EST PRÉSENTE.
 WARNING: POTENTIAL ELECTROSTATIC HAZARD. CLEAN ONLY WITH A MOIST CLOTH AND DETERGENT.
 EATON ELECTRIC LTD, Luton, England, LU2 8DL. Made in England. www.mtl-inst.com
 CE 30 4213/35

AUSTRALIA

MTL Instruments Pty Ltd,
10 Kent Road, Mascot, New South Wales, 2020, Australia
Tel: +61 1300 308 374 Fax: +61 1300 308 463
E-mail: mtl-salesanz@eaton.com

BeNeLux

MTL Instruments BV
Ambacht 6, 5301 KW Zaltbommel
The Netherlands
Tel: +31 (0)418 570290 Fax: +31 (0)418 541044
E-mail: mtl.benelux@eaton.com

CHINA

Cooper Electric (Shanghai) Co. Ltd
955 Shengli Road, Heqing Industrial Park
Pudong New Area, Shanghai 201201
Tel: +86 21 2899 3817 Fax: +86 21 2899 3992
E-mail: mtl-cn@eaton.com

FRANCE

MTL Instruments sarl,
7 rue des Rosiéristes, 69410 Champagne au Mont d'Or
France
Tel: +33 (0)4 37 46 16 53 Fax: +33 (0)4 37 46 17 20
E-mail: mtlfrance@eaton.com

GERMANY

MTL Instruments GmbH,
Heinrich-Hertz-Str. 12, 50170 Kerpen, Germany
Tel: +49 (0)22 73 98 12-0 Fax: +49 (0)22 73 98 12-2 00
E-mail: csckerpen@eaton.com

INDIA

MTL India,
No.36, Nehru Street, Off Old Mahabalipuram Road
Sholinganallur, Chennai- 600 119, India
Tel: +91 (0) 44 24501660 /24501857 Fax: +91 (0) 44 24501463
E-mail: mtlindiasales@eaton.com

ITALY

MTL Italia srl,
Via San Bovio, 3, 20090 Segrate, Milano, Italy
Tel: +39 02 959501 Fax: +39 02 95950759
E-mail: chmninfo@eaton.com

JAPAN

Cooper Crouse-Hinds Japan KK,
MT Building 3F, 2-7-5 Shiba Daimon, Minato-ku,
Tokyo, Japan 105-0012
Tel: +81 (0)3 6430 3128 Fax: +81 (0)3 6430 3129
E-mail: mtl-jp@eaton.com

NORWAY

Norex AS
Fekjan 7c, Postboks 147,
N-1378 Nesbru, Norway
Tel: +47 66 77 43 80 Fax: +47 66 84 55 33
E-mail: info@norex.no

RUSSIA

Cooper Industries Russia LLC
Elektrozavodskaya Str 33
Building 4
Moscow 107076, Russia
Tel: +7 (495) 981 3770 Fax: +7 (495) 981 3771
E-mail: mtlrussia@eaton.com

SINGAPORE

Cooper Crouse-Hinds Pte Ltd
No 2 Serangoon North Avenue 5, #06-01 Fu Yu Building
Singapore 554911
Tel: +65 6645 9864 / 6645 9865 Fax: +65 6 487 7997
E-mail: sales.mtlsing@eaton.com

SOUTH KOREA

Cooper Crouse-Hinds Korea
7F, Parkland Building 237-11 Nonhyun-dong Gangnam-gu,
Seoul 135-546, South Korea.
Tel: +82 6380 4805 Fax: +82 6380 4839
E-mail: mtl-korea@eaton.com

UNITED ARAB EMIRATES

Cooper Industries/Eaton Corporation
Office 205/206, 2nd Floor SJ Towers, off. Old Airport Road,
Abu Dhabi, United Arab Emirates
Tel: +971 2 44 66 840 Fax: +971 2 44 66 841
E-mail: mtlgulf@eaton.com

UNITED KINGDOM

Eaton Electric Ltd,
Great Marlings, Butterfield, Luton
Beds LU2 8DL
Tel: +44 (0)1582 723633 Fax: +44 (0)1582 422283
E-mail: mtlenquiry@eaton.com

AMERICAS

Cooper Crouse-Hinds MTL Inc.
3413 N. Sam Houston Parkway W.
Suite 200, Houston TX 77086, USA
Tel: +1 281-571-8065 Fax: +1 281-571-8069
E-mail: mtl-us-info@eaton.com