

# FLIR Moisture Meter

with Bluetooth<sup>®</sup>

## Model MR55



# Table of Contents

---

<b>1. Advisories</b>	<b>3</b>
1.1 Copyright	3
1.2 Quality Assurance	3
1.3 Documentation	3
1.4 Disposal of Electronic Waste	3
<b>2. Introduction</b>	<b>4</b>
2.1 Key Features	4
<b>3. Description</b>	<b>5</b>
3.1 Meter Description	5
3.2 Display Description	6
3.3 Button Description	6
<b>4. Operation</b>	<b>7</b>
4.1 Meter Power and APO	7
4.2 Measuring Temperature and Relative Humidity	7
4.3 Moisture Measurements	7
4.4 Bluetooth® Transmission Basics	8
4.5 Display Backlight	8
4.6 Worklight	8
4.7 Data Hold	8
4.8 Material Group Selection	8
4.9 Temperature (°C, °F) and Relative Humidity Display Selection	8
4.10 Calibration Verification Test	9
<b>5. Bluetooth® Technical Details</b>	<b>9</b>
<b>6. Field Firmware Upgrades via USB Interface</b>	<b>10</b>
6.1 System Firmware Upgrade	10
6.2 Bluetooth® Firmware Upgrade	11
<b>7. Maintenance</b>	<b>12</b>
7.1 Cleaning	12
7.2 Battery Installation and Replacement	12
7.3 Electrode Pin Replacement	12
<b>8. Safety</b>	<b>13</b>
8.1 FCC Compliance	13
<b>9. Specifications</b>	<b>14</b>
<b>10. Material Group Reference</b>	<b>15</b>
10.1 Common Names of Timbers (BS888/589:1973) with group nos.	15
10.2 Botanical names of timbers with MR55 group numbers	17
10.3 %WME Table (% Wood Moisture Equivalent)	19
<b>11. Technical Support</b>	<b>20</b>
<b>12. Three-Year Limited Warranty</b>	<b>21</b>

# 1. Advisories

---

## 1.1 Copyright

© 2018, FLIR Systems, Inc. All rights reserved worldwide. No parts of the software including source code may be reproduced, transmitted, transcribed or translated into any language or computer language in any form or by any means, electronic, magnetic, optical, manual or otherwise, without the prior written permission of FLIR Systems.

The documentation must not, in whole or part, be copied, photocopied, reproduced, translated or transmitted to any electronic medium or machine readable form without prior consent, in writing, from FLIR Systems.

Names and marks appearing on the products herein are either registered trademarks or trademarks of FLIR Systems and/or its subsidiaries. All other trademarks, trade names or company names referenced herein are used for identification only and are the property of their respective owners.

## 1.2 Quality Assurance

The Quality Management System under which these products are developed and manufactured has been certified in accordance with the ISO 9001 standard.

FLIR Systems is committed to a policy of continuous development; therefore, we reserve the right to make changes and improvements on any of the products without prior notice.

## 1.3 Documentation

To access the latest manuals and notifications, go to the 'Downloads' tab at:

<http://support.flir.com>. It only takes a few minutes to register online. In the download area you will also find the latest releases of manuals for our other products, as well as manuals for our historical and obsolete products.

## 1.4 Disposal of Electronic Waste



As with most electronic products, this equipment must be disposed of in an environmentally friendly way, and in accordance with existing regulations for electronic waste.

Please contact your FLIR Systems representative for more details.

## 2. Introduction

---

Thank you for selecting the FLIR MR55 Moisture Meter with Bluetooth® connectivity. This instrument detects moisture in wood and other building materials. The MR55 also measures Relative Humidity (RH) and ambient Temperature. This device is shipped fully tested and calibrated and, with proper use, will provide years of reliable service.

### 2.1 Key Features

- Resistance-based pin moisture measurements for wood and other building materials including plywood, drywall, oriented strand board (OSB), brick, cement screed, concrete, cement mortar, anhydrite screed, lime mortar, and plaster
- Ambient Temperature and Relative Humidity measurements
- Test material group selectivity
- Bluetooth® data transmission
- Firmware upgrades via micro USB port located in battery compartment
- Work light
- Backlit LCD
- Self-test calibration verification (test points in protective cap)
- Replaceable electrode pins
- Data Hold
- Battery powered (2 x 1.5V 'AA' cells)
- Automatic Power OFF after 20 minutes

## 3. Description

---

### 3.1 Meter Description

1. Temperature and Relative Humidity sensors
2. Measurement electrode pins
3. Display (backlit LCD)
4. Data Hold (short press) / Bluetooth® transmit (long press)
5. Worklight ON/OFF (short press) and backlight ON/OFF (long press)
6. Power button (long press ON/OFF)
7. Material Group number (short press) and °C, °F, RH% selection (long press)
8. Work light
9. Battery/USB port compartment lock
10. Battery/USB port compartment cover

**Note:** Protective cap not pictured

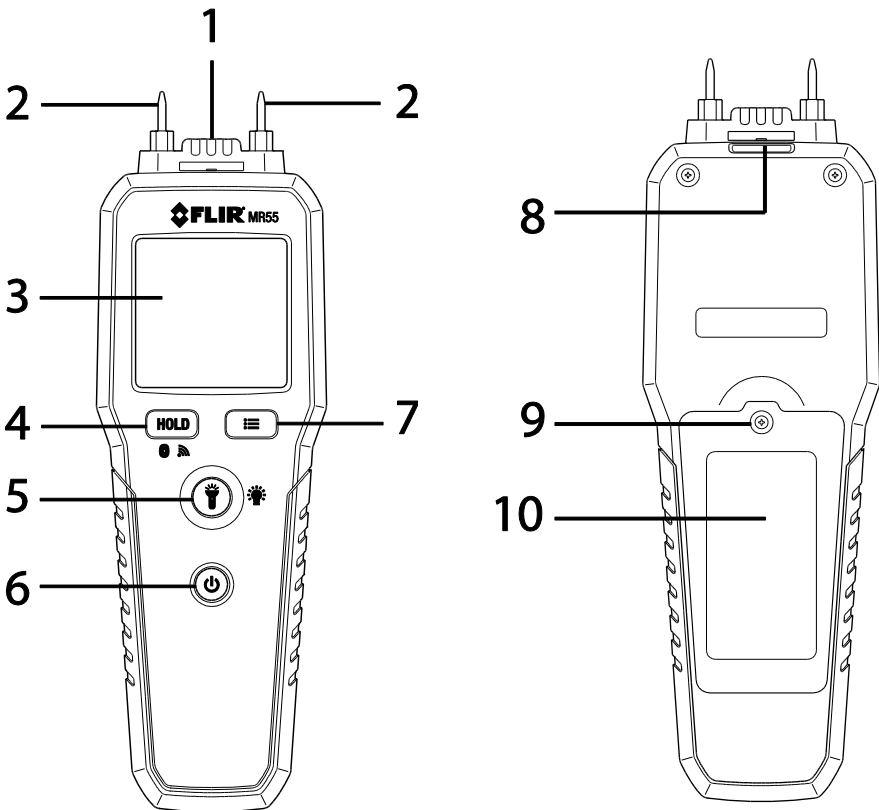



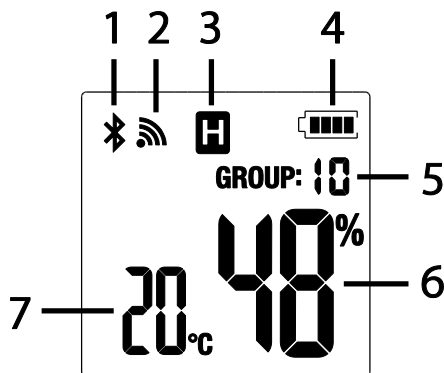

### 3.2 Display Description

1. Bluetooth® (BLE) icon (when paired)
2. Transmission icon (appears for 3 seconds at the start of transmission)
3. Data Hold
4. Battery status
5. Material group number
6. Moisture measurement
7. Ambient temperature (°C, °F) and RH% display area



### 3.3 Button Description

	Long press to power the meter ON/OFF
<b>HOLD</b>	Short press to freeze/unfreeze displayed readings. Readings must first be held before they can be transmitted via Bluetooth®
	Long press to transmit held reading to remotely paired device
	Short press to switch work light ON/OFF
	Long press to switch display backlight ON/OFF
	Short press to select a material group number (1~11) Long press to step through ambient temperature (°C, °F) and relative humidity readings (shown on lower left display digits)

## 4. Operation

---

**CAUTION:** The electrode measurement pins are sharp; Use care when handling. Cover the pins with the protective cap when the instrument is not in use.

### 4.1 Meter Power and APO

1. Two (2) 1.5V 'AA' batteries (rear compartment) power the meter.
2. Long press the power button  to switch the meter ON/OFF. When ON, the meter display will appear as shown in the meter description section above. If the meter display does not switch ON, please check the batteries.
3. The meter's APO feature automatically switches the meter OFF after 20 minutes of inactivity.

### 4.2 Measuring Temperature and Relative Humidity

The ambient temperature and relative humidity sensors are located at the top of the meter (item 1 in the *Meter Description* section).





Moisture measurements are automatically temperature compensated. The meter calculates the compensation using the ambient temperature measurements.

1. The temperature or humidity reading appears on the bottom left of the LCD.
2. Long press the  button to step through °F, °C, and Relative Humidity readings.
3. Remove the protective cap when taking ambient measurements.
4. Replace the cap when finished.

### 4.3 Moisture Measurements

1. Power the meter and select the appropriate material group using the  button (short presses). See the Material Group Reference sections for details.
2. The meter detects moisture through the electrode pins positioned at the top of the meter. Carefully remove the protective cap and push the pins firmly into the material under test. For wood applications, insert the pins perpendicular to the wood's fiber structure.
3. View the readings on the LCD. Take a number of readings in a variety of locations for the best representation of the moisture present.
4. The measurement range for wood is 7 to 99%. The measurement range for other building materials is 1 to 99% (Group 10) and 1 to 35% (Group 11). Readings are automatically temperature compensated.
5. Replace the protective cap after each use.

## 4.4 Bluetooth® Transmission Basics

- When connected with a remote device, the MR55 shows the Bluetooth® icon .
- To transmit a displayed reading to a remotely paired device, first short press the **HOLD** button to freeze the reading.
- Long press the   button to send the data. The transmission symbol  will appear for 3 seconds during transmission. The information transmitted consists of the moisture reading, material group number, and the temperature or humidity reading (depending on which you select to display on the meter). See the dedicated Bluetooth® section for technical details.
- Note that when you switch the meter ON, the Bluetooth® icon will be OFF. It only appears when you connect the MR55 with a remote device. Further, you cannot transmit data unless the display is showing the Bluetooth® icon.

## 4.5 Display Backlight

Long press the backlight button  to switch the LCD backlight ON/OFF. Over use of the backlight will shorten battery life considerably.

## 4.6 Worklight

Short press the work light button  to switch the beam ON/OFF. To conserve battery life use the light only as needed.

## 4.7 Data Hold

Short press the **HOLD** button to freeze/unfreeze the displayed reading. The 'H' icon appears when the data hold mode is active. You must freeze a reading first, before transmitting the reading data via Bluetooth®.

## 4.8 Material Group Selection

Short press the  button to step through the material group numbers (1 ~ 11). See the Material Group Reference section for details.

## 4.9 Temperature (°C, °F) and Relative Humidity Display Selection

Long press the  button to step through °F, °C, and Relative Humidity readings. These readings appear on the lower left LCD area.



## 4.10 Calibration Verification Test

With the meter ON and set to Group 1, touch the measurement pins to the test points labeled 'T' on the protective cap (test points '1' in accompanying diagram). The display will read 18% ( $\pm 2$ ) if the test passes. Next, touch the measurement pins to the test points labeled 'B' on the protective cap (test points '2' in the accompanying diagram). The display will read 26% ( $\pm 2$ ) if the test passes. Please return the MR55 for service if either self-test consistently fails.

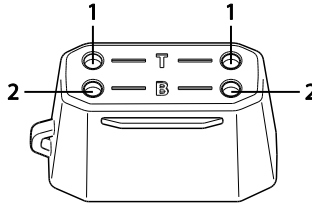

## 5. Bluetooth® Technical Details

---

When connected with a remote device running the **FLIR Tools™** mobile app, the MR55 (using the **METERLiNK®** protocol) can send readings for display on the remote device. When connected to a compatible FLIR camera that supports **BLE** (Bluetooth® Low Energy), the MR55 can send meter readings for display on the camera screen.

Download the **FLIR Tools™** mobile app from the Google Play™ Store, the Apple App store, or from here: <https://www.flir.com/products/flir-tools-app/>

1. When successful communication between the meter and a remote device or FLIR camera is established, the Bluetooth® icon  appears on the meter display.
2. Refer to the **FLIR Tools™** help utility (in the mobile app) for detailed information and tutorials regarding the **FLIR Tools™** application.
3. Refer to Section 4.4 *Bluetooth® Transmission Basics* for using the meter to transmit data via Bluetooth®.

## 6. Field Firmware Upgrades via USB Interface

---

The MR55 includes a micro USB port, located inside the battery compartment. The USB port allows the user to upgrade the System firmware or the Bluetooth® firmware by first downloading an upgrade file from the FLIR website and then connecting the meter to a PC to transfer the file to the meter. Firmware upgrades are available at the <http://support.flir.com> website.

### To update the firmware, you will need:

- Access to the website where the upgrade file(s) are located:  
<http://support.flir.com>
- The MR55 to be updated
- The update file(s). Refer to the steps in the next section

### 6.1 System Firmware Upgrade

1. Visit [support.flir.com](http://support.flir.com) to obtain a firmware upgrade file.
2. Select the 'Downloads' tab and then select 'Instrument Firmware' (Test and Measurement) from the drop down menu.
3. Select MR55 from the second drop down menu.
4. Select and download the firmware upgrade file to the PC.
5. Turn the meter on, and connect it to the PC via the micro USB jack located in the battery compartment. When connected, the meter displays this alert:



6. Copy the firmware upgrade file to the MR55 drive.
7. Disconnect the meter from the USB port.
8. Turn the meter OFF and then back ON again.
9. If the battery power is sufficient, the upgrade will begin and the meter will display the screen shown below:



10. If the battery power is too low, the meter will display the 'LO' message shown below. You must replace the batteries before you can upgrade the meter firmware.

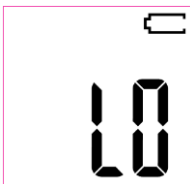

11. When the upgrade is complete, the meter will automatically power ON.

## 6.2 Bluetooth® Firmware Upgrade

To execute a Bluetooth® Firmware Upgrade please perform the same steps as listed in Section 6.1, *System Firmware Upgrade*, above.

If there is an error, the screens shown below will alternately display. If this error occurs, please repeat the upgrade procedure. If the problem persists, contact FLIR technical support.



## **7. Maintenance**

---

### **7.1 Cleaning**

- Wipe the meter housing and pins with a soft, damp cloth. Use a mild detergent if necessary. Do not use solvents or abrasives.
- Always keep the instrument dry.
- Prevent dirt from accumulating at the electrode pins.

### **7.2 Battery Installation and Replacement**

If the instrument does not switch ON or if the battery status icon indicates a low battery voltage, please replace the batteries:

1. Remove the Phillips head screw at the rear of the instrument and remove the battery compartment cover.
2. Install or replace the two (2) x 1.5V 'AA' batteries observing correct polarity.
3. Secure the battery compartment before operating the meter.

### **7.3 Electrode Pin Replacement**

To replace the two electrode pins:

1. Remove the protective cap
2. Unscrew and remove the electrode pins
3. Install the new pins
4. Replace the protective cap

## 8. Safety

---

- The electrode pins are sharp; please use caution when handling the meter. Keep the protective cover in place when not in use.
- Keep the instrument dry.
- Do not strike the meter in an effort to push the pins further into the material under test. Always hold the meter by its side grips when firmly pressing the pins into the tested material.
- Store the batteries separately when the meter is to be stored for periods longer than 60 days.

### 8.1 FCC Compliance

This device complies with part 15 of the FCC Rules. Operation is subject to the following two conditions:

1. This device may not cause harmful interference.
2. This device must accept any interference received, including interference that may cause undesired operation.

This equipment has been tested and found to comply with the limits for a Class B digital device, pursuant to part 15 of the FCC Rules. These limits are designed to provide reasonable protection against harmful interference in a residential installation. This equipment generates, uses, and can radiate radio frequency energy and, if not installed and used in accordance with the instructions, may cause harmful interference to radio communications. However, there is no guarantee that interference will not occur in a particular installation. If this equipment does cause harmful interference to radio or television reception, which can be determined by turning the equipment off and on, the user is encouraged to try to correct the interference by one or more of the following measures:

1. Reorient or relocate the receiving antenna.
2. Increase the separation between the equipment and receiver.
3. Connect the equipment into an outlet on a circuit different from that to which the receiver is connected.
4. Consult the dealer or an experienced radio/TV technician for help.

#### **WARNING**

Changes or modifications not expressly approved by the party responsible for compliance could void the user's authority to operate the equipment.

## 9. Specifications

Measurements	Moisture, relative humidity and ambient temperature
Moisture measurement type	Electrical resistance
Display	Backlit, multifunction LCD
Electrode length	0.4" (10mm)
Electrode pins	Integrated, replaceable
Work light	White LED
Auto Power OFF (APO)	After 20 minutes
Power supply	Two (2) 1.5V 'AA' batteries (rear compartment)
Low battery indicator	 (100% to empty)
Operating Temperature	32 ~ 122°F (0 ~ 50°C)
Operating Humidity	85% Relative Humidity maximum
Housing material	Impact resistant plastic
Drop-proof	6.6 ft. (2m)
IP rating	IP40
Safety Compliance	CE, RCM
Dimensions	7.4 x 2.3 x 1.3" (188 x 58 x 33mm)
Weight	5.6 oz. (160g) battery excluded

### Measurements

Function	Range	Accuracy
Moisture in wood Group 1~9	7 ~ 29%	± 2% MC*
	30 ~ 99%	Reference Only
Moisture in building materials Group 10 and 11	1~99% (Group 10)	Reference Only
	1 ~ 35% (Group 11)	
Ambient Temperature	32 ~ 122°F (0 ~ -50°C)	± 2°F (± 1°C)
Ambient Relative Humidity	0 ~ 10%	± 4%
	10 ~ 85%	± 2%

\* Maximum specified range is dependent on the fiber saturation point for specific species. Beyond this point, the reading can only be used as a relative reference value. For more information on fiber saturation please refer to ASTM D7438. Accuracy specification is based on the analysis in J. Fernández-Golfín et al. Actual real-world accuracy depends on a variety of factors; For more information, refer to ASTM D4444, section 6.

#### Relative Humidity Sensor Note

The meter should be stored in an environment with a relative humidity similar to the area to be tested. If the storage humidity differs by more than 50% RH from the area under test, an acclimation period of up to 24 hours may be required to meet the specified RH accuracy.

## 10. Material Group Reference

### 10.1 Common Names of Timbers (BS888/589:1973) with group nos.

Group 1 ~ 8 for timbers

Group 9 for plywood, drywall, and oriented strand board (OSB)

Group 10 for brick, cement screed, and concrete

Group 11 for cement mortar, anhydrite screed, lime mortar, and plaster

Group 10 and 11 are not specified for accuracy and should be used for reference only

Abura	4	Gurjun	1	Pine, American Long Leaf	3
Afara	1	Hemlock, Western	3	Pine, American Pitch	3
Aformosa	6	Hiba	8	Pine, Bunya	2
Afzelia	4	Hickory	5	Pine, Caribbean Pitch	3
Agba	8	Hyedunani	2	Pine, Corsican	3
Amboyna	6	Iroko	5	Pine, Hoop	3
Ash, American	2	Ironbank	2	Pine, Huon	2
Ash, European	1	Jarrah	3	Pine, Japanese Black	2
Ash, Japanese	1	Jelutong	3	Pine, Kauri	4
Ayan	3	Kapur	1	Pine, Lodgepole	1
Baguacu, Brazilian	5	Karri	1	Pine, Maritime	2
Balsa	1	Kauri, New Zealand	4	Pine, New Zealand White	2
Banga Wanga	1	Kauri, Queensland	8	Pine, Nicaraguan Pitch	3
Basswood	6	Keruing	5	Pine, Parana	2
Beech, European	3	Kuroka	1	Pine, Ponderosa	3
Berlina	2	Larch, European	3	Pine, Radiata	3
Binvang	4	Larch, Japanese	3	Pine, Red	2
Birch, European	8	Larch, Western	5	Pine, Scots	1
Birch, Yellow	1	Lime	4	Pine, Sugar	3
Bisselon	4	Loliondo	3	Pine, Yellow	1
Bitterwood	5	Mahogany, African	8	Poplar, Black	1
Blackbutt	3	Mahogany, West Indian	2	Pterygota, African	1
Bosquiea	1	Makore	2	Pyinkado	4
Boxwood, Maracaibo	1	Mansonia	2	Queensland Kauri	8
Camphorwood, E African	3	Maple, Pacific	1	Queensland Walnut	3
Canarium, African	2	Maple, Queensland	2	Ramin	6
Cedar, Japanese	2	Maple, Rock	1	Redwood, Baltic (European)	1
Cedar, West Indian	8	Maple, Sugar	1	Redwood, Californian	2
Cedar, Western Red	3	Matai	4	Rosewood, Indian	1

Cherry, European	8	Meranti, Red (dark/light)	2	Rubberwood	7
Chestnut	3	Meranti, White	2	Santa Maria	7
Coachwood	6	Merbau	2	Sapele	3
Cordia, American Light	5	Missanda	3	Sen	1
Cypress, E African	1	Muhuhi	8	Seraya, Red	3
Cypress, Japanese (18-28%mc)	3	Muninga	6	Silky Oak, African	3
Cypress, Japanese (8-18%mc)	8	Musine	8	Silky Oak, Australian	3
Dahoma	1	Musizi	8	Spruce, Japanese (18-28%mc)	3
Danta	3	Myrtle, Tasmanian	1	Spruce, Japanese (8-18%mc)	8
Douglas Fir	2	Naingon	3	Spruce, Norway (European)	3
Elm, English	4	Oak, American Red	1	Spruce, Sitka	3
Elm, Japanese Grey Bark	2	Oak, American White	1	Sterculia, Brown	1
Elm, Rock	4	Oak, European	1	Stringybark, Messmate	3
Elm, White	4	Oak, Japanese	1	Stringybark, Yellow	3
Empress Tree	8	Oak, Tasmanian	3	Sycamore	5
Erimado	5	Oak, Turkey	4	Tallowwood	1
Fir, Douglas	2	Obeche	6	Teak	5
Fir, Grand	1	Odoko	4	Totara	4
Fir, Noble	8	Okwen	2	Turpentine	3
Gegu, Nohor	7	Olive, E African	2	Utile	8
Greenheart	3	Olivillo	6	Walnut, African	8
Guarea, Black	8	Opepe	7	Walnut, American	1
Guarea, White	7	Padang	1	Walnut, European	3
Gum, American Red	1	Padauk, African	5	Walnut, New Guinea	2
Gum, Saligna	2	Panga Panga	1	Walnut, Queensland	3
Gum, Southern	2	Persimmon	6	Wandoo	8
Gum, Spotted	1	Pillarwood	5	Wawa	6
				Whitewood	3
				Yew	3



## 10.2 Botanical names of timbers with MR55 group numbers

<i>Abies alba</i>	1	<i>Eucalyptus acmenicides</i>	3	<i>Picea jezoensis</i> (8-18%mc)	8
<i>Abies grandis</i>	1	<i>Eucalyptus crebra</i>	2	<i>Picea sitchensis</i>	3
<i>Abies procera</i>	8	<i>Eucalyptus diversicolor</i>	1	<i>Pinus caribaea</i>	3
<i>Acanthopanax ricinifolius</i>	1	<i>Eucalyptus globulus</i>	2	<i>Pinus contorta</i>	1
<i>Acer macrophyllum</i>	1	<i>Eucalyptus maculate</i>	1	<i>Pinus lampertiana</i>	3
<i>Acer pseudoplatanus</i>	5	<i>Eucalyptus marginata</i>	3	<i>Pinus nigra</i>	3
<i>Acer saccharum</i>	1	<i>Eucalyptus microcorys</i>	1	<i>Pinus palustris</i>	3
<i>Aetoxicon punctatum</i>	6	<i>Eucalyptus obliqua</i>	3	<i>Pinus pinaster</i>	2
<i>Aformosia elata</i>	6	<i>Eucalyptus pilularis</i>	3	<i>Pinus ponderosa</i>	3
<i>Afzelia</i> spp	4	<i>Eucalyptus saligna</i>	2	<i>Pinus radiata</i>	3
<i>Agathis australis</i>	4	<i>Eucalyptus wandoo</i>	8	<i>Pinus</i> spp	2
<i>Agathis palmerstoni</i>	8	<i>Fagus sylvatica</i>	3	<i>Pinus strobus</i>	1
<i>Agathis robusta</i>	8	<i>Flindersia brayleyana</i>	2	<i>Pinus sylvestris</i>	1
<i>Amblygonocarpus andogensis</i>	1	<i>Fraxinus Americana</i>	2	<i>Pinus thunbergii</i>	2
<i>Amblygonocarpus obtusungulis</i>	1	<i>Fraxinus excelsior</i>	1	<i>Pipadeniastrum africanum</i>	1
<i>Araucaria angustifolia</i>	2	<i>Fraxinus japonicus</i>	1	<i>Piptadenia africana</i>	1
<i>Araucaria bidwilli</i>	2	<i>Fraxinus mardshurica</i>	1	<i>Podocarpus dacrydiodes</i>	2
<i>Araucaria cunninghamii</i>	3	<i>Gonystylus macrophyllum</i>	6	<i>Podocarpus spicatus</i>	3
<i>Berlinia grandiflora</i>	2	<i>Gossweilodendron balsamiferum</i>	8	<i>Podocarpus totara</i>	4
<i>Berlinia</i> spp	2	<i>Gossypiospermum proerox</i>	1	<i>Populus</i> spp	1
<i>Betula alba</i>	8	<i>Grevillea robusta</i>	3	<i>Prunus avium</i>	8
<i>Betula alleghaniensis</i>	8	<i>Guarea cedrata</i>	7	<i>Pseudotsuga menzesii</i>	2
<i>Betula pendula</i>	8	<i>Guarea thomsonii</i>	8	<i>Pterocarpus angolensis</i>	6
<i>Betula</i> spp	8	<i>Guibortia ehie</i>	2	<i>Pterocarpus indicus</i>	6
<i>Bosquiera phoberos</i>	1	<i>Hevea brasiliensis</i>	7	<i>Pterocarpus soyauxii</i>	5
<i>Brachylaena hutchinsii</i>	8	<i>Intsia bijuga</i>	2	<i>Pterygota bequaertii</i>	1
<i>Brachystegia</i> spp	2	<i>Juglans nigra</i>	1	<i>Quercus cerris</i>	4
<i>Calophyllum brasiliense</i>	7	<i>Juglans regia</i>	3	<i>Quercus delegatensis</i>	3
<i>Canarium schweinfurthii</i>	2	<i>Khaya ivorensis</i>	8	<i>Quercus gigantean</i>	3
<i>Cardwellia sublimes</i>	3	<i>Khaya senegalensis</i>	4	<i>Quercus robur</i>	1
<i>Carya glabra</i>	5	<i>Larix decidua</i>	3	<i>Quercus</i> spp	1
<i>Cassipourea elliotii</i>	5	<i>Larix kaempferi</i>	3	<i>Ricinodendron heudelotti</i>	5
<i>Cassipourea melanosana</i>	5	<i>Larix leptolepis</i>	3	<i>Sarcocephalus diderrichii</i>	7
<i>Castanea sutiva</i>	3	<i>Larix occidentalis</i>	5	<i>Scottellia coriacea</i>	4

<i>Cedrela odorata</i>	8	<i>Liquidambar styraciflua</i>	1	<i>Sequoia sempervirens</i>	2
<i>Ceratopetalum apetalum</i>	6	<i>Lourea klaineana</i>	8	<i>Shorea</i> spp	2
<i>Chamaecyparis</i> spp (18-28%mc)	3	<i>Lourea trichiloides</i>	8	<i>Sterculia rhinopetala</i>	1
<i>Chamaecyparis</i> spp (8-18%mc)	8	<i>Maesopsis eminii</i>	8	<i>Swietenia candollei</i>	1
<i>Chlorophora excelsa</i>	5	<i>Mansonia altissima</i>	2	<i>Swietenia mahogany</i>	2
<i>Cordia alliodora</i>	5	<i>Millettia stuebelii</i>	1	<i>Syncarpia glomulifera</i>	3
<i>Croton megalocarpus</i>	8	<i>Mimosa heckelii</i>	2	<i>Syncarpia laurifolia</i>	3
<i>Cryptomelia japonica</i>	2	<i>Mitragyna ciliata</i>	4	<i>Tarrietia utilis</i>	3
<i>Cupressus</i> spp	1	<i>Nauclea diderrichii</i>	7	<i>Taxus baccata</i>	3
<i>Dacrydium franklinii</i>	2	<i>Nesogordonia papaverifera</i>	3	<i>Tectona grandis</i>	5
<i>Dalbergia latifolia</i>	1	<i>Nothofagus cunninghamii</i>	1	<i>Terminalia superba</i>	1
<i>Diospyros virginiana</i>	6	<i>Ochroma pyramidalis</i>	1	<i>Thuja plicata</i>	3
<i>Dipterocarpus</i> (Keruing)	5	<i>Ocotea rodiaei</i>	3	<i>Thujopsis dolabrata</i>	8
<i>Dipterocarpus zeylanicus</i>	1	<i>Ocotea usambarensis</i>	3	<i>Tieghamella heckelii</i>	2
<i>Distemonanthus benthamianus</i>	3	<i>Octomeles sumatrana</i>	4	<i>Tilia americana</i>	6
<i>Dracontomelum mangiferum</i>	2	<i>Olea hochstetteri</i>	2	<i>Tilia vulgaris</i>	4
<i>Dryobalanops</i> spp	1	<i>Olea welwitschii</i>	3	<i>Triplohiton scleroxylon</i>	6
<i>Dyera costulata</i>	3	<i>Palaquium</i> spp	1	<i>Tsuga heterophylla</i>	3
<i>Endiandra palmerstoni</i>	3	<i>Paulownia tomentosa</i>	8	<i>Ulmus americana</i>	4
<i>Entandrophragma angolense</i>	7	<i>Pericopsis elata</i>	6	<i>Ulmus procera</i>	4
<i>Entandrophragma cylindricum</i>	3	<i>Picea excelsa</i>	3	<i>Ulmus thomasi</i>	4
<i>Entandrophragma utile</i>	8	<i>Picea abies</i>	3	<i>Xylia dolabriformis</i>	4
<i>Erythrophloeum</i> spp	3	<i>Picea jezoensis</i> (18-28%mc)	3	<i>Zelkova serrata</i>	2

### 10.3 %WME Table (% Wood Moisture Equivalent)

Standard Scale	Wood Species Group							Chipboard
1	2	3	4	5	6	7	8	9
<b>%WME</b>								
7	8	9	8	7	7	11	11	7
8	10	11	9	8	7	12	11	8
9	11	11	10	8	8	12	12	9
10	12	12	10	9	9	13	12	9
11	13	13	11	10	10	13	13	11
12	14	14	12	11	11	14	14	12
13	15	15	13	11	11	15	15	13
14	15	16	13	12	12	15	16	14
15	16	17	14	13	13	16	17	14
16	17	18	15	13	13	16	18	15
17	18	19	16	14	14	17	19	15
18	18	20	16	15	15	17	19	16
19	19	21	17	16	15	18	20	17
20	20	23	18	17	16	18	21	17
21	21	24	19	18	17	19	22	18
22	22	25	19	18	17	20	23	19
23	23	26	20	20	19	21	25	20
24	24	27	21	20	19	22	26	21
25	24	28	21	21	19	23	26	23
26	25	29	22	22	20	24	27	26
27	27	29	23	23	21	25	28	27
28	28	29	24	25	22	26	28	28
29	29	30	26	26	23	27	29	29

## ***11. Technical Support***

---

Main Website	<a href="http://www.flir.com/test">http://www.flir.com/test</a>
Technical Support Website	<a href="http://support.flir.com">http://support.flir.com</a>
Technical support Email	TMSupport@flir.com
Service/Repair Support Email	Repair@flir.com
Support Telephone number	+1 855-499-3662 option 3 (toll-free)

## 12. Three-Year Limited Warranty

---

Congratulations! You (the "Purchaser") are now the owner of a world-class FLIR Test and Measurement product. A qualifying FLIR Test and Measurement product (the "Product") purchased either directly from FLIR Commercial Systems Inc. and affiliates (FLIR) or from an authorized FLIR distributor that Purchaser registers on-line with FLIR is eligible for coverage under FLIR's 3-Year Limited Warranty subject to the terms and conditions in this document. This warranty only applies to purchases of Qualifying Products (see below) purchased after April 2013 and only to the original Purchaser of the Product.

PLEASE READ THIS DOCUMENT CAREFULLY; IT CONTAINS IMPORTANT INFORMATION ABOUT THE PRODUCTS THAT QUALIFY FOR COVERAGE UNDER THE 3-YEAR LIMITED WARRANTY, PURCHASER'S OBLIGATIONS, HOW TO ACTIVATE THE WARRANTY, WARRANTY COVERAGE, AND OTHER IMPORTANT TERMS, CONDITIONS, EXCLUSIONS AND DISCLAIMERS.

**1. PRODUCT REGISTRATION.** To qualify for FLIR's 3-Year Limited Warranty, the Purchaser must fully register the Product directly with FLIR on-line at [www.flir.com](http://www.flir.com) WITHIN Sixty (60) DAYS of the date the Product was purchased by the first retail customer (the "Purchase Date"). PRODUCTS THAT ARE NOT REGISTERED ON-LINE WITHIN Sixty (60) DAYS OF THE PURCHASE DATE OR PRODUCTS WHICH DO NOT QUALIFY FOR THE 3-YEAR WARRANTY WILL HAVE A LIMITED ONE YEAR WARRANTY FROM THE DATE OF PURCHASE.

**2. QUALIFYING PRODUCTS.** Upon registration, a list of Test and Measurement Products that qualify for coverage under FLIR's 3-Year Limited Warranty can be found at [www.flir.com/testwarranty](http://www.flir.com/testwarranty)

**3. THE WARRANTY PERIOD.** The Product is warranted for a period of three (3) Years from the Purchase Date (the "Warranty Period"). Any Product that is repaired or replaced under warranty is covered under this 3-Year Limited Warranty for one hundred eighty days (180) days from the date of return shipment by FLIR or for the remaining duration of the applicable Warranty Period, whichever is longer.

**4. LIMITED WARRANTY.** In accordance with the terms and conditions of this 3-Year Limited Warranty, and except as excluded or disclaimed in this document, FLIR warrants, from the Purchase Date, that all fully registered Products will conform to FLIR's published Product specifications and be free from defects in materials and workmanship during the applicable Warranty Period. PURCHASER'S SOLE AND EXCLUSIVE REMEDY UNDER THIS WARRANTY, AT FLIR'S SOLE DISCRETION, IS THE REPAIR OR REPLACEMENT OF DEFECTIVE PRODUCTS IN A MANNER, AND BY A SERVICE CENTER, AUTHORIZED BY FLIR. IF THIS REMEDY IS ADJUDICATED TO BE INSUFFICIENT, FLIR SHALL REFUND PURCHASER'S PAID PURCHASE PRICE AND HAVE NO OTHER OBLIGATION OR LIABILITY TO BUYER WHATSOEVER.

**5. WARRANTY EXCLUSIONS AND DISCLAIMERS.** FLIR MAKES NO OTHER WARRANTY OF ANY KIND WITH RESPECT TO THE PRODUCTS. ALL OTHER WARRANTIES, EXPRESS OR IMPLIED, INCLUDING BUT NOT LIMITED TO IMPLIED WARRANTIES OF MERCHANTABILITY, FITNESS FOR A PARTICULAR PURPOSE (EVEN IF PURCHASER HAS NOTIFIED FLIR OF ITS INTENDED USE FOR THE PRODUCTS), AND NON-INFRINGEMENT ARE EXPRESSLY EXCLUDED FROM THIS AGREEMENT.

THIS WARRANTY EXPRESSLY EXCLUDES ROUTINE PRODUCT MAINTENANCE, AND SOFTWARE UPDATES, AND REPLACEMENT OF FUSES OR DISPOSABLE BATTERIES. FLIR FURTHER EXPRESSLY DISCLAIMS ANY WARRANTY COVERAGE WHERE THE ALLEGED NONCONFORMITY IS DUE TO NORMAL WEAR AND TEAR, ALTERATION, MODIFICATION, REPAIR, ATTEMPTED REPAIR, IMPROPER USE, IMPROPER MAINTENANCE, NEGLIGENCE, ABUSE, IMPROPER STORAGE, FAILURE TO FOLLOW ANY PRODUCT INSTRUCTIONS, DAMAGE (WHETHER CAUSED BY ACCIDENT OR OTHERWISE), OR ANY OTHER IMPROPER CARE OR HANDING OF THE PRODUCTS CAUSED BY ANYONE OTHER THAN FLIR OR FLIR'S EXPRESSLY AUTHORIZED DESIGNEE.

THIS DOCUMENT CONTAINS THE ENTIRE WARRANTY AGREEMENT BETWEEN PURCHASER AND FLIR AND SUPERSEDES ALL PRIOR WARRANTY NEGOTIATIONS, AGREEMENTS, PROMISES AND UNDERSTANDINGS BETWEEN PURCHASER AND FLIR. THIS WARRANTY MAY NOT BE ALTERED WITHOUT THE EXPRESS WRITTEN CONSENT OF FLIR.

**6. WARRANTY RETURN, REPAIR AND REPLACEMENT.** To be eligible for warranty repair or replacement, Purchaser must notify FLIR within thirty (30) days of discovering of any apparent defect in materials or workmanship. Before Purchaser may return a Product for warranty service or repair, Purchaser must first obtain a returned material authorization (RMA) number from FLIR. To obtain the RMA number Owner must provide an original proof of purchase. For additional information, to notify FLIR of an apparent defect in materials or workmanship, or to request an RMA number, visit [www.flir.com](http://www.flir.com). Purchaser is solely responsible for complying with all RMA instructions provided by FLIR including but not limited to adequately packaging the Product for shipment to FLIR and for all packaging and shipping costs. FLIR will pay for returning to Purchaser any Product that FLIR repairs or replaces under warranty.

FLIR reserves the right to determine, in its sole discretion, whether a returned Product is covered under warranty. If FLIR determines that any returned Product is not covered under warranty or is otherwise excluded from warranty coverage, FLIR may charge Purchaser a reasonable handling fee and return the Product to Purchaser, at Purchaser's expense, or offer Purchaser the option of handling the Product as a non-warranty return. FLIR shall not be responsible for any data, images or other information that may be stored on the returned Product which was not included in the Product at the time of purchase. It is Purchaser's responsibility to save any and all data prior to returning the Product for warranty service.

**7. NON-WARRANTY RETURN.** Purchaser may request that FLIR evaluate and service or repair a Product not covered under warranty, which FLIR may agree to do in its sole discretion. Before Purchaser returns a Product for non-warranty evaluation and repair, Purchaser must contact FLIR by visiting [www.flir.com](http://www.flir.com) to request an evaluation and obtain an RMA. Purchaser is solely responsible for complying with all RMA instructions provided by FLIR including but not limited to adequately packaging the Product for shipment to FLIR and for all packaging and shipping costs. Upon receipt of an authorized non-warranty return, FLIR will evaluate the Product and contact Purchaser regarding the feasibility of and the costs and fees associated with Purchaser's request. Purchaser shall be responsible for the reasonable cost of FLIR's evaluation, for the cost of any repairs or services authorized by Purchaser, and for the cost of repackaging and returning the Product to Purchaser. Any non-warranty repair of a Product is warranted for one hundred eighty days (180) days from the date of return shipment by FLIR to be free from defects in materials and workmanship only, subject to all of the limitations, exclusions and disclaimers in this document.



---

Corporate Headquarters  
FLIR Systems, Inc.  
2770 SW Parkway Avenue  
Wilsonville, OR 97070  
USA  
Telephone: +1 503-498-3547

Customer Support  
Technical Support Website  
Technical Support Email  
Service and Repair Email  
Customer Support Telephone

<http://support.flir.com>  
[TMSupport@flir.com](mailto:TMSupport@flir.com)  
[Repair@flir.com](mailto:Repair@flir.com)  
+1 855-499-3662 option 3 (toll free)

Publication Identification No.: MR55-en-US  
Release Version: AA  
Release Date: July 2018  
Language: en-US