

**5 kV & 10 kV Insulation
Resistance Testers**

Megger[®]

USER MANUAL



SAFETY WARNINGS

Safety warnings must be observed during use:

- The circuit under test **must** be switched off, de-energised, isolated and checked to be safe before insulation test connections are made. Make sure the circuit is not reenergised whilst the instrument is connected.
- Only Megger supplied test leads **must** be used.
- Circuit terminals **must not** be touched during an insulation test or before suitable grounding of the unit under test is in place in line with safe working practices.
- After completing a test, capacitive circuits **must** be completely discharged before disconnecting the test leads. Capacitive charges can be lethal.
- Tested items **must** be firmly shorted out with a shorting link, after discharge, until required for use. This is to guard against any stored dielectric absorption charge subsequently being released thereby raising the voltage to potentially dangerous levels.
- The voltage indicator and automatic discharge features **must** be regarded as additional safety features and not a substitute for normal safe working practice.
- It is rare, but in certain circumstances, breakdown of the circuit under test may cause the instrument to terminate the test in an uncontrolled manner, possibly causing a loss of display while the circuit remains energised. In this event, the unit must be turned off and the circuit discharged manually.
- Test leads, including crocodile clips, **must** be in good order, clean and with no broken or cracked insulation.
- The instrument **must** not be used if any part of it is damaged.
- Insulation testing in wet weather conditions might be hazardous. It is recommended that this instrument is not used in these circumstances. If this is unavoidable, the user **must** take all necessary precautions.
- This instrument is not intrinsically safe and **must** not be used in hazardous atmospheres.

- If this equipment is used in a manner not specified by the manufacturer, the protection provided by the equipment may be impaired.

BATTERY WARNINGS

- Do not disassemble or modify the battery. The battery contains safety and protection devices which, if damaged, may cause the battery to generate heat, rupture or ignite.
- Never heat the battery in a fire or otherwise.
- Do not pierce or damage the battery in any way
- Do not subject the battery to strong impacts/shocks.
- Do not expose the battery to water, salt water or allow the battery to get wet.
- Never short circuit, reverse polarity or disassemble the battery pack.
- In the event of a battery cell leaking, do not allow the liquid to come into contact with the skin or eyes. If contact has been made, wash the affected area with copious amounts of water and seek medical advice.
- Keep cells and batteries out of reach of children
- Seek medical advice if a cell or battery has been swallowed.
- Do not leave a battery on prolonged charge when not in use.
- Retain the original product literature for future reference.

NOTE

THE INSTRUMENT MUST ONLY BE OPERATED BY SUITABLY TRAINED AND COMPETENT PERSONS

Users of this equipment and/or their employers are reminded that National Health and Safety Legislation requires them to carry out valid risk assessments of all electrical work so as to identify potential sources of electrical danger and risk of electrical injury such as inadvertent short circuits.

Symbols used on the instrument



Caution: refer to user manual



Caution: risk of electric shock



Equipment protected throughout by Double Insulation.



Line Power / mains



Equipment complies with current EU directives.

N13117



Equipment complies with current “C tick” requirements.



Do not dispose of in the normal waste stream.



Earth



Universal Serial Bus (USB)

CAT IV 600 V

Overvoltage category IV (equipment installed at or near the origin of the electrical supply to a building)

600 V refers to the rms phase-to-earth voltage that this instrument can withstand to the overvoltage category IV rating.

Table of contents and index

General description.....	5	Care of the instrument.....	21
Features.....	5	Leads.....	21
Instrument Controls and Indicators.....	6	Battery Care.....	21
Preparations for Use.....	7	Replacing the battery.....	21
Initial instructions.....	7	Technical Specification.....	23
Power lead and battery charging.....	7	Electrical specification.....	23
Functional verification.....	7	Environmental Conditions.....	24
Calibration.....	7	GENERAL SPECIFICATION.....	24
Storage.....	7	Repair and Warranty.....	24
Operating instructions.....	8	Calibration, Service and Spare Parts.....	25
General operation.....	8	Returning product to Megger UK & USA service centres... 25	
Breakdown vs. burn mode.....	9	Approved Service Centres.....	26
Voltmeter.....	9	Accessories, Equipment and Spares.....	28
Initial setup.....	10		
Lock Voltage.....	10		
Alarm setting.....	10		
Recording temperature.....	10		
Breakdown mode / burn mode.....	11		
Running an insulation test.....	11		
Memory functions and downloading.....	12		
Real-time output during insulation tests.....	12		
Battery indicator.....	13		
On screen error reporting.....	13		
Measurement Modes.....	14		
‘Spot’ IR test.....	14		
Timed IR test.....	14		
DAR and PI Insulation Tests.....	14		
Dielectric Discharge test.....	15		
Step Voltage Test.....	16		
Ramp voltage test.....	17		
Measurement Techniques.....	18		
Understanding Measurement Currents.....	18		
Insulation measurements above 100 GΩ.....	18		
Terminals.....	19		
GUARD terminal, screened leads.....	19		
Preventative measurement.....	21		
Cleaning.....	21		

General description

The new range of Insulation Resistance Testers (IRT) are smaller and lighter than previous models, yet offer advanced features, improved battery life and rapid charge capability. The range consists of three models; an entry level 5 kV and two fully featured units, one 5 kV the other 10 kV. Resistance measurement capability is up to 10 TΩ for the 5 kV models and 20 TΩ for the 10 kV model.

A key productivity feature is the ability to operate with a discharged battery when line/mains power is connected. An intelligent battery charger ensures the optimum charge rate as a function of battery level, resulting in extended battery life and minimum charge times.

The tough case provides ultimate protection for a portable instrument and a clip-on lead pouch ensures that supplied leads remain with the instrument at all times. The case lid is removable for improved lead access. IP rating is IP65 with case closed ensuring no moisture ingress. High reliability is built-in and all models are safety rated to CATIV 600 V.

Five preset voltage ranges are provided in insulation test mode, plus a user settable lock voltage range which is useful for repetitive measurements at specific test voltages. All test voltages can be adjusted before and during the test using up/down buttons. Preconfigured diagnostic tests like Polarisation Index (PI), Dielectric Absorption Ratio (DAR), Stepped Voltage (SV) and a ramp test are available along with basic and timed insulation resistance tests.

Simplicity of operation is achieved with two rotary switches whereby test voltage range and test mode are self evident. The large backlight display enables multiple results to be displayed, for example, the step voltage test shows five step voltage resistance results simultaneously.

Advanced memory storage includes time/date stamping of results, logging of data and recall of results to screen. A fully isolated USB device interface is used for safe transfer of test records to all versions of Megger's data management

software, PowerDB, or to popular third party spreadsheet packages.

The MIT515, MIT525 and MIT1025 can be powered from the mains supply or by its rechargeable battery, which provides for 4½ to 6 hours of continuous testing with a 100 MΩ load, depending on model. A battery level indicator on the LCD display indicates battery capacity. Connecting power to line/mains supply will automatically charge the battery whether the instrument is switched on or off, except during testing.

Features

- 10 TΩ max. resistance, 20 TΩ for MIT1025
- MIT515 with IR, IR(t), PI and DAR
- MIT525, MIT1025 diagnostic and over voltage tests - PI, DAR, DD, SV and ramp test.
- Operate and charge on line power/mains (except during actual test)
- Light weight Li ion battery
- CATIV 600 V safety rating
- Advanced memory with time/date stamp
- DC and AC voltmeter (30 V to 660 V)
- Large LCD display with backlight
- Download of saved results and logs via 10 kV isolated USB cable (MIT525, MIT1025 only)
- PowerDB Lite software included with MIT525 and MIT1025



Instrument Controls and Indicators



1. Positive (+) terminal
2. GUARD terminal
3. Negative (-) terminal
4. USB device interface
5. Four arrow buttons and OK button
6. TEST button with associated HV warning lamp
7. Backlight button
8. Central rotary switch
9. Save button on MIT525 and MIT1025
10. Test mode rotary switch
11. LED indicating line power / mains
12. Display
13. Power socket



	User lock voltage		Delete records
	Timer		Download via USB
	Save		Filter
	Open records		Alarm
	Battery		Breakdown mode
	Ramp test		Burn mode
	Danger HV		Refer to manual
	Fuse		Noise detected

Preparations for Use

Initial instructions

- Remove instrument, power lead and pouch from the packing box.
- Clip the test lead pouch to the lid.
- Open the lid and familiarise yourself with the layout and position of the IEC 60320 power inlet on the left side of the panel. An isolated USB socket is found on the right side of the instrument.
- Unpack leads and pack them into the lead pouch.
- Read the product manual, **especially the warnings**.
- A quick reference is provided in the instrument lid.
- Keep the original packaging for re-use.

Power lead and battery charging

- If the power lead supplied is not suitable for your line/mains connection, do not use an adaptor. Always use a power lead fitted with the correct plug. The ground connection is not used as the instrument is double insulated.
- If using a fused plug, ensure that it is fitted with a 3 A fuse.
- Supply voltage: 90 to 265 V rms ac at 50/60 Hz.
- A green LED illuminates when line power/mains is present.
- The battery will charge as long as the mains supply is connected, except when a test is in progress.
- For optimum battery life, charge the battery after each use. Full charge duration is up to 2½ hours but a first charge time of 3 hours is advised.

- The battery must be charged between 0 °C and 40 °C ambient temperature. If the battery detects a temperature outside this range the battery symbol will flash.

Power lead connection table

Connection	UK/International	USA
Earth/Ground	Yellow/Green	Green
Neutral	Blue	White
Live (Line)	Brown	Black

Functional verification

Simply turning on the instrument will initiate a start-up process and the display will respond. If an error is detected 'Err' will be displayed with an associated error number.

Calibration

The MIT515, MIT525 and MIT1025 are supplied with a calibration certificate which is automatically generated as part of Megger's final test procedure.

UKAS accredited calibration certificates are available from Megger but this service is chargeable.

Storage

Instruments should be stored in storerooms which meet the storage temperature and humidity specifications listed in this document. If charging is incorporated in the storeroom the room must be well ventilated.

Operating Instructions

General operation

The MIT515, MIT525, MIT1025 Insulation resistance testers (IRTs) are primarily controlled by two rotary switches and a TEST button used to start and stop a test (see section entitled, 'Instrument Control and Indicators'). The central rotary switch includes an 'OFF' position; the instrument switches on by rotating the switch either clockwise or anticlockwise from this position. A range of test voltages for insulation resistance tests up to 5 kV for MIT515/MIT525 and 10 kV for MIT1025 are available, including a user selectable voltage range which can be set between 100 V and 5000 V or 10000 V depending on model. The 'lockable' test voltage range can be adjusted in the settings function.

The settings function is indicated by a spanner symbol and facilitates lock voltage, low resistance alarm, temperature, time/date adjustment. A light blue coloured section of the rotary switch denotes memory functions; open records, download via USB and delete records. A dedicated save button is provided on the MIT525 and MIT1025 models and all models have a backlight button.

A second rotary switch controls the insulation test mode providing for the following tests:

- All models have basic insulation resistance IR, timed insulation resistance IR(t), Dielectric Absorption Ratio (DAR) and Polarisation Index (PI) tests.
- MIT525 / MIT1025 have additional tests; Dielectric Discharge (DD), Step Voltage (SV) and ramp test.

A cluster of directional buttons and an OK button are used in settings and memory functions. The up/down arrows also enable the test voltage to be adjusted during a test. Prior to the start of an IR or IR(t) test, holding down the left arrow button with a voltage level selected on the central rotary switch will activate burn mode. Burn mode is deactivated if the

voltage range or mode is changed or by pressing the right arrow/breakdown button.

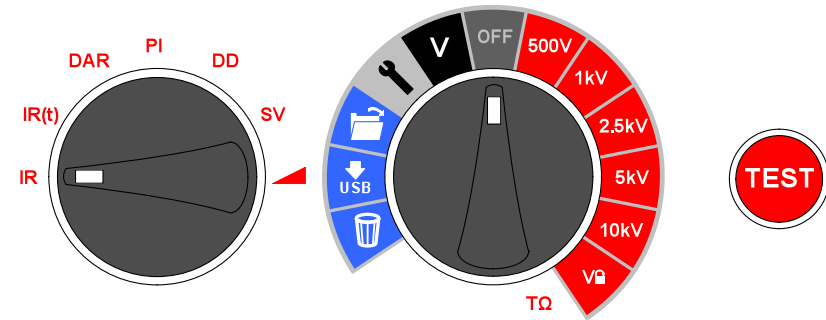

Instrument controls are simple to operate. The central rotary switch incorporates the OFF position. The left hand rotary switch selects insulation test type (test mode switch). The TEST button starts and stops a test.

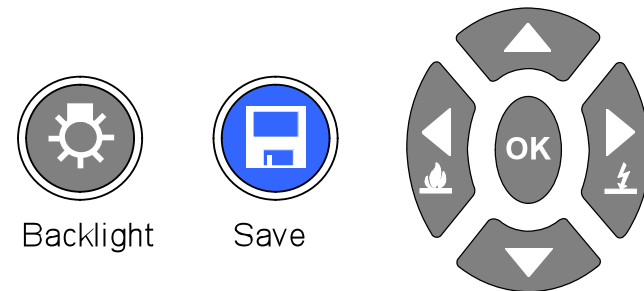

Four arrow buttons and OK facilitate adjustment and selection of settings, voltages and modes. Breakdown/burn modes are set using the left and right arrow buttons. Backlight and save functions are dedicated buttons. All models have backlight and the MIT525 and MIT1025 have the Save button.

Breakdown vs. burn mode

In breakdown mode insulation tests are automatically stopped when a fault causes the applied voltage to drop rapidly. Burn mode IR tests ignore breakdown and continue to test the insulation and are therefore destructive tests. Burn mode is used to purposely create a carbon track in insulation to facilitate fault location. Burn mode only operates at test voltages of 500 V and above.

Voltmeter

A voltmeter is incorporated in the instrument and measures AC and DC voltage from 30 V to 660 V. Frequency (Hz) is measured and displayed for AC voltages.

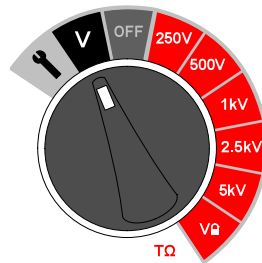

The voltmeter can be used to confirm that the insulation is discharged and for general purpose use. Positive and negative terminals are used for the voltmeter function; do **not** connect the GUARD terminal in **voltmeter mode**.

Before starting a test, the voltmeter detects any voltage between the positive and negative terminals and will display the voltage. If the voltage is above 50 V at the start of an insulation test, a voltage is displayed on the analogue and digital readouts to alert the user. The voltage displayed is developed by current flowing through the internal discharge resistance of the instrument. If the source impedance is high the current will remain constant regardless of the value of the internal discharge resistance.

In high electrical noise environments a lockout activates when induced currents exceed the capability of the instrument to remain within specified accuracies. The voltmeter reports the voltage across the internal discharge resistor.

Voltage during discharge of a reactive load will be displayed in addition to warning symbols. Non-reactive loads will discharge too rapidly to show the voltage drop.

In the unlikely event of a fault during a test or during the discharge process, the user is advised to check for flashing high voltage warning symbols and the red LED on the instrument panel will flash. If the warning symbols and LED do not flash, turn off the instrument before disconnection.

Reset Default Settings

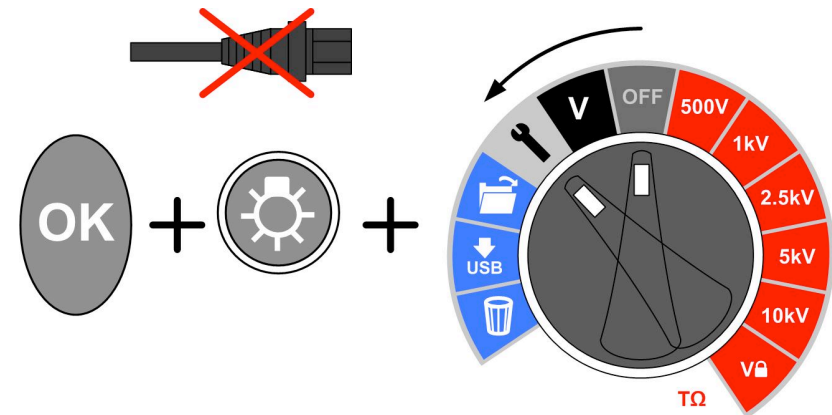

Remove AC source, press OK, backlight buttons and switch main rotary switch from OFF to setting icon.

Instrument Control

Initial setup

It is important to setup the Real Time Clock (RTC) on models MIT525 and MIT1025 to ensure that records saved in the instrument are time/date stamped correctly. The MIT515 does not require time/date setting. The RTC has a separate battery to maintain settings even when the primary battery is removed.

To set the clock and date, select the settings function on the central rotary switch and turn the mode rotary switch to IR. Navigate using the left/right arrows to where the time and date is displayed.

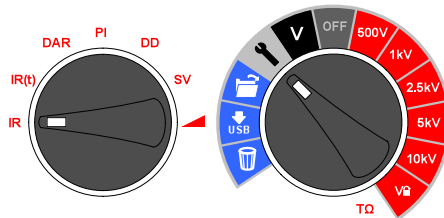

Set the time using the up and down arrows. Change the hours and minutes then press OK to save.



Select the day/month format required, i.e. d:m for day:month or m:d for month:day and press the right arrow button, then set the date and press OK to save. A tick on the left of the display indicates that a setting is saved, a cross is displayed during adjustment indicates that it is not set. Exit settings by changing the central rotary switch to a different position.



Lock Voltage

The user selectable 'lock' voltage range is set by adjusting the displayed voltage using the up and down arrow buttons. When the desired voltage is displayed, it is saved, by pressing the

OK button. The setting does not change even if the instrument is switched off.

Alarm setting

A low resistance alarm sounds when the resistance level of an insulator reaches the alarm, assuming alarm has been activated. The default alarm setting is 500 kΩ and *inactive* (X is displayed on the right of the display). Set central and mode rotary switches to the settings and IR positions respectively. Press the right arrow button once. The low resistance alarm can be set at the default value by simply pressing the OK button, or changed to a different alarm resistance level using the up/down arrow buttons and save it by pressing OK.

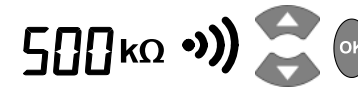

Recording temperature

The MIT525 and MIT1025 are able to record insulation temperature measured by an *independent* thermometer. If you do not wish to record temperature do not change the default setting or reset it if it was previously set.

Move the central rotary switch to point to settings and press the right/left arrow buttons until 't° ---' is displayed. The default setting is no temperature record. This can be changed by pressing up or down arrows to select either °F or °C temperature entry. Pressing OK will confirm the setting and result in a prompt for temperature to be entered whenever the save button is pressed after completing any test. Up and down arrows facilitate temperature entry in 1 °C increments / decrements.

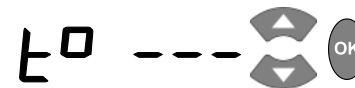

Breakdown mode / burn mode

The insulation resistance 'IR' test operates in either 'Breakdown' or 'Burn' mode.

Default mode is *breakdown*.

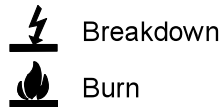

Left and right arrow buttons toggle between burn and breakdown mode when a voltage range is selected. Press and hold left arrow/burn to activate burn mode.

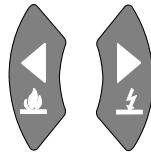

In breakdown mode the test will automatically terminate on detection of a breakdown to prevent damage to the insulation.

Burn mode disables the normal breakdown detection and test voltage continues after breakdown of the insulation. This enables the location of the failure to be seen and detected acoustically but it is a destructive test.

Due to the potential damage that could occur, the unit produces two long beeps when starting a test with burn mode activated.

Running an insulation test

Before testing any reactive load the insulation must be fully discharged.

The required resistance test is selected on the mode rotary switch at the bottom left of the instrument keypad. The test voltage is selected using the preconfigured voltage ranges on the central rotary switch or the V user settable/lockable voltage range.

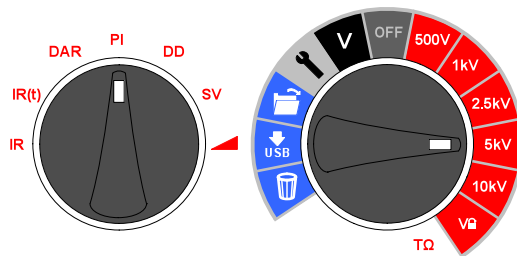

It is possible to adjust the test voltage using the up and down arrow buttons, either before or during a test. Once a test has begun, it is advisable to only adjust the voltage in the first 10s of the test to prevent interference with the capacitive and absorptive currents in the insulator.

A test is started by pressing and holding down the TEST button for approximately 3 seconds. A timer will be displayed to indicate elapsed time during the test. The test is stopped, by pressing the TEST button. As soon as the test is stopped a discharge of the insulator is automatically initiated. An 'StP' indication informs the user that the test is terminating and after a few seconds the voltage on the terminals will be displayed. Left and right arrows can be used to scroll between terminal voltage, last test voltage and the set range voltage. In the event of a terminal voltage of ≥ 50 V a voltage and warning will be displayed.



Do not disconnect instrument leads or clamps until the LED and display warnings are switched off indicating that the unit under test is discharged! Significant current can be stored in reactive loads which act as capacitors or inductors, which can be lethal.

The display shows the final resistance result, capacitance, test current and Time Constant (TC) in addition to test duration.

On MIT525 and MIT1025 models the result can be saved by pressing the dedicated save () button after a resistance or voltage test is complete. The save button will appear momentarily to confirm the data is saved. If a full test curve is required the user must select logging by pressing the save button *before* starting the test. Data will be logged every 5 seconds for the duration of a resistance test. It is not possible to log voltages in voltmeter mode.

If temperature entry has been activated a prompt will appear for the user to enter a temperature reading after IR and IR(t)

insulation tests. DAR, PI, SV, ramp and DD tests will not prompt for temperature input.

Display backlight is activated by pressing the (☼) button. The backlight button can be pressed a second time to deactivate the backlight. Automatic deactivation will occur after a preset timeout period if not deactivated manually.

Memory functions and downloading

Models MIT525 and MIT1025 have advanced storage, recall and download functions to facilitate documentation of insulation tests.

Recall results

Setting the central rotary switch to 'open folder' position enables the user to recall saved results beginning with the most recent result. Up and down arrow buttons enable the user to scroll through results based on a sequential four digit index. Left and right arrow buttons scroll through a single result showing all saved test data including time/date. Where logging has been enabled, only the final result is displayed on screen. The full result can be viewed by downloading to PowerDB/PowerDB Lite.

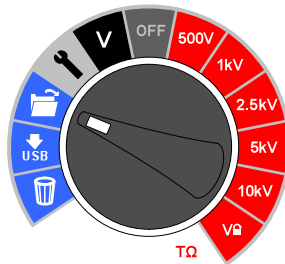

In saved results, the test mode is identified by the icon or abbreviation of each test on the display. In addition, the open folder icon is displayed to indicate recall memory mode.

Download results

PowerDB Pro, Advanced and Lite are Megger's asset and data management software packages with integrated forms for MIT525 and MIT1025 instruments.

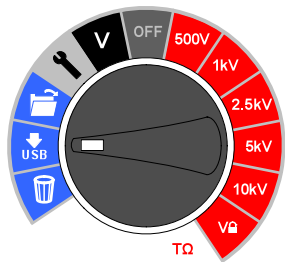

The default download on the instrument is a single test log or

summary result. To download all results press an arrow button.

Detailed instructions on how to interface with PowerDB are available on the product CD on a document entitled 'Interfacing MIT525, MIT1025 to PowerDB'.

PowerDB offers instructions specific to MIT525 and MIT1025 regarding the download procedure. When results are downloaded the IRT can be disconnected from the PC after the application releases the port.

Deleting results

There are two delete functions; delete a single result and delete all results. Select the bin icon on the central rotary switch. The first record indicated contains the result of the last test performed. Up/down arrows navigate through records and the OK button is used to select delete where the 'X' changes to a tick and the on screen bin icon flashes. A subsequent press of the OK button activates the deletion.

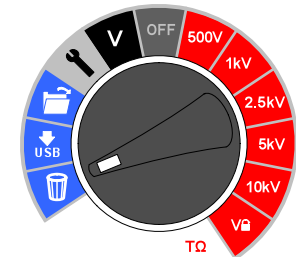

The default delete is a single test result, press the right arrow button to select delete all test results from memory.

Real-time output during insulation tests

PowerDB or PowerDB Lite can be used to record real time data output from the MIT525 and MIT1025 models. Voltage, current and resistance data is sent at a rate 1 Hz from the IRT and displayed in real time on a graph, e.g. a plot of current (μA) versus voltage (kV) for the ramp test.

Before running a test where a real time output is required, attach a PC running PowerDB Pro, PowerDB Advanced or PowerDB Lite via a USB cable. Check the product CD provided with the instrument for a folder named, "Megger USB." If this folder exists, use it when starting PowerDB for the

first time to find the driver, if not allow the operating system to search the internet for the driver. Check the serial port allocation on Device Manager, and enter the serial port number allocated when starting PowerDB. PowerDB offers instructions specific to MIT525 and MIT1025 regarding the real time capture procedure.

Start the application and activate real time data capture in the form of choice. As soon as the test is started real time data output will begin. When the test is complete ensure that the form is saved in PowerDB Pro/Advanced/Lite.

Battery indicator

The battery symbol on the LCD display contains four pairs of segments. The battery is monitored continuously when the instrument is turned on. The charge remaining in the battery, is indicated by segment pairs as follows:

Fully charged battery



50% charged battery



Tests cannot be started, and the battery may fail at any time

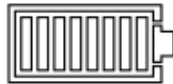

Symbol flashes when there is not enough charge for a test and the instrument will turn itself off.

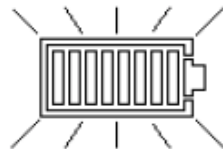

When mains power is present the indicator shows the battery is being charged by animating the segments of the bar graph.

A blinking full battery icon indicates that the battery is prevented from charging due to the temperature being out of

the allowable charge temperature range, 0 °C to 40 °C, or that the battery has failed.

On screen error reporting

Should an error be detected during the operation of the MIT515, MIT525 or MIT1025, an error code is reported preceded by 'Err' with the read handbook warning.

Error codes are given in the following table.

'Err' code	Fault
2	Output voltage over limit
3	FIFO (memory) overflow
4	HV board mismatch with control board setup
5	Battery low error
6	Control board detected inter-board communication failure
7	Test button stuck
8	Measurement board i2c failed
9	Measurement board detected inter-board communication failure
10	Isolation power supply cut-out

If an error occurs do not attempt to repair the instrument. Obtain a repair number from Megger Instruments Limited, carefully pack in a suitable box and send the faulty instrument to the nearest Megger Approved Service Centre, if possible noting the error that was reported.

Measurement Modes

'Spot' IR test

The spot insulation resistance test (IR) is selected on the test mode rotary switch. Select the IR setting and then the required test voltage using the preconfigured voltage ranges on the central rotary switch or the V_{lock} user settable/lockable voltage range. All preconfigured voltage ranges, but not V_{lock} , are adjustable using up and down arrow buttons before and during the test, but the latter should be limited to the first 10 seconds of IR and IR(t) tests. Press and hold TEST to start the test.

To set the user defined lock voltage V_{lock} , turn the central rotary switch to settings and the mode switch to IR. The preset voltage 5000 V will flash and can be changed using the up/down buttons. When the required maximum voltage is displayed, press the OK button to save the setting. This setting will remain until it is reset.

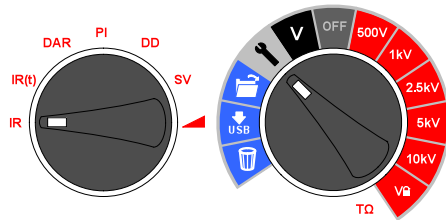

Whenever V_{lock} is selected the set voltage is shown on the display. The voltage lock is useful when, for example, testing insulation of XLPE cables that should not be tested above 5000 V. The lock function will ensure it does not exceed the V_{lock} voltage within the stated output voltage accuracy.

On test completion, insulation capacitance (C) and the Time Constant (TC) associated with it is calculated and displayed.

$$\text{Time Constant (TC)} = R_{\text{insulation}} \times C_{\text{insulation}}$$

Timed IR test

A timed test IR(t) will automatically terminate an insulation test after a preset time. Default timer is set to 1 minute and is adjustable within the settings function. This is a useful feature which saves the user watching the display for the full duration of the test and the possibility of missing the 1 minute reading.

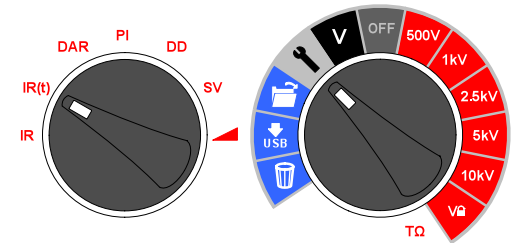

Turn the central rotary switch to the settings position. Select IR(t) on the test mode rotary switch. The default time of 1:00 minute will flash prompting the user to select a new time using the up/down arrow buttons. Press OK to set test duration and turn central rotary switch to desired test voltage. Press and hold TEST to start the test.

DAR and PI Insulation Tests

DAR and PI tests are measurements of resistance over time expressed as a ratio of resistance at time t2 divided by resistance at time t1. The assumption is that insulation temperature does not vary widely over the duration of the test so the resulting DAR and/or PI value are temperature independent. Testing should be done at or below 40 °C, 104 °F for this assumption to hold.

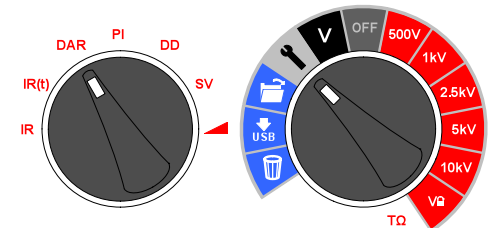

DAR and PI timers t1 and t2 are set when DAR or PI is selected on the test mode rotary switch with the central rotary switch in the settings position. Timer t1 is set first followed by t2. Up and down arrow buttons are used to change the t1 and t2 default values and OK confirms each setting.

DAR and PI insulation test voltages are selected on the central rotary switch by simply aligning the switch opposite to the required insulation test voltage. Press and hold TEST to start a DAR/PI test.

DAR is defined as the ratio of insulation resistance at 1 minute divided by insulation resistance at 30 seconds, although a 1 minute, 15 second DAR is also popular:

$$\text{DAR} = \text{IR}_{60\text{s}} / \text{IR}_{30\text{s}}$$

Insulation Condition	DAR result
Poor	< 1
Acceptable	1 – 1.4
Excellent	1.4 – 1.6

IEEE standard 43-2000, Recommended Practice for Testing Insulation Resistance for Rotating Machines, defines PI as the ratio of insulation resistance at 10 minutes divided by insulation resistance at 1 minute:

$$\text{PI} = \text{IR}_{10\text{min}} / \text{IR}_{1\text{min}}$$

If $\text{IR}_{1\text{min}} > 5000 \text{ M}\Omega$ the PI may or *may* not be an indication of insulation condition and is therefore not recommended by IEEE std. 43.

Insulation Condition	PI result
Poor	< 1
Questionable	1 - 2
Acceptable	2 - 4
Good	> 4

PI results > 1.5 are regarded as acceptable by IEC60085-01:1984 for thermal class rating A, and PI results > 2.0 for thermal class ratings B, F and H.

Dielectric Discharge test

The Dielectric Discharge (DD) or *re-absorption current* test operates during the discharge of the dielectric under test. Originally developed by EDF, France’s power utility company, it is a

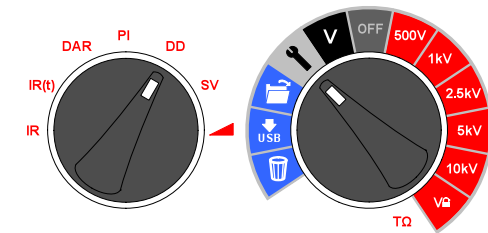

diagnostic insulation test that allows ageing, deterioration, and voids in the insulation to be assessed. The result is dependent on the discharge characteristic so the internal condition of the insulation is tested, largely independent of any surface contamination.

The insulator must first be charged for a sufficient time to be stable, i.e. charging and polarization are complete and the only remaining component of current is leakage current due to the insulation. On discharge the capacitive component of the discharge current decays from a high value with a relatively short time constant of a few seconds. The released absorption current decays from a lower value with a relatively long time constant of up to several minutes.

The DD timer defaults to 30 minutes of charging, which is generally sufficient time for full absorption to take place in an insulation material. The default test voltage is set to 500 V so the primary rotary switch must be set at or above 500 V.

The default DD test duration (t1) is 30 minutes insulation test followed by a fixed 1 minute discharge. The initial 30 minute period can be adjusted but care should be taken to ensure that full absorption will take place in the insulation test period. DD should be selected on the test mode rotary switch and settings on the central rotary switch. Timer t1 is set using the up and down arrow buttons and OK confirms the setting.

The ‘DD’ test requires the instrument to measure the discharge current 1 minute after the removal of the test

voltage, which is greater than the primary time constant of the discharge. On completion of the test, the instrument uses this measurement along with the test voltage and calculated capacitance to produce a figure of merit indicating the quality of the insulation.

$$DD = I_{1min} / (V \times C)$$

where I_{1min} is the discharge current in mA one minute after removal of the test voltage V in Volts and C is the capacitance in Farads.

DD results can identify excess discharge currents that arise when a layer of multi-layer insulation is damaged or contaminated, a condition that will be missed by both the IR and PI tests. Discharge current will be higher, for a given value of voltage and capacitance, if an internal layer is damaged. The time constant of this individual layer will mismatch the other layers, giving rise to a higher value of current than for insulation that is 'good' in this respect.

Homogenous insulation will have a DD value of 0, while good multi-layer insulation will have a value up to 2. The following table is a guide to DD test results:

Insulation Condition	DD result
Bad	> 7
Poor	4 - 7
Questionable	2 - 4
Good	< 2
Homogenous	0

Step Voltage Test

The SV test is a controlled overvoltage test that can be applied to stator and rotor windings on synchronous and asynchronous AC motors and the armature and field windings on DC motors. It is advisable to perform a PI test before an SV test to determine if the insulation is suitable for overvoltage

testing. If a PI test was performed to verify the winding's suitability for over voltage testing, the winding must be completely discharged before the overvoltage test is performed.

The SV test is based on the principle that an ideal insulator will produce identical readings at all voltages, while an insulator which is being over stressed, will show lower insulation values at higher voltages.

During the test the applied voltage steps incrementally by one fifth of the final test voltage each minute for 5 minutes, taking successive measurements.

Resistance readings for the first four 'steps' are displayed under consecutive time designators '1m' to '4m'. The 5 minute reading is displayed by the main display. If the default 5 minute test duration is changed by the user the four readings will not show the respective '1m' to '4m' indicators.

The SV test duration can be adjusted if desired from the 5 minute default value using the up/down arrows and OK to save the setting.

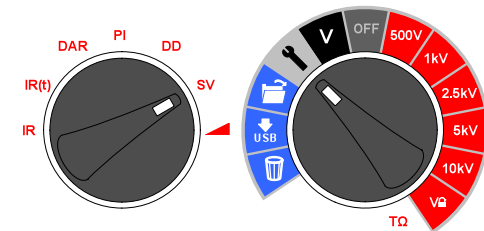

The step timer will always be set to total test time divided by five. Too short a step time may result in incorrect readings and too long a step time may over stress a motor.

The reference standard for step voltage testing is IEEE 95-2002.

Ramp voltage test

The ramp voltage test is an overvoltage test similar to the SV test but with improved control and warning of potential insulation failure. The slow continuous voltage ramp is less likely to result in unpredictable damage to the insulation than the rapid step increases employed in SV test.

If a PI test was performed to verify the winding's suitability for over voltage testing, the winding must be completely discharged before the over voltage test is performed.

The typical voltage ramp (dV/dt) is 1 kV/min which is the default for MIT525/MIT1025. This value is user adjustable from the settings function with the mode rotary switch set to ramp. Up and down buttons are used to adjust dV/dt to the required rate and OK confirms the setting. Press and hold TEST to start.

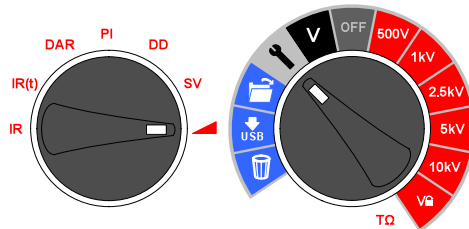

The test will ramp the voltage until it reaches the selected test voltage unless a breakdown or sudden rise in current is detected. The result displayed after the test is the final insulation resistance, voltage and current. If the result is saved a complete curve of current (μA) and voltage (kV) is recorded and can be read into PowerDB, PowerDB Lite or converted to a spreadsheet so that the current vs. voltage curves can be compared to published curves in IEEE 95-2002.

Measurement Techniques

Understanding Measurement Currents

Insulation resistance is defined as the dc test voltage divided by the total current flowing in an insulator. The total current has four components; capacitive current, absorption current, conductance current and leakage current.

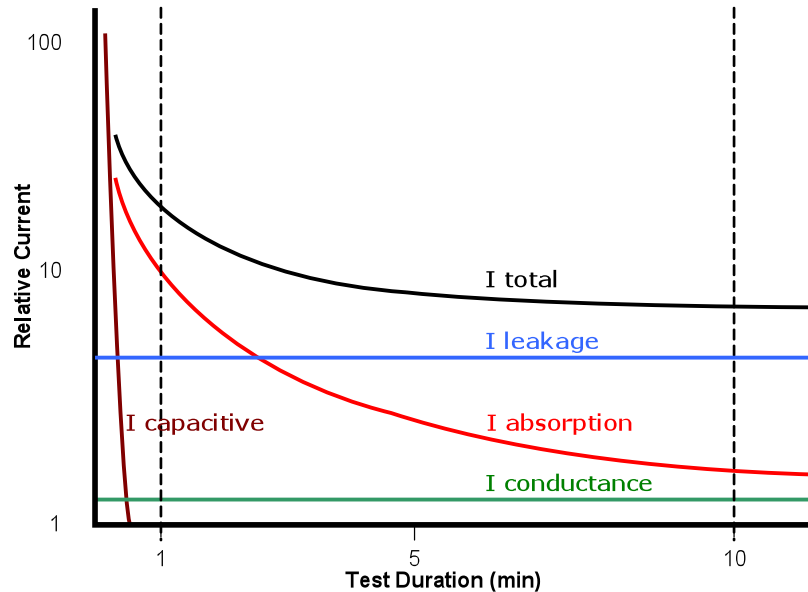

In the case of dry insulation conductance current may be negligible, and the leakage current may be low, in which case the absorption current will dominate the total current measured.

Insulation measurements above 100 GΩ

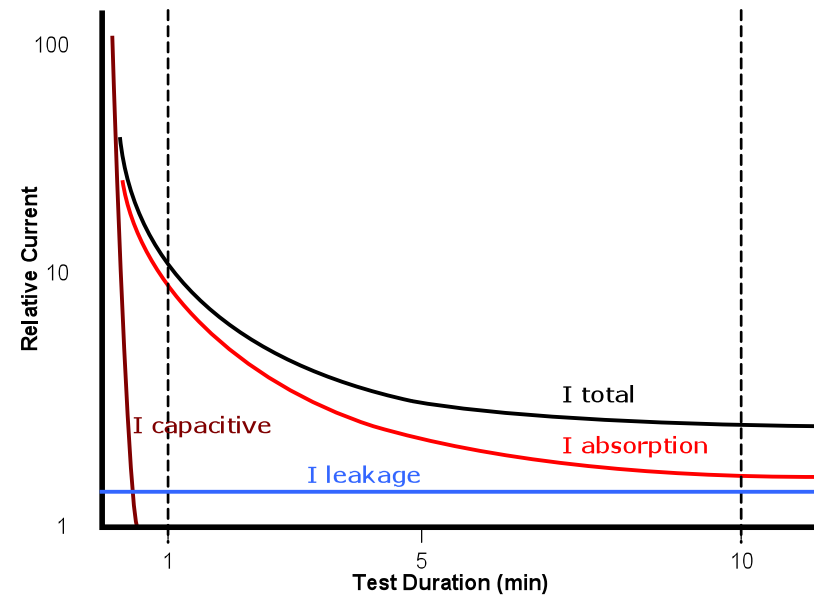

Measurements up to 100 GΩ can be made without any special precautions, assuming that the test leads are reasonably clean and dry. The guard lead can be used to remove the effects of surface leakage if necessary. When measuring resistances above 100 GΩ, the test leads should not be allowed to touch each other, or any other object since this will introduce leakage paths. Sharp points at the test lead connections should also be avoided since this will encourage corona discharge.

The output is isolated, and so will float relative to ground such that the positive terminal is at plus half of the test voltage, and the negative terminal is at minus half of the test voltage with respect to ground.

Leakages therefore occur between the positive terminal and ground, between the negative terminal and ground, and directly between the positive and negative terminals. These leakages have a significant effect and can occur through air.

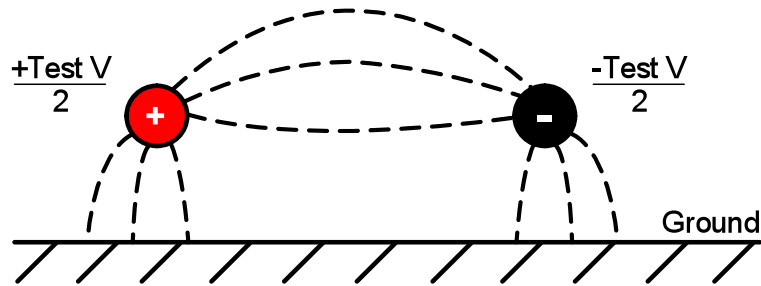

If the guard lead is grounded, and since the negative terminal is at the same voltage as the guard terminal, the leakage into the negative terminal will be considerably reduced. This will improve accuracy because the current flowing into the negative terminal is measured by the instrument and used to calculate resistance. This technique is only permissible if the item under test is isolated from ground. In this context *isolated* means insulated by a resistance of at least 5 MΩ for the positive terminal, or at least 10 kΩ for the negative terminal.

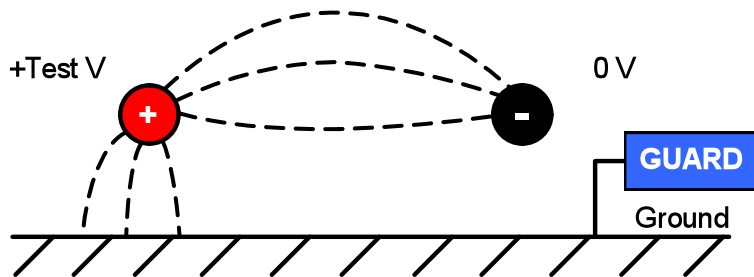

Conversely, if the positive terminal is grounded, then the negative terminal will be at a voltage equal to the test voltage relative to ground, which will result in an increase in leakage current, and worsening of measurement accuracy.

When making measurements above 100 GΩ therefore, the user should ground the Guard lead where possible, otherwise parallel leakage paths may occur.

Alternatively, screened leads are available as an optional accessory from Megger. When using a screened lead the screen is plugged into the Guard terminal, diverting any leakage currents. This considerably improves measurements made with a floating output, where the leads might touch each other or another object other than the test piece.

Terminals

There are three test terminals marked +, - and GUARD. These terminals are designed to accept only genuine Megger test leads. Shutters across the terminals prevent accidental ingress of dirt and other objects. Test lead plugs interlock with the shutters and are released by rotating the test lead plug by a quarter turn.

The GUARD terminal, as explained below, is only used in cases where surface leakage currents need to be eliminated. Most measurements use just the + and - terminals. The instrument's internal voltage generator drives the + terminal with respect to the - terminal, current being measured in the - terminal.

GUARD terminal, screened leads

For basic insulation tests and where there is *little possibility of surface leakage affecting the measurement* it is unnecessary to use the guard terminal, i.e. if the insulator is clean and there are unlikely to be any adverse current paths.

However in cable testing for example, there may be surface leakage paths across the insulation between the bare cable and the external sheathing due to the presence of moisture or dirt. Where it is required to remove the effect of this leakage, particularly at high testing voltages, a bare wire may be bound tightly around the insulation and connected via the third test lead to the guard terminal 'G'.

The guard terminal is at the same potential as the negative terminal. Since the leakage resistance is effectively in parallel with the resistance to be measured, the use of the guard causes the current flowing through surface leakage to be diverted from the measuring circuit. The instrument therefore reads the leakage of the insulator, ignoring leakage across its surface.

The display will show a warning and fuse terminal symbol if the internal guard terminal fuse has blown. The instrument must be switched off to clear the message before further testing is permitted. The fuse should be replaced by an authorised repairer. The instrument may be used in the mean time if the guard terminal not used. Refer to notes regarding measurements above 100 G Ω above.

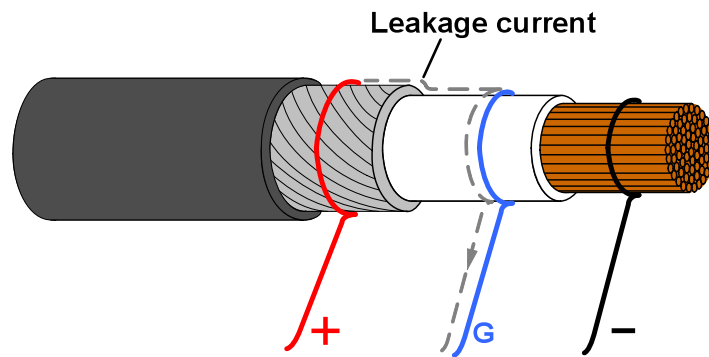

This diagram illustrates GUARD terminal used to prevent surface leakage on cable insulation from affecting a high resistance measurement.

Screened leads are available for the complete range of insulation testers. They are useful in HV switchyards where induced currents are an issue. The screen connects to GUARD and prevents induced currents in the lead.

Preventive Maintenance

Cleaning

Disconnect the instrument and wipe it with a clean cloth *slightly* dampened with soapy water or Isopropyl alcohol (IPA). Care should be taken near the terminals, IEC power and USB sockets.

Care of the instrument

The instrument should always be handled with care and not dropped. Always ensure that the instrument is secured when being transported to prevent mechanical shock.

Leads

Leads are silicone insulated and perform well in all weather conditions. Always keep the leads in the clip-on lead pouch supplied with the instrument.

Regular inspection of leads is recommended to ensure they are not damaged in any way. Damaged leads could affect insulation resistance readings and are a safety hazard.

Battery Care

The battery should be charged on a routine basis at an absolute minimum of once a year. However more frequent charging, i.e. once per quarter is preferable.

Never attempt to charge the battery below 0 °C or above +40 °C. The battery is charged by connecting line power at the instrument IEC power socket.

Store the instrument in a cool, dry location to improve battery life. Storage temperatures below freezing should be avoided.

Replacing the battery

Read and fully understand the warnings on the Li-ion battery in the Safety Warnings section of this document.

The battery pack contains Lithium-ion cells and should be replaced when it no longer holds a charge. A new battery is available as a spare part from Megger. **Genuine Megger battery packs must be used. Failure to use genuine parts may affect product safety performance and will invalidate your warranty.**

Danger Electric Shock Hazard: Removing the lower case to change the battery exposes the AC supply wiring which will be at a hazardous voltage if the equipment is connected to the AC supply.

Replacement involves removal of four screws from the bottom of the instrument after which the base can be lifted away from the front panel and internal moulded assembly. Care should be taken to keep the front panel and moulding assembly together. The battery pack is housed within a grey moulded cover secured by four screws.

On no account must the transparent inner case be opened. Hazardous voltages up to 10 kV will be exposed. No user serviceable parts are inside. Refer servicing to qualified service personnel. If there is any damage to the inner transparent casing or its lid, then confirm that the Central Rotary Switch is in the OFF position, disconnect the old battery and DO NOT connect the new one. Refit the bottom cover and contact Megger Instruments for service.

Instructions:

1. Remove the lid, switch the central rotary switch to OFF.
2. Disconnect the IEC AC power lead and all test leads before inverting the lower case, resting the front panel on a soft surface so as not to damage the keypad.
3. Remove the four case fixing screws and lift off case bottom.
4. Carefully unclip the battery cable connector leading from the main printed circuit board to the battery and remove the cables from recesses designed to hold them in place.

5. Remove the four screws and lift off the battery cover.
6. Remove the used battery and replace with a genuine spare battery ordered from Megger, ensuring correct orientation of cable exit.
7. Route the battery cables via the recesses and clip the battery connector to the printed circuit board battery receptacle **ensuring correct orientation**.
8. Replace the battery cover and secure with the four screws.
9. Ensure the alignment of the instrument panel and high voltage moulding, then replace the lower case and secure with the retaining screws. Take especial care not to leave foreign bodies inside the casing.
10. Check and verify instrument operation.

Technical Specification

Electrical specification

Voltage input range: 85-265 V rms, 50/60 Hz, 100 VA

Battery 11.1 V, 5.2 A hour, safety rated to IEC 62133:2003

Battery life
MIT515, MIT525: Typical capacity is 6 hours continuous @ 5 kV with a 100 M Ω load
MIT1025: Typical capacity is 4.5 hours continuous @ 10 kV with a 100 M Ω load

Battery charge time: 2.5 hours from deep discharge, 2 hours normal discharge

30 min. charge: 1 hour continuous test at 100 M Ω , 5 kV

Test voltages

MIT515, MIT525: 250 V, 500 V, 1000 V, 2500 V, 5000 V
MIT1025: 500 V, 1000 V, 2500 V, 5000 V, 10000 V

User defined test voltage:

MIT515, MIT525: 100 V to 1 kV in 10 V steps, 1 kV to 5 kV in 25 V steps,
MIT1025: 5 kV to 10 kV in 25 V steps

Accuracy (23 °C):

MIT515, MIT525: $\pm 5\%$ to 1 T Ω , $\pm 20\%$ to 10 T Ω
MIT1025: $\pm 5\%$ to 2 T Ω , $\pm 20\%$ to 20 T Ω

Guard: 2% error guarding 500 k Ω leakage with 100 M Ω load

Display range analogue: 100 k Ω to 10 T Ω

Display range digital:

MIT515, MIT525: 10 k Ω to 10 T Ω
MIT1025: 10 k Ω to 20 T Ω

Short circuit current: 3 mA nominal*

* Maximum power regulation technology ensure maximum power transfer throughout all loads not just at short circuit outperforming many 5 mA testers

Insulation alarm: 100 k Ω to 1 G Ω

Capacitor charge:

MIT515, MIT525: < 3 s/ μ F at 3 mA to 5 kV
MIT1025: < 5 s/ μ F at 3 mA to 10 kV (MIT1025)

Capacitor discharge:

MIT515, MIT525: < 250 ms/ μ F discharge from 5000 V
MIT1025: < 500 ms/ μ F to discharge from 10000 V to 50 V

Capacitance range

(above 500 V): 10 nF to 25 μ F dependant on measurement voltage

Capacitance accuracy

(23 °C): $\pm 10\% \pm 5$ nF

Voltage output accuracy

(>200 V, 0 °C to 30 °C): +4%, -0%, ± 10 V nominal test voltage at 1 G Ω

Current measurement

range: 0.01 nA to 6 mA

Current measurement

accuracy (23 °C): $\pm 2\% \pm 0.5$ nA at all voltages

Interference (noise) rejection:

MIT515, MIT525: 1 mA per 250 V up to a maximum of 3 mA

MIT1025: 1 mA per 600 V up a maximum of 3 mA

Voltmeter range: 30 V to 660 V ac or dc, 50/60 Hz

Voltmeter accuracy: $\pm 3\%$, ± 3 V

Timer range: Up to 99 minutes, 15 second minimum setting

Memory capacity: 5½ hours continuous logging every 5 s.
or 33 logged PI tests
or 350 logged IR tests

Test regimes:

MIT515 IR, IR(t), DAR, PI

MIT525, MIT1025: IR, IR(t), DAR, PI, SV, DD, ramp test

Interface: USB type B (device)

Real time output: USB, 1 reading/second (resistance, current and voltage)

Environmental Conditions

Altitude: 3000 m, test lead CAT rating valid to 2000 m, safe working practices must be applied and clips must not be handled until discharge is complete

Operating temperature: -20 °C to 50 °C

Storage temperature: -25 °C to 65 °C

Humidity: 90% RH non-condensing at 40 °C

Ingress protection: IP65 (lid closed), IP40 (lid open)

GENERAL SPECIFICATION

Safety: Meets the requirements of IEC 61010-1, CATIV 600 V to 3000 m
Instrument must be operated with all test leads connected above 2000 m

EMC: Meets the requirements of IEC61326-1

Dimensions: L 315 mm x W 285 mm x H 181 mm

Weight: 4.5 kg

Repair and Warranty

If the protection of an instrument has been impaired it should not be used, but sent for repair by suitably trained and qualified personnel. The protection is likely to be impaired if, for example, the instrument shows visible damage, fails to perform the intended measurements, has been subjected to prolonged storage under unfavourable conditions, or has been exposed to severe transport stresses.

New instruments are covered by a two year warranty from the date of purchase by the user, the second year being conditional on registration of the product on www.megger.com. Any unauthorised prior repair or adjustment will automatically invalidate the warranty.

These products contain no repairable parts, with the exception of the user replaceable battery, and if defective should be returned to your supplier in original packaging or packed so that it is protected from damage during transit. *Damage in transit is not covered by this warranty and replacement/repair is chargeable.*

Calibration, Service and Spare Parts

For service requirements for Megger Instruments contact:

Megger Instruments Limited Archcliffe Road Dover Kent CT17 9EN England. Tel: +44 (0) 1304 502 243 Fax: +44 (0) 1304 207 342	Megger Valley Forge Corporate Centre 2621 Van Buren Avenue Norristown PA 19403 U.S.A. Tel: +1 610 676 8579 Fax: +1 610 676 8625
---	--

Megger operate fully traceable calibration and repair facilities, ensuring your instrument continues to provide the high standard of performance and workmanship you expect. These facilities are complemented by a worldwide network of

approved repair and calibration companies to offer excellent in-service care for your Megger products.

Returning product to Megger UK & USA service centres

1. When an instrument requires recalibration, or in the event of a repair being necessary, a Returns Authorisation (RA) number must first be obtained from one of the addresses shown above. You will be asked to provide the following information to enable the Megger Service Department to prepare in advance for receipt of your instrument, and to provide the best possible service to you.
 - Model, e.g. MIT1025.
 - Serial number, to be found on the underside of the case or on the calibration certificate.
 - Reason for return, e.g. calibration required, or repair.
 - Details of the fault if the instrument is to be repaired.
2. Make a note of the RA number. A returns label can be emailed or faxed to you if you wish.
3. Pack the instrument in the original packing box to prevent damage in transit.
4. Ensure the returns label is attached, or that the RA number is clearly marked on the outside of the package and on any correspondence, before sending the instrument, freight paid, to Megger. Copies of the original purchase invoice and packing note should be sent simultaneously by airmail to expedite clearance through customs. In the case of instruments requiring repair outside the warranty period, an immediate quotation can be provided when obtaining the RA number.
5. You may track the progress of your return on line at www.megger.com

Approved Service Centres

A list of Approved Service Centres may be obtained from the UK address above, or from Megger's website at www.megger.com

Accessories, Equipment and Spares

Included Accessories (all models)	Part Number
User guide CD-ROM	
Power lead	
3 m leadset x 3, medium insulated clips	1002-531
Included Accessories (MIT525, MIT1025)	
USB cable	25970-041
PowerDB Lite software	
3 m leadset x 3, large insulated clips (MIT1025 only)	1002-534
Optional Accessories	
HV test lead sets	
3 m leadset x 3, medium insulated clips	1002-531
3 m leadset x 3, large insulated clips	1002-534
3 m leadset x 3, bare clips	8101-181
8 m leadset x 3, bare clips	8101-182
15 m leadset x 3, bare clips	8101-183
Screened HV test lead sets	
3 m, 5 kV screened un-insulated small clips	6220-835
15 m, 5 kV screened un-insulated small clips	6311-080
3 m, 10 kV screened un-insulated small clips	6220-834
10 m, 10 kV screened un-insulated small clips	6220-861
15 m, 10 kV screened un-insulated small clips	6220-833
Other	
CB101, 5 kV Calibration Box	6311-077
Calibration Certificate - CB101	1000-113
UKAS calibration Certificate CB101	1000-047

Accessories (all models)

Spare Li-ion Battery	Part Number 1002-552
----------------------	--------------------------------

Megger Limited
Archcliffe Road, Dover
Kent CT17 9EN England
T +44 (0)1 304 502101
F +44 (0)1 304 207342
E uksales@megger.com

Megger
4271 Bronze Way, Dallas,
Texas 75237-1019 USA
T +1 800 723 2861 (USA ONLY)
T +1 214 333 3201
F +1 214 331 7399
E ussales@megger.com

Megger
Z.A. Du Buisson de la Couldre
23 rue Eugène Henaff
78190 TRAPPES France
T +33 (0)1 30.16.08.90
F +33 (0)1 34.61.23.77
E infos@megger.com

Megger Pty Limited
Unit 1, 11-21 Underwood Road
Homebush
NSW 2140 Australia
T +61 (0)2 9397 5900
F +61 (0)2 9397 5911
E ausales@megger.com

Megger Limited
Unit 106-550 Alden Road
Markham ON L3R 6A8 Canada
T +1 416 298 9688 (Canada only)
T +1 416 298 6770
F +1 416 298 0848
E casales@megger.com

Megger
501 Crystal Paradise Mall
Off Veera Desai Road
Andheri(w), Mumbai - 400053
Maharashtra
India
T +91 22 26740468
F +91 22 26740465

Megger GmbH
Obere Zeil 2
61440 Oberursel
Germany
T 06171-92987-0
F 06171-92987-19

Megger AB
Eldarvägen 4
Box 2970
SE-187 29 TÄBY
Sweden
T +46 8 510 195 00
F +46 8 510 195 95

Megger AG
Ob. Haselweg 630
5727 Oberkulm
Aargau
Switzerland
T +41 62 768 20 30
F +41 62 768 20 33

Megger products are distributed in 146 countries worldwide.

This instrument is manufactured in the United Kingdom.

The company reserves the right to change the specification or design without prior notice.

Megger is a registered trademark
Part No. MIT515_525_1025_UG_en_V02 0412
www.megger.com