



Instruction Manual

ULTRASONIC FLOWMETER M-Flow

TYPE: FLR (Flow transmitter)
FLS (Detector)
FLY (Signal cable)



PREFACE

We thank you very much for purchasing Fuji's ultrasonic flowmeter.

The instruction manual concerns the installation, operation, checkup and maintenance of the Flow transmitter (FLR) and Detector (FLS) of ultrasonic flowmeter. Read it carefully before operation.

- Before using, be sure to read this instruction manual carefully to ensure correct installation, operation and maintenance of the flowmeter. Note that incorrect handling may lead to trouble or personal injury.
- The specifications of this flowmeter are subject to change for improvement without prior notice.
- Do not attempt to modify the flowmeter without permission. Fuji is not responsible for any trouble caused by modification without permission. If it becomes necessary to modify the flowmeter, contact our office in advance.
- This instruction manual should always be kept on hand by the operator.
- After reading, be sure to keep this manual in a place where it can easily be seen by the operator.
- Make sure that this manual is presented to the end user.
- If the instruction manual has been lost, request another one (with charge) to our local business office.

Manufacturer: Fuji Electric Instruments Co., Ltd.
Type: Shown on nameplate of Flowmeter
Date of manufacture: Shown on nameplate of Flowmeter
Product nationality: Japan

NOTICE

- It is strictly prohibited to reproduce any part or the whole of this instruction manual.
- The contents of this manual may be changed without prior notice.



©Fuji Electric Instruments Co.,Ltd. 2002

Issued in January, 2002
Rev. 1st edition November, 2002
Rev. 2nd edition February, 2004



SAFETY PRECAUTION

Before using, read the following safety precaution to ensure correct handling of the flowmeter.

- The following items are important for safe operation and must be fully observed. These items are classified into "DANGER" and "CAUTION".

Warning & Symbol	Meaning
 DANGER	Incorrect handling may lead to a risk of death or heavy injury.
 CAUTION	Incorrect handling may lead to a risk of medium or light injury, or to a risk of physical damage.

- The items noted under " CAUTION" may also result in serious trouble depending on circumstances.
- All the items are important and must be fully observed.

Caution on Installation and Piping	
 DANGER	<ul style="list-style-type: none"> • This product has not an explosion-proof structure. Do not use it in a place with explosive gases, otherwise, it can result in serious accidents such as explosion, fire, etc.
 CAUTION	<ul style="list-style-type: none"> • The unit should be installed in a place conforming with the installation requirements noted in this instruction manual. Installation in an improper location may lead to a risk of electric shocks, fire, malfunction, etc. • The unit should be installed as noted in the manual. Improper installation will cause falling, trouble or malfunction of the unit. • During installation, make sure that the inside of the unit is free from cable chips and other foreign objects to prevent fire, trouble, malfunction, etc. • The items under "Caution on Installation" noted in the manual must be fully observed; careless installation may result in trouble or malfunction of the unit.

Caution on Wiring	
 CAUTION	<ul style="list-style-type: none"> • When performing wiring termination to prevent output trouble caused by moisture, dew condensation or water leak, follow "Section 3.3 Flow transmitter wiring" described in this manual • Before performing the wiring work, be sure to turn OFF the main power to prevent electric shocks. • Do not perform wiring work outdoors in rainy days to prevent insulation deterioration and dew condensation; otherwise, it can result in trouble, malfunction, etc. • Be sure to connect a power source of correct rating. Connection of a power source of incorrect rating may lead to a risk of fire. • The unit must be earthed as specified to prevent electric shocks or malfunction. • The analog output signal cable should be wired as far away as possible from high-voltage lines to prevent entry of noise signals as it will cause malfunction of the unit. • To prevent malfunction of the unit, the analog output signal cable and power cable should be wired using separate conduits.

Caution on Maintenance/Inspection



CAUTION

- The unit should be inspected everyday to always obtain good results of measurements.
- When measuring the insulation resistance between the power/output terminal and the case, follow “Section 5.2.3 How to measure the insulation resistance” described in this manual.
- If the fuse is blown, detect and eliminate the cause, and then replace the fuse with a spare. If there are no spares, replace the fuse with the one specified in this manual (that must be prepared by customer). Use of a fuse other than specified or its short-circuit may cause an electric shock or fire. The fuse should be replaced according to “Section 5.3 How to replace the fuse” described in this manual.

CAUTION ON INSTALLATION LOCATION



CAUTION

- (1) Sufficient space for daily inspection, wiring, etc.
- (2) A place not exposed to direct sunshine nor weathering.
- (3) Isolation from vibration, dust and moisture
- (4) A place not subjected to radiated heat from a heating furnace etc.
- (5) A place not subjected to corrosive atmosphere
- (6) A place not to be submerged
- (7) A place remote from electrical devices (motor, transformer, etc.) which generate electromagnetic induction noise, electrostatic noise, etc.
- (8) A place not subjected to excessive fluid pulsation (pump discharge side)
- (9) A place that provides enough place for the length of the straight pipe.
- (10) A place where ambient temperature and humidity are -20 to +50°C and 90% RH or less for flow transmitter (FLR), and -20 to +60°C and 90% RH or less for detector (FLS).

CONTENTS

PREFACE	i
SAFETY PRECAUTION	ii
CAUTION ON INSTALLATION LOCATION	iv
CONTENTS	v
1. OUTLINE OF PRODUCT	1
1.1. Outline	1
1.1.1. Measuring principle	1
1.2. Checking the received products	2
1.3. Checking the type and specifications	3
1.4. Names and functions of each part	5
2. SELECTION OF INSTALLATION PLACE	6
2.1. Flow transmitter	6
2.2. Detector	7
2.2.1. Length of straight pipe	8
2.2.2. Mounting posture	9
3. INSTALLATION AND PROCEDURE PRIOR TO RUNNING	10
3.1. Outline of installation procedure	10
3.2. Installation of flow transmitter	11
3.2.1. Wall mounting	11
3.2.2. 2B pipe stand mounting	11
3.3. Flow transmitter wiring	12
3.3.1. Precautions in wiring	12
3.3.2. Applied wiring	12
3.3.3. Treatment of wiring ports	12
3.3.4. Wiring to each terminal	13
3.4. Setting the piping parameters and calculating the sensor unit spacing	14
3.5. Installation of detector	16
3.5.1. Outline of detector installation procedure	16
3.5.2. How to treat the mounting surface	16
3.5.3. How to mount the frame	16
3.5.4. How to mount the sensor unit	19
3.5.5. How to remove the sensor unit	22
3.6. Setting the range and total pulse output	23
3.7. How to calibrate zero	26
4. PARAMETERS	27
4.1. Description on display/setting section	27
4.2. Configuration of keys	28

4.3. Initial values of parameters	31
4.4. Parameter protection	33
4.4.1. Parameter protection ON/OFF	33
4.5. Output setup mode	34
4.5.1. Adjusting zero point	34
4.5.2. Setting the damping	35
4.5.3. Setting the low flow rate cutting	36
4.5.4. Setting the LCD indication	37
4.5.5. Setting the flow rate and flow velocity range	38
4.5.5.1. Setting the flow rate range (single range FLOW SPAN-1)	38
4.5.5.2. Setting forward automatic 2 ranges	39
4.5.5.3. Setting forward/reverse automatic 2 ranges	41
4.5.5.4. How to set analog output at error (BURNOUT)	43
4.5.6. Setting the total	45
4.5.6.1. Setting the total pulse (pulse value, pulse width)	45
4.5.6.2. Setting the preset value	48
4.5.6.3. TOTAL mode (total reset, start, stop)	49
4.5.6.4. Determining how to dispose of total at error (BURNOUT)	50
4.5.7. Setting the DO output	52
4.5.7.1. Invalidating the DO output	53
4.5.7.2. How to validate the total pulse output	54
4.5.7.3. How to validate outputting the FLOW SPAN-2	55
4.5.7.4. How to validate the alarm output	56
4.5.7.5. How to validate the flow switch	57
4.5.7.6. How to validate the total switch	59
4.5.8. How to compensate the measurement value	61
4.6. Measure setup mode	62
4.6.1. How to set the unit system	62
4.6.2. How to set the flow rate unit	63
4.6.3. How to set the total unit	64
4.6.4. How to set the piping parameters	65
4.7. Maintenance mode	67
4.7.1. How to calibrate the analog output	67
4.7.2. How to set the constant current output	68
4.7.3. How to check the action of total pulses	69
4.7.4. How to check the status output	70
4.7.5. How to validate the test mode (simulated flow rate output)	71
4.7.6. How to validate a serial transmission (RS-232C/RS-485)	73
4.7.7. How to validate the synchronization	75
4.7.8. How to select the language	76
4.7.9. How to set the ID No.	77
4.7.10. How to confirm the software version	78

5. MAINTENANCE AND CHECKUP	79
5.1. Routine checkup.....	79
5.2. Periodic checkup	79
5.2.1. Checking the zero point	79
5.2.2. Reapplying silicon-free grease	79
5.2.3. How to measure the insulation resistance	80
5.3. How to replace the fuse.....	81
5.4. How to replace the relay	82
5.5. How to replace the LCD	83
5.6. Troubleshooting	84
5.6.1. If indication is abnormal	84
5.6.2. If keying is abnormal	84
5.6.3. If measurement value is abnormal.....	85
5.6.4. If analog output is abnormal.....	88
5.6.5. How to check the received waveform	89
5.6.5.1. How to connect the oscilloscope	89
5.6.5.2. Checking the received waveform	90
5.6.6. Remediating a hardware fault	91
6. APPENDIXES	92
6.1. External communication specifications	92
6.1.1. Communication specifications	92
6.1.2. Message configuration	93
6.1.2.1. Reception	93
6.1.2.2. Acknowledge	93
6.1.2.3. Error acknowledge	93
6.1.3. Error check	93
6.1.4. Function code table.....	94
6.1.5. Error code table	94
6.1.6. Cable connection specifications (RS-232C)	94
6.2. Specifications	95
6.3. Dimension diagram	97
6.4. Scope of delivery	98
6.5. Items to be specified at order	98
6.6. Piping data	99

1. OUTLINE OF PRODUCT

1.1. Outline

This instrument is a clamp-on ultrasonic flowmeter which carries out measurements according to the transit time method. Compact and lightweight design and easy handling have been drastically pursued, and building in machines and equipment is facilitated. This excellent cost performance flowmeter is usable for small to medium piping size of 25 to 225 mm.

1.1.1. Measuring principle

Measuring principle

Ultrasonic pulses are propagated aslant from the upstream and downstream sides, and the time difference caused by the flow is detected to measure the flow rate.

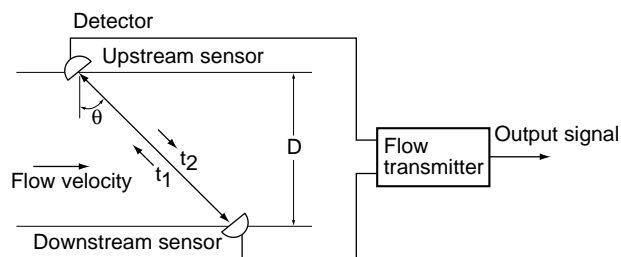

Mounting the detector

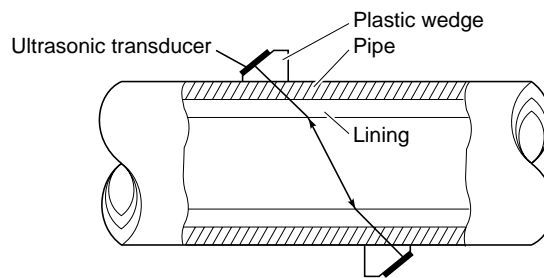

Configuration diagram

(1) Single-path system (V method)

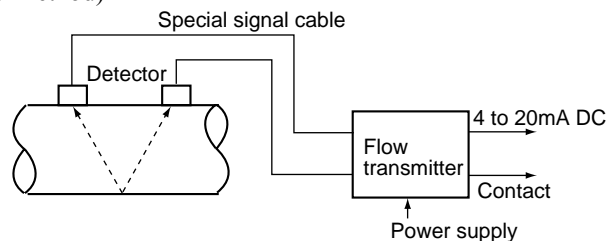

(2) When synchronizing

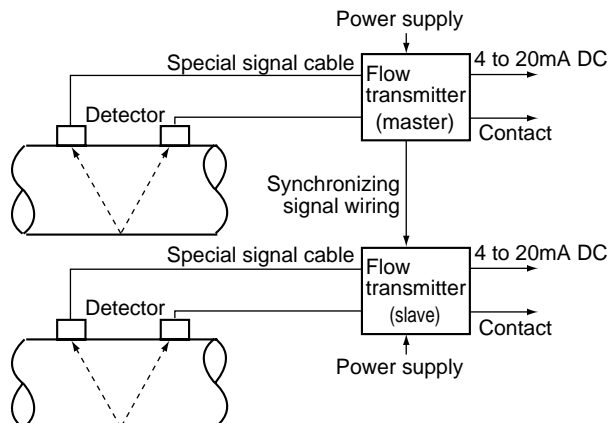

1.2. Checking the received products

- Flow transmitter (FLR)
 - Flow transmitter unit 1 set
 - Waterproof gland 1 set (mounted on main unit)
 - Wall mounting fixture 1 set (mounted on main unit)
 - Pipe mounting fixture (option) 1 set
(U bolt, support fixture, 2 wing nuts, 2 spring washers, 2 plain washers)
- Detector (FLS)
 - Frame 1 pc
 - Sensor unit 1 set (2 pcs)
 - Stainless steel belt 1 set (FLSE12: 2 pcs. FLSE22: 4 pcs.)
 - Spring fixture 2 pcs
 - Silicone rubber or silicone-free compound (option) 1 pc
- Signal cable (FLY: length designated) 1 set (2 pcs)
- Instruction manual 1 copy
- Belt tightening tool (option) As ordered

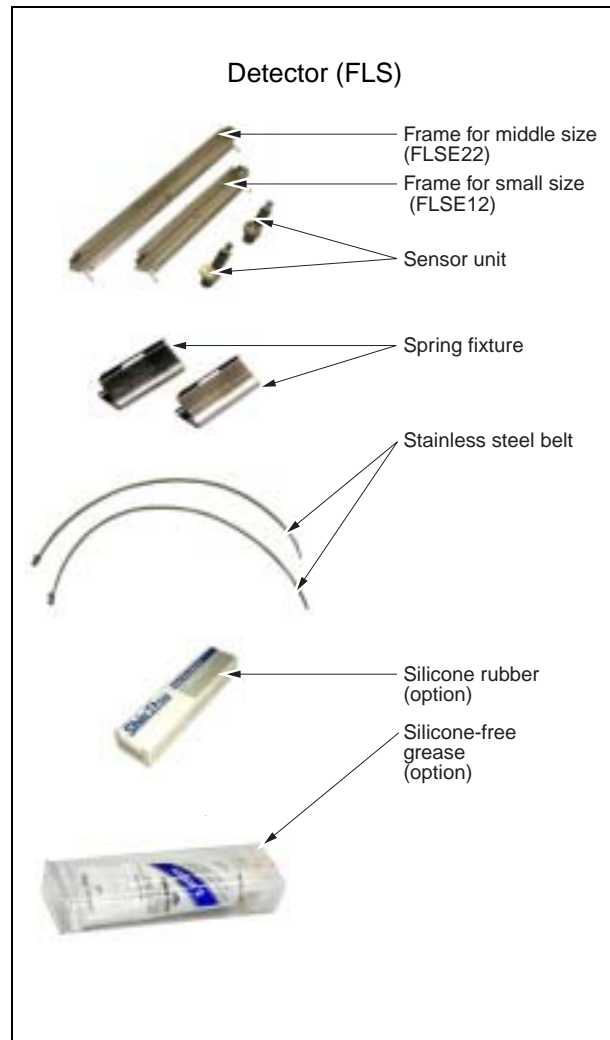
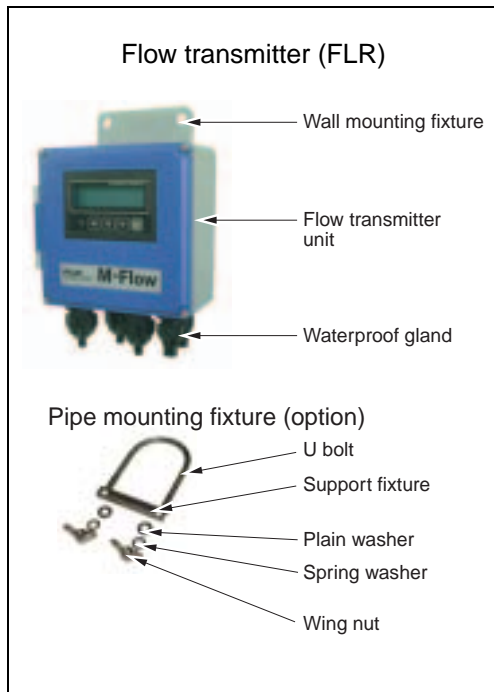

1.3. Checking the type and specifications

The type and specifications of product are indicated on the specifications plate mounted on the flow transmitter and detector frame. Make sure the types are as ordered referring to the type diagrams given below.

<Flow transmitter>

1	2	3	4	5	6	7	8	9	10	11	Description
F	L	R	E				1	-	1	Y	Type (4th digit) Standard for exports
			E								Type (4th digit) Standard for exports
	2										Power Supply (5th digit) 100 to 120Vac, 50/60Hz
	3										200 to 240Vac, 50/60Hz
	4										20 to 30V DC
				Y							Communication & Synchronization (6th digit)
				A							None
				B							RS-232C
				C							RS-485 & Synchronization Synchronization
					Y						Arrester (7th digit)
					A						None
											With arresters for outputs
							1				Modification No. (8th digit) Mark 1
								1			Case structure (9th digit) Immersion-proof (IP65)
									A		Mounting bracket (10th digit) For 2B pipe mount
									B		For wall mount
										Y	Option (11th digit) None



FUJI ELECTRIC	
Ultrasonic Flow Meter	
Type FLRS2YY1-1BY	
Output DC4-20mA	
Power Supply <input type="checkbox"/> DC20-30V	
<input checked="" type="checkbox"/> AC100-120V 50/60Hz	
<input type="checkbox"/> AC200-240V 50/60Hz	
Ser.No. _____	Mfd. 2001
Fuji Electric Instruments Co., Ltd.	
Made in Japan	

<Detector>

1	2	3	4	5	6	7	8	9	10	Description
F	L	S	E	2	1	-	Y	Y		Type (4th digit) Standard
			E							Kind of detector (5th to 6th digit) Small size detector (for 25 to 100mm) Middle size detector (for 50 to 225mm)
				1	2					Acoustic coupler (7th digit) None
				2	2					Silicon rubber (fluid temperature: -20 to +100 deg.C) Silicon-free grease (fluid temperature: 0 to 60 deg.C)
						Y				Modification No. (8th digit) Mark 1
						A				Mounting method (9th digit) Standard (V-mount)
						B				Option (10th digit) None
							1			
								Y		
									Y	

<Signal cable>

1	2	3	4	5	6	7	8	Description
F	L	Y	3				1	Kind of cable (4th digit) Heat resisting cable with water-proof BNC
			3					Cable length (5th to 7th digit) 5m (one pair) 10m (one pair) 15m (one pair) 20m (one pair) 30m (one pair)
				0	0	5		Modification No. (8th digit) Mark 1
				0	1	0		
				0	1	5		
				0	2	0		
				0	3	0		
							1	



FUJI ELECTRIC	Type. FLSS12Y1-YY
	Ser.No.
Sensor.No.	Mfd. 2001
Fuji Electric Instruments Co., Ltd. Made in Japan	

1.4. Names and functions of each part

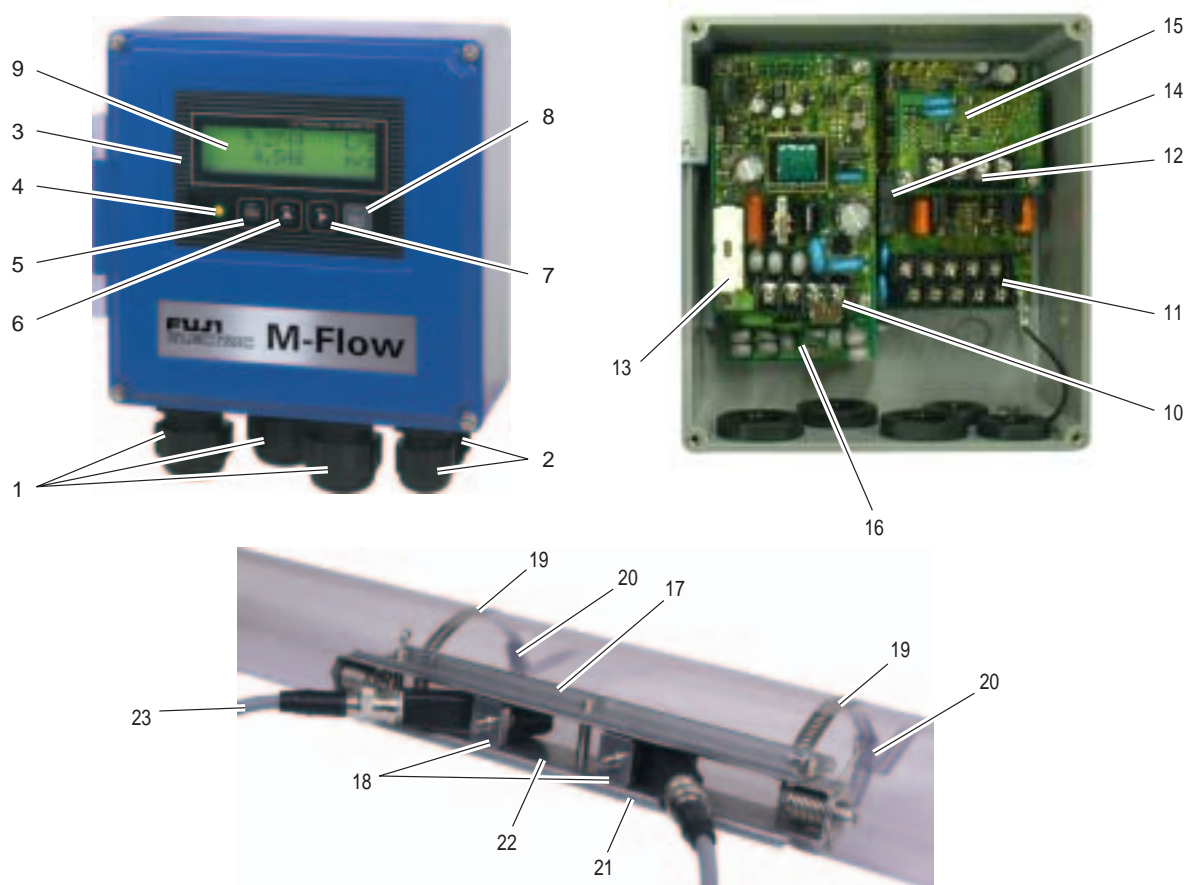

No.	Name	Description
1	Wiring connection port, large	For power cable, output cable
2	Wiring connection port, small	Wiring connection port for signal cable only
3	Indication and setting unit	Indicates and sets the flow rate, etc.
4	Received wave diagnostic indication	Indicates whether received wave is normal (green) or abnormal (red).
5	Escape key	Return to the next-higher layer or cancels the set status.
6	UP key	Selects items, numeric values and symbols.
7	Shift key	Moves the cursor and selects decimal place.
8	Entry key	Enters a selection or registers a setting.
9	LCD indication	Indicates the flow rate or setting.
10	Power terminals	Power cable are connected.
11	Input/output terminals	Special signal cable, analog output and DO output cables are connected.
12	Communication board terminals	Communication cable is connected (communication board is optional).
13	Fuse holder	Houses a fuse.
14	Relay	For DO2 output
15	Communication board	Mounted if communication synchronization is optionally designated.
16	Arrester board	Board for output mounted if arrester is optionally designated.
17	Frame	Fastens the sensor unit on pipe.
18	Sensor unit	Sends and receives an ultrasonic wave.
19	Stainless steel belt	Fastens the frame on pipe.
20	Spring fixture	Removes the play of stainless steel belt.
21	Scale	For reading the sensor mounting spacing
22	Fastening hole	For positioning and fastening the sensor units
23	Special signal cable	Transmits send/receive signals.

2. SELECTION OF INSTALLATION PLACE

Select an installation place taking into account the following matters from the viewpoint of easiness of maintenance and checkup, instrument life and securing the reliability.

CAUTION

- (1) A place where ambient temperature and humidity are -20 to +50°C and 90% RH or less for flow transmitter (FLR), and -20 to +60°C and 90% RH or less for detector (FLS).
- (2) A place not exposed to direct sunshine nor weathering.
- (3) Sufficient space for daily inspection, wiring, etc.
- (4) A place not subjected to radiated heat from a heating furnace, etc.
- (5) A place not subjected to corrosive atmosphere.
- (6) A place not to be submerged.
- (7) A place free from excessive vibration, dust, dirt and moisture.

2.1. Flow transmitter

Secure at least 100 mm of space between the flow transmitter and nearby wall. Also secure a space of opening the front cover for maintenance. Secure a cable wiring space under the case.

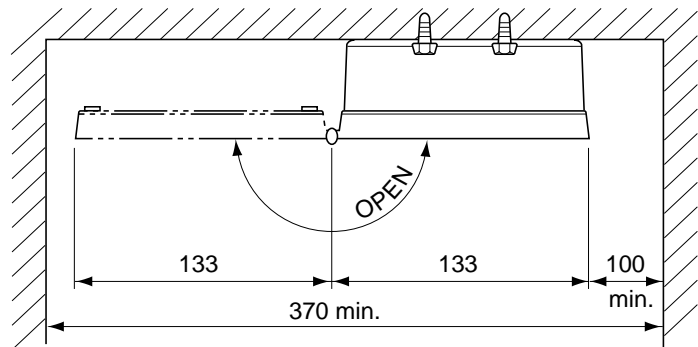

Top view of mounting

2.2. Detector

The measuring accuracy is considerably affected by the detector mounting place, i.e., status of piping for measuring a flow rate. Select a place which clears the condition in section 2.2.1. (Length of straight pipe). Also, sufficiently secure a space for installation and maintenance referring to the following diagram.

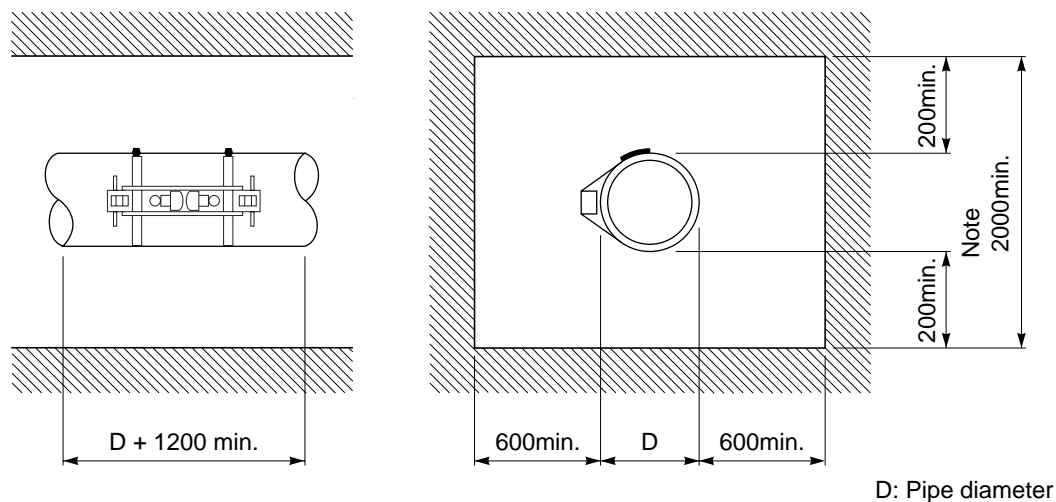

D: Pipe diameter

Necessary space for detector mounting place

2.2.1. Length of straight pipe

The length of upstream and downstream straight pipe of the ultrasonic detector should be long enough to ensure accurate measurements.

(D: Nominal diameter of pipe)

Name	Straight length of upstream piping	Straight length of downstream piping
90° bend		
Tee		
Diffuser		
Reducer		
Valve	<p>Flow controlled upstream</p>	<p>Flow controlled downstream</p>
Pump		

Note: Quoted from JEMIS-032

2.2.2. Mounting posture

The detector can be installed vertical, horizontal or at any posture provided that attention is paid to the following things.

- (1) The piping must completely be filled with fluid when it flows.

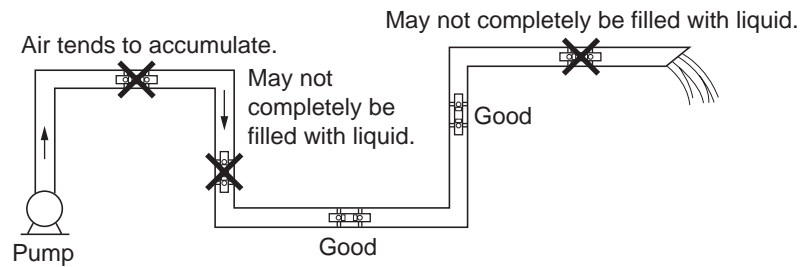

- (2) In case of horizontal piping, mount the detector within $\pm 45^\circ$ from the horizontal plane. Otherwise, the measurement could be impossible if bubbles stay in the upper part of piping or if deposits are accumulated in the lower part of piping. In case of vertical piping, the detector may be mounted at any position on its periphery provided that the flow is upward.

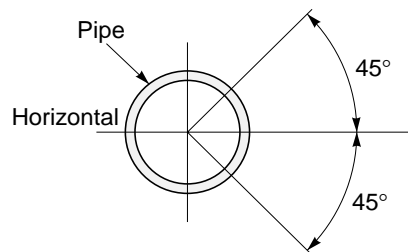

- (3) Do not mount the detector on a distorted part, flange or welding.

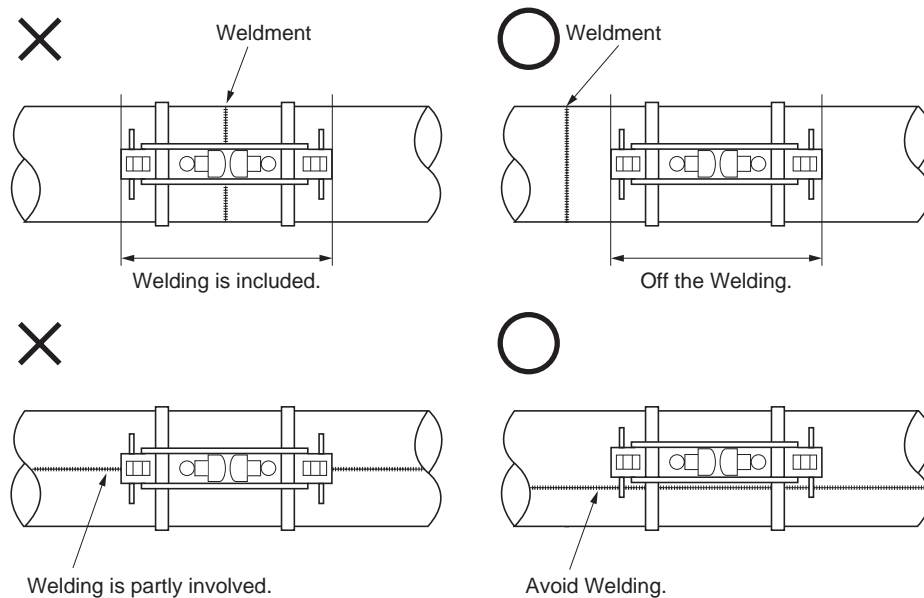

3. INSTALLATION AND PROCEDURE PRIOR TO RUNNING

3.1. Outline of installation procedure

- (1) Select the flow transmitter and detector installation places.
- (2) Install and wire the flow transmitter.
- (3) Turn on power.
- (4) Set the piping parameters, and calculate the sensor unit spacing (* if with parameter setting, check the sensor unit spacing).
- (5) Mount the frame on the piping to measure on.
- (6) Mount the sensor unit.
- (7) Set the measurement range (* unnecessary if with parameter setting and if measurement range is designated).
- (8) Adjust zero point.
- (9) Start a measurement.

3.2. Installation of flow transmitter

The flow transmitter may be mounted on a wall or 2B pipe stand (option).

3.2.1. Wall mounting

For wall mounting, use two M8 bolts.

According to the mounting hole dimensions shown below, drill holes on the wall, and tighten M8 bolts.

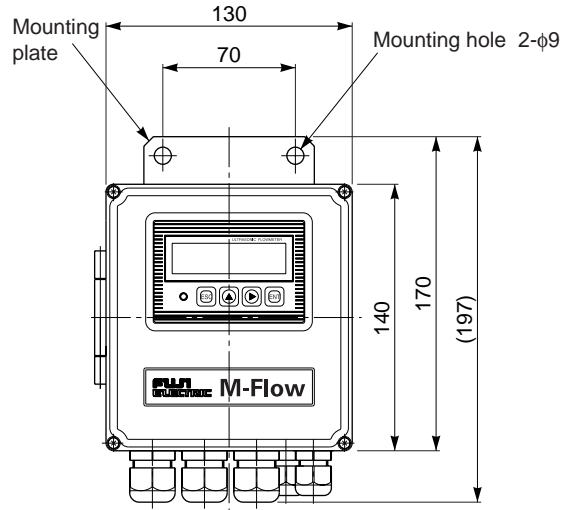

3.2.2. 2B pipe stand mounting



CAUTION

When mounting on 2B pipe, be sure to use a complete set of fixtures (U bolt, support fixture, plain washer, spring washer, wing nut) furnished if optionally designated. Tighten the wing nut by hand. If any support fixture is not used or if the altogether is excessively tightened by tool, the wall mounting fixture may be deformed, thereby breaking the resin case.

Mount the instrument on 2B pipe stand as illustrated below.



3.3. Flow transmitter wiring

3.3.1. Precautions in wiring



CAUTION

- (1) Use a special coaxial cable (FLY3) as a signal cable between the detector (FLS) and flow transmitter (FLR). Do not provide a junction of the signal cable midway.
- (2) Be sure to pass the signal cables through a metal conduit between the detector and flow transmitter. Upstream and downstream signal cables may be put in the same conduit but, to avoid an interference, do not put the power cable together.
- (3) For output signal, use a shield cable, where possible.
- (4) To avoid ingress of noise, do not put the cables together with heavy duty line or the like into the same duct.
- (5) If a ground wire is included in the power cable, connect it to ground as it is.
- (6) A power switch is not provided on the instrument and must be mounted separately.
- (7) Hermetically cover unused wiring ports by furnished caps.

3.3.2. Applied wiring

Use the following cables.

- Power cable : 3 or 2 core cabtyre cable.
Nominal cross-sectional area 0.75 mm² min.
Finish outer diameter Ø11 mm.
- Output signal cable : 2 or, as required, multiple core cabtyre cable.
Finish outer diameter Ø11 mm.
- Detector-flow transmitter cable : Special signal cable by type designation (heat-resisting high-frequency coaxial cable having 50 Ω of characteristics impedance, provided on a side with waterproof BNC connector).
Finish outer diameter Ø5 mm.

3.3.3. Treatment of wiring ports

The outer case of flow transmitter is waterproof (IP65). However, if installed in a humid place, the wiring ports must be made airtight to avoid ingress of moisture, condensation, etc. Be sure to use the waterproof glands furnished with the instrument in order to ensure the waterproof means. Hermetically seal unused glands by furnished caps.



CAUTION

Do not install the instrument where there is a risk of inundation.

3.3.4. Wiring to each terminal

Refer to the following diagram for carrying out wiring.

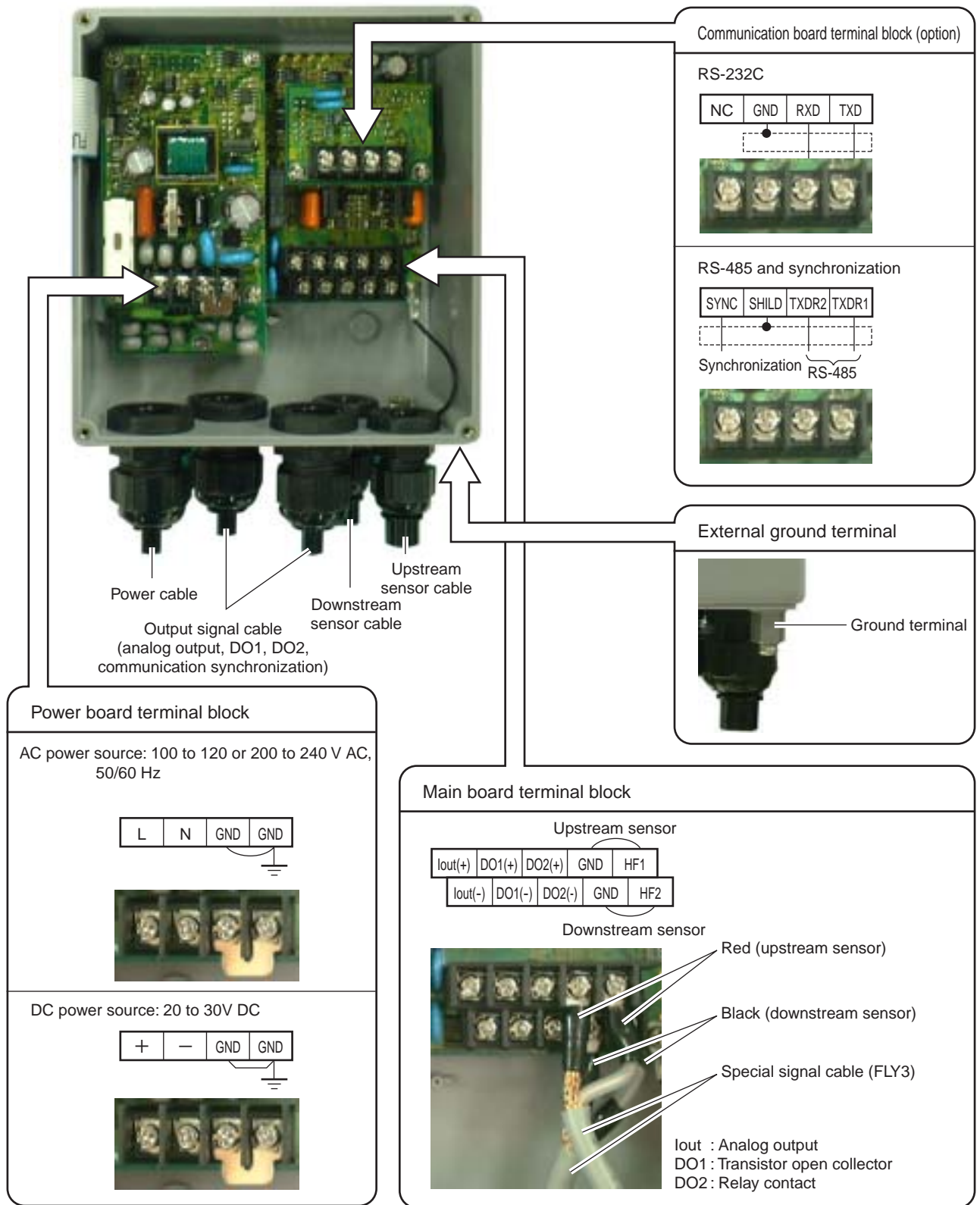

Notes

1. All screws are M3 on the terminal block. Use crimp-style terminals for M3 and whose outer diameter is Ø5.8 or smaller.
2. Be sure to connect to ground the power board terminal block or external ground terminal (class D ground).
3. For output signal, use multiple core cable as required.

3.4. Setting the piping parameters and calculating the sensor unit spacing





















After installation and wiring of the flow transmitter (sensor unit may not be wired), turn on power, input the piping parameters below, and calculate the sensor unit installation spacing. (*When it is provided with parameter setting, the following parameters have already been input. Check the installation spacing in this case.)































Item	Input method	Range or menu
Pipe outer diameter	Value	10 to 300mm
Pipe material	Menu	PVC, PVDF, PEEK, PP, CARBON STEEL, STAINLESS STEEL, COPEER, PIPE S.V (Note 1)
Pipe wall thickness	Value	0.1 to 100mm
Lining presence and material selection	Menu	NO LINING, TAR EPOXY, MORTAR, RUBER, TEFLON, PYREXGLASS, LINING S.V (Note 1)
Lining thickness	Value	0.1 to 10mm
Fluid type	Selection	Water, sea water, FLUID S.V (Note 1)
Kinematic viscosity	Value	0.00E-6m ² /s to 999.999E-6m ² /s (Note 1)

Note 1: In case of material or fluid not included in menus, input its sound velocity and kinematic viscosity of the fluid. The sound velocity can be inputted within the range of 1000 to 3700 m/s for piping or lining material, or 500 to 2500m/s for fluid. (Refer to section 6.6.)

The operating procedure is as follows (from measurement mode).

Note 2: If the parameter protection is set at "PROTECTION ON", change it to "PROTECTION OFF". If ID NO. is set at this time, ID NO. must be inputted.

Keying	LCD indication/comment
 key pressed 3 times.	1st line: [MEASURE SETUP].
 key pressed.	1st line: [SYSTEM UNIT].
 key pressed 3 times.	1st line: [PIPE PARAMETER].
 key pressed.	1st line: [OUTER DIAMETER]. 2nd line: [60.00 mm]. * As selected currently.
 key pressed.	Cursor blinks on 2nd line.
 and  key pressed.	Input the outer diameter of a measurement pipe. As necessary, check the piping data in section 6.6.  : Selects a numeric.  : Shifts the place.
 pressed to enter.	Registered after [**COMPLETE**] is indicated about 1 second on 2nd line.
 key pressed.	1st line: [PIPE MATERIAL]. 2nd line: [PVC] * As selected currently.
 key pressed.	Cursor blinks on 2nd line.
 key pressed to select.	Select the pipe material from menus. If there is no corresponding menu, input the sound velocity of pipe material on sound velocity input screen whose menu is located at the last. As necessary, see piping data in section 6.6.
 key pressed to enter.	Registered after [**COMPLETE**] is indicated about 1 second on 2nd line.
 key pressed.	1st line: [WALL THICKNESS]. 2nd line: [4.50mm] * As selected currently.
 key pressed.	Cursor blinks on 2nd line.
 and  key pressed.	Input the wall thickness of a measurement pipe. As necessary, check the piping data in section 6.6.  : Selects a numeric.  : Shifts the place.
 key pressed to enter.	Registered after [**COMPLETE**] is indicated about 1 second on 2nd line.

Keying	LCD indication/comment
 key pressed.	1st line: [LINING MATERIAL]. 2nd line: [NO LINING]. * As selected currently. If pipe is not lined, press  key to go to selection of next fluid to be measured.
 key pressed.	Cursor blinks on 2nd line.
 key pressed to select.	Select the lining material from menus. If there is no corresponding menu, input the sound velocity of lining material on sound velocity input screen whose menu is located at the last. As necessary, see lining data in section 6.6.
 key pressed to enter.	Registered after [**COMPLETE**] is indicated about 1 second on 2nd line.
 key pressed.	1st line: [LINING THICKNESS]. 2nd line: [2.00 mm]. * As selected currently. Note: Not indicated if lining material is set at [NO LINING].
 key pressed.	Cursor blinks on 2nd line.
 and  key pressed.	Input the lining thickness.  : Selects a numeric.  : Shifts the place.
 key pressed to enter.	Registered after [**COMPLETE**] is indicated about 1 second on 2nd line.
 key pressed.	1st line: [KIND OF FLUID]. 2nd line: [WATER]. * As selected currently.
 key pressed.	Cursor blinks on 2nd line.
 key pressed to select.	Select [WATER] or [SEA WATER]. In case of other fluid, input the sound velocity of fluid on sound velocity input screen whose menu is located at the last. As necessary, see piping data in section 6.6.
 key pressed to enter.	Registered after [**COMPLETE**] is indicated about 1 second on 2nd line.
 key pressed.	1st line: [KINEMATIC VISCO]. 2nd line: [1.0038E-6m ² /s]. * As selected currently. Kinematic viscosity of water is factory set. If fluid to be measured is other than water, input the kinematic viscosity referring to piping data in section 6.6.
 key pressed.	Cursor blinks on 2nd line.
 and  key pressed.	Input the kinematic viscosity.  : Selects a numeric.  : Shifts the place.
 key pressed to enter.	Registered after [**COMPLETE**] is indicated about 1 second on 2nd line.
 key pressed twice.	1st line: [SENSOR TYPE]. 2nd line: [FLS_12]. * As selected currently.
 key pressed.	Cursor blinks on 2nd line.
 key pressed.	Select [FLS_12] or [FLS_22].
 key pressed to enter.	Registered after [**COMPLETE**] is indicated about 1 second on 2nd line.
 key pressed.	1st line: [PIPE PARAMETER]. 2nd line: [S= 16 (48mm)] (*). * Sensor unit spacing calculated by above setting is indicated for sensor unit spacing at detector installation.
 key pressed.	1st line: [MEASURE SETUP]
 key pressed twice.	Measurement mode is resumed.

3.5. Installation of detector

3.5.1. Outline of detector installation procedure

- (1) Treat the surface to mount on the detector.
- (2) Mount the frame.
- (3) Mount the sensor unit.

3.5.2. How to treat the mounting surface

By thinner, sandpaper, etc., eliminate rust, pitch, convex and concave from the pipe surface to mount on the detector by the frame length to occupy.

Note: 1. If jute is wound on the pipe, peel off the jute over the entire periphery by frame length (L) + 200 mm beforehand.

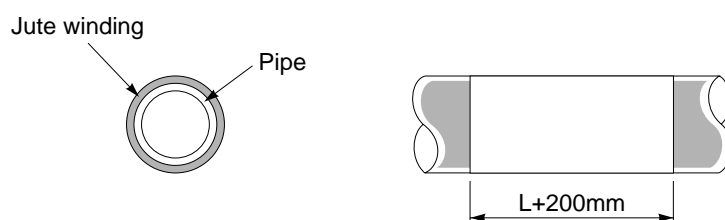

Fig. 3-1 L: Frame length (FLSE1: 240 mm, FLSE2: 360 mm)

3.5.3. How to mount the frame

CAUTION

- Mount the frame carefully not to cut your fingers with stainless steel belt.

- (1) Pass the spring fixture on the stainless steel belt as shown in Fig. 3-2.
- (2) Pass the stainless steel belt through 2 belt holes on the frame as shown in Fig. 3-3.

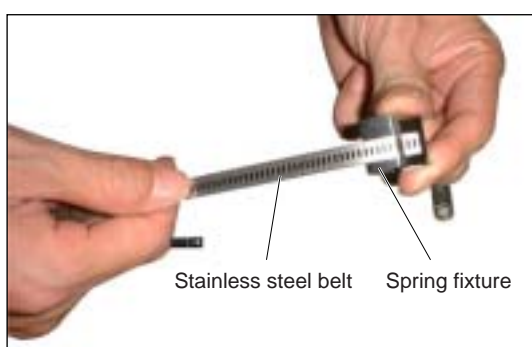

Fig. 3-2

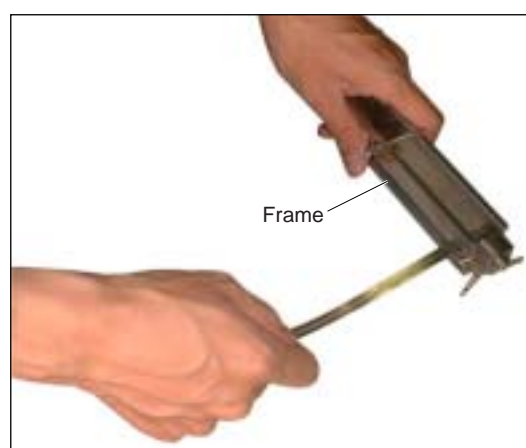

Fig. 3-3

- (3) Make sure the obtained status is as shown in Fig. 3-4.



Fig. 3-4

- (6) Adjust the frame so as to be in parallel with the pipe, put the spring fixture to the side of the frame as shown in Fig. 3-7, and tighten the stainless steel belt so that the frame will tightly be fitted.

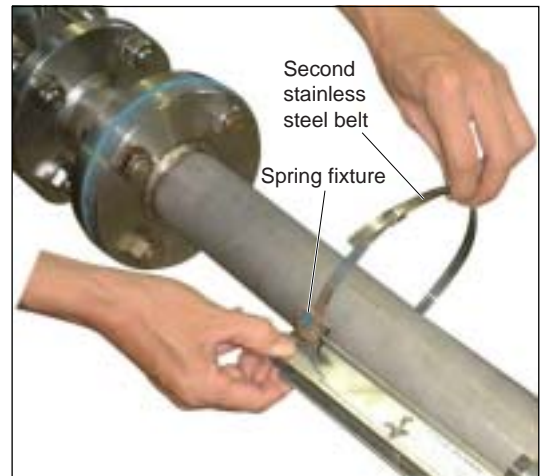

Fig. 3-7

- (4) As shown in Fig. 3-5, apply the frame on the pipe section subjected to a surface treatment.



Fig. 3-5

- (7) After tightening both stainless steel belts, slide the spring fixture to the opposite to the frame as shown in Fig. 3-8.

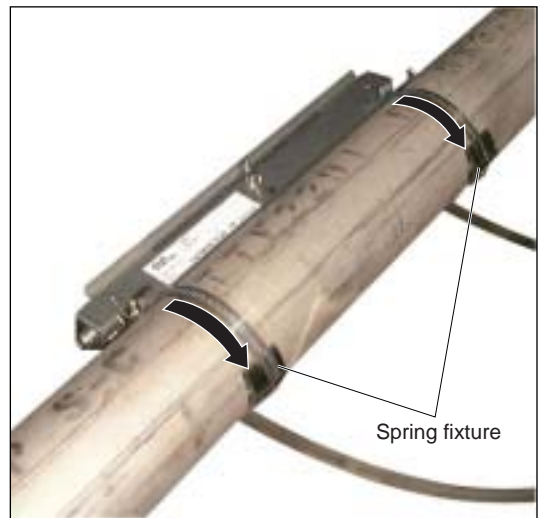

Fig. 3-8

- (5) Temporarily tighten the first stainless steel belt on the pipe as shown in Fig. 3-6.



Fig. 3-6

Note: When removing the frame set to the piping and set it to a different position, use new stainless steel belts.

Mounting on pipe whose diameter is 150A or larger

As shown in Fig. 3-9, connect 2 stainless steel belts.



Fig. 3-9

Tightening tool

Use of an optional tool (Fig. 3-10) facilitates tightening the stainless steel belt (Fig. 3-11).



Fig. 3-10



Fig. 3-11

3.5.4. How to mount the sensor unit

- (1) Mount both sensor units spaced at the SPACING value [S= **] (number of graduations on frame) indicated after setting the piping parameters.

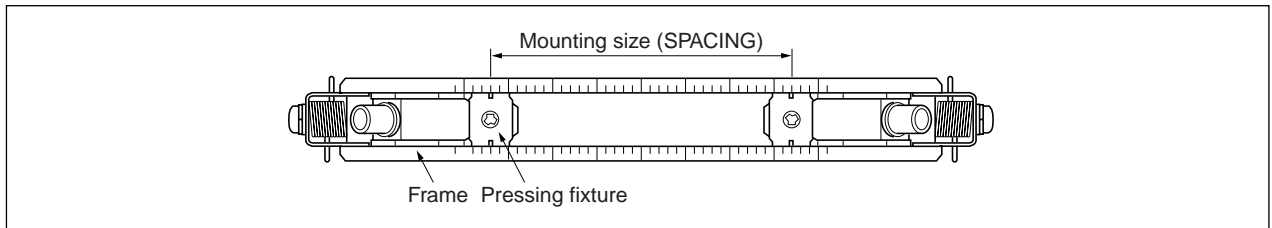

Fig. 3-12

- (2) Before mounting the sensor unit into the frame, sufficiently apply silicone filler (or silicone-free grease ^{Note}) over the entire transmission surface of the sensor unit, taking care not to introduce bubbles (Fig. 3-13).

Note) When using silicon-free grease, pay attention to the fluid temperature range. The fluid temperature range is shown below.

Silicon rubber: -20 to 100°C

Silicon-free grease: 0 to 60°C

When using silicon-free grease, reapply it on the transmission surface of the sensor unit approximately once every 6 months. (Silicon rubber need not be reapplied.)



Fig. 3-13

- (3) Then insert the sensor unit into the frame, align the slit provided on the pressing fixture of the sensor unit with graduations located on the frame top surface (see Fig. 3-14), and press the sensor unit until the fixture claws are engaged with the frame side square holes. Mount both sensor units so as to be roughly symmetrical with respect to the frame (see Fig. 3-15).

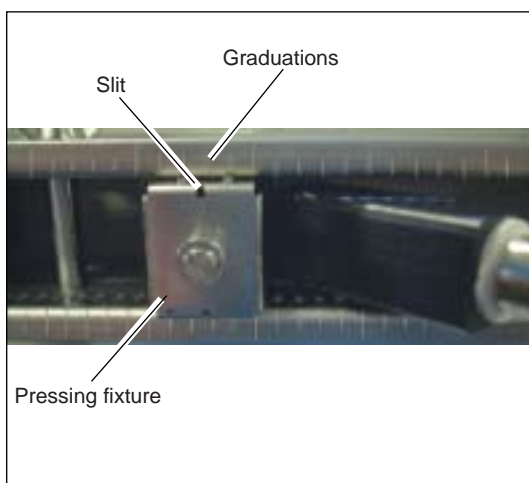

Position of the slit and the graduation
(Magnified view of section A)

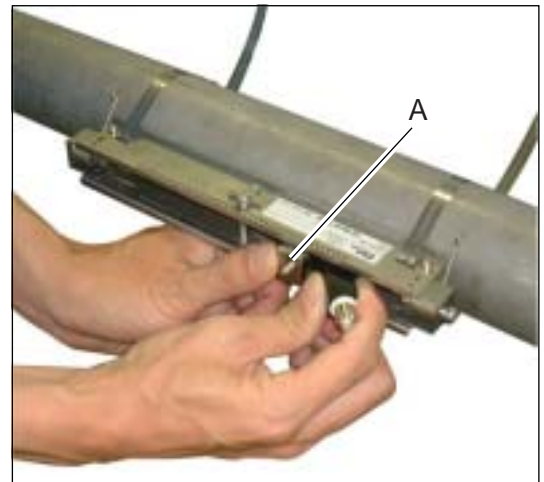

Fig. 3-14



Fig. 3-15

CAUTION

Mount the sensor units so that their BNC connectors will face outward (Fig. 3-16a). If at least one is mounted opposite, the measurement is impossible (Fig. 3-16b, c). The pressing fixture claws must completely be engaged with square holes provided on sides of the frame. Otherwise, the sensor and pipe will not correctly get in contact with each other, whereby the measurement will be impossible.

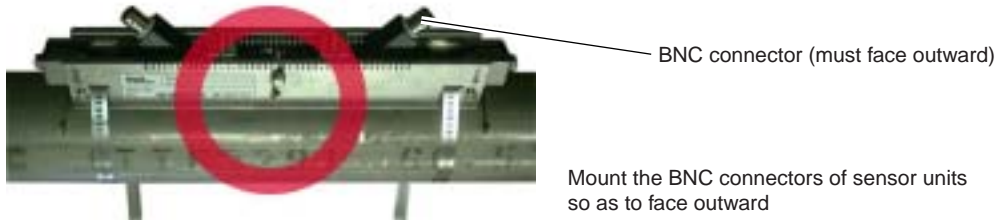

Fig. 3-16

- (4) Engage the signal line with BNC connectors of the sensor units. At this time, do not mistake the upstream and downstream sides for each other. Engage the red BNC connector upstream, and the black BNC connector downstream (see Fig. 3-17).

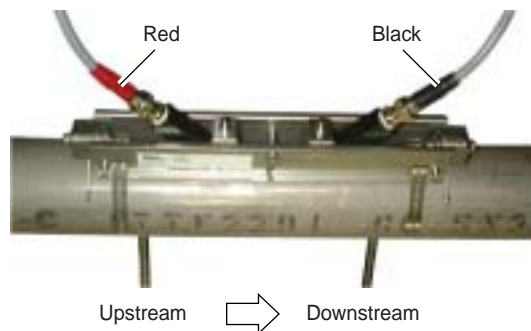

Fig. 3-17

- (5) After connecting the signal line, make sure the red LED on the flow transmitter has turned green. It takes about 10 seconds until the color changes to green. The green color indicates the received signal is normal. The red color indicates the received signal is abnormal. If the LED remains red and does not turn green, examine the **sensor installation status** (sensor spacing, sensor orientation, claw engagement, etc.) and **parameter settings, and check whether the piping is filled with fluid.**



Fig. 3-18

3.5.5. How to remove the sensor unit

If the sensor unit has to be detached from the frame such as after mistaking the space between the sensor units, proceed as follows.

- (1) Loosen the wing bolt located at the middle of frame by 3 to 4 turns (Fig. 3-19).
- (3) Likewise, disengage the opposite claws of the sensor unit pressing fixture from the frame (Fig. 3-21).

Note 1: Do not loosen the wing bolt completely.

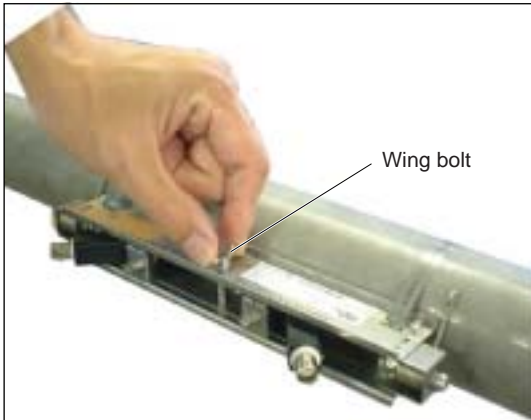

Fig. 3-19

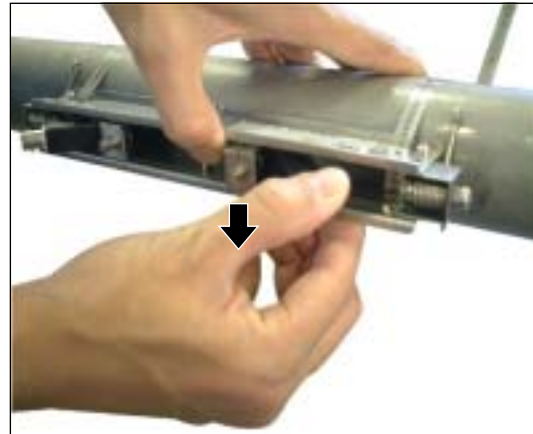

Fig. 3-21

- (2) By hand, hold the frame near the pressing fixture for a sensor unit to remove. Press the resin section which stands out of the frame of sensor unit just enough to open the frame a little (about 1 mm). At this time, the claws of sensor unit fixture are disengaged from the frame (Fig. 3-20).

Note 2: Do not open the frame excessively. Otherwise, it may deform, and an accurate measurement could be impossible or the sensor unit could not be installed.

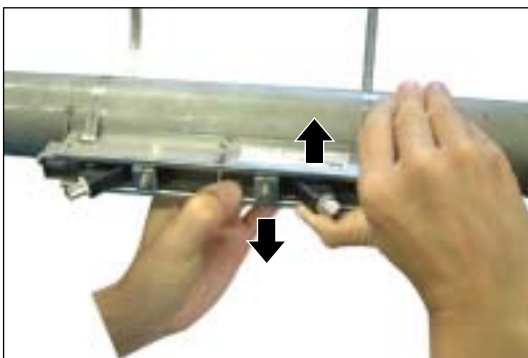

Fig. 3-20

- (4) Making sure claws have been disengaged from both sides, and pull out the sensor unit from the frame (Fig. 3-22).

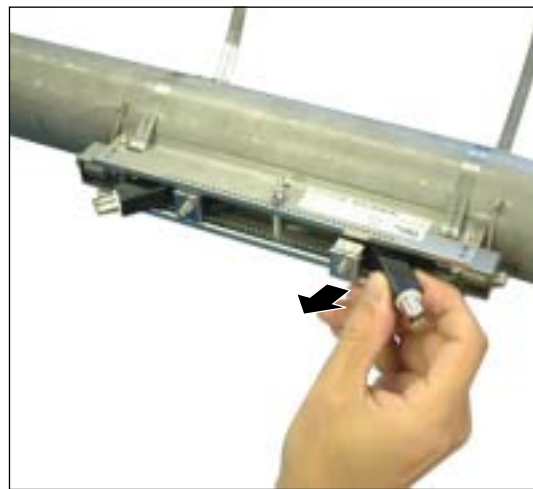

Fig. 3-22

- (5) In the same procedure, remove the other sensor unit also.

Note 3: After removing both sensor units, tighten the loosened wing bolt as before.

3.6. Setting the range and total pulse output

The range is set in the following procedure.

According to a selected range value, an analog output (4-20 mA DC) is delivered.





A pulse is outputted every time the integrated value attains a pulse value.

(Note: Must be carried out after setting the piping parameters in Section 3.4.)

(1) Selecting a unit system: Metric or inch system





Note: Factory set at "Metric system". If you retains it as it is, go to (2) below.

Proceed to the following from the measurement mode.

Keying	LCD indication/comment
 key pressed 3 times.	1st line: [MEASURE SETUP].
 key pressed.	1st line: [SYSTEM UNIT]. 2nd line: [METRIC]. * As selected currently.
 key pressed.	2nd line blinks.
 key pressed.	Select a unit system out of metric system: [METRIC] and inch system: [ENGLISH].
 key pressed.	Registered after [**COMPLETE**] is displayed about 1 sec on 2nd line.

(2) Selecting a flow rate unit: L/s, m3/h or other flow rate unit.







Follows the operation from (1) above.

Keying	LCD indication/comment
 key pressed 1 times.	1st line: [FLOW UNIT], 2nd line: [L/s] * As selected currently.
 key pressed.	2nd line blinks.
 key pressed.	Repeatedly until a desired flow rate unit is selected.
 key pressed.	Registered after [**COMPLETE**] is displayed about 1 sec on 2nd line.

(3) Selecting a total unit: mL, L, m3, or other total unit.

* Must be selected when total indication or total pulse output is used.













Follows the operation from (2) above.

Keying	LCD indication/comment
 key pressed 1 times.	1st line: [TOTAL UNIT], 2nd line: [mL] * As selected currently.
 key pressed.	2nd line blinks.
 key pressed.	Repeatedly until a desired total unit is selected.
 key pressed.	Registered after [**COMPLETE**] is displayed about 1 sec on 2nd line.
 key pressed.	1st line: [MEASURE SETUP]
 key pressed twice.	Resumes the measurement mode.

* Carrying out the operation in (1) to (3) above completes setting of the unit system, flow rate unit and total unit.

(4) Setting the range: To full scale.

Proceed to the following from the measurement mode.

































Keying	LCD indication/comment
 key pressed twice.	1st line: [OUTPUT SETUP].
 key pressed.	1st line: [ZERO ADJUST].
 key pressed 4 times.	1st line: [RANGE]. 2nd line: [FLOW RATE].
 key pressed.	2nd line blinks.
 key pressed to enter.	1st line: [FLOW SPAN-1]. 2nd line: [10.0 L/s]. * As selected currently.
 key pressed.	Cursor blinks on 2nd line.
 and  key pressed.	Until the range is set to a desired value. Setting is available from 0.3 to 10 m/s in terms of velocity. Operate  to select a numeric or point, and  to shift the place.
 key pressed.	Registered after [**COMPLETE**] is displayed about 1 sec on 2nd line.
 key pressed 3 times.	1st line [OUTPUT SETUP].
 key pressed 3 times.	Resumes the measurement mode.

(5) Setting the total pulse and preset value, and starting the total

Set the pulse value, pulse width and preset value.

Then, reset the total value to a preset value (factory set at 0), and start a total.

Proceed to the following from the measurement mode.

Keying	LCD indication/comment
 key pressed twice.	1st line: [OUTPUT SETUP]
 key pressed.	1st line: [ZERO ADJUST]
 key pressed 4 times	1st line: [RANGE], 2nd line: [FLOW RATE]
 key pressed.	2nd line blinks
 key pressed.	2nd line: [TOTAL]
 key pressed.	1st line: [TOTAL MODE], 2nd line [START]
 key pressed.	1st line: [PULSE VALUE], 2nd line: [1mL] * As selected currently.
 key pressed.	Cursor blinks on 2nd line.
 and  key pressed for composing a pulse value.	Compose a desired pulse value. (See 4.5.6.1)  : Selects a numeric or decimal point.  : Shifts the place.
 key pressed.	[**COMPLETE**] appears about 1 second on 2nd line, and then pulse value is registered.
 key pressed.	1st line: [PULSE WIDTH]. 2nd line: [5.0 ms]. * As selected currently.
 key pressed.	Cursor blinks on 2nd line.
 key pressed.	Select 5.0 ms, 10 ms, 50 ms, 100 ms or 200 ms. (See 4.5.6.1)
 key pressed.	[**COMPLETE**] appears about 1 second on 2nd line, and then pulse width is registered.
 key pressed.	1st line: [TOTAL PRESET]. 2nd line: [0 mL]. * As selected currently.
 key pressed.	Cursor blinks.
 and  key pressed.	Compose a desired preset value.  : Selects a numeric or decimal point.  : Shifts the place.
 key pressed.	[**COMPLETE**] appears about 1 second on 2nd line, and then preset value is registered.
 key pressed 3 times.	1st line: [TOTAL MODE]. 2nd line: [START]. * As selected currently.
 key pressed.	2nd line blinks.
 key pressed.	2nd line: [RESET]. * Make sure beforehand total value can be reset.
 key pressed.	[**COMPLETE**] appears about 1 second on 2nd line, and then total value is reset. 2nd line: [STOP]. * Total stops.
 key pressed.	Cursor blinks on 2nd line.
 key pressed twice.	2nd line: [START].
 key pressed.	[**COMPLETE**] appears about 1 second on 2nd line. 2nd line: [START]. * Total starts.
 key pressed 3 times.	1st line: [OUTPUT SETUP].
 key pressed 3 times.	Measurement mode is resumed.







3.7. How to calibrate zero

Completely close the valves upstream and downstream the flow meter before calibrating zero.

Notes

1. If there is no valve or if the fluid flow cannot be stopped, select "CLEAR" when "ZERO ADJUST". In this case, the zero point may slightly be off.
2. If parameters are set at "PROTECTION ON", select "PROTECTION OFF" beforehand.
3. SET ZERO: Retains the current status as zero. CLEAR: Sets the calibration value for zero point to "0".

The following is the zero point adjustment procedure from measurement mode.

Keying	LCD indication/comment
 key pressed twice.	1st line: [OUTPUT SETUP]
 key pressed.	1st line: [ZERO ADJUST]. 2nd line: [CLEAR]. * As selected currently.
 key pressed.	2nd line blinks.
 key pressed.	2nd line: [SET ZERO].
 key pressed to register.	On 2nd line about 1 sec, [**COMPLETE**] is displayed, and zero calibration is performed (Note 4).
 key pressed.	1st line: [OUTPUT SETUP]
 key pressed 3 times.	Measurement mode is resumed.

CAUTION

Note: 4. If [CLEAR] has been selected and executed at this time, a currently stored zero calibration value will be cleared to zero.

4. PARAMETERS



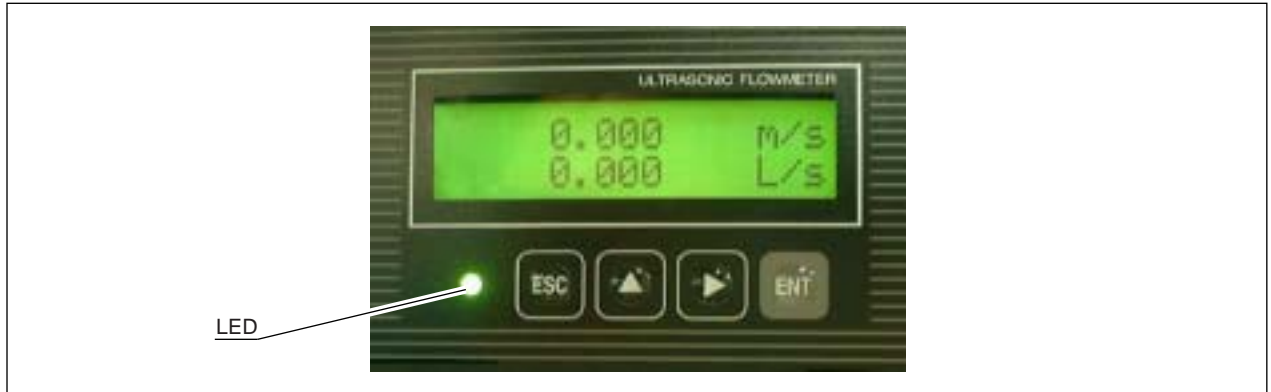

4.1. Description on display/setting section

The display/setting section is illustrated below.



- LED display: Indicates whether the received wave is normal or not.
(Green): Received wave is normal.
(Red): Received wave is abnormal.

Set the parameter by setting switches.

-  ESC Escape key : Returns to a higher hierarchical rank or cancels the setting status.
-  UP key : Selects an item, value or symbol.
-  SHIFT key : Moves the cursor, decimal point, etc.
-  ENT Entry key : Enters a selection or registers a setting.

4.2. Configuration of keys

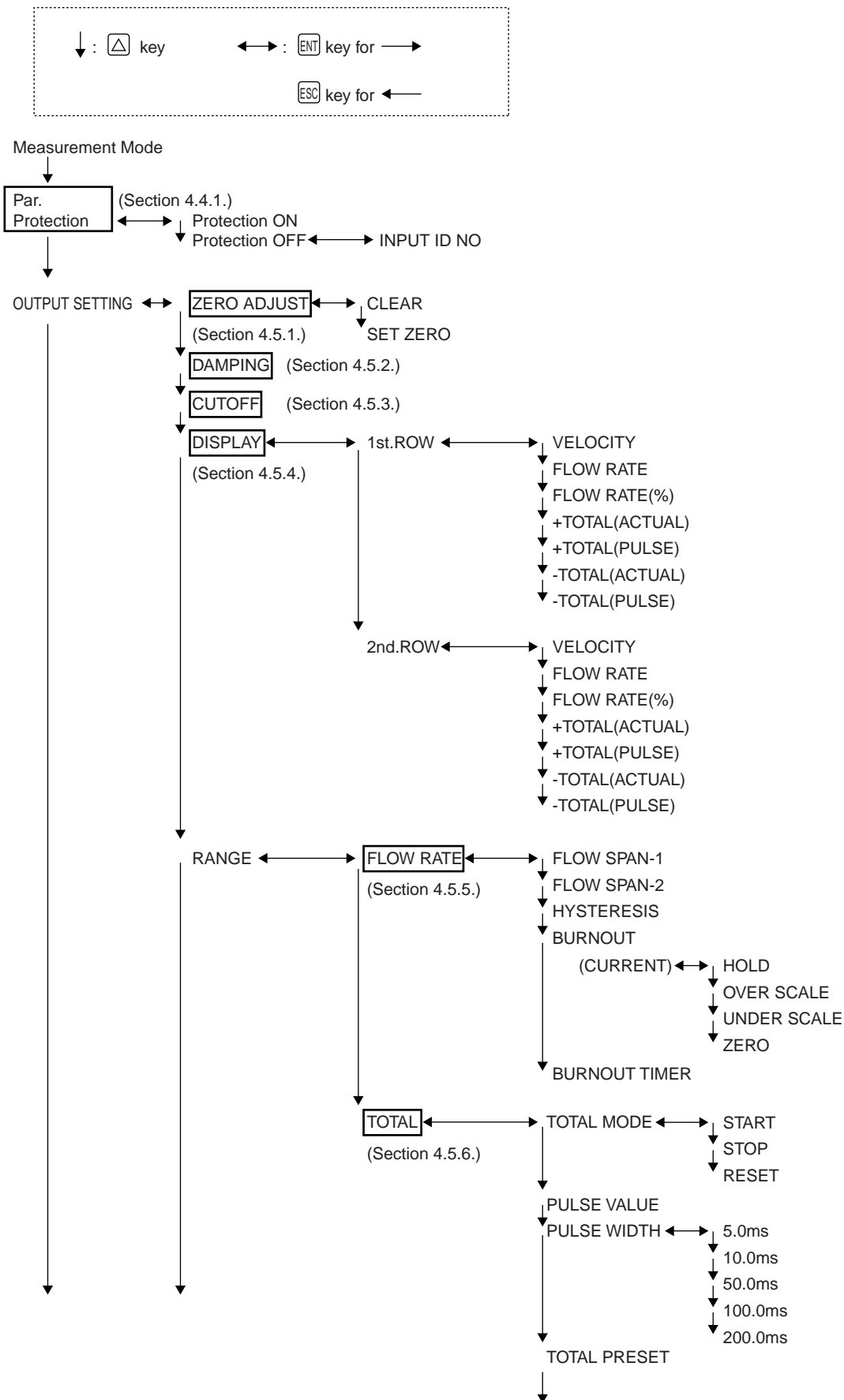

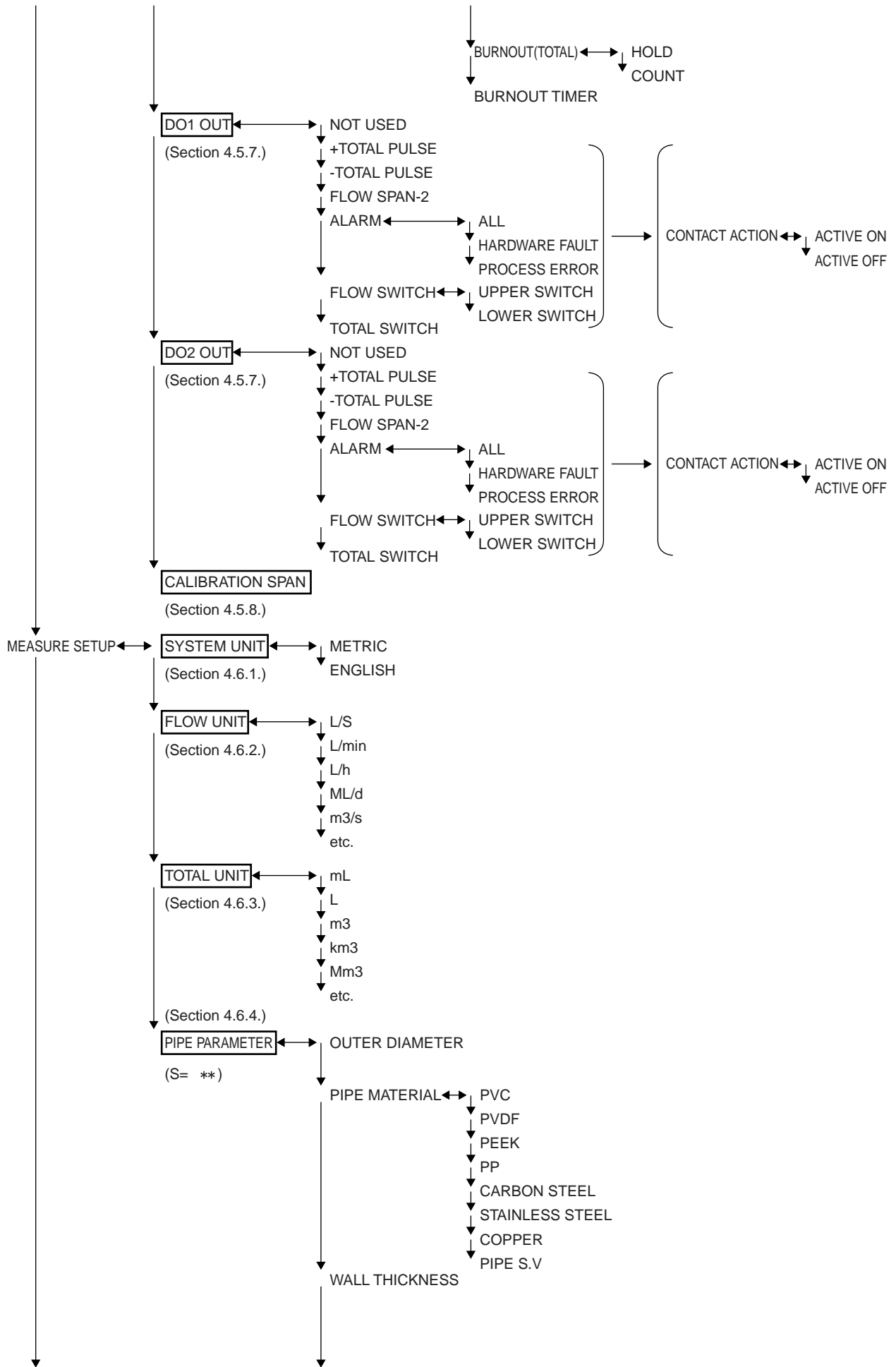

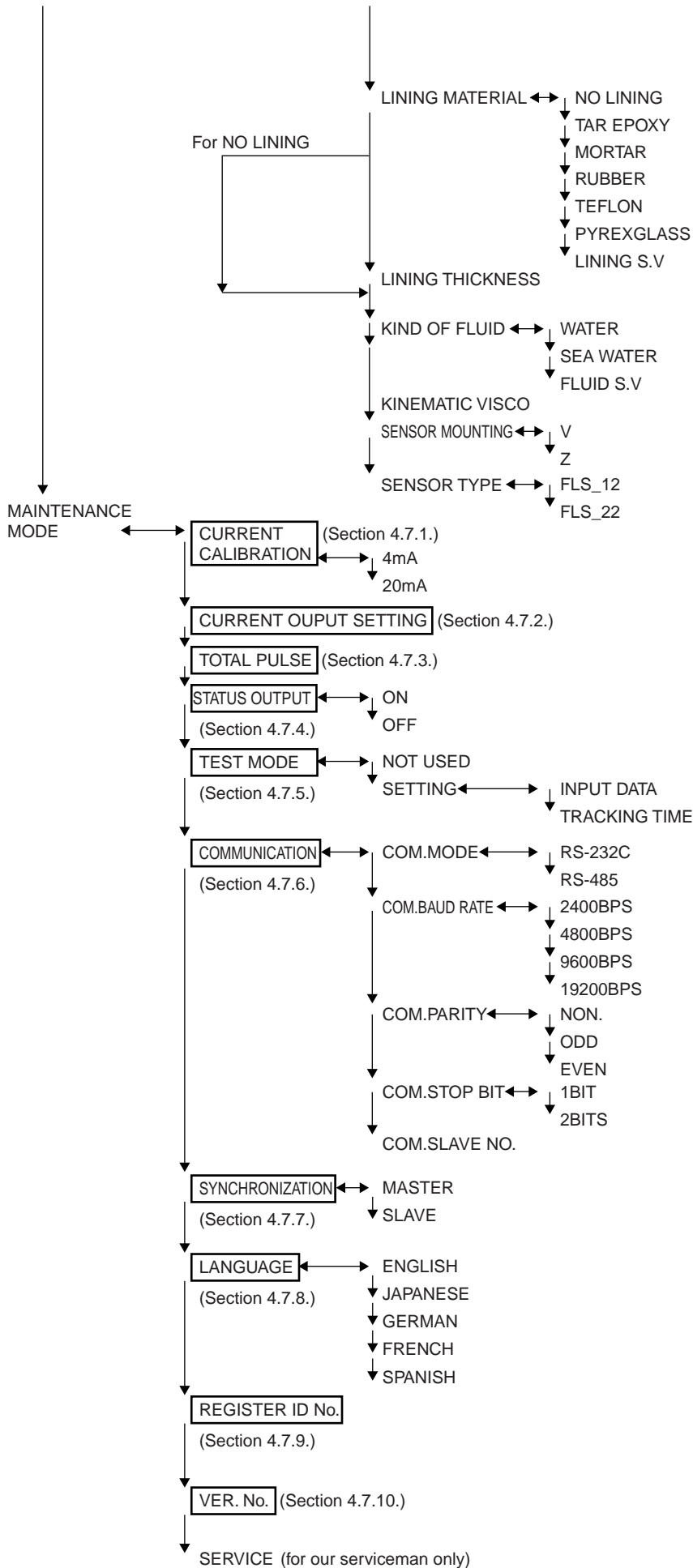

4.3. Initial values of parameters

The following gives factory set values (except when parameter setting is specified).

No.	Setting item	Settable range	Initial value	Settable value	
1	Parameter protection	2 menus	PROTECTION ON	PROTECTION ON, PROTECTION OFF	
2	ID No.	0000 to 9999	0000	_____	
3	Measurement conditions	Unit system	2 menus	Metric	Metric (metric system), English (inch system)
4		Flow rate unit	12 menus (Metric system)	m ³ /h	L/s L/min L/h ML/d m ³ /s m ³ /min m ³ /h Mm ³ /d BBL/s BBL/min BBL/h MBBL/d
			12 menus (Inch system)		gal/s gal/min gal/h Mgal/d ft ³ /s ft ³ /min ft ³ /h Mft ³ /d BBL/s BBL/min BBL/h MBBL/d
5		Total unit	8 menus (Metric system)	m ³	mL L m ³ km ³ Mm ³ mBBL BBL kBBL
			10 menus (Inch system)		gal kgal ft ³ kft ³ Mft ³ mBBL BBL kBBL ACRE-in ACRE-ft
6		Pipe outer diameter	10.00 to 300mm	60.00mm	[mm, in]
7		Pipe material	10 menus Sound velocity: 1000 to 3700 m/s.	PVC	PVC, PVDF, PEEK, PP, CARBON STEEL, STAINLESS STEEL, COPPER, other (sound velocity: _____ [m/s, ft/s])
8		Wall thickness	0.1 to 50.00mm	4.50mm	[mm, in]
9		Lining material	7 menus Sound velocity: 1000 to 3700m/s	No lining	No lining, tar epoxy, mortar, rubber, Teflon, Pyrexglass, other (sound velocity: _____ [m/s, ft/s])
10		Lining thickness	0.01 to 50.00	-	[mm, in]
11		Fluid type	3 menus Sound velocity: 500 to 2500m/s	Water	Water, sea water, other (Sound velocity: _____ [m/s, ft/s])
12		Kinematic viscosity	0.0001 to 999.9999 ×10 ⁻⁶ m ² /s	1.0038×10 ⁻⁶ m ² /s	[×10 ⁻⁶ m ² /s, ft ² /s]
13		Sensor mounting method	2 menus	V	V, Z
14		Sensor type	2 menus	FLS 12	FLS 12, FLS 22
15	Output conditions	Zero adjustment	2 menus	Clear (unadjusted)	Set zero, clear (factory set at clear)
16		Damping	0 to 100sec	5sec	sec
17		Low flow rate cutting	0 to 5 m/s in terms of flow velocity	0.001L/s	[The unit selected at No. 4]
18		Display 1st line contents	7 menus	Flow velocity (m/s)	Flow velocity, flow rate (ACTUAL), flow rate (%), forward total, reverse total, forward total pulse, reverse total pulse
19	Display 1st line decimal point position		00000.000	□□□□□□□□□ (smear a desired place)	
20	Display 2nd line contents	7 menus	Flow rate (m ³ /h)	Flow velocity, flow rate (ACTUAL), flow rate (%), forward total, reverse total, forward total pulse, reverse total pulse	
21	Display 2nd line decimal point position		00000.000	□□□□□□□□□ (smear a desired place)	

No.	Setting item	Settable range	Initial value	Settable value	
22	Analog output	Flow span-1	0.3 to 10 m/s in terms of flow velocity	10.0000m ³ /h	[The unit selected at No. 4]
23		Flow span-2	0.3 to 10 m/s in terms of flow velocity	0.0000m ³ /h	[The unit selected at No. 4]
24		Hysteresis	0 to 10%	5.00%	%
25		Burnout	4 menus	Hold	Hold, upper limit, lower limit, zero
26		Burnout timer	0 to 100sec	10sec	sec
27		Total output	Total action	3 menus	Start
28	Pulse value		0.00001 to 9999999	1m ³	[The unit selected at No. 5]
29	Total pulse width		5 menus	5msec	5, 10, 50, 100, 200msec
30	Burnout		2 menus	Hold	Hold, count
31	Burnout timer		0 to 100sec	10sec	sec
32	Output conditions	DO1 output type	<ul style="list-style-type: none"> ○ 5 output contents menus. ○ 3 alarm menus. ○ Flow switch range 0 to 10 m/s in terms of flow velocity. ○ Total switch range 0.000001 to 99999999 	NOT USED	<input type="checkbox"/> NOT USED <input type="checkbox"/> Flow direction <input type="checkbox"/> Alarm [all, hard, process] <input type="checkbox"/> Flow switches Upper limit [[The unit selected at No. 4]] Lower limit [[The unit selected at No. 4]] <input type="checkbox"/> Total switch [[The unit selected at No. 5]]
33		DO1 output action	2 menus	—	ON, OFF
34		DO2 output type	<ul style="list-style-type: none"> ○ 5 output contents menus. ○ 3 alarm menus. ○ Flow switch range 0 to 10 m/s in terms of flow velocity. ○ Total switch range 0.000001 to 99999999 	NOT USED	<input type="checkbox"/> Unused <input type="checkbox"/> Flow direction <input type="checkbox"/> Alarm [all, hard, process] <input type="checkbox"/> Flow switches Upper limit [[The unit selected at No. 4]] Lower limit [[The unit selected at No. 4]] <input type="checkbox"/> Total switch [[The unit selected at No. 5]]
35		DO output action	2 menus	—	ON, OFF
36		Span calibration	0 to ±200%	100.0%	%

4.4. Parameter protection



















4.4.1. Parameter protection ON/OFF

Description

- Parameters can be protected so that the flow meter settings will not carelessly be changed.
- Parameters can be protected by setting the "ID No." (Note) in the maintenance mode.
Note: 4 digits are factory set at "0000" (see Section 4.7.9).

Settable range : PROTECTION ON : Parameters cannot be changed.
PROTECTION OFF : Parameters can be changed.

For concrete keying, refer to the following examples.

Typical operation	Change the parameter protection from ON to OFF (suppose ID No. is "2234").	
Keying order	Description	Indication
	Pressed in the measurement mode to indicate [PAR. PROTECTION].	PAR. PROTECTION ----- PROTECTION ON
		
	Pressed to blink the 2nd line.	PAR. PROTECTION ----- PROTECTION ON
		
	Pressed to indicate "PROTECTION OFF".	PAR. PROTECTION ----- PROTECTION OFF
		
	Pressed to indicate "INPUT ID NO.".	PAR. PROTECTION ----- ** COMPLETE **
		
		
		
	Pressed to indicate "0000" and blink the cursor. Note: If ID No. is "0000" (as factory set), press  key to release the parameter protection.	INPUT ID NO ----- 0000
		
		
 	Pressed until ID No. [2234] is composed.	INPUT ID NO ----- 2234
		
	Pressed. * If ID No. does not coincide, "INPUT ERROR!" appears, and the input screen is resumed. --- Parameter protection canceled.---	ID NO INPUT ----- ** COMPLETE ** ↓ PAR. PROTECTION ----- PROTECTION OFF

4.5. Output setup mode

4.5.1. Adjusting zero point















Description

- Zero point is calibrated.

Settable range

- CLEAR:** Clears the zero point calibration value to "0". Used in case the flow cannot be stopped when calibrating the zero point.
 Note: 1. Where possible, stop the flow and carry out "SET ZERO" stated below. Otherwise, an error may slip in the zero point.
- SET ZERO:** A point where "SET ZERO" is carried out is regarded as zero. Used for calibrating the zero point upon stopping the flow.
 Note: 2. The flow must completely be stopped. Otherwise, the flowing status is regarded as zero, thereby causing an error.

For concrete keying, refer to the typical operation indicated below. Set the parameter protection to OFF beforehand (Section 4.4.1).

Typical operation	Completely fill the piping, close the upstream and downstream valves, and proceed to zero point calibration.	
Keying order	Description	Indication
           	<p>Pressed twice to indicate "OUTPUT SETUP".</p> <p>Pressed twice to indicate "ZERO ADJUST" and blink the cursor.</p> <p>Pressed to select "SET ZERO".</p> <p>Pressed to execute "SET ZERO". * Be sure to completely stop the flow beforehand.</p> <p style="text-align: center;">--- Zero point calibrated.---</p> <p>Press  key once, and  key 3 times to resume the measurement mode.</p>	<div style="border: 1px solid black; padding: 2px; text-align: center;">OUTPUT SETUP</div> <div style="border: 1px solid black; padding: 2px; text-align: center;">ZERO ADJUST CLEAR</div> <div style="border: 1px solid black; padding: 2px; text-align: center;">ZERO ADJUST SET ZERO</div> <div style="border: 1px solid black; padding: 2px; text-align: center;">ZERO ADJUST ** COMPLETE **</div> <p style="text-align: center;">↓</p> <div style="border: 1px solid black; padding: 2px; text-align: center;">ZERO ADJUST SET ZERO</div> <div style="border: 1px solid black; padding: 2px; text-align: center;">0.000 m/s 0.000 m3/h</div>

4.5.2. Setting the damping

Description



















- Used for attenuating the variation of measured value.
A time constant is set (response time of about 63%).

Settable range: 0 to 100 sec in 1 sec steps.

Note: In case you set to 0 sec, response time become as below.

- System cycle: 0.2 sec
- Dead time: less than 0.2 sec
- Time constant: 0.1 sec

For concrete keying, refer to the typical operation indicated below. Set the parameter protection to OFF beforehand (Section 4.4.1).

Typical operation	Change the damping from 5 to 20 sec.	
Keying order	Description	Indication
	Pressed twice to indicate "OUTPUT SETUP".	OUTPUT SETUP
		
	Pressed to indicate "ZERO ADJUST".	ZERO ADJUST SET ZERO
		
	Pressed to indicate "DAMPING".	DAMPING
		5 sec
	Pressed to blink the cursor.	DAMPING 005 sec
		
 	Operated to select "20".	DAMPING 020 sec
		
	Pressed to register it.	DAMPING ** COMPLETE **
		
		
		
	--- Damping registered.---	DAMPING 20 sec
 	Press  key once, and  key 3 times to resume the measurement mode.	0.000 m/s 0.000 m3/h

4.5.3. Setting the low flow rate cutting

Description

- The output can be cut when the flow rate is too small.
- Effective for indication, analog output (4-20 mA) and total operation.

Settable range: 0 to 5 [m/s] in terms of flow velocity (factory set at 0.001 [L/s]).

Notes

1. As required, set the low flow rate cut because the flow meter may read a flow rate when the fluid in the piping is moving on account of convection, etc. even if the valves are closed.
2. The flow rate unit is as selected by "FLOW UNIT" in "MEASURE SETUP" (see Section 4.6.2).

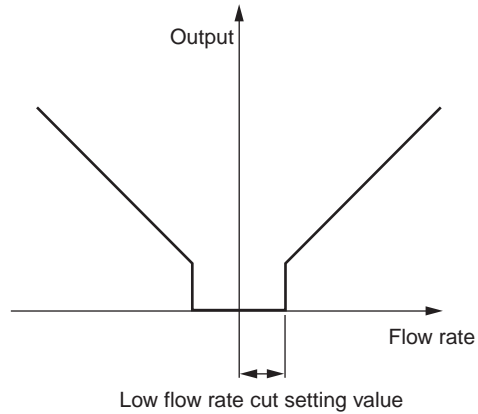

For concrete keying, refer to the typical operation indicated below. Set the parameter protection to OFF beforehand (Section 4.4.1).

























Typical operation	Set the low flow rate cut point to 0.5 [m ³ /h].	
Keying order	Description	Indication
△	Pressed twice to indicate "OUTPUT SETUP".	OUTPUT SETUP
▼		
ENT	Pressed to indicate "ZERO ADJUST".	ZERO ADJUST SET ZERO
▼		
△	Pressed twice to indicate "CUTOFF".	CUTOFF 0.0010 m3/h
▼		
ENT	Pressed to blink the cursor.	CUTOFF 0000.0010 m3/h
▼		
△ ▶	Operated to compose "0.5".	CUTOFF 0000.5000 m3/h
▼		
ENT	Pressed to register it.	CUTOFF ** COMPLETE **
▼		
▼		
▼	--- CUTOFF registered.---	CUTOFF 0.500 m3/h
▼		
ESC △	Press ESC key once, and △ key 3 times to resume the measurement mode.	0.000 m/s 0.000 m3/h

4.5.4. Setting the LCD indication

Description

- Flow velocity indication
 Selectable flow velocity units : m/s (if SYSTEM UNIT was set to METRIC)
 : ft/s (if SYSTEM UNIT was set to ENGLISH) (Section 4.6.1).
 Note: 1. The decimal point position is fixed.
- Flow rate indication
 Selectable flow rate indications: Actual value reading, % reading.
 Note: 2. The indication unit is as selected by FLOW UNIT (Section 4.6.2).
- Total indication
 Selectable total indications: Actual total value reading (forward/reverse flow), total pulse count (forward/reverse flow).
 Note: 3. When total unit is changed, perform "RESET". (Refer to item 4.5.6)
 Conversion of total memory contents due to unit change is not carried out.
- How to validate the indication
 Set the DISPLAY setting mode to 1st. ROW (for indication on 1st line) or 2nd. ROW (for indication on 2nd line), and further select indication contents.

For concrete keying, refer to the typical operation indicated below. Set the parameter protection to OFF beforehand (Section 4.4.1).

Typical operation	Set the LCD indication on 1st line to % reading.	
Keying order	Description	Indication
	Pressed twice to indicate "OUTPUT SETUP".	OUTPUT SETUP
		
	Pressed to indicate "ZERO ADJUST".	ZERO ADJUST
		CLEAR
	Pressed 3 times to indicate "DISPLAY".	DISPLAY
		1ST. ROW
	Pressed to blink the cursor.	DISPLAY
		1ST. ROW
	Pressed again to select "1st. ROW".	1ST. ROW
		VELOCITY
	Pressed twice to select "FLOW RATE (%)".	1ST. ROW
		FLOW RATE (%)
	Pressed to enter "FLOW RATE (%)" and indicate "1st. ROW DIGIT".	1ST. ROW DIGIT
		****. **
	Pressed to shift the decimal point position to next place.	1ST. ROW DIGIT
		*****. *
	Pressed to register it.	1ST. ROW DIGIT
		** COMPLETE **
		↓
		1ST. ROW
	--- FLOW RATE (%) indication validated.---	FLOW RATE (%)
	Press  key 2 times, and  key 3 times to resume the measurement mode	0.0 %
		0.000 m3/h

4.5.5. Setting the flow rate and flow velocity range

4.5.5.1. Setting the flow rate range (single range FLOW SPAN-1)

Description

- The range (full scale) of flow rate to measure is set.
 - * The analog output (4-20 mA) corresponds to the range setting.
- After changing the range, adjust zero point (see Section 4.5.1.).
- Settable range: 0.3 to 10 [m/s] in terms of flow velocity in piping.
 - * Piping parameters and FLOW UNIT must be set beforehand.
 - * If a value beyond the settable range is inputted, "INPUT ERROR" appears and then last setting is resumed.
 - * If "piping parameters" or "FLOW UNIT" has been changed after setting the range, recommence the range setting.

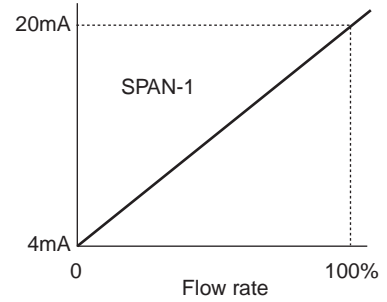

Note: 1. The flow rate unit is as selected by "FLOW UNIT" in the "MEASURE SETUP" mode (see Section 4.6.2.).

For concrete keying, refer to the typical operation indicated below. Set the parameter protection to OFF beforehand (Section 4.4.1).

Typical operation	Set the "FLOW SPAN-1" to 60 m ³ /h. * Set the piping parameters and "FLOW UNIT" beforehand.	
Keying order	Description	Indication
	Pressed twice to indicate "OUTPUT SETUP".	OUTPUT SETUP
	Pressed to select the ZERO ADJUST mode.	ZERO ADJUST CLEAR
	Pressed 4 times to indicate "RANGE".	RANGE FLOW RATE
	Pressed to blink the cursor.	RANGE FLOW RATE
	Pressed to indicate "FLOW SPAN-1".	FLOW SPAN-1 0000010.0 m3/h
	Pressed to blink the cursor.	FLOW SPAN-1 0000010.0 m3/h
	Pressed repeatedly until the cursor is positioned at "1".	FLOW SPAN-1 0000010.0 m3/h
	Pressed 5 times to select "6". Note: To change the decimal point position, align the cursor with a place to change to and operate key likewise.	FLOW SPAN-1 0000060.0 m3/h
	Pressed to register it.	FLOW SPAN-1 ** COMPLETE **
	--- SPAN-1 registered.---	FLOW SPAN-1 60.0 m3/h
	Press key 3 times and press key 3 times to resume the measurement mode.	0.000 m/s 0.000 m3/h

4.5.5.2. Setting forward automatic 2 ranges

Description

- The function carries out a measurement while changing over the range according to the flow rate.
- The current output changes with the action range as illustrated on the right.
- The hysteresis can be set to between 0 and 10% of the smaller range.
- Upon setting DO1 or DO2 to "FLOW SPAN-2", a contact outputs "SPAN-2" action. Select [ACTIVE ON] or [ACTIVE OFF] separately (see Section 4.5.7.3.).
- After changing the range value, adjust zero point (see Section 4.5.1.).
- Settable range: 0.3 to 10 [m/s] in terms of flow velocity in piping for any of SPAN-1 and SPAN-2.
 - * The piping parameters and FLOW UNIT must be set beforehand.
 - * If a value beyond the settable range is inputted, "INPUT ERROR" appears and then last setting is resumed.
 - * If "FLOW UNIT" has been changed after setting the range, recommence the range setting.
 - * When FLOW SPAN-2 is not used (in the case of single range), set "0" to FLOW SPAN-2.

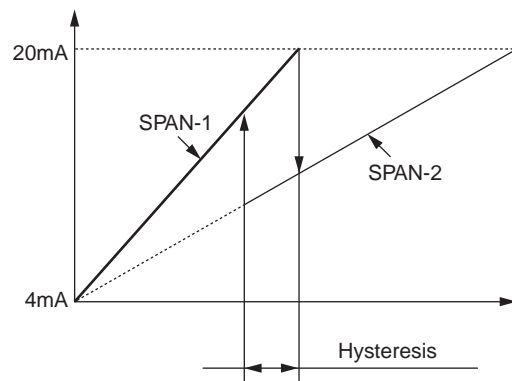

Note: 1. The flow rate unit is as selected by "FLOW UNIT". Before range setting, set the "FLOW UNIT" (see Section 4.6.2.).

For concrete keying, refer to the typical operation indicated below. Set the parameter protection to OFF beforehand (Section 4.4.1).

Typical operation	Set "FLOW SPAN-1" to 10 [m ³ /h], "FLOW SPAN-2" to 60 [m ³ /h], and "HYSTERESIS" to 7%. * Set the piping parameters and "FLOW UNIT" beforehand.	
Keying order	Description	Indication
△	Pressed twice to indicate "OUTPUT SETUP".	OUTPUT SETUP
▼		
ENT	Pressed to indicate "ZERO ADJUST".	ZERO ADJUST CLEAR
▼		
△	Pressed 4 times to indicate "RANGE".	RANGE FLOW RATE
▼		
ENT	Pressed to blink the cursor.	RANGE FLOW RATE
▼		
ENT	Pressed to indicate "FLOW SPAN-1".	FLOW SPAN-1 20.0000 m3/h
▼		
ENT	Pressed to blink the cursor on 2nd line.	FLOW SPAN-1 0020.0000 m3/h
▼		
▶	Pressed repeatedly until the cursor is positioned at "2".	FLOW SPAN-1 0020.0000 m3/h
▼		
△	Pressed repeatedly until "1" appears. Note: To change the decimal point position, align the cursor with a place to change to, and press △ key likewise.	FLOW SPAN-1 0010.0000 m3/h
▼		
ENT	Pressed to register it.	FLOW SPAN-1 ** COMPLETE **
▼		↓

▼	---	FLOW SPAN-1 registered.---	FLOW SPAN-1 10.0000 m3/h
▼			
▼			
▲	Pressed to indicate "FLOW SPAN-2".		FLOW SAPN-2 0.0000 m3/h
▼			
ENT	Pressed to blink the cursor.		FLOW SAPN-2 0000.0000 m3/h
▼			
▶	Pressed twice to move the cursor.		FLOW SPAN-2 0000.0000 m3/h
▼			
▲	Pressed 6 times to select "6".		FLOW SPAN-2 0060.0000 m3/h
▼			
ENT	Pressed to register it.		FLOW SPAN-2 ** COMPLETE **
▼			↓
▼		---	FLOW SPAN-2 60.0000 m3/h
▼			
▲	Pressed to indicate "HYSTERESIS".		HYSTERESIS 5.00 %
▼			
ENT	Pressed to blink the cursor.		HYSTERESIS 05.00 %
▼			
▶	Pressed to move the cursor.		HYSTERESIS 05.00 %
▼			
▲	Pressed twice to select "7".		HYSTERRSIS 07.00 %
▼			
ENT	Pressed to register it.		HYSTERESIS ** COMPLETE **
▼			↓
▼		---	HYSTERESIS 7.00 %
▼			
ESC ▲	Press ESC key 3 times, and press ▲ key 3 times to resume the measurement mode.		0.000 m/s 0.000 m3/h

4.5.5.3. Setting forward/reverse automatic 2 ranges

Description

- The function measures the flow rate of either forward or reverse flow while changing over the range corresponding to the flow direction.
- The current output changes with the action range as illustrated on the right.
- The hysteresis can be set to between 0 and 10% of the action range.
- Upon setting DO1 or DO2 to "FLOW SPAN-2", a contact outputs "SPAN-2" action. Select [ACTIVE ON] or [ACTIVE OFF] separately (see Section 4.5.7.3.).
- After changing the range value, adjust zero point (see Section 4.5.1.).
- Settable range: ± 0.3 to 10 [m/s] in terms of flow velocity in piping for any of SPAN-1 and SPAN-2.
 - * The piping parameters and FLOW UNIT must be set beforehand.
 - * If a value beyond the settable range is inputted, "INPUT ERROR" appears and then last setting is resumed.
 - * If "FLOW UNIT" has been changed after setting the range, recommence the range setting.

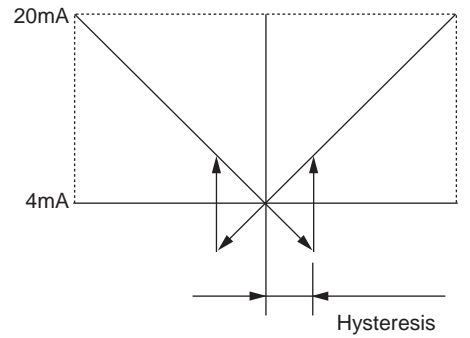

Note: 1. The flow rate unit is as selected by "FLOW UNIT". Before range setting, set the "FLOW UNIT" (see Section 4.6.2.).

For concrete keying, refer to the typical operation indicated below. Set the parameter protection to OFF beforehand (Section 4.4.1).

Typical operation	Set "FLOW SPAN-1" to 20 [m ³ /h], "FLOW SPAN-2" to -10 [m ³ /h], and "HYSTERESIS" to 7%. * Set the piping parameters and "FLOW UNIT" beforehand.	
Keying order	Description	Indication
	Pressed twice to indicate "OUTPUT SETUP".	OUTPUT SETUP
	Pressed to indicate "ZERO ADJUST".	ZERO ADJUST CLEAR
	Pressed 4 times to indicate "RANGE".	RANGE FLOW RATE
	Pressed to blink the cursor.	RANGE FLOW RATE
	Pressed to indicate "FLOW SPAN-1".	FLOW SPAN-1 50.0000 m3/h
	Pressed to blink the cursor.	FLOW SPAN-1 0050.0000 m3/h
	Pressed repeatedly until the cursor is positioned at "5".	FLOW SPAN-1 0050.0000 m3/h
	Pressed repeatedly until "2" appears. Note: To change the decimal point position, align the cursor with a place to change to, and press key likewise	FLOW SPAN-1 0020.0000 m3/h
	Pressed to register it.	FLOW SPAN-1 ** COMPLETE **
		↓

▼	---	FLOW SPAN-1 registered.---	FLOW SPAN-1 ----- 20.0000 m3/h
▼			
▼			
▲	Pressed to indicate "FLOW SPAN-2".		FLOW SAPN-2 ----- 0.0000 m3/h
▼			
ENT	Pressed to blink the cursor.		FLOW SAPN-2 ----- 0000.0000 m3/h
▼			
▲	Pressed repeatedly until "-" appears on 1st place.		FLOW SPAN-2 ----- -000.0000 m3/h
▼			
▶	Pressed twice to move the cursor.		FLOW SPAN-2 ----- -000.0000 m3/h
▼			
▲	Pressed to select "1".		FLOW SPAN-2 ----- -010.0000 m3/h
▼			
ENT	Pressed to register it.		FLOW SPAN-2 ----- ** COMPLETE **
▼			↓
▼		---	FLOW SPAN-2 ----- -10.0000 m3/h
▼			
▲	Pressed to indicate "HYSTERESIS".		HYSTERESIS ----- 5.00 %
▼			
ENT	Pressed to blink the cursor.		HYSTERESIS ----- 05.00 %
▼			
▶	Pressed to move the cursor.		HYSTERESIS ----- 05.00 %
▼			
▲	Pressed twice to select "7".		HYSTERRSIS ----- 07.00 %
▼			
ENT	Pressed to register it.		HYSTERESIS ----- ** COMPLETE **
▼			↓
▼		---	HYSTERESIS ----- 7.00 %
▼			
ESC ▲	Press ESC key 3 times, and press ▲ key 3 times to resume the measurement mode.		0.000 m/s ----- 0.000 m3/h

4.5.5.4. How to set analog output at error (BURNOUT)

Description

- Determine how to set the analog output when received wave error, etc. due to device error, accidental drain of piping or ingress of bubbles.
- Settable ranges
 - (1) Analog output (4-20 mA) at error
 - HOLD (factory set): Outputs a current intensity preceding the error.
 - OVER SCALE: Outputs 23.2 mA.
 - UNDER SCALE: Outputs 0.8 mA.
 - ZERO: Outputs 4 mA.
 - (2) BURNOUT TIMER (time from error detection to BURNOUT processing) 0 to 100 seconds (factory set at 10 sec).

For concrete keying, refer to the typical operation indicated below. Set the parameter protection to OFF beforehand (Section 4.4.1).

Typical operation	Set the BURNOUT to "OVER SCALE". Set the BURNOUT TIMER to "20 sec". * Set the piping parameters and "FLOW UNIT" beforehand.	
Keying order	Description	Indication
△	Pressed twice to indicate "OUTPUT SETUP".	OUTPUT SETUP
▼		
ENT	Pressed to indicate "ZERO ADJUST".	ZERO ADJUST CLEAR
▼		
△	Pressed 4 times to indicate "RANGE".	RANGE FLOW RATE
▼		
ENT	Pressed to blink the cursor.	RANGE FLOW RATE
▼		
ENT	Pressed to indicate "FLOW SPAN-1".	FLOW SPAN-1 20.0000 m3/h
▼		
△	Pressed 3 times to indicate the BURNOUT (CURRENT).	BURNOUT (CURRENT) HOLD
▼		
ENT	Pressed to blink the 2nd line.	BURNOUT (CURRENT) HOLD
▼		
△	Pressed to indicate "OVER SCALE".	BURNOUT (CURRENT) OVER SCALE
▼		
ENT	Pressed to register it.	BURNOUT (CURRENT) ** COMPLETE **
▼		
▼		
▼	--- "OVER SCALE" registered.---	BURNOUT (CURRENT) OVER SCALE
▼		
△	Pressed to indicate "BURNOUT TIMER".	BURNOUT TIMER 10 s
▼		
ENT	Pressed to blink the cursor.	BURNOUT TIMER 010 s
▼		

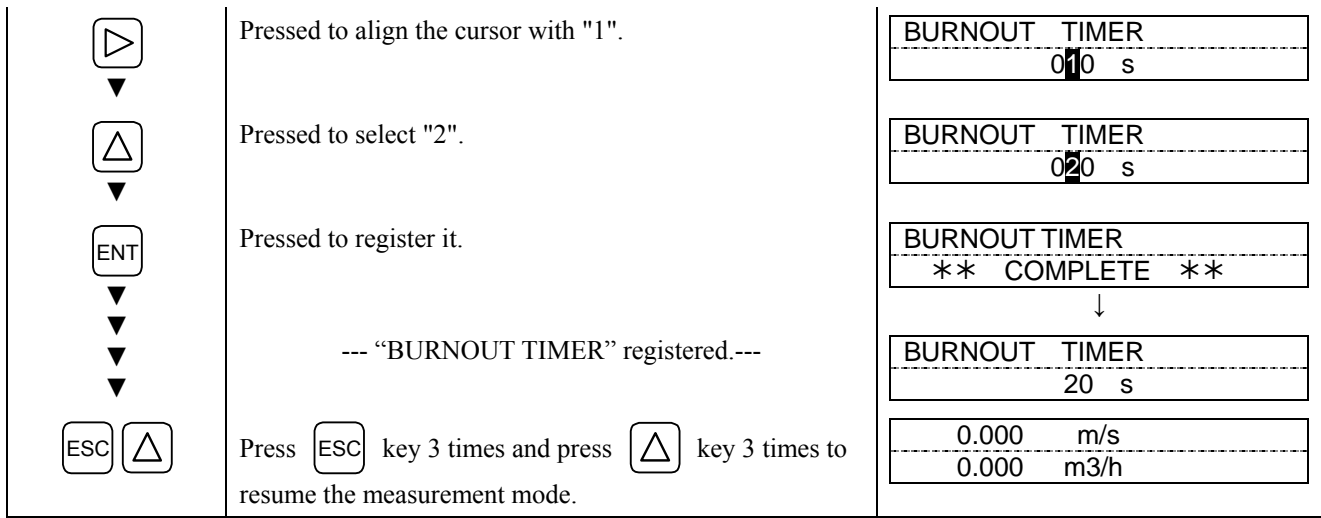

4.5.6. Setting the total

4.5.6.1. Setting the total pulse (pulse value, pulse width)

Description

- Set for total a process variable (flow rate) by total meter, etc. according to total pulse output.
- Pulse value: Total amount (volume) per pulse.
A pulse is outputted when the total volume has attained an amount set by the pulse value, and adds to the total pulse count (in case of total pulse indication).
Settable range: 0.000001 to 99999999.
* Set the total unit before setting the pulse value (see Section 4.6.3.).
- Pulse width: Width of total pulse output.
Select a pulse width according to a corresponding total meter out of menus.
Settable range: 5 ms, 10 ms, 50 ms, 100 ms, 200 ms.
Note: If the output is through DO2 (relay contact), select 50 ms or longer (see Section 4.5.7.).
- Restrictions in the setup
Output of total pulses involves the following restrictions depending on the DO output port (DO1, DO2).

DO output port	Pulse output frequency range (at the time of full scale flow rate)	Pulse width
DO1: Transistor open collector	1 pulse per day to 100 pulses per second	5ms, 10ms, 50ms, 100ms, 200ms
DO2: Relay contact	1 pulse per day to 1 pulse per second	50ms, 100ms, 200ms

Furthermore, the maximum output frequency is restricted also by the setup of the pulse width.

Therefore, set the pulse width and pulse value so that both of condition 1 and condition 2 indicated below are satisfied.

Correct motions may not occur, if any setup that does not satisfy both of condition 1 and condition 2 is made.

Condition 1:

$$\frac{1}{86400} [\text{Hz}] \leq \frac{\text{FLOW SPAN-1}^{\text{Note 1}} [\text{m}^3/\text{s}]}{\text{PULSE VALUE} [\text{m}^3]} \leq \begin{matrix} 100 [\text{Hz}] & (\text{case of DO1}) \\ 1 [\text{Hz}] & (\text{case of DO2}) \end{matrix}$$

Condition 2:

$$\frac{\text{FLOW SPAN-1}^{\text{Note 1}} [\text{m}^3/\text{s}]}{\text{PULSE VALUE} [\text{m}^3]} \leq \frac{1000}{2 \times \text{PULSE WIDTH} [\text{ms}]}$$

Note 1: The range of FLOW SPAN-1 or FLOW SPAN-2, whichever is larger, is the object in the case of 2-range setup.

Note 2: Restrictions in the maximum output frequency of each output port is also applied when the flow rate exceeds the set range. Therefore, if such a setup that the maximum frequency occurs at the time of 100% flow rate of the set range is made, there is a possibility where the total pulse output is incapable of following when the flow rate exceeds 100% and accurate total value cannot be obtained if over-range continues for a long time. If there are cases where the flow rate exceeds 100%, therefore, review the range and pulse value so that the maximum frequency will not exceed the restricted level.

Typical calculation

Calculate the range that permits setup of the pulse value under the range (FLOW SPAN-1) and pulse width indicated below.

When set values of the range (FLOW SPAN-1) and pulse width are as follows;

FLOW SPAN-1: 36 [m³/h] (=0.01 [m³/s]), PULSE WIDTH: 50 [ms]

i) Case of DO1 output

From condition 1,

$$\text{PULSE VALUE} \geq \frac{\text{FLOW SPAN-1 [m}^3\text{/s]}}{100 \text{ [Hz]}} = \frac{0.01 \text{ [m}^3\text{/s]}}{100 \text{ [Hz]}} = \underline{0.0001 \text{ [m}^3\text{]}} = \underline{0.1 \text{ [L]}}$$

$$\text{PULSE VALUE} \leq \text{FLOW SPAN-1 [m}^3\text{/s]} \times 86400 \text{ [s]} = 0.01 \text{ [m}^3\text{/s]} \times 86400 \text{ [s]} = \underline{864 \text{ [m}^3\text{]}}$$

From the above:

$$\underline{0.1 \text{ [L]} \leq \text{PULSE VALUE} \leq 864 \text{ [m}^3\text{]}} \dots\dots\dots \text{A}$$

From condition 2,

$$\begin{aligned} \text{PULSE VALUE} &\geq \text{FLOW SPAN-1 [m}^3\text{/s]} \times \frac{2 \times \text{PULSE WIDTH [ms]}}{1000} = 0.01 \text{ [m}^3\text{/s]} \times \frac{2 \times 50 \text{ [ms]}}{1000} \\ &= \underline{0.001 \text{ [m}^3\text{]}} = \underline{1 \text{ [L]}} \dots\dots\dots \text{B} \end{aligned}$$

The settable range of the pulse value that satisfies both of condition 1 and condition 2 is as follows from results of calculation A and B:

$$\underline{1 \text{ [L]} \leq \text{PULSE VALUE} \leq 864 \text{ [m}^3\text{]}}$$

ii) Case of DO2 output

From condition 1,

$$\text{PULSE VALUE} \geq \frac{\text{FLOW SPAN-1 [m}^3\text{/s]}}{1 \text{ [Hz]}} = \frac{0.01 \text{ [m}^3\text{/s]}}{1 \text{ [Hz]}} = \underline{0.01 \text{ [m}^3\text{]}} = \underline{10 \text{ [L]}} \dots\dots\dots \text{C}$$

Condition 2 is same as that of the case of DO1 output indicated above.

Therefore, the settable range of the pulse value is as follows from results of calculation B and C:

$$\underline{10 \text{ [L]} \leq \text{PULSE VALUE} \leq 864 \text{ [m}^3\text{]}}$$

For concrete keying, refer to the typical operation indicated in the next page. Set the parameter protection to OFF beforehand (Section 4.4.1).

Typical operation	Set the pulse value to 0.1 m ³ /pulse, and the pulse width to 50 ms. * Set the total unit beforehand.	
Keying order	Description	Indication
△	Pressed twice to indicate "OUTPUT SETUP".	OUTPUT SETUP
▼		
ENT	Pressed to indicate "ZERO ADJUST".	ZERO ADJUST CLEAR
▼		
△	Pressed 4 times to indicate "RANGE".	RANGE FLOW RATE
▼		
ENT	Pressed to blink the cursor.	RANGE FLOW RATE
▼		
△	Pressed to indicate "TOTAL" on 2nd line.	RANGE TOTAL
▼		
ENT	Pressed to indicate "TOTAL MODE".	TOTAL MODE START
▼		
△	Pressed to indicate "PULSE VALUE".	PULSE VALUE 1 m3
▼		
ENT	Pressed to indicate the cursor.	PULSE VALUE 00000001 m3
▼		
▶	Pressed 7 times to move the cursor.	PULSE VALUE 00000001 m3
▼		
△	Pressed 9 times to indicate the decimal point.	PULSE VALUE 000000.1 m3
▼		
ENT	Pressed to register.	PULSE VALUE ** COMPLETE **
▼		↓
▼	--- "PULSE VALUE" registered.---	PULSE VALUE 0.1 m3
△	Pressed to indicate the PULSE WIDTH.	PULSE WIDTH 5.0 msec
▼		
ENT	Pressed to blink the cursor.	PULSE WIDTH 5.0 msec
▼		
△	Pressed twice to select "50.0 msec".	PULSE WIDTH 50.0 msec
▼		
ENT	Pressed to register it.	PULSE WIDTH ** COMPLETE **
▼		↓
▼	--- "PULSE WIDTH" registered.---	PULSE WIDTH 50.0 msec
ESC △	Press ESC key 3 times, and △ key 3 times to resume the measurement mode.	0.000 m/s 0.000 m3/h

4.5.6.2. Setting the preset value

Description

- Preset value: Value which appears on the total counter when the total value has been reset.
Settable range: 0 to 99999999

Notes

1. A resetting action simultaneously resets both forward total memory and reverse total memory.
2. Set the total unit beforehand in the MEASURE SETUP mode (see Section 4.6.3.).

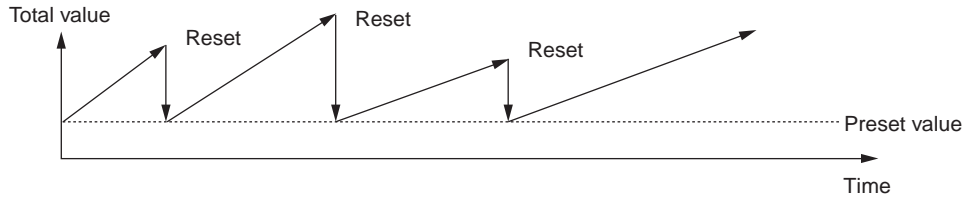

For concrete keying, refer to the typical operation indicated below. Set the parameter protection to OFF beforehand (Section 4.4.1)

Typical operation	Set the preset value to 100 m ³ . * Set the total unit beforehand.	
Keying order	Description	Indication
Δ	Pressed twice to indicate "OUTPUT SETUP".	OUTPUT SETUP
∇		
ENT	Pressed to indicate "ZERO ADJUST".	ZERO ADJUST CLEAR
∇		
Δ	Pressed 4 times to indicate "RANGE".	RANGE FLOW RATE
∇		
ENT	Pressed to blink the cursor.	RANGE FLOW RATE
∇		
Δ	Pressed to indicate "TOTAL" on 2nd line.	RANGE TOTAL
∇		
ENT	Pressed to indicate "TOTAL MODE".	TOTAL MODE START
∇		
Δ	Pressed 3 times to indicate "TOTAL PRESET".	TOTAL PRESET 0 m3
∇		
ENT	Pressed to indicate the cursor.	TOTAL PRESET 00000000 m3
∇		
\triangleright	Pressed 6 times to move the cursor. * Note that input cannot be entered on the first digit (the leftmost digit).	TOTAL PRESET 00000000 m3
∇		
Δ	Pressed to select "1".	TOTAL PRESET 00000100 m3
∇		
ENT	Pressed to register it.	TOTAL PRESET ** COMPLETE **
∇		
∇		
∇	--- PRESET value registered.---	TOTAL PRESET 100 m3
∇		
ESC Δ	Press \square key 3 times, and Δ key 3 times to resume the measurement mode.	0.000 m/s 0.000 m3/h

4.5.6.3. TOTAL mode (total reset, start, stop)

Description

- The total is started, stopped or reset.
- Settable range: START, STOP, RESET.
 START: Carried out the total.
 STOP: Stops the total.
 RESET: Reset the total memory to the preset value.

Notes

1. A resetting action simultaneously resets both forward total memory and reverse total memory.
2. To start a total after resetting a total value, be sure to set the "START".

For concrete keying, refer to the typical operation indicated below. Set the parameter protection to OFF beforehand (Section 4.4.1).

Typical operation	Reset the total value (preset value 0 m ³), and restart a total.	
Keying order	Description	Indication
		0.00 m3/h + 127.26 m3
△	Pressed twice to indicate "OUTPUT SETUP".	OUTPUT SETUP
▼		
ENT	Pressed to indicate "ZERO ADJUST".	ZERO ADJUST CLEAR
▼		
△	Pressed 4 times to indicate "RANGE".	RANGE FLOW RATE
▼		
ENT	Pressed to blink the cursor.	RANGE FLOW RATE
▼		
△	Pressed to indicate "TOTAL" on 2nd line.	RANGE TOTAL
▼		
ENT	Pressed to indicate "TOTAL MODE".	TOTAL MODE START
▼		
ENT	Pressed to blink the cursor.	TOTAL MODE START
▼		
△	Pressed twice to indicate "RESET".	TOTAL MODE RESET
▼		
ENT	Pressed to execute "RESET". Note: After resetting, the total operation automatically stops. To resume a total, execute "START".	TOTAL MODE ** COMPLETE **
▼		↓
▼	--- RESET has ended.---	TOTAL MODE STOP
▼		
ENT	Pressed to blink the cursor.	TOTAL MODE STOP
▼		
△	Pressed twice to indicate "START".	TOTAL MODE START
▼		

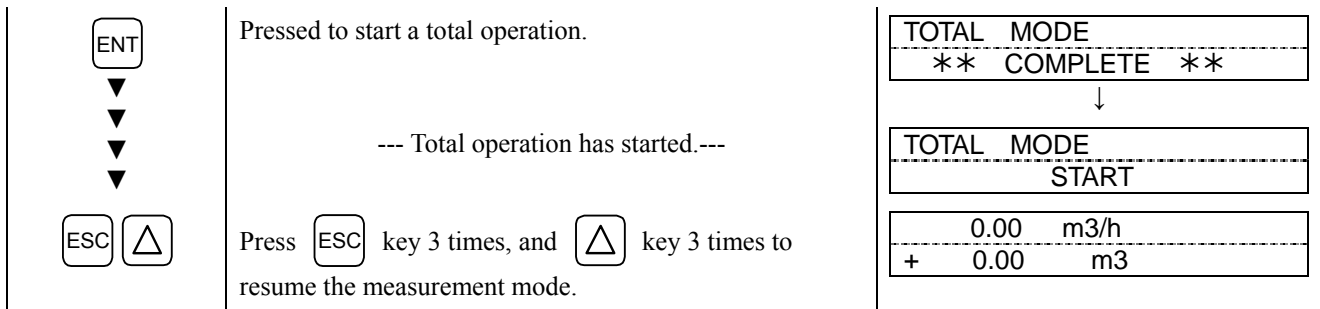

4.5.6.4. Determining how to dispose of total at error (BURNOUT)









Description
BURNOUT(TOTAL)

- Determines how to dispose of the total when the measurement status is abnormal on account of an empty pipe interior or bubbles mixed in fluid (common to total indication and total pulse output).
- Settable range
 HOLD: Stops the total (as factory set).
 COUNT: Continues the total according to a flow rate marked immediately before the error occurrence.

BURNOUT TIMER

- Sets the time from error occurrence to error processing.
- Settable range: 0 to 100 sec (factory set at 10 sec).
 The total continues until the burnout timer is actuated.

For concrete keying, refer to the typical operation indicated below. Set the parameter protection to OFF beforehand (Section 4.4.1).

Typical operation	Change the processing from "COUNT" to "HOLD", and change the burnout timer setting from 10 seconds to 15 seconds.			
Keying order	Description	Indication		
 ▼	Pressed twice to indicate "OUTPUT SETUP".	<table style="width: 100%; border-collapse: collapse;"> <tr> <td style="text-align: center;">OUTPUT SETUP</td> </tr> </table>	OUTPUT SETUP	
OUTPUT SETUP				
 ▼	Pressed to indicate "ZERO ADJUST".	<table style="width: 100%; border-collapse: collapse;"> <tr> <td style="text-align: center;">ZERO ADJUST</td> </tr> <tr> <td style="text-align: center;">CLEAR</td> </tr> </table>	ZERO ADJUST	CLEAR
ZERO ADJUST				
CLEAR				
 ▼	Pressed 4 times to indicate "RANGE".	<table style="width: 100%; border-collapse: collapse;"> <tr> <td style="text-align: center;">RANGE</td> </tr> <tr> <td style="text-align: center;">FLOW RATE</td> </tr> </table>	RANGE	FLOW RATE
RANGE				
FLOW RATE				
 ▼	Pressed to blink the cursor.	<table style="width: 100%; border-collapse: collapse;"> <tr> <td style="text-align: center;">RANGE</td> </tr> <tr> <td style="text-align: center;">FLOW RATE</td> </tr> </table>	RANGE	FLOW RATE
RANGE				
FLOW RATE				
 ▼	Pressed to indicate "TOTAL" on 2nd line.	<table style="width: 100%; border-collapse: collapse;"> <tr> <td style="text-align: center;">RANGE</td> </tr> <tr> <td style="text-align: center;">TOTAL</td> </tr> </table>	RANGE	TOTAL
RANGE				
TOTAL				
 ▼	Pressed to indicate "TOTAL MODE".	<table style="width: 100%; border-collapse: collapse;"> <tr> <td style="text-align: center;">TOTAL MODE</td> </tr> <tr> <td style="text-align: center;">START</td> </tr> </table>	TOTAL MODE	START
TOTAL MODE				
START				
 ▼	Pressed 4 times to indicate "BURNOUT (TOTAL)".	<table style="width: 100%; border-collapse: collapse;"> <tr> <td style="text-align: center;">BURNOUT (TOTAL)</td> </tr> <tr> <td style="text-align: center;">COUNT</td> </tr> </table>	BURNOUT (TOTAL)	COUNT
BURNOUT (TOTAL)				
COUNT				
 ▼	Pressed to blink the cursor.	<table style="width: 100%; border-collapse: collapse;"> <tr> <td style="text-align: center;">BURNOUT (TOTAL)</td> </tr> <tr> <td style="text-align: center;">COUNT</td> </tr> </table>	BURNOUT (TOTAL)	COUNT
BURNOUT (TOTAL)				
COUNT				

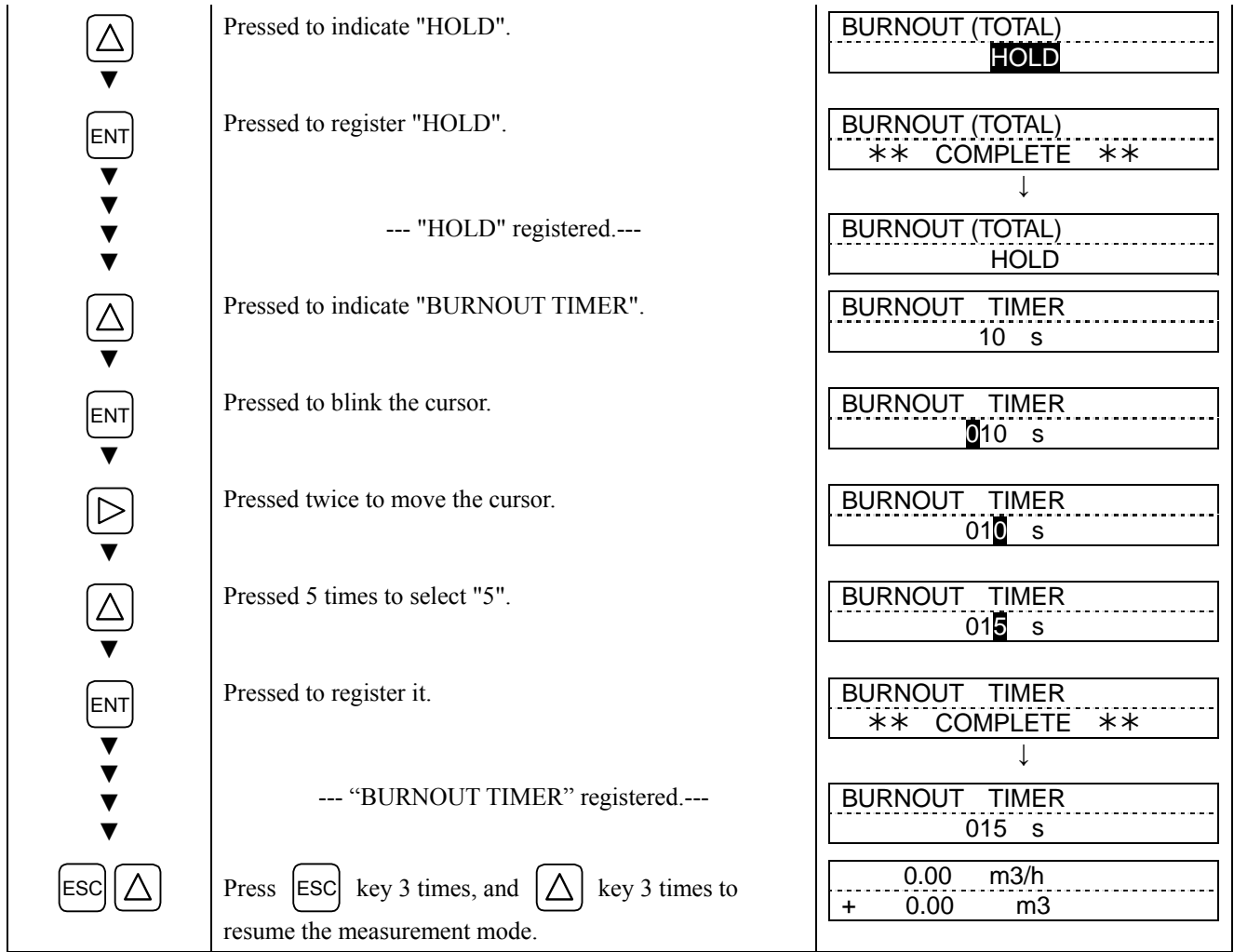

4.5.7. Setting the DO output

Description

Selects the output of total pulses and statuses (of alarm, flow switch, total switch, etc.).

Settable ranges (common to DO1 and DO2)

NOT USED	: Do not use the contact output.
+TOTAL PULSE	: Output the forward total pulses.
-TOTAL PULSE	: Output the reverse total pulses.
FLOW SPAN-2	: Select a contact output at SPAN-2 measurement status (forward automatic 2 ranges, forward/reverse automatic 2 ranges).
ALARM	
HARDWARE	: Select a contact output at EEPROM error.
PROCESS	: Select a contact output when wave is not received or is unstable.
FLOW SWITCH	
UPPER SWITCH	: Select a contact output when flow rate is above the setting.
LOWER SWITCH	: Select a contact output when flow rate is below the setting.
TOTAL SWITCH	: Select a contact output when total value exceeds the setting.
CONTACT ACTION	
ACTIVE ON	: Normally OFF (DO1) or normally open (DO2).
ACTIVE OFF	: Normally ON (DO1) or normally closed (DO2).

Note: DO output specifications

DO1	: Open collector, contact capacity 30 V DC, 0.1 A. When total pulse output is selected (See 4.5.6.1) 1 pulse/day to 100 pulses/s (at full scale flow rate). Pulse width: 5, 10, 50, 100 or 200 ms.
DO2	: Relay contact, contact capacity 220 V AC/30 V DC, 1 A. Life ... 200,000 operations (under rated load), replaceable with socket. When total pulse output is selected (See 4.5.6.1) 1 pulse/day to 1 pulse/s (at full scale flow rate). Pulse width: 50, 100 or 200 ms.

For concrete keying, refer to the typical operation indicated below. Set the parameter protection to OFF beforehand (Section 4.4.1).

4.5.7.1. Invalidating the DO output

Description

- Invalidates the DO1 OUT and/or DO2 OUT contact output.

For concrete keying, refer to the typical operation indicated below. Set the parameter protection to OFF beforehand (Section 4.4.1).

Typical operation	Change the setting of DO1 from "+TOTAL PULSE" to "NOT USED".	
Keying order	Description	Indication
	Pressed twice to select the OUTPUT SETUP mode.	OUTPUT SETUP
	Pressed to indicate ZERO ADJUST.	ZERO ADJUST CLEAR
	Pressed 5 times to indicate "DO1 OUT".	DO1 OUT
	* Pressing key again will select "DO2".	+TOTAL PULSE
	Pressed to blink the cursor.	DO1 OUT +TOTAL PULSE
	Pressed 6 times to indicate "NOT USED" on 2nd line.	DO1 OUT NOT USED
	Pressed to register "NOT USED".	DO1 OUT ** COMPLETE **
		↓
	--- "NOT USED" registered.---	DO1 OUT NOT USED
	Press key once, and key 3 times to resume the measurement mode.	0.000 m/s 0.000 m3/h

4.5.7.2. How to validate the total pulse output

Description

- Validates the total pulse output for DO1 OUT and/or DO2 OUT.
 - +TOTAL PULSE: Forward flow rate total pulse output.
 - TOTAL PULSE: Reverse flow rate total pulse output.
- Note: Referring to Section 4.5.6.1., set the pulse value, pulse width, etc.

For concrete keying, refer to the typical operation indicated below. Set the parameter protection to OFF beforehand (Section 4.4.1).

Typical operation		
Keying order	Description	Indication
	Pressed twice to select the OUTPUT SETUP mode.	OUTPUT SETUP
	Pressed to indicate ZERO ADJUST.	ZERO ADJUST CLEAR
	Pressed 5 times to indicate "DO1 OUT". * Pressing key again will select "DO2".	DO1 OUT NOT USED
	Pressed to blink the cursor.	DO1 OUT NOT USED
	Pressed to indicate "+TOTAL PULSE" on 2nd line. Or, to select "-TOTAL PULSE", press key again.	DO1 OUT +TOTAL PULSE
	Pressed to register "+TOTAL PULSE".	DO1 OUT ** COMPLETE **
	--- "+TOTAL PULSE" registered.---	STATUS OUT CONTACT ACTION
	Pressed to indicate "CONTACT ACTION".	CONTACT ACTION ACTIVE ON
	Pressed to register "ACTIVE ON" (normally OFF). * If it is desired to select Normally ON, press key.	CONTACT ACTION ** COMPLETE **
	--- "ACTIVE ON" registered.---	STATUS OUT CONTACT ACTION
	Press key twice, and key 3 times to resume the measurement mode.	0.000 m/s 0.000 m3/h

4.5.7.3. How to validate outputting the FLOW SPAN-2

Description

- Select a contact output as DO1 and/or DO2 at FLOW SPAN-2 measurement status.

For concrete keying, refer to the typical operation indicated below. Set the parameter protection to OFF beforehand (Section 4.4.1).

Typical operation	Set the DO1 output to "FLOW SPAN-2". Also set the contact to Normally OFF.	
Keying order	Description	Indication
	Pressed twice to select the OUTPUT SETUP mode.	OUTPUT SETUP
	Pressed to indicate ZERO ADJUST.	ZERO ADJUST CLEAR
	Pressed 5 times to indicate "DO1 OUT". * Pressing key again will select "DO2".	DO1 OUT NOT USED
	Pressed to blink the cursor.	DO1 OUT NOT USED
	Pressed 3 times to indicate "FLOW SPAN-2" on 2nd line.	DO1 OUT FLOW SPAN-2
	Pressed to register "FLOW SPAN-2".	DO1 OUT ** COMPLETE **
	--- "FLOW SPAN-2" registered.---	STATUS OUT CONTACT ACTION
	Pressed to indicate "CONTACT ACTION".	CONTACT ACTION ACTIVE ON
	Pressed to register "ACTIVE ON" (normally OFF). *If it is desired to select Normally ON, press key.	CONTACT ACTION ** COMPLETE **
	--- "ACTIVE ON" registered.---	STATUS OUT CONTACT ACTION
	Press key twice, and key 3 times to resume the measurement mode.	0.000 m/s 0.000 m3/h

4.5.7.4. How to validate the alarm output

Description

- Select a contact output as DO1 and/or DO2 when received wave or EEPROM is abnormal.

Settable range

- ALL : Select a contact output when EEPROM and received wave (nothing, unstable) are abnormal.
- HARDWARE FAULT : Select a contact output when EEPROM is abnormal.
- PROCESS ERROR : Select a contact output when received wave is abnormal.

For concrete keying, refer to the typical operation indicated below. Set the parameter protection to OFF beforehand (Section 4.4.1).

Typical operation	Set the DO1 output to "PROCESS ERROR". Also set the contact to Normally OFF.	
Keying order	Description	Indication
	Pressed twice to select the OUTPUT SETUP mode.	OUTPUT SETUP
	Pressed to indicate ZERO ADJUST.	ZERO ADJUST CLEAR
	Pressed 5 times to indicate "DO1 OUT". * Pressing key again will select "DO2".	DO1 OUT NOT USED
	Pressed to blink the cursor.	DO1 OUT NOT USED
	Pressed 4 times to indicate "ALARM" on 2nd line.	DO1 OUT ALARM
	Pressed to indicate the ALARM selection screen.	ALARM ALL
	Pressed twice to indicate "PROCESS ERROR".	ALARM PROCESS ERROR
	Pressed to register it.	ALARM ** COMPLETE **
	--- "PROCESS ERROR" registered.---	STATUS OUT CONTACT ACTION
	Pressed to indicate "CONTACT ACTION".	CONTACT ACTION ACTIVE ON
	Pressed to register "ACTIVE ON" (normally OFF). * If it is desired to select Normally ON, press key.	CONTACT ACTION ** COMPLETE **
	--- "ACTIVE ON" registered.---	STATUS OUT CONTACT ACTION
	Press key twice, and key 3 times to resume the measurement mode.	0.000 m/s 0.000 m3/h

4.5.7.5. How to validate the flow switch

Description

- Select a contact output as DO1 and/or DO2 when the flow rate has exceeded a setting.

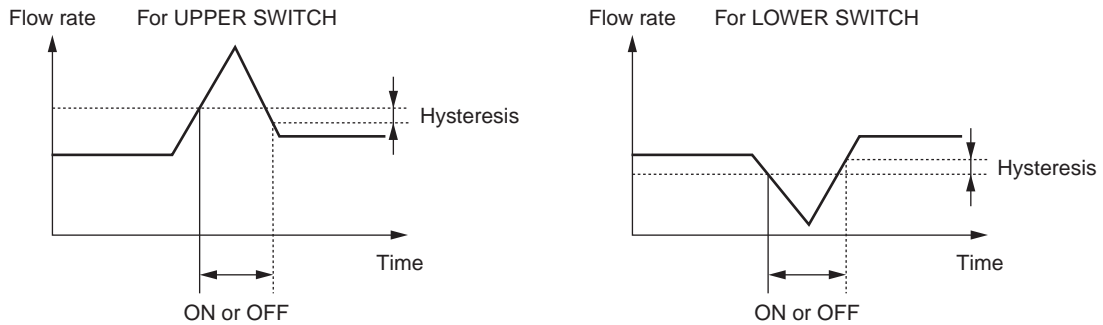

- **Settable ranges**

Flow rate : 0 to 10 m/s in terms of flow velocity.
 Action : UPPER SWITCH or LOWER SWITCH.
 Contact action : ACTIVE ON ... DO1 normally OFF, DO2 normally open.
 ACTIVE OFF ... DO1 normally ON, DO2 normally closed.

Note: The hysteresis value set in Section 4.5.5 "Setting the flow rate and flow velocity range" is applied to the action range.

For concrete keying, refer to the typical operation indicated below. Set the parameter protection to OFF beforehand (Section 4.4.1).

Typical operation	Set the DO1 output to "UPPER SWITCH", and upper limit flow rate to 12 [m ³ /h]. Also, set the contact to Normally OFF.	
Keying order	Description	Indication
△	Pressed twice to select the "OUTPUT SETUP" mode.	OUTPUT SETUP
▼		
ENT	Pressed to indicate "ZERO ADJUST".	ZERO ADJUST CLEAR
▼		
△	Pressed 5 times to indicate "DO1 OUT".	DO1 OUT
▼	* Pressing △ key again will select "DO2".	NOT USED
ENT	Pressed to blink the cursor.	DO1 OUT NOT USED
▼		
△	Pressed 5 times to select "FLOW SWITCH" on 2nd line.	DO1 OUT FLOW SWITCH
▼		
ENT	Pressed to indicate the flow rate setting screen for the "UPPER SWITCH".	UPPER SWITCH 10.0000 m3/h
▼	* Pressing △ key will select the flow rate setting screen for the "LOWER SWITCH".	
ENT	Pressed to blink the cursor.	UPPER SWITCH 0010.0000 m3/h
▼		
▶	Pressed 3 times to move the cursor.	UPPER SWITCH 0010.0000 m3/h
▼		

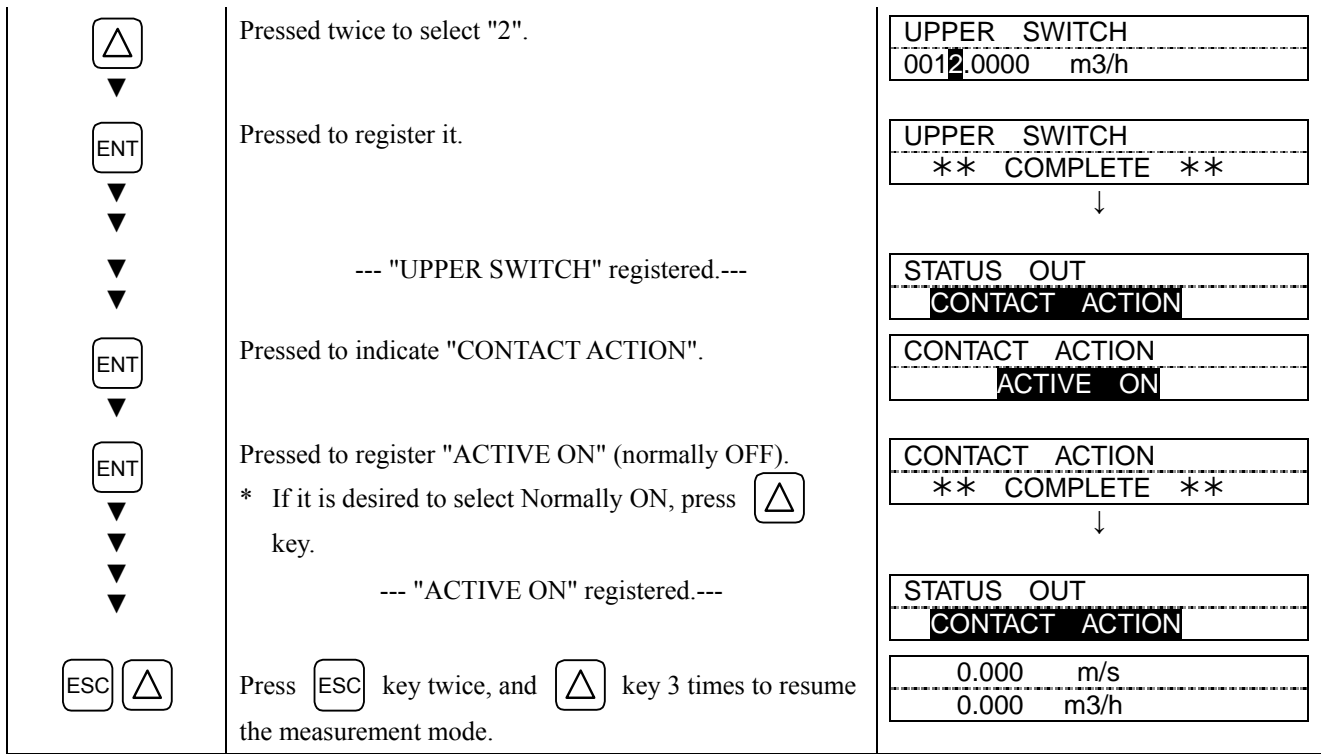

4.5.7.6. How to validate the total switch

Description

- Select a contact output as DO1 and/or DO2 when the total value exceeds a setting.

Settable range: 0.000001 to 99999999

Contact action:

ACTIVE ON ... DO1 normally OFF, DO2 normally open.

ACTIVE OFF ... DO1 normally ON, DO2 normally closed.

Note: Different values can be assigned to DO1 and DO2.

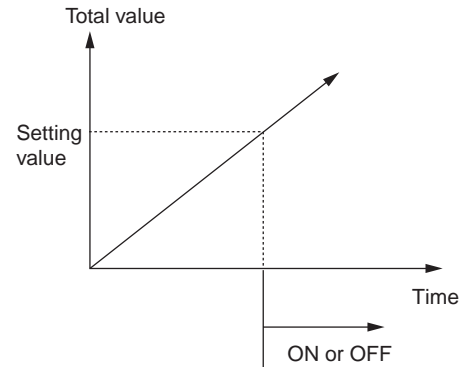

For concrete keying, refer to the typical operation indicated below.
Set the parameter protection to OFF beforehand (Section 4.4.1).

Typical operation	Set the DO1 output to "TOTAL SWITCH", and change the setting from 10000 [m ³] to 100 [m ³]. Also, set the contact to Normally OFF.	
Keying order	Description	Indication
△	Pressed twice to select the OUTPUT SETUP mode.	OUTPUT SETUP
▼		
ENT	Pressed to indicate ZERO ADJUST.	ZERO ADJUST CLEAR
▼		
△	Pressed 5 times to indicate "DO1 OUT". * Pressing △ key again will select "DO2".	DO1 OUT NOT USED
▼		
ENT	Pressed to blink the cursor.	DO1 OUT NOT USED
▼		
△	Pressed 6 times to select "TOTAL SWITCH" on 2nd line.	DO1 OUT TOTAL SWITCH
▼		
ENT	Pressed to indicate the setting screen for "TOTAL SWITCH".	TOTAL SWITCH 10000 m3
▼		
ENT	Pressed to blink the cursor.	TOTAL SWITCH 00010000 m3
▼		
▶	Pressed 3 times to move the cursor.	TOTAL SWITCH 00010000 m3
▼		
△	Pressed 10 times to select "0".	TOTAL SWITCH 00000000 m3
▼		
▶	Pressed twice to move the cursor	TOTAL SWITCH 00000000 m3
▼		
△	Pressed to select "1".	TOTAL SWITCH 00000100 m3
▼		
ENT	Pressed to register it.	TOTAL SWITCH ** COMPLETE **
▼		
▼		
▼		
▼	--- "TOTAL SWITCH" registered.---	STATUS OUT CONTACT ACTION

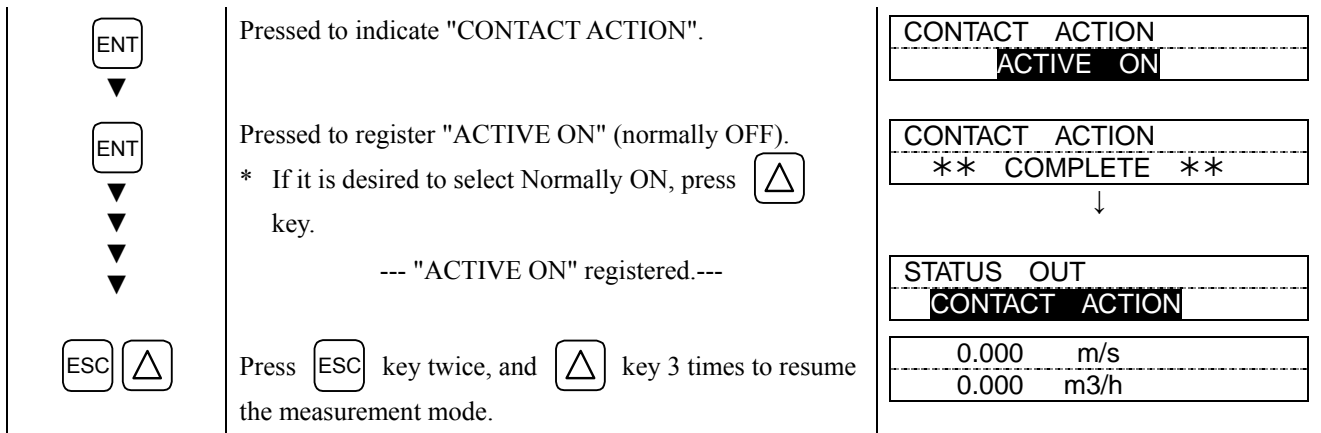

4.5.8. How to compensate the measurement value

Description

- Used for compensating the measurement value.
The span can be compensated.
Compensatable range: ±200%

The output value (reading, analog output and total output) is computed by the following expression.

$$\text{Output} = \frac{\text{measurement value} \times [\text{compensation value \%}]}{100}$$

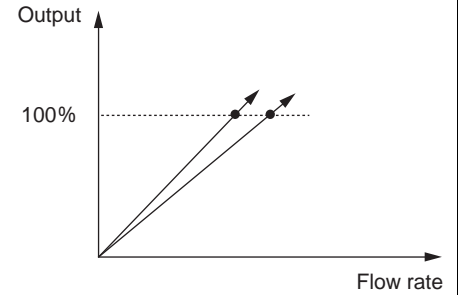

For concrete keying, refer to the typical operation indicated below. Set the parameter protection to OFF beforehand (Section 4.4.1).

Typical operation	Compensate the measurement value by 1 %.	
Keying order	Description	Indication
	Pressed twice to select the OUTPUT SETUP mode.	OUTPUT SETUP
	Pressed to indicate ZERO ADJUST.	ZERO ADJUST CLEAR
	Pressed 7 times to indicate "CALIBRATION SPAN".	CALIBRATION SPAN 100.0 %
	Pressed to blink the cursor.	CALIBRATION SPAN 100.0 %
	Pressed twice to move the cursor.	CALIBRATION SPAN 100.0 %
	Pressed to select "1".	CALIBRATION SPAN 101.0 %
	Pressed to register it.	CALIBRATION SPAN ** COMPLETE **
	--- Compensation value registered.---	CALIBRATION SPAN 101.0 %
	Press key once, and key 3 times to resume the measurement mode.	0.000 m/s 0.000 m3/h

















4.6. Measure setup mode

4.6.1. How to set the unit system

Description

- Select a measurement unit system.
- Metric system (factory set)
 - Length..... mm
 - Flow velocity..... m/s
 - Flow rate..... L/s, L/min, L/h, ML/d, m³/s, m³/min, m³/h, Mm³/d, BBL/s, BBL/min, BBL/h, MBBL/d
 - Total..... mL, L, m³, km³, Mm³, mBBL, BBL, kBBL
- Inch system
 - Length..... inch
 - Flow velocity..... ft/s
 - Flow rate..... gal/s, gal/min, gal/h, Mgal/d, ft³/s, ft³/min, ft³/h, Mft³/d, BBL/s, BBL/min, BBL/h, MBBL/d
 - Total..... gal, kgal, ft³, kft³, Mft³, mBBL, BBL, kBBL, ACRE-in, ACRE-ft

For concrete keying, refer to the typical operation indicated below. Set the parameter protection to OFF beforehand (Section 4.4.1).

Typical operation	Change the unit system from inch system to metric system.	
Keying order	Description	Indication
 	Pressed 3 times to indicate "MEASURE SETUP".	<div style="border: 1px solid black; padding: 2px; width: fit-content; margin: 0 auto;">MEASURE SETUP</div>
 	Pressed to indicate "SYSTEM UNIT".	<div style="border: 1px solid black; padding: 2px; width: fit-content; margin: 0 auto;">SYSTEM UNIT ENGLISH</div>
 	Pressed to blink the cursor.	<div style="border: 1px solid black; padding: 2px; width: fit-content; margin: 0 auto;">SYSTEM UNIT ENGLISH</div>
 	Pressed to indicate "METRIC".	<div style="border: 1px solid black; padding: 2px; width: fit-content; margin: 0 auto;">SYSTEM UNIT METRIC</div>
    	Pressed to register it.	<div style="border: 1px solid black; padding: 2px; width: fit-content; margin: 0 auto;">SYSTEM UNIT ** COMPLETE **</div>
	--- "METRIC" registered.---	↓
 	Press  key once, and  key twice to resume the measurement mode.	<div style="border: 1px solid black; padding: 2px; width: fit-content; margin: 0 auto;">0.000 m/s 0.000 m3/h</div>

4.6.2. How to set the flow rate unit

Description

- Select the unit of flow rate.

- Metric system



















Flow rate..... L/s (factory set), L/min, L/h, ML/d, m³/s, m³/min, m³/h, Mm³/d, BBL/s, BBL/min, BBL/h, MBBL/d

- Inch system

Flow rate..... gal/s, gal/min, gal/h, Mgal/d, ft³/s, ft³/min, ft³/h, Mft³/d, BBL/s, BBL/min, BBL/h, MBBL/d

<Caution> First, set the unit system (metric or inch) according to Section 4.6.1.

For concrete keying, refer to the typical operation indicated below. Set the parameter protection to OFF beforehand (Section 4.4.1).

Typical operation	Set the flow rate unit to [m ³ /h].	
Keying order	Description	Indication
	Pressed 3 times to indicate "MEASURE SETUP".	MEASURE SETUP
		
	Pressed to indicate "SYSTEM UNIT".	SYSTEM UNIT METRIC
		
	Pressed to indicate "FLOW UNIT".	FLOW UNIT L/S
		
	Pressed to blink.	FLOW UNIT L/S
		
	Pressed 6 times to select "m ³ /h".	FLOW UNIT m ³ /h
		
	Pressed to register it.	FLOW UNIT ** COMPLETE **
		↓
	--- "m ³ /h" registered.---	FLOW UNIT m ³ /h
		
 	Press  key once, and  key twice to resume the measurement mode.	0.000 m/s 0.000 m ³ /h

4.6.3. How to set the total unit

Description

- Select the unit of total volume.
- Metric system
 Total..... mL (factory set), L, m³, km³, Mm³, mBBL, BBL, kBBL
- Inch system
 Total..... gal, kgal, ft³, kft³, Mft³, mBBL, BBL, kBBL, ACRE-in, ACRE-ft

<Caution> First, set the unit system (metric or inch) according to Section 4.6.1.

For concrete keying, refer to the typical operation indicated below. Set the parameter protection to OFF beforehand (Section 4.4.1).

Typical operation	Set the total unit to [m ³].	
Keying order	Description	Indication
△	Pressed 3 times to indicate "MEASURE SETUP".	MEASURE SETUP
▼		
ENT	Pressed to indicate "SYSTEM UNIT".	SYSTEM UNIT METRIC
▼		
△	Pressed twice to indicate "TOTAL UNIT".	TOTAL UNIT mL
▼		
ENT	Pressed to blink.	TOTAL UNIT mL
▼		
△	Pressed twice to select "m ³ ".	TOTAL UNIT m3
▼		
ENT	Pressed to register it.	TOTAL UNIT ** COMPLETE **
▼		↓
▼	--- "m ³ " registered.---	TOTAL UNIT m3
▼		
ESC △	Press ESC key once, and △ key twice to resume the measurement mode.	0.00 m3/h + 0.00 m3

4.6.4. How to set the piping parameters

Description

- Set the parameters of piping and fluid to be measured to determine the sensor unit spacing.



Set the following parameters, calculate the sensor unit spacing value and then, to match the result, install the sensor units into the frame.































- Unless the sensor units are spaced accurately, the measurement error will be excessive.
- And the received wave may be abnormal.

Setting item

1. Pipe outer diameter : 10 to 300 [mm] (factory set at 60.00 [mm]).
2. Pipe material : PVC (factory set), PVDF, PEEK, PP, CARBON STEEL, STAINLESS STEEL, COPPER, others (sound velocity 1000 to 3700 m/s).
3. Wall thickness : 0.1 to 50.00 [mm] (factory set at 4.50 [mm]).
4. Lining material : NO LINING (factory set), TAR EPOXY, MORTAL, RUBBER, TEFLON, PYREXGLASS, others (sound velocity: 1000 to 3700 [m/s]).
5. Lining material thickness : 0.01 to 50.00 [mm].
6. Fluid to be measured : WATER, SEA WATER, others (sound velocity: 500 to 2500 [m/s])
7. Kinematic viscosity : 0.0001 to 999.9999×10⁻⁶ [m²/s] (factory set at 1.0038×10⁻⁶ [m²/s])
8. Sensor mounting method : V method (factory set), Z method (Note: V method only is valid. **Select the V method.**)
9. Sensor type : FLS_12 (factory set), FLS_22.

For concrete keying, refer to the typical operation indicated below. Set the parameter protection to OFF beforehand (Section 4.4.1)



Typical operation	Carry out setting for measuring the flow rate of water flowing through PVC pipe (for tap water) having 100 mm of nominal diameter.	
Keying order	Description	Indication
	Pressed 3 times to indicate "MEASURE SETUP".	MEASURE SETUP
	Pressed to indicate "SYSTEM UNIT".	SYSTEM UNIT METRIC
	Pressed 3 times to indicate "PIPE PARAMETER".	PIPE PARAMETER S= 16 (48mm)
	Pressed to indicate "OUTER DIAMETER".	OUTER DIAMETER 60.00 mm
	Pressed to blink the cursor.	OUTER DIAMETER 060.00 mm
	Operated to compose "114" because, from piping data in Section 6.6., the outer diameter of polyvinyl chloride pipe (tap water size) is 114 mm.	OUTER DIAMETER 114.00 mm
	Pressed to register the outer diameter.	OUTER DIAMETER ** COMPLETE **
		↓
	--- "OUTER DIAMETER" registered.---	OUTER DIAMETER 114.00 mm

 	<p>Pressed to indicate "PIPE MATERIAL". Because PVC (factory set) is already registered, go to the next step.</p> <p>Note: If the pipe is made of another material, press  key, and select a corresponding menu.</p>	<table border="1"> <tr> <td>PIPE MATERIAL</td> </tr> <tr> <td>PVC</td> </tr> </table>	PIPE MATERIAL	PVC
PIPE MATERIAL				
PVC				
 	<p>Pressed to indicate "WALL THICKNESS".</p>	<table border="1"> <tr> <td>WALL THICKNESS</td> </tr> <tr> <td>4.50 mm</td> </tr> </table>	WALL THICKNESS	4.50 mm
WALL THICKNESS				
4.50 mm				
 	<p>Pressed to blink the cursor.</p>	<table border="1"> <tr> <td>WALL THICKNESS</td> </tr> <tr> <td>004.50 mm</td> </tr> </table>	WALL THICKNESS	004.50 mm
WALL THICKNESS				
004.50 mm				
  	<p>Operated to compose "7.0" because, from piping data in Section 6.6., the wall thickness of polyvinyl chloride pipe (tap water size) is 7.0 mm.</p>	<table border="1"> <tr> <td>WALL THICKNESS</td> </tr> <tr> <td>007.00 mm</td> </tr> </table>	WALL THICKNESS	007.00 mm
WALL THICKNESS				
007.00 mm				
 	<p>Pressed to register the wall thickness.</p>	<table border="1"> <tr> <td>WALL THICKNESS</td> </tr> <tr> <td>** COMPLETE **</td> </tr> </table>	WALL THICKNESS	** COMPLETE **
WALL THICKNESS				
** COMPLETE **				
  	<p>--- "WALL THICKNESS" registered.---</p>			
 	<p>Pressed to indicate "LINING MATERIAL". "NO LINING" (factory set) is already registered. Because there is no lining, go to the next step.</p> <p>Note: If lining is provided, press  key, and select a corresponding menu. Or, input a sound velocity. Further, go to "LINING THICKNESS", and input a lining thickness. Nothing is indicated in case of "NO LINING".</p>	<table border="1"> <tr> <td>WALL THICKNESS</td> </tr> <tr> <td>7.00 mm</td> </tr> </table>	WALL THICKNESS	7.00 mm
WALL THICKNESS				
7.00 mm				
 	<p>Pressed to indicate "KIND OF FLUID". Because, likewise, "WATER" (factory set) is already registered, go to the next step.</p> <p>Note: If fluid to be measured is other than water, press  key, and input the sea water or measurement fluid's sound velocity.</p>	<table border="1"> <tr> <td>LINING MATERIAL</td> </tr> <tr> <td>NO LINING</td> </tr> </table>	LINING MATERIAL	NO LINING
LINING MATERIAL				
NO LINING				
 	<p>Pressed to indicate "KINEMATIC VISCO". Input the kinematic viscosity of the fluid to be measured. Because the kinematic viscosity 1.0038E-6 [m²/s] of water at 20°C is already registered, go to the next step. In case of fluid other than water, input the kinematic viscosity at a measurement status of fluid to be measured referring to data in Section 6.6., etc.</p>	<table border="1"> <tr> <td>KIND OF FLUID</td> </tr> <tr> <td>WATER</td> </tr> </table>	KIND OF FLUID	WATER
KIND OF FLUID				
WATER				
 	<p>Pressed to indicate "PIPE PARAMETER". "S= 31" is indicated on 2nd line. After mounting the frames on piping, insert into it 2 sensor units spaced at 31 divisions.</p>	<table border="1"> <tr> <td>KINEMATIC VISCO</td> </tr> <tr> <td>1.0038 E-6m²/s</td> </tr> </table>	KINEMATIC VISCO	1.0038 E-6m ² /s
KINEMATIC VISCO				
1.0038 E-6m ² /s				
 	<p>Press  key once, and  key twice to resume the measurement mode.</p>	<table border="1"> <tr> <td>PIPE PARAMETER</td> </tr> <tr> <td>S= 31 (93mm)</td> </tr> </table>	PIPE PARAMETER	S= 31 (93mm)
PIPE PARAMETER				
S= 31 (93mm)				
<table border="1"> <tr> <td>0.00 m³/h</td> </tr> <tr> <td>+ 0.00 m³</td> </tr> </table>	0.00 m ³ /h	+ 0.00 m ³		
0.00 m ³ /h				
+ 0.00 m ³				

4.7. Maintenance mode







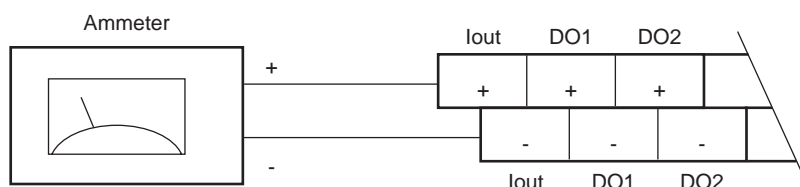







4.7.1. How to calibrate the analog output

Description

- The calibration is performed so as to obtain 4 mA and 20 mA when the analog signal (4-20 mA DC) output is 0% and 100%, respectively.
- Connect an ammeter to Iout terminals as shown below. In the CURRENT CALIBRATION mode, select 4 mA or 20 mA, and operate  key (UP) or  key (Down).



For concrete keying, refer to the typical operation indicated below. Set the parameter protection to OFF beforehand (Section 4.4.1).























Typical operation	Calibrate the output of 4 mA and 20 mA.	
Keying order	Description	Indication
	Pressed 4 times to indicate "MAINTENANCE MODE".	MAINTENANCE MODE
▼		
	Pressed to indicate "CURRENT CALIBRATION".	CURRENT CALIBRATION
▼		
	Pressed twice to select the calibration mode for 4 mA. (When the cursor blinks, 4 mA of current is outputted.)	CURRENT 4 mA
▼	Then, press  (UP) or  (Down) key so as to obtain 4 mA, watching the reading on ammeter or other calibration instruments.	
	Pressed to register the calibration result.	CURRENT ** COMPLETE **
▼		↓
▼	--- 4 mA calibration registered.---	CURRENT 4 mA
▼		
	Pressed to select 20 mA.	CURRENT 20 mA
▼		
	Pressed to select the calibration mode for 20 mA. (When the cursor blinks, 20 mA of current is outputted.)	CURRENT 20 mA
▼	Then, press  (UP) or  (Down) key so as to obtain 20 mA.	
	Pressed to register the calibration result.	CURRENT ** COMPLETE **
▼		↓
▼	--- 20 mA calibration registered.---	CURRENT 20 mA
▼		
 	Press  key twice, and  key once to resume the measurement mode.	0.000 m/s 0.000 m3/h

4.7.2. How to set the constant current output

Description

- Generates a fixed value output of analog signal.
Application example: The operation of a connected receiver is checked by generating a fixed value output of analog signal.
- In the constant current setting mode (CURRENT OUTPUT SETTING), set the constant current output value.
Settable range: -20% (0.8 mA) to +120% (23.2 mA).

For concrete keying, refer to the typical operation indicated below. Set the parameter protection to OFF beforehand (Section 4.4.1).

Typical operation	Set the constant current output of 50% (12 mA).	
Keying order	Description	Indication
	Pressed 4 times to indicate "MAINTENANCE MODE".	MAINTENANCE MODE
		
	Pressed to indicate "CURRENT CALIBRATION".	CURRENT CALIBRATION
		
	Pressed to indicate "CURRENT OUTPUT SETTING".	CURRENT OUTPUT SETTING
		
	Pressed to select the setting screen.	CURRENT SETTING 4.0 mA
		
	Pressed to blink the cursor. Note: A constant current output starts.	CURRENT SETTING 04.0 mA
		
 	Operated to compose [12].	CURRENT SETTING 12.0 mA
		
	Pressed to output 12 mA.	CURRENT SETTING ** COMPLETE **
		
		
		
	Pressed to stop the constant current output. Note: The current output at a measurement status is resumed.	CURRENT SETTING 12.0 mA
		
 	Press  key and  key to resume the measurement mode.	CURRENT OUTPUT SETTING 0.000 m/s 0.000 m3/h

4.7.3. How to check the action of total pulses

Description

- Checks the action of total pulse output.

The output action can be checked upon designating the number of pulses to be outputted per second.

Settable range: 1 to 100 pulses/s. (DO1 only)

Note: 1. The output pulse width is as selected currently (see Section 4.5.6.1.)

Set the frequency taking the pulse width into account referring to the following expression.

Pulse count setting $\leq 1000/(\text{pulse width [ms]} \times 2)$























Example: If the pulse width is set at 50 ms, select 10 pulses/s or less.

Note: 2. DO1 (transistor open collector) and DO2 (relay contact) operate simultaneously.

Before checking the action, confirm whether proceeding to an action is all right or not.

Note: 3. DO2 (relay contact) always operates at the rate of 1 pulse/sec.

For concrete keying, refer to the typical operation indicated below. Set the parameter protection to OFF beforehand (Section 4.4.1).

Typical operation	Output 5 pulses/s.	
Keying order	Description	Indication
	Pressed 4 times to indicate "MAINTENANCE MODE".	MAINTENANCE MODE
		
	Pressed to indicate "CURRENT CALIBRATION".	CURRENT CALIBRATION
		
	Pressed twice to indicate "TOTAL PULSE".	TOTAL PULSE 1 PULSE/s
		
	Pressed to blink the cursor. Note: Outputting simulated pulses starts.	TOTAL PULSE 001 PULSE/s
		
	Pressed twice to move the cursor.	TOTAL PULSE 001 PULSE/s
		
	Pressed 4 times to select "5".	TOTAL PULSE 005 PULSE/s
		
	Pressed to register it.	TOTAL PULSE ** COMPLETE **
		
		
	--- 5 pulses/s registered.---	TOTAL PULSE 005 PULSE/s
	5 simulated pulses/s are outputted.	
	Pressed to stop the simulated output after the end of checking the output.	TOTAL PULSE 005 PULSE/s
		
 	Press  key once, and  key once to resume the measurement mode.	0.000 m/s 0.000 m3/h

4.7.4. How to check the status output

Description

- Check the status output.
Settable range: ON ... Short-circuits the contact. OFF ... Open-circuits the contact.

⚠ CAUTION

- This operation sets DO1 and DO2 the same contact action.
- Before operation, check whether DO output can be changed or not.

For concrete keying, refer to the typical operation indicated below. Set the parameter protection to OFF beforehand (Section 4.4.1)

Typical operation	Check the contact action.	
Keying order	Description	Indication
△ ▼	Pressed 4 times to indicate "MAINTENANCE MODE".	MAINTENANCE MODE
ENT ▼	Pressed to indicate "CURRENT CALIBRATION".	CURRENT CALIBRATION
△ ▼	Pressed 3 times to indicate "STATUS OUTPUT".	STATUS OUTPUT ON
ENT ▼	Pressed to blink the cursor. Note: At this time, the contact output is set as indicated. In the example shown on the right, the contact output is set as "ON".	STATUS OUTPUT ON
△ ▼	Pressed to select "OFF".	STATUS OUTPUT OFF
ENT ▼ ▼ ▼	Pressed to register "OFF". --- "OFF" registered.--- * Make sure the contact output is "OFF".	STATUS OUTPUT ** COMPLETE ** ↓ STATUS OUTPUT OFF
△ ▼	Pressed to select "ON".	STATUS OUTPUT ON
ENT ▼ ▼ ▼	Pressed to register "ON". --- "ON" registered.--- * Make sure the contact output is "ON".	STATUS OUTPUT ** COMPLETE ** ↓ STATUS OUTPUT ON
ESC ▼	Pressed once to stop the blinking of the cursor. * At this time, the contact output is set at normal measurement status.	STATUS OUTPUT ON
ESC △	Press ESC key once, and △ key once to resume the measurement mode.	0.000 m/s 0.000 m3/h

4.7.5. How to validate the test mode (simulated flow rate output)

Description

- Checks different outputs (LCD indication, analog output, DO output) upon simulating flow rate outputs. With the output at the actuated time as an initial value, the output changes up to the input value (simulated flow rate target value) in a selected tracking time and, at the input value, the output becomes constant. Each output changes with a simulated flow rate output. So long as the test mode is valid, "T" blinks on the left end of the 1st line of LCD on the measurement mode screen.

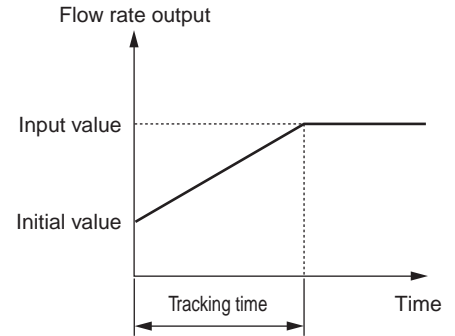

Settable contents

- Test mode validation: Validates or invalidates the test mode.
- Input value : Simulated flow rate target.
- Tracking time : Time required to attain the simulated flow rate target (above input value).

Settable ranges

- Test mode validation: SETTING (valid), NOT USED (invalid).
- Input value : 0 to ± 10 [m/s] in terms of flow velocity.
- Tracking time : 0 to 999 seconds.



CAUTION

- In this mode, the analog output, and DO1 and DO2 outputs change with settings. Check beforehand whether each output can be changed or not.
- Be sure to resume "NOT USED" after the end of test. Otherwise, the input value output status will be held until power is turned off.
- If the TOTAL MODE is set at "START", the total value also changes. If it is desired not to change the total value, select "STOP".

For concrete keying, refer to the typical operation indicated below. Set the parameter protection to OFF beforehand (Section 4.4.1).

Typical operation	Set the simulated flow rate target to 10 [m ³ /h], and the tracking time to 100 [s].	
Keying order	Description	Indication
	Pressed 4 times to indicate "MAINTENANCE MODE".	MAINTENANCE MODE
	Pressed to indicate "CURRENT CALIBRATION".	CURRENT CALIBRATION
	Pressed 4 times to indicate "TEST MODE".	TEST MODE NOT USED
	Pressed to blink the cursor.	TEST MODE NOT USED
	Pressed to select "SETTING".	TEST MODE SETTING
	Pressed to register "SETTING".	INPUT DATA 0 m3/h
	Pressed to blink the cursor on 2nd line.	INPUT DATA 00000000 m3/h



Using key and key, compose "10".



Pressed to register it.



--- Simulated flow rate target registered.---



Pressed to indicate "TRACKING TIME".



Pressed to blink the cursor on 2nd line.



Pressed to select "100".



Pressed to register it.



--- "TRACKING TIME" registered.---
* At this time, the simulated output action starts.



Press key and key to resume the measurement mode. "T" blinks on the left end of 1st line of LCD, and the output changes. In 100 seconds (at which tracking time is set), the output becomes stable at 10 [m³/h] (simulated flow rate target).
Note: Be sure to return the TEST MODE to "NOT USED" after checking the output.

INPUT DATA
00000010 M3/h

INPUT DATA
** COMPLETE **



INPUT DATA
10 m3/h

TRACKING TIME
0 s

TRACKING TIME
000 s

TRACKING TIME
100 s

TRACKING TIME
** COMPLETE **



TRACKING TIME
100 s

T 0.068 m/s
0.500 m3/h



T 1.359 m/s
10.000 m3/h

4.7.6. How to validate a serial transmission (RS-232C/RS-485)

Description

- Validates a transmission before using the transmission function.

Settable contents

Transmission type, transmission rate, parity, stop bits and slave No.

Settable ranges

Transmission type : RS-232C (factory set) or RS-485.

Transmission rate (baud rate) : 2400 BPS, 4800 BPS, 9600 BPS (factory set), 19200 BPS.

























Parity : NON (factory set), ODD, EVEN.

Stop bits : 1 BIT (factory set), 2 BITS.

Slave No. : 0 (factory set) to 63.

Note: For the transmission specifications, refer to "External communication specifications" in Section 6.1.

For concrete keying, refer to the typical operation indicated below. Set the parameter protection to OFF beforehand (Section 4.4.1).

Typical operation	Select the RS-485, and set the baud rate to 9600 BPS, the parity to "ODD", the stop bits to "1 BIT", and the slave No. to "5".	
Keying order	Description	Indication
	Pressed 4 times to indicate "MAINTENANCE MODE".	MAINTENANCE MODE
		
	Pressed to indicate "CURRENT CALIBRATION".	CURRENT CALIBRATION
		
	Pressed 5 times to indicate "COMMUNICATION".	COMMUNICATION
		
	Pressed to select, and pressed again to blink the 2nd line.	COM. MODE RS-232C
		
	Pressed to indicate "RS-485".	COM. MODE RS-485
		
	Pressed to register it.	COM. MODE ** COMPLETE **
		
		
	---	COM. MODE RS-485
		
	Pressed to indicate "COM. BAUD RATE". Because "9600 BPS" is already selected, go to the next step. If it is desired to select another baud rate, press  key, operate  key for selecting it, and press  key to register.	COM. BAUD RATE 9600 BPS
		
	Pressed to indicate "COM. PARITY".	COM. PARITY NON
		
	Pressed to blink the 2nd line.	COM. PARITY NON
		
	Pressed to indicate "ODD".	COM. PARITY ODD

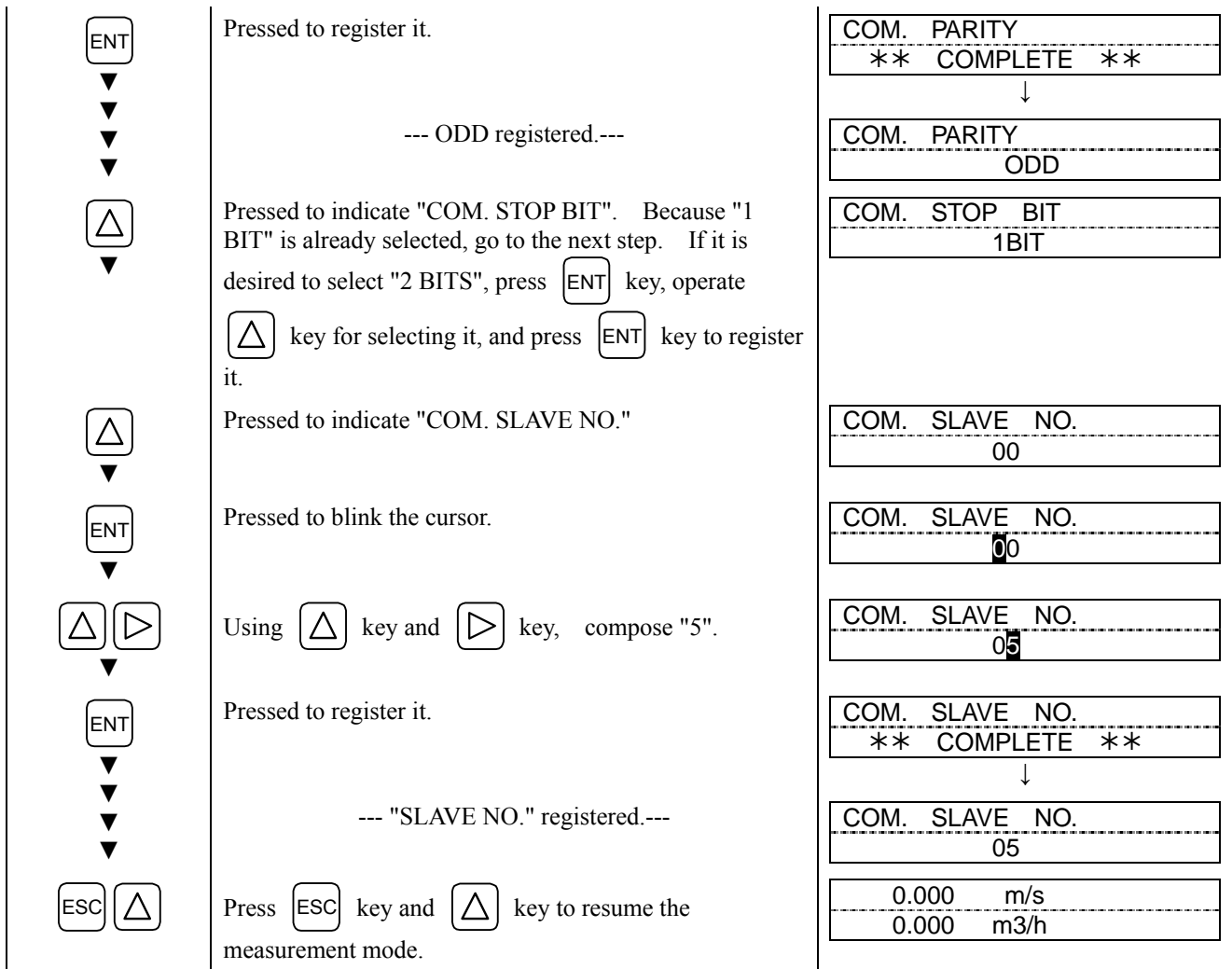

4.7.7. How to validate the synchronization























Description

- Transmits ultrasonic waves according to synchronizing signals from the master flow transmitter.
- Used to avoid the influence by mutual interference between several flow meters located near each other. Used, for example, when they are installed near the same pipe, signal cables pass through the same conduit or there may otherwise be signal interference or crosstalk.
- A reception of synchronizing signal is checked (on slave flow transmitter).

Settable contents

MASTER,SLAVE

For concrete keying, refer to the typical operation indicated below. Set the parameter protection to OFF beforehand (Section 4.4.1).

Typical operation	Select a SLAVE.	
Keying order	Description	Indication
	Pressed 4 times to indicate "MAINTENANCE MODE".	MAINTENANCE MODE
		
	Pressed to indicate "CURRENT CALIBRATION".	CURRENT CALIBRATION
		
	Pressed 6 times to indicate "SYNCHRONIZATION".	SYNCHRONIZATION MASTER
		
	Pressed to blink the 2nd line.	SYNCHRONIZATION MASTER
		
	Pressed to indicate "SLAVE".	SYNCHRONIZATION SLAVE
		
	Pressed to register it.	SYNCHRONIZATION ** COMPLETE **
		
		
		
		
		
		
	Pressed to indicate "SLAVE".	SYNCHRONIZATION SLAVE
		
 	Using  key and  key, resume the measurement mode.	0.000 m/s 0.000 m3/h

4.7.8. How to select the language



















Description

- Can select an indication language (English, Japanese, German, French, Spanish).

Settable contents

ENGLISH (factory set), JAPANESE, GERMAN, FRENCH, SPANISH.

For concrete keying, refer to the typical operation indicated below. Set the parameter protection to OFF beforehand (Section 4.4.1).

Typical operation		
Keying order	Description	Indication
	Pressed 4 times to indicate "MAINTENANCE MODE".	MAINTENANCE MODE
		
	Pressed to indicate "CURRENT CALIBRATION".	CURRENT CALIBRATION
		
	Pressed 7 times to indicate "LANGUAGE".	LANGUAGE ENGLISH
		
	Pressed to blink the 2nd line.	LANGUAGE ENGLISH
		
	Pressed twice to indicate "GERMAN".	LANGUAGE GERMAN
		
	Pressed to register it.	LANGUAGE ** COMPLETE **
		
		
		
	--- "GERMAN" registered.---	↓ SPRACHE DEUTSCH
 	Using  key and  key, resume the measurement mode.	0.000 m/s 0.000 m3/h























4.7.9. How to set the ID No.

Description

- Set the ID No. for protection of parameters (Section 4.4.1.).
If ID No. is set, the number must be inputted before canceling the parameter protection.
- To validate the parameter protection, set the parameter protection to "PROTECTION ON" (see Section 4.4.1.).

ID No. settable range: 0000 to 9999 (4 digits).

For concrete keying, refer to the typical operation indicated below. Set the parameter protection to OFF beforehand (Section 4.4.1).











Typical operation	Set the ID No. to "1106".	
Keying order	Description	Indication
	Pressed 4 times to indicate "MAINTENANCE MODE".	MAINTENANCE MODE
		
	Pressed to indicate "CURRENT CALIBRATION".	CURRENT CALIBRATION
		
	Pressed 8 times to indicate "ID NO."	REGISTER ID NO.
		
	Pressed 2 times to blink the 2nd line.	REGISTER ID NO. 0000
		
 	Press  key and  key for composing "1106".	REGISTER ID NO. 1106
		
	Pressed to register it.	REGISTER ID NO. ** COMPLETE **
		
		
		
		
 	Using  key and  key, resume the measurement mode. Note: To validate the parameter protection, set the parameter protection to "PROTECTION ON".	REGISTER ID NO. **** 0.000 m/s 0.000 m3/h

4.7.10. How to confirm the software version

Description

- Indicates the software version.

For concrete keying, refer to the typical operation indicated below.

Inquire the software version.		
Typical operation	Description	Indication
Keying order		
       	<p>Pressed 4 times to indicate "MAINTENANCE MODE".</p> <p>Pressed to indicate "CURRENT CALIBRATION".</p> <p>Pressed 9 times to indicate "Ver. No."</p> <p>Using  key and  key, resume the measurement mode.</p>	<div style="border: 1px solid black; padding: 2px; text-align: center;">MAINTENANCE MODE</div> <hr style="border-top: 1px dashed black;"/> <div style="border: 1px solid black; padding: 2px; text-align: center;">CURRENT CALIBRATION</div> <hr style="border-top: 1px dashed black;"/> <div style="border: 1px solid black; padding: 2px; text-align: center;">VER. NO FLR 00A</div> <hr style="border-top: 1px dashed black;"/> <div style="border: 1px solid black; padding: 2px; text-align: center;">0.000 m/s 0.000 m3/h</div>

5. MAINTENANCE AND CHECKUP

5.1. Routine checkup

Visually check the following items.

- Whether flow transmitter cover screws are loose. → Retighten.
- Whether cable glands are loose. → Retighten.
- Whether detector mounting band is loose. → Tighten.
- Whether received wave is abnormal (LED lit red). → Check whether piping is filled or not. Remove bubbles or foreign matters, if mixed in measurement pipe. Also check if detector mounting and wiring are normal.

5.2. Periodic checkup

5.2.1. Checking the zero point

Stop the fluid flow, fill the measurement pipe fully, and check the zero point.

5.2.2. Reapplying silicon-free grease

When using silicon-free grease for the acoustic coupler, reapply it on the transmission surface of the sensor unit approximately once every 6 months.

- How to remove the sensor unit Refer to 3.5.5.
- How to mount the sensor unit Refer to 3.5.4.

Note: Silicon rubber need not be reapplied.

5.2.3. How to measure the insulation resistance

CAUTION

- Turn off power before opening the flow transmitter cover.
- Arresters are connected to each of power terminals (N, L) in standard, and arresters can be connected to each of output terminals (Iout, DO1, DO2) optionally. Before measuring the insulation resistance between a power terminal and grounding terminal, remove the grounding plate from inside the terminal box as illustrated below. Before measuring the insulation resistance between each of the said output terminals and grounding terminal (GND), remove an arrester board, if provided optionally.
- The insulation resistance performance is 100 M Ω /500 V DC.
- After the end of test, return the grounding plate and arrester board in place.

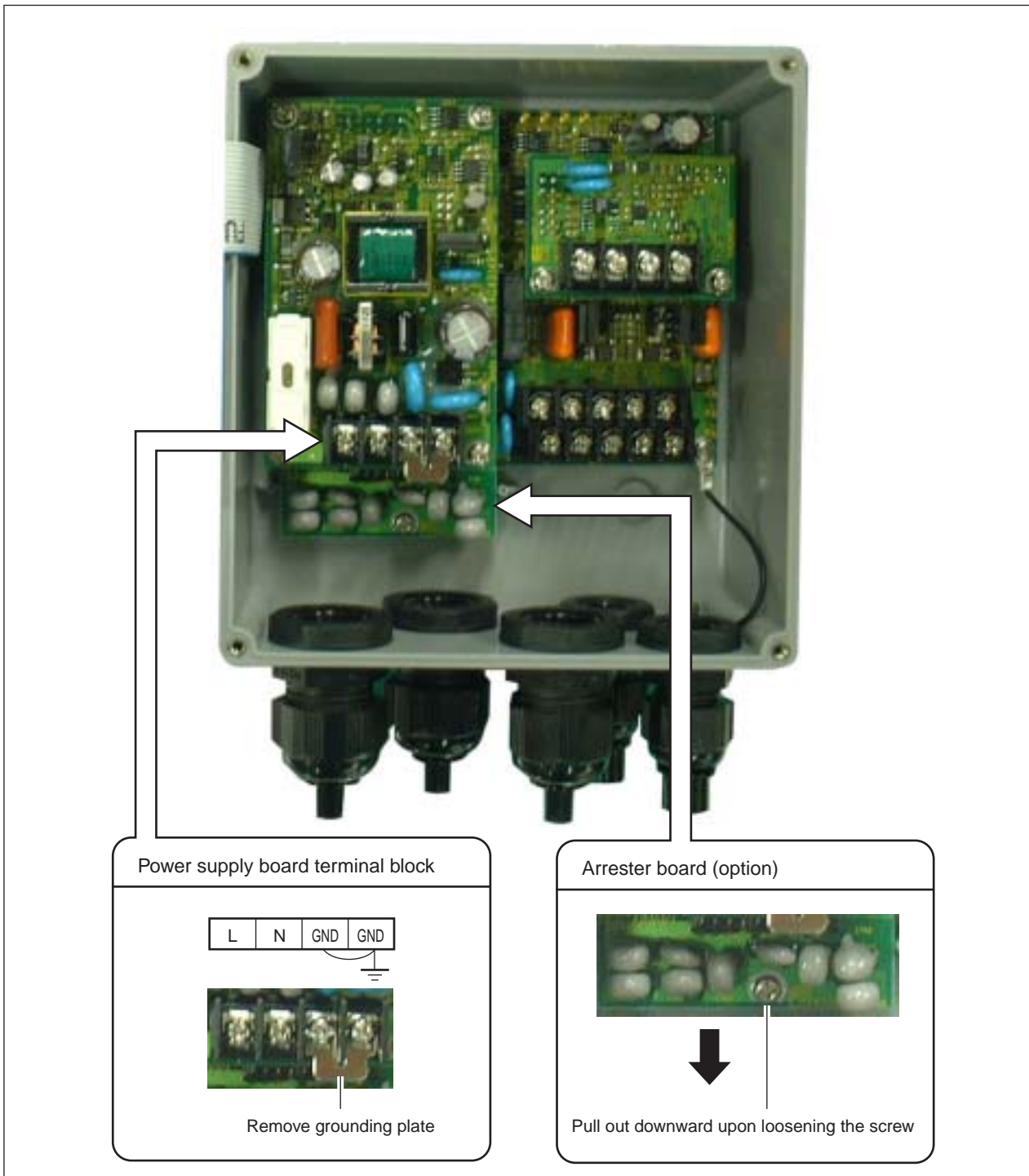

5.3. How to replace the fuse



CAUTION

- Turn off power before replacing the fuse.
- Fuse specifications
 - (1) AC power source (100 or 200 V): 5.2 mm (diameter) × 20 mm (long), 250 V, 0.5 A.
As represented by Fuji Terminal Industry Co., Ltd.FGMB: 250 V, 0.5 A.
 - (2) DC power source: 5.2 mm (diameter) × 20 mm (long), 250 V, 1 A.
As represented by Fuji Terminal Industry Co., Ltd.FGMB: 250 V, 1 A.

- (1) Opening the cover after turning off power
Loosen 4 screws from the flow transmitter front, and open the cover.
- (2) Replacing the fuse
Detach the fuse holder from the power supply board, and replace the fuse. Then, return the fuse holder in place.
- (3) Closing the cover
Close the cover, and tighten 4 screws.

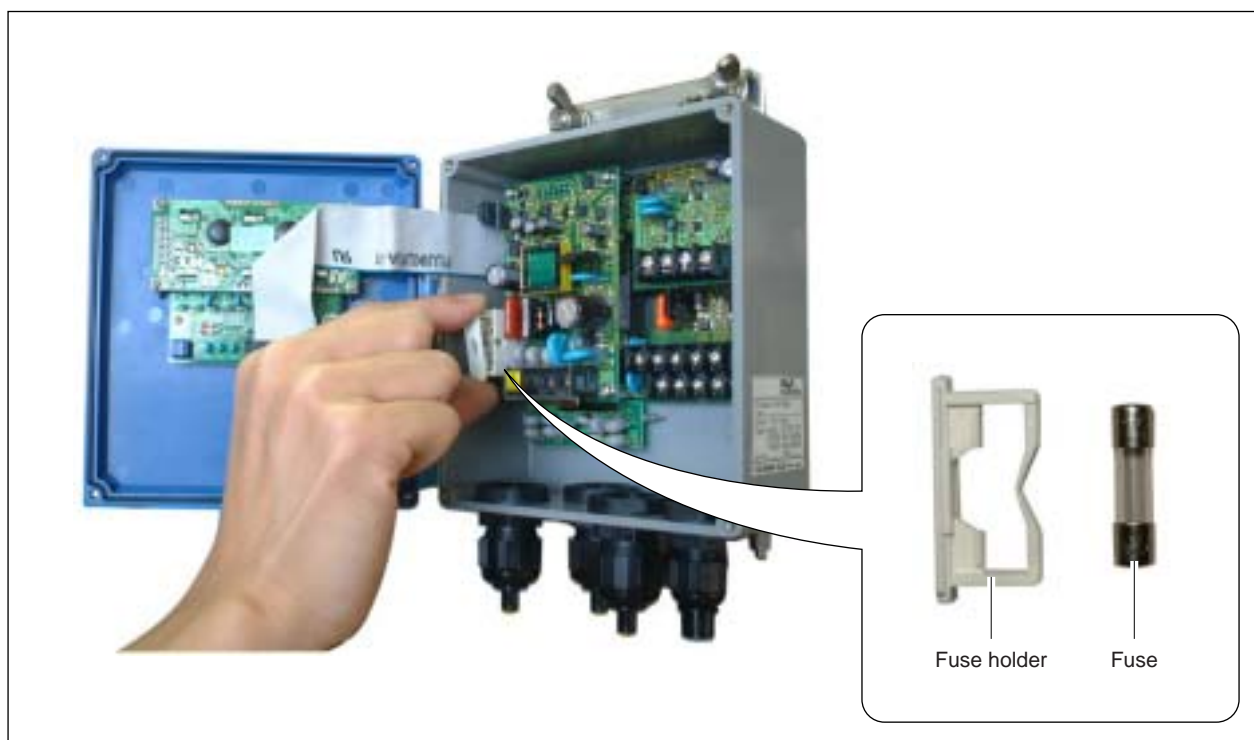

CAUTION

- Turn on power only after closing the cover.

5.4. How to replace the relay

DO2 is a relay contact, whose life is 200,000 operations (rated load).

Replace it before the end of its life estimating the number of contact operations.

Card relay type: RB104-DY (made by Fuji Electric)

[Replacing method]

- (1) Turn off power, and open the cover.
- (2) From the socket, pull out the card relay shown below.
- (3) Position a new card relay into the socket. Push it enough to engage the card relay claws.
- (4) Close the cover, and turn on power.
- (5) Set the maintenance mode to "STATUS OUTPUT", and check the relay ON and OFF actions.



CAUTION

- Turn off power before opening the cover. A high voltage is inside.

Relay dismantling procedure

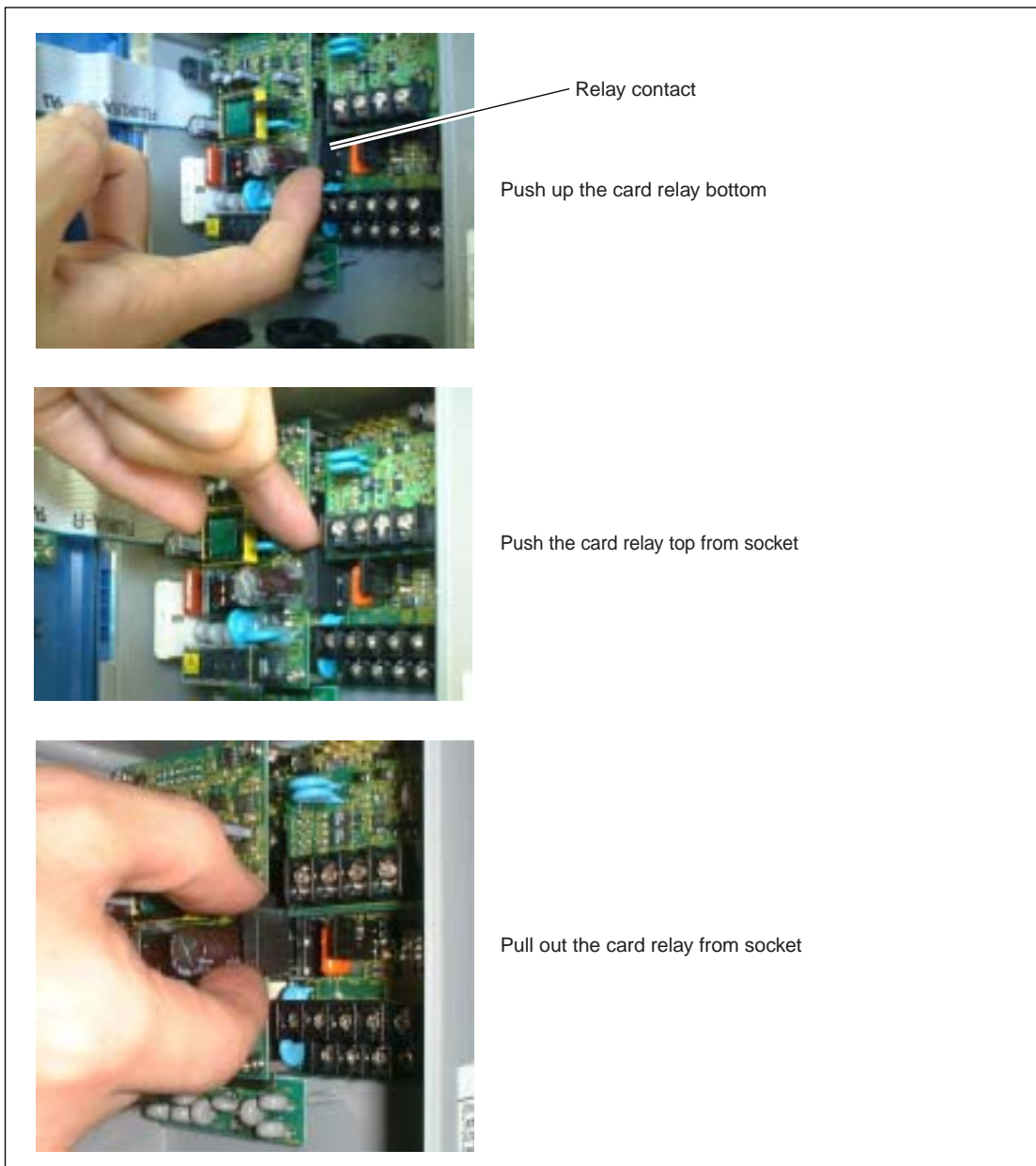

5.5. How to replace the LCD

The nominal life of the LCD is 7 years. Its contrast deteriorates gradually. Replace it about 5 years after starting its use.

[How to replace]

- (1) Turn off power, and open the cover.
- (2) Disengage the flat cable connector.
- (3) Loosen 6 screws from the LCD unit.
- (4) Mount a new LCD unit (see parts list), inserting the operation keys and LED properly into the cover holes so as not to be pushed nor pinched by the cover.
- (5) Engage the flat cable connector (securely all the way).
- (6) Close the cover, and turn on power.
- (7) Make sure the LCD indication is normal, and that keying can be conducted properly.





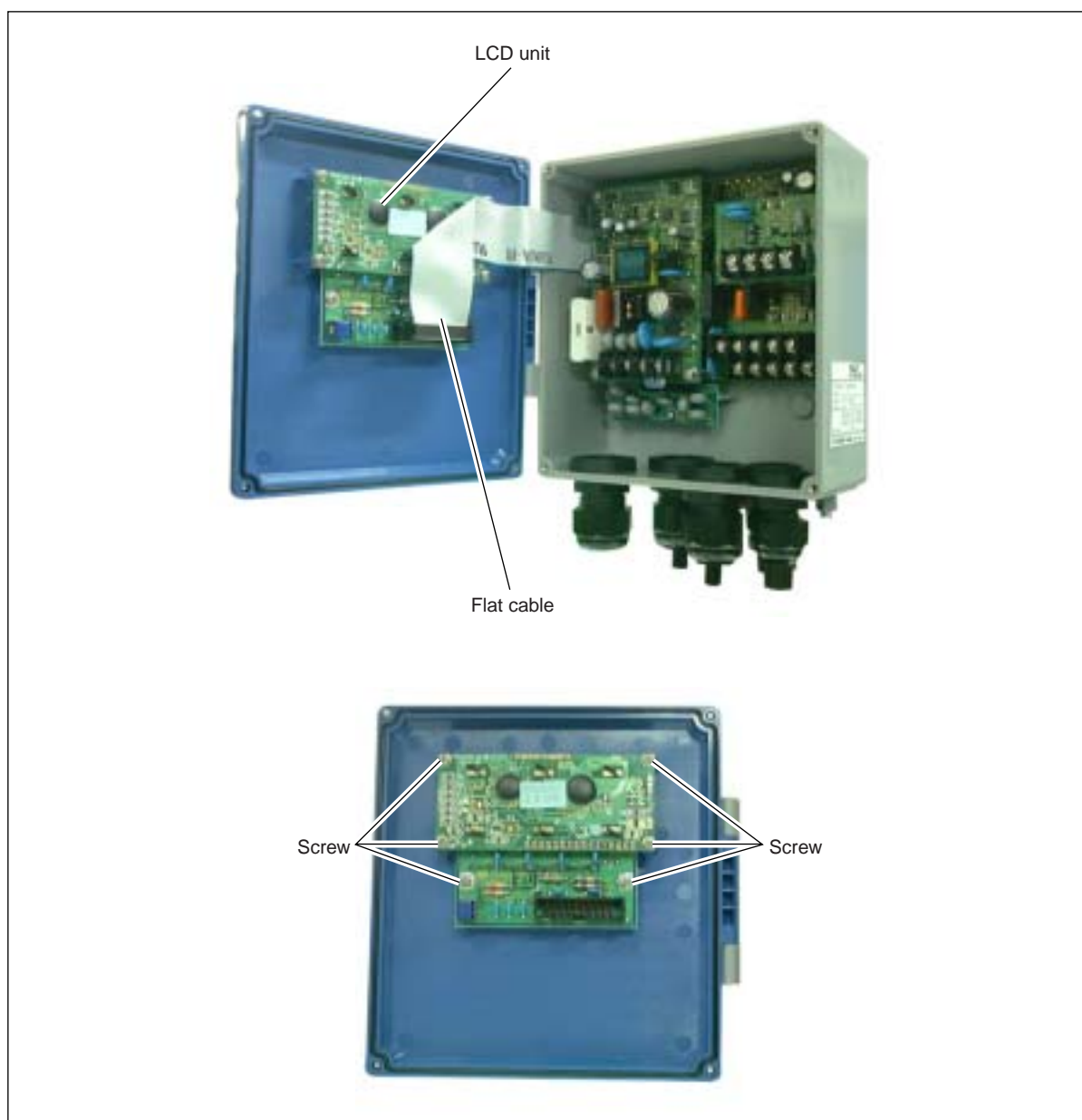

CAUTION

- Turn off power before opening the cover. A high voltage is inside.



5.6. Troubleshooting

5.6.1. If indication is abnormal

Symptom	Cause
 <p>Nothing is indicated</p>	<ul style="list-style-type: none"> ● Power is not turned on. ● Source voltage is too low. ● Fuse is blown. ● LCD is defective. → To "Section 5.6.6. Remediating a hardware fault". ● DC power polarity is inverted.
 <p>1st line is indicated black</p>	<ul style="list-style-type: none"> ● Source voltage is too low. ● DC power polarity is inverted. ● LCD is defective. → To "Section 5.6.6. Remediating a hardware fault".
 <p>Indication is undefined</p>	<ul style="list-style-type: none"> ● Hardware error. → To "Section 5.6.6. Remediating a hardware fault".
 <p>Indication is dim</p>	<ul style="list-style-type: none"> ● Ambient temperature is too low (below -20°C). → Raise the temperature. ● End of LCD unit life. → Replace the LCD unit.
 <p>Entirely black</p>	<ul style="list-style-type: none"> ● Ambient temperature is too high (50°C or higher). → Lower the temperature.
<p>LED is lit red</p>	<ul style="list-style-type: none"> ● Received wave is abnormal. → Check the following points. <ol style="list-style-type: none"> (1) Whether pipe is filled completely. (2) Ingress of bubbles. (3) Sensor cable connection. (4) Sensor unit mounting as to sensor unit spacing, orientation and positions. (5) Coating of silicone rubber or silicone-free bonding agent. (6) Piping status (whether scales are present or lining material is peeled).

5.6.2. If keying is abnormal

Symptom	Cause
Keying is not responded	<ul style="list-style-type: none"> ● Hardware error. → To "Section 5.6.6. Remediating a hardware fault".
Certain key is not responded. Action is not as defined.	

5.6.3. If measurement value is abnormal

Symptom	Cause	Remedy
Minus (-) symbol indicated on measurement value.	<ul style="list-style-type: none"> ● Connection between main unit and sensor units (upstream, downstream) are inverted. 	→ Connect correctly.
	<ul style="list-style-type: none"> ● So is actual flow. 	
Measurement value fluctuates excessively while flow rate is constant.	<ul style="list-style-type: none"> ● Straight part of pipe is not enough. 	→ Select where 10D upstream and 5D downstream can be secured.
	<ul style="list-style-type: none"> ● Pump, valve or others which disturb the flow are located nearby. 	→ Separate them at least 30D.
	<ul style="list-style-type: none"> ● Pulsation exists actually. 	→ Set the damping to longer response time.
Measurement value does not change while flow rate does (LED lit red).	Ultrasonic wave is not propagated into piping, whereby reading is held.	
	1. Installation is poor.	
	<div style="border: 1px solid black; padding: 5px;"> <ul style="list-style-type: none"> ● Pipe specifications are wrong. ● Sensor is mounted on welding. ● Sensor mounting dimensions are wrong. ● Silicone filler is not applied properly when mounting the sensor ● Sensor cable connection is poor. </div>	→ <div style="border: 1px solid black; padding: 5px;">Upon checking, remove the sensor, apply silicone filler, and slightly off-position the sensor.</div>
	<div style="border: 1px solid black; padding: 5px;"> Sensor mounting is poor <ul style="list-style-type: none"> ● Mounting dimensions. ● There is a gap between sensor and piping. </div>	→ <div style="border: 1px solid black; padding: 5px;"> <ul style="list-style-type: none"> ● Mount the sensor in parallel with pipe, allowing correct sensor unit spacing. ● Mount the sensor properly so that it is kept in close contact with the pipe. </div>
	2. Pipe or fluid is problematic.	
	◎ <div style="border: 1px solid black; padding: 2px;">Not completely filled.</div>	→ <div style="border: 1px solid black; padding: 5px;"> Locate a place which is completely filled on the same piping line, and shift the sensor there. <ul style="list-style-type: none"> ● Mount the sensor at lowermost position on piping line. </div>
◎ <div style="border: 1px solid black; padding: 2px;">Ingress of bubbles</div>	→ <div style="border: 1px solid black; padding: 5px;"> Eliminate ingress of bubbles. <ul style="list-style-type: none"> ● Raise the pumping well level. ● Check the pump shaft seal. ● Retighten the negative pressure piping flange. ● Avoid a flow as cascade to pumping well. Shift the sensor where bubbles are not introduced. <ul style="list-style-type: none"> ● Upstream the pump. ● Upstream the valve. </div>	
		(To be continued)

Symptom	Cause	Remedy
(Continued from preceding page)	<p>⊙ Excessively turbid.</p> <p>[More turbid than inflow sewage water or return sludge.] →</p> <p>⊙ Scales are on inside wall of old pipe. →</p> <p>⊙ Lining is thick.</p> <p>[Mortar lining or the like is several ten mm thick.] →</p> <p>⊙ Lining is peeled.</p> <p>[There is a gap between lining and pipe.] →</p> <p>⊙ Sensor is mounted on bend pipe or tapered pipe. →</p> <p>3. Influence by external noise. →</p> <p>[• There is radio broadcasting station nearby. • There is heavy traffic of automobiles, trains, etc. near the measurement site.] →</p> <p>4. Hardware error. →</p>	<div style="border: 1px solid black; padding: 5px; margin-bottom: 10px;"> <ul style="list-style-type: none"> ● Move the sensor to smaller pipe diameter on the same line. ● Move the sensor to another place or pipe. </div> <p style="border: 1px solid black; padding: 2px; margin-bottom: 10px;">Mount the sensor on straight pipe.</p> <div style="border: 1px solid black; padding: 5px; margin-bottom: 10px;"> <ul style="list-style-type: none"> ● Reduce the length of main unit-sensor cable to a minimum. ● Connect the main unit and pipe to ground. </div> <p style="border: 1px solid black; padding: 2px;">See "Section 5.6.6. Remediying a hardware fault. "</p>
Measurement value is not zero while water is at standstill.	<ul style="list-style-type: none"> ● Water convection in pipe. → ● After zero adjustment. → ● Pipe is not completely filled or is empty when water is at a standstill (LED lit red). → 	<p style="border: 1px solid black; padding: 2px; margin-bottom: 10px;">Normal.</p> <div style="border: 1px solid black; padding: 5px; margin-bottom: 10px;"> <ul style="list-style-type: none"> ● Recommence zero adjustment at a status where water is completely at a standstill. </div> <p style="border: 1px solid black; padding: 2px;">Normal.</p>

Symptom	Cause	Remedy
<p>Measurement value contains an error.</p>	<ul style="list-style-type: none"> ● Inputted pipe specifications are different from actual values. 	<p>Difference in inner diameter of 1% produces about 3% of error.</p>
	<ul style="list-style-type: none"> ● Scales exist on wall of old pipe. 	<ul style="list-style-type: none"> ● Input correctly. ● When inputting, regard the scales as lining.
	<ul style="list-style-type: none"> ● Straight part of pipe is not enough (10D upstream and 5D downstream cannot be secured). 	<p>Find a better place for mounting the sensor (upstream the disturbance).</p> <p>[There must be no disturbance within 30D upstream. Pump, valve, joint pipe, etc. are not allowed.]</p> <ul style="list-style-type: none"> ● Mount the sensor at different angles with respect to pipe cross-section until an average is obtained.
	<ul style="list-style-type: none"> ● Pipe is not filled with water or is loaded with mud and sand. 	<p>Reading rises as cross-sectional area reduces.</p> <ul style="list-style-type: none"> ● Move to vertical pipe.

5.6.4. If analog output is abnormal

Symptom	Cause	Remedy
Current output is erroneous.	Range setting is wrong.	→ ● Set the range correctly.
Not 4 mA when measurement value is 0.	Analog output is maladjusted.	→ ● Calibrate the analog output.
Output is 0 mA.	Cable is open-circuited.	
Output is over 20 mA.	"OVERFLOW" is indicated on LCD.	→ Range over. ● Recommence setting of range data of analog output.
Output is below 4 mA.	"UNDERFLOW" is indicated on LCD.	→ Back flow ● Set the upstream and downstream properly.
Measurement value varies but analog output is constant.	Output load is above 600 Ω.	→ ● Lower the load below 600 Ω.
Analog output does not match the measurement value.	Analog output is maladjusted.	→ ● Calibrate the analog output.
Output remains unchanged even after analog output calibration.	Hardware error.	→ ● Contact us.

5.6.5. How to check the received waveform



CAUTION

- A high voltage is applied. Be sure to entrust the following work to our serviceman.

5.6.5.1. How to connect the oscilloscope

Open the cover and, according to the following diagram, connect the oscilloscope to check pins on the printed circuit board.

A high voltage is applied. Do not touch other than so allowed points given below.

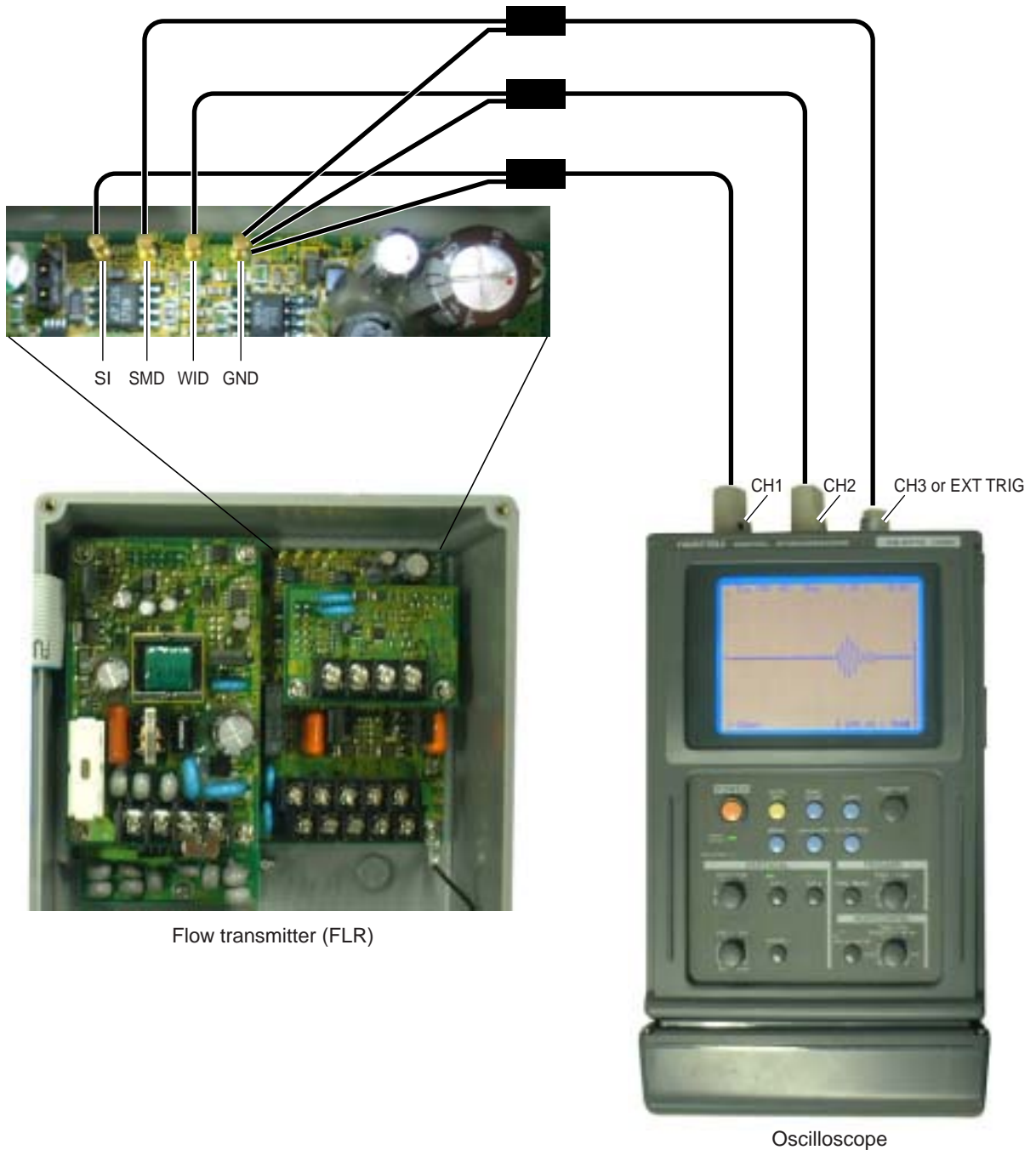

5.6.5.2. Checking the received waveform

Monitor the waveform, and check the status of received waveform.

Window and received signal

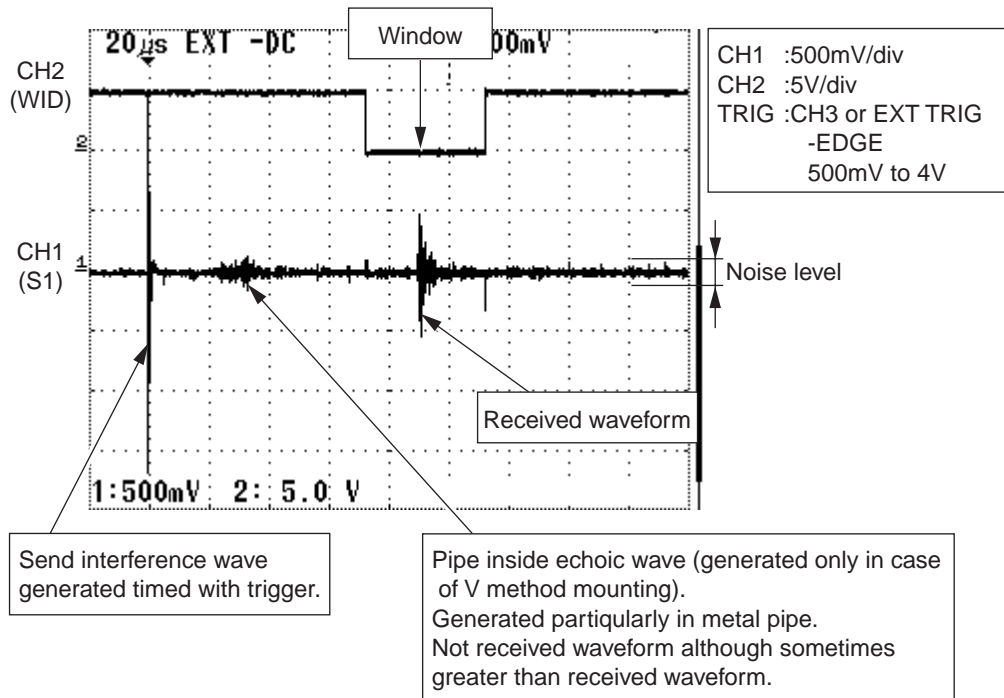

Points

1. The received waveform must exist in LOW zone (window) at WID level of CH2 (WID). If off-positioned, check the piping parameters.
2. The magnitude of received waveform must be about 1 Vpp.
 - (1) If lower than 1 Vpp: The reception sensitivity is too low. Take an action referring to the item of "Measurement value does not change while flow rate does (LED lit red)" in "Section 5.6.3 If measurement value is abnormal".
 - (2) If higher than 1 Vpp: The flow transmitter may be faulty. Specify details of anomaly to us.
3. The overall noise level must be lower than 0.2 Vpp. Excessive noise may be caused by the following.

Cause	Check
Special cable is faulty.	Check the continuity, and measure the insulation resistance.
Polarity of connected terminals is inverted.	Check the connection.
Detector is mounted erroneously (S/N deteriorated).	Take action referring to item "Measurement value does not change while flow rate does (LED lit red)" in "Section 5.6.3 If measurement value is abnormal".
Influence by external noise.	
Detector bonding surface is peeling.	Peel off the detector and recommence the mounting.
Wiring is poor.	Whether special signal cable is passed through metal conduit or wired together with power cable or heavy duty line.
Poor contact.	

Detail of received waveform

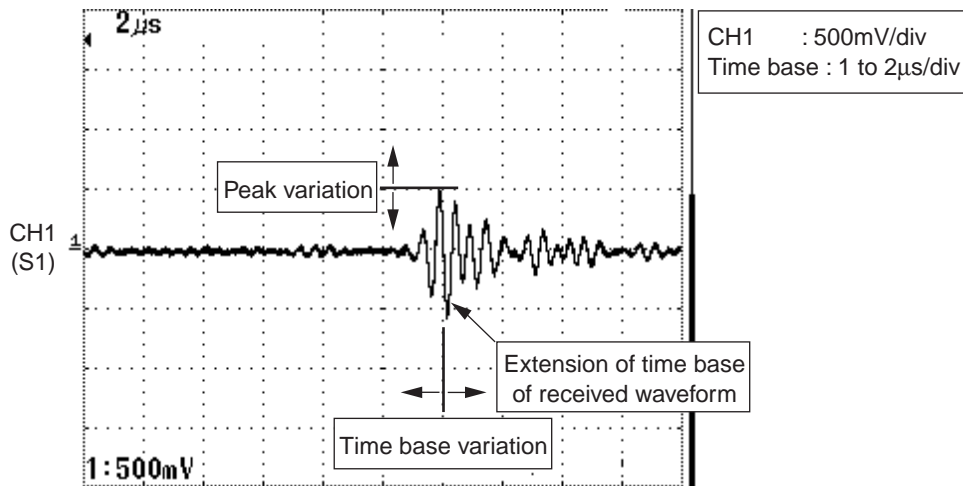

Points

1. Before reaching the maximum amplified signal wave, the number of waves must be 3 to 5. If the startup of received waveform is not sharp enough, then the piping parameter input may be wrong or the detector mounting may be not proper. Check the piping parameters, and how the detector is mounted referring to "Measurement value does not change while flow rate does (LED lit red)" in "Section 5.6.3 If measurement value is abnormal".
2. Peak (amplitude) variations are not allowed. If peaks fluctuate up and down, bubbles are mixed. Take an action referring to the item of "Ingress of bubbles" of "Measurement value does not change while flow rate does (LED lit red)" in "Section 5.6.3 If measurement value is abnormal".
3. The time base must not fluctuate. If it does, there may be influence by turbulent flow or drift current. Take an action referring to the item of "Measurement value fluctuates excessively while flow rate is constant." in "Section 5.6.3 If measurement value is abnormal".

5.6.6. Remediating a hardware fault

If the hardware is found faulty upon interventions in Section 5.6.1 to Section 5.6.5 above, specify details of anomaly to us.

6. APPENDIXES

6.1. External communication specifications

6.1.1. Communication specifications

Item		Description
Communication interface		RS-232C RS-485
Communication distance		15m 1km
Communication method		Half duplex start-stop synchronization
Communication procedure		Message method
Baud rate		2400, 4800, 9600, 19200bps
Communication mode		ASCII mode
Data format	Start	1 bit
	Data	Hexadecimal ASCII expression (8 bits)
	Parity	None, odd, even
	Stop	1, 2 bits
Error check		LRC (logical redundancy check)

6.1.2. Message configuration

6.1.2.1. Reception

Description	Bytes	Remarks
Start mark	1	: (3Ah)
Slave address (SLV)	2	01 to 31
Function code (F_CD)	4	See function code table.
Error check	2	LRC
End mark	1	CR (0Dh)
	1	LF (0Ah)

6.1.2.2. Acknowledge

Description	Bytes	Remarks
Start mark	1	: (3Ah)
Slave address (SLV)	2	01 to 31
Function code (F_CD)	4	See function code table.
Data length (L)	2	
Data	2L	
Error check	2	LRC
End mark	1	CR (0Dh)
	1	LF (0Ah)

6.1.2.3. Error acknowledge

Description	Bytes	Remarks
Start mark	1	: (3Ah)
Slave address (SLV)	2	01 to 31
Function code (F_CD)	4	See function code table.
Error data	2	See error data table.
Error check	2	LRC
End mark	1	CR (0Dh)
	1	LF (0Ah)

Receive format



Acknowledge format

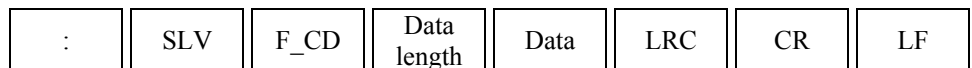

Error acknowledge format

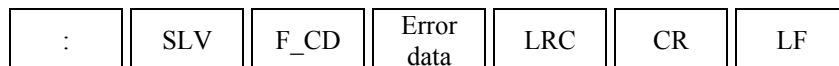

6.1.3. Error check

Arrange the LRC so that the sum (carry not included) of all ASCII data excluding ":", "CR" and "LF" will be 00h.

[LRC creation procedure]

- (1) Add the data headed by the start mark (:) excluding the carry.
- (2) Obtain 2's complement for the sum.
- (3) Convert the 2's complement into ASCII (= LRC).

6.1.4. Function code table

Description	F CD	Remarks
Flow velocity (data 1: measuring path 1)	0300	
Flow rate (Data 1: measuring path 1)	0310	
Forward integrated value (data 1: measuring path 1)	0320	
Reverse integrated value (data 1: measuring path 1)	0330	
Current output % (data 1: measuring path 1)	0340	
Status (data 1: measuring path 1)	0100	

Note: If an error has occurred, the error acknowledge function code is as follows.

Function code: 0300 → 8300

6.1.5. Error code table

Error data	Remarks
01	Function code error (function code undefined)
02	LRC error
03	Reserve
04	Reserve
05	Reserve

6.1.6. Cable connection specifications (RS-232C)

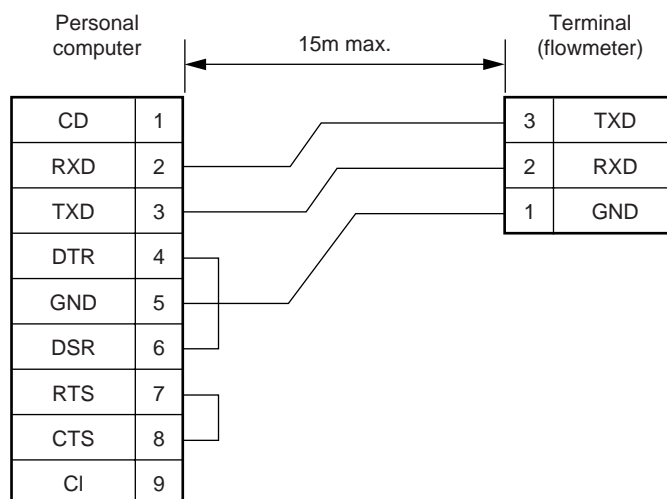

6.2. Specifications

Operational specifications

System configuration:

The system is composed of a detector (Model FLS...1) and a flow transmitter (Model FLR...1), realizing single-path system.

Application:

Liquid flow without aeration that ultrasonic wave can propagate (purified water, cooling water, corrosive liquids, cooling/heating medium, etc.)

Turbidity: 10000deg (mg/L) or less

Fluid temperature: -20 to +100deg.C

(With silicon rubber for

acoustic couplant)

0 to +60deg.C

(With silicon-free grease for

acoustic couplant)

Type of flow: Well-developed turbulent or laminar flow in a full-filled pipe

Applicable flow pipe:

Pipe size: 25 to 100mm (FLSE1) or 50 to 225mm (FLSE2) for plastic pipes
50 to 100mm (FLSE1) or 50 to 225mm (FLSE2) for metal pipes

Material: Plastics (PVC, PVDF*, PEEK, PP*, FRP, etc.) or Metals (Carbon steel, SS, copper, aluminum, etc.)

Note) *Measurement may not be made depending on diameter and thickness of the pipe. Contact us for details.

Liner: Tar epoxy, mortar, rubber, and others

Fundamental straight pipe:

10D for upstream and 5D for downstream (D: pipe diameter)
Refer to "Conditions on straight pipe" for details.

Velocity:

0 to ±0.3 ... ±10m/s

Power supply:

100 to 120V AC ±10%, 50/60Hz or 200 to 240V AC ±10%, 50/60Hz or 20 to 30V DC

Signal cable:

RF co-axial cable up to 30m with water-proof BNC at one end and thermal stability of 100 deg.C

Environment:

Non-explosive environment without direct sunlight, corrosive gas and heat radiation

Ambient temperature:

-20 to +50deg.C for flow transmitter

-20 to +60deg.C for detector

Ambient humidity:

90%RH or less

Grounding:

Class D (less than 100 ohm)

Synchronization (option):

Cross-talk when located closely or acoustic interference when installed on the same pipe line removable by simultaneous transmission of ultrasonic waves

Number of connectable units: up to 31

Cable length: up to 15m

Master/Slave selectable

Arrester (option):

Arrester unit for outputs available (while arrester for power supply incorporated as standard)

Performance specifications

Accuracy:

Pipe size (inside dia.)	2m/s or more	Less than 2m/s
25 to less than 50mm	±3% of rate	±0.06m/s
50 to 225mm	±2% of rate	±0.04m/s

Response time:

System cycle: 0.2s

Dead time: less than 0.2s, Time constant: 0.1s

Power consumption:

15VA or less for AC power supply

5W or less for DC power supply

Permissible air volume rate:

Up to 0.2% at 1 m/s (inversely proportional to velocity)

Short-term thermal stability:

140deg.C, 30min

Functional specifications

Analog output:

4 to 20 mA DC (1 point)

Max. load resistance : 600 ohm

Digital output:

+ total, - total, alarm, acting range, flow switch or total switch arbitrarily available

Transistor open collector:

1 point (DO1)

Normal off/on selectable

Capacity: 30V DC, 0.1A

Total pulse: 1pulse/day to 100pps

(Pulse width: 5, 10, 50, 100 or 200ms)

Mechanical relay contact: 1point (DO2), with socket (exchangeable)

Normal close/open selectable

Capacity: 220V AC /30V DC, 1A (resistive load)

Mechanical expected life:

More than 2×10^7 operations

Total pulse: 1pulse/day to 1pps

(Pulse width: 50, 100 or 200ms)

Communication interface (option):

RS-232C equivalent / RS-485

Number of connectable units:

one (RS-232C)/ up to 31 (RS-485)

Baud rate: 2400/4800/9600/19200 bps selectable

Parity: None/Odd/Even selectable

Stop bit: 1 or 2 bits selectable

Cable length: up to 15m (RS-232C)/up to 1km (RS-485)

Data: Velocity, flow rate, +total, -total, status, etc.

Display device:

2-color LED (Normal: green, Extraordinary: red) LCD with 2 lines of 16 characters and back light

Display language:

English, French, German or Spanish selectable

Velocity/Flow rate display:

Display of velocity and/or flow rate with flow direction

Number: 7digits (decimal point be counted as 1 digit)

Unit: Metric/Inch system selectable

	Metric system	Inch system
Velocity	m/s	ft/s
Flow rate	L/s, L/min, L/h, ML/d, m ³ /s, m ³ /min, m ³ /h, Mm ³ /d, BBL/s, BBL/min, BBL/h, MBBL/d	gal/s, gal/min, gal/h, Mgal/d, ft ³ /s, ft ³ /min, ft ³ /h, Mft ³ /d, BBL/s, BBL/min, BBL/h, MBBL/d

Note: The "gal" means USgal.

Total display:

Display of forward or reverse total

Number: 8digits (decimal point be counted as 1digit)

Unit: Metric/Inch system selectable

	Metric system	Inch system
Total	mL, L, m ³ , km ³ , Mm ³ , mBBL, BBL, kBBL	gal, kgal, ft ³ , kft ³ , Mft ³ , mBBL, BBL, kBBL, ACRE-in, ACRE-ft

Configuration:

Fully configurable from the 4-key pad (ESC, ▽, ▷, ENT) on the surface of flow transmitter's housing case by menu-driven software

Zero adjustment:

Set zero/Clear available

- Damping:** 0 to 100s (every 1s) configurable for analog output and display
- Low flow cut off :** 0 to 5m/s configurable
- Alarm:** Hardware fault/Process fault applicable to digital output
- Burnout:** Analog output : Hold/Over-scale/Under-scale /Zero selectable
 Total: Hold/Count selectable
 Working timer : 0 to 100s (every 1s) configurable
- Bi-directional range:** Forward and reverse ranges configurable independently
 Hysteresis: 0 to 10% of acting range configurable
 Acting range applicable to digital output
- Auto-2 ranges:** Forward 2 ranges configurable independently
 Hysteresis: 0 to 10% of acting range configurable
 Acting range applicable to digital output
- Flow switch:** Lower and upper switching points configurable independently
 Acting point applicable to digital output
- Total switch:** +total switching point configurable
 Acting point applicable to digital output

Physical specifications

- Enclosure protection:** IP65 for both flow transmitter and detector (When water-proof BNC is applied)
- Mounting:** Flow transmitter: Wall/2B pipe mount
 Detector: Clamped on pipe surface
- Acoustic coupler:** Silicon rubber or silicon-free grease
- Material:** Flow transmitter: Plastic ABS
 Detector: Plastic PBT for sensor housing, 304SS for frame
- Sensor cable:** 3D2V with outside diameter 5mm
- Dimensions:** Flow transmitter: H140 × W139 × D68mm
 Detector: H28 × W240 × D50mm for FLSE1
 H28 × W360 × D50mm for FLSE2
- Mass:** Flow transmitter: 0.8kg
 Detector: 0.3kg (FLSE1) / 0.4kg (FLSE2)

6.3. Dimension diagram

Flow transmitter (type: FLR)

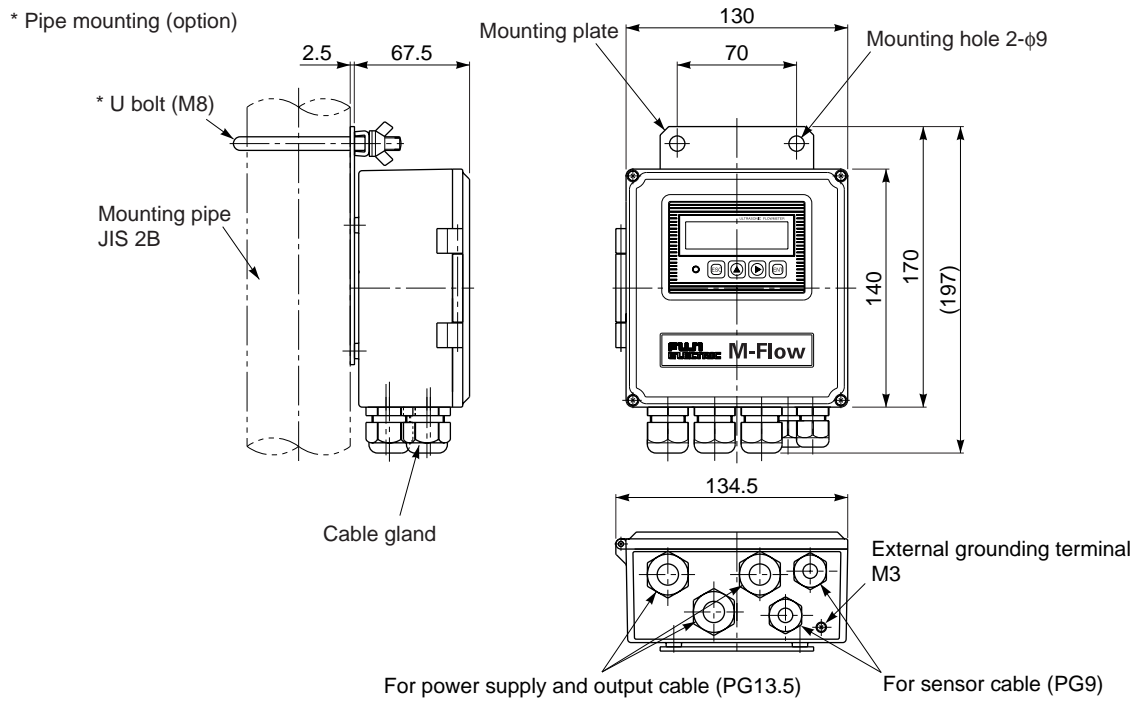

Detector (type: FLS)

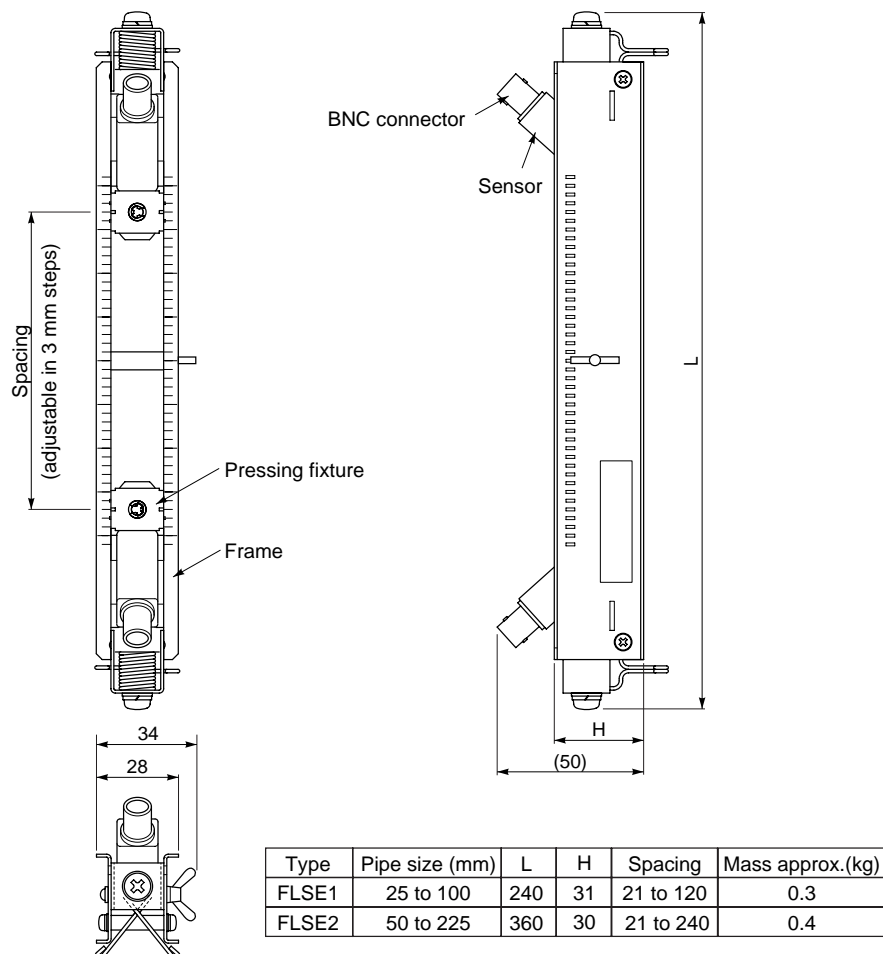

6.4. Scope of delivery

Flow transmitter (type: FLR) : Flow transmitter proper, instruction manual

Detector (type: FLS) : Detector set (1 frame, 2 sensor units), stainless steel belt (1 set), silicone rubber or silicone-free grease (option)

Signal cable (type: FLY) : Cable provide on a side with waterproof connector (1 pair, length specified by type)

6.5. Items to be specified at order

1. Detector type
2. Flow transmitter type
3. Signal cable type
4. Tag No. (if tag is provided)

6.6. Piping data

Stainless steel pipe for pipe arrangement (JIS G3459-1988)

Nominal diameter (mm)		Outer diameter (mm)	Normal thickness						
			Schedule 5S	Schedule 10S	Schedule 20S	Schedule 40	Schedule 80	Schedule 120	Schedule 160
A	B		Thickness (mm)	Thickness (mm)	Thickness (mm)	Thickness (mm)	Thickness (mm)	Thickness (mm)	Thickness (mm)
15	1/2	21.7	1.65	2.1	2.5	2.9	3.9	—	5.5
20	3/4	27.2	1.65	2.1	2.5	2.9	3.9	—	5.5
25	1	34.0	1.65	2.8	3.0	3.4	4.5	—	6.4
32	1 1/4	42.7	1.65	2.8	3.0	3.6	4.9	—	6.4
40	1 1/2	48.6	1.65	2.8	3.0	3.7	5.1	—	7.1
50	2	60.5	1.65	2.8	3.5	3.9	5.5	—	8.7
65	2 1/2	76.3	2.1	3.0	3.5	5.2	7.0	—	9.5
80	3	89.1	2.1	3.0	4.0	5.5	7.6	—	11.1
90	3 1/2	101.6	2.1	3.0	4.0	5.7	8.1	—	12.7
100	4	114.3	2.1	3.0	4.0	6.0	8.6	11.1	13.5
125	5	139.8	2.8	3.4	5.0	6.6	9.5	12.7	15.9
150	6	165.2	2.8	3.4	5.0	7.1	11.0	14.3	18.2
200	8	216.3	2.8	4.0	6.5	8.2	12.7	18.2	23.0
250	10	267.4	3.4	4.0	6.5	9.3	15.1	21.4	28.6
300	12	318.5	4.0	4.5	6.5	10.3	17.4	25.4	33.3
350	14	355.6	—	—	—	11.1	19.0	27.8	35.7
400	16	406.4	—	—	—	12.7	21.4	30.9	40.5
450	18	457.2	—	—	—	14.3	23.8	34.9	45.2
500	20	508.0	—	—	—	15.1	26.2	38.1	50.0
550	22	558.8	—	—	—	15.9	28.6	41.3	54.0
600	24	609.6	—	—	—	17.5	34.0	46.0	59.5
650	26	660.4	—	—	—	18.9	34.0	49.1	64.2

Polyethylene pipe for city water (JIS K6762-1982)

Nominal diameter (mm)	Outer diameter (mm)	1st type (Soft pipe)		2nd type (Hard pipe)	
		Thickness (mm)	Weight (kg/m)	Thickness (mm)	Weight (kg/m)
13	21.5	3.5	0.184	2.5	0.143
20	27.0	4.0	0.269	3.0	0.217
25	34.0	5.0	0.423	3.5	0.322
30	42.0	5.5	0.586	4.0	0.458
40	48.0	6.5	0.788	4.5	0.590
50	60.0	8.0	1.210	5.0	0.829

Galvanized steel pipe for city water SGPW (JIS G3442-1988)

Nominal pipe		Outer diameter (mm)	Thickness (mm)
(A)	(B)		
15	1/2	21.7	2.8
20	3/4	27.2	2.8
25	1	34.0	3.2
32	1 1/4	42.7	3.5
40	1 1/2	48.6	3.5
50	2	60.5	3.8
65	2 1/2	76.3	4.2
80	3	89.1	4.2
90	3 1/2	101.6	4.2
100	4	114.3	4.5
125	5	139.8	4.5
150	6	165.2	5.0
200	8	216.3	5.8
250	10	267.4	6.6
300	12	318.5	6.9

Asbestos cement pipe for city water (JIS A5301-1971)

Nominal diameter (mm)	1st type		2nd type		3rd type		4th type	
	Thickness of connected portion (mm)	Outer diameter of connected portion (mm)	Thickness of connected portion (mm)	Outer diameter of connected portion (mm)	Thickness of connected portion (mm)	Outer diameter of connected portion (mm)	Thickness of connected portion (mm)	Outer diameter of connected portion (mm)
50	10	70	—	—	—	—	—	—
75	10	95	—	—	—	—	—	—
100	12	124	10	120	9	118	—	—
125	14	153	11	147	9.5	144	—	—
150	16	182	12	174	10	170	—	—
200	21	242	15	230	13	226	11	222
250	23	296	19	288	15.5	281	12	274
300	26	352	22	344	18	336	14	328
350	30	410	25	400	20.5	391	16	382
400	35	470	29	458	23	446	18	436
450	39	528	32	514	26	502	20	490
500	43	586	35	570	28.5	557	22	544
600	52	704	42	684	34	668	26	652
700	—	—	49	798	39	778	30	760
800	—	—	56	912	44	888	34	868
900	—	—	—	—	49	998	38	976
1000	—	—	—	—	54	1108	42	1084
1100	—	—	—	—	59	1218	46	1192
1200	—	—	—	—	65	1330	50	1300
1300	—	—	—	—	73	1496	57	1464
1500	—	—	—	—	81	1662	63	1626

Polyethylene pipe for general use (JIS K6761-1979)

Nominal diameter (mm)	Outer diameter (mm)	1st type	2nd type
		Thickness (mm)	Thickness (mm)
13	21.5	2.7	2.4
20	27.0	3.0	2.4
25	34.0	3.0	2.6
30	42.0	3.5	2.8
40	48.0	3.5	3.0
50	60.0	4.0	3.5
65	76.0	5.0	4.0
75	89.0	5.5	5.0
100	114	6.0	5.5
125	140	6.5	6.5
150	165	7.0	7.0
200	216	8.0	8.0
250	267	9.0	9.0
300	318	10.0	10.0

Hi vinyl chloride pipe (city water pipe size)

Nominal diameter	Outer diameter	Thickness of pipe
13	18.0	2.5
20	26.0	3.0
25	32.0	3.5
30	38.0	3.5
40	48.0	4.0
50	60.0	4.5
75	89.0	5.8
100	114.0	7.0
125	140.0	7.5
150	165.0	8.5

Hi vinyl chloride pipe (conduit size)

Nominal pipe	Outer diameter	Thickness of pipe
28	34.0	3.0
35	42.0	3.5
41	48.0	3.5
52	60.0	4.0
65	76.0	4.5
78	89.0	5.5

Vertical type cast iron pipe (JISG5521)

Nominal pipe D	Thickness		Actual outer diameter D1
	T		
	Normal pressure pipe	Low pressure pipe	
75	9.0	—	93.0
100	9.0	—	118.0
150	9.5	9.0	169.0
200	10.0	9.4	220.0
250	10.8	9.8	271.6
300	11.4	10.2	322.8
350	12.0	10.6	374.0
400	12.8	11.0	425.6
450	13.4	11.5	476.8
500	14.0	12.0	528.0
600	15.4	13.0	630.8
700	16.5	13.8	733.0
800	18.0	14.8	836.0
900	19.5	15.5	939.0
1000	22.0	—	1041.0
1100	23.5	—	1144.0
1200	25.0	—	1246.0
1350	27.5	—	1400.0
1500	30.0	—	1554.0

Carbon steel pipe for pipe arrangement
(JIS G3452-1988)

Nominal pipe		Outer diameter (mm)	Thickness (mm)
(A)	(B)		
15	1/2	21.7	2.8
20	3/4	27.2	2.8
25	1	34.0	3.2
32	1 1/4	42.7	3.5
40	1 1/2	48.6	3.5
50	2	60.5	3.8
65	2 1/2	76.3	4.2
80	3	89.1	4.2
90	3 1/2	101.6	4.2
100	4	114.3	4.5
125	5	139.8	4.5
150	6	165.2	5.0
175	7	190.7	5.3
200	8	216.3	5.8
225	9	241.8	6.2
250	10	267.4	6.6
300	12	318.5	6.9
350	14	355.6	7.9
400	16	406.4	7.9
450	18	457.2	7.9
500	20	508.0	7.9

Hard vinyl chloride pipe (JIS K6741-1984)

Section Nominal pipe (mm)	VP		VU	
	Outer diameter	Thickness	Outer diameter	Thickness
13	18	2.2	—	—
16	22	2.7	—	—
20	26	2.7	—	—
25	32	3.1	—	—
30	38	3.1	—	—
40	48	3.6	48	1.8
50	60	4.1	60	1.8
65	76	4.1	76	2.2
75	89	5.5	89	2.7
100	114	6.6	114	3.1
125	140	7.0	140	4.1
150	165	8.9	165	5.1
200	216	10.3	216	6.5
250	267	12.7	267	7.8
300	318	15.1	318	9.2
350	—	—	370	10.5
400	—	—	420	11.8
450	—	—	470	13.2
500	—	—	520	14.6
600	—	—	630	17.8
700	—	—	732	21.0
800	—	—	835	23.9

Steel pipe coated for city water
STPW (JIS G3443-1968)

Nominal diameter (A)	Outer diameter (mm)	Thickness (mm)
80	89.1	4.2
100	114.3	4.5
125	139.8	4.5
150	165.2	5.0
200	216.3	5.8
250	267.4	6.6
300	318.5	6.9
350	355.6	6.0
400	406.4	6.0
450	457.2	6.0
500	508.0	6.0
600	609.6	6.0
700	711.2	6.0
800	812.8	7.1
900	914.4	7.9
1000	1016.0	8.7
1100	1117.6	10.3
1200	1219.2	11.1
1350	1371.6	11.9
1500	1524.0	12.7

Steel pipe coated for city water STW (JIS G3443 1987)

Nominal diameter A	Outer diameter mm	Kinds of symbol				Kinds of symbol			
		STW 30	STW 38	STW 41		STW 290	STW 370	STW 400	
				Nominal thickness				Nominal thickness	
				A	B			A	B
Thickness (mm)	Thickness (mm)	Thickness (mm)	Thickness (mm)	Thickness (mm)	Thickness (mm)	Thickness (mm)	Thickness (mm)		
80	89.1	4.2	4.5	—	—	4.2	4.5	—	—
100	114.3	4.5	4.9	—	—	4.5	4.9	—	—
125	139.8	4.5	5.1	—	—	4.5	5.1	—	—
150	165.2	5.0	5.5	—	—	5.0	5.5	—	—
200	216.3	5.8	6.4	—	—	5.8	6.4	—	—
250	267.4	6.6	6.4	—	—	6.6	6.4	—	—
300	318.5	6.9	6.4	—	—	6.9	6.4	—	—
350	355.6	—	—	6.0	—	—	—	6.0	—
400	406.4	—	—	6.0	—	—	—	6.0	—
450	457.2	—	—	6.0	—	—	—	6.0	—
500	508.0	—	—	6.0	—	—	—	6.0	—
600	609.6	—	—	6.0	—	—	—	6.0	—
700	711.2	—	—	7.0	6.0	—	—	7.0	6.0
800	812.8	—	—	8.0	7.0	—	—	8.0	7.0
900	914.4	—	—	8.0	7.0	—	—	8.0	7.0
1000	1016.0	—	—	9.0	8.0	—	—	9.0	8.0
1100	1117.6	—	—	10.0	8.0	—	—	10.0	8.0
1200	1219.2	—	—	11.0	9.0	—	—	11.0	9.0
1350	1371.6	—	—	12.0	10.0	—	—	12.0	10.0
1500	1524.0	—	—	14.0	11.0	—	—	14.0	11.0
1600	1625.6	—	—	15.0	12.0	—	—	15.0	12.0
1650	1676.4	—	—	15.0	12.0	—	—	15.0	12.0
1800	1828.8	—	—	16.0	13.0	—	—	16.0	13.0
1900	1930.4	—	—	17.0	14.0	—	—	17.0	14.0
2000	2032.0	—	—	18.0	15.0	—	—	18.0	15.0
2100	2133.6	—	—	19.0	16.0	—	—	19.0	16.0
2200	2235.2	—	—	20.0	16.0	—	—	20.0	16.0
2300	2336.8	—	—	21.0	17.0	—	—	21.0	17.0
2400	2438.4	—	—	22.0	18.0	—	—	22.0	18.0
2500	2540.0	—	—	23.0	18.0	—	—	23.0	18.0
2600	2641.6	—	—	24.0	19.0	—	—	24.0	19.0
2700	2743.2	—	—	25.0	20.0	—	—	25.0	20.0
2800	2844.8	—	—	26.0	21.0	—	—	26.0	21.0
2900	2946.4	—	—	27.0	21.0	—	—	27.0	21.0
3000	3048.0	—	—	29.0	22.0	—	—	29.0	22.0

Centrifugal nodular graphite cast iron pipe for city water (A type) (JWWA G-105 1971)

Nominal diameter D	Thickness of pipe T			Actual outer diameter D1
	T			
	1st type pipe	2nd type pipe	3rd type pipe	
75	7.5	—	6.0	93.0
100	7.5	—	6.0	118.0
150	9.5	—	6.0	169.0
200	7.5	—	6.0	220.0
250	7.5	—	6.0	271.6
300	7.5	—	6.5	332.8
350	7.5	—	6.5	374.0
400	8.5	7.5	7.0	425.6
450	9.0	8.0	7.5	476.8
500	9.5	8.5	7.0	528.0

Centrifugal nodular graphite cast iron pipe for city water (K type) (JWWA G-105 1971)

Nominal diameter D	Thickness of pipe			Actual outer diameter D ₁
	1st type pipe	2nd type pipe	3rd type pipe	
400	8.5	7.5	7.0	425.6
450	9.0	8.0	7.5	476.8
500	9.5	8.5	8.0	528.0
600	11.0	10.0	9.0	630.8
700	12.0	11.0	10.0	733.0
800	13.5	12.0	11.0	836.0
900	15.0	13.0	12.0	939.0
1000	16.5	14.5	13.0	1041.0
1100	18.0	15.5	14.0	1144.0
1200	19.5	17.0	15.0	1246.0
1350	21.5	18.5	16.5	1400.0
1500	23.5	20.5	18.0	1554.0

Ductile iron specials

Nominal diameter (mm)	Thickness of pipe (mm)
75	8.5
100	8.5
150	9.0
200	11.0
250	12.0
300	12.5
350	13.0
400	14.0
450	14.5
500	15.0
600	16.0
700	17.0
800	18.0
900	19.0
1000	20.0
1100	21.0
1200	22.0
1350	24.0
1500	26.0
1600	27.5
1650	28.0
1800	30.0
2000	32.0
2100	33.0
2200	34.0
2400	36.0

Dimensions of centrifugal sand mold cast iron pipe (JIS G5522)

Nominal diameter D	Thickness of pipe T			Actual outer diameter D ₁
	High pressure pipe	Normal pressure pipe	Low pressure pipe	
75	9.0	7.5	—	93.0
100	9.0	7.5	—	118.0
125	9.0	7.8	—	143.0
150	9.5	8.0	7.5	169.0
200	10.0	8.8	8.0	220.0
250	10.8	9.5	8.4	271.6
300	11.4	10.0	9.0	322.8
350	12.0	10.8	9.4	374.0
400	12.8	11.5	10.0	425.6
450	13.4	12.0	10.4	476.8
500	14.0	12.8	11.0	528.0
600	—	14.2	11.8	630.8
700	—	15.5	12.8	733.0
800	—	16.8	13.8	836.0
900	—	18.2	14.8	939.0

Arc welded big diameter stainless steel pipe for pipe arrangement (JIS G3468-1988)

Nominal diameter		Outer diameter (mm)	Nominal thickness			
			Schedule 5S	Schedule 10S	Schedule 20S	Schedule 40S
A	B		Thickness (mm)	Thickness (mm)	Thickness (mm)	Thickness (mm)
150	6	165.2	2.8	3.4	5.0	7.1
200	8	216.3	3.4	4.0	6.5	9.3
250	10	267.4	4.0	4.5	6.5	10.3
350	14	355.6	4.0	5.0	8.0	11.1
400	16	406.4	4.5	5.0	8.0	12.7
450	18	457.2	4.5	5.0	8.0	14.3
500	20	508.0	5.0	5.5	9.5	15.1
550	22	558.8	5.0	5.5	9.5	15.1
600	24	609.6	5.5	6.5	9.5	17.5
650	26	660.4	5.5	8.0	12.7	17.5
700	28	711.2	5.5	8.0	12.7	17.5
750	30	762.0	6.5	8.0	12.7	17.5
800	32	812.8	—	8.0	12.7	17.5
850	34	863.6	—	8.0	12.7	17.5
900	36	914.1	—	8.0	12.7	19.1
1000	40	1016.0	—	9.5	14.3	26.2

Arc welded carbon steel pipe (JIS G3457-1976)

Unit: kg/m

Nominal diameter		Thickness (mm) Outer diameter (mm)	6.0	6.4	7.1	7.9	8.7	9.5	10.3	11.1	11.9	12.7	13.1	15.1	15.9	
(A)	(B)															
350	14	355.6	51.7	55.1	61.0	67.7										
400	16	406.4	59.2	63.1	66.9	77.6										
450	18	457.2	66.8	71.1	78.8	87.5										
500	20	508.0	74.3	79.2	87.7	97.4	107	117								
550	22	558.8	81.8	87.2	96.6	107	118	129	139	150	160	171				
600	24	609.6	89.0	95.2	105	117	127	141	152	164	175	187				
650	26	660.4	96.8	103	114	127	140	152	165	178	190	203				
700	28	711.2	104	111	123	137	151	164	178	192	205	219				
750	30	762.0		119	132	147	162	176	191	206	220	235				
800	32	812.8		127	141	157	173	188	204	219	235	251	258	297	312	
850	34	863.6		135		167	183	200	219	233	250	266	275	315	332	
900	36	914.4		143		177	194	212	230	247	265	282	291	335	352	
1000	40	1016.0				196	216	236	255	275	295	314	324	373	392	
1100	44	1117.6						260	281	303	324	346	357	411	432	
1200	48	1219.2						283	307	331	354	378	390	448	472	
1350	54	1371.6									399	426	439	505	532	
1500	60	1524.0									444	473	488	562	591	
1600	64	1625.6											521	600	631	
1800	72	1828.8											587	675	711	
2000	80	2032.0												751	799	

Dimensions of centrifugal mold cast iron pipe (JIS G5523 1977)

Nominal diameter (mm)	Thickness of pipe T		Actual outer diameter D ₁
	High pressure pipe	Normal pressure pipe	
75	9.0	7.5	93.0
100	9.0	7.5	118.0
125	9.0	7.8	143.0
150	9.5	8.0	169.0
200	10.0	8.8	220.0
250	10.8	9.5	271.6
300	11.4	10.0	322.8

Hard vinyl chloride pipe for city water (JIS K6742-1975)

Nominal diameter	Outer diameter	Thickness
13	18	2.5
20	26	3.0
25	32	3.5
30	38	3.5
40	48	4.0
50	60	4.5
75	89	5.9
100	114	7.1
150	165	9.6

Cast iron pipe for waste water (JIS G5525)

Nominal diameter	Thickness of pipe	Actual inner diameter	Actual outer diameter
	T	D ₁	D ₂
50	6.0	50	62
65	6.0	65	77
75	6.0	74	87
100	6.0	100	112
125	6.0	125	137
150	6.0	150	162
200	7.0	200	214

PVDF-HP

Nominal diameter (mm)	SDR33 S16 PN10	SDR21 S10 PN16	SDR17 S8 PN20
	Thickness(mm)	Thickness(mm)	Thickness(mm)
20		1.9	1.9
25		1.9	1.9
32		2.4	2.4
40		2.4	2.4
50		3.0	3.0
63	2.5	3.0	
75	2.5	3.6	
90	2.8	4.3	
110	3.4	5.3	
125	3.9	6.0	
140	4.3	6.7	
160	4.9	7.7	
180	5.5	8.6	
200	6.2	9.6	
225	6.9	10.8	
250	7.7	11.9	
280	8.6	13.4	
315	9.7	15.0	

(a) Velocity of sound subject to change of temperature in water (0 to 100 °C)

T °C	V m/s	T °C	V m/s	T °C	V m/s	T °C	V m/s
0	1402.74						
1	1407.71	26	1499.64	51	1543.93	76	1555.40
2	1412.57	27	1502.20	52	1544.95	77	1555.31
3	1417.32	28	1504.68	53	1545.92	78	1555.18
4	1421.98	29	1507.10	54	1546.83	79	1555.02
5	1426.50	30	1509.44	55	1547.70	80	1554.81
6	1430.92	31	1511.71	56	1548.51	81	1554.57
7	1435.24	32	1513.91	57	1549.28	82	1554.30
8	1439.46	33	1516.05	58	1550.00	83	1553.98
9	1443.58	34	1518.12	59	1550.68	84	1553.63
10	1447.59	35	1520.12	60	1551.30	85	1553.25
11	1451.51	36	1522.06	61	1551.88	86	1552.82
12	1455.34	37	1523.93	62	1552.42	87	1552.37
13	1459.07	38	1525.74	63	1552.91	88	1551.88
14	1462.70	39	1527.49	64	1553.35	89	1551.35
15	1466.25	40	1529.18	65	1553.76	90	1550.79
16	1469.70	41	1530.80	66	1554.11	91	1550.20
17	1473.07	42	1532.37	67	1554.43	92	1549.58
18	1476.35	43	1533.88	68	1554.70	93	1548.92
19	1479.55	44	1535.33	69	1554.93	94	1548.23
20	1482.66	45	1536.72	70	1555.12	95	1547.50
21	1485.69	46	1538.06	71	1555.27	96	1546.75
22	1488.63	47	1539.34	72	1555.37	97	1545.96
23	1491.50	48	1540.57	73	1555.44	98	1545.14
24	1494.29	49	1541.74	74	1555.47	99	1544.29
25	1497.00	50	1542.87	75	1555.45	100	1543.41

Note) T: temperature, V: velocity of sound

(b) Velocity of sound and density of various liquids

Name of liquid	T °C	ρ g/cm ³	V m/s
Acetone	20	0.7905	1190
Aniline	20	1.0216	1659
Alcohol	20	0.7893	1168
Ether	20	0.7135	1006
Ethylene glycol	20	1.1131	1666
n-octane	20	0.7021	1192
o-xylene	20	0.871	1360
Chloroform	20	1.4870	1001
Chlorobenzene	20	1.1042	1289
Glycerin	20	1.2613	1923
Acetic acid	20	1.0495	1159
Methyl acetate	20	0.928	1181
Ethyl acetate	20	0.900	1164
Cyclohexane	20	0.779	1284
Dithionic acid	20	1.033	1389
Heavy water	20	1.1053	1388
Carbon tetrachloride	20	1.5942	938
Mercury	20	13.5955	1451
Nitrobenzene	20	1.207	1473
Carbon disulfide	20	1.2634	1158
Chloroform	20	2.8904	931
n-propyl alcohol	20	0.8045	1225
n-pentane	20	0.6260	1032
n-hexane	20	0.654	1083
Light oil	25	0.81	1324
Transformer oil	32.5	0.859	1425
Spindle oil	32	0.905	1342
Petroleum	34	0.825	1295
Gasoline	34	0.803	1250
Water	13.5	1.	1460
Sea water (salinity: 3.5%)	16	1.	1510

Note) T: temperature, ρ : density, V: velocity of sound

(c) Velocity of sound per piping material

Material	V m/s
Iron	3230
Steel	3206
Ductile cast iron	3000
Cast iron	2460
Stainless steel	3206
Copper	2260
Lead	2170
Aluminum	3080
Brass	2050
Vinylchloride	2640
Acrylics	2644
FRP	2505
Mortar	2500
Tar epoxy	2505
Polyethylene	1900
Teflon	1240

Note) V: velocity of sound

(d) Dynamic viscosity coefficient of various liquids

Name of liquid	T °C	ρ g/cm ³	V m/s	ν ($\times 10^{-6}$ m ² /s)
Acetone	20	0.7905	1190	0.407
Aniline	20	1.0216	1659	1.762
Ether	20	0.7135	1006	0.336
Ethylene glycol	20	1.1131	1666	21.112
Chloroform	20	1.4870	1001	0.383
Glycerin	20	1.2613	1923	11.885
Acetic acid	20	1.0495	1159	1.162
Methyl acetate	20	0.928	1181	0.411
Ethyl acetate	20	0.900	1164	0.499
Heavy water	20	1.1053	1388	1.129
Carbon tetrachloride	20	1.5942	938	0.608
Mercury	20	13.5955	1451	0.114
Nitrobenzene	20	1.207	1473	1.665
Carbon disulfide	20	1.2634	1158	0.290
n-pentane	20	0.6260	1032	0.366
n-hexane	20	0.654	1083	0.489
Spindle oil	32	0.905	1324	15.7
Gasoline	34	0.803	1250	0.4 to 0.5
Water	13.5	1.	1460	1.004(20°C)

Note) T: temperature, ρ : density, V: velocity of sound
 ν : kinematic viscosity