



The Fastest Flow Controller Company in the World!

OPERATING MANUAL

M · MW · MS · MQ · MB



Thank you for purchasing an Alicat flow meter.

If you have any questions about operating it, or if something is not working as expected, please let us know. We are eager to help you in any way possible.

Alicat Scientific, Inc.

info@alicat.com • alicat.com

7641 N Business Park Drive, Tucson, AZ 85743 USA

1-888-290-6060

Serial Number: _____

Next Calibration (Month/Day) : _____

Recalibrate your flow meter every year.

Alicat recommends that you have your flow meter calibrated every year in order to ensure the continued certainty of your readings and extend the Limited Lifetime Warranty. When it's time for your flow meter's annual recalibration, contact us by phone, email or live chat to set it up, or fill out the Service Request Form at alicat.com/service.

NIST

This Alicat device comes with a NIST traceable calibration certificate.

RoHS

This Alicat flow meter conforms to the European Union's Restriction of Use of Hazardous Substances in Electrical and Electronic Equipment (RoHS) Directive 2011/65/EU.

CE

This Alicat flow meter complies with the requirements of the Low Voltage Directive 2014/35/EU and the EMC Directive 2014/30/EU and carries the CE Marking accordingly.



This Alicat flow meter complies with the requirements of the European Union's Waste Electrical & Electronic Equipment (WEEE) Directive 2002/96/EC.

DOC-MANUAL-M Rev 0, 2020.02.20

Welcome to the Alicat way.

You're busy, and the last thing you want to do is waste time wrestling with your flow meter. We're here to make your life a little easier so you can do what you do best. It's our pleasure to introduce you to your new Alicat:

- **High-accuracy performance for all your gases.** Use your flow meter with any of the 98 or more gases that are part of Gas Select™, **page 23**.
- **1000 readings per second** ensures high resolution data, **page 29**.
- **Monitor pressure and temperature** during flow measurement. View internal stream absolute pressure and temperature, **page 17**.
- **Backlit display with adjustable contrast** is easy to read in direct sunlight. In dimly lit areas, press the Alicat logo to turn on the backlight, **page 7**.
- **Change your STP** to match any standard temperature and pressure reference, **page 27**.
- **Log data to your PC.** Talk to the flow meter serially to capture all flow data for logging and analysis, **page 31**.

This manual covers the following Alicat Scientific instruments:

- **M-Series** Mass Flow Meters
- **MQ-Series** High-Pressure Mass Flow Meters
- **MS-Series** Mass Flow Meters for use with Aggressive Gases
- **MW (WHISPER)** Low Pressure Drop Mass Flow Meters
- **MB-Series** Portable Mass Flow Meters
- **MBS-Series** Portable Mass Flow Meters for Aggressive Gases
- **MQB-Series** Portable High-Pressure Mass Flow Meters
- **MWB (WHISPER)** Portable Low Pressure Drop Mass Flow Meters

This includes M-Series devices labeled as approved for CSA Class 1 Div 2 and ATEX Class 1 Zone 2 hazardous environments. See **page 50** for Special Conditions regarding the use of CSA/ATEX labeled devices.

Please contact Alicat at **1-888-290-6060** or **info@alicat.com** if you have any questions regarding the use or operation of this device.

Contents

Quick Start Guide	6
Getting Started	7
Getting to Know Your Mass Flow Meter	7
Connectors and Buttons	7
The Flow Meter Display	8
Status Messages	8
Option: Charging Your Portable Flow Meter	9
Mounting	10
Filters	10
Connecting Your Gas Flow Meter	11
Power and Signal Connections	12
RS-232 / RS-485 Digital Input / Output Signal	13
Analog Signals	14
Option: Color TFT Display	15
Navigation and Customization	16
Flow Meter Menu Map	16
Collecting Live Flow Data	17
Choosing Engineering Units	18
Option: Collecting Totalized Flow Data	19
Menu	20
Taring Your Flow Meter	20
About	21
Diagnostic Information	21
Basic Configuration Menu	22
Choosing Engineering Units from the Basic Configuration Menu	22
Gas Select™	23
Gas List	24
Using COMPOSER™ to Personalize Mixed Gas Compositions	25
Adding a new mixed gas composition to COMPOSER™	26
Defining STP/NTP Reference Values	27
Advanced Setup	28
Display Setup	28
Sensor Setup	29
Configuring Serial Communications	30

Serial Communication	31
Establishing Communication	31
Streaming vs Polling	32
Polling Mode	32
Streaming Mode	32
Taring	33
Collecting Flow Data	33
Quick Command Guide	34
Using Gas Select™ and COMPOSER™	35
Troubleshooting	36
Maintenance	40
Gas List	41
Engineering Units	43
Flow Units	43
Pressure Units	44
Optional Pinouts	45
Locking Industrial Connector Pinouts	45
9-pin D-Sub Common Pinouts	46
M12 Connector Pinouts	47
15-pin D-Sub Common Pinouts	48

Quick Start Guide

Setup

- **Connect your flow meter.** Ensure that flow through your device will be in the same direction as the arrow on the flow body (usually left to right).
- **Tare your flow meter.** Before you connect the flow meter, ensure that no air is flowing through the device and select **TARE FLOW** from the Main Display. **Note:** Whisper flow meters are sensitive enough to measure the lightest of breezes, so ensure that one end is plugged before selecting tare.
- **Choose your engineering units.** Press the button above or below any parameter to enlarge it in the middle of the display. If you select that same item a second time, you can change the engineering unit for that parameter. You can choose units for all of the parameters at once by selecting **MENU → BASIC CONFIG → DEVICE UNITS**.

Operation: Flow Verification

- **Monitor live flow readings.** You can monitor live readings of flow, pressure and temperature by viewing the screen. Readings are updated in real time. See **page 17**.
- **Tare your flow meter** before you begin another round of measurements. Ensure that no flow is passing through your meter, and select **TARE FLOW**. See **page 20**.
- (Optional) **Capture a totalized reading.** The totalizer option displays the total flow that has passed through the device since the last time the totalizer was reset. Press **TOTAL/MENU** to access the totalizer.

Backlight

Your Alicat monochrome display comes equipped with a backlight. **To activate, press the center of the Alicat logo on the front of your device.** To turn the backlight off press the button again. For color displays, pressing this button will turn off the display to conserve power.

Maintenance and Care

- If your gas is clean, your flow meter will require no periodic cleaning. Read more on **page 40**.
- Calibrate your flow meter annually. Request an Alicat factory calibration at alicat.com/service or by calling Alicat at **1-888-290-6060**.

Getting Started

Getting to Know Your Mass Flow Meter

Connectors and Buttons

The drawings below represent typical configurations of a standard Alicat mass flow meter (M series) and a standard battery-powered mass flow meter (MB series). **Your flow meter's appearance and connections may differ.**

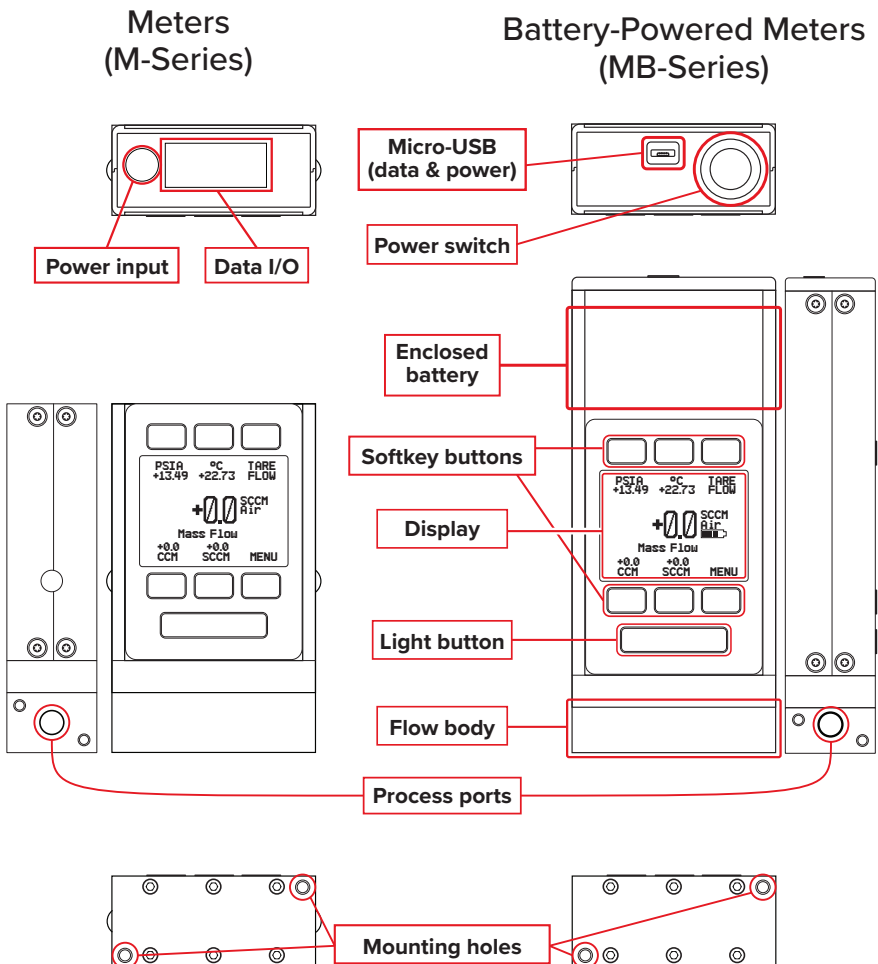

The Flow Meter Display

The figure below identifies the various features of the flow meter display. Press the large button with the Alicat logo to toggle the backlight on and off. For more details, see the Menu Map on **page 16** and the menu-by-menu descriptions that follow it.

Engineering units are used by the meter in its serial communications and calculations. These can be different from **button units**, which are the units being displayed. These are individually configurable. See **page 18**.

- 1 Highlights **pressure** in the center of the meter. Push a second time to choose the pressure parameter (if available), or to select pressure engineering units.
- 2 Highlights **temperature**. Push a second time to select temperature engineering units.
- 3 TARE FLOW **tare the flow rate** (see **page 20**).
- 4 Highlights **volumetric (actual) flow** rate. Push a second time to select volumetric flow rate engineering units.
- 5 Highlights **mass flow** rate. Push a second time to select mass flow (normal mass flow) or true mass flow engineering units.
- 6 **TOTAL/MENU** Accesses the optional **flow totalizer** (optional) (**page 19**). **MENU** enters the Menu system (**page 16**)

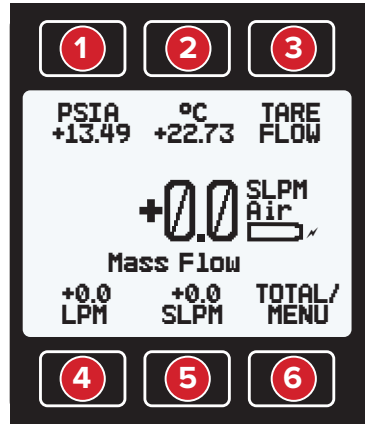

Status Messages

ADC	Analog-digital converter error	MOV	Mass flow over range of device
LCK	Front display is locked	TMF	Totalizer missed out of range flow
OVR	Totalizer rolled over to zero	TOV	Temperature over range of device
POV	Pressure over range of device	VOV	Volumetric flow over range of device

Option: Charging Your Portable Flow Meter

If you purchased a portable meter, we've fully charged it at the factory, so you can use it right away. Typical battery life of a fully-charged battery is 18 hours with a monochrome display or 8 hours with a TFT color display, when the backlight is set to 10. Dimming the backlight will increase battery life.

The battery indicator on the right side of the Main Display reflects the relative battery level. When the battery indicator is completely empty, approximately 15 minutes of battery life remains. Please charge the flow meter as soon as possible to maintain full device performance.

Charge the flow meter using the supplied USB cable (micro-B to type A) or a similar cable. You may charge the flow meter using any USB outlet on a computer or portable power supply, but charging will be fastest (approximately 3.5 hours) when connected to the supplied 2.0A power supply.

The red indicator LED on top of the device lights up red to indicate that the unit is charging. The red LED turns off when the battery is charged.

Your flow meter may be used while it is charging. A small lightning bolt symbol (⚡) will appear to the right of the battery symbol while the device is charging. If the battery has been fully depleted, you may need to charge the flow meter for a full minute before the device can be turned on.

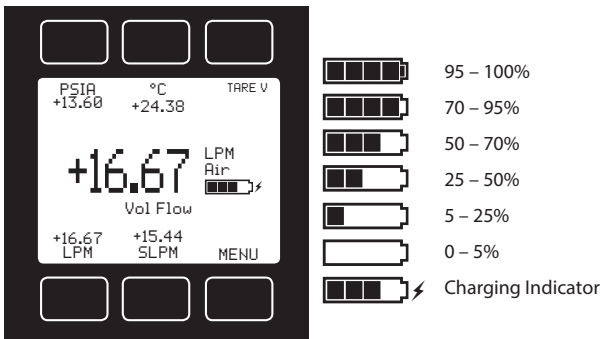

Warning: *The safe charging temperature range is 0-45 °C (32-113 °F). If internal sensors detect temperatures outside of this range, the battery will not charge.*

Mounting

No straight runs of pipe are required upstream or downstream of the meter. For most Alicat flow meters, you can mount or hold the meter in any position, because it is internally compensated for any changes to its orientation during use. (MS/MBS series flow meters use media-isolated sensors that must be tared after changing orientation.) Your flow meter is also minimally affected by vibrations, so you can rest it on top of a vibrating instrument with little impact to measurement accuracy.

Device Ports

Your flow meter has been shipped with plastic plugs fitted into its ports. To lessen the chance of contaminating the flow stream, do not remove these plugs until you are ready to install the device.

Standard Alicat Gas Flow Meters have female inlet and outlet ports. Welded VCR and other specialty fittings may have male connections.

- If you are using a fitting that does not have a face seal, use thread-sealing Teflon tape to prevent leakage around the port threads, but do not wrap the first two threads. This will minimize the possibility of getting tape into the flow stream and clogging the laminar flow elements (LFE).
- If you are using a fitting that has a face seal, there is no need to apply Teflon tape to the threads.



Warning: *Do not use pipe dopes or sealants on the process connections, as these compounds can cause permanent damage to the meter should they get into the flow stream.*

Filters

When pressure drop is not an issue, use in-line sintered filters to prevent large particulates from entering the flow meter. Suggested maximum particulate sizes are as follows:

- **5 microns** for units with flow ranges of 1 SCCM or less.
- **20 microns** for units with flow ranges between 2 SCCM and 1 SLPM.
- **50 microns** for units with flow ranges of 1 SLPM or more.

Connecting Your Gas Flow Meter

Your Alicat flow meter can measure flow generated by positive pressure and/or suction. Connect the meter so that the flow travels in the same direction as the flow arrow, usually from left to right as you look at the front of the device.

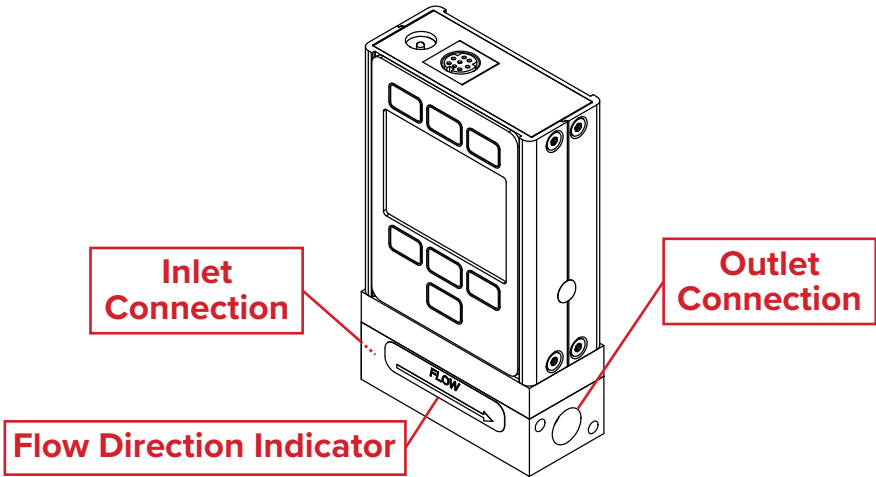

Model	Max Common Mode Pressure	Max Differential Pressure
M, MS, MB, MBS	175 PSIA	75 PSID
MW, MWB	80 PSIA	10 PSID
MQ, MQB	400 PSIA	75 PSID

Power and Signal Connections

Power can be supplied to your meter through either the power jack or the multi-pin connector on top of your device.

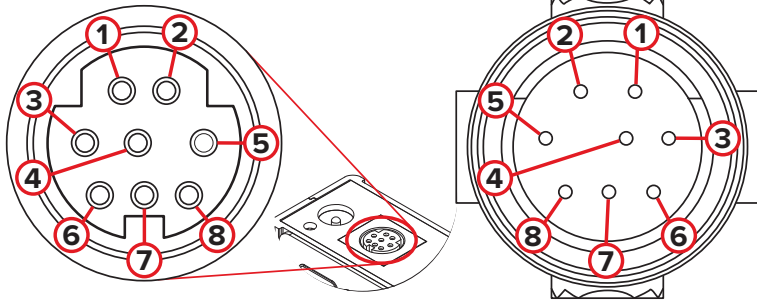

Female Connector: Device

Male Connector: Cable



Meter power jacks require a 9–24 Vdc power supply with a 2.1 mm female positive center plug capable of supplying at least 50 mA. 4–20 mA analog signal outputs require at least 12 Vdc and 100 mA, and 0–10 Vdc outputs require at least 12 Vdc.

Standard 8-Pin Mini-DIN Pinout

Pin	Function	Cable color
1	Not Connected (or optional 4–20 mA Primary Output Signal)	Black
2	Static 5.12 Vdc (or optional Secondary Analog Output [4–20 mA, 0–5 Vdc, 1–5V dc, 0–10 Vdc] or Basic Alarm)	Brown
3	Serial RS-232RX / RS-485(–) Input Signal (receive)	Red
4	Remote Tare (Ground to Tare)	Orange
5	Serial RS-232TX / RS-485(+) Output Signal (send)	Yellow
6	0–5 Vdc (or optional 1–5 Vdc or 0–10 Vdc) Output Signal	Green
7	Power In (as described above)	Blue
8	Ground (common for power, digital communications, analog signals and alarms)	Purple

Note: The above pinout is applicable to all flow meters with the Mini-DIN connector. The availability of different output signals depends on the options ordered. Optional configurations are noted on the unit's calibration sheet.



Caution: Do not connect power to pins 1 through 6, as permanent damage can occur. It is common to mistake Pin 2 (labeled 5.12 Vdc Output) as the standard 0–5 Vdc analog output signal. Pin 2 is normally a constant 5.12 Vdc that reflects the system bus voltage.

For 6-pin locking industrial connector, M12, DB9 and DB15 pinouts, see **page 45 to page 48** or visit alicat.com/pinout.

RS-232 / RS-485 Digital Input / Output Signal

To use the RS-232 or RS-485 digital signal, connect the RS-232 / RS-485 Output Signal (Pin 5), the RS-232 / RS-485 Input Signal (Pin 3) and Ground (Pin 8) to your serial port as shown below. (See "Serial Communications" on **page 31** for details)

DB9 to 8-Pin Mini-DIN Connection for RS-232 / RS-485 Signals

9 Pin Serial Connection		8 Pin Mini-DIN Connection	
Pin	Function	Pin	Function
5	Ground	8	Ground
3	Transmit	3	Receive
2	Receive	5	Transmit

DB9 connections

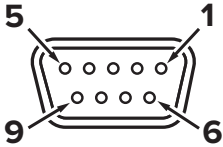

Male Connector: Cable

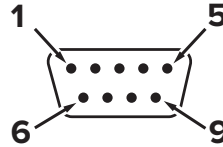

Female Connector: Device

Analog Signals

Primary Analog Output Signal

Most Alicat instruments include a primary analog output signal, which is linear over its entire range. For both standard 0–5 Vdc and optional 0–10 Vdc output signals, a zero flow condition is usually in the range of 0.010 Vdc. Zero flow for the optional 1–5 Vdc and 4–20 mA output signals is 1 Vdc and 4 mA, respectively. Full-scale flow is 5 Vdc for 0–5 Vdc and 1–5 Vdc signals, 10 Vdc for 0–10 Vdc signals and 20 mA for 4–20 mA signals.

Alicat’s default 8-pin mini-DIN connector places the primary analog output on Pin 6 for voltage signals and Pin 1 for 4–20 mA current signals. Ground for these signals is common on Pin 8.

Using Ground to Tare

You can tare your mass flow meter remotely by momentarily grounding Pin 4, as shown below. When the switch is closed, the device will tare, and resume operation once the switch has been released.

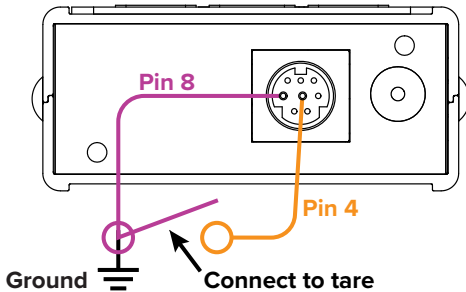

Option: Second Analog Output Signal

Alicat’s default 8-pin mini-DIN connector places the secondary analog output on Pin 2 for both voltage and current signals. Your device’s secondary analog signal may differ from its primary output signal.



See the calibration sheet that shipped with your meter to determine which output signals were ordered.

Option: 4–20 mA Current Output Signal

If your meter has a 4–20 mA current primary or secondary output signal, your flow meter will require 12–24 Vdc power.



Caution: Do not connect 4–20 mA devices to “loop powered” systems, as this will destroy portions of the circuitry and void the warranty. If you must interface with existing loop powered systems, always use a signal isolator and a separate power supply.

Option: Color TFT Display

Instruments ordered with a color display function the same as standard backlit monochrome instruments, but color is used to provide additional on-screen information.

Multi-Color Display Indicators

- **GREEN:** Parameter labels and adjustments associated with the button directly above or below the label are presented in green.
- **WHITE:** The color of each parameter is displayed in white while operating under normal conditions.
- **RED:** The color of a parameter is displayed in red when its value exceeds 128% of the device's specifications.
- **YELLOW:** Menu items that are ready to be selected appear in yellow. This color replaces the symbol (>) in selections on monochrome display.



Press the Alicat logo button to turn off the color display backlight. The flow meter remains in operation while the backlight is off.

LCD Contrast

LCD contrast is ranged from 0 to 11 on color displays, with 11 indicating the greatest contrast. See “Display Setup” on **page 28**.

Specifications for Instruments with Color Displays

Color displays will require an additional 40 mA when using a 24 Vdc power supply. All other specifications from your device's specification sheet remain in effect.

Specification	Meter
Supply Voltage	7–24 Vdc
Supply Current	80 mA at 12 Vdc 70 mA at 24 Vdc

Navigation and Customization

Start Here

* Main Display

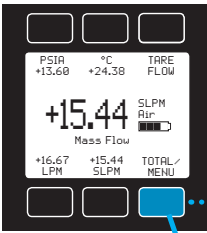

Optional Flow Totalizer

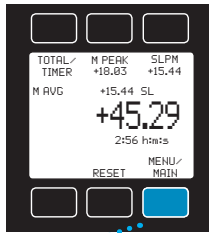

Flow Meter Menu Map

Without Flow Totalizer

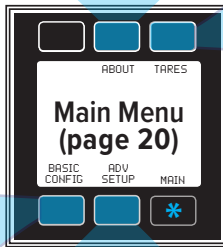
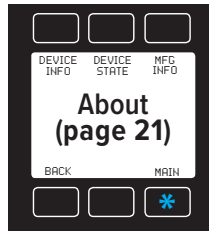

* Press MAIN to return to the Main Display.

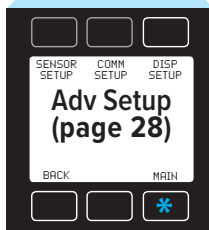
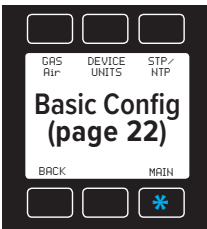

Collecting Live Flow Data

The Main Display has two primary functions:

- Collecting live temperature, pressure and flow data (see below)
- Changing engineering units for temperature, pressure and flow (**page 18**)

This screen displays live data for all flow parameters simultaneously. Live data is measured 1000 times per second and typically displayed 10 times per second on the device LCD screen. Press the button next to any of the four flow parameters once to highlight its value in the center of the screen. Press the same button again to enter the engineering unit selection menu for that parameter (**page 18**).

Main Display

- 1** Highlights **pressure** in the center of the meter. Push a second time to select engineering units or the pressure parameter:
 - Internal absolute pressure
 - Internal gauge pressure (optional)
 - Barometric pressure (optional)
- 2** Highlights **temperature**. Push a second time to select temperature engineering units.
- 3** **TARE FLOW** Tares the **flow rate** (see **page 20**).
- 4** Highlights **volumetric (actual) flow** rate. Push a second time to select volumetric flow rate engineering units.
- 5** Highlights **mass flow** rate. Push a second time to select mass flow engineering units and switch between standardized, normalized, and true mass flow.
- 6** **TOTAL** Accesses **flow totalizer** (optional) (**page 19**). **MENU** enters the Menu system (**page 20**).

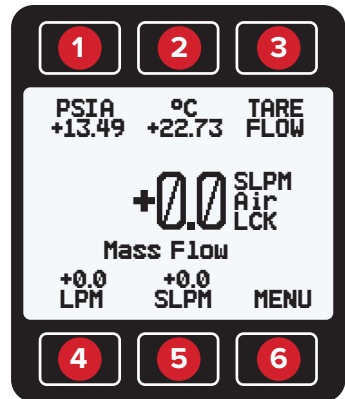

Choosing Engineering Units

Press the button adjacent to any of the four measurement parameters twice to enter its unit selection menu. You can change units in two ways:

Button engineering units (**page 18**) alter the display only, not the serial data:

- Select **Set button eng units** and press **SELECT** to change the engineering unit on the display only. This does not alter the flow meter data frame.

Device engineering units alter both the display and the flow meter data frame:

- Select **Set device eng units** and then choose the engineering unit as above. An additional confirmation screen asks you to confirm the serial change.

If the button engineering unit is different than the device engineering unit, Set device eng units will not appear. First select **Show device eng units** to revert the button to the current device unit for that parameter. Enter the unit selection menu again to change the device engineering unit.

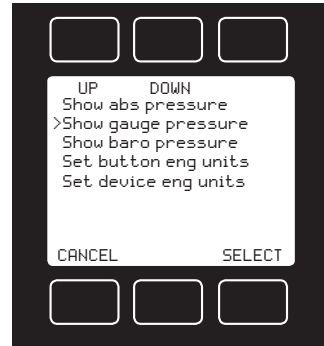

The example above shows the unit selection menu for a device that has the internal barometer option.

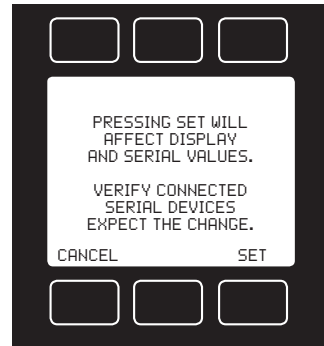

Examples of changing device engineering units:

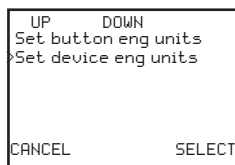
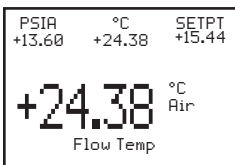
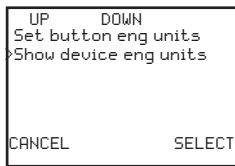
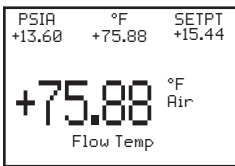

Changing device units:

°F is not the existing device engineering unit, so the unit selection menu displays **Show device eng units**. Select this to revert the button unit to the device unit for this parameter.

Changing device units:

°C is the existing device engineering unit, so the unit selection menu displays **Set device eng units**. Select this to choose a new unit.

Option: Collecting Totalized Flow Data

Your flow meter may have been purchased with an optional flow totalizer. This displays the total amount of mass or volume that has flowed through the instrument since its last reset, like a gasoline pump. You can access the totalizer screen by pressing **TOTAL/MENU** on the Main Display.

Totalizer (Optional)

TOTAL/TIMER Toggles between totalized flow and elapsed time as the parameter highlighted in the center.

M PEAK or **V PEAK** Displays the maximum flow rate since last reset. Press to select engineering units.

Displays live flow rate. Press to select engineering units.

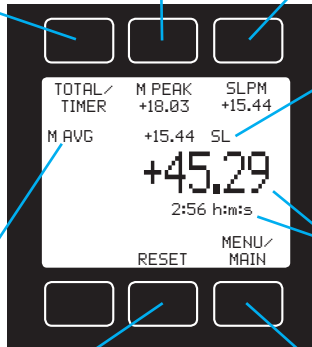
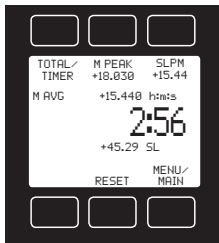

Alternating display of:

- Selected engineering unit for totalized flow or time (**page 19**).
- Selected gas calibration (**page 23**).

Displays totalized flow and elapsed time since last reset. Time units alternate with status messages when any are present (**page 19**).

Optional totalizer averaging: Displays average flow rate since last reset, updated live.

RESET Clears all totalized data and resets the timer to 0. Totalization of flow data continues immediately.

MENU/MAIN Enters the Menu system (**page 16**). From there, press **MAIN** to exit to the Main Display of live data.

Totalizer Rollover Functions

Your flow totalizer has been configured to report a maximum of 7 digits. By default, the placement of the decimal is the same as the live flow rate. The totalizer can be configured at the time of order for the following behaviors. (By default, the totalizer rolls over and displays **OVR**.)

- **Rollover:** Totalizer resumes counting from 0 as soon as the maximum count has been reached.
- **Freeze:** Totalizer stops counting at max count, until it is reset manually.
- **Error:** Displays **OVR** status message when maximum count has been reached; compatible with Rollover and Freeze.

The elapsed time counter has a maximum value of 9999:59:59 (h:m:s) (416 days, 16 hours). If flow is still being totalized at that point, the timer freezes, regardless of the behavior chosen above for the totalized flow readings.

Menu

You can enter the menu system by pressing the **MENU** button from the Main Display.

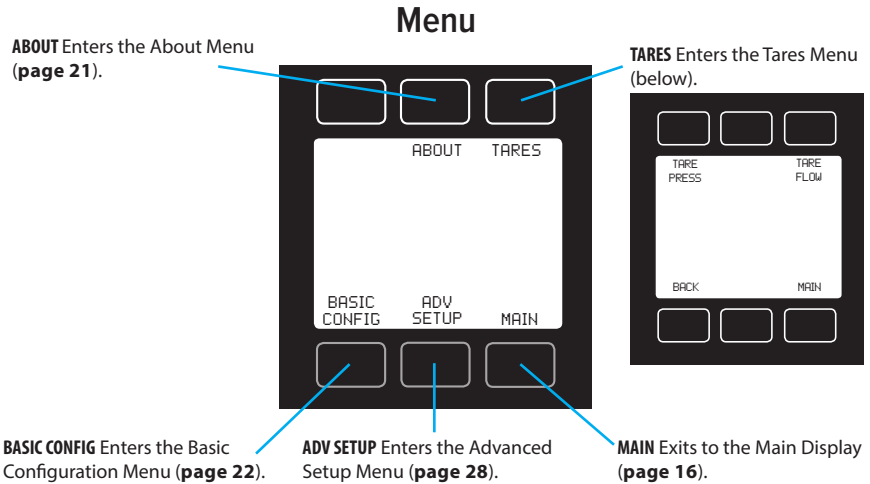

Taring Your Flow Meter

Taring is an important practice that ensures that your flow meter is providing the most accurate measurements possible. This function gives the flow meter a good zero reference for flow measurements. For meters with a barometer, taring can also be used to align the internal absolute pressure sensor with the barometric pressure reading.

How to Tare

1. Ensure that nothing is flowing through the device.
2. **MENU** → **TARE** → **TARE FLOW**. Flow tares should occur at the expected process pressure, as long as there is no flow.
3. **MENU** → **TARE** → **TARE PRESS**. Absolute pressure tares must be done with the meter open to atmosphere (requires a barometer, which is included by default in portable devices)

When to Tare

- Before every new flow measurement cycle.
- After significant changes in temperature or pressure.
- After dropping or bumping the flow meter.
- After installing the meter in a different orientation.

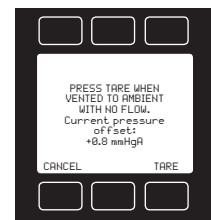
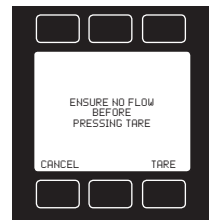

About

We hope you don't run into trouble using your flow meter, but if you do, the **ABOUT** menu contains information that can make the troubleshooting process easier. Select **MFG INFO** to look up Alicat's phone number and web address. **DEVICE INFO** shows you the serial number and firmware version (**SW:**) for your specific device. It also gives you the original manufacturing date and the last calibration date, as well as the initials of the calibration technician.

Menu → About

DEVICE STATE Displays diagnostic information for troubleshooting (below).

DEVICE INFO Displays serial number, firmware revision and calibration information.

MFG INFO Displays Alicat's contact information.

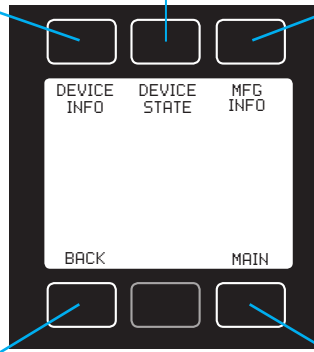
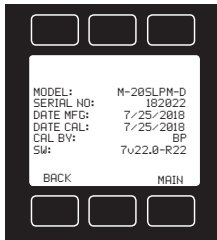

BACK Returns to the top-level Menu (**page 20**).

MAIN Exits to the Main Display (**page 16**).

Diagnostic Information

The **DEVICE STATE** screen displays live values for the internal device registers. Many of these values can help an Alicat applications engineer diagnose operational issues over the phone. Some register values clearly distinguish between hardware and operational problems, which speeds up the troubleshooting process.

Within the **DEVICE STATE** screen, press **PAGE** to advance to the next page of register values.

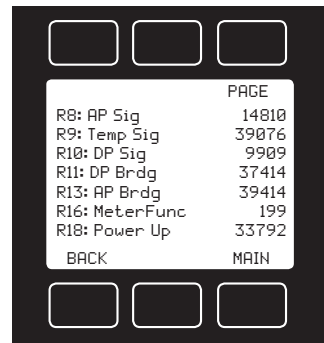

Basic Configuration Menu

The Basic Configuration Menu contains options for choosing the gas calibration, device engineering units and STP/NTP mass flow references.

Menu → Basic Configuration

GAS Enters Gas Select™ and COMPOSER™ menus (**page 23**).

DEVICE UNITS Changes device engineering units for any parameter:

Mass Flow - Volumetric Flow - Pressure - Temperature - (Volu Totalizer - Mass Totalizer - Totalizer Time)

STP/NTP Defines standard (STP) and normal (NTP) temperature and pressure conditions (**page 27**).

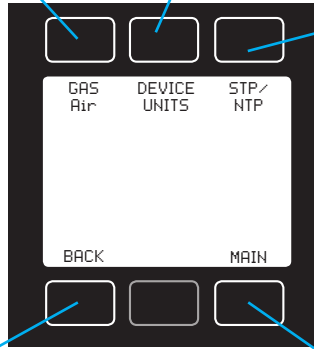

BACK Returns to the top-level Menu (**page 20**).

MAIN Exits to the Main Display (**page 16**).

Choosing Engineering Units from the Basic Configuration Menu

Changing device engineering units alters both the display and the data frame. First choose the parameter whose unit you want to change, and then select your desired engineering unit, confirming the change on the last screen. If your meter has been configured with a flow totalizer, this screen will also include units for totalized volumetric and mass flow, plus elapsed time.

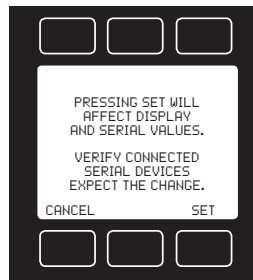
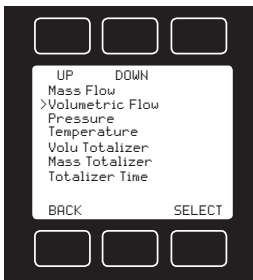

Gas Select™

In most cases, your flow meter was physically calibrated on air at Alicat's factory. Gas Select™ allows you to reconfigure the flow meter to flow a different gas without sending it back to Alicat for a physical recalibration.

To use Gas Select, simply choose a gas or gas mix from one of the listed categories. As soon as you press **SELECT** from the gas listing, your flow meter will reconfigure itself to flow your chosen gas. There is no need to restart the flow meter.

Your current gas selection appears just below the unit's indicator on the right side of the Main Display:

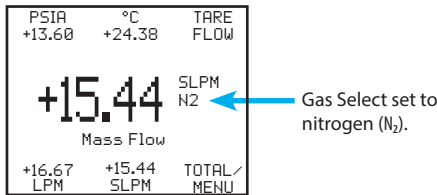

Menu → Basic Config → Gas → **Category Listing**

UP/DOWN Moves the selection arrow up or down the listing of gas categories.

PAGE Advances the view to the next page of categories.

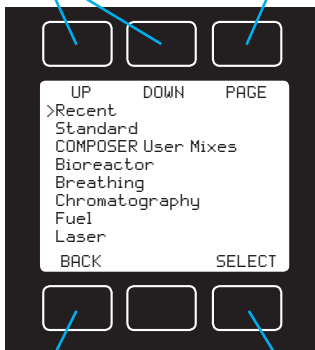

BACK Returns to the Basic Configuration Menu (page 20).

SELECT Opens the category to view its gases.

Gas → **Gas Listing**

UP/DOWN Moves the selection arrow up or down the listing of gases.

PAGE Advances the view to the next page of gases.

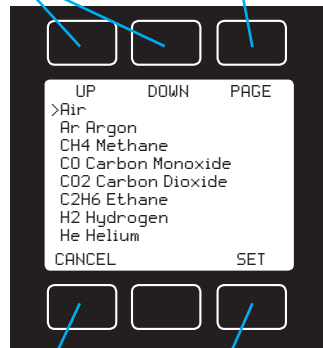

CANCEL Returns to the listing of gas categories.

SET Loads the gas properties data for the selected gas and exits to the Main Display (page 16).

Gas List

Your Alicat is preloaded with gas properties data for the following gases:

Pure Non-Corrosive Gases

Acetylene (C₂H₂)
Air (Clean Dry)
Argon (Ar)
Isobutane (*i*-C₄H₁₀)
Normal Butane (*n*-C₄H₁₀)
Carbon dioxide (CO₂)
Carbon monoxide (CO)
Deuterium (D₂)
Ethane (C₂H₆)
Ethylene (Ethene) (C₂H₄)
Helium (He)
Hydrogen (H₂)
Krypton (Kr)
Methane (CH₄)
Neon (Ne)
Nitrogen (N₂)
Nitrous Oxide (N₂O)
Oxygen (O₂)
Propane (C₃H₈)
Sulfur Hexafluoride (SF₆)¹
Xenon (Xe)

Breathing Gases

Metabolic Exhalant
EAN-32 EA-80 Heliox-50
EAN-36 Heliox-20 Heliox-60
EAN-40 Heliox-21 Heliox-80
EA-40 Heliox-30 Heliox-80
EA-60 Heliox-40 Heliox-99

Bioreactor Gas Mixes

5%–95% CH₄/CO₂ in 5% increments

Refrigerants²

R-11 ³	R-116	R-152a
R-14	R-124 ³	R-318
R-22 ³	R-125 ³	R-404A ³
R-23 ³	R-134a ³	R-407C ³
R-32 ³	R-142b ³	R-410A ³
R-115 ³	R-143a ³	R-507A ³

Welding Gases

C-2	C-25	He-75
C-8	C-50	He-90
C-10	C-75	
C-15	He-25	A 1025
C-20	He-50	Stargon CS

Chromatography Gas Mixes

P-5	P-10
-----	------

Oxygen Concentrator Gas Mixes

89% O₂, 7% N₂, 4% Ar
93% O₂, 3% N₂, 4% Ar
95% O₂, 1% N₂, 4% Ar

Stack/Flue Gas Mixes

2.5% O₂, 10.8% CO₂, 85.7% N₂, 1% Ar
2.9% O₂, 14% CO₂, 82.1% N₂, 1% Ar
3.7% O₂, 15% CO₂, 80.3% N₂, 1% Ar
7% O₂, 12% CO₂, 80% N₂, 1% Ar
10% O₂, 9.5% CO₂, 79.5% N₂, 1% Ar
13% O₂, 7% CO₂, 79% N₂, 1% Ar

Laser Gas Mixes

4.5% CO₂, 13.5% N₂, 82% He
6% CO₂, 14% N₂, 80% He
7% CO₂, 14% N₂, 79% He
9% CO₂, 15% N₂, 76% He
9.4% CO₂, 19.25% N₂, 71.35% He
9% Ne, 91% He

Fuel Gas Mixes

Coal Gas 50% H₂, 35% CH₄, 10% CO, 5% C₂H₄
Endothermic Gas 75% H₂, 25% N₂
HHO 66.67% H₂, 33.33% O₂
LPG HD-5 96.1% C₃H₈, 1.5% C₂H₆, 0.4% C₃H₆, 1.9% n-C₄H₁₀
LPG HD-10 85% C₃H₈, 10% C₃H₆, 5% n-C₄H₁₀

Natural Gases

93% CH₄, 3% C₂H₆, 1% C₃H₈, 2% N₂, 1% CO₂
95% CH₄, 3% C₂H₆, 1% N₂, 1% CO₂
95.2% CH₄, 2.5% C₂H₆, 0.2% C₃H₈, 0.1% C₄H₁₀, 1.3% N₂, 0.7% CO₂

Synthesis Gases

40% H₂, 29% CO, 20% CO₂, 11% CH₄
64% H₂, 28% CO, 1% CO₂, 7% CH₄
70% H₂, 4% CO, 25% CO₂, 1% CH₄
83% H₂, 14% CO, 3% CH₄

Pure Corrosive Gases²

Ammonia (NH ₃)	Dimethylether (DME)
Butylene (1-Buten)	Hydrogen Sulfide (H ₂ S)
Cis-Butene (c-Buten)	Nitrogen Trifluoride (NF ₃)
Isobutane (i-Buten)	Nitric Oxide (NO)
Trans-Butene (t-Buten)	Propylene (C ₃ H ₆)
Carbonyl Sulfide (COS)	Silane (SiH ₄)
Chlorine (Cl ₂)	Sulfur Dioxide (SO ₂)

¹ Sulfur hexafluoride is a highly potent greenhouse gas monitored under the Kyoto Protocol.

² S-series units only

³ Under the Montreal Protocol and Kigali Amendment, the production and consumption of these ozone-depleting substances (ODS) is being or has been phased out. It is recommended you ensure compliance with this universally ratified treaty before attempting to use these gases, in addition to R113, R-123, and R-141b.

Using COMPOSER™ to Personalize Mixed Gas Compositions

To remain accurate, your flow meter needs to know the viscosity of the gas you are flowing through it. The more closely you can define your actual gas composition, the more accurate your flow readings will be. Alicat's COMPOSER™ is an included feature of Gas Select™ that lets you define new mixed gas compositions to reconfigure your flow meter on the fly.

COMPOSER™ uses the Wilke method to define a new gas mixture based on the molar (volumetric) ratios of the gases in the mixture. You can define these gas compositions to within 0.01% for each of up to five constituent gases in the mixture. Once you define and save a new COMPOSER™ gas mix, it becomes part of the Gas Select system and is accessible under the gas category **COMPOSER User Mixes**. You can store 20 COMPOSER™ gas mixes on your flow meter.

Note: COMPOSER™ does not physically mix any gases for you. It reconfigures your flow meter to report flow readings more accurately based on the constituents of your defined gas mixture.

Gas Select™ → Category Listing

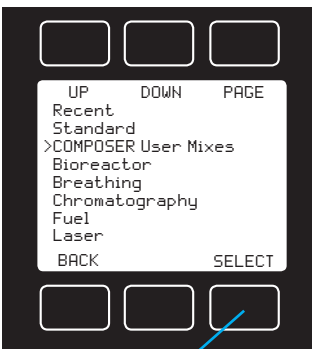

SELECT Enters the COMPOSER™ Menu.

To access COMPOSER™, select **COMPOSER User Mixes** from the **Gas Select** category listing. Select any existing mix to reconfigure your flow meter to flow that gas mixture. Select **Delete Mix** to permanently remove a gas mix.

Gas Select™ → **COMPOSER™ Menu**

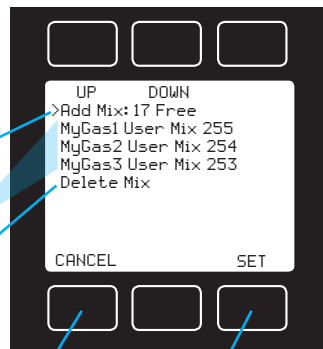

Add Mix Creates a new COMPOSER™ gas mix.

COMPOSER™ Mixes Selects an existing gas mix to use.

Delete Mix Deletes an existing gas mix. (Option appears if at least 1 mix exists.)

CANCEL Returns to the Gas Select™ Menu (**page 23**).

SET Confirms your selection and exits to the Main Display (**page 16**).

Navigating and Customizing Your Flow Meter

Adding a new mixed gas composition to COMPOSER™

Generate and store a new COMPOSER™ mix in 3 easy steps:

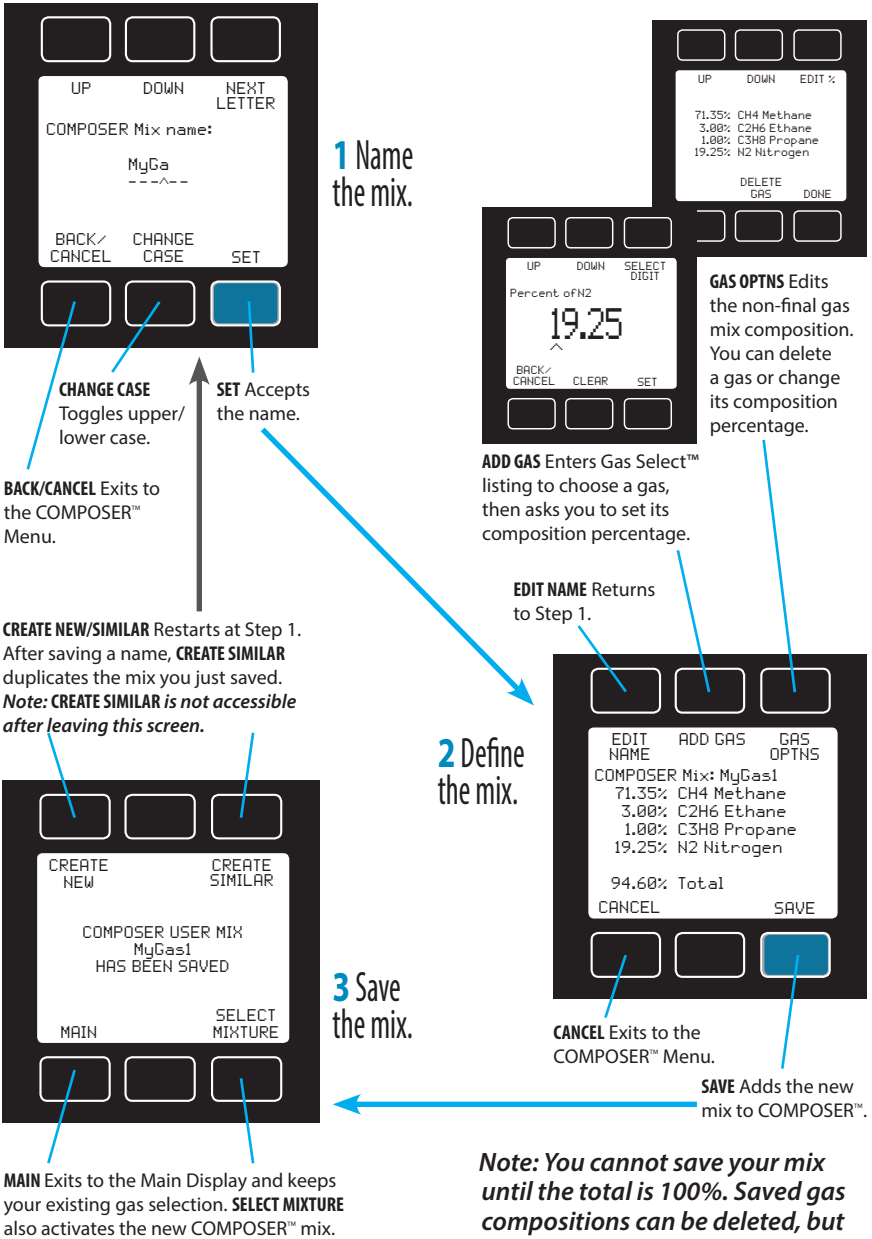

Defining STP/NTP Reference Values

Standardized flow rates are reported in "standard" or "normal" volumetric flow units that reference a given temperature and pressure combination. This reference is called an STP (standard temperature and pressure) or, typically in Europe, an NTP (normal temperature and pressure).

Menu → Basic Config → **STP/NTP**

Stan T: Standard Temperature
Stan P: Standard Pressure
Norm T: Normal Temperature
Norm P: Normal Pressure

Ref temp units Changes the temperature units used for STP and NTP calculations.

Ref pressure units Changes the pressure units used for STP and NTP calculations.

BACK Returns to the Basic Configuration Menu (**page 22**).

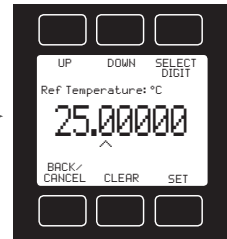
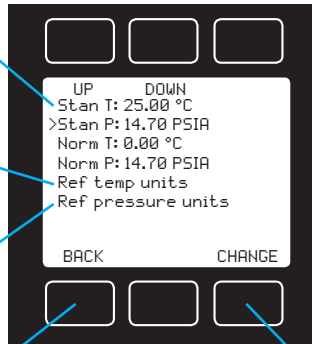

CHANGE Enters the value or unit selection screen for the selected parameter.

Using the **STP/NTP** menu, you can independently change the temperature or pressure references for STP and NTP. Your flow meter ships with Alicat default STP of 25°C and 1 atm (which affects flow units beginning with "S"), and an NTP of 0°C and 1 atm (which affects flow units beginning with "N").

To make changes, follow these steps:

1. Select the desired pressure or temperature reference engineering unit by selecting **Ref temp units** or **Ref pressure units** and pressing **CHANGE**. Both normal and standard references use the same engineering units.
2. Select the temperature or pressure value you wish to modify, and press **CHANGE**.
3. At the confirmation screen, press **SET** to confirm your desired change.



Caution: Changes to **STP/NTP** references will alter your mass flow readings.

Advanced Setup

The Advanced Setup Menu lets you configure the display, zero band, averaging (for flow and pressure) and serial communications.

Menu → Advanced Setup

SENSOR SETUP Enters the Sensor Setup Menu (**page 28**).

COMM SETUP Enters the Communications Menu (**page 31**).

DISP SETUP Enters the Display Setup Menu (**page 28**).

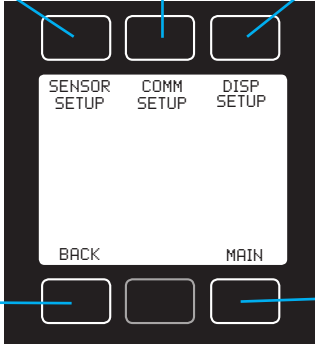

BACK Returns to the top-level Menu (**page 20**).

MAIN Exits to the Main Display (**page 16**).

Display Setup

The options in the Display Setup Menu adjust the contrast of the display and enable screen rotation.

Advanced Setup → Display Setup

LCD CONTRAST Sets the contrast level of the display. Press reset to revert to the default contrast level.

ROTATE DISP Rotates the display and buttons 180° for inverted installations.

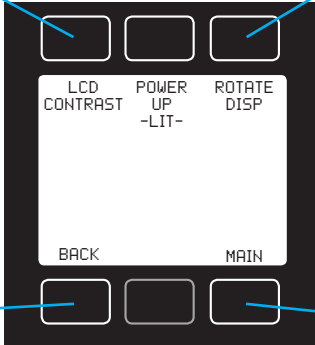

BACK Returns to the Setup Menu (above).

MAIN Exits to the Main Display (**page 16**).

Sensor Setup

The Sensor Setup Menu contains advanced settings that govern how the flow and pressure sensors report their data.

Advanced Setup → Sensor Setup

DISPLAY AS ZERO Defines the zero band threshold under which flow values are displayed as 0. (Max: 6.38%)

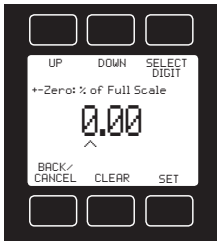

SIG DIGITS Sets the number of significant digits to display flow readings on-screen and in the serial data frame.

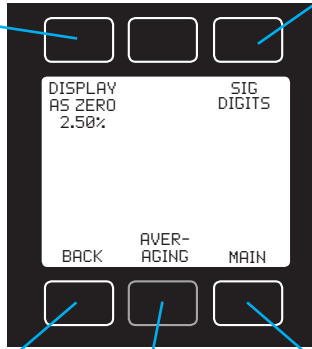

BACK Returns to the Advanced Setup Menu ([page 28](#)).

AVERAGING Adjusts the time constants of the geometric running averages for flow and pressure (1-255 ms).

MAIN Exits to the Main Display ([page 16](#)).

The zero band threshold (**DISPLAY AS ZERO**) is the value below which the flow meter displays all flow readings as "0" (no flow). This function also applies to gauge pressure readings when using the optional barometer.

For example, a 20-SLPM meter with a zero band value of 0.25% would display as 0 SLPM for all readings below 0.05 SLPM.



Note: Deadband settings do not affect the values reported in the serial data.

The **AVERAGING** button opens a submenu for adjusting the flow and pressure averaging, which are changed independently. Values roughly correspond to the time constant (in milliseconds) of the averaged values. Higher numbers generate a greater smoothing effect on rapidly fluctuating readings (max 255 ms).

The maximum averaging time is 255 ms.

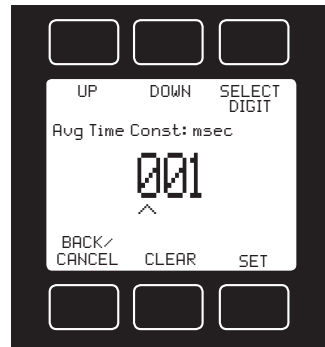

Configuring Serial Communications

You can operate the flow meter remotely via its top connector for easy streaming and logging of all data. Before connecting the flow meter to a computer, ensure that it is ready to communicate with your PC by checking the options in the **COMM SETUP** menu.

Advanced Setup → Comm Setup

UNIT ID Sets the serial unit ID (below):

@ = streaming mode
A-Z = polling mode

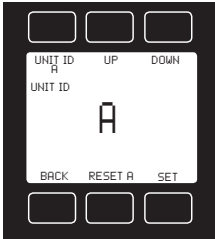

BACK Returns to the Advanced Setup Menu (**page 28**).

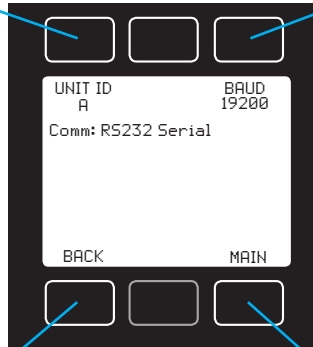

BAUD Sets the serial baud rate (below). Baud rates include: 2400, 9600, 19200, 38400, 57600 and 115200.

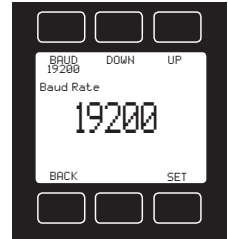

MAIN Exits to the Main Display (**page 16**).

Unit ID

The unit ID is the identifier that a computer uses to distinguish your flow meter from other Alicat devices when it is connected to a network. Using the unit ID letters **A-Z**, you can connect up to 26 devices to a computer at the same time via a single COM port. This is called polling mode (**page 32**). Unit ID changes take effect when you select **SET**.

If you select **@** as the Unit ID, the flow meter enters streaming mode when you exit the menu (see **page 32**).



NOTE: Devices equipped with Modbus RTU will also have a Modbus ID that can be set separately from the unit ID.

Baud Rate

Baud rate is the speed at which digital devices transfer information. The flow meter has a default baud rate of 19200 baud (bits per second). If your computer or software uses a different baud rate, you must change the flow meter baud rate in the **BAUD** menu to match them both. Alternatively, you can change your computer's baud rate in Device Manager. Baud rate changes take effect once you press **SET**, but you may need to restart your software.

Serial Communication

Connecting your flow meter to a computer allows you to log the data that it generates. The flow meter communicates digitally through its communications connector and cable using a real or virtual COM port on your computer. This section of the manual shows you how to operate the flow meter using ASCII commands.

Establishing Communication

After connecting your flow meter using a communications cable, you will need to establish serial communications through a real or virtual COM port on your computer or programmable logic computer (PLC).

- If you have connected your device to a serial port, note its COM port number. This can be found in Windows Device Manager.
- If you have used a USB cable to connect your device to your computer, the computer in most cases will recognize your Alicat as a virtual COM port. If it does not, download the appropriate USB device driver at alicat.com/drivers and note the COM port number as found in Windows Device Manager.
- The meter will be configured with the following settings:
 - **Baud:** 19200 (default; others can be used if the computer, its software and the meter are set for the same rate)
 - **Data bits:** 8
 - **Parity:** none
 - **Stop bits:** 1
 - **Flow control:** none

Serial Terminal Application

Alicat's Serial Terminal is a preconfigured program for serial communications that functions much like the older HyperTerminal program of Windows.

Download Serial Terminal for free at alicat.com/drivers. Once downloaded, simply run SerialTerminal.exe. Enter the COM port number to which your device is connected and the baud rate of the flow meter. The default baud rate is 19200, but this is adjustable by entering the **SERIAL COMM** menu on your flow meter: **MENU** → **ADV SETUP** → **COMM SETUP** → **BAUD** (page 30).

Streaming vs Polling



Note: In what follows,  indicates an ASCII carriage return (decimal 13, hexadecimal D). Serial commands are not case-sensitive.

Polling Mode

Your flow meter was shipped to you in polling mode with a unit ID of A, unless requested otherwise. Polling the flow meter returns a single line of data each time you request it. To poll your flow meter, simply enter its unit ID.

Poll the device: `[unit ID]`

Example: `a` (polls unit A)

You can change the unit ID of a polling device by typing:

Change the unit ID: `[current unit ID]@[desired unit ID]`

Example: `a@=b` (changes unit A to unit B)

You can also do this via the flow meter menu: **MENU** → **ADV SETUP** → **COMM SETUP** → **UNIT ID** (page 30). Valid unit IDs are letters A-Z, and up to 26 devices may be connected at any one time, as long as each unit ID is unique.

Streaming Mode

In streaming mode, your flow meter continuously sends a line of live data at regular intervals without your having to request the data each time. Only one unit on a given COM port may be in streaming mode at a time.

To put your flow meter into streaming mode, type:

Begin streaming: `[unit ID]@=@`

This is equivalent to changing the unit ID to “@”. To take the flow meter out of streaming mode, assign it a unit ID by typing:

Stop streaming: `@=@[desired unit ID]`

Example: `@@=a` (stops and assigns unit ID of A)

When sending a command to a flow meter in streaming mode, the flow of data will not stop while the user is typing. This may make the commands you type unreadable. If the device does not receive a valid command, it will ignore it. If in doubt, simply hit  and start again.



Note: The default streaming interval is 50 ms, but this can be increased by changing Register 91 while the device is in polling mode:

Set streaming interval: `[unit ID] w91=[number of milliseconds]`

Example: `aw91=500` (streams new data every 500 ms)

Taring

Before collecting flow data, be sure to tare your flow meter. This can occur serially through two separate commands. Taring flow sets the zero flow reading and must be done when no flow is passing through the flow meter:

Tare flow: `[unit ID]v`

Example: `av` (sets flow reading to zero)

For devices equipped with a barometer, the second tare aligns the internal absolute pressure sensor with the current barometer reading and must be done with the flow meter open to atmosphere:

Tare absolute pressure: `[unit ID]pc`

Example: `apc`
(aligns internal pressure to barometer)

Collecting Flow Data

Collect live flow data by typing the `[unit ID]` command or by setting your flow meter to streaming. Each line of data for live flow measurements appears in the format below, but Unit ID is not present in streaming mode.

A +13.5424 +24.5782 +16.6670 +15.4443 N2

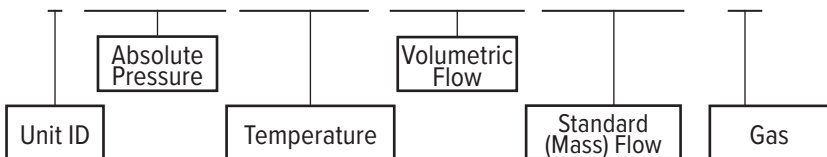

Single spaces separate each parameter, and each value is displayed in the chosen device engineering units, which may differ from the engineering units visible on the flow meter display (see "Choosing Engineering Units" on **page 27**). You can query the engineering units of the instant data frame by typing:

Query live data info: `[unit ID]??d*`

Example: `a??d*`
(returns the data frame descriptions)

Additional columns, including status codes (**page 8**), may be present to the right of the gas label column. The Unit ID appears in the data frame only when the flow meter is in polling mode.

Quick Command Guide



Note: *Serial commands are not case-sensitive. For simplicity, we assume that the unit ID of the flow meter is A in the listing that follows.*

Change unit ID: [current unit ID]@[desired unit ID]↵

Tare flow: av↵

**Tare absolute pressure
with barometer:** apc↵ (optional)

Poll the live data frame: a↵

Begin streaming data: [unit ID]@=@↵

Stop streaming data: @@=[desired unit ID]↵

Set streaming interval: aw91=[number of milliseconds]↵

Query gas list info: a??g*↵

Choose a different gas: ag[Gas Number]↵

**Create a
COMPOSER™ mix:** agm [Mix Name] [Mix Number] [Gas1 %]
[Gas1 Number] [Gas2 %] [Gas2 Number]...↵

**Delete a
COMPOSER™ mix:** agd [Mix Number]↵

Query live data info: a??d*↵

Manufacturer info: a??m*↵

Firmware version: a??m9↵

Lock the front display: a1↵

Unlock front display: au↵

If you have need of more advanced serial communication commands, please contact Alicat.

Using Gas Select™ and COMPOSER™

To reconfigure your flow meter to flow a different gas, look up its Gas Number (**page 41**). Then type:

Choose a gas: [unit ID]g[Gas Number]↵

Example 1: ag8↵ (reconfigures to flow nitrogen)

Example 2: ag206↵ (reconfigures to flow P-10)

COMPOSER™ user mixes are selected in the same way. All COMPOSER™ gas mixes are numbered between 236 and 255, starting at 255.

Choose a user mix: [unit ID]g[Gas Number]↵

Example: ag255↵ (reconfigures for user mix 255)

Defining a new COMPOSER™ gas mix is faster using serial commands than using the front panel. The basic formula for this is:

[unit ID]gm [Mix Name] [Mix Number] [Gas1 %] [Gas1 Number]
[Gas2 %] [Gas2 Number]...↵

- [Mix Name] Use a maximum of 6 letters (upper case and/or lower case), numbers and symbols (space, period or hyphen only).
- [Mix Number] Choose a number from 236–255. If a user mix with that number already exists, it will be overwritten. Use the number 0 to assign the next available number to your new gas. **COMPOSER™ gas numbers are assigned in descending order from 255.**
- [Gas1 %] [Gas1 Number]... For each constituent gas, enter its molar percentage (using up to 2 decimal places) and then its Gas Number (**page 41**). You must have 2–5 gases in your COMPOSER™ mix.

After creating your COMPOSER™ mix, your flow meter will confirm the new gas:

Example1: Create a mix of 71.35% helium, 19.25% nitrogen and 9.4% carbon dioxide as Gas 252, called "MyGas1".

agm MyGas1 252 71.35 7 19.25 8 9.4 4↵

Response: A 252 71.35% He 19.25% N2 9.40% C02

Example2: Create a mix of 93% methane, 3% ethane, 1% propane, 2% N₂ and 1% CO₂, using the next available gas number, called "MyGas2".

agm MyGas2 0 0 93 2 3 5 1 12 2 8 1↵

Response: A 253 AIR 93.00% CH4 3.00% C2H6 1.00% C3H8 2.00% N2 1.00%



Note: The sum of all gas constituent percentages must equal 100.00%.

Troubleshooting

If you run into any trouble with your meter's installation or operation, please get in touch with us by phone, chat or email. You'll also find help on our website alicat.com and in the pages that follow.

General Use

Issue: My meter does not turn on or has trouble staying on.

Action: Check power and ground connections. Please reference the technical specifications to assure you have the proper power for your model.

Portable flow meters run on a rechargeable battery, but you can also connect to a wall outlet or computer using a micro-USB cable. If the battery has been fully depleted, it may take a minute or so to acquire enough charge to turn back on. If your flow meter will not power on after being plugged in for at least 5 minutes, contact Alicat.

Issue: The buttons do not work, and the screen shows LCK.

Action: The flow meter buttons were locked out via a serial command. Press and hold all four outer buttons to unlock the interface.

Issue: I can't read the display easily.

Action: During the day, you can increase the visibility of the display by increasing the contrast (**MENU → ADV SETUP → DISP SETUP → LCD CONTRAST**). If you are working under low-light conditions, push the large Alicat button (located below the display) to turn on the backlight.

Issue: The analog output signal indicates values lower than what appears on my instrument's display.

Action: Analog signal voltage degrades over long distances. You can minimize this effect by using wires with a heavier gauge, especially in the ground wire.

Issue: How often do I need to calibrate my meter?

Action: Alicat recommends annual recalibrations. Check your flow meter's last calibration date by selecting **MENU → ABOUT → DEVICE INFO**. If it is time to recalibrate, request a recalibration at alicat.com/service.

Issue: I dropped my meter. Is it OK? Do I need to recalibrate?

Action: If it turns on and appears to respond normally, then it is probably OK. It may or may not need a recalibration. Compare it against a known-good flow standard. If it checks out, keep using it, but tell us about the drop at your next annual recalibration so we can check it out for you.

Issue: How can I see temperature, pressure or flow in different units?

Action: From the main menu, select **BASIC CONFIG → DEVICE UNITS**. From this menu, you can adjust temperature, pressure or flow units. For more information, see **page 18**.

Flow Readings

Issue: The live flow readings won't settle down.

Action: The flow meter is very fast, so it can detect subtle variations in flow that may go unnoticed by your other flow devices. This sensitivity can help detect problems with pumps or flow controllers. You can lessen this sensitivity by increasing the flow averaging press **MENU → ADV SETUP → SENSOR SETUP → FLOW AVG**. See **page 29**.

Issue: My flow readings are negative.

Action: If your flow meter is not connected to anything, it may be reading a small flow that is entering its outlet. Plug one end to see if the flow returns to 0. Under conditions of no flow, a negative flow reading can indicate a poor tare. Ensure that the flow meter has no flow passing through it, and select **TARE FLOW** from the Main Display to give it a fresh tare.

Issue: My flow readings jump to 0 when flow rates are low.

Action: Your flow instrument is equipped with a programmable zero band that is preset at the factory. Reduce your deadband threshold by selecting **MENU → ADV SETUP → SENSOR SETUP → ZERO BAND**. Note: The zero band threshold has no effect upon the serial data.

Issue: Does the meter work if it is laying down? Will it be accurate?

Action: Yes to both! The flow meter is internally compensated for any changes in orientation, so you can use it sideways, on its back, or upside-down. S and QS-series devices should be tared again after changing their orientation.

Issue: Can I put the meter on top of a vibrating device? Will it be accurate?

Action: Yes, and yes! The flow meter is internally compensated for any changes in orientation, including rapid vibrations. Noise will increase if the flow meter is vibrating.

Issue: My meter does not agree with another meter I have in line.

Action: Check the STP or NTP settings (**MENU → BASIC CONFIG → STP/ NTP**) to ensure that your standardized temperature and pressure references match those of your other flow calibrator. Also check that your device's Gas Select™ is set to the right gas or mixture.

Issue: My flow readings won't change when flow changes.

Action: If your flow readings won't change regardless of actual flow, your flow sensor may be damaged. Please contact Alicat to troubleshoot.

Issue: My volumetric flow readings don't match another flow calibrator I use.

Action: If you are flowing dry gas, the differences in flow readings are likely the result of pressure drop. Every flow meter has some amount of pressure drop, especially those that use differential pressure as the measurement method. For example, volumetric flow readings taken with a standard Alicat flow meter may differ from those taken with one of our low pressure drop Whisper flow meters.

Issue: Can I use the meter with other gases?

Action: Yes! Your flow meter is designed specifically to work with many different gases. Gas Select (**MENU → BASIC CONFIG → GAS**) includes up to 130 preloaded gases and gas mixes, or you can define your own using COMPOSER™. If your desired gas is not listed, please contact Alicat to ensure compatibility.

Serial Communications

Issue: I can't communicate to the meter when it is connected to my computer.

- Action:**
1. Make sure the baud rate and other serial settings of your software and COM Port require is the one your meter is using (MENU → ADV SETUP → COMM SETUP → BAUD).
 2. Check the flow meter unit ID (MENU → ADV SETUP → COMM SETUP → UNIT ID) to make sure you are addressing it properly with your serial commands.
 3. Check the pinout (see **page 45** or alicat.com/pinouts)
 4. Make sure the COM number matches the one your software is using to connect to the flow meter (**page 30**).
-

Still experiencing issues?

Issue: None of the above helped.

Action: We're here to help! Give us a call (1-888-290-6060) during our normal business hours (8am-5pm Mountain Standard Time) to get help from a friendly and capable applications engineer. Or, go to alicat.com and start a live chat. Is it after hours? Send an email to info@alicat.com, and we'll get in touch with you as soon as we can.

Additionally, our troubleshooting resources online might be more up to date than the manual. Please visit alicat.com/support.

Maintenance

Cleaning

Your flow meter requires no periodic cleaning, provided that it has been flowing clean, dry gas. If necessary, the outside of the device can be cleaned with a soft dry cloth.



If you suspect that debris or other foreign material has entered your device, do not take apart the flow body to clean it, as this will negate its NIST-traceable calibration. Please contact us for cleaning.

Recalibration

The recommended period for recalibration is once every year. A label located on the back of the device lists the most recent calibration date. This date is also stored inside your flow meter and is visible by selecting **MENU → ABOUT → DEVICE INFO**.

When it is time for your flow meter's annual recalibration, contact us by phone or live chat to set it up. Or, send an email to service@alicat.com, or fill out the form at alicat.com/service. We'll ask for your device's serial number and your contact information and send you an email with instructions for returning the flow meter to us.

Replacement Accessories

Accessories are available by contacting Alicat.

For repair, recalibration or recycling of this product contact:

Alicat Scientific, Inc.

service@alicat.com • alicat.com

7641 N Business Park Drive, Tucson, AZ 85743 USA

1-888-290-6060

Technical Specifications and Dimensional Drawings

Please visit alicat.com/knowledge-base/alicat-specification-sheets/ to find the complete operating specifications and dimensional drawings for your mass flow meter.

Gas List

#	Short Name	Long Name
0	Air	Air (Clean Dry)
1	Ar	Argon
2	CH4	Methane
3	CO	Carbon Monoxide
4	CO2	Carbon Dioxide
5	C2H6	Ethane
6	H2	Hydrogen
7	He	Helium
8	N2	Nitrogen
9	N2O	Nitrous Oxide
10	Ne	Neon
11	O2	Oxygen
12	C3H8	Propane
13	nC4H10	Normal Butane
14	C2H2	Acetylene
15	C2H4	Ethylene (Ethene)
16	iC4H10	Isobutane ²
17	Kr	Krypton
18	Xe	Xenon
19	SF6	Sulfur Hexafluoride ¹
20	C-25	25% CO ₂ , 75% Ar
21	C-10	10% CO ₂ , 90% Ar
22	C-8	8% CO ₂ , 92% Ar
23	C-2	2% CO ₂ , 98% Ar
24	C-75	75% CO ₂ , 25% Ar
25	He-25	25% He, 75% Ar
26	He-75	75% He, 25% Ar
27	A1025	90% He, 7.5% Ar, 2.5% CO ₂
28	Star29	Stargon CS (90% Ar, 8% CO ₂ , 2% O ₂)
29	P-5	5% CH ₄ , 95% Ar
30	NO	Nitric Oxide ²
31	NF3	Nitrogen Trifluoride ²
32	NH3	Ammonia ²
33	Cl2	Chlorine ²
34	H2S	Hydrogen Sulfide ²

#	Short Name	Long Name
35	SO2	Sulfur Dioxide ²
36	C3H6	Propylene ²
80	1Buten	1-Butylene ²
81	cButen	Cis-Butene (cis-2-Butene) ²
82	iButen	Isobutylene
83	tButen	Trans-2-Butene ²
84	COS	Carbonyl Sulfide ²
85	DME	Dimethylether (C ₂ H ₆ O) ²
86	SiH4	Silane ²
100	R-11	Trichlorofluoromethane (CCl ₃ F) ^{2,3}
101	R-115	Chloropentafluoroethane (C ₂ ClF ₅) ^{2,3}
102	R-116	Hexafluoroethane (C ₂ F ₆) ²
103	R-124	Chlorotetrafluoroethane (C ₂ HClF ₄) ^{2,3}
104	R-125	Pentafluoroethane (CF ₃ CHF ₂) ^{2,3}
105	R-134A	Tetrafluoroethane (CH ₂ FCF ₃) ^{2,3}
106	R-14	Tetrafluoromethane (CF ₄) ²
107	R-142b	Chlorodifluoroethane (CH ₃ CClF ₂) ^{2,3}
108	R-143a	Trifluoroethane (C ₂ H ₃ F ₃) ^{2,3}
109	R-152a	Difluoroethane (C ₂ H ₄ F ₂) ²
110	R-22	Difluoromonochloromethane (CHClF ₂) ^{2,3}
111	R-23	Trifluoromethane (CHF ₃) ^{2,3}
112	R-32	Difluoromethane (CH ₂ F ₂) ^{2,3}
113	R-318	Octafluorocyclobutane (C ₄ F ₈) ²
114	R-404A	44% R-125, 4% R-134A, 52% R-143A ^{2,3}
115	R-407C	23% R-32, 25% R-125, 52% R-143A ^{2,3}
116	R-410A	50% R-32, 50% R-125 ^{2,3}
117	R-507A	50% R-125, 50% R-143A ^{2,3}
140	C-15	15% CO ₂ , 85% Ar
141	C-20	20% CO ₂ , 80% Ar
142	C-50	50% CO ₂ , 50% Ar
143	He-50	50% He, 50% Ar
144	He-90	90% He, 10% Ar
145	Bio5M	5% CH ₄ , 95% CO ₂
146	Bio10M	10% CH ₄ , 90% CO ₂
147	Bio15M	15% CH ₄ , 85% CO ₂

#	Short Name	Long Name
148	Bio20M	20% CH ₄ , 80% CO ₂
149	Bio25M	25% CH ₄ , 75% CO ₂
150	Bio30M	30% CH ₄ , 70% CO ₂
151	Bio35M	35% CH ₄ , 65% CO ₂
152	Bio40M	40% CH ₄ , 60% CO ₂
153	Bio45M	45% CH ₄ , 55% CO ₂
154	Bio50M	50% CH ₄ , 50% CO ₂
155	Bio55M	55% CH ₄ , 45% CO ₂
156	Bio60M	60% CH ₄ , 40% CO ₂
157	Bio65M	65% CH ₄ , 35% CO ₂
158	Bio70M	70% CH ₄ , 30% CO ₂
159	Bio75M	75% CH ₄ , 25% CO ₂
160	Bio80M	80% CH ₄ , 20% CO ₂
161	Bio85M	85% CH ₄ , 15% CO ₂
162	Bio90M	90% CH ₄ , 10% CO ₂
163	Bio95M	95% CH ₄ , 5% CO ₂
164	EAN-32	32% O ₂ , 68% N ₂
165	EAN	36% O ₂ , 64% N ₂
166	EAN-40	40% O ₂ , 60% N ₂
167	HeOx20	20% O ₂ , 80% He
168	HeOx21	21% O ₂ , 79% He
169	HeOx30	30% O ₂ , 70% He
170	HeOx40	40% O ₂ , 60% He
171	HeOx50	50% O ₂ , 50% He
172	HeOx60	60% O ₂ , 40% He
173	HeOx80	80% O ₂ , 20% He
174	HeOx99	99% O ₂ , 1% He
175	EA-40	Enriched Air-40% O ₂
176	EA-60	Enriched Air-60% O ₂
177	EA-80	Enriched Air-80% O ₂
178	Metab	Metabolic Exhalant (16% O ₂ , 78.04% N ₂ , 5% CO ₂ , 0.96% Ar)
179	LG-4.5	4.5% CO ₂ , 13.5% N ₂ , 82% He
180	LG-6	6% CO ₂ , 14% N ₂ , 80% He
181	LG-7	7% CO ₂ , 14% N ₂ , 79% He
182	LG-9	9% CO ₂ , 15% N ₂ , 76% He

#	Short Name	Long Name
183	HeNe-9	9% Ne, 91% He
184	LG-9.4	9.4% CO ₂ , 19.25% N ₂ , 71.35% He
185	SynG-1	40% H ₂ , 29% CO, 20% CO ₂ , 11% CH ₄
186	SynG-2	64% H ₂ , 28% CO, 1% CO ₂ , 7% CH ₄
187	SynG-3	70% H ₂ , 4% CO, 25% CO ₂ , 1% CH ₄
188	SynG-4	83% H ₂ , 14% CO, 3% CH ₄
189	NatG-1	93% CH ₄ , 3% C ₂ H ₆ , 1% C ₃ H ₈ , 2% N ₂ , 1% CO ₂
190	NatG-2	95% CH ₄ , 3% C ₂ H ₆ , 1% N ₂ , 1% CO ₂
191	NatG-3	95.2% CH ₄ , 2.5% C ₂ H ₆ , 0.2% C ₃ H ₈ , 0.1% C ₄ H ₁₀ , 1.3% N ₂ , 0.7% CO ₂
192	CoalG	50% H ₂ , 35% CH ₄ , 10% CO, 5% C ₂ H ₄
193	Endo	75% H ₂ , 25% N ₂
194	HHO	66.67% H ₂ , 33.33% O ₂
195	HD-5	LPG: 96.1% C ₃ H ₈ , 1.5% C ₂ H ₆ , 0.4% C ₃ H ₆ , 1.9% n-C ₄ H ₁₀
196	HD-10	LPG: 85% C ₃ H ₈ , 10% C ₃ H ₆ , 5% n-C ₄ H ₁₀
197	OCG-89	89% O ₂ , 7% N ₂ , 4% Ar
198	OCG-93	93% O ₂ , 3% N ₂ , 4% Ar
199	OCG-95	95% O ₂ , 1% N ₂ , 4% Ar
200	FG-1	2.5% O ₂ , 10.8% CO ₂ , 85.7% N ₂ , 1% Ar
201	FG-2	2.9% O ₂ , 14% CO ₂ , 82.1% N ₂ , 1% Ar
202	FG-3	3.7% O ₂ , 15% CO ₂ , 80.3% N ₂ , 1% Ar
203	FG-4	7% O ₂ , 12% CO ₂ , 80% N ₂ , 1% Ar
204	FG-5	10% O ₂ , 9.5% CO ₂ , 79.5% N ₂ , 1% Ar
205	FG-6	13% O ₂ , 7% CO ₂ , 79% N ₂ , 1% Ar
206	P-10	10% CH ₄ 90% Ar
210	D-2	Deuterium

1 Sulfur hexafluoride is a highly potent greenhouse gas monitored under the Kyoto Protocol.

2 S-series units only

3 Under the Montreal Protocol and Kigali Amendment, the production and consumption of these ozone-depleting substances (ODS) is being or has been phased out. It is recommended you ensure compliance with this universally ratified treaty before attempting to use these gases, in addition to R113, R-123, and R-141b.

Engineering Units

True Mass

Flow Units

Label	Notes
mg/s	milligram per second
mg/m	milligram per minute
g/s	gram per second
g/m	gram per minute
g/h	gram per hour
kg/m	kilogram per minute
kg/h	kilogram per hour
oz/s	ounce per second
oz/m	ounce per minute
lb/m	pound per minute
lb/h	pound per hour

Temperature Units

Label	Notes
°C	degrees Celsius
°F	degrees Fahrenheit
K	Kelvin
°R	degrees Rankine

Time Units

Label	Notes
h:m:s	hours:minutes:seconds
ms	milliseconds
s	seconds
m	minutes
hour	hours
day	days

Flow Units

Volumetric	Std.	Normal	Notes
uL/m	SuL/m	NuL/m	microliter per minute
mL/s	SmL/s	NmL/s	milliliter per second
mL/m	SmL/m	NmL/m	milliliter per minute
mL/h	SmL/h	NmL/h	milliliter per hour
L/s	SL/s	NL/s	liter per second
LPM	SLPM	NLPM	liter per minute
L/h	SL/h	NL/h	liter per hour
US GPM			US gallon per minute
US GPH			US gallon per hour
CCS	SCCS	NCCS	cubic centimeter per second
CCM	SCCM	NCCM	cubic centimeter per minute
cm ³ /h	Scm ³ /h	Ncm ³ /h	cubic centimeter per hour
m ³ /m	Sm ³ /m	Nm ³ /m	cubic meter per minute
m ³ /h	Sm ³ /h	Nm ³ /h	cubic meter per hour
m ³ /d	Sm ³ /d	Nm ³ /d	cubic meter per day
in ³ /m	Sin ³ /m		cubic inch per minute
CFM	SCFM		cubic foot per minute
CFH	SCFH		cubic foot per hour
CFD	SCFD		cubic foot per day
	kSCFM		1000 cubic feet per minute
count	count	count	setpoint count, 0–64000
%	%	%	percent of full scale

Pressure Units

Absolute or Barometric	Gauge	Notes
PaA	PaG	pascal
hPaA	hPaG	hectopascal
kPaA	kPaG	kilopascal
MPaA	MPaG	megapascal
mbarA	mbarG	millibar
barA	barG	bar
g/cm ² A	g/cm ² G	gram force per square centimeter
kg/cm ² A	kg/cm ² G	kilogram force per square centimeter
PSIA	PSIG	pound force per square inch
PSFA	PSFG	pound force per square foot
mTorrA	mTorrG	millitorr
torrA	torrG	torr
mmHgA	mmHgG	millimeter of mercury at 0°C
inHgA	inHgG	inch of mercury at 0°C
mmH ₂ O A	mmH ₂ O G	millimeter of water at 4°C (NIST conventional)
mmH ₂ O A	mmH ₂ O G	millimeter of water at 60°C
cmH ₂ O A	cmH ₂ O G	centimeter of water at 4°C (NIST conventional)
cmH ₂ O A	cmH ₂ O G	centimeter of water at 60°C
inH ₂ O A	inH ₂ O G	inch of water at 4°C (NIST conventional)
inH ₂ O A	inH ₂ O G	inch of water at 60°C
atm		atmosphere
m asl		meter above sea level
ft asl		foot above sea level
V		volt
count	count	setpoint count, 0–64000
%	%	percent of full scale

Optional Pinouts

Additional Pinouts

Individual pinouts available at alicat.com/pinout



Due to variance in cable manufacturing, please identify proper wiring/pins via continuity check & color when using blunt cut multi-strand cables.

Locking Industrial Connector Pinouts

If your mass flow meter was ordered with a six-pin locking industrial connection, please be sure to reference the following pinout diagram.

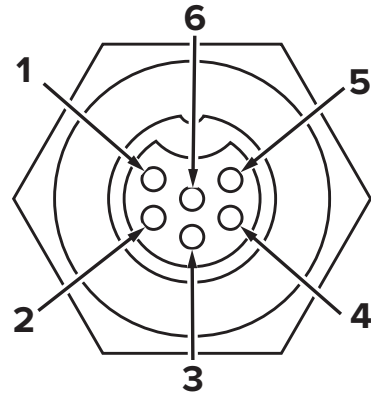
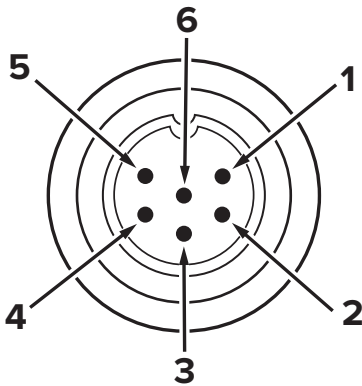

Male Connector: Cable

Female Connector: Device

Pin	Function
1	Power In (+)
2	RS-232TX / RS-485(+)
3	RS-232RX / RS-485(-)
4	Remote Tare (Ground to Tare)
5	Ground (common for power, communications and signals)
6	Signal Out (Voltage or Current as ordered)

The above pinout is applicable to all flow meters ordered with the industrial connector. The availability of different output signals depends on the flow meter options ordered.

9-pin D-Sub Common Pinouts

If your instrument was ordered with a DB9 connection, be sure to check the calibration label on the device or the calibration data sheet and reference the appropriate pinout diagram.

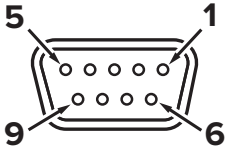

Male Connector: Cable

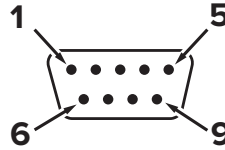

Female Connector: Device

Common 9-pin D-Sub Pinouts

Pin	DB9 (Female) DB9M (Male)	DB9A / DB9K	DB9R	DB9T	DB9U
1	Current Out	NC	TX (+)	TX (+)	RX (-)
2	Analog Out 2	Analog Out	Analog Out	Analog Out	Analog Out
3	RX (-)	Power In	Analog In	Power In	Power In
4	Analog In	Ground	Ground	Ground	Ground
5	TX (+)	TX (+)	NC	NC	NC
6	Analog Out	Analog In	RX (-)	Analog In	Analog In
7	Power In	Ground	Power In	Ground	Ground
8	Ground	Ground	Ground	Ground	Ground
9	Ground	RX (-)	Ground	RX (-)	TX (+)

Key of Terms:

Current Out

Not Connected or optional 4-20 mA analog output signal

Analog In

Remote tare function

Analog Out

0-5 Vdc Output Signal (or 0-10 Vdc optional)

Analog Out 2

5.12Vdc or Optional Secondary Analog Output

TX (+)

Serial RS-232TX or RS-485(+)

RX (-)

Serial RS-232RX or RS-485(-)

NC Not Connected

Power In (+Vdc)

Ground

Common for power, digital and analog signals, and alarms

Additional 9-pin D-Sub Pinouts

Pin	DB9B	DB9G	DB9H	DB9I	DB9N
1	Analog Out 2	RX (-)	TX (+)	NC	Power In
2	Analog Out	Analog Out	Analog Out	Analog Out	Analog In
3	Power In	Ground	Analog In	Power In	Analog Out
4	Ground	Power In	RX (-)	Ground	NC
5	Ground	Ground	Analog Out 2	NC	Ground
6	Analog In	TX (+)	NC	Analog In	Ground
7	Ground	Analog In	Power In	Ground	RX (-)
8	TX (+)	Current Out	Ground	RX (-)	TX (+)
9	RX (-)	Ground	Ground	TX (+)	NC5

M12 Connector Pinouts

If your Alicat Instrument was ordered with the M12 connection, please be sure to reference the following pin-out diagram.

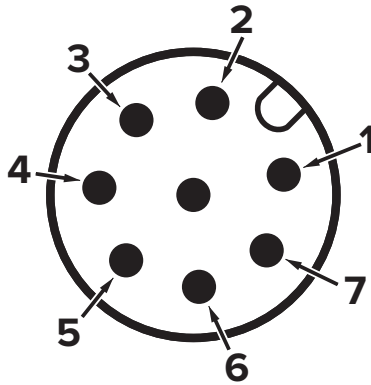

M12 Connector Male

Pin	Function
1	0–5 Vdc (or optional 0–10 Vdc) Output Signal
2	Power In +24 VDC, 1 A recommended for most models
3	Serial RS-232 RX / RS-485(-) Input Signal (receive)
4	Remote Tare (Ground to Tare)
5	Serial RS-232 TX / RS-485(+) Output Signal (send)
6	Static 5.12 Vdc [or optional Secondary Analog Output (4–20 mA, 5 Vdc, 10 Vdc) or Basic Alarm]
7	Ground (common for power, digital communications, analog signals and alarms)
8	Inactive (or optional 4–20 mA Primary Output Signal)

Note: The above pin-out is applicable to all the flow meters with the M12 connector. The availability of different output signals depends on the options ordered. Optional configurations are noted on the unit's calibration sheet.



Due to variance in cable manufacturing, please identify proper wiring/pins via continuity check & color when using blunt cut multi-strand cables.

Individual pinouts available at www.alicat.com/pinout

15-pin D-Sub Common Pinouts

If your instrument was ordered with a DB15 connection, be sure to check the calibration label on the device or the calibration data sheet and reference the appropriate pinout diagram.

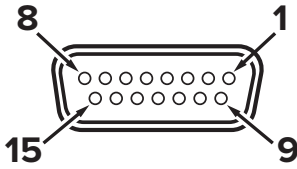

Male Connector: Cable

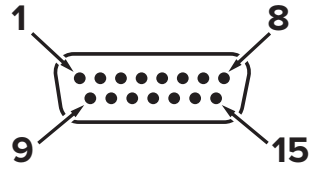

Female Connector: Device

Pin	DB15	DB15A	DB15B	DB15H	DB15K	DB15O	DB15S
1	Ground	Ground	Ground	NC	NC	Ground	Ground
2	Analog Out	Analog Out	Analog Out	RX (-)	Analog Out	NC	Analog Out
3	Ground	Analog In	NC	NC	NC	NC	NC
4	NC	Ground	NC	NC	NC	Analog Out	NC
5	Power In	Ground	Power In	Ground	Ground	Power In	Ground
6	NC	Ground	NC	Analog Out	NC	NC	NC
7	NC	Power In	NC	Ground	Power In	Analog In	NC
8	Analog In	TX (+)	Analog In	NC	Analog In	NC5	Analog In
9	Ground	Ground	Ground	NC	Analog Out 2	Ground	Ground
10	Ground	NC	Ground	Analog Out 2	NC	Ground	Ground
11	Analog Out 2	NC	Analog Out 2	Power In	Ground	Analog Out 2	Analog Out 2
12	NC	Analog Out 2	NC	Ground	Ground	NC	RX (-)
13	RX (-)	NC	NC	NC	RX (-)	NC	Power In
14	Ground	NC	RX (-)	Analog In	TX (+)	RX (-)	TX (+)
15	TX (+)	RX (-)	TX (+)	TX (+)	Ground	TX (+)	Ground



Due to variance in cable manufacturing, please identify proper wiring/pins via continuity check & color when using blunt cut multi-strand cables.

Individual pinouts available at
www.alicat.com/pinout

Key of Terms:

Current Out

Not Connected

Analog In

setpoint for controllers or remote tare function for meters

Analog Out

0–5 Vdc Output Signal (or 0–10 Vdc optional)

Analog Out 2

5.12Vdc or Optional Secondary Analog Output

TX (+)

Serial RS-232TX or RS-485(+)

RX (-)

Serial RS-232RX or RS-485(-)

NC Not Connected

Power In (+Vdc)

Ground

Common for power, digital communications, analog signals and alarms

Additional Information for Alicat CSA and ATEX Approved Devices



EEx nA IIC T4
Class I, Div. 2 Group A, B, C and D T4
24 Vdc, 0.800A max
Class I, Zone 2 AEx nA IIC T4

WARNINGS:



EXPLOSION HAZARD – *DO NOT DISCONNECT WHILE CIRCUIT IS LIVE UNLESS AREA IS KNOWN TO BE NON-HAZARDOUS.*



EXPLOSION HAZARD – *SUBSTITUTION OF COMPONENTS MAY IMPAIR SUITABILITY FOR CLASS I, DIVISION 2.*

Alicat CSA / ATEX approved devices are equipped with a locking connector. Please see page 45 to page 48 for the correct power and signal connections for each type of connector.

See the following page for special conditions regarding the use of these units!



USE of Alicat instruments (L, LC, LCR, M, MW, MS, MC, MCW, MCS, MCR, MCRW, MCRS, MCD, P, PS, PC, PCD, PCS, PCR and PCRS product families) in Class 1 Division 2 applications.



CSA certifies the use of this product for general use as well as use in hazardous locations as defined by Class 1 Division 2 Group A, B, C and D T4.

CSA certification is indicated by the product label as shown below and not by the statements in this, or any accompanying documentation.

Special Conditions:

To comply with CSA certification the following information is included in the product literature:

- When equipment is properly labeled, it is suitable in Class I, Division 2, Group A, B, C and D, T4
 - Tamb. -40°C to +50°C
- Electrical Rating 24Vdc, 0.800A max
- Instruments shall be powered by a CSA certified, UL listed, Class II external power supply suitable for the application
- Instruments shall be housed in an enclosure with a minimum IP54 rating or location providing equivalent protection
- Instrument's final approval shall be provided by the local authority having jurisdiction

USE of Alicat instruments (L, LC, LCR, M, MW, MS, MC, MCD, MCW, MCS, MCR, MCRW, MCRS, P, PS, PC, PCD, PCS, PCR and PCRS product families) in applications requiring ATEX Class 1 Zone 2 Certification.



Properly labeled Alicat instruments comply to the following ATEX standard:

Ex II 3 G EEx nA IIC T4
(-40°C ≤ Ta ≤ +50°C)

The examination certificate was issued by the CSA in accordance with accepted practices and procedures. This confirms compliance with the European ATEX Directive or Group II Category 3G equipment.

ATEX certification is indicated by the product label as shown above and not by the statements in this, or any accompanying documentation.

Special Conditions:

- Properly labeled equipment is only certified for use in ambient temperatures in the range of -40°C to +50°C only
- Electrical Rating 24Vdc, 0.800A max
- Instruments shall be powered by a CSA certified, UL listed, Class II external power supply suitable for the application
- Instruments shall be housed in an enclosure with a minimum IP54 rating or location providing equivalent protection
- Instrument's final approval shall be provided by the local authority having jurisdiction

Limited Lifetime Warranty

Alicat Scientific, Inc. warrants to the original purchaser (hereinafter referred to as “Buyer”) that instruments manufactured by Alicat Scientific (hereinafter referred to as “Product”) shall be free from defects in materials and workmanship for the life of the Products.

Under this warranty, the Products will be repaired or replaced at manufacturer’s option, without charge for parts or labor when the Product is carried or shipped prepaid to the factory together with proof of purchase.

The foregoing shall constitute the exclusive and sole remedy in lieu of other remedies of the Buyer for any breach by Alicat Scientific of this warranty to the maximum extent permitted by law.

This warranty does not apply to any Product which has not been installed or used in accordance with the Product operation and installation specifications provided to Buyer verbally or in writing by Alicat Scientific for the proper and normal use of the Product.

Buyer agrees hereunder that Alicat reserves the right to void any warranty, written or implied, if upon Alicat’s examination of Product shall disclose to Alicat’s satisfaction that the Product failure was due solely, or in part, to accident, misuse, neglect, abuse, alteration, improper installation, unauthorized repair or improper testing by Buyer or agent of Buyer.

Alicat Scientific shall not be liable under any circumstances for indirect, special, consequential, or incidental damages in connection with, or arising out of, the sale, performance, or use of the Products covered by this warranty.

Alicat Scientific does not recommend, warrant or assume responsibility for the use of the Products in life support applications or systems.

Alicat’s warranties as herein above set forth shall not be enlarged, diminished or affected by, and no obligation or liability shall arise or grow out

of Alicat’s rendering of technical advice in connection with Buyer’s order of the Products furnished hereunder.

If Product becomes obsolete, Alicat Scientific, at its own discretion, reserves the right to repair the Product with available replacement parts or upgrade the Product to a current, commercially available version of the original Product. Should upgrading the Product be deemed necessary by Alicat, Buyer hereby agrees to pay an upgrade fee equal to seventy percent of the retail value of the replacement Product. Alicat Scientific hereunder makes no claim that replacement Products will look, function or operate in the same or similar manner as the original product.

When a Product is returned to Alicat Scientific for recalibration this service is considered normal preventative maintenance. Recalibration of Product shall not be treated as a warranty service unless recalibration of Product is required as the result of repairs to Product pursuant to this Warranty. Failure of Buyer to send Product to Alicat Scientific for recalibration on a yearly basis after a period of 36 months from date of manufacture will remove any and all obligations regarding repair or replacement of Product as outlined by this Warranty to Buyer from Alicat Scientific.

This Warranty is in lieu of all other relevant warranties, expressed or implied, including the implied warranty of merchantability and the implied warranty of fitness for a particular purpose, and any warranty against infringement of any patent.

Continued use or possession of Products after expiration of the applicable warranty period stated above shall be conclusive evidence that the warranty is fulfilled to the full satisfaction of Buyer.

Alicat makes no warranty as to experimental, non-standard or developmental Products.

Accessories purchased from Alicat are not covered by this warranty.

Notice: Alicat Scientific, Inc. reserves the right to make any changes and improvements to the products described in this manual at any time and without notice. This manual is copyrighted. This document may not, in whole or in part, be copied, reproduced, translated, or converted to any electronic medium or machine readable form, for commercial purposes, without prior written consent from the copyright holder.

Note: Although we provide assistance on Alicat Scientific products both personally and through our literature, it is the complete responsibility of the user to determine the suitability of any product to their application.

The product complies with the requirements of the Low Voltage Directive 2014/35/EU, the EMC Directive 2014/30/EU and the RoHS Directive 2011/65/EU and carries the CE Marking accordingly. Contact the manufacturer for more information.

Flow Meter Menu Map

Start Here

*** Main Display**

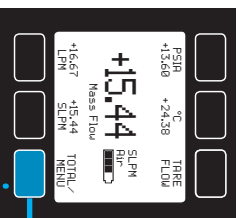

Optional
Flow
Totalizer

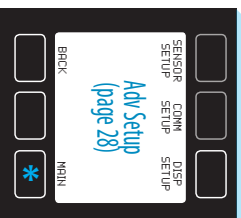
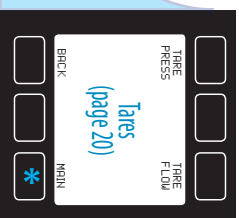
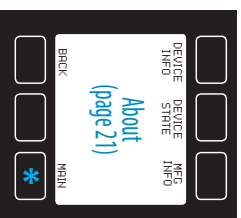
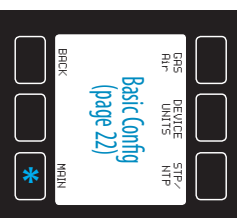
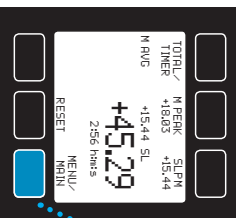

*** Press MAIN to return to the Main Display.**