

optris[®] LS

Portable Infrared Thermometer



Operator's Manual

 **optris**
infrared thermometers

Scope of Supply

- LS unit
- 2 batteries (type AA)
- t/c insertion probe
- USB interface cable
- software
- pouch
- hard case
- operators manual

You will find the serial number on the unit. Always use this number when you contact the customer service concerning maintenance, additional order of components, spare parts or repairs.

Thank you for choosing the **optris® LS** infrared thermometer.

Disposal of old electrical and electronic equipment

This symbol on the unit indicates that this product shall not be treated as household waste. Instead it should be handed over to the applicable collection point for the recycling of electrical and electronic equipment. For more information please contact your distributor.



Optris GmbH
Ferdinand-Buisson-Str. 14
13127 Berlin
Germany

Tel.: +49-30-500 197-0
Fax: +49-30-500 197-10

E-mail: info@optris.de
Internet: www.optris.com

Comments on this manual

Read the manual carefully before the initial start-up. The producer reserves the right to change the herein described specifications in case of technical advance of the product.

Orientation



Icons for easy finding of chapters

Operating elements on the LS unit | **Buttons in the software**

ADJUSTABLE VALUES

Readings on the unit display | **Readings in software screens**

Important information and notes

[▶ Reference to other chapters]

[Menu: Hint to menu items in the software]

Warranty

Each single product passes through a quality process. Nevertheless, if failures occur please contact the customer service at once. The warranty period covers 24 months starting on the delivery date. After the warranty is expired the manufacturer guarantees additional 6 months warranty for all repaired or substituted product components. Warranty does not apply to electrical circuit breakers, primary batteries and damages, which result from misuse or neglect. The warranty also expires if you open the product. The manufacturer offers a 3 months warranty for rechargeable batteries. The manufacturer is not liable for consequential damage. If a failure occurs during the warranty period the product will be replaced, calibrated or repaired without further charges. The freight costs will be paid by the sender. The manufacturer reserves the right to exchange components of the product instead of repairing it. If the failure results from misuse or neglect the user has to pay for the repair. In that case you may ask for a cost estimate beforehand.

Content

	Page		Page
Basic Operation	4	Material and Location Names	19
Batteries	4	Data Logger Recall	20
User interface	4	Thermocouple Probe	21
Display	5	Software OptrisConnect	22
Measurement	6	Installation and Start	22
Handling	6	Connection to the Computer	22
Measurement Functions	7	Data Logger Functions	24
Display Backlight	8	Time Stamp	25
Laser Sighting	8	Material and Location Names	25
Optics	9	Digital Displays	26
Setup Menu 1	11	Diagram Functions	27
Emissivity Setting	11	Device Setup	32
High Alarm	12	Device Information	33
Low Alarm	12	Specification	34
Long-Term Measurement (Lock Mode)	13	Technical Data	34
Setup Menu 2	14	Factory Default Setting	36
Temperature Unit	14	Troubleshooting	36
Buzzer	15	Maintenance	37
Flip-Display	15	Principle of Operation	38
Ambient Temperature Compensation	16	Emissivity	39
Reset	17	Appendix A – Emissivity Table Metals	41
Data Logger	18	Appendix B – Emissivity Table Non Metals	42
Storing Data	18	Appendix C – Declaration of Conformity	43

Basic Operation

Batteries



To open the battery compartment gently press the cover lid on the left side of the handle in direction of the arrow (see picture). Insert the batteries (orientation as shown inside the compartment) and close the cover lid. If the batteries are low the battery symbol will appear in the display. Please exchange the batteries immediately if the symbol is flashing.



Please do not use old and new batteries together.
Please use only alkaline or rechargeable batteries
[Type: Mignon AA, R6, UM3].

User interface

- 1 Precision glass optics
- 2 Optics toggle switch SF/ CF
- 3 Tripod mount
- 4 Trigger
- 5 Display
- 6 Up and Down buttons
- 7 Mode (I and II) buttons
- 8 Handle and battery compartment
- 9 USB interface
- 10 t/c input

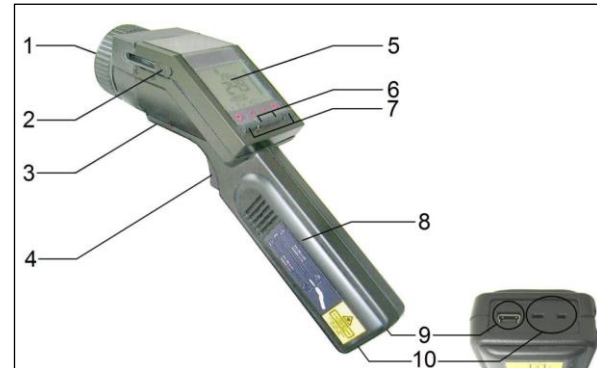

Display

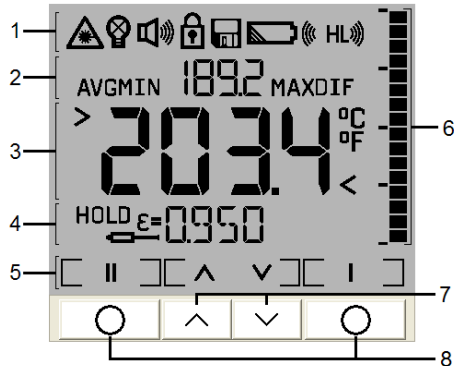

Readings in the display

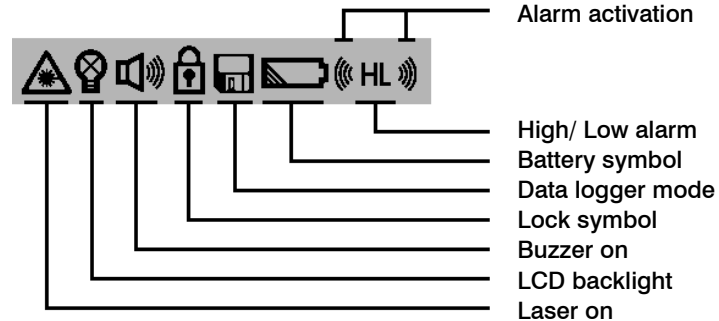

Status information

- | | |
|---|---|
| 1 | Status information |
| 2 | Upper display: Measurement functions (MIN-, MAX-, DIF-, AVG-indication), Data logger position |
| 3 | Main display: IR-temperature and unit (°C/ °F) |
| 4 | Lower display: HOLD, emissivity, probe temperature, Tamb-value, material and location name |
| 5 | Assignment of buttons: Mode I I , Mode II II , Up Λ and Down V |
| 6 | Bar graph display |
| 7 | Up and Down buttons |
| 8 | Mode buttons |

Measurement

Handling

Please hold the unit as shown in the right figure and aim at the target. Pull the **Trigger** [1] and keep it pressed – if the laser is activated the true size and location of the measurement spot will be shown on the object surface. The temperature of the object is shown in the display [2].

The LS can also be used in vertical position (measurement downwards). With this handling small objects like electronic SMD components can easily be aimed and measured. For this purpose please hold the unit as shown in the left figure. If the display switch is set to **Auto** (default setting) or set to



On, the **I**-button automatically gets the function of the **Trigger** [1] and the readings in the display [2] are turned by 180°
[► **Flip-Display**].

Please note, that at vertical use (Flip mode) in context with a switched display also the assignment of the Mode buttons (I and II) will change.



Measurement Functions

The measured temperature will be shown in the main display [1]. In the upper display the according maximum temperature [2] and in the lower display the set emissivity [3] will be displayed. The bar graph in the right part of the display [4] shows temperature trends. The scaling will be done automatically between minimum reading (no segment) and maximum reading (all segments).

Hold function: The temperature will be displayed for **7 seconds** after the **Trigger** is released. The display shows **HOLD**. The unit automatically switches off after this time if no button is pressed.

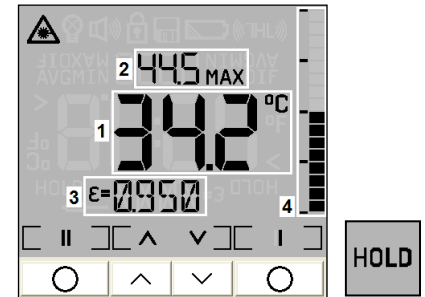

After taking a measurement the following functions can be displayed in turn by pressing the **[▲]**-button (starting from the **HOLD** mode):

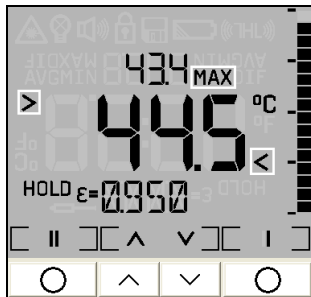

Maximum reading [MAX]



Minimum reading [MIN]

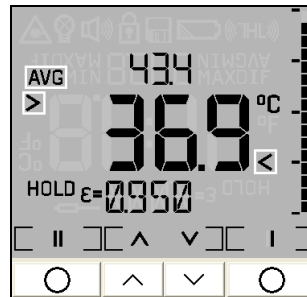

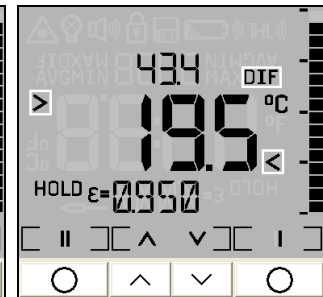

Average reading [AVG]





Difference reading [DIF]

MAX: maximum value determined during measurement
MIN: minimum value determined during measurement

AVG: average value (related to duration of measurement)
DIF: the difference between **MIN** and **MAX**

These values will be shown in the **main display**, which is marked with the symbols  and  in this case. The current temperature (in the **HOLD** mode: the last measured temperature) will be shown in the **upper display**. After turning into the **measure mode** or after switch off of the unit the selected measurement function will be kept.

Recall (Last Value) The last measured value remains stored in the LS after switch off. To recall this value please press (in the switched off condition) the  - or  -button. The unit will be set into the **HOLD** mode.

In the emissivity menu the last measured temperature value can be corrected afterwards by changing the emissivity.



Display Backlight

Pull the **Trigger** (keep it pressed) and *then* press the  -button to activate/ deactivate the display backlight. The symbol in the display flashes to confirm.

Default setting: On

This function is not available in the Flip mode.



Laser Sighting

Pull the **Trigger** (keep it pressed) and *then* the  -button to activate/ deactivate the laser. The laser symbol in the display (only if the trigger is pulled) indicates the active laser.

Default setting: On

WARNING: Do not point the laser directly at the eyes of persons or animals! Do not stare into the laser beam. Avoid indirect exposure via reflective surfaces!



Optics

The LS has switchable optics. The two possible operating modes are indicated as **SF mode (Standard Focus)** and **CF mode (Close Focus)**.

In the **SF mode** (standard operating mode) objects $\geq 16\text{mm}$ can be measured. The measurement spot will be exactly marked with the patented crosshair laser, i.e. the real size and location of the spot is shown on the object – independently from the distance and with no optical offset (see right figure).



In the **CF mode** objects $\geq 1\text{mm}$ (e.g. electronic components) can be measured. In this operating mode a two point laser shows the spot on the target. Both laser beams cross at the focus distance (62mm from front of housing) and indicate the minimum spot size at this distance (Diameter: 1mm).

To switch between SF and CF mode please shift the **Optic switch** which is located beside the display, to the corresponding position (see right figure).

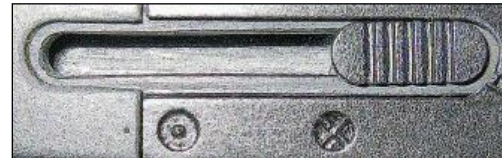

The symbols on the housing have the following meaning:



SF/ Crosshair laser

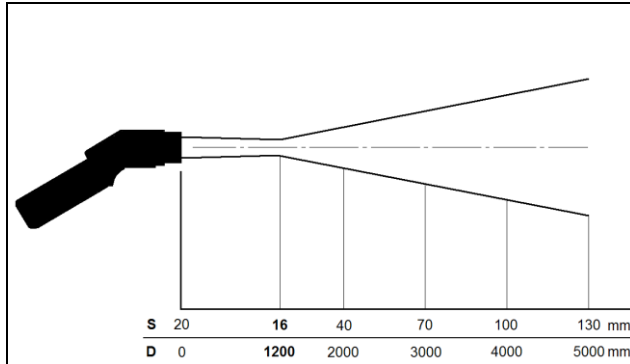

D:S (focus point) = 75:1/ 16mm@1200mm

D:S (far field) = 36:1

D = Distance from front of the unit to the object

S = Spotsize



CF/ Two point laser

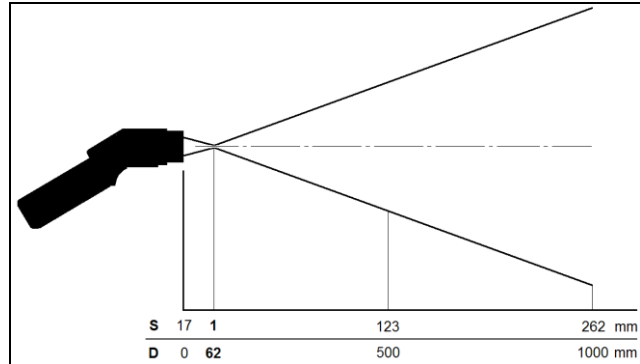

D:S (focus point) = 62:1/ 1mm@62mm

D:S (far field) = 4:1

The measured area of the object (spot size) depends on the distance. For a correct measurement the spot size should have at least the **same size like** the object or should be **smaller than** that at all times.

Setup Menu 1

In this menu **Emissivity**, **Alarm values** and the **Lock mode** can be set up.

Each setting or change of values and parameters will be saved by pressing the **Trigger** or the **I** -button.

Trigger → **SAVE** → **Measure mode**

I → **SAVE** → **next menu item**

To activate the setup menu the unit must be in the HOLD mode.

If none of these buttons is pressed the settings or changes done before will not be saved and the unit switches off after approx. **30 s**.

Emissivity Setting

The emissivity (ϵ - Epsilon) is a material constant which describes the ability of the body to emit infrared energy. It can range between 0 and 1 (0 and 100 %) [**► Emissivity**].

Setting range: 0,100...1,100 (values > 1,000 = amplification)
Default setting: 0,950

HOLD → **I** → ϵ flashes → **▲** → INCREASE ϵ
⇒ **▼** → DECREASE ϵ

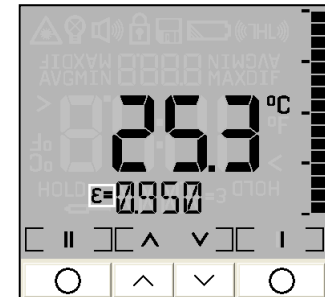

ϵ



High Alarm

Setting of a temperature value (alarm setpoint). If the temperature reading is *above* this setpoint a visual **display colour = red** + **flashing alarm symbol** and an acoustic signal [**▶ Buzzer**] will be generated:

Setting range: -35...900°C
Default setting: 900°C

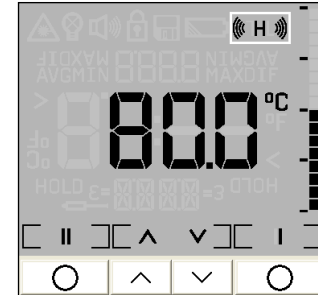
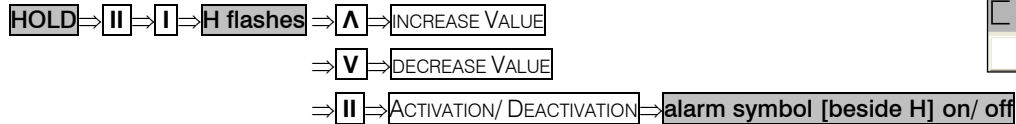

Low-Alarm

Setting of a temperature value (alarm setpoint). If the temperature reading is *below* this setpoint a visual **display colour = blue** + **flashing alarm symbol** and an acoustic signal [**▶ Buzzer**] will be generated:

Setting range: -35...900°C
Default setting: -35°C

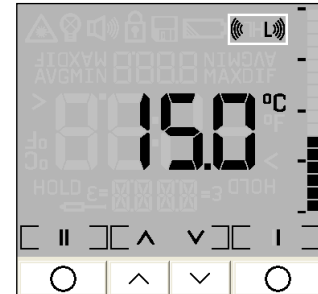
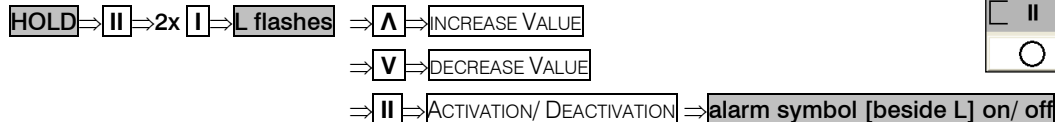

Long-Term Measurement (Lock Mode)

This function allows a continuous measurement without pulling the trigger for that time. The laser is only working if the trigger is pulled.

Setting range: On/ Off

Default setting: Off

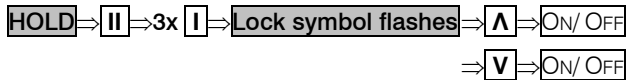

after setting to **On**:



or:

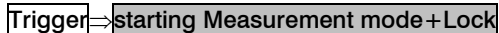

You can deactivate the Lock function in the same order, but starting from

Measurement mode+Lock.

The data logger functions are also available in the Lock mode [**▶ Data Logger**].

For a long-term temperature measurement of an object it is recommended to mount the unit on a tripod.

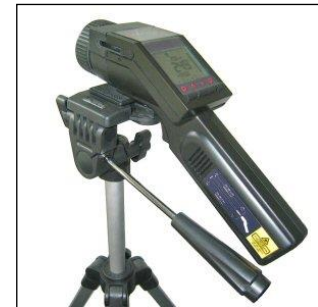
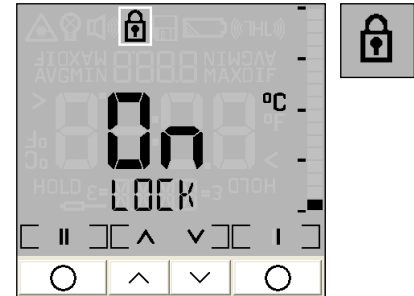

Setup Menu 2

In this menu **Temperature unit**, **Buzzer**, **Flip display**, **Ambient temperature compensation** and **Factory default settings** can be set up.

HOLD → **II** → 4x **I** → **2. Menu**

The procedure is the same as described in the setup menu 1:

Trigger → **SAVE** → **Measurement mode**

I → **SAVE** → **next menu item**

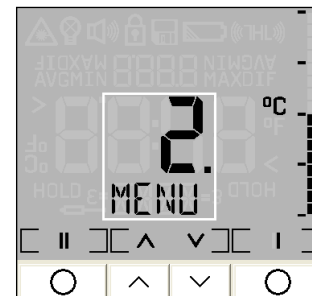

°C

Temperature Unit

With this function you can switch the temperature unit in the display between °C und °F.

Setting range: °C/ °F

Default setting: °C

2. Menu → **II** → **Temperature unit flashes** ⇒ **Λ** ⇒ °C/°F
⇒ **V** ⇒ °C/°F

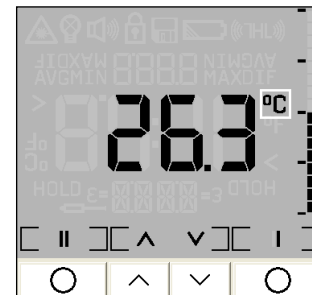

Buzzer

With this function the buzzer (acoustic alarm signal) can be switched on and off. Independent from this the key tone (confirmation by pressing Mode, Up and Down button) will remain On.

Setting range: On/ Off
Default setting: On

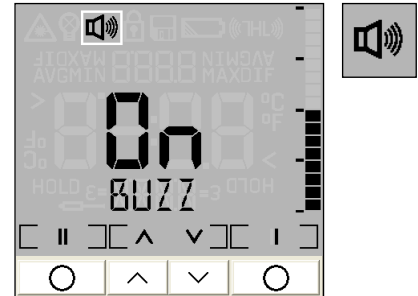
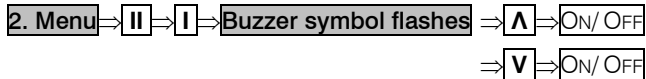

Flip-Display

The LS has a so called Flip display (turn around display). As the unit can be used in horizontal and in vertical position (preferably in combination with the CF mode), the ability to switch allows a comfortable operation in both positions.

Setting range: Auto/ Off/ On
Default setting: Auto

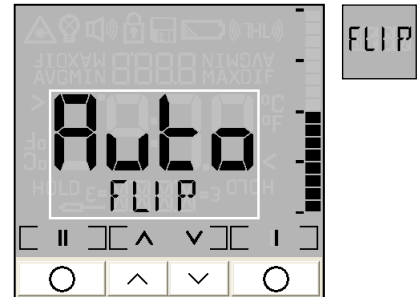
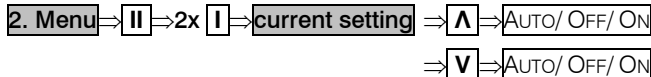

- AUTO:** automatic position detection (by internal position sensor) and display switch according to the handling of the unit
- OFF:** no switch (for reading at horizontal measurements)
- ON:** permanent switch (for reading at vertical measurements)

If ON is activated the display will switch immediately (see the right picture). Please note, that in this context also the assignment of the Mode buttons (I und II) changes.

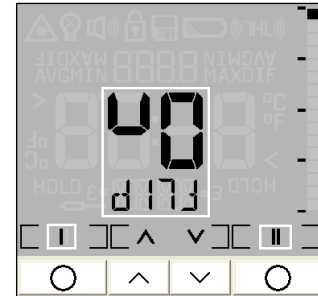

Ambient Temperature Compensation

In dependence on the emissivity value a certain amount of ambient radiation will be reflected from the object surface. To compensate this impact you can use this function to enter a temperature value for the ambient radiation [Tamb]:

- Setting range:** -35...900°C
- Default setting:** deactivated

An activation of this function on the LS for the first time is only possible with the supplied software [▶ Device Setup].

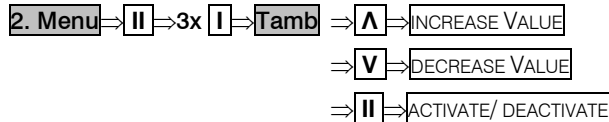

If the Tamb-function is activated, the current set Tamb-value can be easily displayed as follows:

Trigger + **Λ** ⇒ **Toggle between Emissivity and Tamb in lower display**

If, in addition, a thermocouple probe is connected, the lower display will toggle between **Emissivity**, **t/c probe temperature** and **Tamb value**.

[▶ **Thermocouple Probe**]

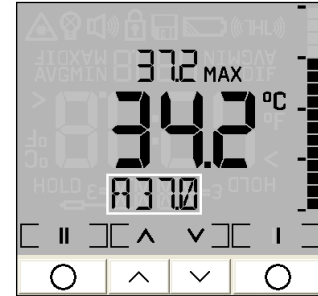

Reset

With this function the unit can be set back to the factory default values

[▶ **Factory Default Setting**].

2. Menu ⇒ **II** ⇒ 3 or 4¹⁾x **I** ⇒ **RES** ⇒ **II** ⇒ **RES flashes** ⇒ **II** ⇒ **RESET**
⇒ **I** ⇒ **HOLD**
⇒ **Trigger** ⇒ **Measure mode**

1) depends on the status of Tamb function

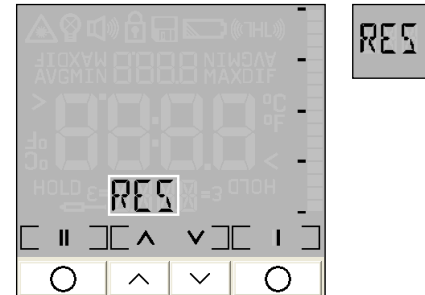

The stored values in the data logger will not be deleted with the reset function.



Data Logger

The LS has an internal data logger with a maximum capacity of 100 measurement protocols. Every protocol contains the following values:

Position number [P 00...P 99], object temperature, MAX-, MIN-, AVG- and DIF-value, emissivity, probe temperature (if connected), material and location name

Storing Data

To store any data the unit must be in the **HOLD** mode. At first please take your measurement and after this release the **Trigger**:

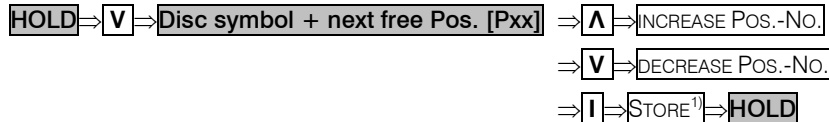

¹⁾ The storage will be confirmed with a double buzzer tone.

If you pull the **Trigger** *no storage* will be made and the unit changes to the **Measurement mode**.
If no button is pressed, also *no storage* will be made and the unit switches off after approx. **30 s**.

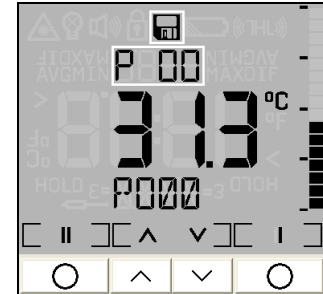

If the storage mode is started the next free position will automatically be shown.
If you select an occupied position, the P flashes in the upper display.
The storage function can also be executed after recall of the last value [▶ Recall (Last Value)].

Material and Location Names

You can assign a 4-digit alpha numeric description to any data logger position. This description will be shown in the bottom display and has the following presetting:

P000 (for position 1) – P099 (for position 100)

In the editing mode you can choose between **20 pre-defined descriptions** (SURF, ENG, ..., GLAS, ..., PVC, etc.). To do this please start the data logger mode and choose a desired position:

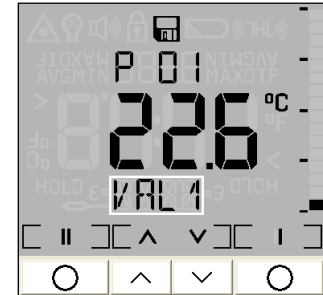

You can also **define own descriptions**. The following character set can be used:

[A...Z] [0...9] [-/<>] [empty]

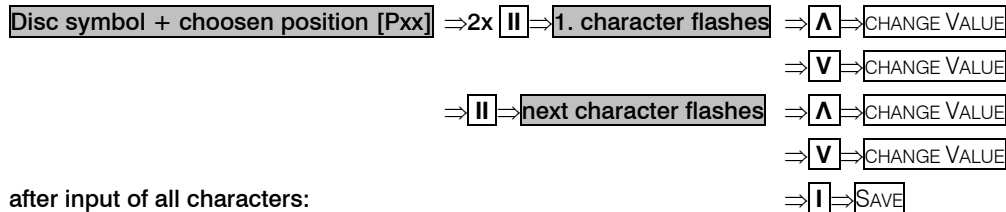



Software OptrisConnect

Installation and Start

Main functions:

- Download of logger data
- Display and record of temperature trends
- Setup of parameters

Minimum system requirements:

- Windows XP, Vista, 7
- USB interface
- Hard disc with at least 30 MByte free space
- At least 128 MByte RAM
- CD-ROM drive

Insert the installation CD into the according drive on your computer. If the auto run option on your computer is activated the installation wizard will start automatically. Otherwise please start **setup.exe** on the CD-ROM. Follow the instructions of the wizard until the installation is finished.

The installation wizard will place a launch icon on the desktop and in the start menu:

[Start]\Programs\Optris GmbH\OptrisConnect.

If you want to uninstall the software from your system please use the **uninstall icon** in the start menu.



Connection to the Computer

Please connect the LS with your computer by using the special USB adapter cable. After you have started the software and the communication has been established the status line (below the time axis) will show the following information:

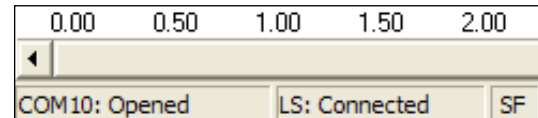

COMxx: Opened

active COM port if a USB adapter cable is connected

LS: Connected

successful communication with the connected LS

SF/ CF

selected optics mode on the LS

**Please use for a connection between the LS and a computer only the supplied USB adapter cable, as otherwise there will be no function.
The connection cable supplied is not a standard USB cable!**

As long as the LS is connected to your computer it will be powered via the USB interface. In this case operation is also possible if no batteries are inside the unit. At digital communication the unit display shows the **HOLD** – mode but the unit is measuring continuously and is sending temperature data via the interface to the computer **[► Digital displays]**.

If you cannot establish a communication in spite of correct connection between LS and computer please choose the correct COM port under **Menu: Setup\ Interface**. If the USB adapter cable is connected this port is marked **[Infrared Thermometer Adapter]**:

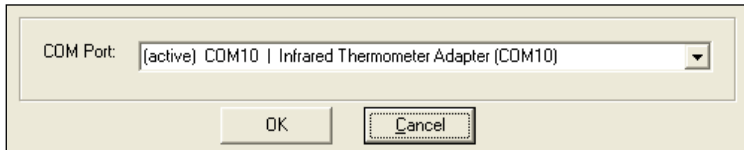

Language

You can select the desired language under **Menu: Setup\ Language**.



Data Logger Functions

To download the logger data from the unit please press the **Logger** -button [Menu: Measurement\ Download logger data].

All data from the logger will be displayed in an extra window as a table:

Index	Date	Time	TObj	TObjMin	TObjMax	TObjAvg	TObjDiff	TInt	TExt	Hi Alarm	Lo Alarm	Eps	Name
1	14.10.2005	20:58:14	25,8°C	25,8°C	25,9°C	25,8°C	0,1°C	26,0°C	25,7°C	29,7°C	-40,0°C	0,946	P000
2	14.10.2005	20:13:50	26,8°C	26,8°C	29,8°C	27,9°C	3,0°C	27,3°C	28,7°C	-40,0°C	0,946	P001
3	14.10.2005	20:58:24	26,0°C	25,6°C	26,0°C	25,8°C	0,4°C	26,0°C	25,7°C	29,7°C	-40,0°C	0,946	P002
4	14.10.2005	20:58:28	25,7°C	25,6°C	25,8°C	25,7°C	0,2°C	26,0°C	25,8°C	29,7°C	-40,0°C	0,946	LH12
5	14.10.2005	20:58:58	25,5°C	25,5°C	25,8°C	25,6°C	0,3°C	26,0°C	25,9°C	29,7°C	-40,0°C	0,946	P004
6	14.10.2005	20:17:20	599,6°C	29,2°C	600,5°C	538,2°C	571,3°C	27,2°C	28,7°C	-40,0°C	0,947	P005
7	14.10.2005	20:14:06	26,8°C	26,8°C	29,8°C	27,9°C	3,0°C	27,3°C	28,7°C	-40,0°C	0,946	P006
8	18.10.2005	13:16:46	22,3°C	22,0°C	23,0°C	22,4°C	1,0°C	25,6°C	900,0°C	-40,0°C	1,000	P007
9	19.10.2005	17:05:06	23,0°C	21,3°C	23,2°C	22,6°C	1,9°C	26,8°C	900,0°C	-40,0°C	0,999	P008
10	19.10.2005	17:05:12	23,0°C	21,3°C	23,2°C	22,6°C	1,9°C	26,8°C	900,0°C	-40,0°C	0,999	P009
11	19.10.2005	17:05:28	34,6°C	24,8°C	34,6°C	28,8°C	9,8°C	26,8°C	900,0°C	-40,0°C	0,999	P010
12	20.10.2005	13:50:46	24,6°C	24,2°C	26,0°C	24,5°C	1,8°C	27,1°C	30,0°C	-40,0°C	1,000	P011
13	20.10.2005	13:28:24	24,1°C	24,1°C	24,3°C	24,1°C	0,2°C	27,0°C	29,1°C	-40,0°C	0,950	P012
14	20.10.2005	13:51:12	51,1°C	21,0°C	51,2°C	37,3°C	30,2°C	27,1°C	30,0°C	-40,0°C	1,000	P013
15	20.10.2005	13:53:28	21,8°C	21,8°C	21,9°C	21,8°C	0,1°C	27,3°C	30,0°C	-40,0°C	1,000	PP5L
16	20.10.2005	18:06:44	48,7°C	24,3°C	48,6°C	41,2°C	24,3°C	24,5°C	30,0°C	-40,0°C	0,950	PD15
17	20.10.2005	18:08:48	-11,1°C	-11,4°C	4,8°C	-10,7°C	16,2°C	24,6°C	30,0°C	10,0°C	0,950	PD16

Columns in the logger table

Index	serial number
Date	date of measurement
Time	time of measurement
TObj	object temperature
TObj Min	min. object temperature
TObj Max	max. object temperature
TObj Avg	average object temperature
TObj Diff.	difference between TObj Min and TObj Max
TInt	internal unit temperature (if connected)
TExt	t/c temperature (if connected)
Hi-Alarm	High-Alarm value
Lo-Alarm	Low-Alarm value
Eps	emissivity
Name	material or position name

Logger temperatures, on which the set **High-Alarm** value has been exceeded, will be shown in the table **red and bold**.

Logger temperatures, on which the set **Low-Alarm** value has been fallen below, will be shown in the table **blue and bold**.

Save as...

opens an explorer window to save the logger data on your computer [***.lgg**]

Open File...

opens an explorer window to open existing logger files ¹⁾

Clear Logger...

After confirmation of the security query all logger data inside the LS will be deleted [unit display shows: **CLR**].

The status line inside the data logger window (beneath the table) shows the location and file name of the current data.

¹⁾ **The logger file can also be opened and edited with any text editor or Microsoft Excel.**

Time Stamp

If you store data inside your LS for the first time (after insertion of the batteries), an internal timer will be started automatically. When connected to a computer the timer will be synchronized with the computer time. Thus, every logger entry is stored with date and time of the measurement.

Please store the logger data on your computer before you change the batteries. Otherwise an exact assignment of the time of measurement is not possible (Restart of the timer).

Material- and Location Names

You can assign descriptions to each logger position by choosing between 20 predefined descriptions or defining own descriptions. The table of the predefined descriptions can be edited with the software.



To open the table please press the **Names** button [Menu: Device\ Material and location names]. Then mark the entry which you would like to edit with the cursor and enter the desired name. The maximum length is **four digits**. The following character set can be used: [A...Z] [0...9] [-/<>] [Space].

If a wrong input is made (no character/ more than 4 characters/ invalid character) the position number in the table appears red and the table cannot be closed with **OK**.

OK

saves the changed table inside the LS

Standard

loads the standard table (factory default) in the connected unit

Up

moves the selected entry up

Down

moves the selected entry down

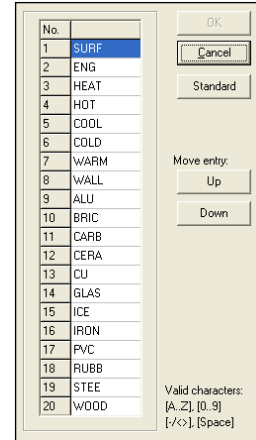

TObj
24°C

Digital Displays

If the LS is connected to your computer and you start the software, the current temperature **TObj** will be shown as digital display (top right).

You can add additional displays for the internal temperature **TInt** and the temperature of a connected t/c probe **TExt** [Menu: View\ Digital displays].

The once selected displays will also appear after a restart of the software. The **size** can be changed if you put the mouse cursor on the line beneath the display and pull it down. The buttons of the tool bar will also be moved (depending on the display size).

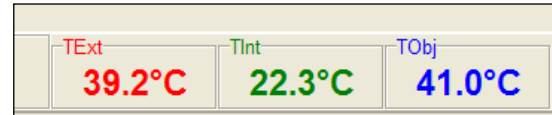
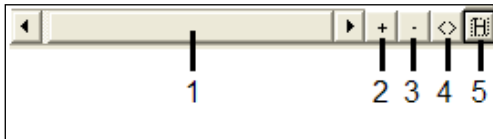

Diagram Functions

STARTING THE MEASUREMENT

To start a measurement, please press the **Start** button in the tool bar
 [Menu: Measurement\ Start].



Control elements of the time axis:

- 1 Scroll bar
- 2 Zoom in (increase)
- 3 Zoom out (decrease)
- 4 Whole range
- 5 H: Hold/ C: Continue

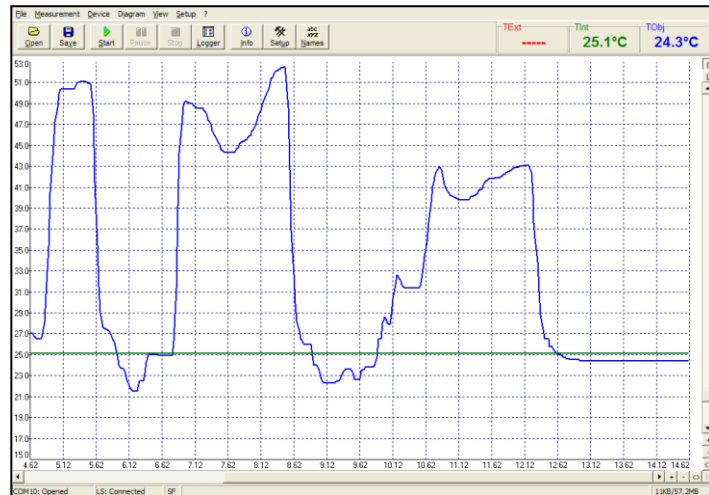



Any activation of a control element of the time axis will stop the further actualization of the measurement graph. The measurement itself continues in the background. To return to the current measurement graph please press the **Pause** button [Menu: Measurement\ Pause] or **C**.

During the stopped status any parts of the diagram can be selected with the **Time scroll bar**. With the zoom in-button **+** these parts can be stretched (enlarged) and with the zoom out-button **-** clinched (minimized).

SCALING OF THE TEMPERATURE AXIS

With **global scaling** the temperature range of the diagram will automatically be adapted to the respective peak values. The range will remain as set during the whole measurement.

With **local scaling** the temperature range of the diagram will be adapted dynamically to the respective peak values. After the respective peak has left the diagram in the further process of the measurement, the range will be readapted. This option enables an optimum display of the temperature graph.

A **manual scaling** can be done at any time using the control elements of the temperature axis.

Control elements of the temperature axis:

- | | |
|---|---------------------|
| 1 | Global auto scaling |
| 2 | Local auto scaling |
| 3 | Scroll bar |
| 4 | Zoom in (increase) |
| 5 | Zoom out (decrease) |
| 6 | Whole range |

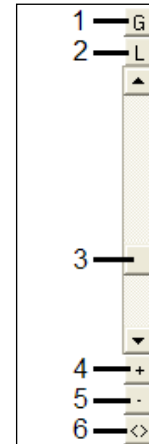

Activation of the desired option:
Control elements (temperature axis) or [Menu: Diagram].

STOP MEASUREMENT

To stop the current measurement please press the **Stop** button [Menu: Measurement\ Stop].
The **Save** button [Menu: File\ Save as] opens an explorer window to select destination and file name [file type: *.dat].



SAVING OF DATA

The menu item options [Menu: Setup\ Options] enables the following settings for data protection:



Warning if unsaved data exist

if activated, each **Stop** and new **Start** will be followed by the query:
There is unsaved Data. Save now?
[Default setting: activated]

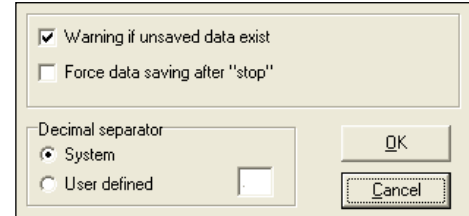

Force data saving after „stop“

if activated, after each **Stop** an explorer window for saving the data will be opened automatically.

Decimal separator

System uses the computer system based separator for saving the data. If you want to use a **user defined** (which may be helpful for further use of the data files with other applications) you can enter the desired separator in the according field.

If none of both options is activated, a new measurement will be started after termination of one measurement and pressing of the **Start** button.
In this case the former data are deleted!



OPENING OF FILES

To open a saved file please press the button **Open** [Menu: File\ Open]. You can select the desired file in the newly opened explorer window [file type: *.dat].

The data files can also be opened and edited with any text editor or with Microsoft Excel.

DIAGRAM SETTINGS

The menu item Settings [Menu: Diagram\ Settings] enables the selection of the following diagram options:

- Digital** Selection which signals should be displayed as digital display
- Diagram** Selection which signals should be displayed as graph [TObj, TInt, TExt]
- Pen Width** Pen width of the temperature graphs [1...5]
- Color** Color of the temperature graph and digital displays
- Initial time** Time frame on the x-axis, which should be displayed at the beginning of a measurement

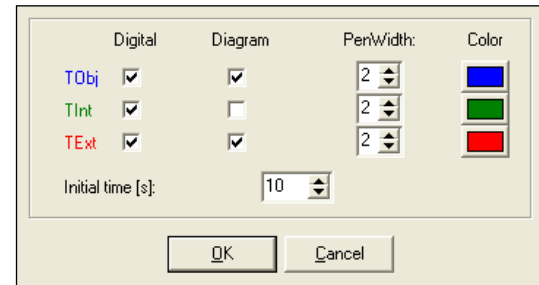

MEASUREMENT CONFIGURATION

The menu item [Menu: Measurement\ Settings] opens the following dialog:

Max. data count

Limitation of the maximum number of data values – when achieved the measurement will be stopped

Memory

Memory, calculated from the max data count value (will also be displayed in the status line)

Recording interval

Time between single data [1ms...10s]

Recording time

maximum time of measurement, calculated from **Max data count** and **Recording interval**

The dialog box shows the following settings:

Max. data count	1000 x 5000
Memory	57.2MB
Recording interval (equal with diagram resolution):	20msec
Recording time:	1 day, 4 h

Buttons: OK, Cancel

A change of the parameter **Max data count** will have influence on the **Memory** and **Recording time**.

A change of the parameter **Recording interval** will have influence on the **Recording time** only.



Device Setup

The button **Setup** [Menu: Device\ Setup] opens a dialog window for setting up the following parameters of the LS:

Emissivity	Backlight
High alarm	Laser
Low alarm	Buzzer
Ext. Ambient Temp.	Lock mode
Temperature unit	Flip mode

The first activation of **Ext. Ambient Temp.** will initiate this feature inside the LS unit. From this time the feature will appear in the **Setup Menu 2** on the unit, also if deactivated again in the device setup [► **Ambient Temperature Compensation**].

A reset of the unit to the factory default values [► **Reset**] will delete the display of this function during operation [Setup Menu 2].

To load the factory default settings into the unit please press the **Factory Default** button (same functionality as ► **Reset**). An additional query avoids a reset of the unit by mistake.

A change of parameters will be taken over from the connected unit *immediately* and vice versa.

Device Information

The button **Info** [Menu: Device\ Device Info] will display the following unit-specific information:

Device type	Description from the manufacturer
Firmware Rev.	Revision number of the internal software
Hardware Rev.	Revision number of the internal hardware
Serial No.	Serial number of the unit
IR Temperature range	Measurement range (IR)

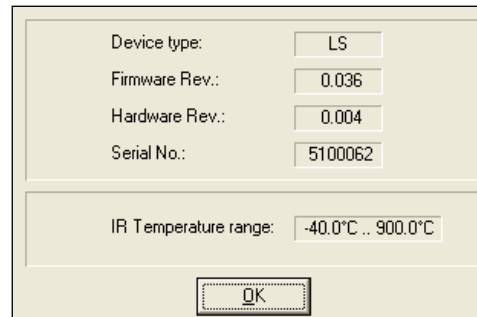

The screenshot shows a dialog box with a light beige background. It contains five rows of information, each with a label on the left and a text box on the right. The labels are 'Device type:', 'Firmware Rev.:', 'Hardware Rev.:', 'Serial No.:', and 'IR Temperature range:'. The text boxes contain the values 'LS', '0.036', '0.004', '5100062', and '-40.0°C .. 900.0°C' respectively. At the bottom center of the dialog box is a button labeled 'OK'.

Device type:	LS
Firmware Rev.:	0.036
Hardware Rev.:	0.004
Serial No.:	5100062
IR Temperature range:	-40.0°C .. 900.0°C

OK



Specification

Technical Data

Temperature range IR:	-35...900°C (-30...1650°F)
Temperature range probe:	-35...900°C (-30...1650°F)
Temperature unit:	°C/ °F (switchable)
Spectral range:	8...14μm
Optical resolution:	75:1 (16mm@1200mm/ 90% energy) switchable to CF (close focus): 1mm@62mm/ 90% energy
Minimum spot size:	1mm@62mm (CF mode)
Temperature resolution:	0,1°C
Accuracy IR:	±0,75 % (100 to 900 °C)
(at T _{Amb} 23±5 °C)	±0,75 °C (20 to 99,9 °C) ±1,5 °C (-20 to 19,9 °C) ±2,5 °C (-35 to -20,1 °C)
Accuracy t/c input:	±0,75°C or ±1,0% of reading (whichever is greater)
Repeatability:	±0,5°C or ±0,5% of reading (whichever is greater)
Temperature coefficient ¹⁾ :	±0,05K/K or ±0,05%/K (whichever is greater)
Response time:	150 ms (95% signal)
Display:	LCD Flip Display with backlight (horizontal and vertical viewing directions controlled by position sensor)
Display backlight:	green and alarm colours (red/ blue)
Bar graph display:	auto scaling
Laser:	<1mW, class II, 630-650 nm SF: patented crosshair laser

(size of crosshairs = spot size@ any distance)
CF: two point laser (laser dot size = spot size@ focus distance)

Measurement functions:	MAX, MIN, DIF, AVG, HOLD
Alarm functions:	High and Low alarm, audible and visual
Emissivity/ Gain:	0,100...1,100 (adjustable)
Interface:	USB
Input:	t/c type K
Data Logger:	100 measurement protocols with time stamps, 4 digit material and location names (editable)
Software:	OptrisConnect oscilloscope software, 20 readings per second
Power supply:	2xAA (Mignon Alkaline) batteries or via USB cable (if connected to a PC)
Battery life time:	5h (operating with laser and backlight 50% on) 10h (operating with laser and no backlight) 25h (operating without laser and backlight)
Ambient temperature:	0 – 50°C
Storage temperature:	-30...65°C (without batteries)
Relative humidity:	10 – 95%, non condensing
EMI:	89/336/EWG
Weight:	420 g
Vibration:	IEC 68-2-6: 3G, 11 – 200Hz, any axis
Shock:	IEC 68-2-27: 50G, 11ms, any axis
Tripod mounting:	¼ - 20 UNC

¹⁾ below 20°C and above 30°C

Factory default settings

The unit has the following presettings at the time of delivery:

Emissivity:	0,950	Lock:	Off
Optics:	SF	Buzzer:	On
High alarm:	900°C/ deactivated	Laser:	On
Low alarm:	-35°C/ deactivated	Display backlight:	On
Temperature unit:	°C	Display turn:	Auto

The Reset function will set the unit back to these default values (exception: optics).

Troubleshooting

Display	Problem	Action
temperature reading: LLLL	object temperature below measurement range	choose target within measuring range
temperature reading: HHHH	object temperature above measurement range	choose target within measuring range
battery symbol is on or flashing	low batteries	check/ replace batteries
blank display	empty batteries	check/ replace batteries immediately
laser does not work	low batteries/ laser deactivated	see above activate the laser

Maintenance

Lens cleaning: Blow off loose particles using clean compressed air. The lens surface can be cleaned with a soft, humid tissue (moistened with water) or a lens cleaner (e.g. Purosol or B+W Lens Cleaner).

Cleaning the housing: To clean the exterior housing, use a humid tissue (wetted with water or a mild commercial cleaner).

PLEASE NOTE: Never use cleaning compounds which contain solvents (neither for the lens nor for the housing).

CAUTIONS: Avoid static electricity, arc welders, and induction heaters. Keep away from very strong EMF (electromagnetic fields). Don't leave the unit on or near objects of high temperature. Avoid abrupt changes in ambient temperature. If this occurs, allow 20 minutes for thermal stabilization before the use to prevent the possibility of inaccurate temperature readings.

WARNING: Do not touch live voltage with the contact probe.

In case of problems or questions, which may arise when you use the optris® LS, please contact our service department. The customer service staff will support you with questions concerning the optimization of the work with the infrared thermometer, calibration procedures or with repairs.

Principle of Operation

Basics of Infrared Thermometry

Depending on the temperature each object emits a certain amount of infrared radiation. A change in the temperature of the object is accompanied by a change in the intensity of the radiation. For the measurement of “thermal radiation” infrared thermometry uses a wave-length ranging between 1 μm and 20 μm .

The intensity of the emitted radiation depends on the material. This material contingent constant is described with the help of the emissivity which is a known value for most materials (see enclosed table emissivity).

Infrared thermometers are optoelectronic sensors. They calculate the surface temperature on the basis of the emitted infrared radiation from an object. The most important feature of infrared thermometers is that they enable the user to measure objects contactless. Consequently, these products help to measure the temperature of inaccessible or moving objects without difficulties. Infrared thermometers basically consist of the following components:

- lens
- spectral filter
- detector
- electronics (amplifier/ linearization/ signal processing)

The specifications of the lens decisively determine the optical path of the infrared thermometer, which is characterized by the ratio Distance-to-Spot-size.

The spectral filter selects the wavelength range, which is relevant for the temperature measurement. The detector in cooperation with the processing electronics transforms the emitted infrared radiation into electrical signals.

Emissivity

Definition

The intensity of infrared radiation, which is emitted by each body, depends on the temperature as well as on the radiation features of the surface material of the measuring object. The emissivity (ϵ – Epsilon) is used as a material constant factor to describe the ability of the body to emit infrared energy. It can range between 0 and 100 %. A “blackbody” is the ideal radiation source with an emissivity of 1,0 whereas a mirror shows an emissivity of 0,1.

If the emissivity chosen is too high, the infrared thermometer may display a temperature value which is much lower than the real temperature – assuming the measuring object is warmer than its surroundings. A low emissivity (reflective surfaces) carries the risk of inaccurate measuring results by interfering infrared radiation emitted by background objects (flames, heating systems, chamottes). To minimize measuring errors in such cases, the handling should be performed very carefully and the unit should be protected against reflecting radiation sources.

Determination of unknown Emissivities

- ▶ First, determine the actual temperature of the measuring object with a thermocouple or contact sensor. Secondly, measure the temperature with the infrared thermometer and modify the emissivity until the displayed result corresponds to the actual temperature.
- ▶ If you monitor temperatures of up to 260 °C you may place a special plastic sticker onto the measuring object, which covers it completely. Now set the emissivity to 0,95 and take the temperature of the sticker. Afterwards, determine the temperature of the adjacent area on the measuring object and adjust the emissivity according to the value of the temperature of the sticker.

-
- Cove a part of the surface of the measuring object with black, flat paint with an emissivity of 0,98. Adjust the emissivity of your infrared thermometer to 0,98 and take the temperature of the colored surface. Afterwards, determine the temperature of a directly adjacent area and modify the emissivity until the measured value corresponds to the temperature of the colored surface.

Characteristic Emissivities

In case none of the methods mentioned above help to determine the emissivity you may use the emissivity tables (Appendix A and B). These are average values, only. The actual emissivity of a material depends on the following factors:

- temperature
- measuring angle
- geometry of the surface
- thickness of the material
- constitution of the surface (polished, oxidized, rough, sandblast)
- spectral range of the measurement
- transmissivity (e.g. with thin films)

Appendix A – Emissivity Table Metals

Material		typical Emissivity
Aluminium	non oxidized	0,02-0,1
	polished	0,02-0,1
	roughened	0,1-0,3
	oxidized	0,2-0,4
Brass	polished	0,01-0,05
	roughened	0,3
	oxidized	0,5
Copper	polished	0,03
	roughened	0,05-0,1
	oxidized	0,4-0,8
Chrome		0,02-0,2
Gold		0,01-0,1
Haynes	alloy	0,3-0,8
Inconel	electro polished	0,15
	sandblast	0,3-0,6
	oxidized	0,7-0,95
Iron	non oxidized	0,05-0,2
	rusted	0,5-0,7
	oxidized	0,5-0,9
	forged, blunt	0,9
Iron, casted	non oxidized	0,2
	oxidized	0,6-0,95
Lead	polished	0,05-0,1

Material		typical Emissivity
Lead	roughened	0,4
	oxidized	0,2-0,6
Magnesium		0,02-0,1
Mercury		0,05-0,15
Molybdenum	non oxidized	0,1
	oxidized	0,2-0,6
Monel (Ni-Cu)		0,1-0,14
Nickel	electrolytic	0,05-0,15
	oxidized	0,2-0,5
Platinum	black	0,9
Silver		0,02
Steel	polished plate	0,1
	rustless	0,1-0,8
	heavy plate	0,4-0,6
	cold-rolled	0,7-0,9
	oxidized	0,7-0,9
Tin	non oxidized	0,05
Titanium	polished	0,05-0,2
	oxidized	0,5-0,6
Wolfram	polished	0,03-0,1
Zinc	polished	0,02
	oxidized	0,1

Appendix B – Emissivity Table Non Metals

Material	typical Emissivity
Asbestos	0,95
Asphalt	0,95
Basalt	0,7
Carbon non oxidized graphite	0,8-0,9 0,7-0,8
Carborundum	0,9
Ceramic	0,95
Concrete	0,95
Glass	0,85
Grit	0,95
Gypsum	0,8-0,95
Ice	0,98
Limestone	0,98
Paint non alkaline	0,9-0,95
Paper any color	0,95
Plastic >50 µm non transparent	0,95
Rubber	0,95
Sand	0,9
Snow	0,9
Soil	0,9-0,98
Textiles	0,95
Water	0,93
Wood natural	0,9-0,95

Appendix C – Declaration of Conformity

EG-Konformitätserklärung EU Declaration of Conformity



Wir / We

Optris GmbH
Ferdinand Buisson Str. 14
D-13127 Berlin

erklären in alleiniger Verantwortung, dass
declare on our own responsibility that

die Produktserie optris LS
the product group optris LS

den Anforderungen der EMV-Richtlinie 2014/30/EU und der Niederspannungsrichtlinie 2014/35/EU
entspricht.
meets the provisions of the EMC Directive 2014/30/EU and the Low Voltage Directive 2014/35/EU.

Angewandte harmonisierte Normen:
Applied harmonized standards:

EMV Anforderungen / EMC General Requirements:
EN 61326-1:2013 (Grundlegende Prüfanforderungen / Basic requirements)
EN 61326-2-3:2013

Gerätesicherheit von Messgeräten / Safety of measurement devices:

EN 61010-1:2010
EN 60925-1:2015 (Lasersicherheit / Laser safety)

Dieses Produkt erfüllt die Vorschriften der Richtlinie 2011/65/EU (RoHS) des Europäischen
Parlaments und des Rates vom 8. Juni 2011 zur Beschränkung der Verwendung bestimmter
gefährlicher Stoffe in Elektro- und Elektronikgeräten.
This product is in conformity with Directive 2011/65/EU (RoHS) of the European Parliament and of
the Council of 8 June 2011 on the restriction of the use of certain hazardous substances in
electrical and electronic equipment.

Berlin, 04.11.2015

Ort, Datum / place, date

Dr. Ulrich Kienitz
Geschäftsführer / General Manager