



Operating instructions for the low pressure calibrator (LPX)



Table of contents

View	13
Notes on the operating instructions	14
1. Description of the device	14
2. General safety warnings	15
3. Operating the LPX calibrator	15
4. Description of the functions	15
5. Menu navigation for calibrators	16
6. Commissioning	16
7. Maintenance / disposal	17
8. Software for calibrators	18
Technical data	19
Spare parts and accessories for KELLER pressure calibrators	20
Declaration of conformity	31

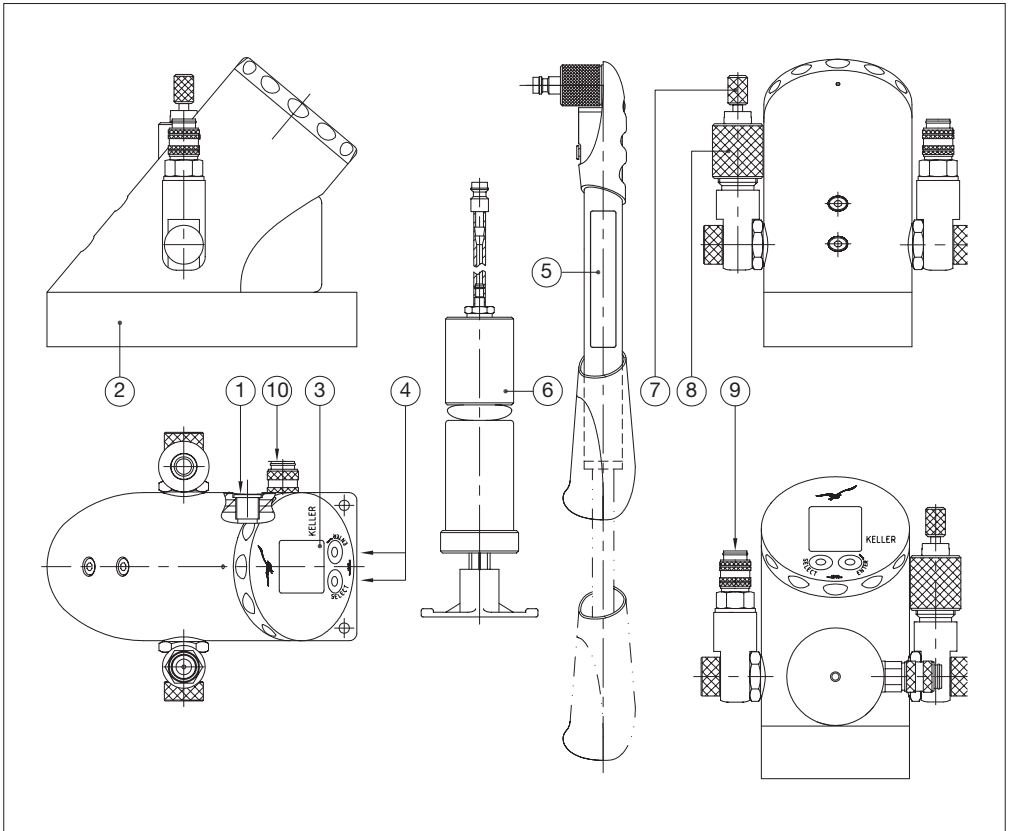

- 1 Port for interface cable (K-104A or K-114A)
(PC connection / RS485)
- 2 Device base
- 3 Display
- 4 SELECT and ENTER buttons
- 5 Hand pump
- 6 Vacuum pump
- 7 Pressure relief valve
- 8 Fine-tuning valve
- 9 Pressure connection for test object
(Serto coupler / connection nipple, G 1/4")
- 10 Connection for hand and vacuum pumps
(up to -850 mbar)

Notes on the operating instructions

- The operating instructions are intended for specialist workers and trained personnel.
- Before each stage of work, read the relevant notes and warnings carefully, and keep to the sequence as stated.
- Pay particular attention to the section on "General safety warnings".

If you have any problems or questions, please contact your supplier or consult KELLER directly.

1. Description of the device

General description

By means of the pressure pumps supplied with the product, the low-pressure calibrator enables the generation of pressures of -0,85 bar relative (with the vacuum pump) to +10 bar relative (with the hand pump). The measurement technology incorporated into this device allows accurate measurement and documentation of the characteristic of a test object that is connected to it. The measured pressure progression can be displayed, evaluated and saved with a computer monitoring program (CCS30).

The calibrator is operated with the two function buttons SELECT and ENTER, located directly below the display. The calibrator itself is powered by a 3,0 V battery, but power can also be supplied externally via the K-114A interface converter. Test objects (transmitters or pressure switches) must be supplied from an external source.

Pressure range for the display

The low pressure calibrator has a factory-set pressure zero point of 0 bar absolute (vacuum). The Zero function allows any desired pressure value to be set as the new zero point reference.

To take relative measurements, the low pressure calibrator is zeroed at ambient pressure (*SET ZERO*). To reset the pressure zero point to absolute pressure, use the *RES ZERO* function (reset zero).

Commissioning

A pressure-resistant connection for the test object is required in order to use the low pressure calibrator. The pressure connection for the test object is already screwed to the pressure distributor of the low pressure calibrator so that it is pressure resistant when it leaves the factory, and it must not be dismantled.

Recommended torque for the test object pressure connection: 10 Nm

IMPORTANT!

Nothing must adhere to the surface of the test object (no oil, grease, water, etc). Impurities could pass through the adapter to reach the low pressure calibrator and damage it.

Overpressure

If the pressure exceeds the measuring range by more than 20%, the measuring cell or the mechanism of the low pressure calibrator may be destroyed.

Recalibration

The recalibration cycle depends on the conditions of use. Recommended recalibration cycle: 1 year.

Scope of delivery

- 1 calibrator
- 1 hand pump
- 1 carrying case
- 1 vacuum pump
- 1 hose nipple
- 1 connection nipple, G 1/4"
- 2 sealing rings (G 1/8" + G 1/4")
- 1 CrNi filter
- 1 spare battery, type CR2430 (3,0 V)
- 1 set of operating instructions
- 1 test record (5 points)
- USB interface converter, K-114A
- 1 KELLER software CD

Intended use

The low pressure calibrator (LPX) may only be used to generate positive or negative pressure with air. Use of the calibrator with other media, especially hydraulic oil, will damage it. The operational safety of the device supplied is guaranteed only if it is used as intended. The limit values as stated (see page 19: "Technical data") must never be exceeded.

Before installing the low pressure calibrator, check that it is suitable for your applications.



2. General safety warnings

The current national regulations on accident prevention and workplace safety must be followed whenever work is carried out. Internal regulations issued by the operator must be followed, even if they are not mentioned in these instructions.

Never use the low pressure calibrator together with an external pressure source.

Do not remove any connected components (e.g. test objects) when the low pressure calibrator is under pressure. Open the pressure relief valve before removing one of the parts.

Only use the adapters and seals that are available as accessories.

Do not store the calibrator under pressure: only store the low pressure calibrator with the pressure relief valve open.

Avoid the action of force of any kind on the low pressure calibrator and its operating controls.

Do not use low pressure calibrators if they are damaged or faulty.

3. Operating the LPX calibrator

Operating the pressure calibrator is described starting on page 16.

Connect the test object

You can connect your test object to the low pressure calibrator via the pressure connection (9).

Zeroing the device

Engage the hand pump (5) in the connection port (10). Open the pressure relief valve (until the red mark is visible at most) to release any pressure that may be present. If the pressure display does not show zero, perform a zeroing procedure (*SET ZERO*). Then close the pressure relief valve.

Pressure generation

You can use the hand pump (5) to make an approximate setting for the desired pressure.

Generating negative pressure (vacuum)

Engage the vacuum pump (6) in the connection port (10) and lower the pressure. You can then fine-tune the pressure by screwing the fine-tuning valve (8) in or out.

Release pressure

Open the relief valve (7) to reduce the pressure to an approximate level, or to vent the low pressure calibrator.

Information about the display

If no pressure can be shown on the display, it will show *DFL* (overflow) or *UFL* (underflow).

If pressure outside the device's measuring range is applied, the last valid pressure value that was measured will flash on the display (overload warning).

Display



4. Description of the functions

Menu navigation

If the selected function or unit is not activated by pressing the ENTER button within 5 seconds, the display will return to measuring mode without changing a setting.

Function	Display	Description
Min. / max. display		Shows the peak and trough pressure values measured thus far. (Display is shown with reduced resolution)
Leak measurement		Leak mode is used to determine the pressure change over a defined period, which can be changed. (Leak measurement period, factory setting: 10 minutes)
Zero the display		Permanently sets the applied pressure as the new pressure zero point.
Reset display		Resets the pressure zero point to the factory setting. (Zero point for vacuum → absolute pressure is displayed)
Automatic switch-off function		(Cont = Continuous) The device switches off automatically after a defined period (which can be changed), starting from the last time a button was pressed. (Switch-off period, factory setting: 15 minutes)
Select units		mbar, bar, hPa, kPa, MPa, cmH2O, mH2O, inH2O, ftH2O, PSI, kp/cm², mmHg, inHg

SELECT button

The SELECT button positioned on the front is used to switch the device on, to select a function and to select the various pressure units.



ENTER button

The ENTER button positioned on the front is used to activate the selected

5. Menu navigation for calibrators

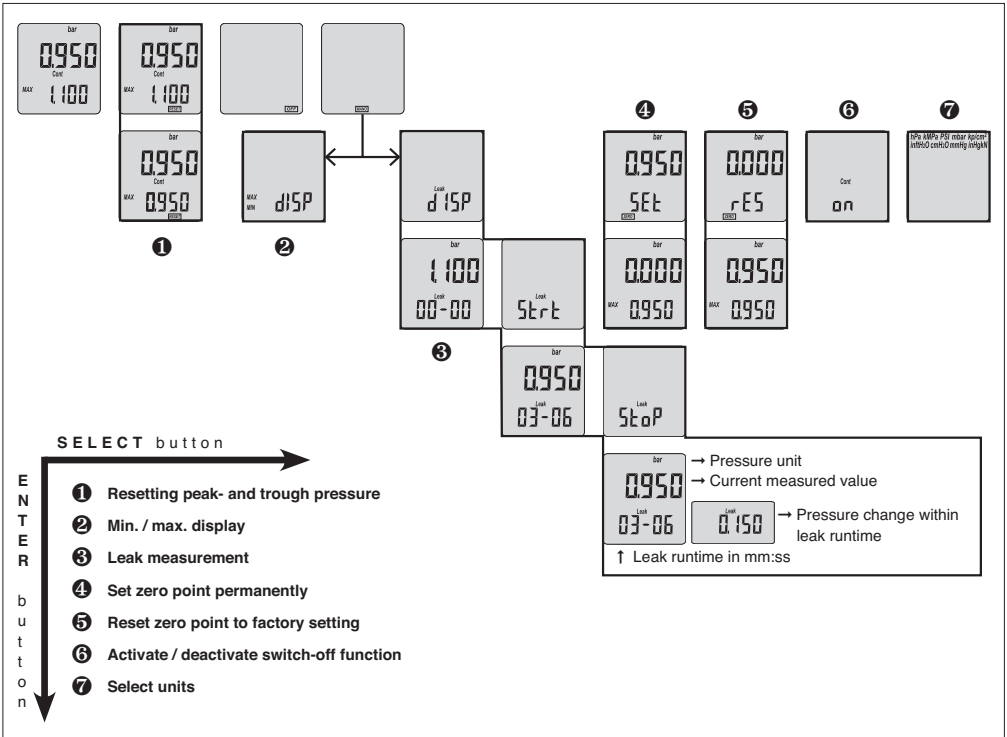

6. Commissioning

Switch the device on

Press the SELECT button to switch the device on. Initially, the device shows the pressure range calibrated in the factory (top) and the software version (year / week).

Switch the device off

Keep the SELECT button pressed down until the display shows *OFF*.

Press the ENTER button to execute the shutdown.

→ The settings made previously are retained when you switch the device on and off.

Display mode

Display mode is the calibrator's basic mode. The upper part of the display shows the pressure unit and the pressure that is currently measured. The lower part of the display shows the last

function that was used, either the Min./max. display or the Leak function.

Using the functions

Written descriptions of the individual functions are given below (in addition to the diagram above).

Selecting functions

The individual sub-functions are called up from the MANO menu. Keep the SELECT button pressed until *MANO* is

shown, and press ENTER to activate. You can now use SELECT to choose the function you want, and ENTER to execute the function. Depending on the current setting, the first function to be shown is either *MIN/MAX DISP* or *LEAK DISP*.

Leak measurement function

Leak mode is used to determine the pressure change over a defined period, which can be adjusted. The unit to be tested must be connected to the low pressure calibrator on the pressure side.

Start leak measurement

Activate the *MANO* menu. The display shows *LEAK DISP*. Press the ENTER button and then the SELECT button. Press ENTER to confirm *LEAK START*. The leak measurement starts, and the display alternates between the current leak time and the pressure change measured thus far.

Active leak measurement

During leak measurement, the lower part of the display alternates each second between the measurement time that has now elapsed [mm:ss] and the pressure change measured thus far.

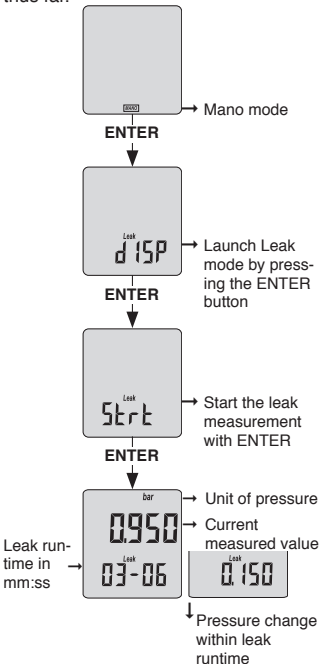

End leak measurement early

To end an active leak measurement early, press the ENTER button and confirm the "*LEAK STOP*" display by pressing ENTER.

Leak measurement completed

If the leak measurement time has elapsed or if the measurement was manually ended ahead of time, the display alternates between the elapsed leak measurement time and the measured pressure change.

Set leak measurement time

The leak measurement time is preset to 10 minutes in the factory, and it can only be changed with the "Mano Config" software. (→ Software for calibrators)

MANO / "Continuous" function

Automatic switch-off function (the device switches off automatically 15 minutes after a button was last pressed). Leak measurements are canceled by the automatic switch-off function if the measurement time is more than the switch-off time.

CONT ON: Disables the automatic switch-off function

CONT OFF: Enables the automatic switch-off function

If the "Continuous" function is enabled, *CONT* flashes on the display.

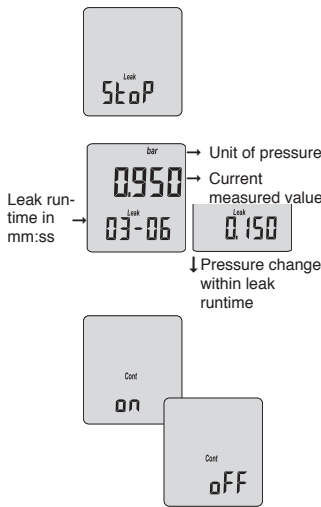

7. Maintenance / disposal

Battery

The pressure calibrator is powered by a 3 V button-cell battery (behind the display). If the battery is low, the battery symbol on the display, *BAT LOW* lights up.

Replacing the battery

Please switch the device off. Turn the display section ring beyond the limit stop until it is released from the housing section (turn through about 180°). Open the battery compartment and change the battery (type CR 2430).



Pressure coupling filter

The low pressure calibrator has a CrNi filter, 11 x 8 (material DIN 1.4404), fitted behind the pressure coupling in order to prevent impurities from penetrating inside it, which could cause leaks.

If the filter is dirty and pressure can no longer be transmitted, replace it with the spare filter that is included in the scope of delivery.

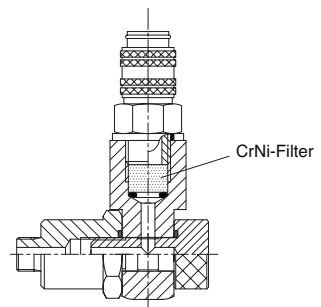

Disposal

This product must not be disposed of as normal household waste at the end of its useful lifetime. To prevent possible damage to the environment or to health due to uncontrolled waste disposal, this product must be separated from other waste and recycled correctly in order to ensure sustainable use of the raw materials.



8. Software for calibrators

The USB interface converter (K-114A) enables communication between the calibrator and a computer. Before you connect the interface converter to the computer, install driver K-104 / K-114 (the software CD is included in the scope of delivery, K-114A, or can be downloaded free of charge at www.keller-druck.com)

Settings on the low pressure calibrator with the ManoConfig software

Device settings such as the leak measurement time or the switch-off time for the low pressure calibrator can be adjusted using the "ManoConfig" software.

Record measurements with the CCS30 software

The CCS30 software records the data measured by the pressure calibrator, and shows them in both graphic and tabular form. Measured data can be saved or exported for further processing. You will find more information about the software in the CCS30 manual.

Step-by-step software installation

Install from the CD or from www.keller-druck.com:

- 1.) K-104 / K-114 driver
- 2.) (CCS30) Control Center Series 30
- 3.) ManoConfig (if desired)

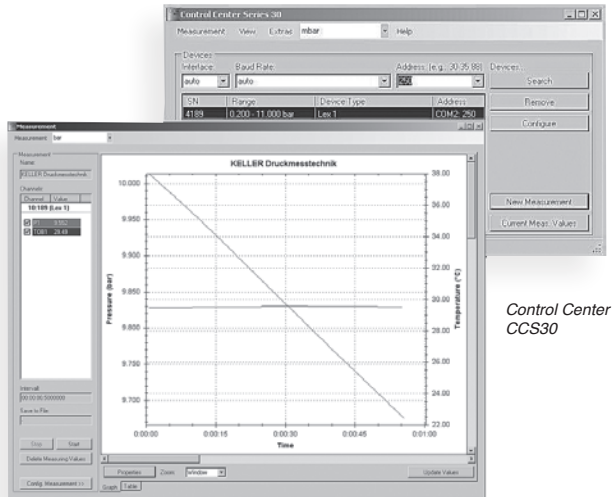

Control Center
CCS30

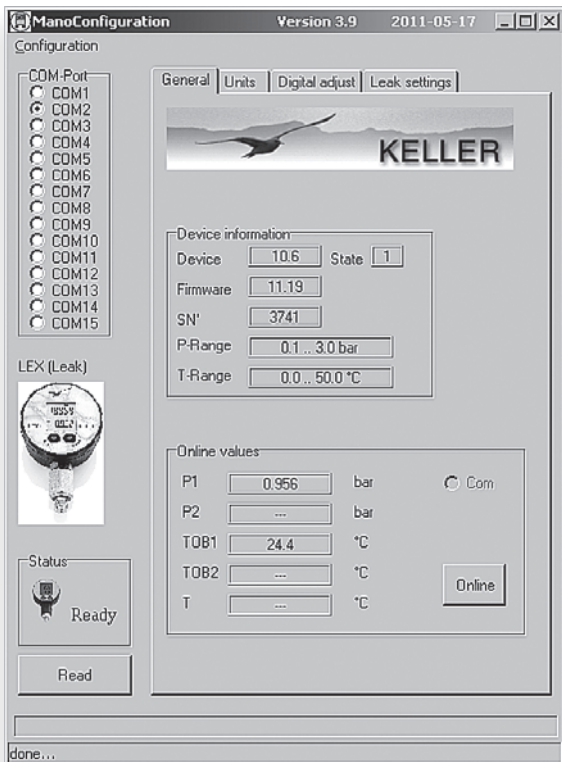















ManoConfig

Technical data

Pressure range	-0,85...10 bar (others on request)
Overpressure	12 bar
Accuracy, error band ⁽¹⁾ (10...40 °C)	< 0,05 %FS
Accuracy, error band ⁽¹⁾ (0...50 °C)	< 0,1 %FS
Leak rate	10 bar: -50 mbar @ 10 min.
Display resolution	1 mbar
Number of digits on display	5 digits
Measurement interval	0,5 seconds
Interface	RS485; the Fischer cable socket on the side fits the K-104A / K-114A interface converter
Compensated temperature range	0...50 °C
Operating temperature	0...50 °C
Storage temperature	-10...60 °C
Air humidity	5...95% relative humidity
Power supply	Button-cell battery, type CR2430
Battery lifetime:	> 2000 h in continuous operation
Dimensions (L x W x H)	159 x 138 x 148 mm
Degree of protection	IP 65
Selectable pressure units	bar, mbar, hPa, kPa, MPa, PSI, kp/cm ² , cmH ₂ O, mH ₂ O, inH ₂ O, ftH ₂ O, mmHg, inHg

⁽¹⁾ including accuracy, temperature coefficients, zero point and range tolerance

Spare parts and accessories for KELLER pressure calibrators

Description	Article number	suitable for			Illustration
		LPX	MPX	HPX	
Carrying case, empty	309025.0005	x	x	x	
Battery, type CR2430	557005.0001	x	x	x	
Hose nipple	508832.0005	x	x		
Connecting nipple, G 1/4" including sealing ring	508832.0004	x	x		
Y-coupler	307025.0001		x		
Test object adapter, G 1/4" M-G 3/8" F	506810.0028			x	
Test object adapter, G 1/4" M-G 1/2" F	506810.0013			x	
Sealing ring, G 1/8"	508635.0001	x	x		
Sealing ring, G 1/4"	508635.0002	x	x		
CrNi filter	307025.2011	x	x		
Vacuum pump	309005.0005	x	x		
Hand pump	309005.0004	x			
Fine-tuning valve	309030.0006	x	x		
Bottle of oil, 0,5 l (HLP 22 BP hydraulic oil)	650505.0005			x	
K-114A	309010.0075	x	x	x	

Für das folgenden Erzeugnis...

**Niederdruckkalibrator
LPX**

...wird hiermit bestätigt, dass es den wesentlichen Schutzanforderungen entspricht, die in der Richtlinie des Rates zur Angleichung der Rechtsvorschriften der Mitgliedstaaten über die elektromagnetische Verträglichkeit (2004/108/EG) festgelegt sind.

Diese Erklärung gilt für Produkte dieser Serie, die mit dem CE-Zeichen versehen und die Bestandteil dieser Erklärung sind.

Zur Beurteilung der Erzeugnisse hinsichtlich elektromagnetischer Verträglichkeit wurden folgende Normen herangezogen.

Herewith we declare that the following product or product range

**Low pressure calibrator
LPX**

meet the basic requirements for the electromagnetic compatibility, which are established in the directive of the European Community (2004/108/EC).

This declaration is valid for products of this Series marked with the CE sign and which are part of this declaration.

As criteria for the electromagnetic compatibility, the following norm is applied:

Nous attestons que le produit ou gamme de produits :

**Calibreur basse pression
LPX**

répondent aux exigences de base en matière de compatibilité électromagnétique prévues par la directive de la Communauté Européenne (2004/108/CE).

La présente déclaration est valable pour les produits de cette série, marqués avec le sigle CE et faisant partie intégrante de la présente déclaration.

La norme appliquée pour évaluer la compatibilité électromagnétique desdits instruments est la suivante :

EN 61326-2-3:2006

Diese Erklärung wird verantwortlich für den Hersteller:

This declaration is given for the manufacturer

La présente déclaration est fournie pour le fabricant

KELLER AG für Druckmesstechnik, St. Gallerstrasse 119, CH-8404 Winterthur

abgegeben durch die

in full responsibility by

par

KELLER GmbH, Schwarzwaldstrasse 17, D-79798 Jestetten

Jestetten, 4. Oktober | October | Octobre 2012



Hannes W. Keller
Geschäftsführender Inhaber | Managing Owner | Président Directeur Général
mit rechtsgültiger Unterschrift | with legally effective signature | dûment autorisé à signer



KELLER AG für Druckmesstechnik
St. Gallerstrasse 119 • CH-8404 Winterthur
Tel. +41 (0)52 235 25 25 • Fax +41 (0)52 235 25 00

www.keller-druck.com



November • November • Novembre 2012