



The LD-PRC process indicator and alarm controller is a technically advanced but cost effective instrument, designed specifically for use in process applications with 4–20mA or 0–10V DC inputs.

This controller has been designed for ease of use, with intuitive, scrolling text prompts that guide you step-by-step through the setup process. The front panel includes 5 buttons, for simple operator interface, and the large 4-digit display ensures that the figures can be easily read from a distance.

Order Codes

LD-PRC	Universal Process Controller
-HV	85–265V AC / 95–370V DC
-LV	15–48V AC / 10–72V DC

Options

-R2	2 x relay outputs
-R4	4 x relay outputs
-A	1 x mA/V analog output

Contents

1 - Specifications	2
2 - Front Panel & Display	3
3 - Wiring	6
4 - Dimensions & Installation	9
5 - Input Header Adjustment	11
6 - Input Setup & Calibration	13
7 - Setpoint Setup	18
8 - Setpoint Open Access	21
9 - Reset PIN Numbers / View Firmware Version	21

1

SPECIFICATIONS

Input

Input signal Current (0/4–20mA) or Voltage (0–2/10V)

Excitation 24V DC (50mA max)

Sampling rate 10Hz

Resolution 16-bit

Accuracy 0.05% of reading

Ambient drift Typically 50ppm/°C

Power

Power supply

HV: 85–265V AC/95–370V DC, or
LV: 15–48V AC/10–72V DC

Relay Output

OPTIONAL

Number of relay outputs None, 2, or 4

Relay output type 5A Form A (3A 240V AC max or 3A 30V DC max)

Analog Output

OPTIONAL

Number of analog outputs None or 1

Analog output type Isolated 16 bit
4–20mA/0–10V

Programming

Front panel buttons Up, Down, P (Prog/Enter), plus 2x Function Buttons for menu access

Calibration Factory set up for 4–20mA. Calibrated for 0/4–20mA and 0–2/10V. Simple header adjustment required for voltage input (see Section 5)

Security Input setup and setpoint functions have independent PIN code access

Display

Display type LED large display, 5 buttons

LED indicators 4 setpoint LED's

Digits 1 row of 4 digits, large 20mm (0.8") size, 7-segment LED

Construction

Casing Panel mount case, 5 buttons

Ingress protection rating IP65 dust/splash proof (face only)

Dimensions (H x W x D)
48 x 96 x 120mm (1.89 x 3.78 x 4.72")

Cutout area (H x W)
45 x 92mm (1.77 x 3.62")

2

FRONT PANEL & DISPLAY

2.1 - Front panel

SPX ■ The SP LED's are used to indicate active setpoints.

F1 This button is used to access the **Input Setup & Calibration** menu (Section 6).

P This button is used to save your settings and advance to the next step in the setup process.

↑ This button is typically used to scroll through options or increase values in the setup menu. Pressing this button from the main display allows you to view/reset the **PEAK** value (see 2.4).

↓ This button is typically used to scroll through options or decrease values in the setup menu. Pressing this button from the main display allows you to view/reset the **VALY** (valley) value (see 2.4).

F2 This button is used to access the **Setpoint Setup** menu (Section 7) and the **Setpoint Open Access** menu (Section 8).

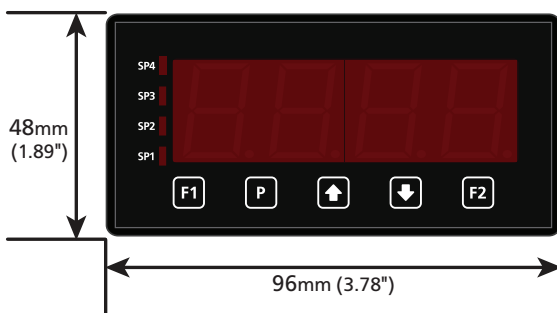































2.2 - Display brightness



To adjust the display brightness, press the **P** and **↑** buttons together from the main display. **BRI** appears and toggles with the current setting. Use the **↑** and **↓** buttons to adjust the LED backlight, and then press **P** to finish.



2.3 - 7 Segment display characters



The 4 digit, 7 segment display is designed for large size and great visibility of numeric characters in normal operating mode. When navigating the setup menus, this table is a useful reference for the mixed-case alphabetic characters.

A	B	C	D	E	F	G
						
H	I	J	K	L	M	
						
N	O	P	Q	R	S	T
						
U	V	W	X	Y	Z	
						
!	?	/				
						

2.4 - Up and down button shortcuts

Pressing the  and  buttons from the main operational display allows instant access to peak and valley values held in the controller's memory, as shown below.

 PEAK	Maximum measured process input since the unit was turned on or reset
 VALY	Minimum measured process input since the unit was turned on or reset

PEAK or **VALY** (valley) may be reset to zero by pressing the  and  buttons at **the same time** while the variable is being displayed. These values may also be reset using the function pins (see 3.5).

Press  at any time to return to normal operating mode.

3

WIRING

BEFORE YOU BEGIN WIRING, ensure that the power supply is disconnected.

3.1 - Pinouts

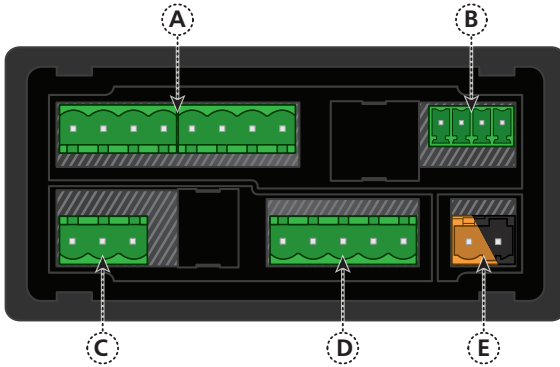

Key

3.1A Relay Output (See 3.3)

3.1B Analog Output (See 3.4)

3.1C Analog Input (See 3.2)

3.1D Function Pins (See 3.5)

3.1E Power Supply (See 3.6)

3.2 - Wire the analog input

See 3.1C

The analog input module has an input type header that is configured for 0/4–20mA input by default. **This will need to be adjusted for voltage input applications.**

Ideally you should do this before you continue wiring. Please see Section 5.

Then wire the analog input as required for your application, referring to the diagrams below.

2-wire Current/Voltage Input

External excitation used

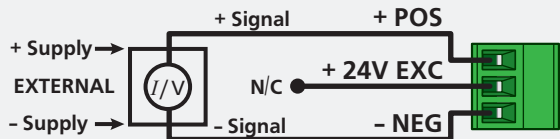

2-wire Current Input

Loop powered sensor

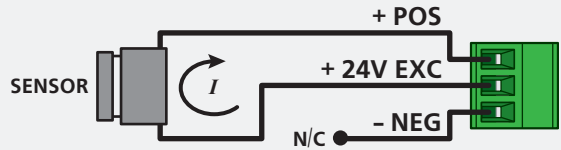

3-wire Current/Voltage Input

Controller supplied excitation

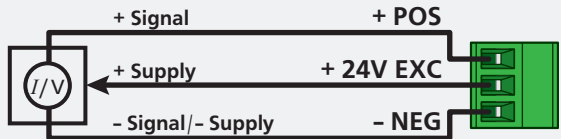

3.3 - Wire the relay outputs

See 3.1A

If your controller has relay outputs fitted, wire them as shown below. Relays can be programmed to operate within the total span range of the controller.

-R2

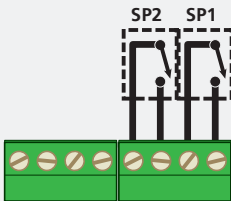

-R4

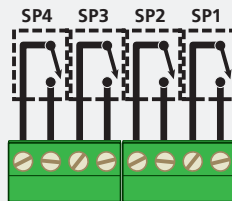

3.4 - Wire the analog output

See 3.1B

If your controller has analog output fitted, wire it as shown for either voltage (0–10V) or current (4–20mA).

-A

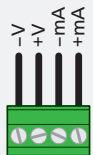

3.5 - Wire the function pins

See 3.1D

Connect external switches to enable a function to be executed when its switch is activated:

Valley	Clears the Valley value (also see 2.4)
Hold	Holds the current display value
Test	Resets the meter
Peak	Clears the Peak value (also see 2.4)

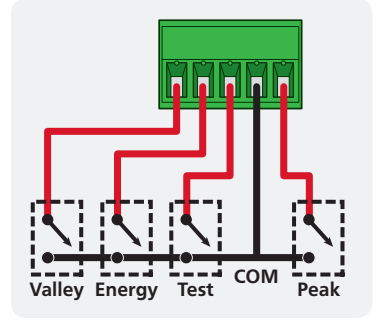

3.6 - Wire the power supply

See 3.1E

DO NOT attempt to wire your controller while the power is on. NEVER connect your low voltage controller to mains power.

Wire your controller for low or high voltage power supply, as show in the diagrams below. Check the label on the unit against the colour of the connector:

- › **Orange =**
High voltage (85–265V AC,
95–370V DC)
- › **Black =**
Low voltage (15–48V AC,
10–72V DC)

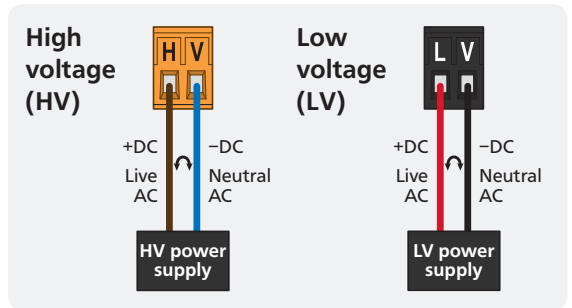

Once you have completed the wiring process it is safe to switch on your power supply. Ensure that your display is functioning before you proceed.

4

DIMENSIONS & INSTALLATION

4.1 - Case dimensions

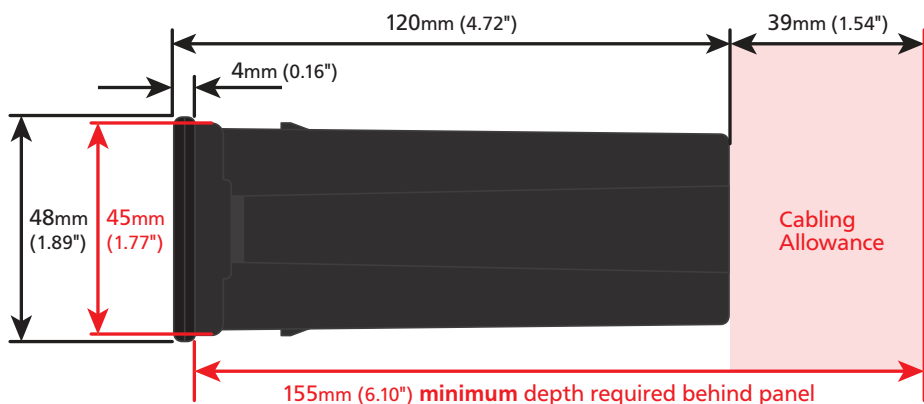
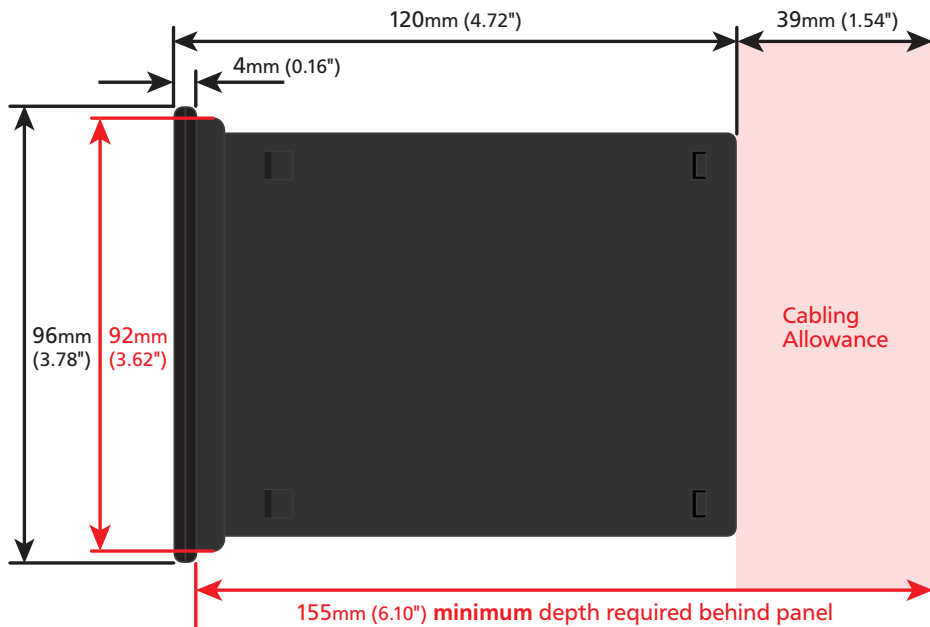

4.2 - Installation instructions

- A** Prepare the **Panel Cutout** to $92 \times 45\text{mm} \pm 0.5$ ($3.62 \times 1.77" \pm 0.02$), as shown below.
Allow at least 155mm (6.10") depth behind the panel to accommodate the meter body, protruding connectors and cabling.
- B** Remove the **Mounting Clips** from the meter back.

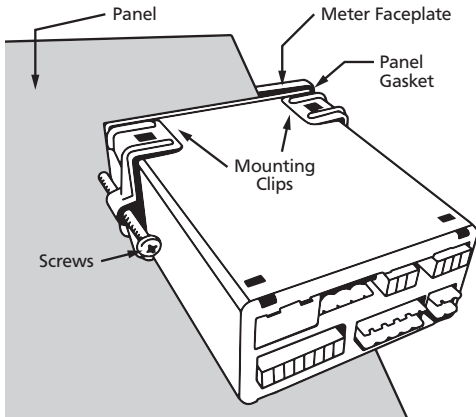

- C** Slide the **Panel Gasket** over the rear of the unit to the back of the **Meter Faceplate**.
- D** From the front of the panel, insert the meter into the **Panel Cutout**. Holding the unit in place, engage the **Mounting Clips** so that the tabs snap into place over the notches on the case.
- E** To achieve a proper seal, tighten the **Screws** evenly until the unit sits firmly against the panel. Do not over-tighten the screws.

Panel Cutout

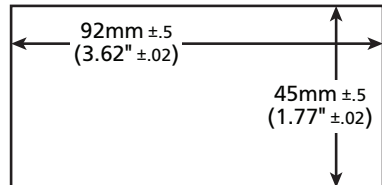

5

INPUT HEADER ADJUSTMENT

The analog input board for the LD-PRC has a header which can be set to 3 positions, depending on your input type and range, as per the table below:

Header Position	Used For
20mA	0–20mA and 4–20mA input ranges (default setting)
2V	0–2V input range
10V	0–10V input range

5.1 - Do I need to shift the input header?

In most cases the **input header does not need to be changed** from its default position of '20mA' (suitable for 0–20mA and 4–20mA inputs).

You **will** need to shift the input header if:

- › You are using the 0–2V or 0–10V input range, or
- › You are changing your input type or range from a previous setup

5.2 - How to shift the input header

A If the meter is already installed, remove it from the panel, and unplug all plugs from the back of the unit.

B Using a small screwdriver or similar implement, press downward into one of the slots at the rear of the case.

This will disengage the tab which holds the back plate on, allowing it to be gently levered away at one corner.

C Holding the loosened corner open with one hand, disengage the lever on the opposite slot.

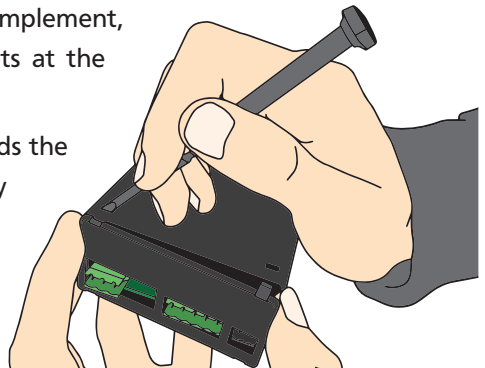

D You should now be able to remove the back plate. If it does not unclip easily, you may need to disengage the two remaining tabs by repeating steps 5.2B–C on the other side of the meter.

E Slide the analog input module out of the meter case. (See 3.1C to identify the input module.)

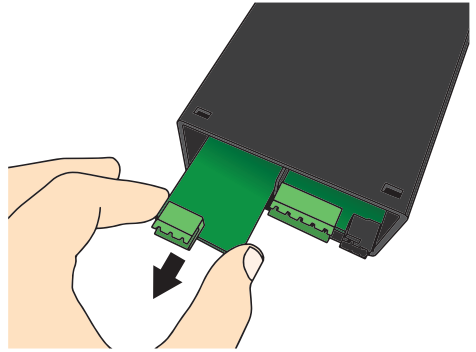

F Position the header on the input module as required for your input type and range:

- › **20mA** 0–20mA & 4–20mA
- › **Custom** Not used
- › **2V** 0–2V
- › **10V** 0–10V

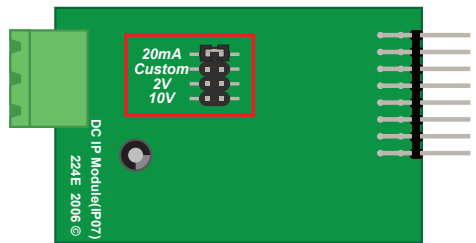

Note that you will also need to change the *Input Mode* in software from the front panel - see 6.2C.

G Slide the input module back into the meter case.

Make sure that it is sitting in the tracks on the left and right. Press firmly until the input module is fully inserted and sits flush with the other boards that are visible from the back of the meter.

H Replace the back plate.

Begin by inserting the two lower tabs into the slots, and then position the upper tabs so that they will not catch on the top lip of the meter case. Apply firm pressure until the back plate clicks into place.

I Reconnect the plugs and return the meter to the panel installation.

Don't forget that once the unit is connected and powered up, you will need to enter the **Input Setup** menu (6.2) and confirm that the correct *Input Mode* is also selected (see 6.2C).

6

INPUT SETUP & CALIBRATION

6.1 - Enter Cal PIN number

A Enter the calibration mode by pressing the **F1** button.

__ ENTER CAL PIN NUMBER scrolls across the display and toggles with **0**. Use the **▲** and **▼** buttons to enter your security code (factory default '1'). Then press **P**. If the correct PIN is entered, setup is started at 6.2.

If an incorrect PIN number is entered, **___ INCORRECT PIN NUMBER – ACCESS DENIED** scrolls across the display and it returns to normal operating mode.

You will have the opportunity to change your PIN number at the end of this section (6.6). If you have forgotten your PIN number, see Section 9.

6.2 - Input setup

A **__ INPUT SETUP** scrolls across the display and toggles with **SKIP**. Press **P** to skip to 6.3, or the **▲** button and then **P** to **ENTR** (enter) input setup.

B **__ MAINS FREQUENCY** scrolls across the display. Use the **▲** and **▼** buttons to select **50HZ** or **60HZ**, and then press **P**.

C **__ INPUT MODE** scrolls across the display and toggles with the current selection. Use the **▲** and **▼** buttons to select: **0-20** (0–20mA), **4-20** (4–20mA), **2V** (0–2V) or **10V** (0–10V). Then press **P**.

*Note that if you change the **INPUT MODE** in this step, then the input header on the analog input module may also need to be changed. See Section 5 for more information.*

D **__ DECIMAL POINT POSITION** scrolls across the display and toggles with the current selection. Use the **▲** and **▼** buttons to select **NODP** (no decimal point), **0.1**, **0.12**, or **0.123**, and then press **P** to accept and continue.

E **__ DISPLAY ROUNDING** scrolls across the display and toggles with the selected rounding. Using the **▲** and **▼** buttons, select: **NONE**, **2**, **5**, or **10**. Press **P**.

Rounding is quoted in display counts and is not influenced by decimal point position. For example, if your input signal is 5.3mA, the display will show: 5.3 (for rounding=NONE), 5.4 (for rounding=2), 5.5 (for rounding=5), or 5.0 (for rounding=10).

6.3 - Calibration

A **__ CALIBRATION TECHNIQUE** scrolls across the display and toggles with **SKIP**. Press **P** to skip to 6.4, or use the **▲** and **▼** buttons to select a calibration method: either **AUTO** or **MAN** (manual). Then press **P**.

- ➔ If you selected **AUTO**, complete steps 6.3B–D now.
- ➔ If you selected **MAN**, complete steps 6.3E–F now.
- ➔ If you selected **SKIP**, skip to 6.4 now.

***AUTO** (key-in) calibration uses zero and span values to calculate the scale and offset. This is the most accurate calibration method, but requires known low and high input signals (or the use of a calibrator).*

***MAN** The manual calibration procedure uses low and high display values, and is intended for a pre-calibrated sensor with a known output range. (For example 4mA=0 and 20mA=1000.) It does not require any input signals to be applied to the controller during calibration.*

Auto calibration

B **__ APPLY LOW INPUT SIGNAL – – – ENTER LOW DISPLAY VALUE** scrolls across and toggles with the current selection. Apply the required low input signal, and wait a moment for the signal to stabilise. Then, using the **▲** and **▼** buttons, enter your low display value, and press **P** to accept and continue.



C **__ APPLY HIGH INPUT SIGNAL – – – ENTER HIGH DISPLAY VALUE** scrolls across and toggles with the current selection. Apply the required high input signal, and wait a moment for the signal to stabilise. Then, using the **▲** and **▼** buttons, enter your high display value, and press **P**.

D If Auto calibration was successful, you will be directed out of the calibration menu to the operational display without viewing any further scrolling messages. (To proceed to step 6.4, you must select **SKIP** at 6.3A.)



If calibration fails, **__ CALIBRATION FAILED** will scroll across the display and you will be directed back to the operational display. The most likely cause of this

error is that the controller could not detect any change in input signal during calibration. Check your signal and connections, and repeat the procedure.

Manual calibration

- E** **__ ENTER DISPLAY VALUE FOR [LOW MA/V]** scrolls across the display, and toggles with the current low display value. Use the  and  buttons to adjust the display value for the low level input signal. Then press .

The text string for [LOW MA/V] is determined by your INPUT MODE (selected in 6.2C): 0MA (for 0–20mA), 4MA (for 4–20mA) or 0 VOLTS (for 0–2V/0–10V).

- F** **__ ENTER DISPLAY VALUE FOR [HIGH MA/V]** scrolls across the display, and toggles with the current high display value. Use the  and  buttons to adjust the display value for the high level input signal. Then press .

The text string for [HIGH MA/V] is determined by your INPUT MODE (selected in 6.2C): 20MA (for 0/4–20mA), 2 VOLTS (for 0–2V) or 10 VOLTS (for 0–10V).



Manual calibration is now complete. You will be directed back to the operational display. (To proceed to step 6.4, you must select **SKIP** at 6.3A.)

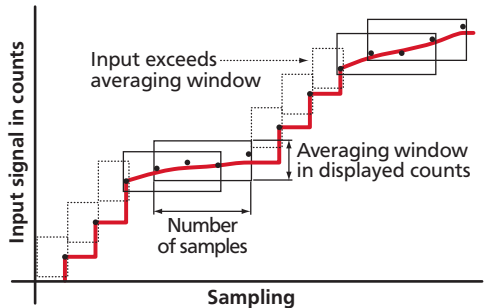

6.4 - Averaging

Your controller has input signal averaging, optimising stable measurement.

If the change in input exceeds the averaging window value it will not average, ensuring fast response when there are large differences between readings.



- A** **__ AVERAGING PARAMETERS** scrolls across and toggles with **SKIP**. Press  to skip to 6.5, or the  button and then  to **ENTR** (enter) averaging setup.

- B** **__ AVE SAMPLES** scrolls across the display and toggles with the currently selected averaging. Using the  and  buttons, alter the number of input

samples that the controller will average, and then press **P**.

Increasing the number of samples will stabilise measurement, but it will also slow down response rates. A typical value is 4.

- C** **__ AVE WINDOW** scrolls across the display and toggles with the currently selected averaging window value. Using the **▲** and **▼** buttons, alter the signal averaging window. Then press **P**.

*If your input signal contains large noise spikes, you can increase the size of the averaging window to ensure that these are still averaged. However, increasing the window size too far will reduce the ability of the controller to respond quickly to real changes in input signal. Setting **AVE WINDOW** to 0 will give continuous averaging as per the selected averaging samples. A typical value is 10% of your system capacity.*







6.5 - Analog output setup

*N.B. All new units are calibrated before shipping. Recalibration is **only** necessary if settings are wiped or the unit's accuracy requires verification after a long period of use. e.g. 1 year.*

- A** **__ ANALOG OUTPUT SETUP** scrolls across the display and toggles with **SKIP**. If your controller does not have analog output installed, (or you do not wish to configure your analog output now), press **P** to skip to 6.6. Otherwise, press the **▲** button and then **P** to **ENTR** (enter) analog output setup.
- B** **__ LOW SCALE VALUE FOR ANALOG OUTPUT** scrolls across the display and toggles with the currently selected low scale display value. Use the **▲** and **▼** buttons to enter your cal low position, and then press **P**.
- C** **__ HIGH SCALE VALUE FOR ANALOG OUTPUT** scrolls across the display and toggles with the currently selected high scale display value. Use the **▲** and **▼** buttons to enter your cal high position, and then press **P**.
- D** **__ CALIBRATE ANALOG OUTPUT?** scrolls across the display and toggles with **SKIP**. Press **P** now to skip analog output calibration and continue to 6.6, or the **▲** button and then **P** to **ENTR** (enter).







Factory analog output calibration is precisely set before shipping this instrument, and should not be adjusted unless advised by the manufacturer.

- ➔ If you selected **ENTR**, connect a mA or volt meter across the analog output connector (see 3.1B), and then continue to 6.5E.
- ➔ If you selected **SKIP**, go to 6.6 now.

- E** **_ _ CAL LOW ANALOG OUTPUT** scrolls across and toggles with a calibration number shown in internal units (around -16000). Press the  and  buttons until your multimeter displays your target low output (e.g. 4mA), then press .
- F** **_ _ CAL HIGH ANALOG OUTPUT** scrolls across and toggles with a calibration number shown in internal units (around 30000). Press the  and  buttons until your multimeter displays your target high output, then press .

Analog output calibration is now complete. The display will return to normal operating mode.

6.6 - Edit Cal PIN number

- A** **_ _ EDIT CAL PIN NUMBER** scrolls across the display and toggles with **SKIP**. Press  to skip and return to the operational display, or the  button and then  to **ENTR** (enter) and change your PIN number.
- B** **_ _ ENTER NEW CAL PIN NUMBER** scrolls across the display and toggles with the current PIN (default 1). Using the  and  buttons, enter your new Calibration PIN number. Then press  to exit to the operational display.

7

SETPOINT SETUP

The software in your controller will allow you to configure up to 4 setpoints, however full functionality is only supported when relay output hardware is installed.

(Setpoints with no corresponding relay output hardware may be used as simple LED indicators, if desired. In this case, features requiring relay output functionality will continue to appear in the setup menu, but will be ignored by the controller.)

7.1 - Enter Setpoint PIN number

- A** Enter setpoint setup mode by pressing and holding the **F2** button for 3 seconds. **__ ENTER SP PIN NUMBER** scrolls across the display and toggles with **0**. Use the **↑** and **↓** buttons to enter your security code (factory default '1'). Then press **P**. If the correct PIN is entered, setup is started at 7.2. If an incorrect PIN number is entered, **__ INCORRECT PIN NUMBER – ACCESS DENIED** scrolls across the display and it returns to normal operating mode.

You will have the opportunity to change your PIN number at the end of this section (7.3). If you have forgotten your PIN number, see Section 9.

7.2 - Setpoint setup

- A** **__ EDIT SETPOINT** scrolls across the display and toggles with **SKIP**. Press **P** now to skip to 7.3, or use the **↑** and **↓** buttons to select a setpoint to edit, and then press **P**.
- B** **__ SP VALUE** scrolls across the display and toggles with the current value for the selected setpoint. Using the **↑** and **↓** buttons, adjust the display value at which the selected setpoint will activate, and then press **P**.
- C** **__ SP ACTIVATION** scrolls across the display and toggles with the current activation for the selected setpoint. Using the **↑** and **↓** buttons, select the relay

activation to operate **ABVE** (above) or **BLW** (below) the setpoint value, and then press **P**.

ABVE: Relay turns on above the setpoint value and off below it.

BLW: Relay turns on below the setpoint value and off above it.

- D** **__ HYSTERESIS TYPE** scrolls across the display and toggles with the current setting for the selected setpoint. Using the **↑** and **↓** buttons, select either **ALM** (alarm) or **CTRL** (control), and then press **P**.

ALM - SETPOINT VALUE controls setpoint activation point. **HYSTERESIS VALUE** controls setpoint deactivation point.

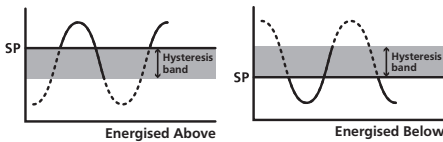

CTRL - SETPOINT VALUE controls setpoint deactivation point. **HYSTERESIS VALUE** controls setpoint reactivation point.

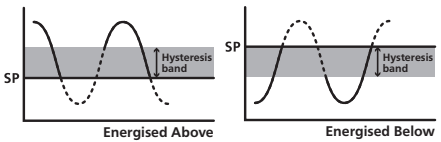

- E** **__ HYSTERESIS VALUE** scrolls across the display and toggles with the hysteresis value for the selected setpoint. Use the **↑** and **↓** buttons to adjust this value if required, and then press **P**.

*The **HYSTERESIS VALUE** defines the separation band between setpoint activation and deactivation, and will operate as per the **HYSTERESIS TYPE** setting selected in 7.2D.*





- F** **__ MAKE DELAY** scrolls across the display and toggles with the current make delay time for the selected setpoint. This is the time delay between setpoint activation, and when the relay turns on. Adjust this value in 0.1 second increments using the **↑** and **↓** buttons, and then press **P**.

- G** **__ OPEN ACCESS TO SP VALUE** scrolls across the display and toggles with the open access permission setting for the selected setpoint. Use the **↑** and **↓** to select either **YES** or **NO**, and then press **P**.







*When enabled, this option allows the selected setpoint's value to be edited directly after pressing the **F2** button, without needing to enter a PIN number or go through all of the other options. Each setpoint can individually have this option enabled or disabled. See Section 8.*

- H** The step that you proceed to now will depend on which setpoint you are editing (selected in 7.2A):

- ➔ If you are currently editing **SP 1**, skip to 7.2J now.
- ➔ If you are currently editing **SP 2–4**, continue to 7.2I now.

- I **__ TRAIL SP1** scrolls across the display and toggles with the trailing setting for the selected setpoint. A setpoint with **TRAIL SP1** enabled will trail the *SP Value* of **SP 1**. (The setpoint value of the trailing setpoint will effectively become an offset value.)
Using the  and  buttons, turn trailing **OFF** or **ON**, and then press .
- J **__ EDIT SETPOINT** scrolls across the display and toggles with **SKIP**. You are now back at 7.2A. To edit another setpoint, follow the instructions from 7.2A–J again. If you do not wish to edit another setpoint, press  now to skip to 7.3.

7.3 - Edit SP PIN number

- A **__ EDIT SP PIN NUMBER** scrolls across the display and toggles with **SKIP**. Press  to skip and return to the operational display, or the  button and then  to **ENTR** (enter) and change your PIN number.
- B **__ ENTER NEW SP PIN NUMBER** scrolls across the display and toggles with the current PIN (default 1). Using the  and  buttons, enter your new SP PIN number. Then press  to exit to the operational display.

8

SETPOINT OPEN ACCESS

If none of the setpoints have their open access option enabled then this feature will be disabled and the **F2** button will not respond to a short button press. (See 7.2G.)

- A Begin by pressing the **F2** button for less than 3 seconds.
- B The name of the first access-enabled setpoint will appear on the display and toggle with the current value for that setpoint. Using the **↑** and **↓** buttons, adjust the selected value. Then press **P** to accept and continue.
- C The name of the next access-enabled setpoint will appear on the display, along with its setpoint value. Repeat step 8B. The open access menu will proceed through all access-enabled setpoints in this fashion. Pressing **P** for the last enabled setpoint will exit and return to the operational display.

9

RESET PIN NUMBERS / VIEW FIRMWARE VERSION

If you have forgotten your PIN number(s), follow the procedure below to reset both the Calibration and Setpoint PINs to their factory default of 1.

This procedure will also allow you to view the current software installed on your device, which may be required for support purposes.

- A Press **↑**, **↓** and **P** at the same time. (This key combination can be difficult to execute and you may need several tries to get it right.)
- B A message will appear on the display, with details of the unit's current software configuration (Product name, Firmware Version, and Macro Version etc). At the end, you will see – **ALL PIN NUMBERS RESET TO 1**.
- C Both the Cal PIN number and the SP PIN number have now been reset to '1'. You can change this, if required, by following the instructions in 6.6 (for Cal) and 7.3 (for SP), using '1' to enter each menu initially.



Define Instruments

New Zealand (Head Office)

 10B Vega Place, Rosedale,
Auckland 0632, New Zealand
PO Box 245 Westpark Village,
Auckland 0661, New Zealand

Ph: +64 (9) 835 1550

Fax: +64 (9) 835 1250

 sales@defineinstruments.co.nz

www.defineinstruments.co.nz

United States (Dallas, TX)

Ph: (214) 926 4950

 sales@defineinstruments.com

www.defineinstruments.com
