



**KANOMAX**  
*The Ultimate Measurements*

# ANEMOMASTER<sup>®</sup>

## LITE

---

MODEL 6006

Handheld Anemometer

User's Manual

---

## Important Safety Information

---

The symbols for the warnings used in this manual are defined below.

### Classifications

---



**Danger: To Prevent Serious Injury or Death**

Warnings in this classification indicate danger that may result in serious injury or death if not observed.



**Caution: To Prevent Damage to the Product**

Warnings in this classification indicate risks of damage to the product that may void the product warranty if not observed.

### Description of Symbols

---



△ This symbol indicates a condition that requires caution (including danger). The subject of each caution is illustrated inside the triangle (e.g. the high temperature caution symbol is shown on the left).



⊘ This symbol indicates a prohibition. Do not take the prohibited action shown inside or near this symbol (e.g. the disassembly prohibition symbol is shown on the left).



● This symbol indicates a mandatory action. A specific action is given near the symbol.



## Danger

---



Forbidden

Never bring the probe close to a flammable gas atmosphere. The heated sensor may cause a fire or explosion.



Don't touch



Hot surface

Never touch the sensor.

The sensor is heated during operation. Touching the heated sensor may cause burns, and may also damage the sensor itself.



Use properly



Explosive

Do not disassemble or heat the batteries, or put them into a fire.

This may cause burns and the batteries may burst.



## Caution

---



Forbidden

Do not use the instrument in a water vapor atmosphere.

Condensed steam on the sensor will change the heat dissipation rate, resulting in inaccurate measurements. It may also cause damage to the sensor.



Forbidden

This instrument is designed to be used in an environment with a clean air stream without any dust or foreign materials.

Foreign materials may cause damage to the sensor. Also dust or foreign materials on the sensor will impede accurate measurements.



Forbidden

Do not apply force to the sensor.

If the sensor is deformed, the accuracy of the sensor may be affected.



Set up properly

When measuring, ensure that the direction mark is facing into the airflow.

Otherwise, the measurement may be inaccurate, as some sensors (uni-directional probes) have a specific directivity.



Forbidden

Do not use or leave the instrument in a high temperature, high humidity or dusty environment. Do not leave this instrument under direct sunlight for a prolonged period.

The instrument may not function properly out of the specified operating conditions.



Forbidden

**Do not subject the instrument or the probe to strong impacts.**  
Dropping the unit or placing heavy objects on it may cause damage or malfunction to the instrument.



Do not remodel/  
disassemble

**Never disassemble, modify or repair the product.**  
Failure to observe the above may cause short circuit and/or other failure that will affect the performance.



Forbidden

**Do not pick up or carry the instrument by the probe cable.**  
It may cause a malfunction or the wire may break.



Use properly

**Remove the batteries from the battery compartment when storing the instrument. Do not leave exhausted batteries in the battery compartment. When inserting batteries be sure to insert them with the polarity facing the correct direction.**  
Failure to do so may cause battery leakage.



Forbidden

**Do not wipe the instrument with a volatile solvent.**  
The body may deform or deteriorate. Use a soft dry cloth to remove stains. If stains persist, soak the cloth in a neutral detergent and wipe the instrument with the soft cloth. Never use volatile solvents such as thinner or benzene.



Forbidden



Electrified

**Discharge any built-up static electricity from your body before touching the instrument.**  
The built-up static electricity may influence the readings and cause damage to the circuit.



Forbidden



Use properly

**Regularly check the head of the probe for contamination. Impurities (such as dust) on the sensor may affect the accuracy of the measurements.**  
To get rid of dust, use a blow blush for cameras to blow it off, or you can rinse it with water and allow it to air-dry completely.  
\*Be sure to turn the power off before you clean it.  
\*Never dry the probe with heat. (Heat may cause permanent damage to the sensor.)



Forbidden

Do not move the main unit and the probe from a cold place to a warm place quickly. It will cause dew condensation.

Even when used in an environment within the specified operating temperature and humidity, a sudden temperature change may cause condensation. Condensation generated on the sensor may cause inaccurate measurements. Condensation on metal parts may cause rusting and lead to a malfunction.



Forbidden

Do not touch the LCD screen with a sharp-pointed object or with excessive pressure.

It may cause distortion of the screen or a malfunction. Also a rapid temperature change may cause a malfunction of the screen.



Set up properly

When storing the instrument, put the instrument in the carrying case and keep it in a place with an ambient temperature of -10 to 50°C and no condensation.



Forbidden

Do not dispose of the instrument as a household waste.

Please note that the disposal of the instrument and the batteries should be in line with your local or national legislation. For details, please contact your local distributor.

# Table of Contents

---

<b>§ 1</b>	<b>Part Names and Functions (Instrument) .....</b>	<b>6</b>
	Part Names and Functions (Main Body).....	6
	Part Names and Functions (Probe).....	7
<b>§ 2</b>	<b>Preparation for Measurement.....</b>	<b>7</b>
	Installing Batteries .....	7
	Battery Level Indicator .....	9
	Changing Units for the Readings.....	9
<b>§ 3</b>	<b>How to Measure.....</b>	<b>10</b>
<b>§ 4</b>	<b>Specifications .....</b>	<b>11</b>
<b>§ 5</b>	<b>Troubleshooting .....</b>	<b>12</b>
<b>§ 6</b>	<b>Compensation of Air Velocity Value .....</b>	<b>13</b>
<b>§ 7</b>	<b>Warranty and After Service .....</b>	<b>14</b>
	Kanomax Limited Warranty .....	14
<b>§ 8</b>	<b>Contact Information .....</b>	<b>16</b>

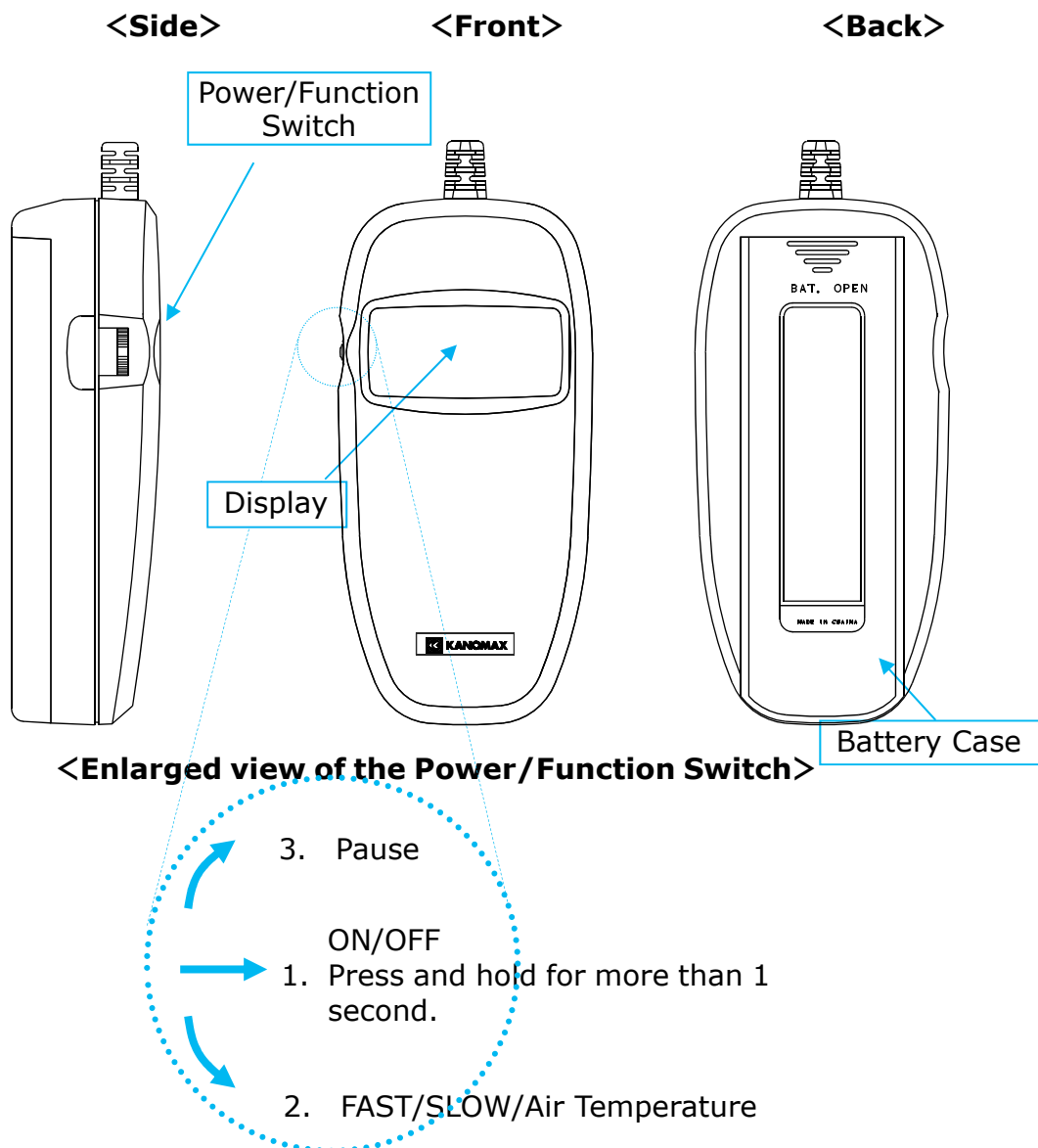

Power/Function Switch is a multifunction switch that can be slid up and down, and pressed.

1. Pressing will switch the power on and off. Press and hold the switch for more than 1 second until the LED indicates the change of the ON/OFF status.
2. Sliding the switch down will change the measurement mode in the following order: FAST → SLOW → Air Temperature → FAST →
3. Sliding the switch up will hold the display. Slide up, down or press the switch to continue.

---

## Part Names and Functions (Probe)

---

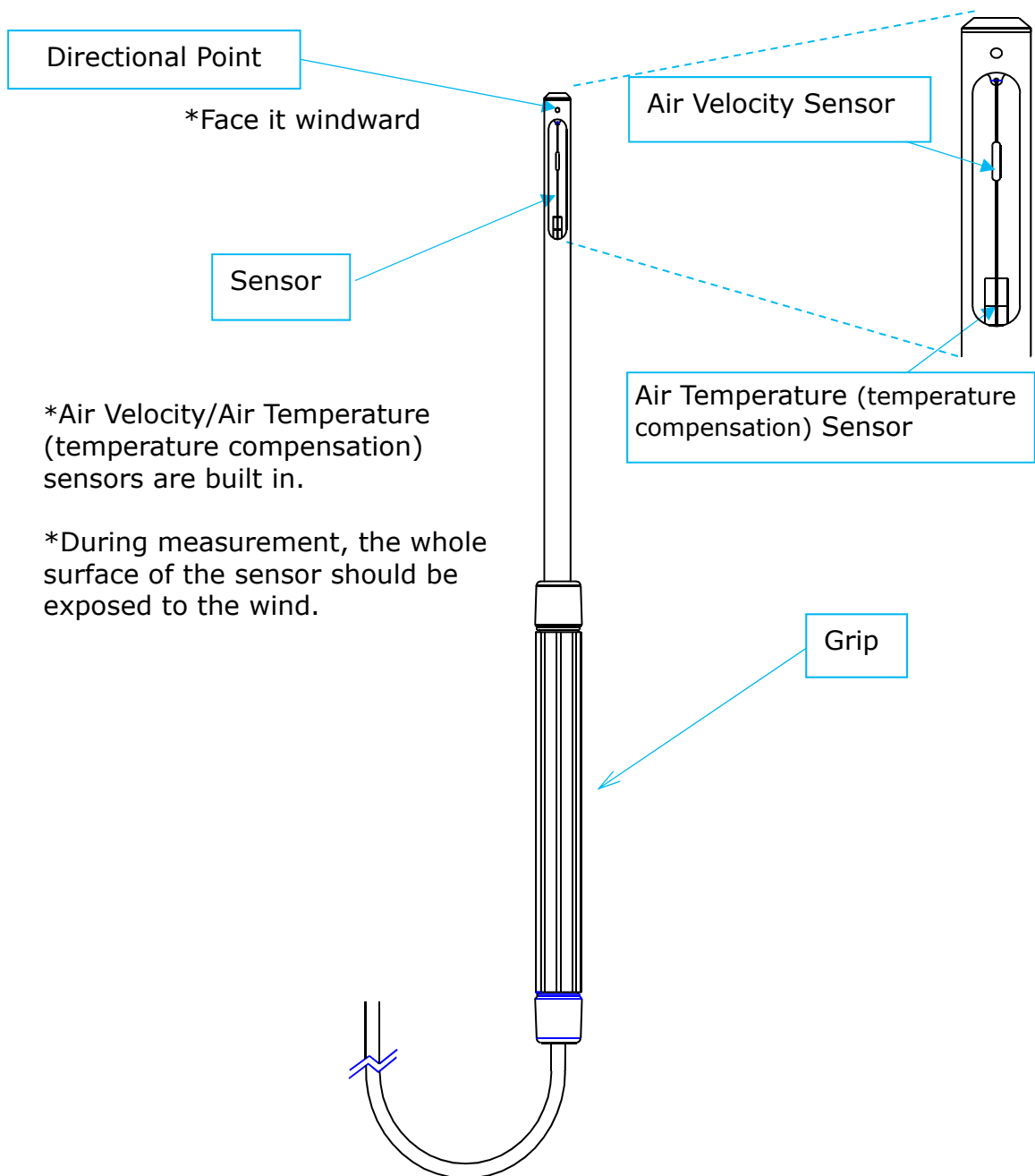

## § 2 Preparation for Measurement

---

### Installing Batteries

---

- Use four AA size batteries.
- Make sure that the power is off before inserting the batteries.
- If you are using charging batteries, charge them with a special



charger prior to use.

### <Back (Battery Case)>

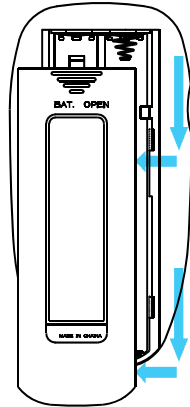

1. Slide the cover of the battery case down along the rail.
2. Slide the cover until it stops, and then lift it up.

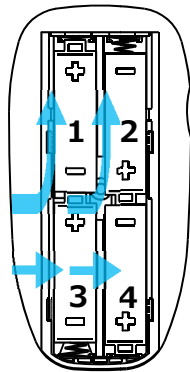

3. Insert the batteries in the order shown in the left figure, observing polarity.
4. Replace the battery cover by following the reversed procedures 1 and 2.

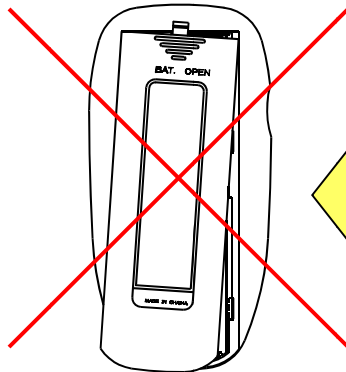

To put the battery cover back, do not first engage the detent at the top end. Follow the above-mentioned procedure backwards to slide the cover back. If you forcibly try to click the cover onto the body, it may be broken.

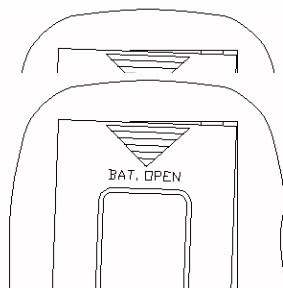

## Battery Level Indicator

Battery level is displayed as below depending on the charge left:

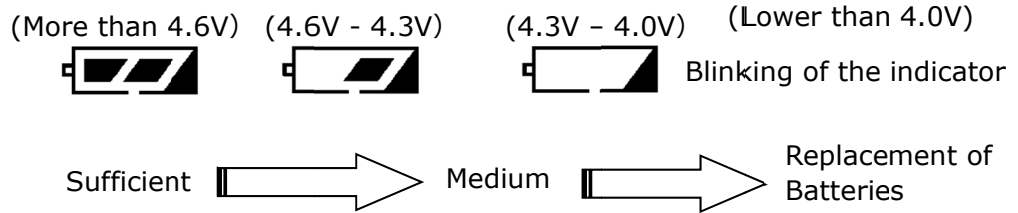

- Guaranteed operating voltage range of the battery is more than 4V.
- When battery voltage decreases to less than 4V, the display will go on and off and the power will be turned off automatically.
- When you are using a charging battery, recharge the battery a little early, before the 4.3V -4.0V mark is displayed.

## Changing Units for the Readings

- The units can be changed using the dip switch.
- You can find the dip switch in the battery box.

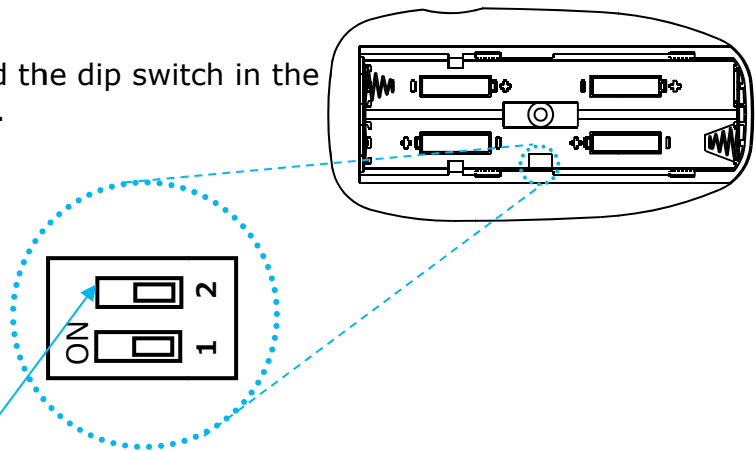

\*SW 2 is not used.

SW No.	1
Units	OFF (factory default)
m/s °C	OFF (factory default)
FPM °F	ON

- Procedure Flow Chart -

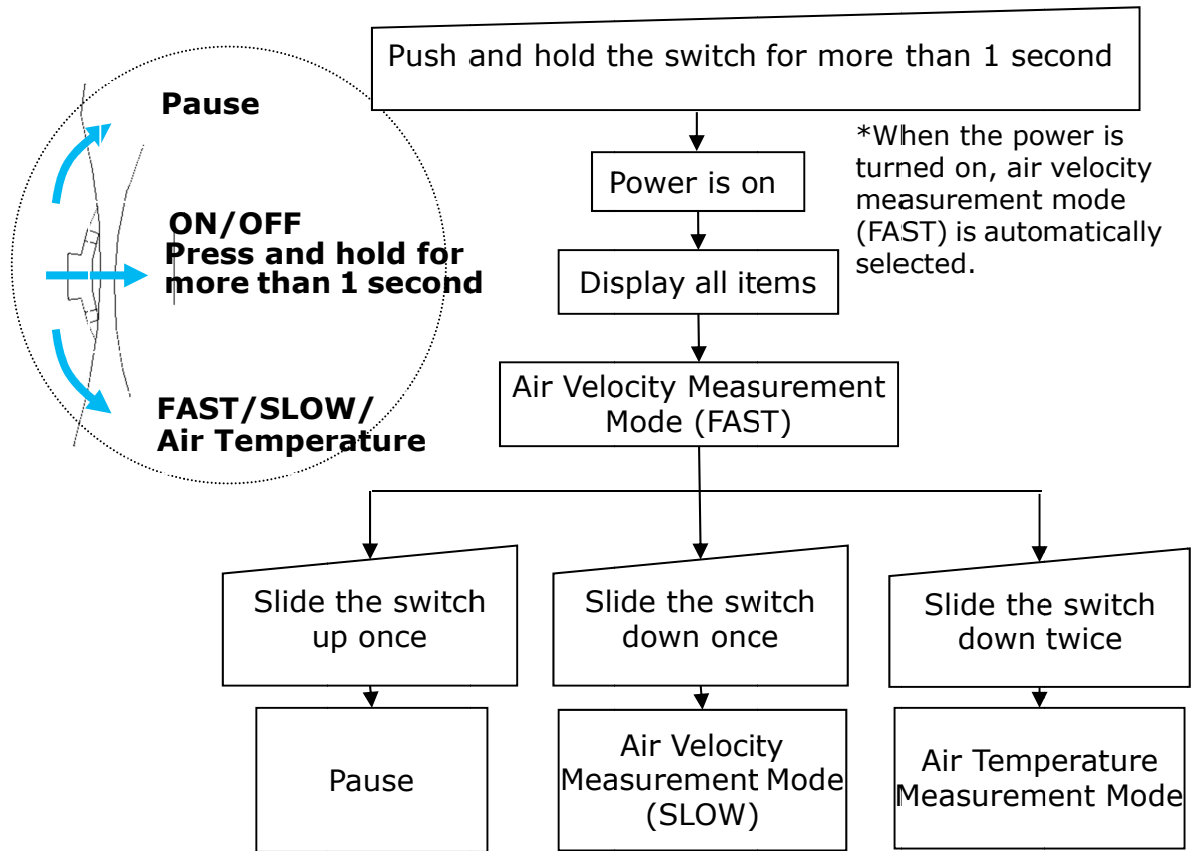

<Change the Time Constant (Air Vel. Measurement Mode)>

\*Time Constant determines the time span of the moving average. When you set the Time Constant to a larger (longer) value, the readings will become stable. When you select a smaller (shorter) value, the readings will become more responsive and sensitive to the change in air velocity.

- By sliding down the switch, you can change the Time Constant to 1 second (FAST) or to 5 seconds (SLOW).
- When the power is turned off, it will return to the initial setting of 1 second (FAST).
- When measurement values fluctuate significantly, setting to "SLOW" will make the reading easy.

<Measurement of Air temperature>

- Turn the power on and slide the switch down twice to enter Air Temperature Measurement Mode.
- Do not make a measurement immediately after the mode change. Especially, when no airflow is present (wind-speed of 0.1m/s or lower), wait for at least 30 seconds before taking a measurement.

## § 4 Specifications

MODEL		6006				
Items to Measure		Clean air of normal pressure/humidity				
Range	Air Velocity	0.01 m/s to 20.0 m/s (2 FPM to 3940 FPM)				
	Air Temperature	-20 °C to 70.0 °C (-4 °F to 158 °F)				
Accuracy	Air Velocity	±5% of reading or ±0.015 m/s (±3 FPM), whichever is greater				
	Air Temperature	±1.0 °C (±2.0 °F)				
Temperature compensation accuracy	Air Velocity	±5% of reading or ±0.015 m/s (±3 FPM), whichever is greater, (in the temperature range of 10 °C to 40 °C (50 °F to 104 °F))				
Display resolution	Air Velocity	0 m/s to 9.99 m/s : 0.01m/s (minimum) 10.0 m/s to 20.0 m/s : 0.1 m/s ( <table style="display: inline-table; vertical-align: middle;"> <tr> <td style="padding: 0 10px;">0 FPM to 1958 FPM :</td> <td style="padding: 0 10px;">2 FPM (minimum)</td> </tr> <tr> <td style="padding: 0 10px;">1960 FPM to 3940 FPM :</td> <td style="padding: 0 10px;">20 FPM</td> </tr> </table> )	0 FPM to 1958 FPM :	2 FPM (minimum)	1960 FPM to 3940 FPM :	20 FPM
	0 FPM to 1958 FPM :	2 FPM (minimum)				
1960 FPM to 3940 FPM :	20 FPM					
Air Temperature	0.1 °C (0.2°F)					
Response	Air Velocity	Less than one second (air velocity at 1 m/s (196 FPM) : 90% response)				
	Air Temperature	Less than 30 seconds (air velocity at 1 m/s (196 FPM) : 90% response)				
Function	(1) Battery Life Indicator (4 levels) (2) FAST / SLOW (1 second or 5 second moving average) (3) Change of units using dip switch (m/s and °C → FPM and °F) (4) Hold Display					
Dimensions	Probe : Approx. φ 6.1 (φ10.6) x 205 mm (φ 3.3 x approx. 1.5 m for cable) Main body : Approx.60(W) x 120 (L) X 34 (H) mm					
Power Source	Four AA batteries...or charging batteries (manganese batteries, alkali batteries, Ni-Cd, Ni-MH) (Please purchase a special charger if you use charging batteries)					
Battery Life	Approx. 4 hours (continuous measurement at 1 m/s air velocity using manganese batteries)					
Operating Environment	Main Body: 5 °C to 40 °C (41 °F to 104°F), with no visible condensation					
	Probe: -20.0 °C to 70 °C (-4 °F to 158°F), with no visible condensation					
Storage Temperature Range	-10 °C to 50 °C (14 °F to 122°F), with no visible condensation					
Weight	Approx. 180 g (including batteries)					
Standard Accessories	AA size batteries (for test purpose)..... 4 Operation manual (this volume) ..... 1 Carry case ..... 1 Extension rod (166mm to 909 mm) ..... 1					
Option	Spare probe					

\* Supplied batteries are for tests. If the batteries are weak, replace them with new ones for accurate measurement.

## § 5 Troubleshooting

Before asking for repair, check the items below.

### 1. Under normal conditions:

Problems	Possible Cause	Corrective Action
No power. (LCD remains unlit)	Dead batteries.	Replace them with new batteries.
	Wrong battery polarity.	Insert them correctly.
	Dirty contact point.	Clean the contact point of the battery.
"----" (OVER) is displayed.	Used beyond the measurement range.	Use it within the measurement range.
	Air velocity sensor is damaged.	Contact the dealer.
"E01" is displayed or "0.00" display remains unchanged.	Air velocity sensor is damaged.	Contact the dealer.
	Probe cable is damaged.	Contact the dealer.
"E02" is displayed.	Air temperature sensor is damaged.	Contact the dealer.
Display frozen.	Display is "paused".	Release "pause".
	Weak batteries.	Replace them with new batteries.
Display goes on and off.	Weak batteries.	Replace them with new batteries.
	Dirty contact point.	Clean the contact point of the battery.
Unit of the readings is different.	Unit setting has been changed.	Change the unit using the dip switch in the battery case.

### 2. When replacing the batteries:

Problem	Possible Cause	Corrective Action
No power.	Batteries were replaced while the power was on.	Remove all the batteries and insert them again.

Air temperature, humidity and pressure can influence accuracy of air velocity.

**<Influence of air temperature>**

ANEMOMASTER LITE is a hot-wire anemometer that uses heat radiation to measure wind speed, therefore, temperature compensation is needed to prevent the influence of ambient temperature. Without temperature compensation, air temperature will influence heat radiation and thus will change the readings even the actual air velocity is the same. The anemometer measures air temperature at the same time by an inner circuit called temperature compensation and automatically compensates readings of air velocity to prevent influence from air temperatures within a range of 10 °C to 40 °C.

**<Influence of humidity>**

As air velocity sensor is heated 40 °C to 50 °C above ambient temperature, it is usually not influenced by relative humidity.

**<Influence of atmospheric pressure>**

Change in pressure influences heat radiation. Compensation of atmospheric pressure is provided by using the formula below.

$$U_m = \frac{1013}{P_m} \times U_c$$

$U_m$  : Actual Air Velocity [m/s]     $U_c$  : Indicating Value [m/s]

$P_m$  : Atmospheric Pressure at the Measuring Point [hPa]

---

**Kanomax Limited Warranty**

---

The limited warranty set forth below is given by KANOMAX JAPAN, Inc. (hereafter referred to as "KJI") with respect to the KANOMAX brand anemometer, and its attachment parts including probe and other accessories (hereafter referred to as "PRODUCT") purchased directly from KJI or from an authorized distributor.

Your PRODUCT, when delivered to you in new condition in its original container, is warranted against defects in materials or workmanship as follows: for a period of two (2) years from the date of original purchase, defective parts or a defective PRODUCT returned to KJI, as applicable, and proven to be defective upon inspection, will be exchanged for a new or comparable rebuilt parts, or a refurbished PRODUCT as determined by KJI. Warranty for such replacements shall not extend the original warranty period of the defective PRODUCT.

This limited warranty covers all defects encountered in normal use of the PRODUCT, and does not apply in the following cases:

- (1) Use of parts or supplies other than the PRODUCT sold by KJI, which cause damage to the PRODUCT or cause abnormally frequent service calls or service problems.
- (2) If any PRODUCT has its serial number or date altered or removed.
- (3) Loss of damage to the PRODUCT due to abuse, mishandling, alternation, improper packaging by the owner, accident, natural disaster, electrical current fluctuations, failure to follow operation, maintenance or environmental instructions prescribed in the PRODUCT's operation manual provided by KJI, or service performed by any person or entity other than KJI.

NO IMPLIED WARRANTY, INCLUDING ANY IMPLIED WARRANTY OF MERCHANTABILITY OR FITNESS FOR A PARTICULAR PURPOSE, APPLIES TO THE PRODUCT AFTER THE APPLICABLE PERIOD OF THE EXPRESS LIMITED WARRANTY STATED ABOVE, AND NO OTHER EXPRESS WARRANTY OR GUARANTY, EXCEPT AS MENTIONED ABOVE, GIVEN BY ANY PERSON OR ENTITY WITH RESPECT TO THE PRODUCT SHALL BIND KJI. KJI SHALL NOT BE LIABLE FOR LOSS OF STORAGE CHARGES, LOSS OR CORRUPTION OF DATA OR ANY OTHER SPECIAL, INCIDENTAL OR CONSEQUENTIAL DAMAGES CAUSED BY THE USE OR MISUSE OF, OR INABILITY TO USE OR CONSEQUENTIAL DAMAGES CAUSED BY THE USE OR MISUSE OF, OR INABILITY TO USE, THE PRODUCT, REGARDLESS OF THE LEGAL THEORY ON WHICH THE CLAIMS IS BASED, AND EVEN IF KJI HAS BEEN ADVISED OF THE POSSIBILITY OF SUCH DAMAGES. IN NO EVENT SHALL RECOVERY OF ANY KIND AGAINST KJI BE GREATER IN AMOUNT THAN THE PURCHASE PRICE OF THE PRODUCT SOLD BY KJI AND CAUSING THE ALLEGED DAMAGE. WITHOUT LIMITING THE FOREGOING, THE OWNER ASSUMES ALL RISK AND LIABILITY FOR LOSS, DAMAGE OF, OR INJURY TO THE OWNER AND THE OWNER'S PROPERTY AND TO OTHERS AND THEIR PROPERTY ARISING OUT OF USE OR MISUSE OF, OR INABILITY TO USE, THE PRODUCT NOT CAUSED DIRECTLY BY THE NEGLIGENCE OF KJI. THIS LIMITED WARRANTY SHALL NOT EXTEND TO ANYONE OTHER THAN THE ORIGINAL PURCHASER OF THE PRODUCT, OR THE PERSON FOR WHOM IT WAS PURCHASED AS A GIFT, AND STATES THE PURCHASER'S EXCLUSIVE REMEDY.

**After Service**

- When you have a problem with your instrument, please check out "Troubleshooting" first.
- If that does not solve the problem, please contact your local distributor or call our service center. (See last page for "Contact Information".)
- During the warranty period, we will repair at no charge a product that proves to be defective due to material or workmanship under normal use. (See above "Kanomax Limited Warranty".)
- Repair after warranty expiration:  
Upon request, we will repair the instrument at the customer's expense, if the instrument's performance is found to be recoverable by providing the repair.
- Replacement parts are available for minimum period of five (5) years after termination of production. This storage period of replacement parts is considered as the period during which we can provide repair service. For further information, please contact your local distributor or our service center.





**KANOMAX***The Ultimate Measurements*U.S.A.

KANOMAX USA, INC.  
PO Box 372, 219 Route 206, Andover, NJ 07821 U.S.A.  
TEL: (800)-247-8887 / (973)-786-6386 FAX: (973)-786-7586  
URL: <http://www.kanomax-usa.com/>  
E-Mail: [info@kanomax-usa.com](mailto:info@kanomax-usa.com)

JAPAN

KANOMAX JAPAN, INC.  
2-1 Shimizu, Suita City, Osaka 565-0805, Japan  
TEL: 81-6-6877-0183 FAX: 81-6-6879-5570  
URL: <http://www.kanomax.co.jp>  
E-Mail: [sales@kanomax.co.jp](mailto:sales@kanomax.co.jp)

CHINA

Shenyang Kano Scientific Instrument Co., Ltd.  
#2610, 51 Wulihe Street Heping District Shenyang P.R.C.  
TEL: 86-24-23846440 FAX: 86-24-23898417  
URL: <http://www.kanomax.com.cn/>  
E-Mail: [sales@kanomax.com.cn](mailto:sales@kanomax.com.cn)

Copyright © Kanomax Japan Inc. All rights reserved.

2012

No copying, distribution, publication, modification, or incorporation of this document, in whole or part, is permitted for commercial purposes without the express written permission of Kanomax.

The contents of this document may be changed without prior notice.

02001/17.03