

Model D801 “Tuff Tilt Digital” Tiltmeter

The model D801 “Tuff Tilt Digital” is a high performance, digital tiltmeter with advanced firmware features. Units use a gravity referenced electrolytic tilt sensor with superior measurement accuracy and virtually no long-term drift. Output is RS232 or RS422 (RS485 full duplex). Utilizing a 16-bit A/D, the D801 is sensitive to $<0.0001^\circ$ (.0017 mm/m). * User programmable firmware controls include sample averaging, auto-zero (tare), baud/output rate, and more. The D801 also includes on-board memory, with storage capacity up to 22,000 samples. All units are rated IP65 waterproof for advanced protection from the elements. Use the D801 “Tuff Tilt” for structural monitoring, platform position and control, and more.



	High-Gain	Standard	Wide-Angle
Angular Range	$\pm 0.5^\circ$	$\pm 3^\circ$	$\pm 50^\circ$
Resolution	$<0.0001^\circ$	0.0001°	0.002°
Repeatability	0.0003°	0.0003°	0.004°
Non-Linearity	0.1%	0.1%	0.1%
Kz Coefficient ($^\circ/\text{C}$)	± 0.0002 degree/ $^\circ\text{C}$ (typical)		± 0.004 degree/ $^\circ\text{C}$ (typical)
Output	RS232, RS422 (RS485 full duplex)		
Output Format	NMEA XDR, Trimble TCM, Ashtec compatible, Simple (default: X, Y, Temp., S/N)		
Baud Rate	9600 (default), 19200, 28800, 57600, 115200, 130400		
Channels	X-tilt, Y-tilt, Temperature, Serial No.		
Time Constant	0.15 sec		
Power	7-28 VDC @ 30mA, 250 mV ripple max, reverse polarity protected		
Environmental	-40 to +85 C operation and storage; IP65		
Dimensions	120 x 80 x 60 mm, 0.6kg (1.5 lbs)		
Materials	Diecast painted aluminum		
Cable	3m (10 ft.), 6 conductors + one overall shield, PVC jacket. DB9 connector for digital I/O.		

Specifications subject to change without notice on account of continued product development

Ordering Code:

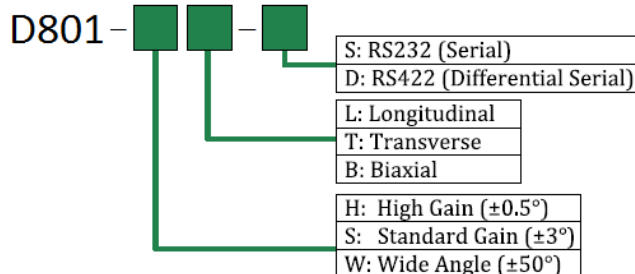

Accessories:

Part No.	Description
70369	6-conductor cable (specify total length on order)
00254-02	Extra power transformer (100-240VAC to 12VDC)
81439	Mounting bracket for vertical surfaces
84051	Mounting plate for horizontal surfaces

Model D801 "Tuff Tilt Digital" Tiltmeter



Enclosure Dimensions

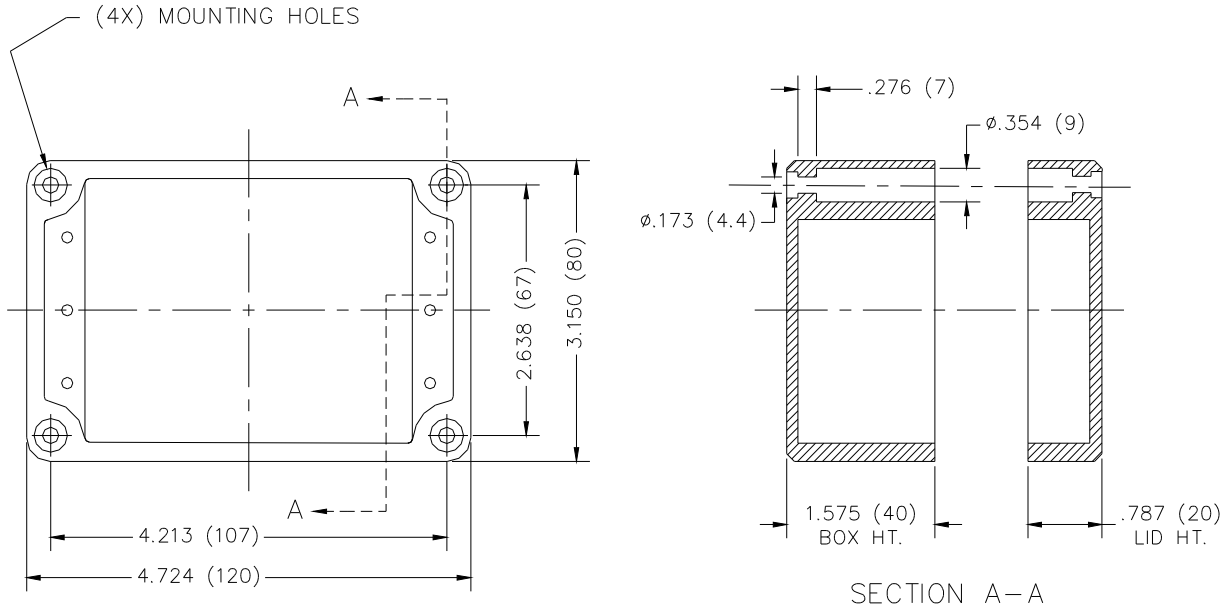

Dimensions in inches (mm)

Cable Wiring and Pin-outs

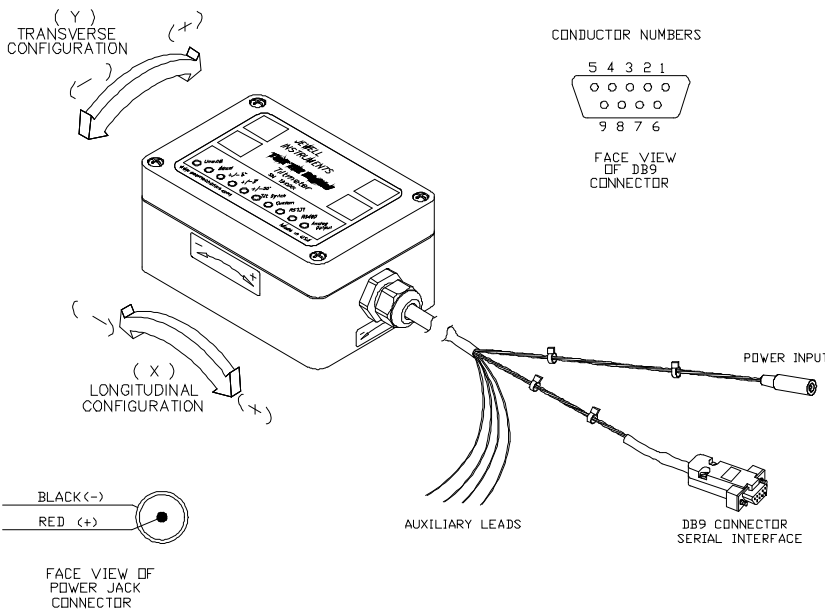

RS232 Wiring

Wire Color	Function	DB9 Pin-out
Black	GND	5
Red	V+ (Power)	--
Green	Analog X Out	--
Yellow	RxD (RS232)	3
White	TxD (RS232)	2
Blue	Analog Y Out	--

RS422 Wiring

Wire Color	Function	DB9 Pin-out
Black	GND	1
Red	V+ (Power)	--
Yellow	Rx- (RS422)	9
Blue	Rx+ (RS422)	8
Green	Tx+ (RS422)	4
White	Tx- (RS422)	5