

IP100/200 Series

Adjustable Depth Insertion
Paddlewheel Instructions

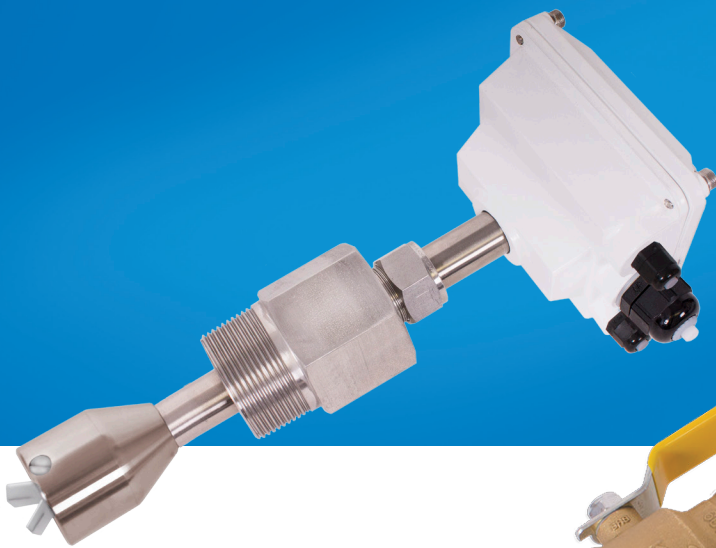

IP11x/21x
(Shown with externally
powered electronics)



IP15x/25x
(Shown with battery
powered electronics)



General Information

General InformationPage 3
 FeaturesPage 3
 SpecificationsPage 5

Installation

Positioning the MeterPage 5
 Immersion.....Page 5
 IP11x/21x Installation.....Page 6
 IP15x/25x Installation.....Page 6
 Depth Setting.....Page 7
 Pipe Wall Thickness.....Page 8
 Flow Range.....Page 8
 Straight Pipe RecommendationsPage 9
 Full Pipe Recommendations.....Page 10

Connections

OverviewPage 11
 FT430Page 11
 FT440Page 12
 FT450Page 12

Operation and Maintenance

Operation TheoryPage 13
 Flow RatePage 13
 Calibration (K-Factor)Page 13
 Rotor ReplacementPage 13
 Checking Signal.....Page 13
 Parts ExplosionPage 14
 Parts List.....Page 14

Troubleshooting

ProblemPage 15
 Probable Cause.....Page 15
 Things To Try.....Page 15

Warranty

Seametrics Limited WarrantyBack

The **IP100/200-Series** are adjustable depth insertion paddlewheels that come in brass, PVC, or 316 stainless models to fit 3" to 40" pipe. Adapters mate with standard 1-1/2" (11x/21x) or 2" (15x/25x), or PVC (11x/21x) NPT threaded fittings such as saddles and weldolets which may be purchased either locally or from Seametrics.

Ruby bearings and a non-drag Hall-effect sensor give these meters the widest flow range of any of the paddlewheel types. A sensor detects the passage of miniature magnets in the six rotor blades. The resulting square-wave signal can be sent for hundreds of feet over unshielded cable without a transmitter and connected directly to many PLC's and other controls without any additional electronics.

A modular system of electronics can be installed directly on the flow sensor or mounted remotely. The FT430 (externally powered with pulse), FT440 (loop powered), and FT450 (battery powered) all provide digital rate and total displays, as well as a programmable pulse; the FT440 also provides a 4-20 mA analog output. The AO55 is a blind analog (4-20 mA) transmitter. Programmable pulse for pump pacing is available with the PD10 (available as wall mounted unit only).

The "hot-tap" models (IP15x/25x) can be installed or serviced without shutting down the line by means of a 2" full-port isolation valve that comes with a nipple for installation on the pipe fitting. In most circumstances, no special tool is required.

Features

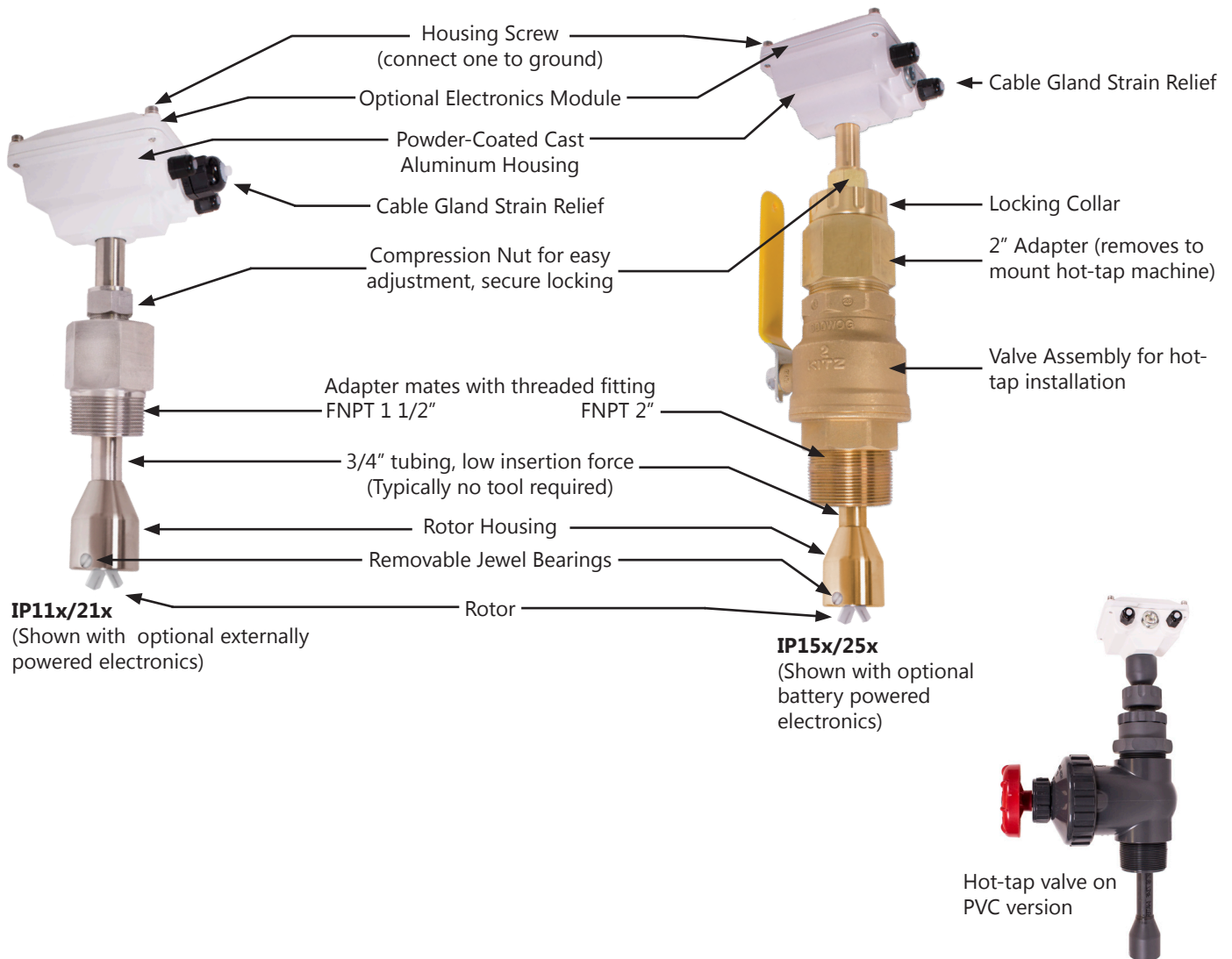

Specifications*

Pipe Size	3" to 40"			
Power	Low Power: 6-36 Vdc/< 2 mA		Micropowered (-04 Option): 3.1-16 Vdc/60 μ A @ 3.6 Vdc	
Sensor	Low Power: Digital Magneto-resistive		Micropowered (-04 Option): Giant Magneto-resistance (GMR)	
Materials	Housing	Powder-coated cast aluminum		
	Tubing/Fitting/Sensor Housing	Brass, PVC, or 316 Stainless Steel		
	Rotor	PVDF (Kynar®)		
	Shaft	Kynar® /Tungsten Carbide (Kynar® /Ceramic or Kynar®/Silicon Carbide optional)		
	Bearings	Ruby jewel		
	O-Ring (15x/25x only)	EDPM		
	Valve Assembly for:	IP11x/21x (Brass/SS)	IP11x/21x (PVC)	IP15x/25x (Brass/SS)
	None	None	Bronze (316SS optional)	Uses gate valve
Fitting Size Required	1.5" FNPT	2" FNPT	2" FNPT	2" FNPT
Maximum	Pressure	Brass/SS: 200 psi (14 bar)		PVC: 150 psi (10 bar)
	Temperature	Brass/SS: 200° F (93° C)		PVC: 130° F (55° C)
Flow Velocity	0.3 to 30 ft/sec (0.9 to 9.14 m/sec)			
Accuracy	\pm 1.5% of full scale			
Output Transistor Maximum Current Sinking	150mA (low power version only)			
Cable	#22 AWG 3-con, 18' (6m); 2,000' (610m) maximum cable run Note: 50' (15m) maximum for battery powered or micropowered versions.			
Environmental	See meter mounted electronic specification for rating.			
Regulatory	C E Mark			

*Specifications subject to change. Please consult our website for the most current data (www.seametrics.com).

Kynar is a registered trademark of Arkema, Inc.

Positioning the Meter

For best results, the IP sensor should be installed with at least ten diameters of straight pipe upstream and five downstream. Certain extreme situations such as partially-opened valves are particularly difficult and may require fifteen diameters upstream. (See Straight Pipe Recommendations.)

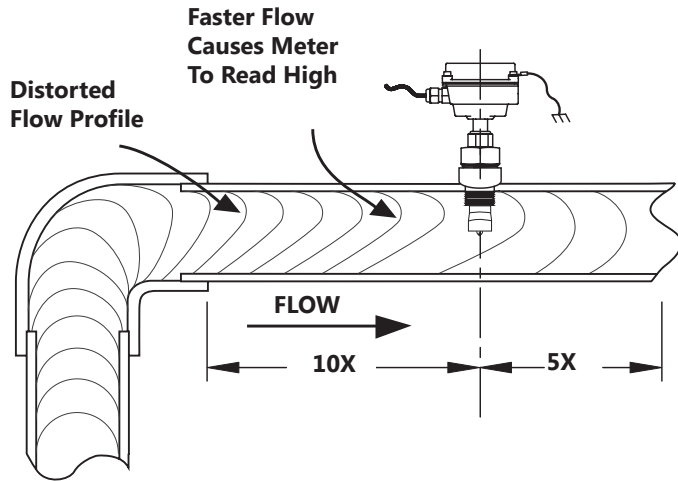

Distorted Flows

Horizontal (3 o'clock or 9 o'clock position) is the preferred installation orientation, since it improves low-flow performance and avoids problems with trapped air and sediment. (See Orienting the Meter diagram below.) Bottom (6 o'clock), top (12 o'clock), and vertical pipe installations are all acceptable if required by the piping layout.

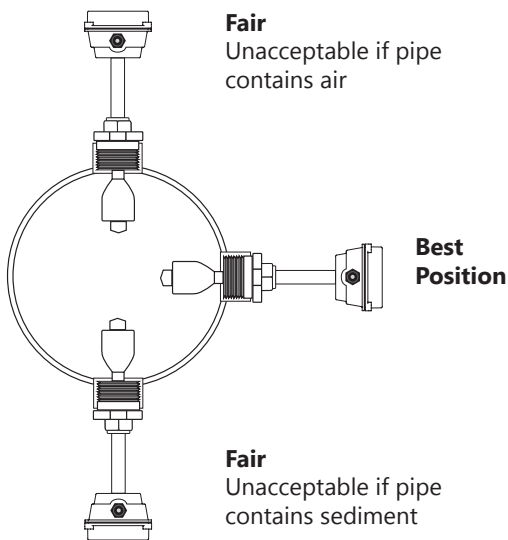

Orienting the Meter

Immersion

The IP100/200 Series standard sensors are not designed for continuous underwater operation. If this is a possibility, as in a flooded vault, a unit modified for immersion should be specified (Option -40).



Caution: These flow sensors are not recommended for installation downstream of a boiler feedwater pump where installation fault may expose the flow sensor to boiler pressure and temperature. Maximum recommended temperature is 200°F.

IP11x/21x Installation

Fitting Installation. IP11x/21x brass/SS adapters mate with a 1-1/2" female NPT pipe thread adapter fitting (2" for PVC). Any fitting that provides the matching NPT female thread may be used. Installation procedure compensates for fitting height differences. Cut a minimum 1-3/4" hole in the pipe. If possible, measure the wall thickness and write it down for use in depth setting. Then install the threaded fitting (saddle, weldolet, etc.) on the pipe.

Meter Installation. Loosen the compression nut so that the adapter slides freely. Pull the meter fully upward and finger-tighten the compression nut. Using a thread sealant, install the adapter in the pipe fitting. Do not overtighten. Now loosen the compression nut, lower the meter to the appropriate depth setting (see diagram and instructions that follow). **Caution: Do not allow the meter to fall into the pipe uncontrolled, as this may damage the meter.** Be sure flow is in the direction of the arrow on the housing. Fully tighten compression nut.

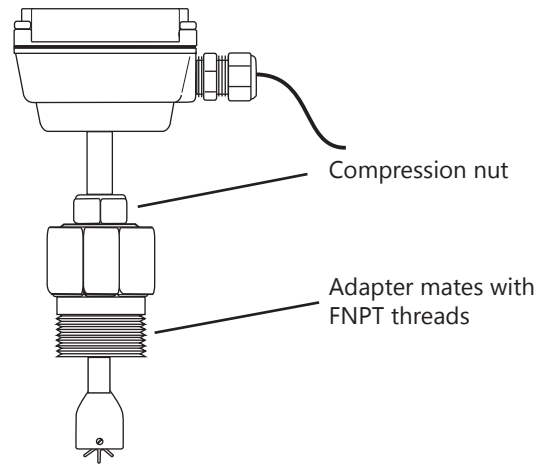

IP15x/25x Installation

Hot tap' IP meters are designed to be installed and serviced without depressurizing the pipe.

Fitting Installation. The IP15x and 25x adapters mate with a 2" FNPT threaded fitting for compatibility with the 2" isolation valve. Any fitting that provides matching NPT female thread may be used. The installation procedure compensates for differences in fitting height.

If initial installation is performed on an unpressurized pipe, cut a minimum 1-3/4" hole in the pipe. If possible, measure the wall thickness and write it down for use in depth setting. Then install the threaded fitting (saddle, weldolet, etc.) on the pipe.

If it is necessary to do the initial installation under pressure, any standard hot tap drilling machine with 2" NPT adapter, such as a Transmate or a Mueller, can be used. Ordinarily, it is not necessary to use an installation tool, since the small-diameter tube can be controlled by hand at all but the highest pressures.

Meter Installation. Remove the sensor unit from the valve assembly. Using a thread sealant, install the valve assembly on the pipe fitting. If the initial installation is a pressure ("hot") tap, remove the 1-1/2" x 2" adapter bushing at the back of the valve. Thread the tapping machine on, open the valve, and tap using a minimum of 1-3/4" or maximum 1-7/8" cutter. After retracting the machine and closing the valve, reinstall the flow sensor. When the sensor is secure, open the valve and adjust depth setting (see diagram and instructions that follow). Be sure flow is in the direction of the arrow on the housing. Tighten locking collar and compression nut fully.

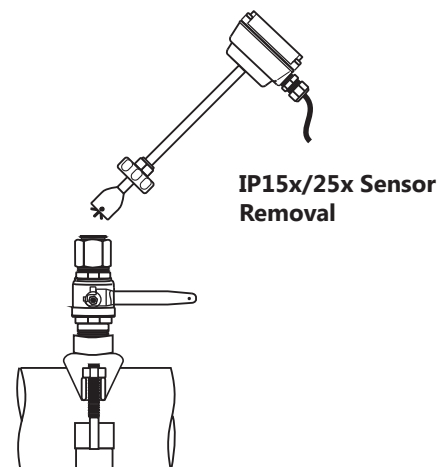
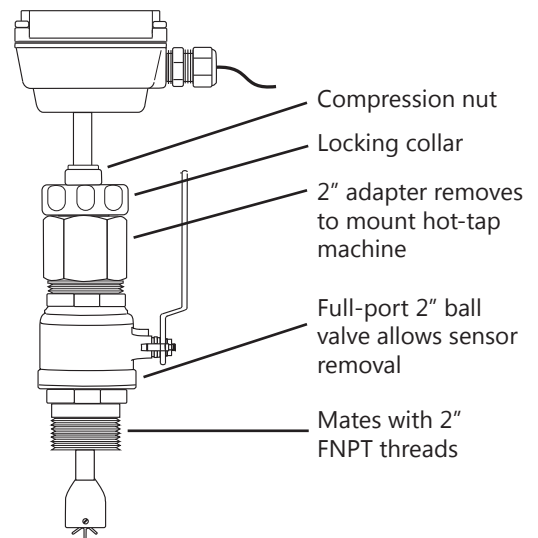

Depth Setting

It is important for accuracy that the sensor be inserted to the correct depth into the pipe.

1. Go to www.seametrics.com and select the K-factor Calculator located at the bottom of the home page to find dimension D (insertion depth setting)*.
2. Measuring from the outside of the pipe to the joint in the housing, as shown in the diagram, adjust the sensor to Dimension D and hand-tighten compression nut.
3. Align the conduit housing with the centerline of the pipe, as shown. Be sure the arrow on the housing points in the direction of flow.

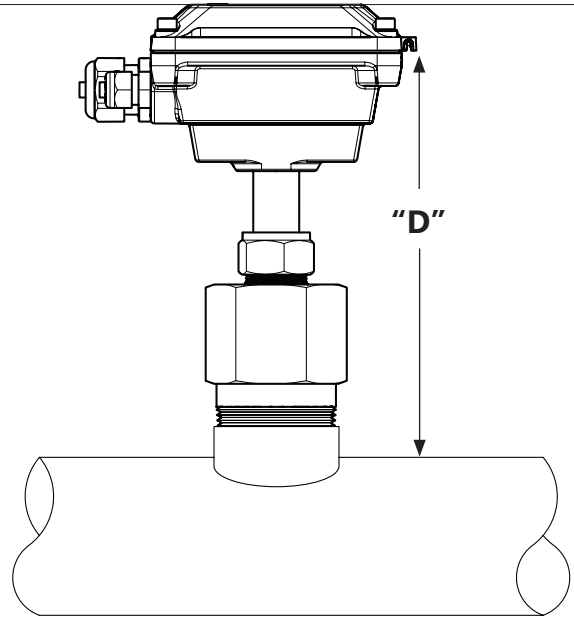
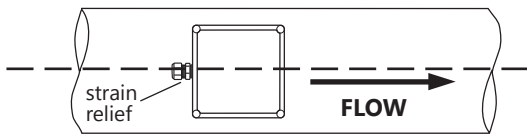

Proper Depth Setting

4. Check Dimension D one more time.
5. Fully tighten the compression nut.

Record your settings. Once you have the meter set up and operational, it is important to record you meter settings and save them future reference.

K-Factor _____

Insertion Depth (Dim. D) _____

* For pipe sizes larger than 50", please consult factory.



Caution! Never attempt to remove a flow sensor when there is pressure in the pipe unless it is specifically designed for hot tap installation and removal. Loosen the compression nut slowly to release any trapped pressure. If fluid sprays out when removing the sensor, stop turning and depressurize the pipe. Failure to do so could result in the sensor being thrown from the pipe, resulting in damage or serious injury.

Table 1: Pipe Wall Thickness (inches)

Nominal Pipe Size*													
	3"	4"	6"	8"	10"	12"	14"	16"	18"	20"	24"	30"	36"
Schedule 40	0.216	0.237	0.280	0.322	0.365	0.406	0.438	0.500	0.562	0.593	0.687	--	--
Schedule 80	0.300	0.337	0.432	0.500	0.593	0.687	0.750	0.843	0.937	1.031	1.218	--	--
Stainless Steel (10S)	0.120	0.120	0.134	0.148	0.165	0.180	0.188	0.188	0.188	0.218	0.250	0.312	0.312
Stainless Steel (40S)	0.216	0.237	0.280	0.322	0.365	0.375	0.375	0.375	0.375	0.375	0.375	0.375	0.375
Copper Tubing (Type L)	0.090	0.100	0.140	0.200	0.250	0.280	--	--	--	--	--	--	--
Copper Tubing (Type K)	0.109	0.134	0.192	0.271	0.338	0.405	--	--	--	--	--	--	--
Brass Pipe	0.219	0.250	0.250	0.312	0.365	0.375	--	--	--	--	--	--	--
Duct. Iron (Class 52)	0.280	0.290	0.310	0.330	0.350	0.370	0.390	0.400	0.410	0.420	0.440	0.470	0.530

* Call factory for larger pipe sizes.

Table 2: Flow Range in Sched. 40 pipe (in GPM)

Nominal Pipe Size*												
Velocity (ft/sec)	3"	4"	5"	6"	8"	10"	12"	16"	24"	36"	38"	48"
0.3	6.9	11.9	18.7	27	46.8	73.7	105	165	376	874	1060	1690
0.5	11.5	19.8	31.2	45	78	123	174	275	627	1460	1770	2820
1.0	23	39.7	62.4	90	156	246	349	551	1250	2910	3530	5640
2.0	46.1	79.4	125	180	312	492	698	1100	2510	5830	7070	11280
5.0	115	198	312	450	780	1230	1740	2750	6270	14570	17670	28200
10.0	230	397	624	900	1560	2460	3490	5510	12530	29140	35350	56400
20.0	461	794	1250	1800	3120	4920	6980	11020	25060	58270	70700	112800
30.0	691	1190	1870	2700	4680	7370	10470	16520	37600	87410	106050	170000

* Call factory for larger pipe sizes.

Straight Pipe Recommendations (X = diameter)

Reduced Pipe

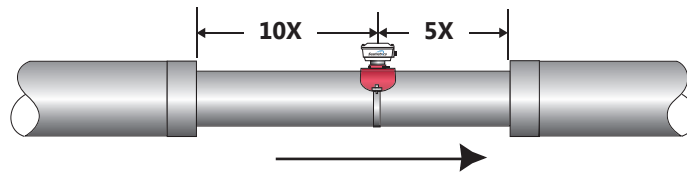

Two Elbows In Plane

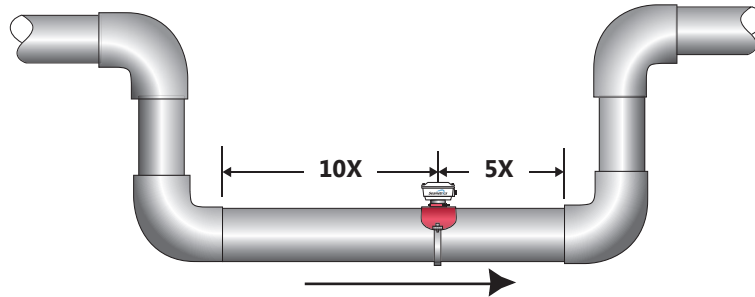

Two Elbows, Out Of Plane

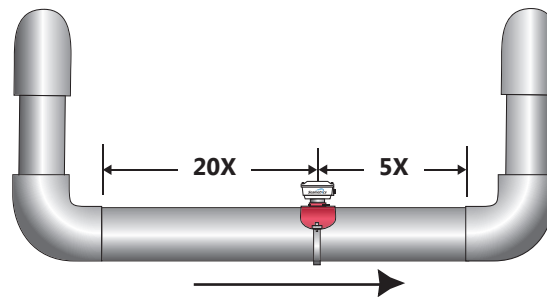

Expanded Pipe

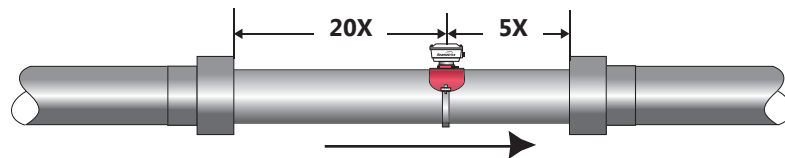

Spiral Flow

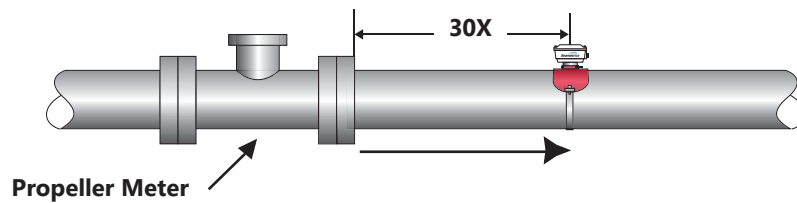

Swirling Flow

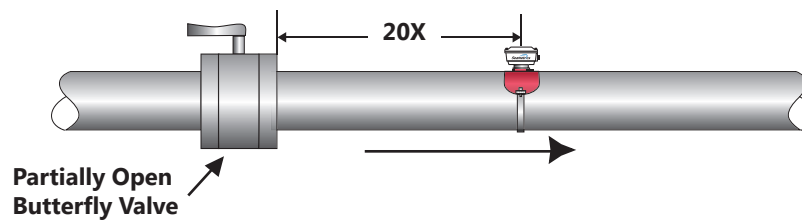

Full Pipe Recommendations

Possible Problem

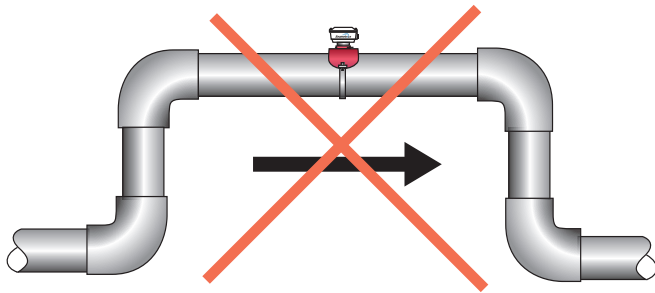

Allows air pockets to form at sensor

Better Installation

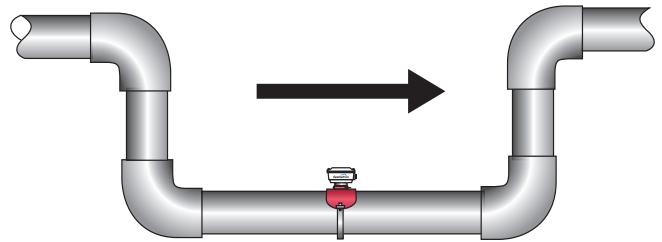

Ensures full pipe

Possible Problem

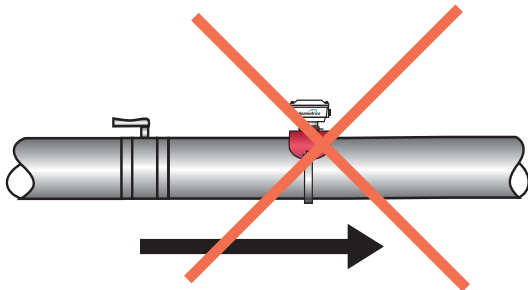

Post-valve cavitation can create air pocket

Better Installation

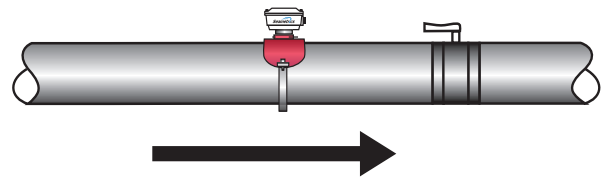

Keeps pipe full at sensor

Possible Problem

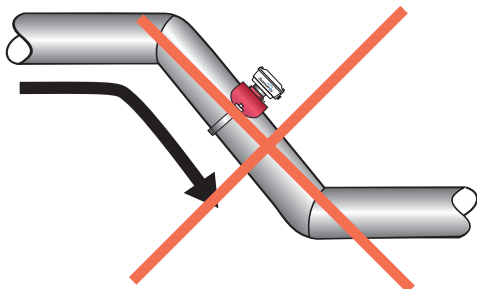

Air can be trapped

Better Installation

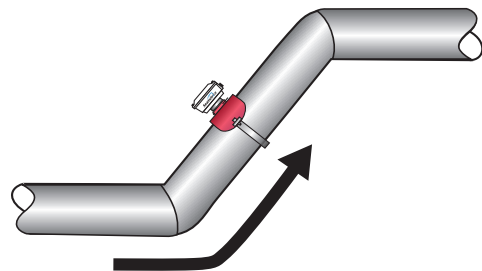

Allows air to bleed off



Caution: These flow sensors are not recommended for installation downstream of a boiler feedwater pump where installation fault may expose the flow sensor to boiler pressure and temperature. Maximum recommended temperature is 200°F.

Sensors are supplied with 18 ft. (6m) of cable. For sensors with no additional electronics, see diagram for color coding of connections. For sensors with on-board electronics, see the manual accompanying the electronic module.

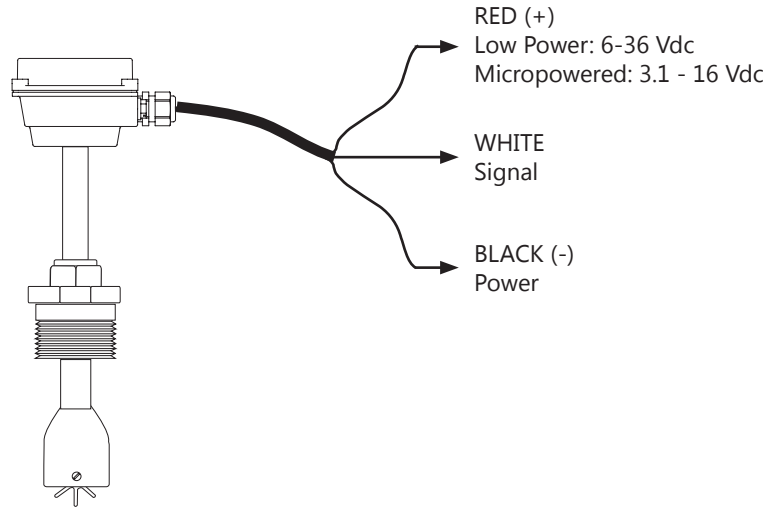

FT430

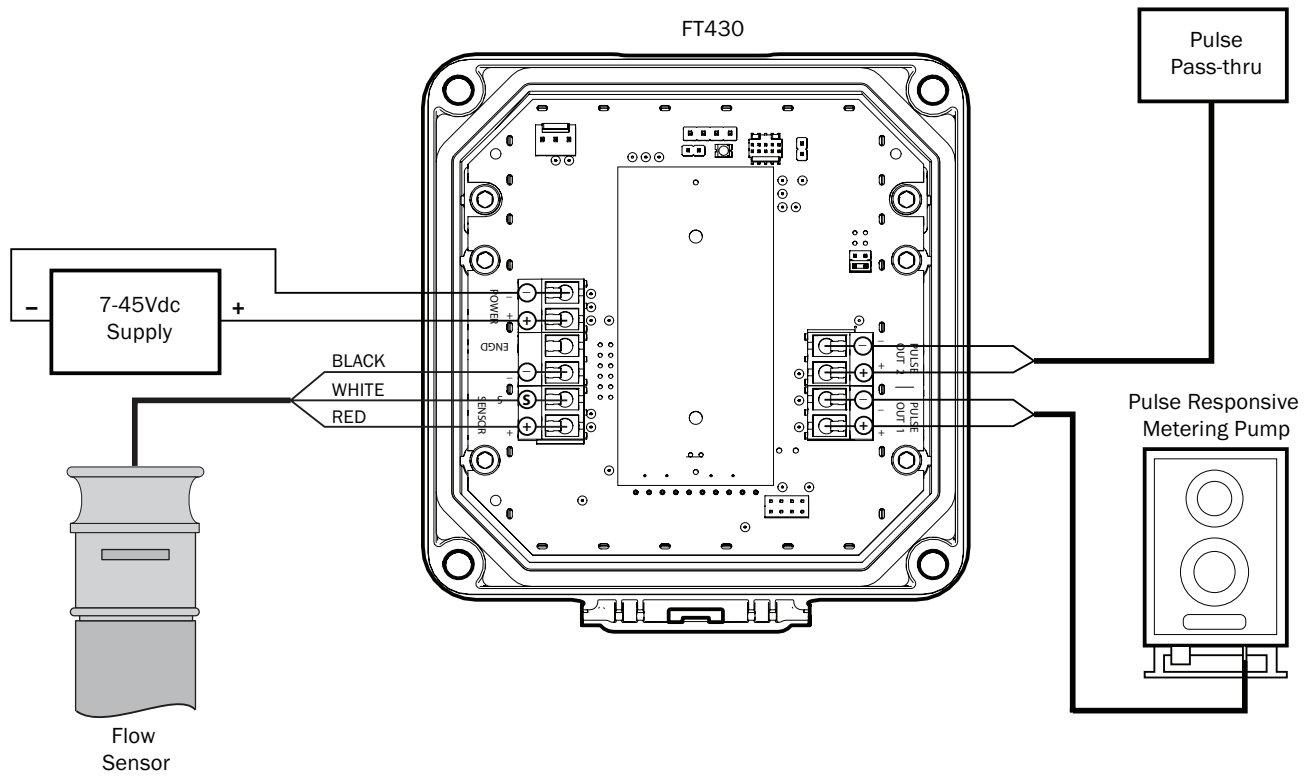

FT440

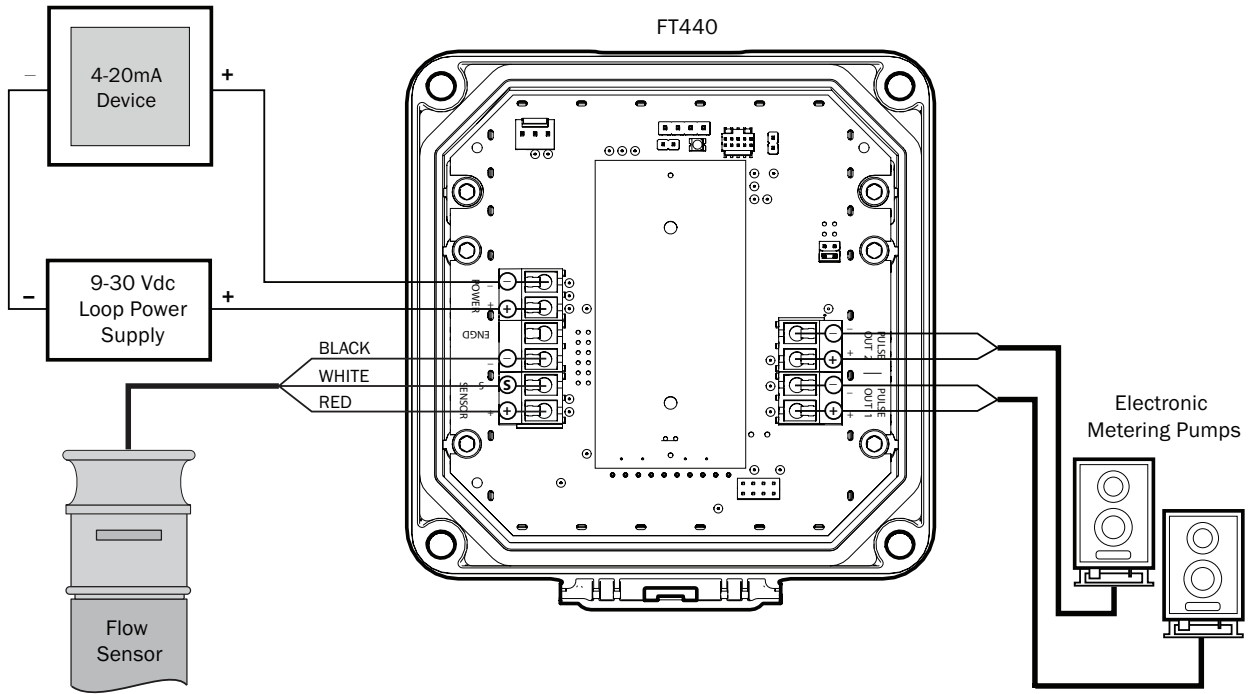

FT450

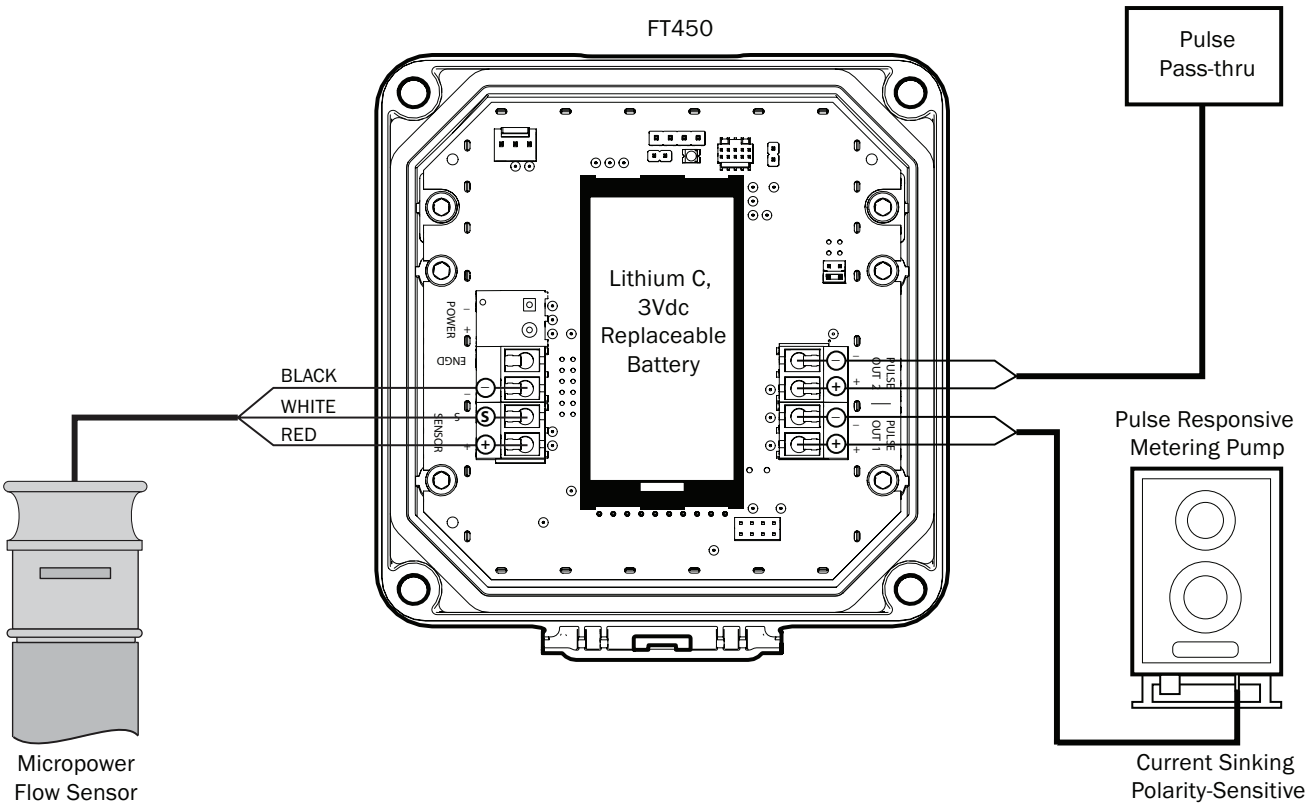

Operation Theory

In principle, an insertion flow sensor measures the velocity of flow at one point in the pipe, and flow rate and total can be inferred from this one point. Accuracy is decreased by any factor which makes the flow at the measured point unrepresentative of the entire flow stream. This includes distorted flow patterns caused by upstream fittings too close to the sensor. The worst offenders are fittings that increase the flow on one side of the pipe, such as partially-opened gate or butterfly valves. Fluid moving in a pipe does not all flow at the same velocity. Toward the center of the pipe, fluid moves faster than at the wall, and the relationship between the two changes as overall flow rate increases. This change in the "velocity profile" can result in non-linearity, which means that the K-factor that is correct for one flow rate may be incorrect for another. The recommended depth settings have been carefully chosen to minimize this source of error, and should be followed carefully, especially in the smaller pipe sizes.

Flow Rate

These sensors are designed to operate at flow velocities of 0.3 to 30 feet per second. (See chart for conversion to gallons per minute.) If erratic readings are encountered at low flows, check the chart to see if flow is below minimum for the pipe size. The standard shaft and bearings should have a long life at continuous high flow.

Calibration ("K-Factor")

In order to properly process pulses from the flow sensor, a number must be entered into the control to which the sensor is connected. This number, called the K-factor, is the number of pulses the sensor puts out per unit of fluid passing through the pipe. It is normally provided for Seametrics sensors in pulses per gallon, and is given on the chart "K-factors for Various Pipe Sizes." These numbers are based on extensive testing, which has shown close agreement between different IP sensors in the same installation. Typically, most K-factor error can be attributed to installation variables, such as depth setting and fitting configuration.

It is occasionally possible to field calibrate a sensor by catching the fluid in a measured container and comparing with the number of pulses recorded. (To record individual pulses, set the K-factor on the control to 1.00.) This is especially desirable if the installation has less than the recommended length of straight pipe upstream of the sensor.

All Seametrics flow sensors are repairable, and can be returned to the factory or distributor for repair after a Return Material Authorization (RMA) number has been issued.

Rotor Replacement

Rotors are easily field-replaced. Shaft and rotor are a single unit, and are not replaced separately. If replacement is due only to normal shaft wear, bearing replacement is probably not necessary. If the rotor has been damaged by impact, the bearings should also be replaced. Rotor and bearings can be ordered as a kit, Part No. 25902. Follow these steps:

1. Unscrew the threaded bearing housings to expose the shaft ends. If bearings are being replaced, back them completely out.
 2. Remove the rotor. Put the new rotor in its place.
 3. Thread in one bearing housing part way, then the other. Take care to start the end of the shaft into the bearing hole before tightening further.
 4. Screw in bearing housings until they bottom.
- Note:** Do not use excessive force.
5. Check for free spin. Blowing lightly on the rotor should result in it spinning rapidly and coasting to a smooth stop.

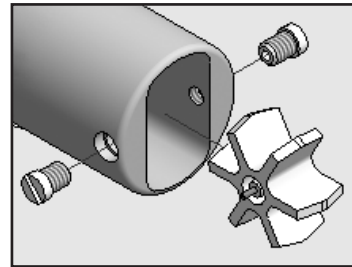

Checking Signal

The flow sensor has only one moving part, the rotor. If this is turning properly and there is no signal, the Hall-effect sensor is not operating properly. To check the signal, apply 12 Vdc regulated* power to the red (+) and black (-) leads. Set a multimeter to voltage reading. Put the positive multimeter lead on the red wire and the negative lead on the white wire. Slowly turn the rotor. Voltage reading should swing between +12 Volts and 0 Volts as the rotor turns. If it does not, the Hall effect sensor is not working properly. Checking for continuity is not a useful test of these sensors.

***NOTE:** An unregulated power supply can exceed max voltage of micro-powered sensor pickup (gray cable) and damage sensor.

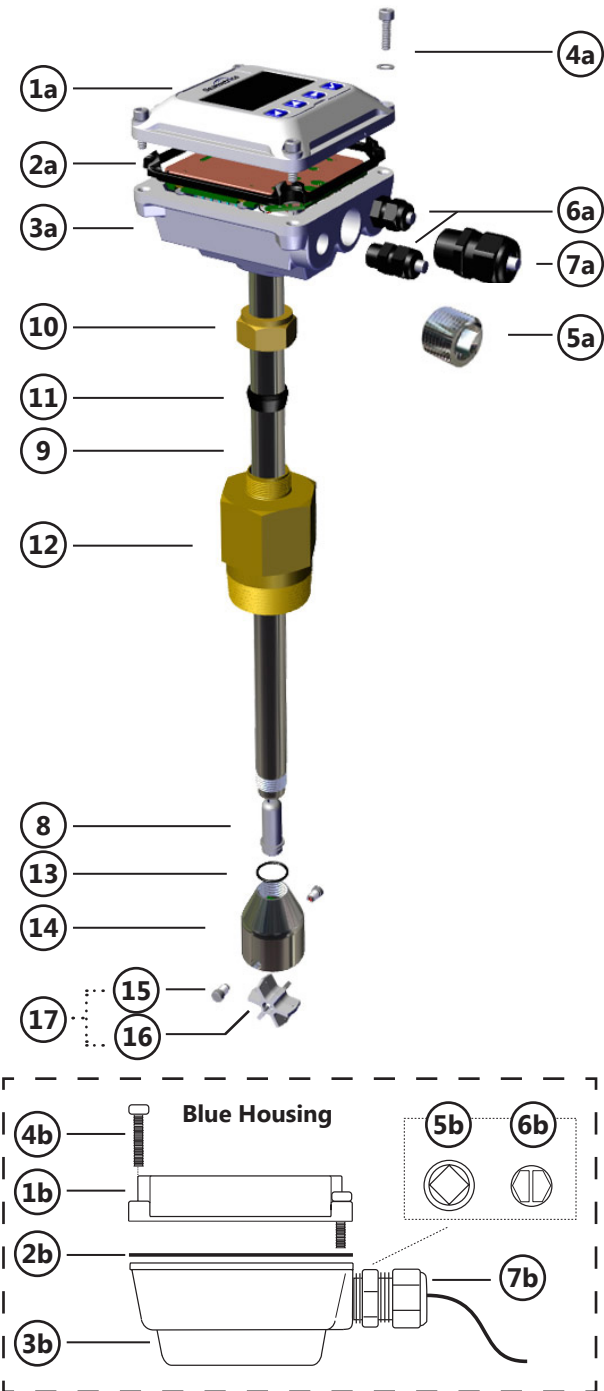

IP 11x/21x Parts		White Housing 1a thru 7a	Blue Housing 1b thru 7b
1	Upper housing/ electronics	Contact service representative for your specific model	Contact service representative for your specific model
2	Housing gasket/seal	102025	100411
3	Lower housing	Not field replaceable	Not field replaceable
4	Housing screw/washer kit (4 each)	100414	100414
5	Plug, steel (battery units)	100360	100360
6	Strain relief kit, small (includes 2)	100364	100364
7	Strain relief kit, large (includes 1) (externally powered units)	101850	101850
8	Sensor pickup	100508 (Micropower, gray cable, FT450) 100419 (Standard, blue cable, FT430/440)	
9	Tube	Not field replaceable	
10	Compression nut	100064 (brass) 100084 (ss)	
11	Compression ferrule	100358	
12	Adapter	100845 (brass) 100846 (ss)	
13	Rotor housing o-ring	100218 (EPDM)	
14	Rotor housing	100068 (brass) 100118 (ss)	
15	Bearings (includes 2)	103315	
16	Rotor with shaft	100035 (Kynar®/tungsten carbide) 100036 (Kynar®/ceramic) 100435 (Kynar®/silicone carbide)	
17	Rotor repair kit (#15 & #16 above)	100317 (Kynar®/tungsten carbide) 100043 (Kynar®/ceramic) 100556 (Kynar®/silicone carbide)	

IP 15x/25x Parts (Hot Tap)		
All parts are the same except those below, which replace #12		
A	Locking collar	100061 (brass) 100116 (ss)
B	Adapter fitting O-ring	100345 (EPDM)
C	Adapter, hot tap	100384 (brass) 100385 (ss)
D	Nipple, 2 inch	100066 (brass) 100103 (ss)
E	Valve assembly (includes valve plus B, C, & D above)	100069 (brass) 100119 (ss)

Problem	Probable Cause	Things to Try...
No pulse output	Below minimum flow cutoff	Check velocity vs. pipe size (see page 8)
	Empty pipe	Check plumbing
	No power	Check connections
Output pulses incorrect	Incorrect depth setting	Check depth setting (see page 7)
	Pipe not full	Refer to installation recommendations (see pages 5 and 10)
	Not enough straight pipe	Refer to installation recommendations (see pages 5 and 9)
Jumpy reading	Fluctuating flow rate	Refer to installation recommendations (see pages 5 - 10)
	Fluctuating around low flow cutoff	Check velocity vs. pipe size (see page 8)
	Not enough straight pipe	Refer to installation recommendations (see pages 5 and 9)

The limited warranty set forth below is given by Seametrics, with respect to Seametrics and INW brand products purchased in the United States of America.

Seametrics warrants that products manufactured by Seametrics, when delivered to you in new condition in their original containers and properly installed, shall be free from defects in material and workmanship. **Seametrics products are warranted against defects for a period of two (2) years from date of installation, with proof of install date. If no proof of install date can be provided, warranty period will be two (2) years from date of shipment from Seametrics, as defined on Seametrics' invoice.** Seametrics' obligation under this warranty shall be limited to replacing or repairing the part or parts, or, at Seametrics' option, the products, which prove defective in material or workmanship. The following are the terms of Seametrics' limited warranty:

- a. Buyer must give Seametrics prompt notice of any defect or failure and satisfactory proof thereof.
- b. Any defective part or parts must be returned to Seametrics' factory or to an authorized service center for inspection.
- c. Buyer will prepay all freight charges to return any products to Seametrics' factory, or another repair facility, as designated by Seametrics.
- d. Defective products, or parts thereof, which are returned to Seametrics and proved to be defective upon inspection, will be repaired to factory specifications.
- e. Seametrics will deliver repaired products or replacements for defective products to the buyer (ground freight prepaid) to the destination provided in the original order.
- f. Products returned to Seametrics for which Seametrics provides replacement under this warranty shall become the property of Seametrics.
- g. This limited warranty covers all defects encountered in normal use of Seametrics products, and does not apply to the following cases:
 - i. Loss of or damage to Seametrics product due to abuse, mishandling, or improper packaging by buyer
 - ii. Failure to follow operating, maintenance, or environmental instructions prescribed in Seametrics' instruction manual
 - iii. Products not used for their intended purpose
 - iv. Alterations to the product, purposeful or accidental
 - v. Electrical current fluctuations
 - vi. Corrosion due to aggressive materials not approved for your specific product
 - vii. Mishandling, or misapplication of Seametrics products
 - viii. Products or parts that are typically consumed during normal operation
 - ix. Use of parts or supplies (other than those sold by Seametrics) which cause damage to the products, or cause abnormally frequent service calls or service problems
- h. A new warranty period shall not be established for repaired or replaced material, products, or supplied. Such items shall remain under warranty only for the remainder of the warranty period on the original materials, products, or supplies.
- i. In the event that equipment is altered or repaired by the buyer without prior written approval by Seametrics, all warranties are void. Damage caused by equipment or accessories not manufactured by Seametrics may void the product's warranty.
- j. SOFTWARE: The Seller grants the user a non-exclusive license to use Seametrics' software, according to the following limitations and conditions:
 - i. The user may install the software on one or more desktop or laptop computers.
 - ii. All title and intellectual rights to the software are owned by Seametrics.
 - iii. No copies may be made or distributed except as described above.
 - iv. The user may not modify or reverse-engineer the software.

THE FOREGOING WARRANTY IS IN LIEU OF ALL OTHER WARRANTIES, WHETHER ORAL, WRITTEN, EXPRESSED, IMPLIED OR STATUTORY. NO IMPLIED WARRANTY, INCLUDING ANY IMPLIED WARRANTY OF MERCHANTABILITY OR FITNESS FOR A PARTICULAR PURPOSE, APPLIED TO THE PRODUCTS AFTER THE APPLICABLE PERIOD OF THE EXPRESS LIMITED WARRANTY STATED ABOVE, AND NO OTHER EXPRESS WARRANTY OR GUARANTY, EXCEPT AS MENTIONED ABOVE, GIVEN BY ANY PERSON OR ENTITY WITH RESPECT TO THE PRODUCTS, SHALL BIND SEAMETRICS. SEAMETRICS SHALL NOT BE LIABLE FOR LOSS OF REVENUES, OR PROFITS, OR INCONVENIENCES, EXPENSE FOR SUBSTITUTE EQUIPMENT OR SERVICE, STORAGE CHARGES, LOSS OF DATA, OR ANY OTHER SPECIAL, INCIDENTAL, OR CONSEQUENTIAL DAMAGE CAUSED BY THE USE OR MISUSE OF, OR INABILITY TO USE THE PRODUCTS, REGARDLESS OF THE LEGAL THEORY ON WHICH THE CLAIM IS BASED, AND EVEN IF SEAMETRICS HAS BEEN ADVISED OF THE POSSIBILITY OF SUCH DAMAGES. IN NO EVENT SHALL RECOVERY OF ANY KIND AGAINST SEAMETRICS BE GREATER IN AMOUNT THAN THE PURCHASE PRICE OF THE PRODUCT SOLD BY SEAMETRICS AND CAUSING THE ALLEGED DAMAGE. WITHOUT LIMITING THE FOREGOING, YOU ASSUME ALL RISK OF LIABILITY FOR LOSS, DAMAGE, OR INJURY TO YOU AND YOUR PROPERTY AND TO OTHERS AND THEIR PROPERTY ARISING OUT OF USE OR MISUSE OF, OR INABILITY TO USE THE PRODUCTS NOT CAUSED DIRECTLY BY THE NEGLIGENCE OF SEAMETRICS.

SOME STATES DO NOT ALLOW LIMITATIONS ON THE DURATION OF AN IMPLIED WARRANTY, SO THE ABOVE LIMITATIONS MAY NOT APPLY TO YOU. SIMILARLY, SOME STATES DO NOT ALLOW THE EXCLUSION OR LIMITATIONS OF CONSEQUENTIAL DAMAGE, SO THE ABOVE LIMITATION OR EXCLUSION MAY NOT APPLY TO YOU. THIS LIMITED WARRANTY GIVES YOU SPECIFIC LEGAL RIGHTS; HOWEVER, YOU MAY ALSO HAVE OTHER RIGHTS WHICH MAY VARY FROM STATE TO STATE.

