



Touchpoint Plus

Technical Handbook

Revision History

Revision	Comment	Date
Issue 01	First Issue and initial translations	30/05/2015
Issue 02	Added new chapters, new data and final translations	09/06/2015
Issue 03	Completely Revised; added Expansion Unit, Dual Input Module and Modbus	29/02/2016
Issue 04	Added new chapters; added SIL2 and ATEX certification	22/01/2019

Conditions of Use

Disclaimer

In no event shall Honeywell be liable for any damages or injury of any nature or kind, no matter how caused, that arise from the use of the equipment referred to in this manual.

Strict compliance with the safety procedures set out and referred to in this manual, and extreme care in the use of the equipment, are essential to avoid or minimise the chance of personal injury or damage to the equipment.

The information, figures, illustrations, tables, specifications, and schematics contained in this manual are believed to be correct and accurate as at the date of publication or revision. However, no representation or warranty with respect to such correctness or accuracy is given or implied and Honeywell will not, under any circumstances, be liable to any person or corporation for any loss or damages incurred in connection with the use of this manual.

The information, figures, illustrations, tables, specifications, and schematics contained in this manual are subject to change without notice.

Unauthorised modifications to the gas detection system or its installation are not permitted, as these may give rise to unacceptable health and safety hazards.

Any software forming part of this equipment should be used only for the purposes for which Honeywell supplied it. The user shall undertake no changes, modifications, conversions, translations into another computer language, or copies (except for a necessary backup copy).

In no event shall Honeywell be liable for any equipment malfunction or damages whatsoever, including (without limitation) incidental, direct, indirect, special, and consequential damages, damages for loss of business profits, business interruption, loss of business information, or other pecuniary loss, resulting from any violation of the above prohibitions.

Warranty

Honeywell Analytics warrants the Touchpoint Plus system against defective parts and workmanship, and will repair or (at its discretion) replace any components that are or may become defective under proper usage within 12 months from the date of commissioning by a Honeywell Analytics approved representative* or 18 months from shipment from Honeywell Analytics, whichever is sooner.

This warranty does not cover consumable, batteries, fuses, normal wear and tear, or damage caused by accident, abuse, improper installation, unauthorized use, modification or repair, ambient environment, poisons, contaminants or abnormal operating conditions.

This warranty does not apply to sensors or components that are covered under separate warranties, or to any 3rd-party cables and components.

Any claim under the Honeywell Analytics Product Warranty must be made within the warranty period and as soon as reasonably practicable after a defect is discovered. Please contact your local Honeywell Analytics Service representative to register your claim.

This is a summary. For full warranty terms please refer to the Honeywell Analytics' General Statement of Limited Product Warranty, which is available on request.

* A Honeywell Analytics approved representative is a qualified person trained or employed by Honeywell Analytics, or a qualified person trained in accordance with this manual.

Copyright Notice

Microsoft, MS and MS-DOS are registered trademarks of Microsoft Corp.

Other brand and product names mentioned in this manual may be trademarks or registered trademarks of their respective companies and are the sole property of their respective holders.

Honeywell is the registered trademark of Honeywell Safety and Productivity Solutions (SPS).

Touchpoint is a registered trademark of Honeywell Analytics (HA).

Find out more at www.honeywellanalytics.com

This page is deliberately left blank.

Contents

Chapter 1. Important Information	9
1.1 Regulatory Approval Markings.....	9
1.2 Additional Product Markings.....	9
1.3 TPPL Mandatory Warning	9
1.4 TPPL General Warnings	10
1.5 TPPL General Cautions.....	11
1.6 How to Use this Manual.....	11
1.6.1 Intended Readers	11
1.6.2 Conventions Used.....	11
1.6.3 Associated Manuals.....	12
Chapter 2. Safety Hazards, Warnings and Cautions	13
2.1 Safety	13
2.1.1 Warnings and Cautions.....	13
2.1.2 Safety Hazards.....	14
2.2 Location and Description of Warning Labels	16
2.2.1 Safety Warning Labels	16
2.3 Electrical Hazards.....	17
2.3.1 General Safety Precautions.....	17
2.3.2 Component Testing and Replacement	17
2.3.3 Good Practice	18
2.3.4 Lithium Battery Hazard	18
2.3.5 Product Compliance	19
2.3.6 Training of Personnel	20
2.3.7 Conditions Satisfying Local, National and International Safety Regulations	20
2.3.8 Approved Maintenance and Servicing Procedures.....	20
2.4 Security guide	20
2.5 Firmware and EEPROM update.....	20
Chapter 3. System General Description.....	21
3.1 How to Open and Close the Enclosure.....	23
3.2 Equipment Specification.....	24
3.2.1 Power Requirements (Controller Unit only)	24
3.2.2 Weights.....	25
3.2.3 Dimensions.....	25
3.2.4 Ambient Operating Temperature.....	25
3.2.5 Overall Ambient Operating Humidity	25
3.2.6 Storage Conditions (Without batteries)	25
3.2.7 Storage Conditions (With batteries)	25
3.2.8 IP Rating.....	25
3.2.9 Construction	25
3.2.10 Touchpoint Plus Packaging	26
3.2.11 Packaging Components for Return to Manufacturer	26
3.2.12 Disposal (WEEE Directive)	26
3.3 TPPL Construction	26
3.3.1 TPPL Basic Control Unit	26
3.3.2 TPPL Expansion Unit.....	27
3.3.3 TPPL DIP Switches	27
Chapter 4. System Mechanical Installation	28
4.1 Wall Mounting Requirements	28
Chapter 5. Electrical Power Connection and Interfacing	30
5.1 Power Connection.....	30
5.1.1 AC Power Supply	31
5.1.2 DC Power Supply.....	32
5.1.3 Backup Battery Pack.....	32
5.2 Cabling and Connection Requirements.....	33

5.2.1 AC Mains Voltage Power Cables	33
5.2.2 DC Power Cables.....	33
5.2.3 Field Device Cables	33
5.2.4 Optional Expansion Unit Connection	34
5.2.5 Main Module Connections.....	35
5.2.6 Expansion Module Power Connections.....	36
5.2.7 TPPL DIP Switches	37
5.2.8 Ethernet Connection (Option).....	37
5.2.9 Module / Field Device Connections.....	38
5.2.10 mA Input Module Connections.....	39
5.2.11 mV Input Module Connections.....	42
5.2.12 Dual Input Module Connections	44
5.2.13 mA Output Module Connections.....	45
5.2.14 Relay Output Module Connections.....	46
5.3 Modbus Remote Terminal Unit (RTU) and Transmission Control Protocol (TCP) Connections.....	47
5.3.1 Modbus Configuration	49
Chapter 6. Commissioning.....	50
6.1 Menu Structure.....	50
6.1.1 The Information Menu.....	50
6.1.2 The Configuration Menu.....	51
6.1.3 The Maintenance Menu.....	52
6.1.4 System Test Menu.....	52
6.2 First Time Switch On.....	53
6.3 Logging In/Out.....	54
6.3.1 How to Log In.....	54
6.3.2 How to Log Out.....	54
6.3.3 Password Rules	54
6.3.4 How To Change a Password.....	55
6.3.5 Forgotten Passwords.....	55
6.4 Date, Time and Language Settings	56
6.4.1 How to Set or Change Date, Time and Language Settings.....	56
6.5 Service Contact Settings.....	56
6.6 Touch Panel Configuration	57
6.6.1 How to Change the Backlight Timeout and Brightness	57
6.6.2 How to Calibrate the Touch Panel	57
6.7 Latching Alarms	57
6.8 Remote Reset / Acknowledge / Inhibit Switch Options	60
6.9 Data Logging.....	60
6.9.1 To set or change Data Logging:.....	60
6.10 TPPL TCP/IP Address.....	61
6.11 Network Settings for WEB and MODBUS TCP.....	61
6.12 Modbus RTU Settings.....	62
6.13 Commission Input / Output Modules.....	63
6.14 Channel Configuration.....	63
6.14.1 Introduction.....	63
6.14.2 Configuring a Channel (mA Input and mV Input Channels)	64
6.14.3 Editing a Configured Channel	65
6.14.4 Editing mA Input Channel Settings.....	65
6.14.5 Editing mV Input Channel Settings.....	69
6.14.6 Editing Relay Output Channel Settings.....	71
6.14.7 Editing mA Output Channel Settings.....	73
6.15 Calibrating Input Channels	75
6.15.1 Adjusting the mV Sensor Baseline.....	75
6.15.2 Calibrating a mV Input Channel.....	75
6.15.3 Calibrating a mA Input Channel.....	77
6.16 Backing Up the Configuration Settings	79
6.16.1 How to Back Up the Configuration:.....	79
6.16.2 How to Restore the Configuration	80
Chapter 7. Touchpoint Plus User Guide	81

7.1 User Interface General	81
7.2 Touchscreen	82
7.3 Switching On and Off	82
7.4 Menu Items and Access Levels	83
7.4.1 Navigation – Active Access Level Icons	85
7.5 SD Card Usage	85
7.5.1 Checking the Capacity of the SD Card	86
7.5.2 Inserting or Replacing SD Cards	86
7.6 Normal Operation (Safety Functions)	87
7.7 Operating Overview	88
7.7.1 Touchscreen	88
7.7.2 User Interface Screen	88
7.7.3 Navigating the Channel Detail Screens	90
7.7.4 Navigation – Active Events and Filtering	91
7.7.5 Navigation – Menu	92
7.8 Responding to Alarms	93
7.8.1 Remote Reset and Acknowledge Switches	93
7.8.2 View Active Alarms	93
7.8.3 Accept or Acknowledge an Active Alarm	93
7.8.4 Reset a Latched Alarm	94
7.9 Event Information	94
7.9.1 Viewing Event Information	94
7.9.2 Accepting / Acknowledging Active Events	94
7.9.3 Resetting Latched Events	95
7.10 Inhibiting Channels	95
7.10.1 To Inhibit Input Channels:	95
7.10.2 To Clear Inhibits:	95
7.10.3 To Change Inhibit Timeouts	96
7.11 Viewing Input Channels and Input Details	96
7.12 Viewing Output Channels	98
7.13 Viewing the Trend Graph	99
7.14 Viewing and Exporting Event History	100
7.14.1 To View the Event History:	100
7.14.2 To Export the Event History:	100
7.15 Accessing the System Information and Service Contact Details	100
7.16 System State and System Failure Relays	100
7.17 Monitoring TPPL via the Optional Web Interface	101
7.17.1 Web Interface Configuration	101
7.17.2 Web Interface Navigation	103
Chapter 8. Routine Maintenance and Scheduled Testing	104
8.1 Routine Maintenance	104
8.1.1 Periodic Checks	104
8.2 Routine Testing	105
8.2.1 Exercising the Audio/Visual Alarms	105
8.2.2 Exercising the Relays	106
8.2.3 Checking the mA Outputs	106
8.2.4 Calibrating mV Input Channels	107
8.3 Periodic Scheduled Testing	109
8.3.1 Introduction	109
8.3.2 Field Inputs Test	110
8.3.3 Cause and Effect Test	110
8.3.4 LCD, LED and buzzer test	111
8.3.5 Reaction and response time test	111
Chapter 9. Repairs, Replacements and Upgrades	112
9.1 How to Decommission and Remove a Serviceable I/O Module	112
9.1.1 To Remove a Serviceable Module	112
9.2 How to Replace a Faulty I/O Module	113
9.2.1 To Replace a Faulty Module	113

9.3 How to Add a New I/O Module	114
9.3.1 To Add a New Module	114
9.4 How to Update the Sensor Catalogue	115
9.5 How to Backup / Restore the System Configuration	116
9.5.1 To Create a Backup File	116
9.5.2 To Restore the Configuration From a Backup File	117
9.6 How to Update Firmware	118
9.6.1 How to Check Firmware Compatibility	118
9.6.2 How to Update the Firmware	119
9.7 Back up Battery Maintenance	120
9.7.1 Recommended Backup Battery Maintenance	120
9.7.2 How to Replace the Backup Battery	120
9.8 Return to Factory Default Settings	121
9.8.1 To Reset the Touchpoint Plus to its Factory Default Settings	121
Chapter 10. Troubleshooting	122
10.1 Calling for Technical Support	122
Chapter 11. Technical Specifications	123
11.1 Environmental	123
11.2 User Interface and Main Module	123
11.3 I/O Modules	124
11.3.1 mA Input Module	124
11.3.2 mV Input Module	124
11.3.3 Dual Input Module	124
11.3.4 mA Output Module	125
11.3.5 Relay Output Module	125
11.3.6 Expansion Module	125
11.4 Power Supplies	125
11.4.1 External Supplies	125
11.4.2 Backup Battery	126
11.5 Enclosures	126
11.5.1 Wall Mount Enclosure	126
Chapter 12. Certifications	127
12.1 EU Declaration of Conformity	127
12.2 National and International Certificates of Compliance	127
12.3 European Performance Approval (DEKRA Testing and Certification GmbH) for Systems	128
12.3.1 Special Conditions for Use When Used for measurement of flammable gases	128
12.3.2 Special Conditions for Use When Used for Measurement of Toxic Gases or Oxygen	129
12.3.3 Special Conditions for software update	129
Chapter 13. Replacement Parts and Optional Extras	130
13.1 Spare Parts	130
13.2 Publications	131
Chapter 14. TPPL Configuration Code	133
Chapter 15. Icon Glossary	134
Chapter 16. Compatible Sensors	135
Chapter 17. Configurable Parameter Reference Guide	136
Chapter 18. Event Codes	147
Chapter 19. List of Figures	155
Chapter 20. List of Tables	157

Chapter 1. Important Information

The Equipment referred to in this manual contains components and assemblies that are each certified for use in a variety of differing environments, and it is the site owner's responsibility to confirm the suitability of the equipment prior to its installation and use.

The equipment is not only certified for flammable gas detection only but also for detection of oxygen and toxic gases.

Check the product rating plate and look for the following marks to ensure that the supplied equipment is suitable for its intended location and purpose:

1.1 Regulatory Approval Markings



Products bearing the CE mark conform to all applicable European Directives as stated on the Honeywell product specific EC Declaration of Conformity.



Products bearing the UL mark conform to the requirements for Ordinary Locations. The letters C and US mean that the product is additionally certified for use in Canada and the United States of America.

1.2 Additional Product Markings



Products bearing this mark must not be disposed of in domestic waste. They must always be taken to a specialist Waste Electrical and Electronic Equipment (WEEE) disposal or recycling facility. A box under the mark may show the type of hazardous material in the product, e.g. the letters Pb would show that the item contains Lead.



Products bearing this mark are recyclable and should not be disposed of as normal landfill waste.

1.3 TPPL Mandatory Warning

WARNING

FOR SAFETY REASONS THIS EQUIPMENT MUST BE OPERATED BY QUALIFIED PERSONNEL ONLY. READ AND UNDERSTAND THE INSTRUCTION MANUAL COMPLETELY BEFORE OPERATING OR SERVICING THE EQUIPMENT.

ATTENTION

POUR DES RAISONS DE SÉCURITÉ, CET ÉQUIPEMENT DOIT ÊTRE UTILISÉ, ENTRETENU ET RÉPARÉ UNIQUEMENT PAR UN PERSONNEL QUALIFIÉ. ÉTUDIER LE MANUEL D'INSTRUCTIONS EN ENTIER AVANT D'UTILISER, D'ENTREtenir OU DE RÉPARER L'ÉQUIPEMENT.

1.4 TPPL General Warnings

- 1) HIGH OFF-SCALE READINGS MAY INDICATE AN EXPLOSIVE CONCENTRATION
- 2) ONLY THE COMBUSTIBLE GAS DETECTION PORTION OF THIS INSTRUMENT HAS BEEN ASSESSED FOR PERFORMANCE PER CSA C22.2 No.152.
- 3) The equipment specified in this manual is only to be installed by the Manufacturer's trained personnel, or by competent persons trained in accordance with the Manufacturer's installation instructions.
- 4) Installation must be in accordance with the recognized standards of the appropriate authority in the country concerned. Refer to local, national and company regulations.
- 5) Do not operate the Touchpoint Plus system or its components outside of their rated operating specification.
- 6) Touchpoint Plus must not be operated in Oxygen enriched atmospheres, i.e. greater than 25% v/v Oxygen.
- 7) All equipment containing a User Interface must be suitably protected from direct sunlight and rain.
- 8) Power Supply Fluctuations are not to exceed DC 18 – 32 V SELV Supply or $\pm 10\%$ of nominal.
- 9) All versions of Enclosure apparatus are electrical Class 1, and must be connected to Protective Earth (Ground).
- 10) The Touchpoint Plus installation must include a means of isolating or disconnecting the input voltage supply. The isolation or disconnection device must be conveniently located close to the system and be clearly labelled. For an AC mains voltage supply, the isolation or disconnection device must disconnect both the line and neutral poles, but maintain earth (ground) continuity.
- 11) The Touchpoint Plus input voltage supply must include over-current protection.
- 12) All cabling must be appropriately rated and approved in accordance with local, national and company regulations, and suitable for the installation. Additionally, cabling must satisfy requirements defined in the manuals of connected field devices, in particular if the field device is certified for use in a hazardous location.
- 13) All signal cables and interconnections must be shielded and the shields terminated only at the unified earth (ground) bus bar situated inside the enclosure
- 14) All conduits and cable armour shall be bonded to protective earth (ground), and care must be taken to avoid ground loops and to avoid contact with cable shielding.
- 15) Cable entry glands, blanking plugs, reducers, adaptors and breather devices must be suitably approved and must not reduce the IP rating or protection levels. Items should not be used if there is a high risk of mechanical damage to the equipment or enclosure.
- 16) Access doors and entry points must be kept closed when the system is energised in normal operation.
- 17) The TPPL Enclosures must be securely closed and the locking handle security screws must be fully tightened during normal operation.
- 18) All equipment in this manual is rated to +2000 m (6562 ft) altitude maximum.
- 19) For safety reasons this equipment must be operated by qualified personnel only. Read and understand the Instruction Manual completely before operating or servicing the equipment.
- 20) Touchpoint Plus systems may contain hazardous live terminals. Appropriate precautions should be taken during operation, installation, and maintenance and servicing. Specifically, operators must have appropriate training and experience to be aware of the hazards to which they may be exposed, and of measures to minimise risk to themselves or other people.
- 21) The protection provided by TPPL may be impaired or lost if the equipment is installed or used in an incorrect, unspecified or unauthorised way.
- 22) Be aware that extended exposure of a detector element to certain concentrations of combustible gases and air can introduce stress to the element that may seriously affect its performance, and therefore recalibration should be carried out or the sensor replaced, or both, after an alarm due to an indication of a high concentration.
- 23) When used in a Gas Detection summing up role, the gas reading may be higher than the actual concentration at any one detector head location, or it may be the actual concentration at one specific detector head.
- 24) Exposure to some chemicals may degrade the sealing properties of materials used in the alarm relay.
- 25) Do not open TPPL enclosures or disconnect/reconnect equipment until power has been isolated and the area is made safe / non-hazardous. This includes replacing backup batteries.
- 26) Substitution of any components may impair suitability for Class I, Division 2.
- 27) Touchpoint Plus oxygen detection is intended for measurement of oxygen deficiency and enrichment. Do not use for oxygen inertisation.

1.5 TPPL General Cautions

- 1) Touchpoint Plus SMPS, Input and Output Modules have no user serviceable parts. In the unlikely event of a failure, the item must be replaced using only manufacturer supplied parts.
- 2) Do not use sharp objects to operate the Touchscreen as this could irreparably damage the User Interface and adversely affect its IP rating.
- 3) Use only soft, damp cloths or screen wipes to clean the Touchpoint Plus. Do not use solvents or abrasives as they will cause irreparable damage.
- 4) Once commissioned, Touchpoint Plus is intended for continuous operation.
- 5) Undo the security screws before pulling the locking handle. Failing to do so may irreparably damage the enclosure.
- 6) Do not place any objects on top of the enclosures as this may cause overheating and may cause the enclosure to fall from the wall.

1.6 How to Use this Manual

1.6.1 Intended Readers

This Manual should be read by everyone who operates or monitors the Touchpoint Plus gas detection system.

Only personnel who have been fully trained by Honeywell are authorised to Install, Set-up, Service, and Test, Repair, or Recondition Honeywell gas detection systems.

IMPORTANT

Personnel, who work on, or in the area of, the Touchpoint Plus Gas detection system must be made aware of the contents of Chapter 2 – Safety Hazards, Warnings and Cautions.

Before unpacking the system, read carefully the accompanying documentation.

1.6.2 Conventions Used

The following conventions are used in this manual:

Boot up refers to the action of starting the software from cold.

Menu>Configuration>Channel highlights a sequence of commands (including button touches).

mV Sensor refers to a mV Bridge Sensor.

Reboot refers to shutting down and restarting the software without interrupting the power supply.

Restart refers to cycling the power off and then on again.

SELV refers to Safety Extra-Low-Voltage devices.

[Start] highlights unique button touches.

Start up refers to the action of switching on the system.

Touch refers to all direct interactions with the Touchscreen, whether by finger or stylus.

TPPL refers to the Touchpoint Plus Gas Detection System.

1.6.3 Associated Manuals

This TPPL Technical Handbook should be used in conjunction with ancillary component and field device user guides or documentation.

This TPPL Technical Handbook (MAN 0984) is available in the following languages:

- English (UK) Pt. Nr. 3011M5001

The supplementary TPPL Modbus Installation and Setup Guide (Pt. Nr. 3011M5027) is available in English only, and is recommended for OEMs and Modbus specialists only.

Note: Refer to Chapter 16 for a list of remote sensors. Refer to the manuals and instructions relevant to the gas sensors and detectors working with Touchpoint Plus.

Chapter 2. Safety Hazards, Warnings and Cautions

2.1 Safety

Incorrect set-up, maintenance, operation or modification of the Touchpoint Plus gas detection system or its installation may constitute a serious hazard to the health and safety of personnel and their environment. It is therefore imperative that the contents of this chapter are thoroughly understood by everyone who has access to the gas detection system or its associated equipment.

When properly installed, this gas detection system enclosure is rated as IP65.

It may be installed in a Pollution Degree 2 (i.e. laboratory, office or control room) or Pollution Degree 3 (i.e. unheated boiler room) environment as defined by IEC/UL/EN 61010-1: Safety requirements for electrical equipment for measurement, control and laboratory use.

In all cases, several hazards may be present when operating or servicing the equipment and extreme caution must be exercised at all times. The hazards that may be encountered include:

- Class 1 electrical hazards (AC 110/220 V, DC 18–32 V)
- Mechanical hazards (Heavy components, swinging access doors, locking handles etc.)
- Environmental hazards (toxic atmospheres)
- Fire and Ignition hazards

DANGER

Touchpoint Plus is **not ATEX/IECEx certified**, and it shall only be installed in safe areas where there are no flammable atmospheres, and where oxygen concentrations cannot exceed 25% v/v O₂.

Touchpoint Plus is suitable for use in Class I, Division 2, Groups A, B, C, and D, or non-hazardous locations only.

2.1.1 Warnings and Cautions

Safety of this equipment is reinforced by the use of safety labels that are fixed to the equipment in a visible manner. The labels used and their location is detailed in Ch.2.2.1 Safety Warning Labels.

Other likely hazard occurrence and severity is indicated throughout this manual by the use of signal words accompanied by a hazard description and an internationally recognisable hazard symbol, as shown in the three example boxes below:

DANGER

Danger indicates an **imminent hazard** that, if not avoided, is **extremely likely to result** in death or serious injury.

WARNING

Warning indicates a **potentially hazardous** situation that, if not avoided, **could result** in death or serious injury.

CAUTION

Caution indicates a **potentially hazardous** situation that, if not avoided, **may result** in minor or moderate injury. It is also used to alert the user against unsafe working practices and potential damage to equipment.

2.1.2 Safety Hazards

The following specific hazards are associated with the installation and use of this equipment:

DANGER – IGNITION HAZARD

Touchpoint Plus is Not ATEX/IECEx certified, and it shall only be installed in safe areas where there are no flammable atmospheres, and where oxygen concentrations cannot exceed 25% v/v O₂.

Touchpoint Plus is suitable for use in Class I, Division 2, Groups A, B, C, and D or non-hazardous locations only.

WARNING – LITHIUM BATTERY HAZARDS

Lithium batteries may cause severe injury or death if swallowed, and may catch fire or explode if mishandled, recharged, burned or disposed of incorrectly.

Always handle batteries with care, keep them out of the reach of children, and dispose of them carefully in accordance with local regulations.

Batteries (regardless of type) shall only be handled, fitted, removed or replaced in non-hazardous (safe) areas.

WARNING – LETHAL VOLTAGE PRESENT

All power supplies must be hard wired and must include a circuit breaker (RCD / RCCB) and, close by and unobstructed, a means of manually isolating and locking-out the power supply without breaking the protective earth (ground) connection.

Removable plug/socket connection is not permitted under any circumstance.

WARNING – LETHAL VOLTAGE PRESENT

Lethal current may be present in this equipment when electrical power is applied and after it is removed. There is a risk of death or injury from electrical shock when access doors are open.

Isolate power before opening electrical access panels. Ensure residual current is fully discharged before touching live terminals.

WARNING – LETHAL VOLTAGE PRESENT

Lethal current may be generated both internally and externally to the system. All installations, including enclosures and external units, must be grounded to protective earth, and must be capable of staying earthed (grounded) when the power supply is interrupted.

The Protective Earth (Ground) symbol is shown to the left, and it always has a green background. Do not confuse it with the chassis earth and equipment earth symbols shown below it.

WARNING – TOXIC WASTE AND HARMFUL BY-PRODUCTS

The Touchpoint Plus system and/or its sensors may become contaminated by the ambient environment in which it or they are used. It is the Customer's sole responsibility to ensure that all appropriate safety precautions are taken before handling any components or transferring them to any other party.

2.1.2 Safety Hazards (Cont.)

The following general hazards are associated with the use of this equipment:

WARNING – FIRE OR EXPLOSION HAZARD

Batteries may explode if mistreated. Do not disassemble them or dispose of in fire.

WARNING – DO NOT USE WATER

DO NOT USE WATER if a lithium battery overheats or burns, as it may make the fire worse and it may cause an explosion.

Evacuate the area immediately and call Emergency Services.

CAUTION – HEALTH AND ENVIRONMENTAL HAZARDS

This equipment contains a number of potentially toxic substances that may pose a health or environmental hazard if exposed to very high temperatures, VOCs or corrosives, or if improperly handled or disposed of.

CAUTION – RISK OF INJURY AND DAMAGE

Each Touchpoint Plus enclosure is heavy and weighs considerably more when packed. Ensure that a Manual Handling Risk Assessment is carried out before moving or installing the system, and ensure that enclosures are fitted securely to a suitable vertical surface. Do not place objects on the enclosures.

CAUTION – RISK OF EYE INJURY

Touchpoint Plus uses high energy AC and DC currents that may cause arcing and sparks if shorted out. Always wear eye protection when the enclosure is open.

CAUTION – RISK OF HEARING DAMAGE

Touchpoint Plus can be used to control loud alarms and sirens. Always wear hearing protection when working in the vicinity of loud or high-pitched noises.

CAUTION – RISK OF EQUIPMENT DAMAGE

Touchpoint Plus houses static-sensitive components. Always isolate power and discharge circuits before touching internal components. Always take anti-static precautions.

CAUTION – RISK OF INJURY OR DAMAGE

Always follow a Safe System of Work when carrying out any work involving Safety Systems.

2.2 Location and Description of Warning Labels

2.2.1 Safety Warning Labels

In accordance with the requirements of European Standard EN 60825-1, appropriate warning labels are mounted in specified locations on the equipment. This is to indicate conditions under which the user could be subjected to electrical hazards.



Figure 1. Quick Start Guide Label (Not to Scale)



Figure 2. Rating Label (External – Not Shown Below)



Figure 3. Protective Earth (Ground) Point



Figure 4. Equipment Earth (Ground) Point

This Protective Earth (Ground) location point label is used inside the system and is not normally visible to the operator.

This Equipment Earth (Ground) location point label is used inside the system and is not normally visible to the operator.



Figure 5. Internal Label Positions

2.3 Electrical Hazards

Gas detection systems contain electrical supplies that are potentially dangerous and hence suitable precautions must be taken to prevent the risk of electrocution. This is especially important when untrained/unqualified persons are allowed to open the enclosure (e.g. to access/remove/refit the SD Card).

2.3.1 General Safety Precautions

- Read the relevant manual before beginning any operating or service procedures.
- Only personnel trained and certified by Honeywell are authorised to service, fit or remove internal parts.
- Only the minimum number of trained personnel, consistent with safety, should have access to the area while work is being carried out. If necessary, erect warning signs and barriers.
- Follow accepted working procedures and codes of practice as well as the electrical safety code for the site where the equipment is installed.
- Never operate the equipment under normal conditions with doors open, access panels removed or shorting links fitted.
- Do not 'Live Test' without a Safe System of Work (SSoW).
- Always keep the area around the equipment dry and free of obstructions.
- Switch off and Isolate the equipment if water ingress is suspected or confirmed.
- Never operate the equipment if any Mains power cable is frayed or damaged.
- Never wear wristwatches, rings, bracelets, or other jewellery when working around electrical circuits or moving parts.
- Take anti-static precautions when working on electronic circuits.
- Never work on electrical equipment alone.

2.3.2 Component Testing and Replacement

Before carrying out any electrical testing or component replacement:

- Read this Manual to become familiar with the location of high voltage components.
- Isolate the system at the main circuit breaker, lock it in the 'Off' position, and attach a notice indicating that maintenance work is in progress.
- Always wait for 5 minutes after isolating the equipment to ensure that stored energy has dissipated.
- Never assume the polarity of cabling or replacement components. Refer to electrical schematics or contact Honeywell for confirmation.
- Use only Honeywell approved replacement parts.

WARNING – UNAUTHORISED PERSONNEL

Only Honeywell trained and certified maintenance technicians are authorised to carry out component testing and replacement. Unauthorised work may result in a potentially dangerous situation and will invalidate the manufacturer's warranty.

ANTI-STATIC PRECAUTIONS

Antistatic Precautions are required to prevent severe damage to electronic components.

Antistatic Precautions

As with all modern electronic circuits, the Printed Circuit Boards (PCBs) in Touchpoint Plus systems utilise some static-sensitive components that can be severely damaged if subjected to static discharge. Static can be generated on the human body by friction or movement and is discharged through the first contacted route to earth. It can also jump gaps between items of differing electrical potential.

Static damage is not always immediately apparent and can cause component failure at any time after the static discharge has occurred. It is, therefore, very important that everyone takes the following precautions when handling PCBs:

- An industry approved antistatic wrist strap, containing a resistive component greater than 1Megohm, must be worn and connected to an effective earth (ground) point. The continuity between the strap and earth (ground) must be checked regularly.
- PCBs must only be handled by their non-conductive edges. Do not allow any components, conductive tracks or contacts to come into proximity with the body, clothing, machinery, power source or any material other than a static-dissipative mat.
- With the exception of assemblies containing batteries, anti-static packaging must be used for transporting PCBs and Integrated Circuits (ICs). All Touchpoint Plus electronic components are shipped in appropriate packaging that can be re-used when returning items for test or repair.
- Avoid wearing clothing manufactured from, or containing a high proportion of, man-made fibres. These can build up a high static potential that may not be discharged through the body or wrist strap.

An effective earth (ground) point is the protective earth (ground) bus bar inside the enclosure. This can be used to connect a suitable anti-static wrist strap provided that the Gas detection system is connected to protective earth (ground) via the mains power supply cable.

IMPORTANT

If installed correctly, the equipment earth (ground) point is connected directly to mains earth (ground) via protective earth and the mains power supply cable, and the earth (ground) circuit cannot be broken by operating the Isolator switch or circuit breaker.

2.3.3 Good Practice

After switching off the system, it is good practice to wait at least 15 seconds before switching it on again. This allows the circuits and RAM to discharge adequately before being powered-up again. Failing to do so may cause data corruption.

2.3.4 Lithium Battery Hazard

Lithium batteries are fitted to Touchpoint Plus as backup power sources.

Replace the factory installed battery pack TPPL0IBB with Honeywell Analytics Asia Pacific replacement battery pack part no. TPPLSIBB and the PCB CMOS battery with type CR2032 only.

Use of other batteries may present a risk of fire or explosion.

LITHIUM BATTERY TOXIC AND FIRE HAZARDS

Lithium batteries may cause severe injury or death if swallowed, and may catch fire or explode if mishandled, recharged, burned or disposed of incorrectly.

Always handle lithium batteries with care, keep them out of the reach of children, and dispose of them carefully in accordance with local regulations.

Batteries shall only be fitted, removed or replaced in non-hazardous (safe) areas.

2.3.5 Product Compliance

This product complies with the following standards and directives.

Other safety directives may apply to the complete system installation if an OEM's product is integrated into other equipment or machinery.

Safety	Compliance
Hazardous Location (Non-Incendive)	Class 1, Division 2, Groups A,B,C,D, Temp. Code T4 ISA 12.12.01-2013 CSA C22.2 No. 213-M1987
Electrical Safety	CAN/CSA C22.2 No. 61010-1 and No.142 UL 61010-1 (3 rd Edition); UL508 IEC/EN 61010-1 (3 rd Edition)
EMC/RFI	EN 50270
Low Voltage Directive	IEC/EN 61010-1 (3 rd Edition)
Gas Performance*	ISA 12.13.01 and CSA C22.2 No. 152 EN 60079-29-1, EN 50104, EN 45544-1/2/3 and EN 50271

* ISA 12.13.01 and CSA C22.2 No.152 approvals are applicable only to mV sensors Model 705 and MPD or any suitably certified mA sensor.

* EN 60079-29-1 approval is only valid for operation with Sensepoint, Sensepoint HT, Sensepoint ppm and a certified 4-20 mA transmitter.

Note: The Equipment referred to in this manual contains components and assemblies that are each certified for use in a variety of differing environments, and it is the site owner's responsibility to confirm the suitability of the equipment prior to its installation and use.

Check the product rating plate and look for the following marks to ensure that the supplied equipment is suitable for its intended location and purpose:



Products bearing the CE mark conform to all applicable European Directives as stated on the Honeywell product specific EC Declaration of Conformity.



Products bearing the UL mark conform to the requirements for Ordinary Locations. The letters C and US mean that the product is certified for use in Canada and the United States of America.

IMPORTANT

Read and understand the instruction manual before operating or servicing the equipment.

Conditions of Use

This Touchpoint Plus equipment shall only be operated:

- By properly trained personnel.
- Under Honeywell approved conditions.
- With due authorisation.
- Using approved maintenance and servicing procedures.

2.3.6 Training of Personnel

Honeywell and / or its distributors can provide training for operators and maintenance personnel. Personnel who have been trained in operation and maintenance shall be limited to carrying out only those procedures and tasks taught during the training course. Honeywell certified maintenance technicians must carry out all other tasks.

Honeywell can also provide additional or advanced training. Retraining is recommended periodically and whenever the equipment / installation is changed or upgraded.

2.3.7 Conditions Satisfying Local, National and International Safety Regulations

Approved conditions must satisfy the requirements of applicable national and international safety standards and statutory requirements relating to electrical, EMC, and health hazards. In addition, they must satisfy the requirements of the Site Safety Officer and the local safety regulations.

2.3.8 Approved Maintenance and Servicing Procedures

Approved Maintenance and Servicing Procedures are those stipulated in this manual or as authorised separately by Honeywell.

It may be necessary to establish a temporary Locally Controlled Area (LCA) to restrict access during maintenance, testing or servicing of this equipment.

2.4 Security guide

Establishing an Ethernet connection to the Touchpoint plus may expose the system to vulnerabilities. Honeywell recommends against connecting the Touchpoint plus to untrusted computers or equipment without taking appropriate measures to ensure security.

2.5 Firmware and EEPROM update

User is responsible for verification of all settings of Touchpoint Plus after successful update of software (e.g. Ch 6.16.2 How to Restore the Configuration, Ch 9.5.2 To Restore the Configuration From a Backup File and Ch 9.6.2 How to Update the Firmware). It is highly recommended to verify all settings are correct after software update. Follow Honeywell's software update guideline or contact Honeywell for any support in software update.

Chapter 3. System General Description



Figure 6. Touchpoint Plus Wall-Mounted Controller

The Touchpoint Plus is an entry level (or upgrade) touch-screen digital Controller for general industrial and commercial gas detection systems. It has eight input channels, with a further eight channels available through an optional expansion unit (see Note below).

It can handle a wide range of milliamp, millivolt, and catalytic sensors through analogue inputs, and it can control various outputs such as audible and visible signals and solenoid valves.

The cabinets are constructed from high-impact plastic and have fully-sealed, easy opening access. They are supplied with a wall mounting or can be directly mounted to any solid vertical surface or rack. Cable entry is via entry glands on the lower side.

Touchpoint Plus is rated IP65, which means that it is dustproof and can be subjected to low-pressure water without significant ingress. This makes it particularly suited to offices, control rooms and unheated boiler rooms.

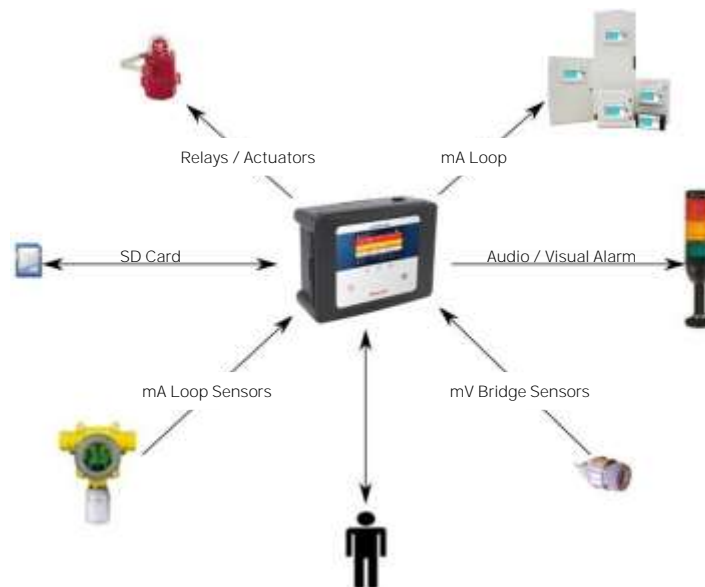

Figure 7. Typical Installation Options

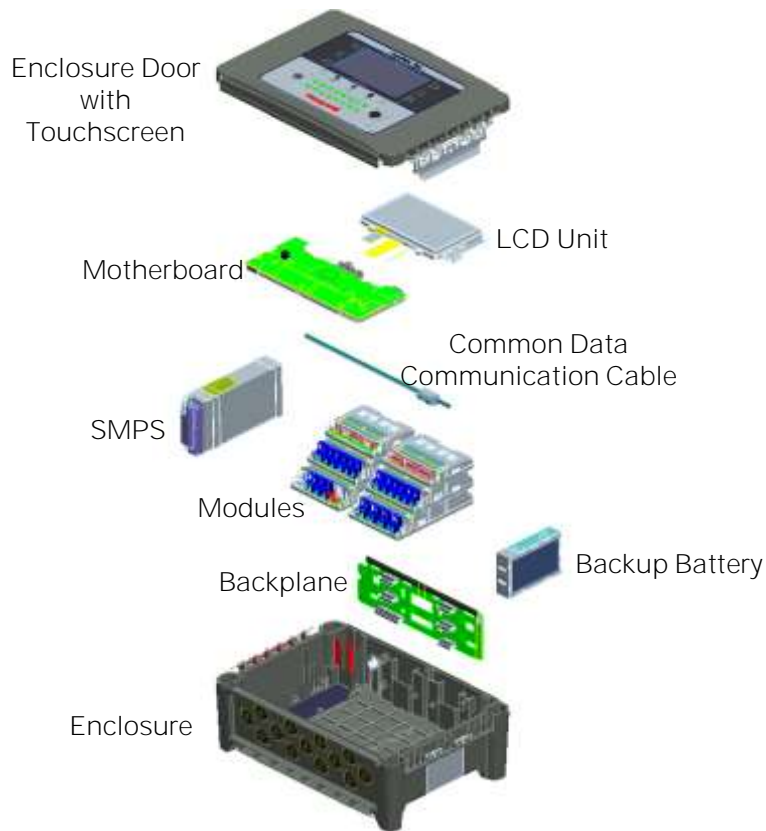

Figure 8. TPPL Controller Exploded View

Both the Touchpoint Plus and its optional expansion unit have the option for AC, DC and battery backup power supplies, but the optional Expansion Unit has no motherboard or display (LCD).

Features of the Controller unit:

- colour LCD Touch Screen with multi-language user interface and menus
- password protection
- flexible Mains Power Input: 50 – 60 Hz 110/220 V ~ (AC), 18 – 32 V $\overline{\text{---}}$ (DC), Max 107 W for a single unit or 210W for combined Base and Expansion Units
- up to 8 channels of Analogue Input (0–22 mA loop input or Bridge mV for Cat bead or Dual input)
- 2 or 3-wire signal inputs
- up to 24 channels of user configurable relay controlled Output
- up to 8 channels of configurable mA Output
- alarm update on Acknowledge
- automatic Self-Diagnostic Event Log with error codes
- event recording
- SD Card

3.1 How to Open and Close the Enclosure

- 1) Ensure that it is safe to open the enclosure and, if necessary switch off and isolate electrical power.
- 2) Unscrew the two x 3 mm Hex socket security screws (1) until they become loose (2).
- 3) Pull the handle until it comes free (3). Do not apply undue force.
- 4) Open the enclosure door fully.



Figure 9. Undoing the Two Security Screws and Opening the Enclosure

- 5) Closure is the reverse of this procedure, but care must be taken not to exert undue force, and you must not press on the membrane or touch screen areas.

Note: The door recess has an environmental seal that requires some pressure to close the door correctly. The enclosure handle is the primary method of applying this pressure but you can assist it by pressing firmly on the door edge directly above the handle as you press on the handle itself.

CAUTION

TPPL enclosures must be fully closed and secured during normal operation.

3.2 Equipment Specification

3.2.1 Power Requirements (Controller Unit only)

The Touchpoint Plus system is designed to operate on a single phase, 50 to 60 Hz, 110/220 V- (AC) supply with a typical power consumption of less than 107 W.

Alternatively it can be connected to an 18–32 V $\overline{\text{DC}}$ (DC) supply with typical power consumption less than 107 W.

The system can contain an optional backup battery to guard against short-term power disruption.

Nr.	Power Usage	Module Qty	Power	Total Power (Max) W			Remarks
				mA in	mV in	Dual in	
1	UI Module	1	3.4	3.4	3.4	3.4	
2	Main Module	1	1.0	1.0	1.0	1.0	
3	mA Input Module	1	0.3	0.3			8 ch, not including Field Device power
	mA input Field Devices	-	40	40		20	Field Device power (8 ch* 5W) Field Device power (4 ch* 5W)
	mV Input Module	1	18.5		18.5		8 ch
	Dual Input Module	1	9.4			9.4	4 ch mA and 4 ch mV
4	mA Output Module	2	4.2	8.4	8.4	8.4	
5	Relay Output Module	2	2.5	5.0	5.0	5.0	
6	Charging power for backup battery pack	1	6	6	6	6	
7	Audio/Visual Alarm	-	28.8	28.8	28.8	28.8	When alarm devices are connected
8	SMPS Power Loss	-	14.0	14.0	14.0	14.0	
MAXIMUM CONSUMPTION				107	85	96	

Table 1. Maximum Power Consumption Calculations

Input	Voltage Range AC	AC 110/220 V manually switchable 300 VAC surge for 5 sec without damage
	AC Frequency Range	50 – 60 Hz \pm 6%
Output	DC Voltage	24 V
	Rated Current	6.5 A
	Current Range	0 – 6.5 A
	Rated Power	156 W
Protection	Overload	110 – 150 % rated output power
	Over-Volt	27.6 – 32.4 VDC Hiccup mode, which recovers automatically when the fault is removed.

Table 2. Power Supply (SMPS RS–150–24) Electrical Ratings

3.2.2 Weights

Note: Based on one input module, two mA output modules, two output relays, power supply and backup battery for the basic unit and expansion unit respectively.

	TPPL Basic Unit	TPPL Expansion Unit
System alone	8.5 Kg (18.7 lbs)	8 Kg (17.6 lbs)
System with packaging	9 Kg (20 lbs)	8.5 Kg (18.7 lbs)

Table 3. System Weights

3.2.3 Dimensions

External Dimension	Millimetres	Inches
Depth	156	6.2
Length	426	16.9
Width	300	11.8

Table 4. System Dimensions

3.2.4 Ambient Operating Temperature

-10 °C to +55 °C (14 °F to 131 °F)

3.2.5 Overall Ambient Operating Humidity

5 % to 95 %RH, non-condensing

3.2.6 Storage Conditions (Without batteries)

-25 °C to +60 °C (-13 °F to 140 °F), @ 5 % to 95 %RH, non-condensing

3.2.7 Storage Conditions (With batteries)

1 year: -20 °C to +25 °C (-4 °F to +077 °F)
 3 months: -20 °C to +45 °C (-4 °F to +113 °F)
 1 month: -20 °C to +60 °C (-4 °F to +140 °F)

3.2.8 IP Rating

The enclosures are sealed to IP65 when appropriate cable entry glands are used.

3.2.9 Construction

The system cabinets are constructed from PC ABS plastic with a secured quick release front access door panel.

The Controller door panel holds a touch sensitive colour LCD with a membrane cover over additional buttons, LEDs and an audible warning horn.

Inside the Controller cabinet is a Switched-Mode Power Supply (SMPS) providing a nominal DC 24 V output, an optional Lithium-ion backup battery, a Main Module, a mA/mV Input Module, two mA Output Modules, two Relay Modules, protection fuses, and the control and user interface electronics.

The optional expansion unit holds the same modules and optional backup battery, but has no controller or user interface.

Both enclosures contain a common Earth (ground) rail that must be bonded to Protective Earth (Ground) through an isolation switch that does not disconnect the Earth line.

3.2.10 Touchpoint Plus Packaging

- Touchpoint Plus outer packaging is made from cardboard. Facilities for recycling are widely available.
- Touchpoint Plus inner packaging is made from Stratocell®, Low-Density Polyethylene (LDPE) foam. The foam can be recycled into new Stratocell® where such recycling facilities exist.

3.2.11 Packaging Components for Return to Manufacturer

Honeywell is unable to accept any consignment that does not conform to the European Classification, Labelling and Packaging (CLP) Regulations (EC) 1272/2008.

Consult your distributor, supplier, or the manufacturer if you require further advice.

3.2.12 Disposal (WEEE Directive)



The system contains Lithium batteries and a number of homogenous hazardous materials. These should be disposed of carefully in accordance with the WEEE Directive and local laws and guidelines. Under no circumstances can they be disposed of as domestic waste.

3.3 TPPL Construction

The TPPL system consists of a basic Control Unit and an optional Expansion Unit, as shown below.

3.3.1 TPPL Basic Control Unit

This figure shows the building blocks of the basic Touchpoint Plus system.

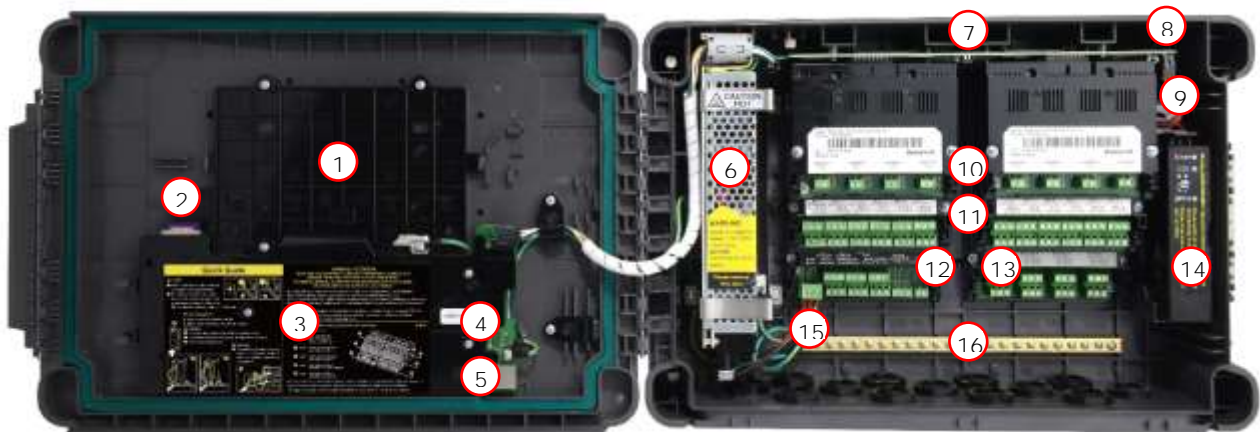

Figure 10. Controller Unit Layout Before Installation

1	Touchscreen assembly	9	Battery Connector
2	SD Card	10	mA Output Modules
3	Motherboard	11	Relay Output Modules
4	Modbus Terminals (option)	12	Main Module
5	Ethernet Connector	13	Input Module (mA/mV/Dual)
6	Switched Mode Power Supply	14	Backup Battery
7	DIP Switch (on backplane)*	15	Power Terminal
8	Battery On / Off Switch	16	Earth (Ground) Bus Bar

* The DIP Switch (7) is used to enable / disable the optional expansion box. See Ch.3.3.3 TPPL DIP Switches.

3.3.2 TPPL Expansion Unit

This figure shows the building blocks of the Touchpoint Plus Expansion Unit.

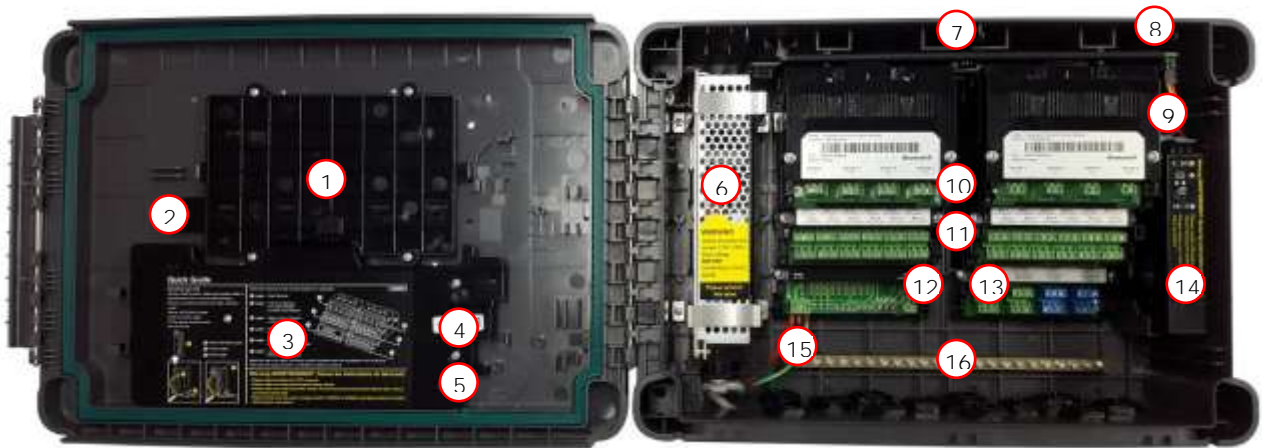

Figure 11. Expansion Unit Layout Before Installation

1	Touchscreen not fitted	9	Battery Connector
2	SD Card not fitted	10	mA Output Modules
3	Motherboard not fitted	11	Relay Output Modules
4	Modbus not fitted	12	Main Module (Power and CAN only)
5	Ethernet Connector not fitted	13	Input Module (Dual shown)
6	Switched Mode Power Supply	14	Backup Battery
7	DIP Switch (on backplane)	15	Power Terminal
8	Battery On / Off Switch	16	Earth (Ground) Bus Bar

3.3.3 TPPL DIP Switches

TPPL Backplanes have a DIP switch (item 7 in the figures above) that controls the interaction between the master (basic) and the optional expansion unit backplanes. Once set these DIP switches need not be altered.



Figure 12. Backplane DIP Switch Settings

Chapter 4. System Mechanical Installation

The system can be directly wall-mounted or on an optional mounting fixture. Whichever method is chosen, the mounting must be sound, secure, and capable of supporting the weight of the enclosure plus the weight of any cables and glands.

When choosing a location, it must be easily visible and accessible, with room to mount an external power isolator. There must also be room to fully open the access door, which opens to the left, and room to easily access the door locking handle and its securing screws, which are situated on the right. If using the optional expansion unit there must be sufficient room between them to access the locking handle and its securing screws.

The units should be mounted so that the screen can be easily accessed and seen, but they should not obstruct accesses, walkways or exits.

Protect the unit from heat sources, direct sunshine, rain, severe weather, steam or excess humidity and condensation.

Assembly	IP	NEMA	Pollution Degree	Remarks
Wall mounted cabinet	65	4X indoor	2	When properly installed using the appropriate cable entry glands

CAUTION

It is the Customer's responsibility to ensure that the equipment is correctly installed, and that cable entry glands or blanks of the appropriate IP rating are correctly used.

Failure to do so will invalidate the quoted IP / NEMA / Pollution ratings and may invalidate the warranty.

CAUTION

The units as supplied have two hex-socket securing screws in the access door handle, and these have to be fully unscrewed prior to opening the handle. Failing to do so could cause irreparable damage to the housing.

The handle must be correctly locked and the screws must be correctly tightened when the unit is in normal operation. Failing to fully secure the enclosure is unsafe and will invalidate product certification.

4.1 Wall Mounting Requirements

For details and drawings refer to Honeywell Analytics website at www.honeywellanalytics.com.

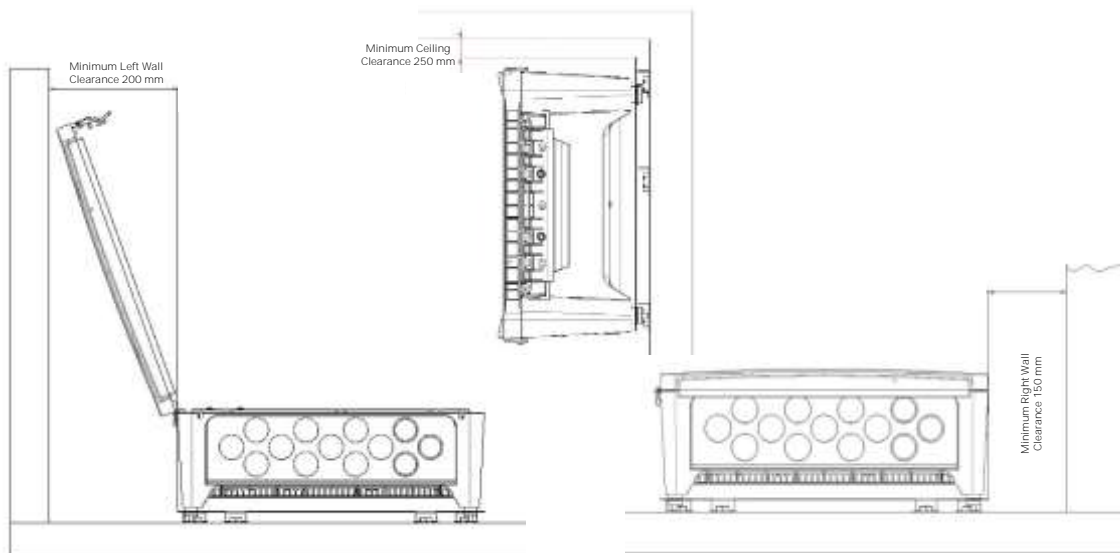

Figure 13. Installation Clearance Measurements

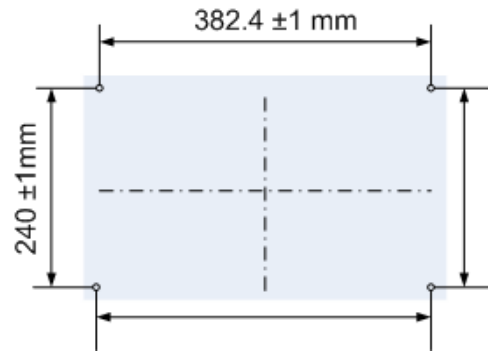

Figure 14. Wall Mounting Template

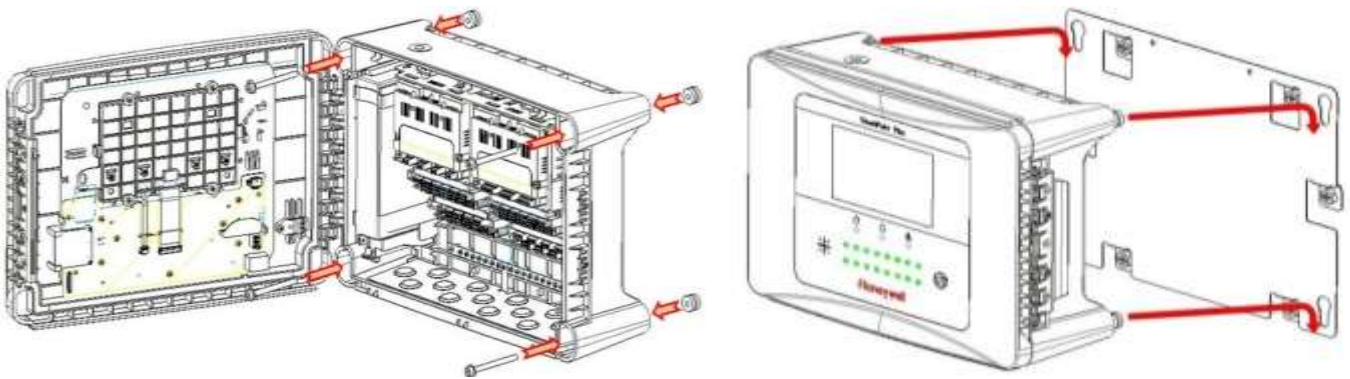

Figure 15. Wall and Plate Mounting Points

You can use the wall mounting plate as its own template and location guide, and you should ensure that the mounting bolts are adjusted to fit the plate bayonet holes before fixing the plate to the wall. The mounting nuts should be torqued to 1.18 - 1.76 Nm (10.42 - 15.62 lb-in).

Chapter 5. Electrical Power Connection and Interfacing

WARNING – ELECTRICAL SHOCK HAZARD

All power supplies must be hard wired and must include a circuit breaker (RCD / RCCB), and (close by and unobstructed) a means of manually isolating and locking out the power supply without breaking the protective earth (ground) connection.

Removable plug and socket connection is not permitted under any circumstance.

WARNING – ELECTRICAL SHOCK HAZARD

Lethal current may be present in this equipment when electrical power is applied. There is a danger of death or injury from electrical shock. Isolate power before opening electrical access panels. Ensure residual current is fully discharged before touching live terminals.

WARNING – ELECTRICAL SHOCK HAZARD

Lethal current may be generated both internally and externally to the system. All installations, including remote units and cables, must be connected to protective earth, and must be capable of remaining so when the power supply is interrupted.

Protective earth is shown by the green symbol on the left.

WARNING

Honeywell can accept no responsibility for any damage or injury caused by incorrect or faulty wiring. It is the customer's responsibility to provide appropriate power supplies to the TPPL and detectors.

5.1 Power Connection

Every TPPL Controller and Expansion Unit is factory set to operate at a manually switchable voltage of AC 110/220 V on single phase, 50 to 60 Hz power supplies. They can also be connected to DC 18 – 32 V SELV supplies with their backup battery removed, or DC 24 – 32 V SELV supplies with a battery fitted (24 V is the battery's minimum charging current).

TPPL Controller and Expansion Units each have a typical power consumption of less than 107 W, and they must be directly connected to power supplies via a Main Isolator Switch that leaves protective earth (ground) permanently connected. The circuit should incorporate a Residual Current Device (RCD) or Residual Current Circuit Breaker (RCCB).

TPPL systems are not certified for connection to domestic or fluctuating power supplies.

WARNING

The system is normally supplied with the voltage pre-set to the customer's specification. Before connecting to Mains Power check the **power supply** voltage setting and correct as necessary. Remove the yellow label when done.

5.1.1 AC Power Supply

To confirm or alter the pre-set operating voltage, open the system front cover, locate the SMPS on the left side and, if required, change the voltage selector using a screwdriver at the point shown at the top of the yellow and black label.

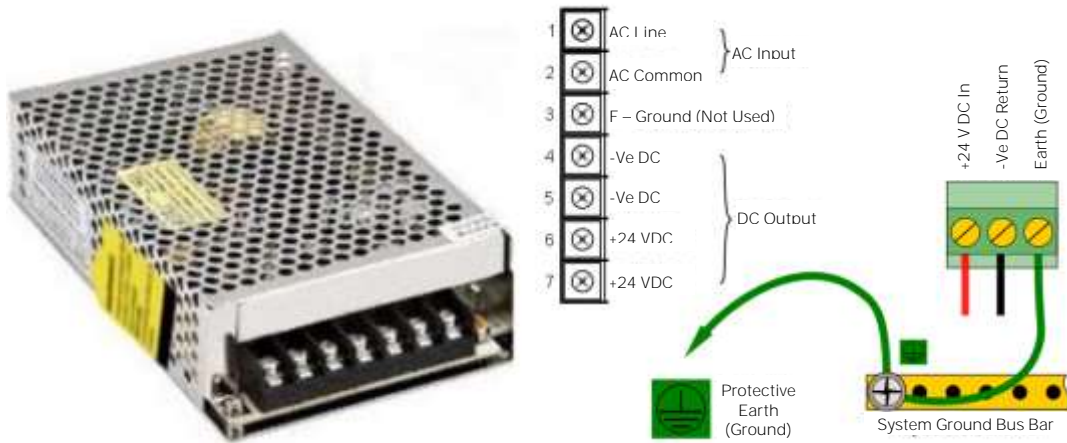

Figure 16. Switched Mode Power Supply (SMPS) Connections

Note: Mains Earth (Ground) must only be connected to the protective earth (ground) rail, and not to the SMPS.

Regional power cable wires are coloured in accordance with the following code:

Wire	Europe	USA	CAN	India/Pakistan
Protective Earth (Ground)	Green + Yellow	Green	Green	Green
Isolated Earth (Ground)	—	Green + Yellow	Green	—
Neutral	Blue	White	White	Black
Line	Brown	Blue, Red, or Black	Red or Black	Red, Yellow, or Blue

Table 5. Regional Power Cable Colours

Before making any electrical connections or changes ensure that:

- the mains supply isolator switch is in the Off position
- the system is set up to operate at the correct voltage

Refer to Ch.3.2.1 Power Requirements for further information on system electrical specifications.

Note 1: Input voltage of less than DC 23.5 V will fail to charge the backup battery, and it will generate a 'Battery unchargeable' warning message.

Note 2: If Field detectors exceed 20 W per channel or a combined total of 40 W they may need their own power supplies. Refer to Table 6: mA Input Module Connections for further information.

5.1.2 DC Power Supply

It is possible to power the Touchpoint Plus controller directly from a DC 18 – 32 V supply without using AC supplies at all. However, batteries used alone may quickly drop below the minimum DC 18 V requirement when under load.

Note: The system must still be connected to protective earth (ground) when using an external DC supply.

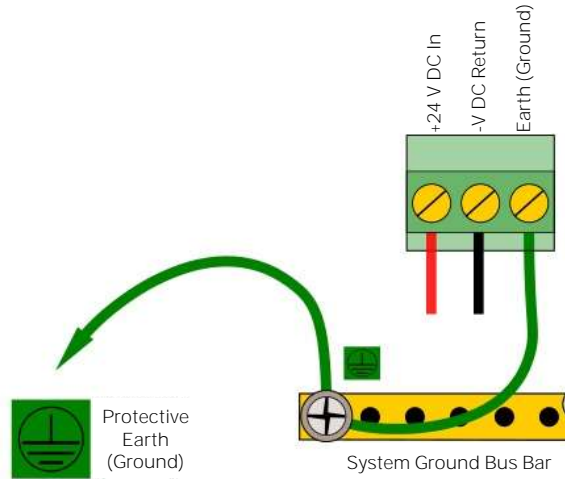

Figure 17. Connections for DC 24 V Supply

5.1.3 Backup Battery Pack

TPPL can be fitted with a rechargeable 24 volt Lithium-Ion Battery Pack. This would normally be charged by the SMPS, but can be charged by a separate DC 24 – 32 V supply. Charging could take up to 24 hours from a fully discharged state.

Note: The backup battery requires a minimum 24 VDC input to fully charge. It has a non-replaceable 15 A over-current protection fuse so the battery input should never exceed 32 V, 5 A.

DANGER

DO NOT USE WATER to cool overheated Lithium batteries as this can cause them to ignite violently or explode.

IMPORTANT

The battery should be charged at DC 24 – 32 V. The backup battery will not become fully charged and the buffer time will be reduced if the charging supply is <24 V.

CAUTION

User shall switch off battery connection switch on the back plane PCB before every battery pack cable connect and disconnect. Refer to Ch.10.7 Back up Battery Maintenance.

5.2 Cabling and Connection Requirements

WARNINGS

All cabling shall be appropriately rated and approved in accordance with national and local regulations. Additionally, cabling must satisfy the requirements defined in the manuals of connected field devices, particularly if the field device is certified for use in a hazardous location.

Signal cables should be shielded to avoid spurious signals, and shall be bonded to protective earth (Ground). Care must be taken to avoid Ground feedback loops.

All external cables should be fitted through appropriate glands to preserve the IP rating.

5.2.1 AC Mains Voltage Power Cables

Use a properly rated AC power cable, certified and installed in accordance with local and national regulations. The Touchpoint Plus terminals will accept only copper wire sizes in the range 0.4 – 4 mm² (solid core), 0.4 – 3 mm² (stranded core), or 21 – 12 AWG ($T_{amb} > 80\text{ }^{\circ}\text{C}$). The mains terminals should be torqued to 1.35 Nm (11.9 lb-in).

5.2.2 DC Power Cables

Use a properly rated DC power (mains) cable, certified and installed in accordance with local and national regulations. The Touchpoint Plus terminals will accept only sizes 0.9 – 3.3 mm² (solid or stranded copper cores), or 18 – 12 AWG ($T_{amb} > 80\text{ }^{\circ}\text{C}$). The mains terminals should be torqued to 0.5 Nm (4.4 lb-in).

5.2.3 Field Device Cables

Field Device cabling (sensors, lights, solenoids, etc.) should be appropriate to the zone classification, and in accordance with the device manufacturer's recommendations. Refer to local and national regulations where appropriate, and to the device's user manual.

All sensor field cables must be screened and earthed (grounded) in order to:

- ensure correct operation of the system
- avoid spurious signals
- provide lightning protection
- Meet Standards for RFI and EMC

The I/O modules will accept copper wire sizes to a maximum of 2 mm² or 14 – 30 AWG, with the terminals torqued to 0.5 Nm (4.4 lb-in).

Ensure that the maximum loop resistance is not exceeded, as specified by the device manufacturer.

Ensure that the correct power level is present at the field device, as specified by the device manufacturer, and does not exceed the TPPL supply limit of 15W per channel individually or 40 / 68 W in total. (See the notes under 5.2.5 Main Module Connections for more details about power consumption and availability.)

E.g. if a device's supply requirement is 24 VDC 0.5 A, then the power requirement is 24 V x 0.5 A ($V \times I$) = 12 W. If you use 240m of AWG 22 cable ($R = 0.05\text{ }\Omega/\text{m}$), the power line dissipation is $0.05\text{ }\Omega/\text{m} \times 240\text{m} \times 0.5^2\text{ A}$ ($R \times I^2$) = 3 W. Therefore the total power requirement is 15 W (12 + 3).

You should also test the cable resistance in situ as its actual resistance is relative to T_{amb} (taking into account any added end of line resistance).

5.2.4 Optional Expansion Unit Connection

In general, the expansion unit should have the same cabling and similar power requirements as the Controller:

- Power cable: 2-core plus Earth
- CAN cable <10 metres (32.8 Ft) using 0.2 to 2 mm² / 14 – 24 AWG shielded twisted pair cable (Belden #9841 or equivalent)
- Shielded signal cables
- Avoid Earth (Ground) loops

The SMPS can deliver 150 W maximum, however a basic unit and an expansion unit each need 107 W so must be wired as shown below when using AC Mains input.

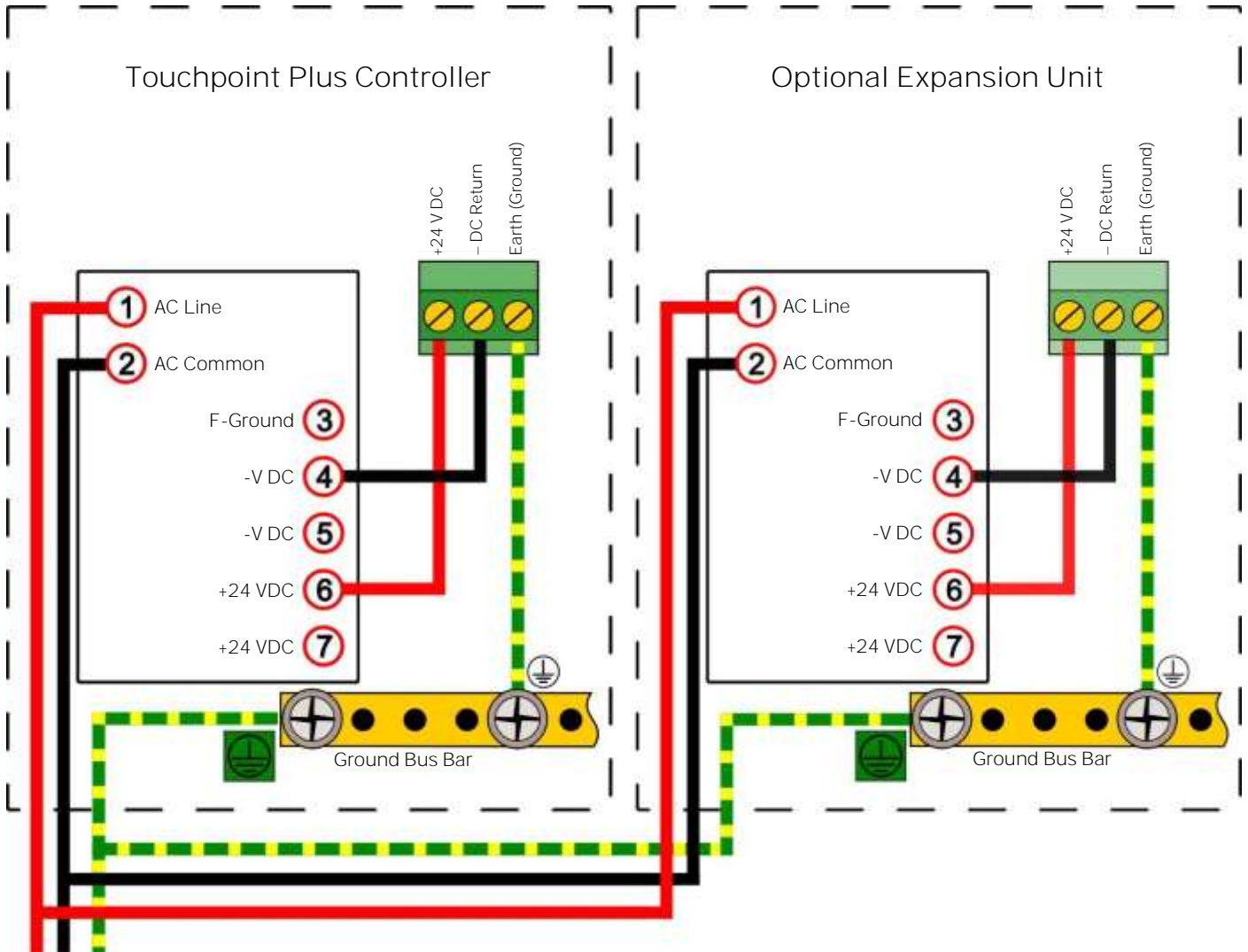

Figure 18. Connecting the Touchpoint Plus and Optional Expansion Unit to a Mains Supply

Note: The SMPS is attached to chassis ground and does not need a separate ground connection.

Note: The Main and Expansion Unit power cables should be matched in type and rating.

5.2.5 Main Module Connections

Install the power and main module connections as shown below:



Module Label	Identifier	Terminal	Purpose	Remarks
Power	+DC	1	24 VDC	Power Supply In
	-DC	2	0 VDC	
	-	3	Earth	
RLY1	NC	4	Relay 1	Channel Relay 001 (Alarm, Fault, Warning Or Inhibit)
	COM	5		
	NO	6		
RLY2	NC	7	Relay 2	Channel Relay 002 (Alarm, Fault, Warning Or Inhibit)
	COM	8		
	NO	9		
RLY3	NC	10	Relay 3	System Failure Relay 003 (System Failure Relay)
	COM	11		
	NO	12		
Visible Output	+24 Vdc	13	Visible	Dedicated Alarm (Max 300 mA) (Note 2)
	VIS	14		
	Unused	15		
Audible Alarm	A1	16	Audible 1	Dedicated Alarms (Max 300 mA per channel)
	A2	17	Audible 2	
	F	18	Audible 3	
Ext Alarm PWR	+24 Vdc	19	Ext. Alarm 1	External Alarm Power (Note 2)
	+24 Vdc	20	Ext. Alarm 2	
	+24 Vdc	21	Ext. Alarm 3	
Remote	COM 3.3 V	22	Common	Remote Inputs (Note 4)
	RST R1	23	Reset	
	IHB R2	24	Inhibit	
CAN	CAN_H	25	CAN_High	Link to Expansion Unit Option
	CAN_L	26	CAN_Low	

Figure 19. Basic Unit Main Module Connections

Note 1: +24 VDC Nominal = Controller Input (18 to 32 VDC) – 1.8 VDC (the max voltage drop in the TPPL).

Note 2: Alarm Terminals 13, 19, 20, and 21 can supply +24 VDC at ≤ 28 W combined this 28 W can instead be used to increase the power available to field sensors if external audible and visible alarms are not connected. e.g. the 8 sensor channels would normally have ≤40 W of combined available power, but this can be increased to 68.8 W if terminals 13 – 21 are unused.

Note 3: You must supply sensors with external power if more than 40 / 68 W total power is required (See Note 2).

Note 4: Maximum R_{loop} resistance for a remote reset/inhibit switch is 18 Ω , for instance ≤500 m of 1 mm² shielded cable.

Note 5: RLY1 or RLY2 should be configured as "system inhibit relay"

5.2.6 Expansion Module Power Connections

The cables must be fitted through a gland to preserve the IP rating.



Module Label	Terminal	Identifier	Purpose	Remarks
Power	1	+DC	24 VDC	Power Supply In
	2	-DC	0 VDC	
	3	—	Earth	
CAN	25	CAN_H	CAN High	Link from Basic Unit
	26	CAN_L	CAN Low	

Figure 20. Expansion Unit Main Module Connections

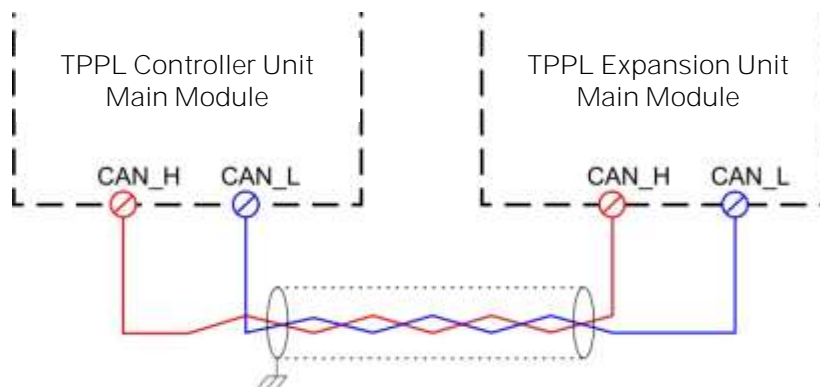

Figure 21. Connecting the Expansion Unit to the Basic Unit

5.2.7 TPPL DIP Switches

TPPL Backplanes have a DIP switch that controls the interaction between the basic (Controller) and the expansion (slave) unit backplanes. Set them as shown below.

		
Basic Unit Alone 2, 4, or 8 Channels Both On	Basic Unit with Expansion Unit 10, 12, or 16 Channel Expansion 1 On, 2 Off	Expansion Unit 10, 12, or 16 Channel Expansion Always 1 Off, 2 On

Figure 22. Backplane DIP Switch Settings

5.2.8 Ethernet Connection (Option)

Ethernet cable must be CAT5e or CAT6 Ethernet cable terminated to TIA/EIA-568B standard. The cable should have shielded RJ45 plugs with the shield of the cable bonded to the metal body (shield) of the connector plug. The cable length should not exceed 100 m. The Ethernet cable should be fitted through a gland to preserve the IP rating.

Connect an Ethernet Network (Web Interface) cable by routing it through a suitable gland and cable clamps before plugging it into the lower right of the Motherboard as shown below:

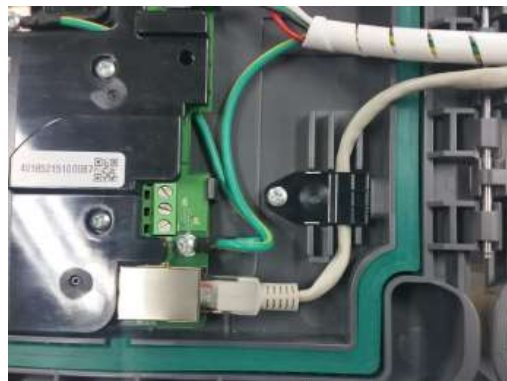

Figure 23. Ethernet Cable Fitting

5.2.9 Module / Field Device Connections

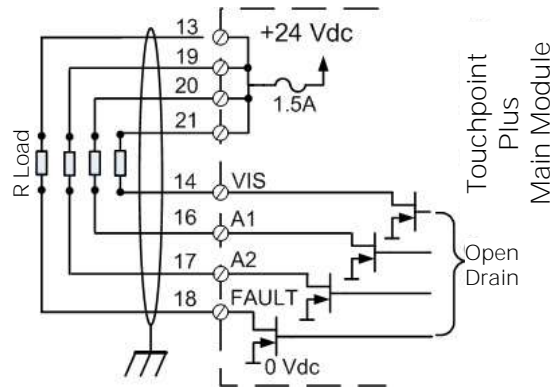

Figure 24. Dedicated Alarm Circuit Connections

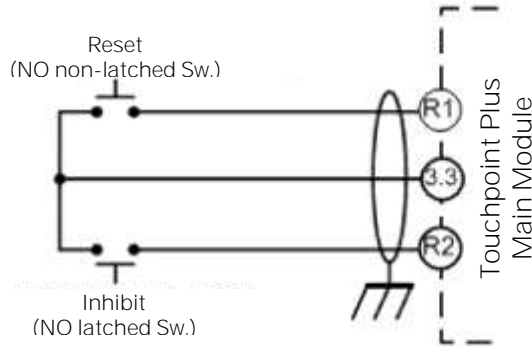

Figure 25. Optional Remote Reset and Inhibit Switch Connections

Maximum R_{loop} resistance for a remote reset/inhibit switch is 18Ω , for instance ≤ 500 m of 1 mm^2 shielded cable.

WARNING
It is the user's responsibility to ensure that Remote Reset / Inhibit switches are guarded against unauthorised access or tampering.

5.2.10 mA Input Module Connections

Note: mA input channels are limited to 20 W per channel to a combined total of 40 W (68 W if Main Module Terminals 13 to 21 are not used). Sensors requiring more than 20 W must have their own power supplies.

Module Label	Terminal	Identifier	Field device
mA Input 1	1	+VE	+24 VDC
	2	-VE	0 VDC
	3	Sig	4 – 20 mA signal
mA Input 2	4	+VE	+24 VDC
	5	-VE	0 VDC
	6	Sig	4 – 20 mA signal
mA Input 3	7	+VE	+24 VDC
	8	-VE	0 VDC
	9	Sig	4 – 20 mA signal
mA Input 4	10	+VE	+24 VDC
	11	-VE	0 VDC
	12	Sig	4 – 20 mA signal
mA Input 5	13	+VE	+24 VDC
	14	-VE	0 VDC
	15	Sig	4 – 20 mA signal
mA Input 6	16	+VE	+24 VDC
	17	-VE	0 VDC
	18	Sig	4 – 20 mA signal
mA Input 7	19	+VE	+24 VDC
	20	-VE	0 VDC
	21	Sig	4 – 20 mA signal
mA Input 8	22	+VE	+24 VDC
	23	-VE	0 VDC
	24	Sig	4 – 20 mA signal

Table 6. mA Input Module Connections

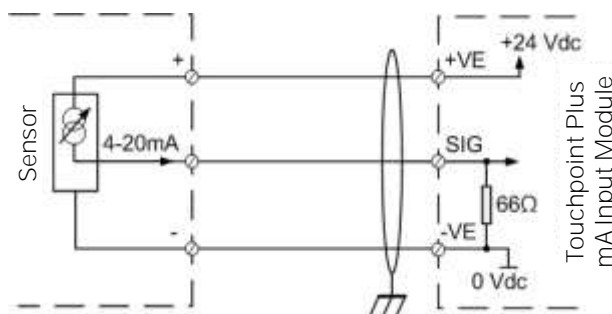

Figure 26. Three Wire Device Powered by a mA Input Module

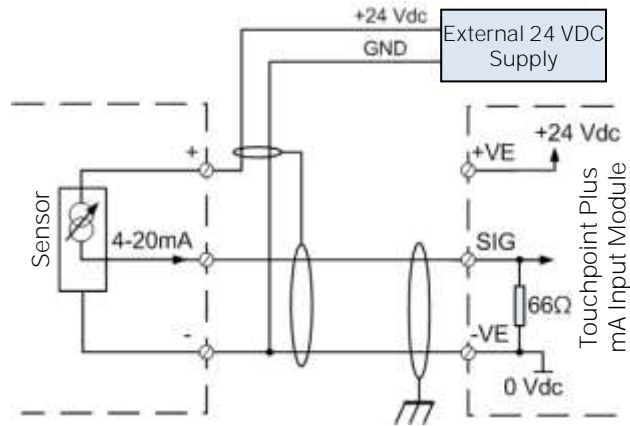

Figure 27. Three Wire Device Powered by an External Source

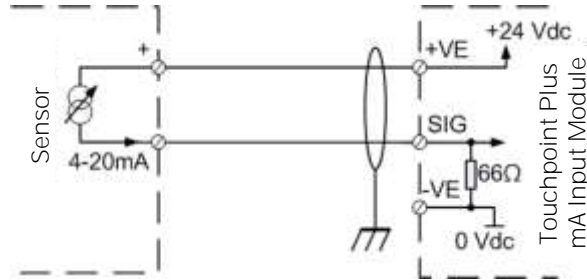

Figure 28. Two Wire Device Powered by a mA Input Module

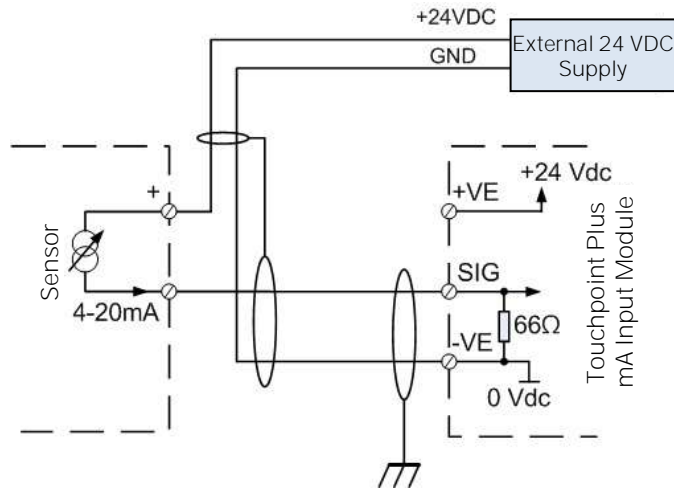

Figure 29. Two Wire Device Powered by an External Source

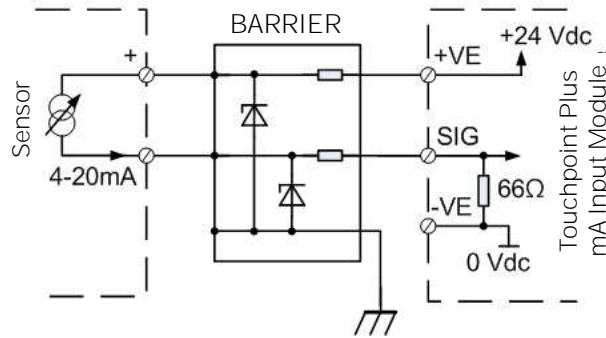

Figure 30. Two Wire Device Barrier Device Powered by a mA Input Module

Note: For intrinsically safe (I.S.) field devices, refer to the device manufacturer’s instructions for details of suitably approved I.S. barriers and interconnections.

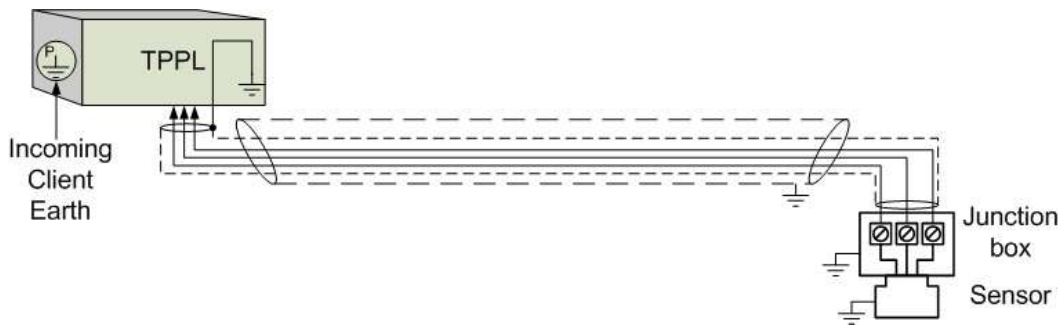

Figure 31. Grounding for Screened Cable with Armour and with Metal Junction Box and Sensor



Figure 32. Grounding for Screened Cable, No Armour, with Metal Junction Box and Sensor

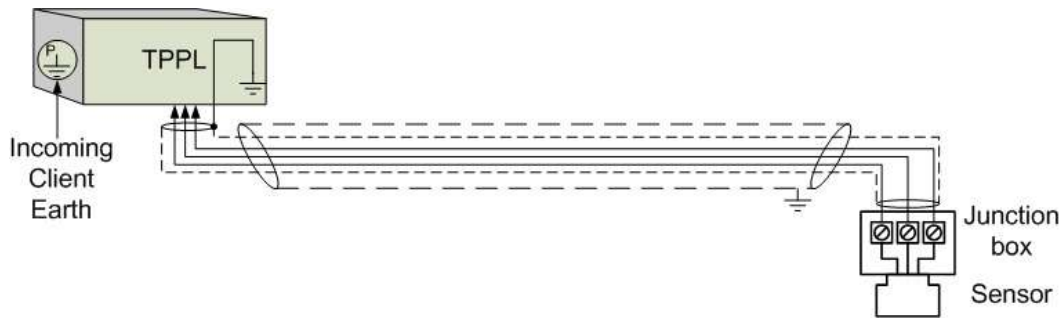

Figure 33. Grounding for Screened and Armoured Cable with Plastic Junction Box and Sensor

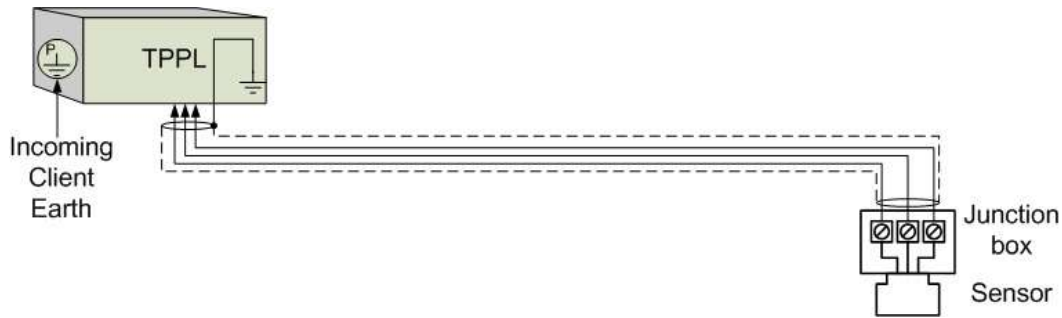

Figure 34. Grounding for Screened Cable with Plastic Junction Box and Sensor

5.2.11 mV Input Module Connections

Module Label	Terminal	Identifier	Field device
mV In 1	1	S	Sensitive (+)
	2	01	Signal
	3	NS	Sensitive (-)
mV In 2	4	S	Sensitive (+)
	5	01	Signal
	6	NS	Sensitive (-)
mV In 3	7	S	Sensitive (+)
	8	01	Signal
	9	NS	Sensitive (-)
mV In 4	10	S	Sensitive (+)
	11	01	Signal
	12	NS	Sensitive (-)
mV In 5	13	S	Sensitive (+)
	14	01	Signal
	15	NS	Sensitive (-)
mV In 6	16	S	Sensitive (+)
	17	01	Signal
	18	NS	Sensitive (-)

Module Label	Terminal	Identifier	Field device
mV In 7	19	S	Sensitive (+)
	20	01	Signal
	21	NS	Sensitive (-)
mV In 8	22	S	Sensitive (+)
	23	01	Signal
	24	NS	Sensitive (-)

Table 7. mV Input Module Connections

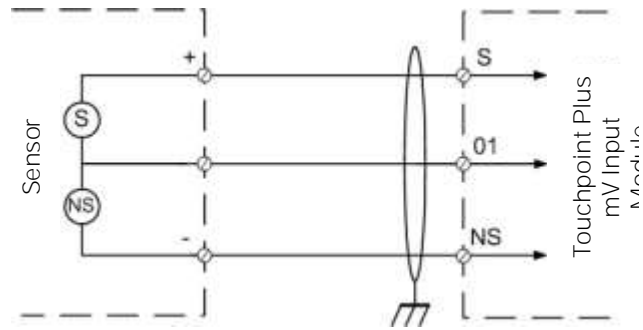

Figure 35. Catalytic Detector Connections

5.2.12 Dual Input Module Connections

The Dual Input Module can be used to connect two or four mA and two or four mV field device inputs.

Minimum Firmware Requirements

Dual Input Modules require the following Firmware versions (on both the Main and Expansion Units) or above.

Firmware	Remarks
UI Module 1.1.0	—
Sensor Catalog 1.0	—
Font Data 1.0	—
Main Module 1.1.4	EEPROM: 1
Dual Input Module 1.0.1	EEPROM mA Input: 1
	EEPROM mV Input: 2

Table 8. Firmware Requirements

The Dual Input Module requires the firmware to be updated twice; once for the mA input channel MCU and once for the mV input channel MCU.

During FW updating the Dual Input Module input channel LCD will warn twice (once for the mA and once for the mV input channel) because the MCUs must be reset after each (mA/mV) FW update.

Refer to the 9.6.1 How to Check Firmware Compatibility

CAUTION

Firmware updating should be carried out only by authorised Honeywell personnel or agents as incorrect updating could lead to irreparable damage, unexpected consequences or loss of the safety function.

Dual Input Module Connections

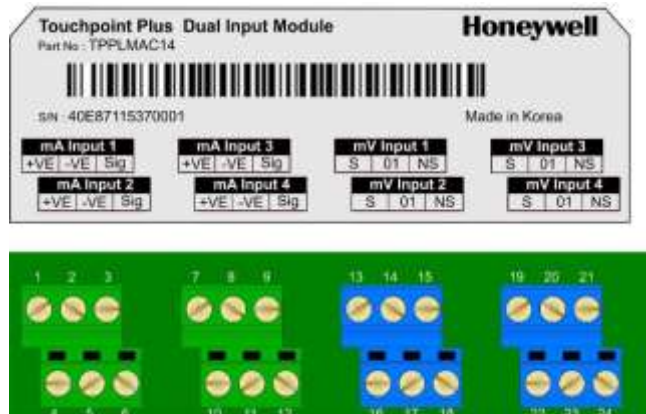

Figure 36. Dual Input Module Terminal Layout

Module Label	Terminal	Ident	Field device	Module Label	Terminal	Ident	Field device
mA Input 1	1	+VE	+24 VDC	mV Input 1	13	S	Sensitive (+)
	2	-VE	0 VDC		14	01	Signal
	3	Sig	Signal (4 – 20 mA)		15	NS	Sensitive (-)
mA Input 2	4	+VE	+24 VDC	mV Input 2	16	S	Sensitive (+)
	5	-VE	0 VDC		17	01	Signal
	6	Sig	Signal (4 – 20 mA)		18	NS	Sensitive (-)
mA Input 3	7	+VE	+24 VDC	mV Input 3	19	S	Sensitive (+)
	8	-VE	0 VDC		20	01	Signal
	9	Sig	Signal (4 – 20 mA)		21	NS	Sensitive (-)
mA Input 4	10	+VE	+24 VDC	mV Input 4	22	S	Sensitive (+)
	11	-VE	0 VDC		23	01	Signal
	12	Sig	Signal (4 – 20 mA)		24	NS	Sensitive (-)

Table 9. Dual Input Module Connections

5.2.13 mA Output Module Connections

Label	Terminal	Identifier	Field Device
mA Out 1	1	I+	24 VDC, 4–20 mA, $R_{Loop} : 33 - 700 \Omega$
	2	I-	GND
mA Out 2	3	I+	24 VDC, 4–20 mA, $R_{Loop} : 33 - 700 \Omega$
	4	I-	GND
mA Out 3	5	I+	24 VDC, 4–20 mA, $R_{Loop} : 33 - 700 \Omega$
	6	I-	GND
mA Out 4	7	I+	24 VDC, 4–20 mA, $R_{Loop} : 33 - 700 \Omega$
	8	I-	GND

Table 10. mA Output Module Connections

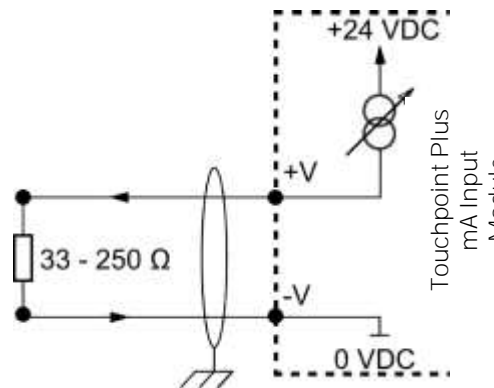

Figure 37. mA Output Module Connections

5.2.14 Relay Output Module Connections

Module Label	Terminal	Identifier	Field Device (max)
RLY 1	1	NC	1.7 A @ 250 VAC 1.7 A @ 30 VDC
	2	COM	
	3	NO	
RLY 2	4	NC	1.7 A @ 250 VAC 1.7 A @ 30 VDC
	5	COM	
	6	NO	
RLY 3	7	NC	1.7 A @ 250 VAC 1.7 A @ 30 VDC
	8	COM	
	9	NO	
RLY 4	10	NC	1.7 A @ 250 VAC 1.7 A @ 30 VDC
	11	COM	
	12	NO	
RLY 5	13	NC	1.7 A @ 250 VAC 1.7 A @ 30 VDC
	14	COM	
	15	NO	
RLY 6	16	NC	1.7 A @ 250 VAC 1.7 A @ 30 VDC
	17	COM	
	18	NO	
RLY 7	19	NC	1.7 A @ 250 VAC 1.7 A @ 30 VDC
	20	COM	
	21	NO	
RLY 8	22	NC	1.7 A @ 250 VAC 1.7 A @ 30 VDC
	23	COM	
	24	NO	
RLY 9	25	NC	1.7 A @ 250 VAC 1.7 A @ 30 VDC
	26	COM	
	27	NO	
RLY 10	28	NC	1.7 A @ 250 VAC 1.7 A @ 30 VDC
	29	COM	
	30	NO	
RLY 11	31	NC	1.7 A @ 250 VAC 1.7 A @ 30 VDC
	32	COM	
	33	NO	
RLY 12	34	NC	1.7 A @ 250 VAC 1.7 A @ 30 VDC
	35	COM	
	36	NO	

Table 11. Relay Output Module Connections

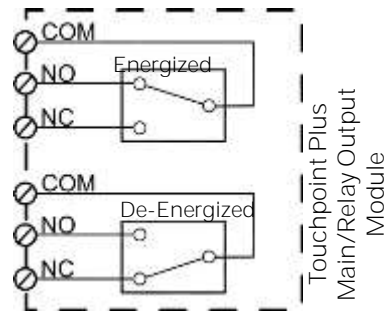

Figure 38. Output Relay States

5.3 Modbus Remote Terminal Unit (RTU) and Transmission Control Protocol (TCP) Connections

The Touchpoint Plus Modbus Interface provides a facility for digital communication between TPPL and an external control system. Modbus is a well-supported digital data communication protocol that provides a set of standard commands by which system data can be communicated.

TPPL can be supplied with the Modbus Interface.

Note: Full instructions are given in the Honeywell Analytics Modbus User Guide, which is available separately on the Honeywell Analytics download site.

CAUTION

Switch off and Isolate all mains and backup power supplies and take anti-static precautions before and during this procedure. Failure to do so could lead to injury and irreparable system damage.

The data from the Modbus interface should not be used for safety relevant purposes.

To access or fit the optional Modbus PCB:

- 1) Open the enclosure and remove the PCB cover screws as shown below:



Figure 39. PCB Cover Screws (Arrowed)

- 2) Slide the cover off carefully and place it on a clean, anti-static surface.
- 3) Fit the Modbus PCB by carefully aligning the connectors and pushing down gently, observing the orientation shown below:

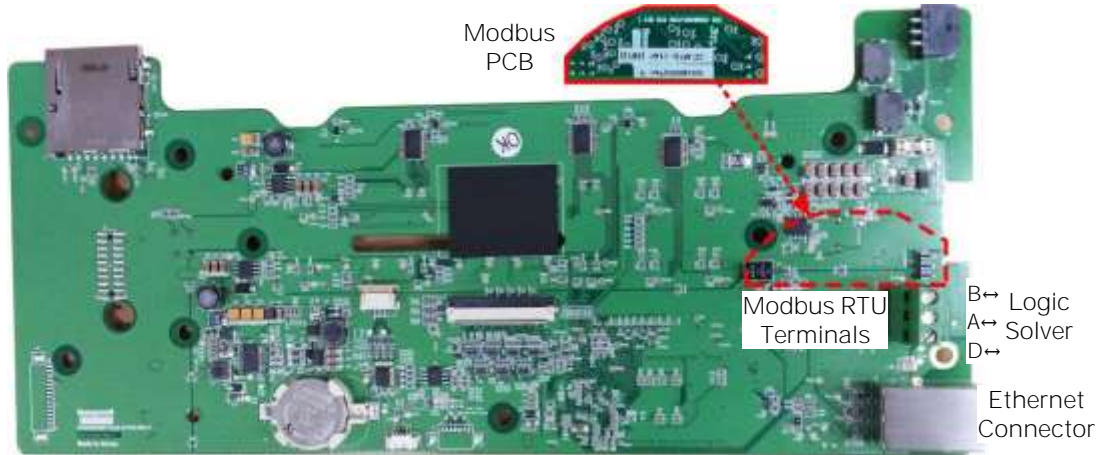

Figure 40. Motherboard Showing the Modbus PCB Location

- 4) Connect the Modbus cables as shown below. (You should connect a 120Ω termination resistor (R_T) between A and B to prevent reflections on the RS485 circuit if TPPL is the last node in a Modbus system highway.)

Note: External R_T is not needed if the logic solver side has an internal R_T.

CAUTION

Some manufacturers have been known to incorrectly reverse their RS485 Data terminals, which can cause Tx/Rx to fail. If this happens, simply swap over A and B cables and re-test.

MODBUS RTU	Label	Terminal ID	Logic Solver
Drain	D	1	D
Data +	A (D+)	2	A (D+)
Data -	B (D-)	3	B (D-)

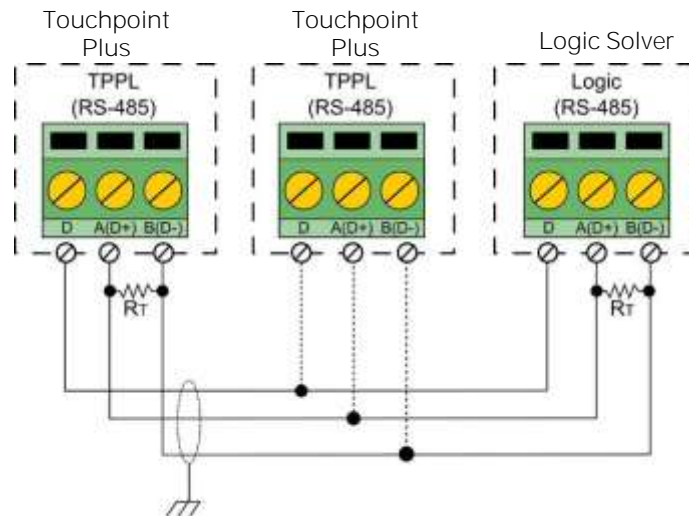

Figure 41. Modbus RTU Connections

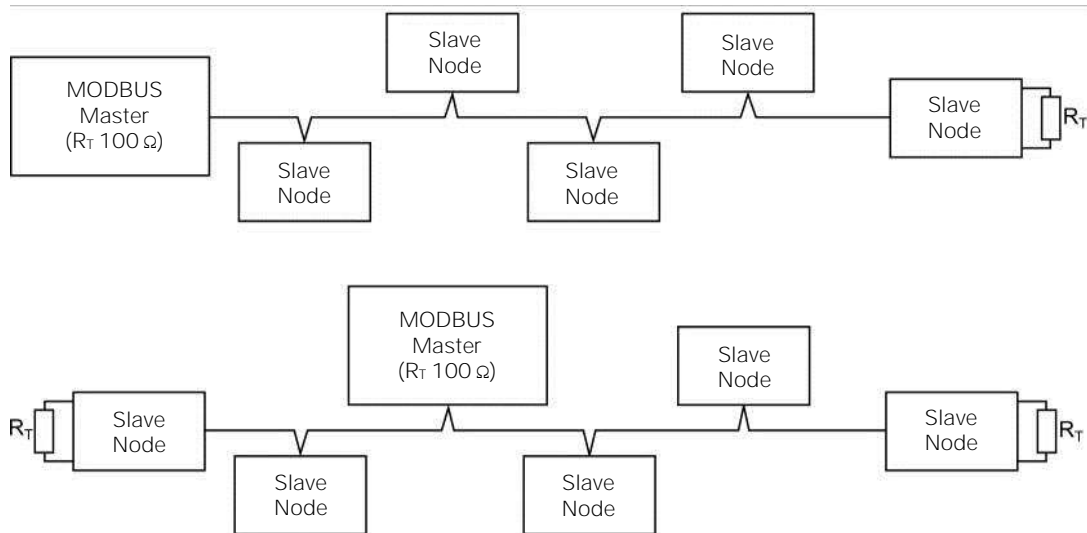

Figure 42. Two Modbus Installation Examples (other methods may be used)

Note: TPPL can fill any of the slave nodes, and it can support up to 32 nodes in Multi-Drop Mode (one master node with 31 slave nodes).

- 5) Refit the PCB cover. Do not overtighten the screws.
- 6) Close and secure the enclosure door.
- 7) Switch on the backup and main power supplies and wait for the system to initialise.
- 8) Test the Modbus installation.

5.3.1 Modbus Configuration

For information on Modbus Configuration see Ch.6.12 Modbus RTU Settings.

Chapter 6. Commissioning

This chapter explains several tasks that may be required during commissioning.

First time switch-on and Commissioning should only be carried out by a Honeywell Analytics engineer or by a qualified person who has been trained in accordance with this manual.

During first time switch-on, it will be necessary to confirm or set the Date, Time and Language, to set new passwords and delete the default password, and to program password protected items shown in the menu structures below.

If the system was ordered from Honeywell Analytics, carry out Ch.6.13 Commission Input / Output Modules and Ch.7.6 Channel Configuration for the input channels before proceeding with Ch.6.14 Channel Configuration for the Relay Output channels and the mA Output channel.

CAUTION

When commissioning is complete, user shall conduct the initial check as required by each sensor's user manual (e.g. bump test, accuracy test and etc.) as well as check of Touchpoint Plus mA output and relay operation as required by this manual. Each sensor connected to Touchpoint Plus shall be regularly gas calibrated per the recommended interval by sensor's user manual. In addition, Touchpoint Plus mA output and relay operation shall be regularly checked as required by this manual.

6.1 Menu Structure

The tables below show the full Menu tree but not all items are available to all users. In particular Service Mode and Update System can only be accessed by logging on as the Administrator.

6.1.1 The Information Menu

The Information Menu contains non-editable summaries of the current system configuration and it can be read by all.

Menu Level 1	Menu Level 2	Menu Level 3
 Information	System Information	N/A
	Event History	N/A
	Trend / Plot	N/A
	Channel Information	N/A
	Module Information	N/A
	Service Contact	N/A
	Relay Status	N/A
	Additional Status	SD Card and Battery Status
	Network	IP Status

Figure 43. Information Menu

6.1.2 The Configuration Menu

The Configuration Menu contains all of the basic system settings that are entered on installation / commissioning. It should not need updating unless there are changes to the system or requirements. Access is restricted to Service or Admin users.

Menu Level 1	Menu Level 2	Menu Level 3	Menu Level 4
 Configuration	Channel Settings	Channel Number Select	Remove
			Enable
			Disable
			Select (3 windows)>Edit>Review>Apply>Update
	Module Control Panel	Module Select	Refresh
			Add
			Remove
			Replace
	General	Date / Time	Change
		Language	Change
		Service Contact	Change
		Home Settings	Default Home screen layout
		Timeout	Menu Timeout (5 – 100 Sec) Authentication Timeout (15 – 100 Min)
	Log Interval and Threshold	Log Threshold	Enter %FSD
		Log Interval	Enter Seconds
	Display	LCD Backlight Timeout	Enter Seconds
		LCD Backlight Brightness	Enter %
		Touch Panel Calibration	Wizard
	Outputs	Dedicated Alarm Contacts	Dedicated Audible Alarm 1 (1/2/3)
			Dedicated Audible Alarm 2 (1/2/3)
		Buzzer Options	Buzzer Option (Enable / Disable) Activation on Warning (Enable / Disable)
	Security	Password	Change / Reset (per user)
		Remote Access	Remote Reset/Acknowledge (Enable / Disable)
			Remote Inhibit (Enable / Disable)
			Remote Inhibit Setting (NO / NC)
	Config Manager	Import	Per Channel (Update File required)
		Export	Keyboard (Input File Name) / Wizard
	Network	Ethernet	DHCP / SIP Address (Keyboard)
		Modbus RTU	Address Settings (Keyboard) Baud, Parity, D-Bits

Figure 44. Configuration Menu

6.1.3 The Maintenance Menu

The Maintenance Menu is where commissioning and maintenance tasks can be accessed. Most of this menu is available to Service Engineers, but Service Mode and system updates can only be authorised by the Administrator.

Menu Level 1	Menu Level 2	Menu Level 3	Menu Level 4	
 Maintenance	Reset alarms / Faults	Yes / No	N/A	
	Reset All Peaks	Yes / No	N/A	
	Gas Calibration	Wizard	N/A	
	Adjust mV Baseline	Wizard	N/A	
	SD Card	Format / Eject	N/A	
	Power Off	Yes / No	N/A	
	Service Mode (Administrator)	Electronic Adjustment	Requires multi-meter and technical skills	
		Reset to Default	Yes / No	
	Update System (Administrator)	Software	Update File required	
		Language	Update File required	
Sensor Catalog		Update File required		
Module Data		Update File required		

Figure 45. Maintenance Menu

6.1.4 System Test Menu

This menu allows a Service Engineer to test / emulate various system functions. Access is restricted to Service or Admin users

Menu Level 1	Menu Level 2	Menu Level 3	Menu Level 4	
 System Test	Force Relay	Module Select	System / Channel (On/Off)	
	Force 4 – 20mA	Channel to Force (All / Single)	New Output Value (in mA)	
	Relay C&E Matrix	Select Relay Channel	Input Select Auto-fill (A1, A2, A3, FLT, INHIB, WARN)	
			Input Channel (Selective Inputs - Scrollable)	
			Vote Count Summary	
			Channels Selected Summary	
	Dedicated Alarm Contacts	Visible Alarm	On / Off	
		Audible Alarm 1	On / Off	
		Audible Alarm 2	On / Off	
		Audible Alarm 3	On / Off	
LCD Test	Yes / No			
LED & Buzzer	Yes / No			

Figure 46. System Test Menu

6.2 First Time Switch On

Before switching power on, ensure that the system has been commissioned or that a qualified person has checked that the wiring is safe and conforms to local regulations, and that all electrical connections are made in accordance with Chapter 5. Also check that the battery isolator switches are 'On' if a backup battery is fitted.

Switch on power at the Isolator switch and wait for the system to initialise.

The system start up sequence may last for up to 20 minutes depending on the number of channels in use. During this time the mA Output signals and Relay Output contacts are initialised to the inhibit state, with the Relay output being delayed by approximately 30 seconds after the mA output inhibit ends.

Each sensor requires the warm-up time for stabilization. When Touchpoint Plus is turned-on, Touchpoint Plus starts the normal gas reading after sensor warm-up period. Refer to each sensor's user manual for the warm-up time.

TPPL will first display the auto-scrolling Input screen, indicating the current status of the system. The Channel List View is shown below. The screenshot shows installed sensors but it may be blank depending on your system status:



You can alter the screen views or gain further information by touching the icons shown below:

	Toggle to select screen layout		Admin Logged in
	SD Card Status Good		Service Logged in
	SD Card Status Fault		Operator Logged in
	External mains power is connected. Touch for status		No one Logged in
	External power is not connected. Touch for status		Toggle auto-scroll on and off
	Event History (changes colour to show fault, inhibit or alarm)		Scroll up when auto-scroll disabled
	Further Menu Options		Scroll down when auto-scroll disabled

Table 12. Home Screen Menu Icons

6.3 Logging In/Out

Access to some functions and system settings is controlled by password security. On a new system the default password for all levels is "TPPL" but they should all be changed on first access, especially if the customer has elected to have Networked access (see below for instructions).

6.3.1 How to Log In

- 1) To log in, touch the user  icon to open the login dialog.
- 2) Touch your chosen Operator / Service / Administrator icon.
- 3) Touch the password box.
- 4) Enter the correct password using the touch screen keyboard. (Toggle the [↕] key for upper / lower case letters, and the [?123] key for symbols).
- 5) Touch [Finish].
- 6) Touch [Log In].
- 7) Use the Menu Icon to select further options.
- 8) [Log Out] when finished.



6.3.2 How to Log Out

Touch the logged-in user icon and then touch [Log Out].

Note: Periods of inactivity will lead to automatic log out; if you were in the middle of calibrating the touch screen you must return and finish the calibration before you can proceed any further.

6.3.3 Password Rules

Note: Administrator level access is required to create or amend an Administrator or lower levels of password. Service level access can create or amend Service or lower levels of password. Operators can only change their own password.

The following rules apply:

- There are three password protected levels and one non-protected level.
- Passwords are case sensitive and cannot be recovered, but they can be reset by a higher level user.*
- Passwords must be at least 8 characters long.
- Passwords must contain a mix of letters, numbers and symbols.
- Passwords must contain upper and lower case characters.
- Passwords must be easy to remember but hard to guess.
- Passwords may be written down, but only if they are kept secure (e.g. in a sealed envelope in a locked safe or encrypted on other hardware [256AES or higher]).

* Lost Admin passwords can only be reset by authorised Honeywell Field Service Technicians. See the back page or select TPPL Menu>Information>Service Contact for details.

6.3.4 How To Change a Password

You can only change your own or lower level passwords. The initial default password for all levels is “TPPL” but it should always be changed during or immediately after Commissioning.

- 1) Login as Service or Administrator.
- 2) Touch **Menu icon>Configuration>Security>Password**.
- 3) Touch an access level icon and touch each box to open a keyboard.
- 4) Input the currently logged in password, the new password, and confirm the new password. (Toggle the **[↑↓]** key for upper / lower case letters, and the **[?123]** key for symbols.
- 5) Touch **[Finish]** to close the keyboard before touching the next box.
- 6) Touch **[Change]** when finished.

Note: The stored passwords will be replaced with the new passwords so you must also update any written copies.



CAUTION

For security reasons you should change the default Administrator, Service and Operator passwords at the earliest opportunity and periodically thereafter.

At the very least you should keep a copy of the Administrator password in a safe place as it cannot be recovered if lost or forgotten.

Careless password management can allow unauthorized access to the system, which may cause safety issues that are the user's sole responsibility. Honeywell™ will not be liable if any end-user fails to follow established security protocols or the guidelines in this manual.

6.3.5 Forgotten Passwords

The Administrator or Service Engineer can reset lower level passwords but the Administrator password cannot be changed or reset without entering the current Administrator password.

To reset a lower level password:

- 1) Log in as **Administrator*** or **Service**.
- 2) Go to **Menu>Configuration>Security>Password**.
- 3) Touch the user to change, then enter your own password, and then enter and confirm the new password.
- 4) Alternatively you can use the **[Reset]** button to reset to the default password “TPPL”, and then allow the user to set their password as shown above.

* Lost Admin passwords can only be reset by authorised Honeywell Field Service Technicians. See the back page or select **TPPL Menu>Information>Service Contact** for details.

6.4 Date, Time and Language Settings

System Date and Time settings are used by the events log, so you should decide whether to use Local or UTC time. Using UTC means that you have a global time stamp and you do not have to adjust for daylight saving time.

Note: You should replace the CMOS battery every two years or when the time and date settings are not retained after power is cycled. Refer to Ch.5.3 Modbus Remote Terminal Unit (RTU) and Transmission Control Protocol (TCP) Connections for more information.

Note: You should regularly check the time and date settings and adjust them if required. Touchpoint Plus does not adjust automatically for daylight savings time so it retains a copy of the earlier data if the clock is backdated (e.g. when ending daylight savings time), which can show as a mismatch in the events log chronology.

6.4.1 How to Set or Change Date, Time and Language Settings

- 1) Touch the **Login** icon in the navigation bar and a login prompt will ask for the access level and Password.
- 2) Login to the **Service** access level.
- 3) From the navigation bar select **Menu>Configuration>General>Date / Time**.
- 4) Set the date, time and display format as required.
- 5) Touch **[Finish]**.

6.5 Service Contact Settings

To set the Service contact:

- 1) Login as **Administrator** or **Service**.
- 2) Touch **Menu>Configuration>General>Service Contact**.
- 3) Update the settings with your local service support contact details.
- 4) Touch **[Finish]** and return to the Configuration menu.

6.6 Touch Panel Configuration

The Touchscreen can be configured to match local preferences.

6.6.1 How to Change the Backlight Timeout and Brightness

- 1) Login as Administrator or Service.
- 2) Touch the Menu>Configuration>Display.
- 3) Touch and enter LCD Backlight Timeout and Brightness settings, or touch [Start] to calibrate the Touch Panel (see below).
- 4) Touch [Finish] and return to the Configuration menu.

Parameter Name	Default Setting	Value Range	Comment
Backlight time out	30 seconds (0.5 min)	0.5 to 10 mins or Always On	This is the time that the backlight will remain on after the Touchscreen is idle. If a new event occurs, the backlight will come on and will remain on as long as the event remains unacknowledged.

6.6.2 How to Calibrate the Touch Panel

To calibrate the screen:

- 1) Login as Administrator or Service.
- 2) Touch Menu>Configuration>Display.
- 3) Touch [Start].
- 4) Follow the instructions on screen, touching each marker as it appears.
- 5) Touch [Finish] and return to the Configuration menu.

6.7 Latching Alarms

Latched alarms stay active (after the input reading has reverted to the normal range) until acknowledged, whereas Unlatched alarms are automatically reset when the reading goes back to the normal range.

To set or change latched alarms:

- 1) Log in as Service.
- 2) Touch Menu>Configuration>Channel Settings.
- 3) Touch the Input Module to change (circled)...:



4) ...to give this window:



5) Touch the Channel you want to change and then touch [Select].

6) Touch the Channel Enable>Enable option:

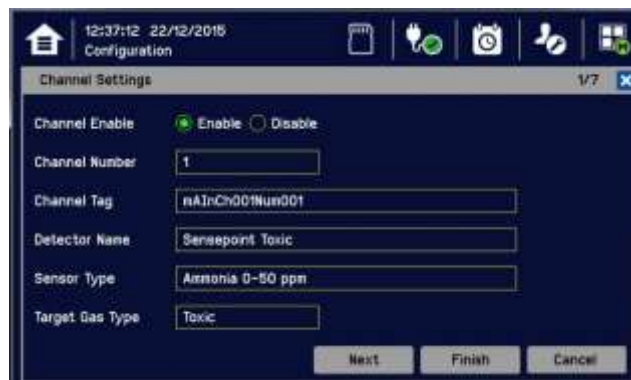

7) then touch [Next]:



8) Then [Next] again:

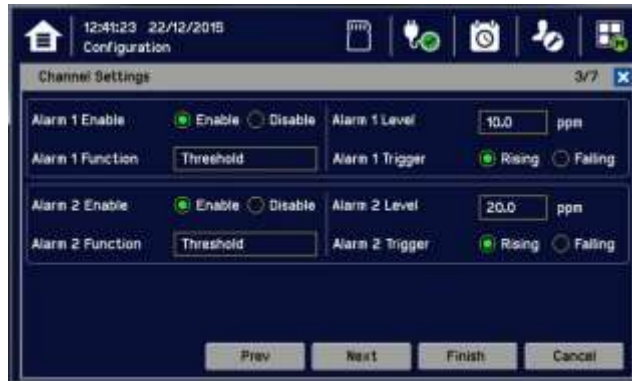

9) Then [Next] again:



10) Then [Next] again:

11) Touch Alarm Latch>Enable or Alarm Latch>Disable:

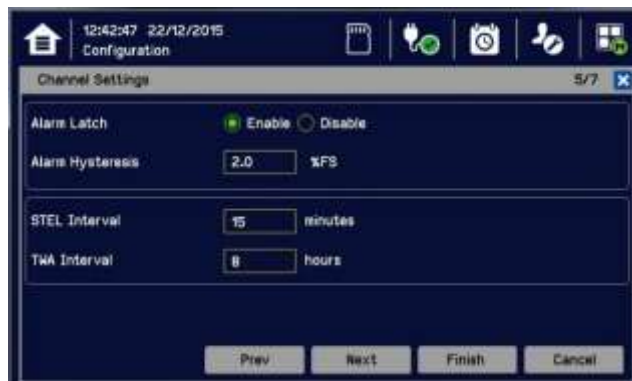

12) Touch Finish>Apply>Update.

13) Repeat to configure another Alarm channel.

6.8 Remote Reset / Acknowledge / Inhibit Switch Options

Select this option if your system has been installed with Remote switches that supplement the local Alarm Acknowledge, Alarm Reset, or Channel Inhibit options.

- 1) Confirm whether the remote inhibit switches are normally open circuit or normally closed. (Single stand-alone switches can be either mode but multiple switches must be normal closed circuit if wired in series and normal open circuit if wired in parallel.)
- 2) Login as Service or Administrator.
- 3) Touch **Menu>Configuration>Security>Remote Access**.
- 4) Touch the required **[Enable / Disable]** options and whether the Remote Inhibit Setting is **Normal Open** or **Normal Closed**.
- 5) Touch **Finish>Close>Close>User Icon>Log Out**.

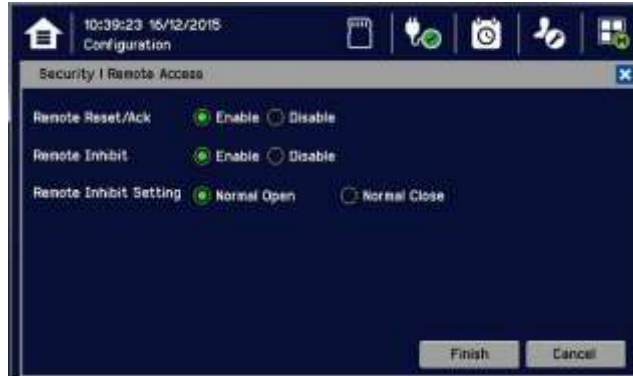

6.9 Data Logging

You should set the Data Logging Interval and Threshold during initial configuration.

Using a 0 %FSD Threshold means that the TPPL will log the gas concentration at the specified intervals without checking changes in gas concentration. In contrast, a >1 %FSD Threshold setting will ignore fluctuations in low ambient gas concentrations and only check for rises in gas above the Threshold (i.e. safe) setting.

Leave the Interval setting at 0 seconds if you don't want to log gas concentration at the configured log interval. However, if you do want to monitor changes, you should start with a low threshold setting and slowly increase it by trial and error if you get too many unnecessary warnings.

6.9.1 To set or change Data Logging:

- 1) Log in as Administrator or Service.
- 2) Touch **Menu>Configuration>Log Interval & Threshold**.
- 3) Touch required box and enter the details using the touchpad.
- 4) Touch **[Finish]**.
- 5) Make other changes or **[Log Out]**.

6.10 TPPL TCP/IP Address

The default TPPL TCP/IP address (for optional Web Interface access) is 192.168.0.100, but you may need to change it if it conflicts with other items on the network or if the Control Room is monitoring multiple TPPL systems. See Ch.6.11 Network Settings for Web and MODBUS TCP and Ch.6.12 Modbus RTU Settings for further information.

6.11 Network Settings for WEB and MODBUS TCP

TPPL can be installed with the ability to view its status over the Web. (See Ch.7.17 Monitoring TPPL via the Optional Web Interface for more details.)

Note: It will be the end user's sole responsibility to protect the TPPL system from unauthorised access or tampering.

Note: It is important to ensure that the default IP Address does not clash with other units on your network.

To check or set the IP Address:

- 1) Log in as Administrator or Service
- 2) Menu>Configuration>Network>Ethernet



- 3) Touch a radio button to set the IP acquiring type (DHCP / SIP)
- 4) Touch the IP Address box to change the address (only if there are network conflicts) and enter the new IP Address using the onscreen keyboard:

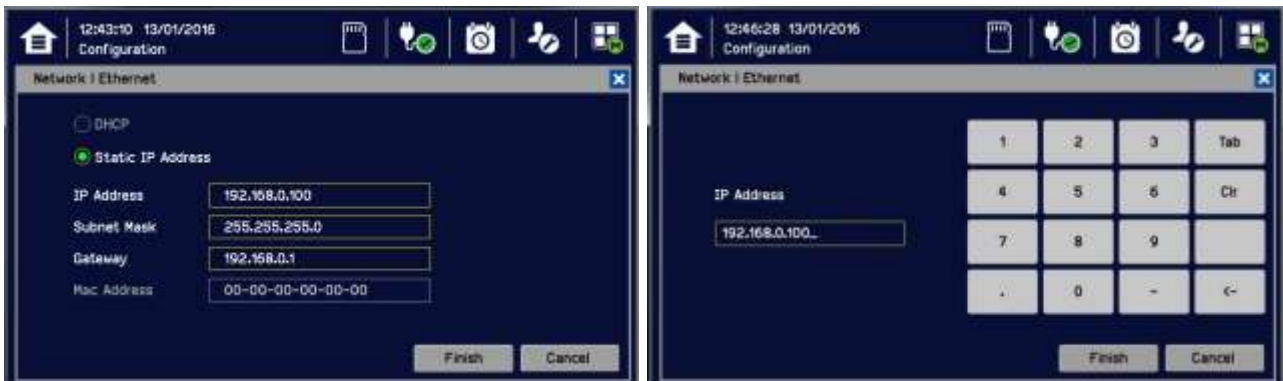

- 5) Touch [Finish]
- 6) Touch the Subnet Mask and Gateway boxes (if required), and use the keyboard to enter new values as before
- 7) Touch [Finish]
- 8) [Log out]

6.12 Modbus RTU Settings

See the separate Modbus User Guide for instructions on setting up Modbus on a Remote Terminal Unit. You will also need to know the Host Baud and Parity settings.

To view or change the Modbus Settings in TPPL:

- 1) Log in as Administrator or Service
- 2) Menu>Configuration>Network>Modbus RTU



- 3) Touch the Address box if you want to change the default setting
- 4) Touch the Baud box to change the communication speed to 4800, 9600, or 19200 Baud, then [Select]
- 5) Touch the radio buttons to change Parity and Databits:

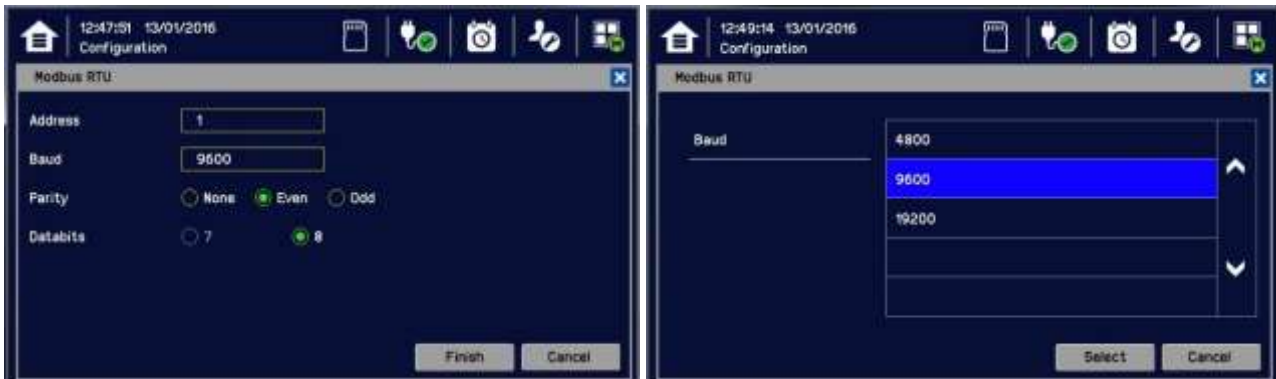

- 6) Touch [Finish] when done
- 7) [Log out]

Tip: You can reduce the default Baud if communication is slow or unstable or increase it if you have a really good connection.

6.13 Commission Input / Output Modules

- 1) Login as **Service** or **Administrator**.
- 2) Touch **Menu> Configuration>Module Control Panel**.
- 3) Touch **[Refresh]** to check for additional modules (if an expansion unit is connected and switched on).
- 4) Touch an I/O module (a blue block) and touch **[Add]**. Touch one of the listed I/O module types.
- 5) Repeat for other installed I/O modules.
- 6) To remove a module, select the Module on the screen and then touch **[Remove]**. To replace it, touch **[Replace]**.

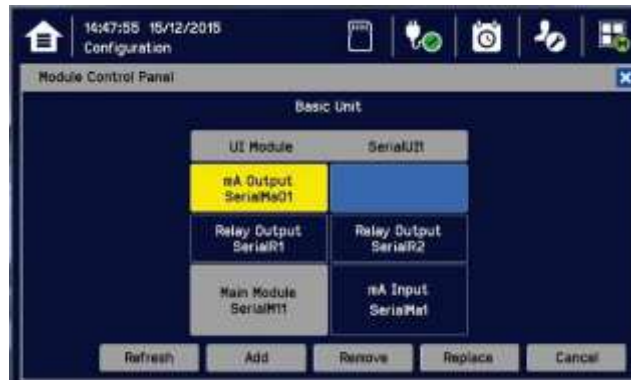

Note: Sky blue blocks show uncommissioned or decommissioned modules.

6.14 Channel Configuration

Note: Administrator or Service level access is required. Refer to Ch.7.4 Menu Items and Access Levels for details.

Note: In order to disable calibration overdue warning, set the calibration interval to zero. (See Ch.6.14.2 Configuring a Channel and Ch.6.14.3 Editing a Configured Channel).

The system will time out after fifteen minutes if not data is entered during channel configuration. Unsaved settings will not be retained. The channel will be decommissioned. It may be necessary to return to the System Setup screen and set the module to Normal state.

Note: Refer to Ch.17 Configurable Parameter Reference Guide for the understanding of parameters.

6.14.1 Introduction

Individual channels can be configured in two ways – either from the built in sensor catalogue (for Analogue Input modules only), or by completing a full custom configuration.

When using the sensor catalogue, only the Analogue Channel number and tag must be manually entered and then the rest of the configuration will be populated automatically when a detector is selected from the pre-defined list.

Note: You can always use the sensor catalogue as a starting point and then amend it afterwards (see Ch.6.14.3 Editing a Configured Channel and Ch.17 Configurable Parameter Reference Guide).

To change any parameter, enter the new value and touch **Apply** to update the system. The system will then return the value, which will be displayed on the screen, and the user must touch **Update** for the settings to take effect. This requires the user to verify that the correct value has reached the system.

New values can be entered in various ways:

- Free text (i.e. channel tag)
- Numeric keypad
- Check / uncheck a box (i.e. to toggle an alarm between latching and non-latching)
- Select an option by checking a radio button
- Select from a list of available options (i.e. channel number)

The configuration is designed to be simple to follow on the screen. However you can refer to Ch.18 Configurable Parameter Reference Guide to find detailed definitions of all the parameters, default settings and available ranges.

6.14.2 Configuring a Channel (mA Input and mV Input Channels)

Choose your required configuration method, and follow the on-screen instructions. Refer to Ch.18 Configurable Parameter Reference Guide for detailed information on configurable parameters.

Note: You will need to have the required configuration information available before starting this procedure or you risk having the system timing you out and decommissioning the uncompleted channel and losing all of your unsaved changes.

If you want to configure an individual channel:

- 1) Login as an Administrator or Service.
- 2) Touch Menu>Configuration>Channel settings.
- 3) Touch the required Module type.
- 4) Touch a required channel and touch [Select].
- 5) Touch [Enable] for a required channel.
- 6) Touch [Channel Number] and [Enter Channel Tag].
- 7) Touch a detector name and a sensor type to import all relevant configuration parameters from the Sensor Catalog.
- 8) Edit the channel parameters.
- 9) Touch [Finish] if modification of channel settings is complete.
- 10) Check whether the channel settings are valid before making it take effect.
- 11) Touch [Apply].

CAUTION – ALARM INHIBIT

During the gas calibration, I/O module are set as inhibit status, which means input channels will not trigger any alarms and output channels will not execute any actions. User should consider alternative safety measures when performing these procedures.

During the configuration, I/O module measures gas and execute the necessary actions.

CAUTION – CHANGING COMPONENTS

Changing the detector type, gas type, or mV full scale deflection will reset the input channel calibration data and you will get a Calibration Due warning. If this happens you must recalibrate the channel to ensure accurate readings. See Ch.6.15 Calibrating Input Channels for further information.

6.14.3 Editing a Configured Channel

To edit an already configured channel:

- 1) Login as an Administrator or Service.
- 2) Touch Menu>Configuration>Channel settings and then select an I/O module.
- 3) Touch the required channel.
- 4) Touch the screen that you want to edit (refer to previous sections of this manual).
- 5) Enter the required values in the New Value field and touch [Finish].
- 6) Review all parameters are valid and touch [Apply].
- 7) The system will return the new value; touch [Update] to confirm.

6.14.4 Editing mA Input Channel Settings

- 1) Log in as Service.
- 2) Touch Menu>Configuration>Channel Settings.
- 3) Touch the Input Module you want to change (circled)...:

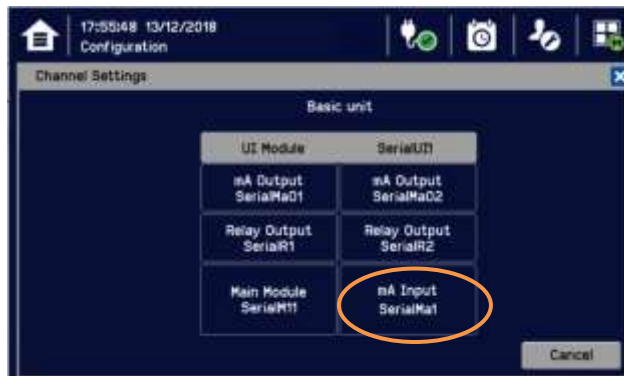

- 4) ...to give this window:

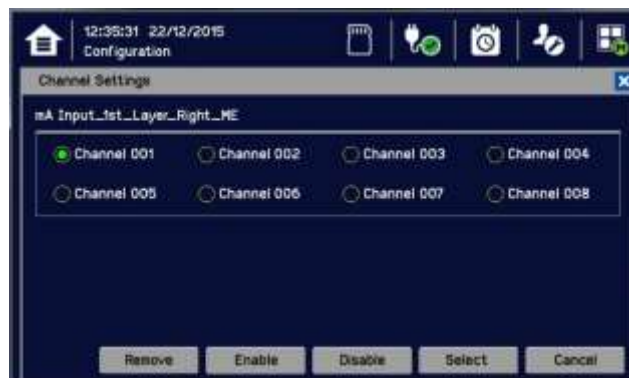

- 5) Touch the [Channel] you want to change and then touch [Select].

- 6) Touch any settings you want to change, then scroll through and touch your choices, and touch [Select] to close the window:

Refer to Ch.16 Compatible Sensors for a list of available detectors.
 You can also use the TPPL Sensor Catalog to select listed gases, or you can enter 'User gas' details if your gas is not listed.
 Refer to Ch. 9.4 How to Update the Sensor Catalogue for further information.

- 7) Then touch [Next] to see these settings inserted (use [Prev] if you want to amend them):



8) Then touch [Next] again to change more settings:

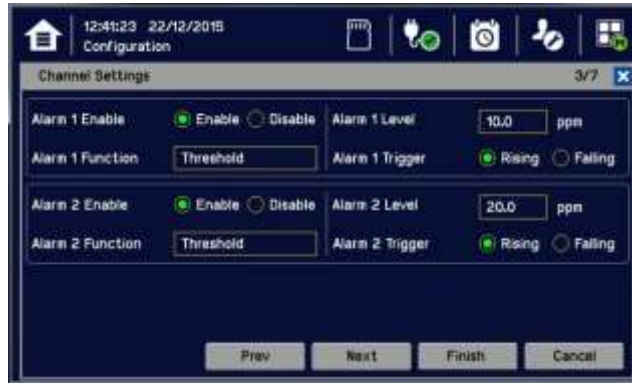

Note: Touch the [Alarm Function] boxes to open a dialog box for Threshold, STEL or TWA choices.

Note: It is only available set to “Falling” for O2 channels.

9) Then touch [Next] again to change more settings:



10) Then touch [Next] again to change more settings:

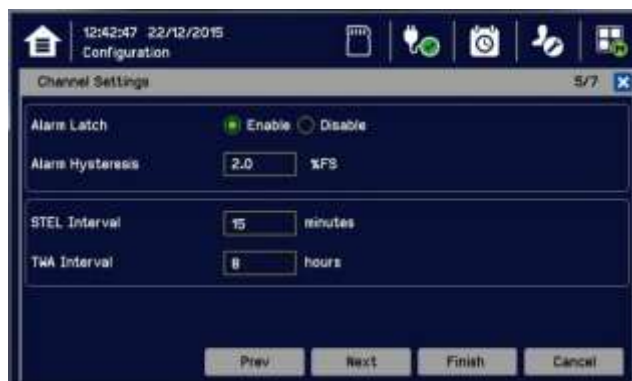

Note: The TWA Interval is fixed 8 hours.

- 11) Touch and enter the [Calibration Interval] and the [Span Gas Concentration] that was used for First Span, then select [Next]:

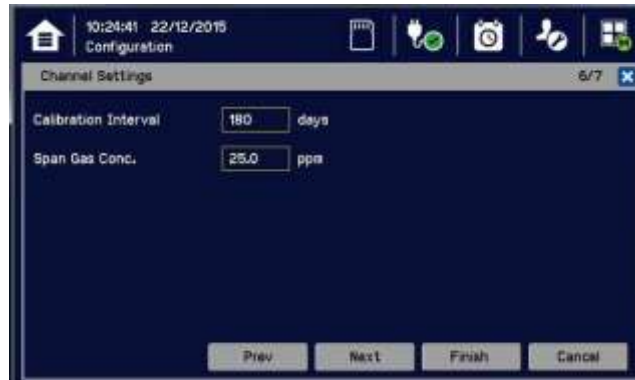

- 12) Touch and change the following [Channel Settings]:



Note: This Window's options tell the system what input values are relevant and actionable. These values shall only be changed by Honeywell Authorised personnel or by qualified personnel trained in accordance with this manual.

Note: [Inhibit Timeout] is a failsafe timeout in case the User forgets to reset a local inhibit. It does not affect Remote Inhibit switches that are either on or off (e.g. key switches).

- 13) Touch **Finish>Apply>Update**.
- 14) Repeat to configure other input channels.

Note: You will have to redo any unsaved changes if the system reverts to an earlier window due to inactivity.

6.14.5 Editing mV Input Channel Settings

- 1) Log in as Service.
- 2) Touch Menu>Configuration>Channel Settings.
- 3) Touch the Input Module to change (circled)...:

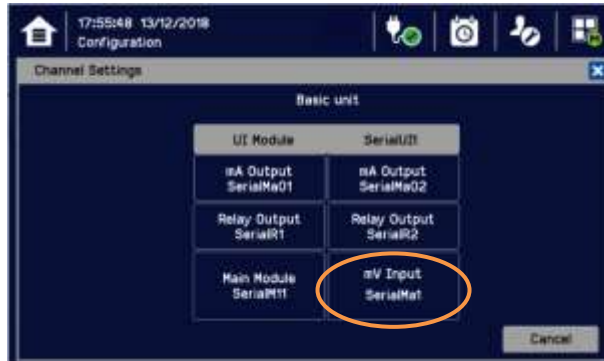

- 4) ...to give this window:

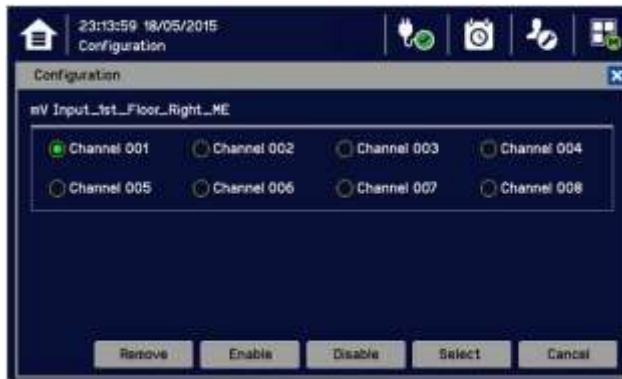

- 5) Touch the [Channel] to change and then touch [Select] to give this window:

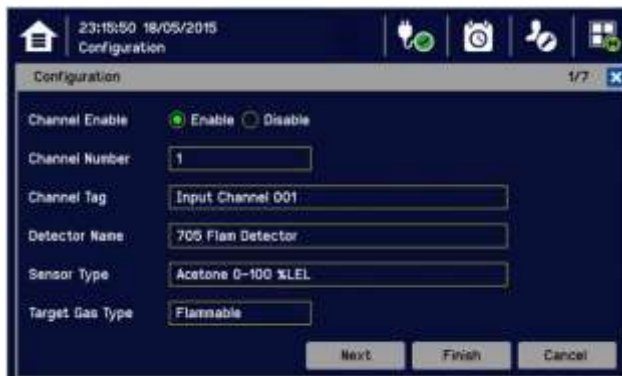

6) Touch the required settings, change details and touch [Select]:

Refer to Ch.16 Compatible Sensors for a list of available detectors.
 You can also use the TPPL Sensor Catalog to select listed gases, or you can enter 'User gas' details if your gas is not listed.
 Refer to Ch. 9.4 How to Update the Sensor Catalogue for further information.

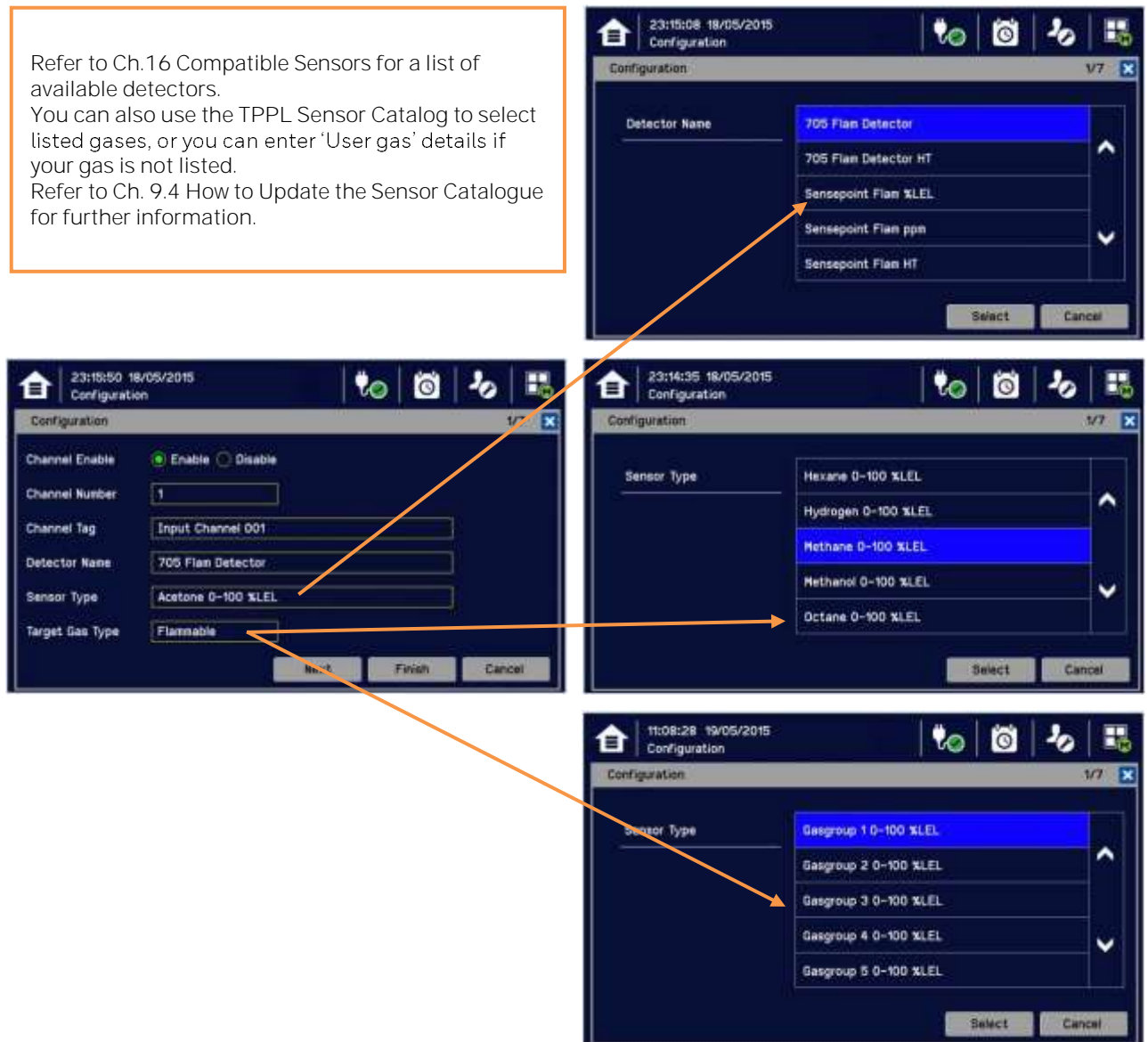

Note: The Target Gas Type is automatically entered by your choice of Sensor Type.

Note: The Sensor Type gases will vary with different types of Detectors. Gases listed with a '-2' suffix are compliant with EN 60079-20-1 LEL levels.

Note: Sensors must be recalibrated when selecting a new target gas.

Note: Refer to sensor's user manual for selection of gas group

Note: Refer to Ch.6.14.4 of mA input channel setting for the additional mV input setting. Note that STEL and TWA are not available for mV input channels.

6.14.6 Editing Relay Output Channel Settings

Prior to starting you should have completed configuring or editing all of the required input channels.

- 1) Login as an Administrator or Service.
- 2) Touch Menu>Configuration>Channel settings.
- 3) Touch the required Relay Output Module (circled):



- 4) To get this window:

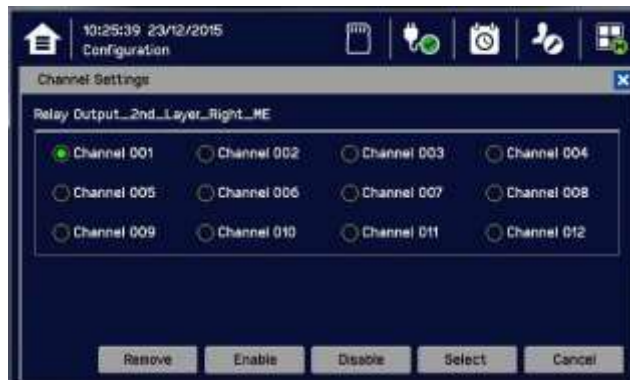

- 5) Touch a channel to commission or edit and touch [Select].
- 6) Touch the buttons and boxes to make changes as required:

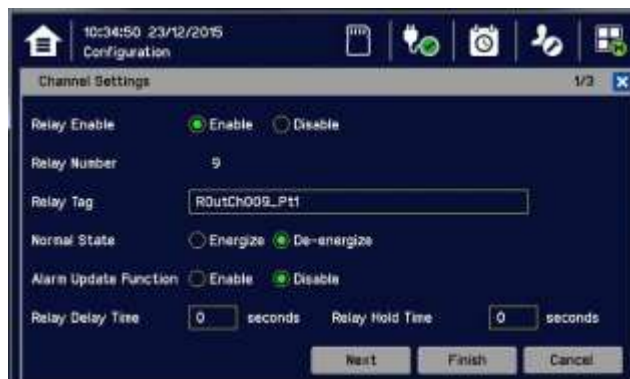

- 7) Touch [Next].
- 8) Choose Count Reduction options. This option allows you to ignore faulty or inhibited detectors for Vote Count purposes (See also 10 below):

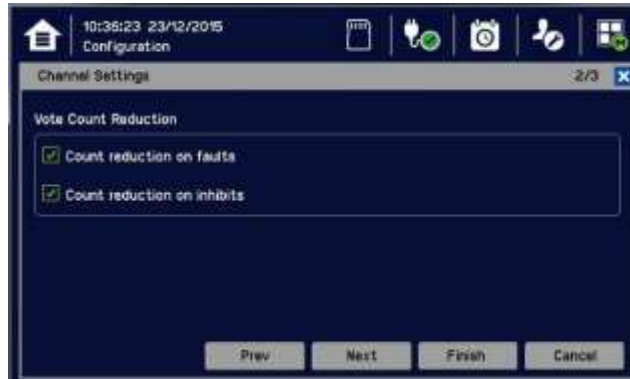

'Voting' is where an installation requires confirmation from at least 2 detectors before it triggers a response.

'Vote Count Reduction' is where the controller can be told to ignore voting channels that are in Fault mode or Inhibit mode or both, and will trigger an event when one or more detectors (not in fault or inhibit) are triggered.

Non-voting detectors are not affected by Vote Count Reduction.

Vote count reduction is applicable for only the relays configured to alarm event.

- 9) Touch [Next] and then choose Inputs (Alarms A1, A2 & A3, Fault, Inhibit & Warnings) to auto-populate all the available channels. Scroll down to see further channels and selectively un-tick if required.
- 10) Touch and enter Vote Count numbers if required (see box above).



- 11) Touch [Finish].

12) Review the settings, scrolling down to see them all:



13) If happy with the settings, touch [Apply]. Wait for the changes to be made.



14) Review again and select [Update].

15) Repeat all to Commission or edit further relay channels.

6.14.7 Editing mA Output Channel Settings

Prior to starting you should have completed configuring or editing all of the required input channels.

- 1) Log in as Service.
- 2) Touch Menu>Configuration>Channel Settings.
- 3) Touch the mA Output Module to change (circled)...:



4) ...to give this window:

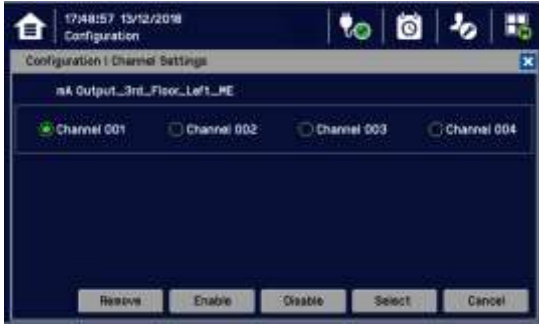

- 5) Touch the [Channel] you want to change and then touch [Select].
- 6) Touch the buttons and boxes to make changes as required:

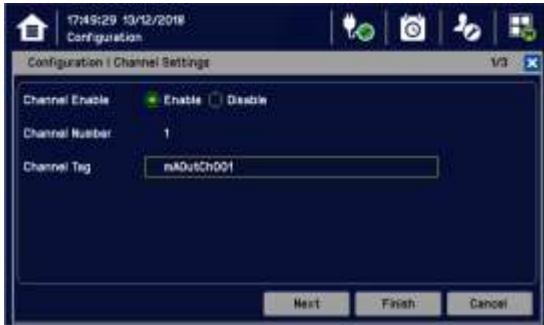

- 7) Touch [Next].

Set special state output levels:



- 8) Touch [Next].

Select input channel to map the mA output

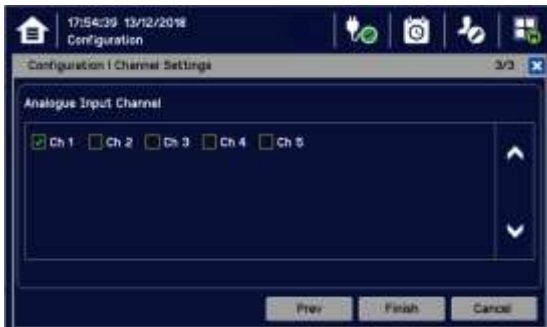

- 9) Touch [Finish].
- 10) If happy with the settings, touch [Apply]. Wait for the changes to be made.
- 11) Repeat all to Commission or edit further mA output channels.

6.15 Calibrating Input Channels

CAUTION – ALARM INHIBIT

For catalytic bead type detectors, the Analogue Input Modules form part of the measuring circuit. Therefore all commissioned mV channels remain in Inhibit state until they are calibrated.

You should consider alternative safety measures when performing these procedures.

6.15.1 Adjusting the mV Sensor Baseline

It is important to select [Adjust mV Baseline] when calibrating a new or replacement sensor for the first time, and [Span] for all calibrations thereafter. This also applies when either the detector type or sensor type is changed during channel configuration, even though the sensor itself remains the same.

CAUTION

Doing this procedure correctly allows you a time window in which to safely organise the replacement of nearly spent catalytic bead sensors.

Doing it incorrectly may result in a spent sensor with incapable gas detection.

To adjust the mV Sensor Baseline:

- 1) Replace the catalytic bead sensor in accordance with its' user manual.
- 2) Check the mV sensor wiring is undamaged and correctly connected.
- 3) Perform the next check under clean air.
- 4) Login as Administrator or Service.
- 5) Touch **Menu>Maintenance>Adjust mV Baseline** and select a **mV input channel**.
- 6) Touch **[Start]**.
- 7) Check mV sensor type setting is correct.
- 8) Carry out the sensor calibration as shown in the next section (the mV input channel will be automatically inhibited during this procedure).

6.15.2 Calibrating a mV Input Channel

It is important to select [First Calibration] when calibrating a new or replacement sensor for the first time.

To calibrate a mV input channel, follow the procedure below in combination with the relevant instructions in the sensor manual.



This procedure requires 2 people in radio or telephone contact.

Only trained technicians are authorized to carry out sensor calibration.

Caution: Ensure that any relay operated devices (drenchers, repeater alarms, etc.) are inhibited before starting this test.

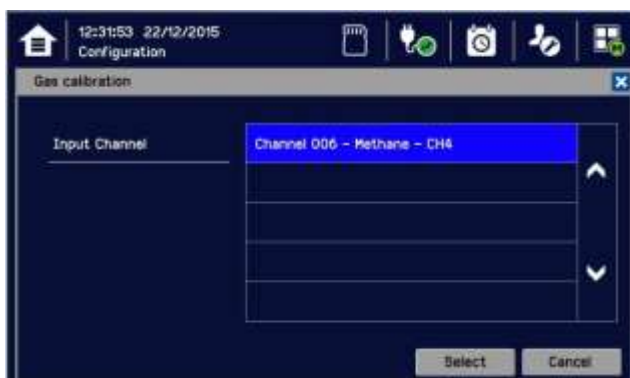
- 1) Log in as **Service**.
- 2) Touch **Menu>Maintenance>Gas Calibration**. Touch the channel to be calibrated followed by **[Select]**.



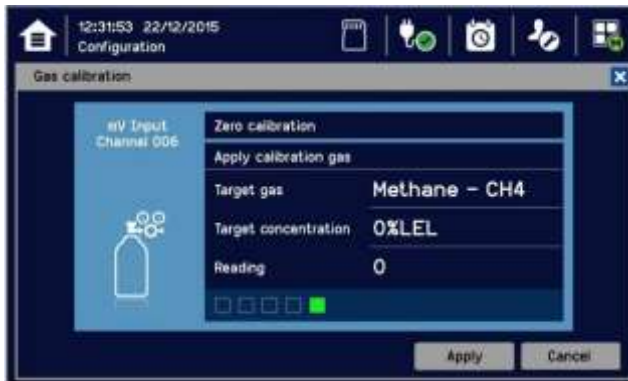

- 3) Touch [Start] while applying clean air to the sensor.
- 4) Wait until the sensor reading  becomes stable .

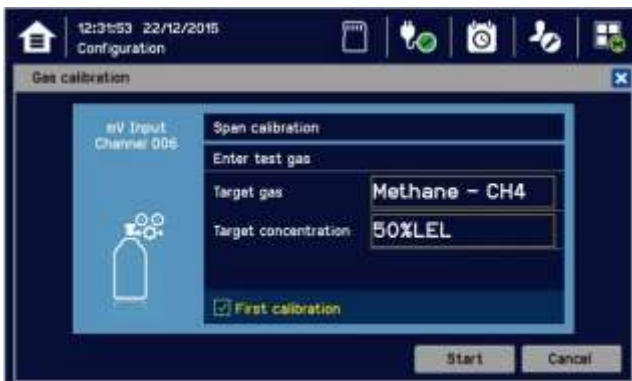

- 5) Confirm the zero calibration reading and then touch [Next].
- 6) Touch [Target concentration.] and enter the target concentration of your span gas (%LEL) followed by [Finish].
- 7) Touch First calibration to toggle it on or off as appropriate. Failing to carry out First calibration on new sensors may falsely reduce their useful life, while carrying it out on used sensors may lead to unexpected sensor failures.
- 8) When ready, touch [Start] and apply your span gas to the sensor.



- 9) Wait until the sensor reading  becomes stable .
- 10) Confirm that the gas reading is correct and touch [Finish]:

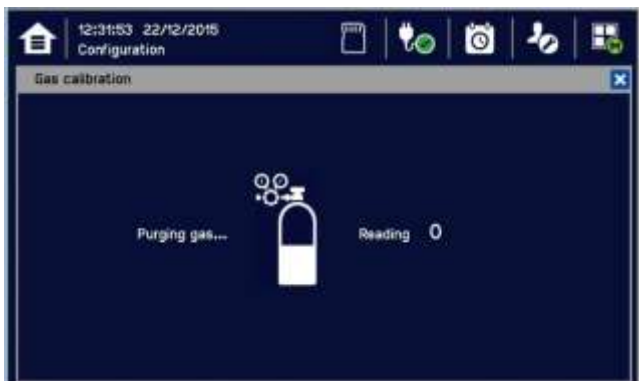
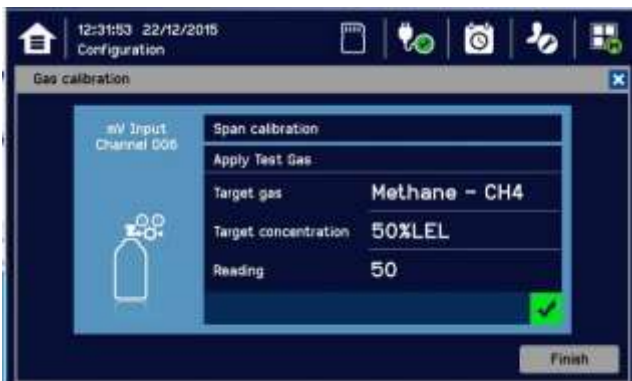

- 11) Remove the span gas from the sensor and confirm that the gas reading has returned to zero. Choose whether or
- 12) not to calibrate another channel

Touchpoint Plus will exit the calibration menu no matter of current gas reading in calibration mode in 45 s after purging gas step. User may see gas alarm if user cannot ensure the gas reading value of Touchpoint Plus lower than alarm level in purging step.

6.15.3 Calibrating a mA Input Channel

To calibrate a mA input channel, follow the procedure below in combination with the relevant instructions in the sensor manual.

This procedure requires 2 people in radio or telephone contact.

Only trained technicians are authorized to carry out sensor calibration.

WARNING

Where the sensor or transmitter has the facility, the mA loop should always be calibrated by forcing signal levels at the sensor / transmitter. Any gas calibration required must be carried out at the field device according to the manufacturer's instructions.

The Touchpoint Plus controller calibration should not be used to adjust for deficiencies in the sensor / transmitter gas calibration. Failure to observe this can result in significant accuracy errors.

Caution: Ensure that any relay operated devices (drenchers, repeater alarms, etc.) are inhibited before starting this test.

The span gas should normally be air at 20.9% v/v Oxygen if the O₂ sensor is not being used with a transmitter that has a force mA function.

The Touchpoint Plus controller calibration should not be used to correct deficiencies in the sensor calibration; instead carry out a gas calibration at the sensor according to the manufacturer's instructions.

To calibrate the mA loop of an input channel, follow the procedure below in combination with the relevant instructions in the sensor manual.

- 1) Log in as Service.
- 2) Touch Menu>Maintenance>Gas Calibration. Touch the channel to be calibrated followed by [Select].

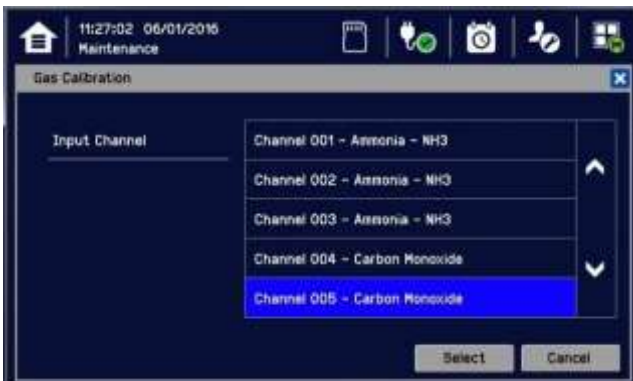

- 3) Touch [Start] while applying clean air to the sensor.
- 4) Wait until the sensor reading becomes stable ✔

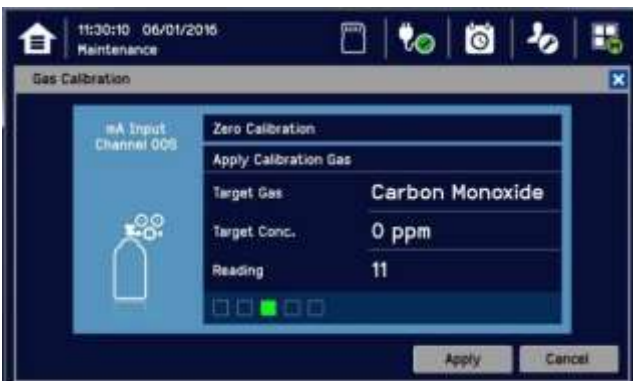

- 5) Confirm the zero calibration reading and then touch [Next].
- 6) Touch [Target Conc.] and enter the target concentration of your span gas (ppm) followed by [Finish].

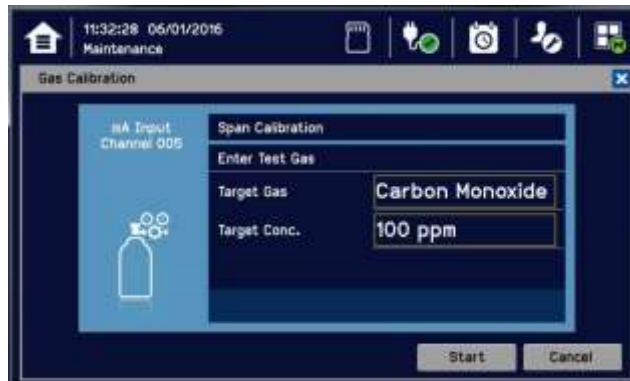

- 7) When ready touch [Start] and apply your span gas to the sensor.



- 8) Wait until the sensor reading becomes stable
- 9) Confirm that the gas reading is correct and touch [Finish]:



- 10) Remove the span gas from the sensor, and choose whether or not to calibrate another channel.

Touchpoint Plus will exit the calibration menu in 45 s after purging the gas, regardless of the current gas reading. A gas alarm can occur if the gas reading value measured by Touchpoint Plus is higher than the alarm level set for purging.

6.16 Backing Up the Configuration Settings

It is recommended that you back up the TPPL configuration once commissioning is completed or when any software, modules or settings are changed. Alternative safety arrangements should be in place during this procedure (if used in a hazardous location, e.g., Class 1 Division 2).

WARNING

If used in hazardous location, power must always be off and isolated before opening the access door, and the door must always be closed and secured during normal operation.

Opening the enclosure will expose live high-voltage terminals that may remain live for a time after power is switched off. Do not touch these terminals or the Earth (Ground) bar as they can cause electric shock and burns.

6.16.1 How to Back Up the Configuration:

- 1) Complete and save all configuration changes.
- 2) Touch **Menu>Maintenance>SD Card>Eject>**
- 3) Touch **Close>Menu>Maintenance>Power-off>Yes** (if used in a hazardous location, e.g., Class 1 Division 2)
- 4) Switch off and Isolate Power (if used in a hazardous location, e.g., Class 1 Division 2)
- 5) Open the access door and locate the SD card slot (see Fig.10 item 2).
- 6) Temporarily replace the installed SD Card with an empty 2 to 32 GB (FAT32) standard SD Card.
- 7) Close the access door, restart the system and wait for it to stabilise.
- 8) Check the SD Card status by touching on either the SD Card or Power Icons:
- 9) Log in as **Administrator** or **Service**.
- 10) Touch **Menu>Configuration>Config Manager>Export**.
- 11) Enter a file name for the back-up configuration file and touch **[Finish]**.
- 12) Touch **[Export]** to continue. The backup may take several minutes, and progress is shown on screen.
- 13) When backup is completed, touch **Menu>Maintenance>SD Card>Eject>**
- 14) Touch **Menu>Maintenance>Power-off>Yes**. (if used in a hazardous location, e.g., Class 1 Division 2)
- 15) Switch off and Isolate Power. (if used in a hazardous location, e.g., Class 1 Division 2)
- 16) Open the access door.
- 17) Replace the Backup SD card with the original card or a new card that has sufficient space to record event data.
- 18) Close the enclosure door and tighten the two handle security screws.
- 19) Switch power on and return the system to normal operation. Touch the SD Card Icon to confirm the SD card status.
- 20) Transfer the backup data to a dated folder on a PC or digital device for safekeeping. The Configuration backup file is stored on the SD Card in **\\CFG\TPP_CFG.bin**
- 21) You can reuse the card once the backup file has been transferred.

6.16.2 How to Restore the Configuration

To restore a configuration, you must first copy the stored file `[Your PC] \\CFG\TPP_CFG.bin` to the root directory of an empty SD card (FAT32), and then an Administrator must follow the reverse process of backing up, i.e. use [Import] instead of [Export].

Note: `\\CFG\TPP_CFG.bin` must be inside the specific folder on the SD card.

Note: Before attempting to restore from a saved configuration you must ensure that the current status is exactly the same as it was when the backup file was exported. In other words the module installation status and commissioning status must be exactly the same or the system will not import the configuration data.

CAUTION

Restoring the configuration does not include the gas calibration data. It could be necessary for user to conduct the gas calibration after restoring the configuration.

Chapter 7. Touchpoint Plus User Guide

WARNING

Do not operate TPPL with the door insecure.

The TPPL Touchscreen provides the primary means of control and viewing. Secondly, the Web Interface can be used for remote viewing (see Ch.7.17 Monitoring TPPL via the Optional Web Interface).

7.1 User Interface General

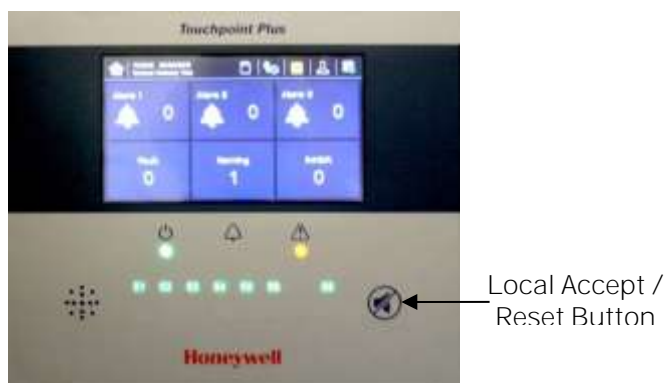

Figure 47. Touchpoint Plus Controller User Interface

The User Interface panel (shown above) has:

- A colour Touch screen for normal system operation, maintenance and configuration
- Power, Alarm / Fault and Inhibit state LEDs
- Active Channel (01 to 08) status indicators (Channel 07 is not commissioned in this example)
- Active Expansion Channel (09 to 16) status indicators (not commissioned above)
- Accept* / Reset membrane button (arrowed above)
- Integral Alarm Buzzer (Left side)

*The membrane button acknowledges and silences active alarms and resets latched alarms, depending on the situation and how long it is pressed. See Ch.7.8 Responding to Alarms for further information.

Further System Interfaces consist of:

- Remote inhibit and remote reset terminals in the Main module
- One fixed relay and two configurable relays in the Main Module for System Failure, Alarm and Inhibit
- Three dedicated alarm outputs for visual and audio alarms
- An SD Card slot for data logging and firmware/software updates
- An optional expansion unit with optional dual input module (mV & mA)
- Optional remote Web Interface networking via RS485 port
- Optional remote Modbus TCP/IP via hard-wired terminal

7.2 Touchscreen

The Touchscreen is touch only and does not support swipe or pinch gestures.

The Touchscreen has four access levels: View mode is available to all users while Configuration, Maintenance and System Test functions are password protected. (See Ch. 7.4 Menu Items and Access Levels for further information.)

There are only three passworded accounts: Administrator, Service and Operator, and their passwords must be carefully guarded.

Lost passwords can only be replaced by someone higher which, in the case of the Administrator, will be a Honeywell representative.

Password holders should be assigned to one access level only.

7.3 Switching On and Off

Before switching power on, ensure that the system has been commissioned or that a qualified person has checked that the wiring is safe and conforms to local regulations. Also check that the battery isolator switches are in the correct position and that an SD Card is fitted. Check that the optional expansion unit battery switches are in the correct position.

Switch on power at the Isolator switch and wait for the system to initialise. (The system start up sequence may last for up to 5 minutes depending on the number of channels in use.)

TPPL will first display the auto-scrolling Input screen, indicating the current status of the system. The Channel List View is shown below. The screenshot shows installed sensors but it may be blank depending on your system status:



You can alter the screen views or gain further information by touching the icons shown below:

	Toggle to select screen layout		Admin Logged in
	SD Card Status Good		Service Logged in
	SD Card Status Fault		Operator Logged in
	External mains power is connected. Touch for status		No one Logged in
	External power is not connected. Touch for status		Toggle auto-scroll on and off
	Event History (changes colour to show fault, inhibit or alarm)		Scroll up when auto-scroll disabled
	Further Menu Options		Scroll down when auto-scroll disabled

Table 13. Home Screen Menu Icons

7.4 Menu Items and Access Levels

The table below details the menu items and access levels for the User Interface. The password hierarchy is Administrator, then Service, then Operator. Broadly speaking, the Administrator can do everything, the Service Engineer can edit channel configuration and do maintenance and calibration, and the Operator can view, acknowledge and reset events. (Viewing basic System Information and Status does not require a password.)

A user can log in by touching the log in icon, selecting an access level and then entering a valid password.

Note: Logged in users are automatically timed out after fifteen minutes of activity. For security reasons do not leave the Touchscreen unattended while logged in.

Note: If user fails the password 10 times consecutively, Touchpoint Plus log-in is locked for all access levels. After 10 minutes, log-in becomes available.

Note: Admin account is only valid for authorized service engineer and its delegation. The user is responsible for permitting the use of admin account under special maintenance case, e.g. maintenance << Service Mode << Electronic Adjustment.

There are two kinds of timeout in menu mode. One is 'menu timeout' and the other is 'authentication time out'. With 'menu timeout', the display will change to a higher menu and then back to the Channel Status screen if there is no touch input for a pre-set time. The default menu timeout is 90 seconds, but this can be changed using menu options Configuration>General>Timeout.

For security reasons 'authentication timeout' will log you out automatically when there is no Touchscreen activity during the set time. Changes may be lost and the user will have to log in again.

Items with a clock symbol time out after 15 minutes of inactivity.

The default time out is 10 minutes for the pop-up menu.

Key: ● = Allowed, ○ = Denied, ⌚ = Fixed timeout
 ↪ = sub-menu, ↪↪ = sub-sub-menu

Menu Item	Admin.	Service	Operator	Others
Login ⌚	●	●	●	○
Menu Home	●	●	●	●
Event History	●	●	●	●
Channel View Home	●	●	●	●
↪ List View	●	●	●	●
↪ Tile View	●	●	●	●
↪ Summary View	●	●	●	●
↪ Output View	●	●	●	●
Information				
↪ System Info	●	●	●	●
↪↪ Summary Info	●	●	●	●
↪↪ Software Info	●	●	●	●
↪↪ Parameter Info	●	●	●	●
↪ Event History	●	●	●	●
↪↪ Filter View	●	●	●	●
↪↪ Export History	●	●	●	●
↪ Trend/Plot	●	●	●	●
↪ Channel Info	●	●	●	●
↪ Module Info	●	●	●	●
↪ Relay Status	●	●	●	●
↪ Additional Status	●	●	●	●
↪ Network	●	●	●	●

Menu Item	Admin.	Service	Operator	Others
↵ Service Contact	●	●	●	●
Configuration	●	●	○	○
↵ Channel Settings	●	●	○	○
↵↵ mA Input Channel	●	●	○	○
↵↵ mV Input Channel	●	●	○	○
↵↵ mA Output Channel	●	●	○	○
↵↵ Relay Channel	●	●	○	○
↵ Module Control Panel	●	●	○	○
↵ General	●	●	○	○
↵↵ Date / Time	●	●	○	○
↵↵ Language	●	●	○	○
↵↵ Service Contract	●	●	○	○
↵↵ Home Settings	●	●	○	○
↵↵ Timeout Setting	●	●	○	○
↵ Log Interval and Threshold	●	●	○	○
↵ Display Screen	●	●	○	○
↵ Outputs	●	●	○	○
↵↵ Dedicated Alarm Contacts	●	●	○	○
↵↵ Buzzer Options	●	●	○	○
↵ Security	●	●	○	○
↵↵ Password	●	●	○	○
↵↵ Remote Access (Buttons)	●	●	○	○
↵ Config Manager	●	●	○	○
↵↵ Import	●	●	○	○
↵↵ Export	●	●	○	○
↵ Network	●	●	○	○
↵↵ Ethernet	●	●	○	○
↵↵ Modbus RTU	●	●	○	○
Maintenance	●	●	●	○
↵ Reset Alarms / Faults	●	●	●	○
↵ Reset All Peaks	●	●	●	○
↵ Gas Calibration 🚫	●	●	○	○
↵ Adjust mV Baseline 🚫	●	●	○	○
↵ Service Mode 🚫	●	○	○	○
↵↵ Electronic Adjustment 🚫	●	○	○	○
↵↵ Reset to Defaults 🚫	●	○	○	○
↵ Update System 🚫	●	○	○	○
↵↵ Software 🚫	●	○	○	○
↵↵ Language 🚫	●	○	○	○
↵↵ Sensor Catalogue 🚫	●	○	○	○
↵↵ Module Data 🚫	●	○	○	○
↵ SD Card	●	●	○	○





















Menu Item	Admin.	Service	Operator	Others
 Eject	●	●	○	○
 Format	●	●	○	○
 Power Off 	●	●	○	○
System Test	●	●	○	○
 Force Relay 	●	●	○	○
 Force 4–20 mA 	●	●	○	○
 Relay C & E Matrix 	●	●	○	○
 Dedicated Alarm Contacts 	●	●	○	○
 LCD test 	●	●	○	○
 LED & Buzzer test 	●	●	○	○

Table 14. User / Component Matrix

7.4.1 Navigation – Active Access Level Icons

You must enter a valid password to access the menu items listed above. (See Ch.6.3 Logging In/Out.)

The silhouette icon shows who is logged in. Touch the icon to log in / out, or to change to a higher access level:

	No one is logged in
	Operator is logged in
	Service engineer is logged in
	Administrator is logged in

Note: The system will log you out after a set period of inactivity. (The default authentication timeout is 15 minutes, but this can be changed in system settings.)

7.5 SD Card Usage

The SD card is used to store the system event history and trend logs. The SD card should remain fitted during normal operation of the controller to avoid loss of event data.

The card may also be used when backing up and restoring the system configuration.

The Touchpoint Plus accepts standard size SD cards of 2 to 32 GB, using FAT32 formatting. New SD cards must be formatted by the Touchpoint Plus system when they are first used, as described below. SD cards formatted by Touchpoint Plus can be used in a standard PC, with an adaptor if necessary, with normal read/write access.

Formatting the SD card deletes all existing data. This is not reversible.

SD cards must be write-enabled before use.

Touchpoint Plus monitors the SD card use and warns the user when there is less than 50MB of free space remaining, and when the SD card is full.

If the SD card is not replaced or more space made available, the Touchpoint Plus continues to log data by overwriting the oldest data. Overwritten data is not recoverable. A further warning is given when data is being overwritten,

The SD card icon on the front panel changes to yellow if the Touchpoint Plus is unable to save data or the SD card is being overwritten.

The system will continue to function correctly as a controller if there is no SD card fitted or data cannot be saved. The safety function is not affected.

To avoid fragmentation of logged data, only one SD card should be in use at any time. If the SD card is removed, it should not be temporarily replaced by another SD card as event data will be logged on the replacement card until the original card is returned. The data stored on the temporary card cannot be used by the Touchpoint Plus.

Data will be cached for up to 5 minutes when the SD card is removed, and written to the SD card when it is replaced. Data will be lost if the SD card is not replaced within this time.

Logged Data

Logged data is stored in CSV format and can be read by standard spreadsheet or database software. Note that some older spreadsheet software may have a row size limitation and may not be able to read the entire event log file.

Directory

Directory/filename	Data	Creating
:/LOG/GASDATA/MMMYYYY/YYMMDD.csv	Gas logging data	Every day
:/LOG/GASDATA/MMMYYYY/YYMMDDHHNNSS.csv	Updated parameters	Every day
:/LOG/EVENT/EVTTYMM.csv	Event log	Every month
:/LOG/EXPORT/EVTTYMMDDHHMMSS.csv	Exported event history	User on demand
:/LOG/EXPORT/EVTTYMMDDHHMMSS.csv	Exported configuration	User on demand

7.5.1 Checking the Capacity of the SD Card

There are three ways to check the SD Card size and remaining space:

- Touch **Menu>Information>Additional Status**.
- Touch the SD Card icon in the menu toolbar (no icon = SD card not fitted, yellow icon = needs checking).
- Touch the Power Supply icon in the menu toolbar.

SD Card Usage	
Available	10.7 GB
Total	16 GB

7.5.2 Inserting or Replacing SD Cards

Note: Incorrectly removing or replacing an SD card may result in data loss or corruption.

WARNING

Always turn off and isolate the system before opening the door. Do not switch back on until the door is reclosed and secured. Do not operate TPPL with the door insecure. Take alternative site safety precautions while power is off.

To Insert or Replace an SD Card:

- 1) Log in as **Admin** or **Service**.
- 2) Touch **Menu>Maintenance>SD Card>Eject>**
- 3) Touch **Close>Menu>Maintenance>Power-off>Yes** (applies only to Class 1 Division 2)
- 4) If in a hazardous area, turn off and isolate the system.
- 5) Open the access door and locate the SD card slot (see Fig. 10 item 2).
- 6) Insert or replace the card in the SD card slot.
- 7) Note: the SD card is retained by a spring clip immediately above the card. Press the clip to remove or replace the card.

8) Check the SD Card status by touching on either the SD Card or Power Icons:



- 9) If the SD Card is new, full or has a fault, log in as Admin or Service.
- 10) Touch **Menu>Maintenance>SD Card>Format>Yes**
- 11) Close the window and log out when finished.
- 12) Re-check the SD Card status by touching on either the SD Card or Power Icons again.

CAUTION
 Formatting the SD card will irreversibly erase all existing data.

7.6 Normal Operation (Safety Functions)

During normal operation:

- The Touchpoint Plus system will collect sensor data every 1 second.
- Input channel gas calculation is compared to alarm setpoints every 500 ms.
- Input channel gas calculation is checked for over/under range value every 500 ms.
- Cycle time of the Main Module is 1 second until data are sent to the output modules (UI, relay, mA)
- Any failure of the safety function i.e. due to major fault or power loss will activate the System Failure relay. System Failure relays are updated at the end of each 1 second cycle.
- The Cause and Effect matrix will be evaluated every 1 **second**, and commands sent accordingly to the appropriate output channels.
- Any change in status of an I/O channel will be reported to the User Interface and logged in the event history.
- Events (Alarms, Faults, Inhibits, etc.) will be reported to the User Interface and logged in the event history.
- Be careful with the mA output and relay setting as user can configure the setting of mA output and relay operation. Below table shows the recommendation of mA output and relay setting for safety function of Touchpoint Plus. One of either RLY1 or RLY2 in main board shall be configured to system inhibit relay

State	System Failure Relay	System Inhibit Relay	mA output
Normal	Normal energized	Normal energized	4-20 mA
Fault	De-energized	NA	1 mA
Inhibit	NA	De energized	2 mA

- In case of negative drift (underscale) and over-range (overscale), Touchpoint Plus shows the signal outputs as below:

State	LCD Display	Relay	mA output
Negative drift	Fault (Red colour)	System Failure relay	Fault output (Default <=1mA)
Over range	Warning (Blue colour)	Alarm/Warning relay by user relay configuration	Over range output (20-21.5mA)

- The system response time of Touchpoint Plus is 3 s. However, the gas response time of Touchpoint Plus will be increased more of input sensor's time of response.
- Touchpoint Plus monitors the internal communication. In case of communication error detected, Touchpoint Plus will generate the communication fault in 5 s.

7.7 Operating Overview

Refer to Ch.15 Icon Glossary for more information.

7.7.1 Touchscreen

The colour Touchscreen is activated using a finger or a soft stylus. Do not use sharp or abrasive objects as they may cause irreparable damage.

All interactions are single tap (no gestures or swipes). Some actions open a new Window. Windows may be closed by touching the X or [Cancel] button, or by touching the [Home / View] button.

7.7.2 User Interface Screen

The icons in the navigation toolbar are used to toggle through the User Interface options, as shown in the tables below.



	Channel List View		Manual Scrolling Toggle (the list and all events can be manually scrolled)
	Channel Tile View		Auto Scrolling Toggle (active events are locked at the top of the list, other events scroll down)
	Channel Summary View		Scroll the list up
	Output Channel List View		Scroll the list down

Table 15. Home Screen Icons













Notes:

- Flashing Colour – New Events
- Steady Colour – Acknowledged Events
- Channel List View – Display shows up to six inputs and events with automatic or manual scrolling.
- Channel Tile View – Display shows up to eight inputs and events.
- Channel Summary View – Display shows total counts for alarm 1, alarm 2, alarm 3, fault, warning and inhibits.
- Output Channel List View – Display shows up to eight outputs and events.

Events flash until acknowledged and stay coloured until the causative event is cleared / reset.

Touch any colour, channel or event to see more information. You can also touch a filter icon (see below) to show only items in that colour band.



	Alarm Filter		History Information
	Fault Filter		Alarm History
	Inhibit Filter		Fault History
	Warning Filter		Inhibit History
	Filter Information		Warning History
	Filter Refresh		Toggle View

Filters only show during active events but you can use them to instantly filter multiple events for clarity.

7.7.3 Navigating the Channel Detail Screens.

Touch an individual channel or item to display more details:



Refer to Ch.15 Icon Glossary for further information.

7.7.4 Navigation – Active Events and Filtering

You can change the list type by touching a filter from one of the Tile views.

Event data may be exported to the SD card by touching **History>Export Event**

Note: In event view display, events are displayed in an order of priority: Alarm > Fault > Inhibit > Warning.



7.7.5 Navigation – Menu

User must have the appropriate access level to enter Maintenance, Configuration and System Test options.

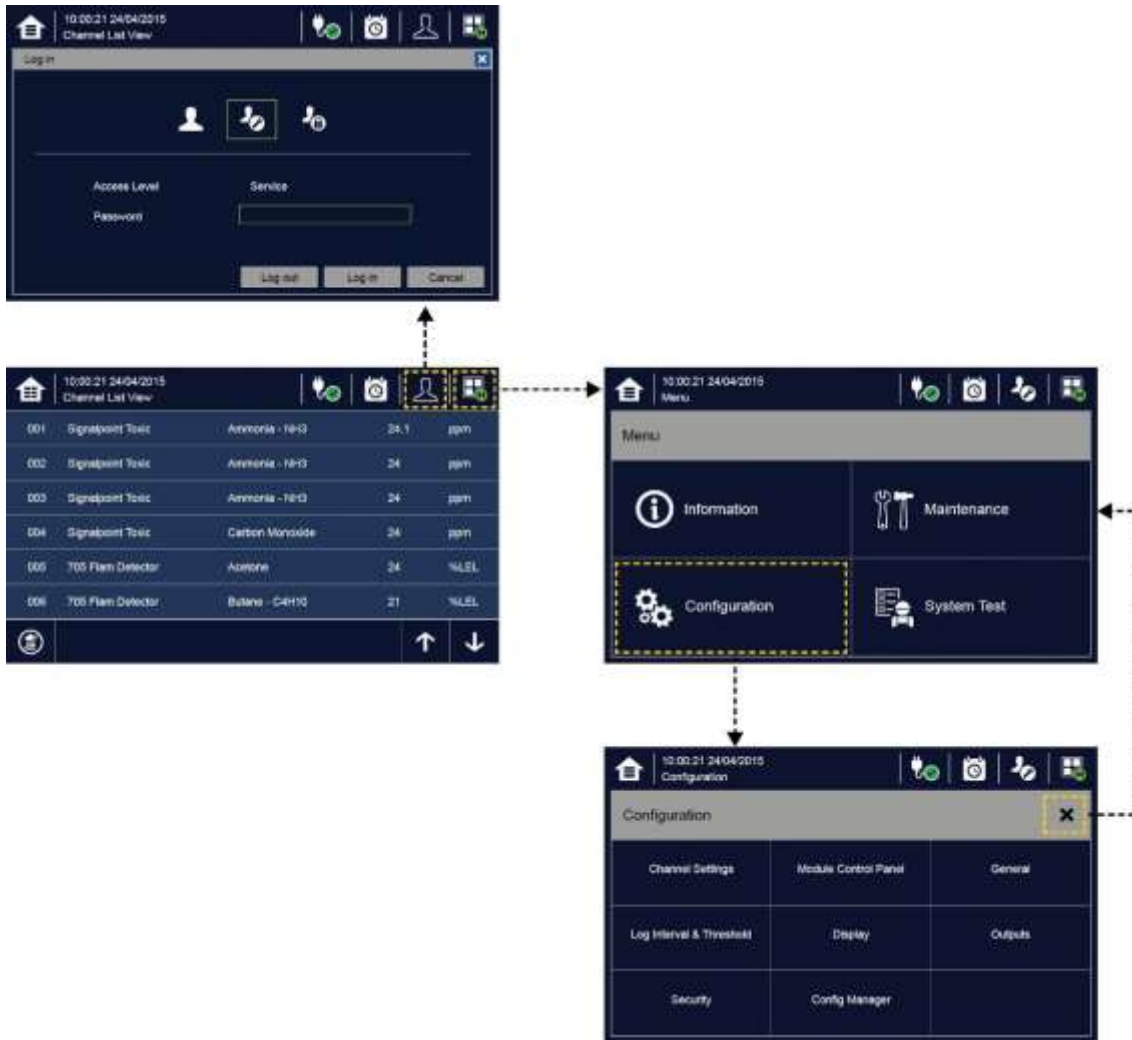

Inactivity Timeout

The user will be logged out after a period of inactivity. (Menu->Configuration->General->Timeout) Changes may not be saved.

7.8 Responding to Alarms

7.8.1 Remote Reset and Acknowledge Switches

Touchpoint Plus supports an optional remote Acknowledge or Reset switch which can be used to acknowledge or reset certain events. These switches do not require a user login.

To prevent unauthorised activation, access should be restricted, for instance by use of a lockable switch. Refer to Figure 25.

7.8.2 View Active Alarms

Active alarms can be viewed:

- 1) At the Input screen, touch the red filter icon to display a list of the active Alarms, starting with the most recent event.
- 2) Unacknowledged alarms will flash.
- 3) Touch any alarm to view more information.



Note: The display will show the channel ID location tag. The highest priority alarm will be shown if more than one alarm has been triggered on the same channel.

7.8.3 Accept or Acknowledge an Active Alarm

Ensure that the alarm has been investigated and required safety actions completed before attempting to reset an alarm.

To acknowledge an alarm, log in and press the  button for at least one second, which will:

- silence the alarm
- stop the channels, LEDs and icons flashing
- acknowledge all active events except Faults

Note: Check for new alarms if the sounder restarts after you have acknowledged it.

Note: If a Relay Output channel has the Alarm Update function enabled, the alarm will be ignored for the Cause and Effect matrix once it is acknowledged.

7.8.4 Reset a Latched Alarm

A latched alarm is one that cannot automatically reset itself when the triggering event has cleared.

Note: Operator or higher access level is required

A latched alarm can be reset in three ways:

- 1) By logging in and pressing the  button for >3 seconds. This will reset ALL latched alarms, faults and warnings, provided that the triggering event has cleared. It will also reset any latched relay outputs.
- 2) By logging in and selecting **Menu>Maintenance>Reset alarms/Faults**. This will reset all latched events for the channel, provided that the input signal has returned to Normal status.
- 3) By holding the Remote reset switch for >3 seconds.

Note: Alarm/Event reset will only work when the triggering event has cleared (e.g. gas alarm, fault situation and etc.)

WARNING

A gas detector may indicate that the gas concentration in its vicinity has dropped to a safe level, but this does not mean that a dangerous atmosphere doesn't persist elsewhere in that area. Do not reset the alarms until the area has been confirmed to be safe or has been adequately ventilated.

In case of mV sensor's over-range alarm, user shall not reset the over-range alarm until it is verified that the flammable gas has cleared.

7.9 Event Information

7.9.1 Viewing Event Information

Detailed information about active events can be viewed in several ways:

- by touching the actual event to show detailed information about that channel.
- by touching one of the available filter icons on the bottom toolbar. The screen will then show a list of only the chosen type of active events, and each event can be touched to show detailed information about that channel.
- by touching the  icon to change the view layout (not all screens have filter icons).
- Refer to the Ch 7.14 for export of Event history.



7.9.2 Accepting / Acknowledging Active Events

Note: Accept and Acknowledge have the same meaning in this context. Acknowledging an event will not reset latched events.

Active events can be acknowledged by logging in and pressing the  button for >1 second. This will acknowledge ALL active events and the flashing will stop.

7.9.3 Resetting Latched Events

Note: Password access is required.

Acknowledged latched events can be reset in three ways:

- 1) By logging in and pressing the  button for >3 seconds. This will reset ALL latched alarms, faults and warnings, provided that the event has cleared. It will also reset any latched relay outputs.
- 2) By logging in and selecting **Menu>Maintenance>Reset Alarms/Faults**. This will reset all latched events, provided that the input signal has returned to Normal / within tolerance.
- 3) By holding the Remote reset switch for >3 seconds.

Note: Alarm/Event reset will only work when the triggering event situation has cleared (e.g. gas alarm, fault situation etc.). In case of mV sensor's over-range alarm, user shall not reset the over-range alarm until it is verified that the flammable gas has cleared.

Note: The fault events are always latched except the communication fault.

7.10 Inhibiting Channels

Note: Service or higher access level is required.

7.10.1 To Inhibit Input Channels:

- 1) Log in as Administrator or Service
- 2) Touch a channel, then touch the inhibit icon:  and then touch **[Yes]**
- 3) Or use a Remote Inhibit input (key-locking) switch.
- 4) Or set input channel gas sensor to inhibit mode so that Touchpoint Plus will receive respective current.

7.10.2 To Clear Inhibits:

- 1) Log in as Administrator or Service
- 2) Touch an inhibited channel, then touch the inhibit icon:  and then touch **[Yes]**
- 3) Or use a Remote Inhibit input (key-unlocking) switch.
- 4) Or Touchpoint Plus's channel in inhibit mode will automatically clear an inhibit when input channel gas sensor's inhibit is cleared

Note: An auto-inhibit cannot be cleared manually. Auto-inhibits may occur during calibration or warm-up, when a transmitter is signalling Inhibit, or when an Inhibit delay time is running.

7.10.3 To Change Inhibit Timeouts

- 1) Log in as Administrator or Service
- 2) Touch a channel, then touch the Settings icon: 
- 3) Touch [Next] repeatedly until you reach page 7/7, as shown below:



- 4) Touch the chosen value, enter a new value, and touch [Finish]>[Finish]>[Apply]. Refer to Ch.15 Icon Glossary for further information.





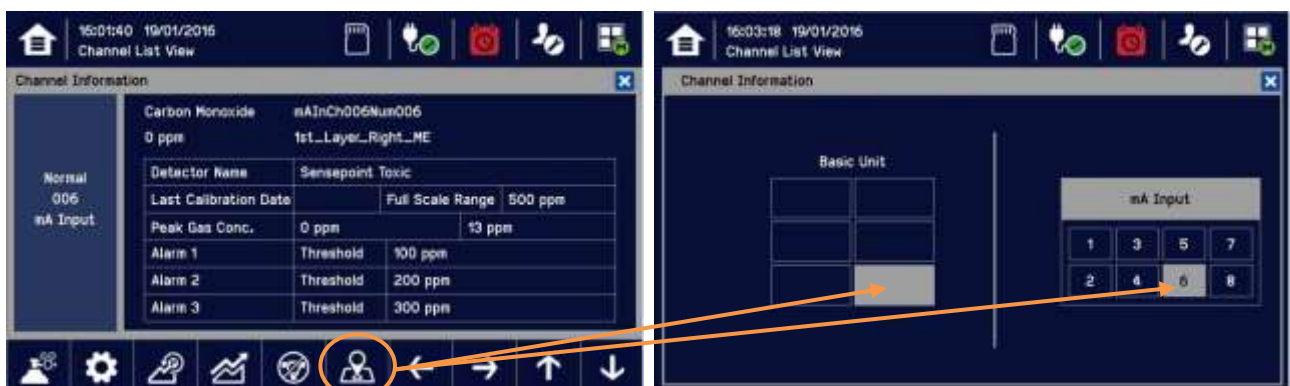

Note: Inhibit timeout setting is available in the Configuration menu. Inhibit timeout will not work for inhibits activated by the remote inhibit input or the signal of an input channel gas sensor.

7.11 Viewing Input Channels and Input Details

From the Input screen, toggle the  icon between Channel Tile>Channel Summary>Channel Output.

- 1) From the Input screen, select Channel List or Channel Tile.
- 2) A list of all input channels is shown in order of channel ID. The channel ID, gas name, status, min/max peak gas concentration and current reading will be shown.
- 3) The list can be filtered by status – Alarm, Fault, Inhibit, Warning or All.
- 4) Touch a channel and the Channel detail (left below) screen will appear. Depending on access level, a number of options will be shown (see Ch.15 Icon Glossary for Icon names):





Function	Icon	Access Level	Comment	
Channel Detail	—	Viewer	Shows detailed information about the channel including Custom ID, sensor and gas name, gas reading, configured alarms and alarm levels.	
Calibration		Service	Option to calibrate the channel.	
Channel Settings		Service	Change the input channel settings.	
Peak reset		Service	Reset peak reading of the channel.	
Trend / Plot		Viewer	Shows the trend graph for the channel. See Normal Operation, View Trend Graph for more information.	
Inhibit		Service	Inhibits the channel. On an inhibited channel, this option is Clear Inhibit. See Normal Operation, Inhibit for more information.	
Channel location		Viewer	Shows the physical position of the I/O Module and channel (see pictures above).	
		Viewer	Scroll Left, Right, Up, Down.	

7.12 Viewing Output Channels

From the Input screen, toggle the Home icon  between Channel Tile>Channel Summary>Channel Output.

- 1) From the Input screen, select Channel List or Channel Tile.
- 2) A list of all output channels is shown in order of channel ID. The channel ID, location tag and status are shown.
- 3) The list can be filtered by status – Fault, Inhibit, Warning or All.
- 4) Touch a channel and the Channel detail screen will appear. Depending on access level, a number of options will be shown:

Function	Icon	Access Level	Comment
Channel configuration		Service	Change the output channel configurations: Inhibit, Fault, Warning, and Over-range output level
Linked input Channel Nr.		Viewer	Display an output channel number that is mapped to the terminal number

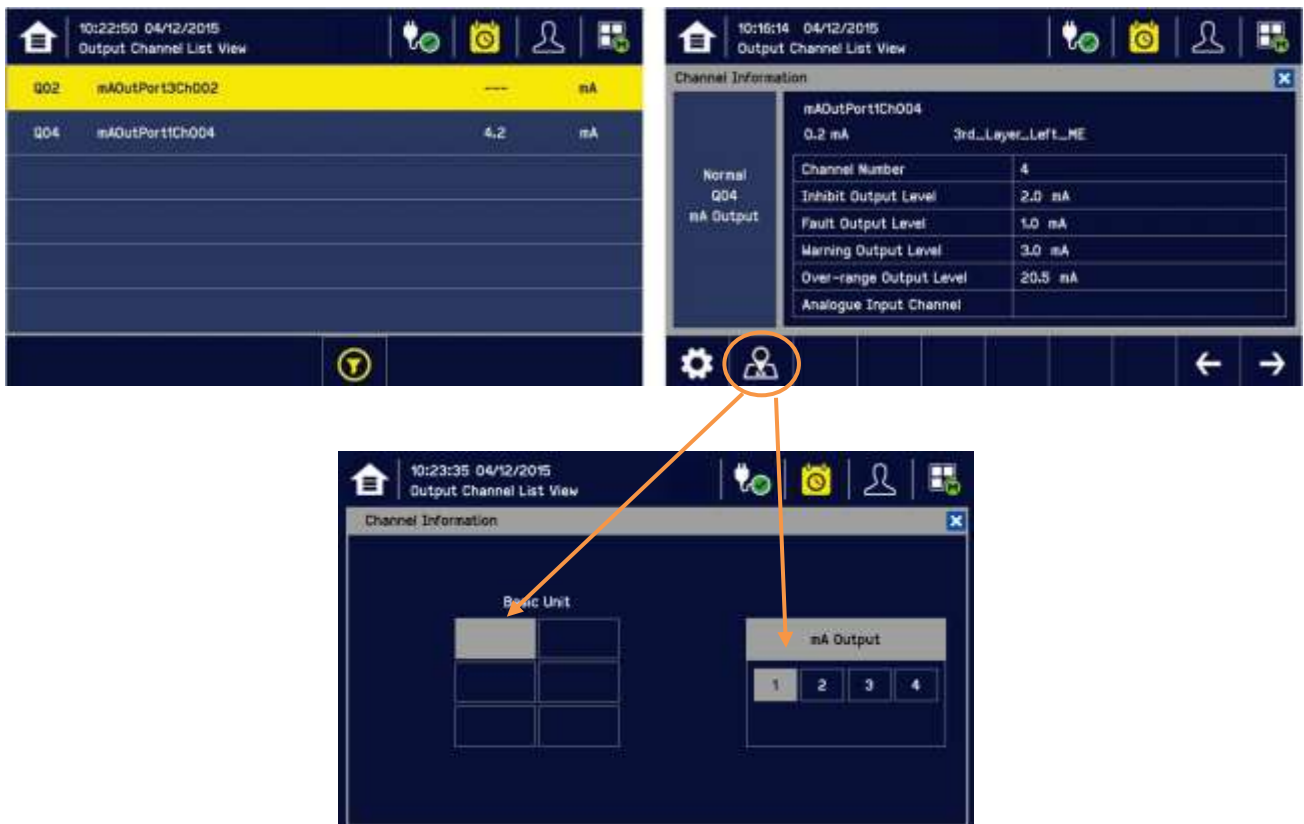

7.13 Viewing the Trend Graph

The Trend graph is used to view signal variation over a period of time.

To view the graph:

- 1) Touch the **Menu Icon**>**Information**>**Trend / Plot**.
- 2) Touch the required channel, and then touch **[Select]**.
- 3) Select the required **Data Range** (1/2/4/8 hours) and then touch **Plot**. (**Alarm Threshold** is shown by default.)
- 4) The trend graph will be displayed. Use the arrows to move backwards or forwards in time; use the **X** or **[Cancel]** to exit.

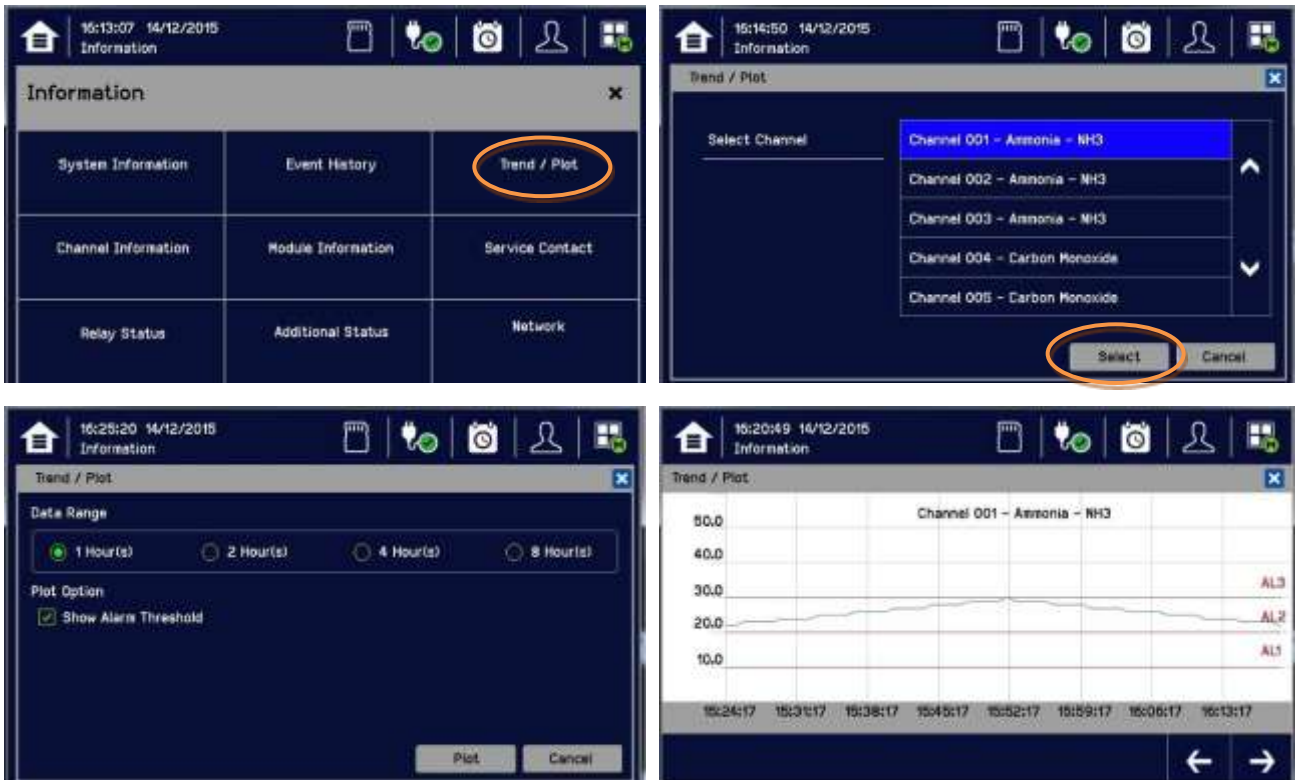

Note: The Touchpoint Plus Trend / Plot will retain up to the latest 8 hours of data but will be cleared after a power reset.

Note: Readings are averaged over one minute periods. Short term variations of less than one minute cannot be viewed.

Note: Touchpoint Plus does not adjust automatically for daylight savings time but it will retain a backup of the earlier data if the system clock is backdated (e.g. when ending daylight savings time).

7.14 Viewing and Exporting Event History

The event history for the complete system can be viewed in date order (latest first). The history can be filtered by Alarm, Fault, Inhibit, or Warning.

Note: Touchpoint Plus does not adjust automatically for daylight savings time. So it will retain a backup of the earlier data if the clock is backdated (e.g. when ending daylight savings time).

7.14.1 To View the Event History:

Touch **Menu>Information>Event History**, then touch the **Filter** icon of choice or scroll through the list.

7.14.2 To Export the Event History:

First touch the SD Card icon to ensure that you have sufficient empty space on the SD card.

Touch **Menu>Information>Event History**. Select the events of interest, using filters if required, and touch **Export Event**.

The event history is exported to SD card: \LOG\EXPORT\EVYYYYMMDDhhmmss.csv in CSV file format. It may be opened by standard spreadsheet, database or text editing programs.

Some earlier versions of spreadsheet software are limited to 65,526 entries and may not show all exported events. In this case it may be necessary to use later software.

7.15 Accessing the System Information and Service Contact Details

Touch **Menu>Information>System information** to view details about the Firmware, Software and serial numbers.

Touch **Menu>Information>Service Contact** or see the back page of this manual for details of how to access technical support.

7.16 System State and System Failure Relays

The Main Module has three relays (30 VDC or 250 VAC, both 1.7 A):

- One or both System State relays can activate if there is any active alarm, fault, warning or inhibit in the system (if configured).
- The System Failure relay can activate if the safety function of the system is not operating, for example due to a major fault or power loss.

Refer to the Ch 7.6 and Figure 19 for further information.

Note: One of either RLY1 or RLY2 in main board relay shall be configured to System inhibit Relay.

7.17 Monitoring TPPL via the Optional Web Interface

The Web Interface is an optional external PC interface tool that provides remote web clients with TPPL data in real time.

CAUTION

Windows XP has known security issues and should not be used with TPPL.

WARNING

The data from Touchpoint Plus web interface should not be used for safety relevant purposes

The following browsers are currently supported:

- Chrome
- Internet Explorer 10, Internet Explorer 11
- Internet Explorer 8, Internet Explorer 9 (Trend / Plot is not available)
- Safari
- Other browsers may work but their performance may vary.

Note: Contact Honeywell Support (refer to back page of this manual) if a browser security update causes performance issues.

7.17.1 Web Interface Configuration

The Web Interface supports two concurrent web clients. Further users may connect, but performance may be degraded.

The TPPL Default IP address is 192.168.0.100. To change the IP address refer to Ch.6.11 Network Settings for WEB and MODBUS TCP.

The Web Interface shows the current TPPL status as follows:

- Channel List View – shows up to six inputs and events with automatic scrolling
- Channel Summary View – shows total counts for alarm 1, alarm 2, alarm 3, fault, warning and inhibits
- Channel Output View – shows up to eight outputs and events

Key to examples below:

- Channel marking in red – one or more input channels are in Alarm
- Channel marking in yellow – one or more channels are in Fault
- Channel marking in orange – one or more channels are in Inhibit
- Channel marking in blue – one or more channels are in Warning

You can select how you monitor TPPL via the Web Interface menus by selecting from the menu:

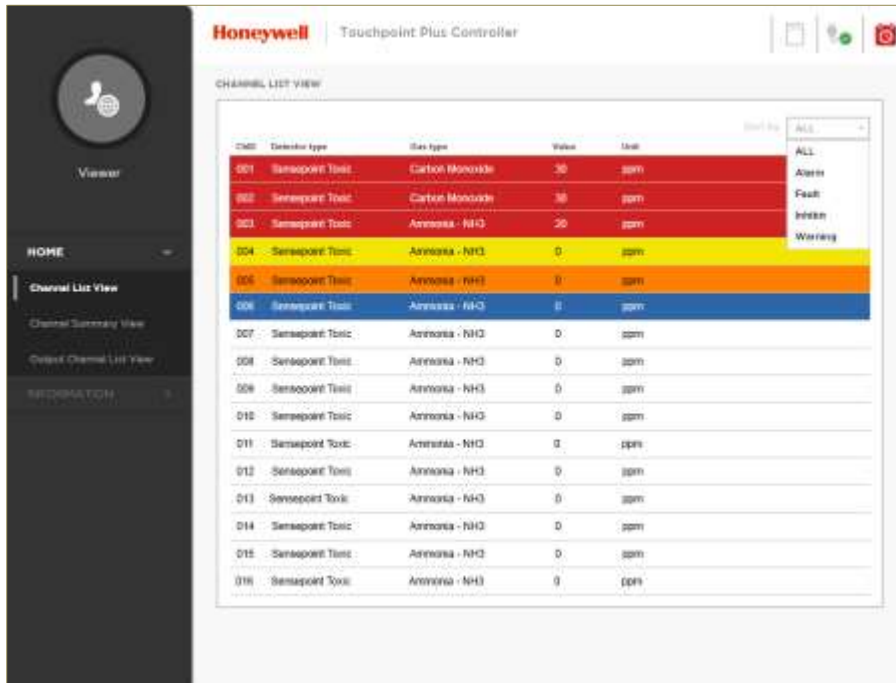

Figure 48. Web Interface Channel List View



Figure 49. Web Interface Channel Summary View

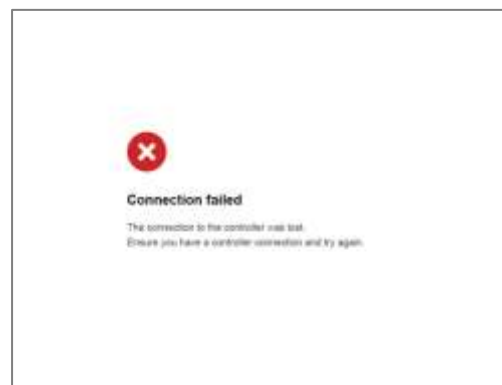

Figure 50. Web Interface Connection Failed Dialog

7.17.2 Web Interface Navigation

The Web Interface menu allows you to see and monitor the following information:

- System Information
- Event History
- Trend / Plot (not IE8 or IE9)
- Channel Information
- Module Information
- Service Contact
- Relay Status
- Additional Status
- System Configuration

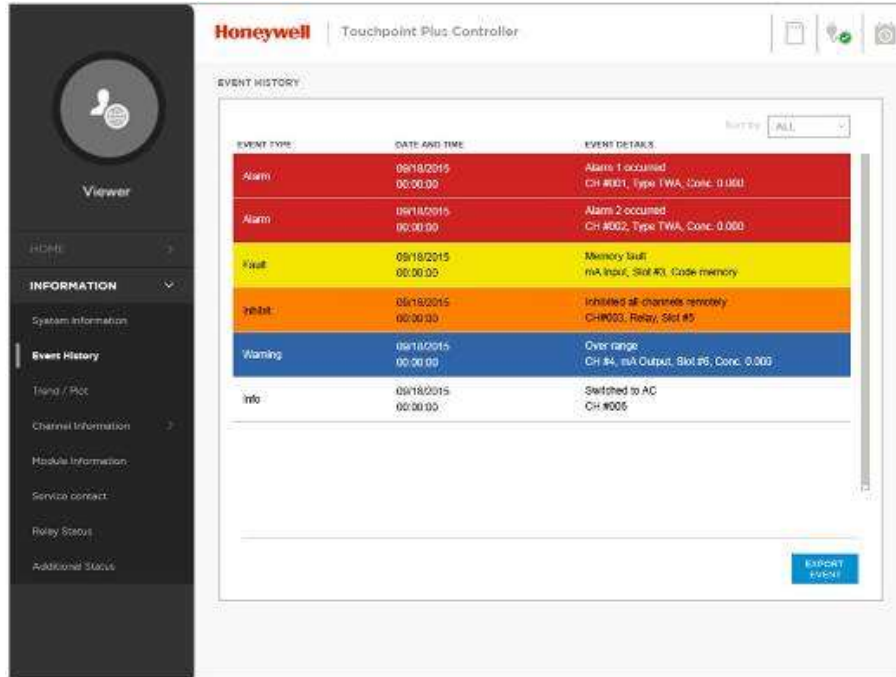

Figure 51. Web Interface Information Menu Showing Event History

Chapter 8. Routine Maintenance and Scheduled Testing

This chapter describes how to perform common maintenance operations and system testing. The required frequency of inspection and maintenance will depend on local site conditions. Refer to IEC/EN 60079-29-2, EN45544-4 or other local or national regulations for guidance on establishing an appropriate maintenance routine.

Note: Input sensor's sensitivity reduces over time. Regular recalibration is required to make allowance for these changes. This slow change is monitored by Touchpoint Plus and is used to give the input sensor life expired warning or calibration fail when the sensitivity is < 50 % of the first calibration.

WARNING

Read Chapter 2 Safety and other related warnings and cautions before carrying out any work on the system.

WARNING

If the relays are switching mains voltages, hazardous live terminals may be present within the Relay Output Module even if the Touchpoint Plus system is isolated.
Ensure that the system is isolated before touching potentially live terminals.

8.1 Routine Maintenance

CAUTION

Test outputs will be generated and relays will be activated during Cause and Effect (C&E) Testing. Ensure that relay activated output systems (i.e. emergency deluge / sirens etc.) are isolated before starting the Relay and mA Output tests.
Each sensor connected to Touchpoint Plus shall be regularly gas calibrated at the interval specified in sensor's user manual.
In order to maintain safety functions of Touchpoint Plus, mA output and relay output shall be routinely tested at max. yearly interval.

8.1.1 Periodic Checks

- Visually inspect all cables and conduits for loose connections, security of attachment, and signs of damage.
- Wipe the Touchpoint Plus Controller with a soft damp cloth or use PC Screen cleaner.
- Check for dust contamination.
- Periodically exercise the outputs (see Ch.8.2 Routine Testing) to confirm their functionality (see Caution above).
- Audio/Visual Alarms shall be checked weekly basis (refer to Ch.8.2.1)

CAUTION

Do not use solvent or abrasives to clean any part of the Touchpoint Plus System.
Use only soft, lightly dampened cloths or proprietary screen cleaners.

8.2 Routine Testing

8.2.1 Exercising the Audio/Visual Alarms

Audio/visual alarms can be tested by switching the Dedicated Alarms **On**. To do this:

- 1) Ensure that relay activated output systems (i.e. emergency deluge / sirens etc.) are isolated before starting the test.
- 2) Login as an **Administrator** or **Service**.
- 3) Touch **Menu>System Test >Dedicated Alarm Contacts**.
- 4) Touch the appropriate Alarm to toggle it on for each output (see below).



- 5) Check the alarm outputs are visible / audible and turn them off when satisfied.
- 6) Touch **[Finish]** when the tests are completed and all selections will automatically turn off.

CAUTION

Ensure that the system is returned to normal operation once testing is complete.

8.2.2 Exercising the Relays

WARNING
If the relays are switching mains voltages, hazardous live terminals may be present.

Relay output channels can be tested by forcing the relays to an active state:

- 1) Ensure that relay activated output systems (i.e. emergency deluge / sirens etc.) are isolated before starting the test.
- 2) Login as an Administrator or Service.
- 3) Touch Menu>System Test>Force Relay.
- 4) Touch the active (yellow) Relay Output Channels to be tested, and toggle them on.



- 5) Check the selected relay output contact power switching using a suitable test tool or voltmeter.
- 6) Touch [Finish]>[Cancel] and all selections will turn off.
- 7) Proceed to the next step.

8.2.3 Checking the mA Outputs

Milliamp (mA) output channels can be tested by forcing the mA output:

- 1) Ensure that relay activated output systems (i.e. emergency deluge / sirens etc.) are isolated before starting the test.
- 2) Login as an Administrator or Service.
- 3) Touch Menu>System Test>Force 4-20mA.
- 4) Touch the All radio button and check the mA output value; touch the mA box to change it. For single channels touch the Single Channel number box and then scroll through the list and touch the required channel followed by [Select].

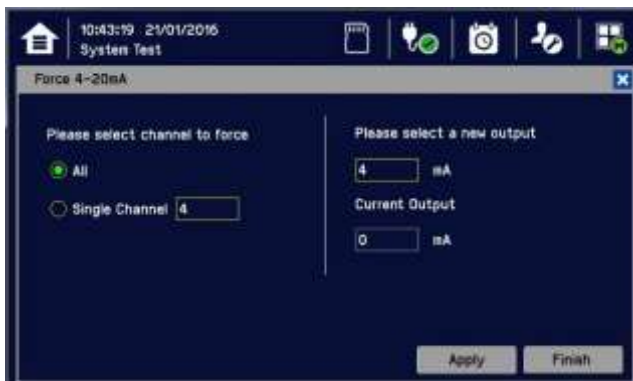

- 5) Touch [Apply].
- 6) Check the appropriate mA output levels using a suitable ammeter.
- 7) Repeat steps 4 to 6 for all mA output channels.
- 8) Touch [Finish] when the tests are completed.

CAUTION

Ensure that the system is returned to normal operation once testing is complete.

8.2.4 Calibrating mV Input Channels

Catalytic sensors should be calibrated periodically according to the manufacturer's recommendations. This should be a two-person job to avoid the controller timing out and losing the settings.

Note: To enable a calibration interval for the channel, edit the interval setting before starting calibration (see Ch.6.14 Channel Configuration).

You should select **First Span** only when calibrating a new or replacement sensor for the first time. You then adjust the mV Baseline, and then you should use **Span** for all calibrations thereafter (see Note below).

Note: Adjustment of the Baseline is only required when a mV channel is configured for the first time or when a catalytic bead element is replaced. Once the Baseline is established it should not be adjusted for second or subsequent gas calibrations, i.e. until the next catalytic bead replacement.

To Calibrate a mV Input Channel:

- 1) Login as **Administrator** or **Service**.
- 2) Touch **Menu>Maintenance>Adjust mV Baseline** and select a mV input channel.
- 3) Touch **Menu>Maintenance>Gas Calibration**. Touch the channel to be calibrated, followed by [Select]:



- 4) Select Zero Calibration, check or uncheck First Calibration, touch [Start] and apply clean air (Zero Gas) to the sensor:

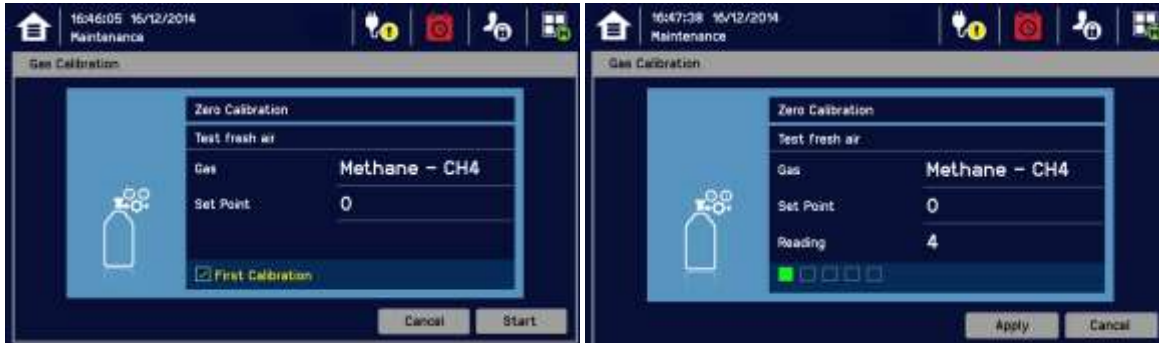

- 5) View the reading until it is stable, and then touch [Apply].
- 6) Confirm that the gas reading is stable, and touch [Next].
- 7) Enter the concentration of the span gas and touch [Start]:



- 8) When ready touch [Start] and apply gas to the sensor.
- 9) View the reading until it is stable, and then touch [Apply]. This may take 3 – 5 minutes, depending on the gas type.
- 10) Confirm that the gas reading is correct.
- 11) Remove the span gas from the sensor and confirm that the gas reading has returned to zero. Choose whether or not to calibrate another channel.

Touchpoint Plus will exit the calibration menu no matter of current gas reading in calibration mode in 45 s after purging gas step. User may see gas alarm if user cannot ensure the gas reading value of Touchpoint Plus lower than alarm level in purging step.

8.3 Periodic Scheduled Testing

Periodic Scheduled Testing should only be carried out by a Honeywell authorised technician or a qualified person trained in accordance with this manual.

The following tests will show as a Fault on the events log.

8.3.1 Introduction

The Touchpoint Plus system has two test modes available, which together enable a full system test.

The test modes are:

- Field Inputs Test – this tests all input channel devices without affecting any outputs.
- Cause and Effect Test – this test forces the Touchpoint Plus input channels to known states to test that the correct relay output channels are activated.

WARNING

The Touchpoint Plus system is not operational while in Test Mode, and all field device inputs will be ignored.

Ensure that alternative safety arrangements are maintained during test, and ensure that Normal Operation is restored as soon as testing is completed.

CAUTION

Test output conditions will be simulated and relays will be activated during the Cause and Effect Test.

Ensure that relay activated output systems (i.e. emergency deluge / sirens etc.) are isolated before starting the test.

When a test mode is activated the **System Failure** relay indicates that the safety function of the system is not operating. A **Fault** will be seen on the User Interface and a **Fault event** will be recorded in the **Event log**.

Once a test mode is active, the system will remain in test mode per the timeout setting. User shall operate the test mode prior to timeout setting value. (Refer to Ch.7.4 for timeout setting) The only exception is in the case of a power cycle, when TPPL will restart in normal mode.

All events generated while the system is in test mode will be logged in the event history, which can be viewed by selecting **[Menu>Information>Event History]**.

CAUTION

Ensure that the system is returned to normal operation once testing is completed.

8.3.2 Field Inputs Test

See Cautions above.

To carry out the Field Inputs Test:

- 1) Login as an Administrator or Service.
- 2) Inhibit the required Input Channels (see Ch.7.10 Inhibiting Channels.)
- 3) Supply test gas for the input channels.
- 4) System will display the gas reading and inhibit state.
- 5) Pre-configured Inhibit outputs (relays and mA output) will be triggered but all alarm outputs are inhibited.

8.3.3 Cause and Effect Test

See Cautions above.

During this test, all field device inputs will be ignored by the Touchpoint Plus system. The Cause and Effect matrix will be evaluated based on simulated input states and outputs will be generated.

CAUTION

Test outputs will be generated and relays will be activated during the Cause and Effect Test. Ensure that relay activated output systems (i.e. emergency deluge / sirens etc.) are isolated before starting the test.

This test has two purposes:

- 1) To verify that Cause and Effect matrix configuration is correct by forcing the state of the input channels to various combinations.
- 2) To check that the output channels are configured correctly, including delay on/off times etc.

To use the Cause and Effect Test mode:

- 1) Login as an Administrator or Service.
- 2) Touch Menu>System Test>Relay C&E Matrix>Relay Channel.
- 3) Touch the channel to be tested followed by [Select].
- 4) The system will display a matrix of all the input channels that are linked to the output channel being tested.
- 5) Select the input channel states that you wish to simulate, and touch on [Simulate].
- 6) Check that the relay output state is correct and touch [Finish].
- 7) Repeat steps 2–6 for the next channel.

CAUTION

Ensure that the system is returned to normal operation once testing is complete.

8.3.4 LCD, LED and buzzer test

It is recommended to conduct LCD, LED and buzzer test weekly basis.

To use test menu

- 1) Login as an Administrator or Service
- 2) Touch **Menu>System Test>LCD test>Start LCD test [Yes]**
- 3) Check that the LCD screen and color are correct

- 1) Login as an Administrator or Service
- 2) Touch **Menu>System Test>LED & Buzzer test>Start LED & Buzzer test [Yes]**
- 3) Check that the LED and color are correct
- 4) Check that the buzzer operates correctly

8.3.5 Reaction and response time test

For testing reaction and/or response time, refer to the real-time gas reading value shown on the display during the gas calibration or refer to the logging data of the mA output.

Chapter 9. Repairs, Replacements and Upgrades

9.1 How to Decommission and Remove a Serviceable I/O Module

CAUTION

Failing to follow this procedure correctly could render the removed module unusable and unrepairable.

ANTI-STATIC PRECAUTIONS

Antistatic Precautions are required to prevent damage to electronic components.

9.1.1 To Remove a Serviceable Module

- 1) Login as an Administrator or Service.
- 2) Touch **Menu>Configuration>Module Control panel**.

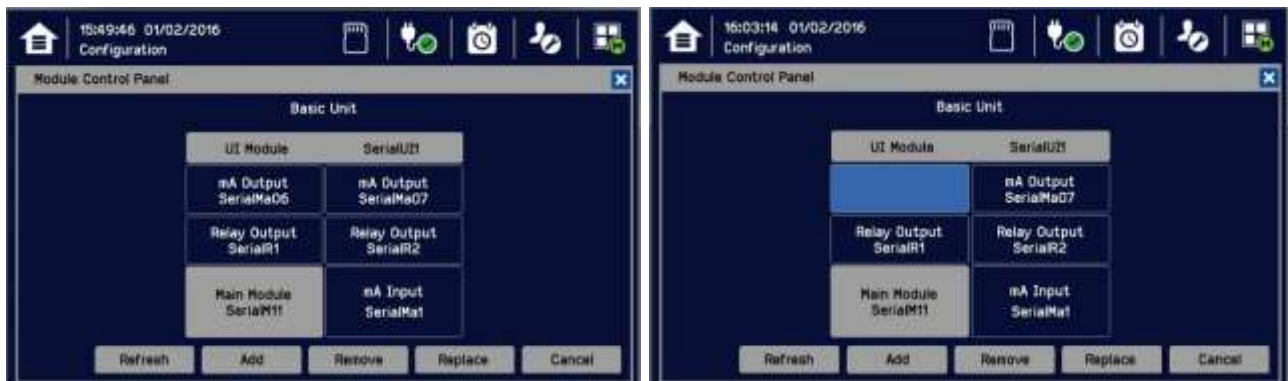

- 3) Touch the I/O module block that you want to remove, and touch **[Remove]** and confirm **[Yes]**.
- 4) Wait for the block to turn light blue. Remove any other modules the same way.
- 5) Touch **Menu>Maintenance> Power-off>Yes**.
- 6) Isolate the power supplies.
- 7) Open the enclosure door and switch the battery to 'Off' (if there is a back-up battery installed).
- 8) Electrically disconnect the module(s), and then remove them (see Ch.10.2 How to replace a Faulty Module if you want to replace it with another module).
- 9) Switch the battery to 'On' (if there is a back-up battery installed).
- 10) Close and secure the enclosure door.
- 11) Switch on the Touchpoint Plus and wait for the system to stabilise.
- 12) Login as an Administrator or Service.
- 13) Touch **Menu>Configuration>Module Control panel**.
- 14) Touch **[Refresh]** to confirm the modules were removed correctly.
- 15) Log out.

9.2 How to Replace a Faulty I/O Module

A faulty I/O module can be replaced with another of the same type, without needing to reprogram the configuration. Touchpoint Plus will automatically copy over the configuration to the new module.

WARNING

If the relays are switching mains voltages, hazardous live terminals may be present within the Relay Output Module even if the Touchpoint Plus system is isolated. Isolate hazardous voltages before proceeding.

ANTI-STATIC PRECAUTIONS

Antistatic Precautions are required to prevent damage to electronic components

Note: The new module must be the same type and same or higher mod state as the module to be removed.

9.2.1 To Replace a Faulty Module

- 1) Login as an Administrator or Service.
- 2) Touch Menu>Maintenance>Power off>Yes.
- 3) Isolate the power supplies and then open the enclosure access door
- 4) Switch the battery to 'Off' (if there is a back-up battery installed).
- 5) Disconnect the faulty module.
- 6) Replace the module.
- 7) Reconnect the module.
- 8) Switch the battery to 'On' (if there is a back-up battery installed).
- 9) Close and secure the enclosure door.
- 10) Switch on the Touchpoint Plus and wait for the system to stabilise.
- 11) Login as an Administrator or Service.
- 12) Touch Menu>Configuration>Module Control Panel.
- 13) In the Module Control panel, first touch [Refresh] and wait for the update to complete.
- 14) Touch the light blue block corresponding to the replaced module and touch Replace>Select.
- 15) Wait until the update is completed and Log out when completed.

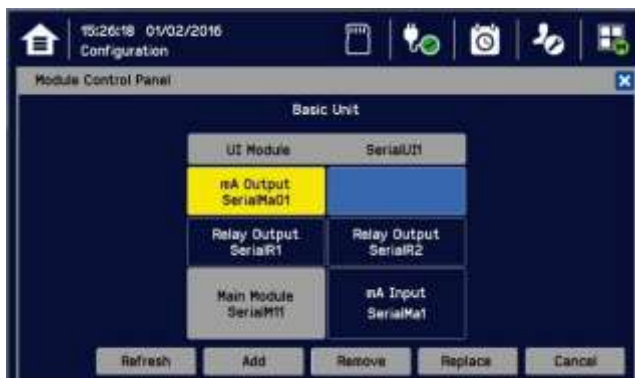

Key to I/O Module colour

Gray: Mandatory modules that cannot be added removed or replaced.

Yellow: A Module was added previously but cannot be detected now (i.e. Module removed).

Light blue: Serial number or module type is not matched (i.e. an I/O Module has been replaced).

Background colour: This module is installed.

9.3 How to Add a New I/O Module

The Touchpoint Plus system can easily be expanded by adding additional I/O modules.

Refer to Ch.3.3.1 and Ch.3.3.2 for full populated I/O modules

ANTI-STATIC PRECAUTIONS
 Antistatic Precautions are required to prevent severe damage to electronic components.

9.3.1 To Add a New Module

- 1) Login as an Administrator or Service.
- 2) Touch **Menu>Maintenance>Power off>Yes**.
- 3) Isolate the power supplies and switch the battery to 'Off' (if there is a back-up battery installed).
- 4) Fit the new module to an empty slot, ensuring that that the module is the correct way up and with the label towards you.
- 5) Electrically connect the new module.
- 6) Switch the battery to 'On' (if there is a back-up battery installed).
- 7) Switch on the Touchpoint Plus and wait for the system to stabilise.
- 8) Login as an Administrator or Service.
- 9) Touch **Menu>Configuration>Module Control Panel**.

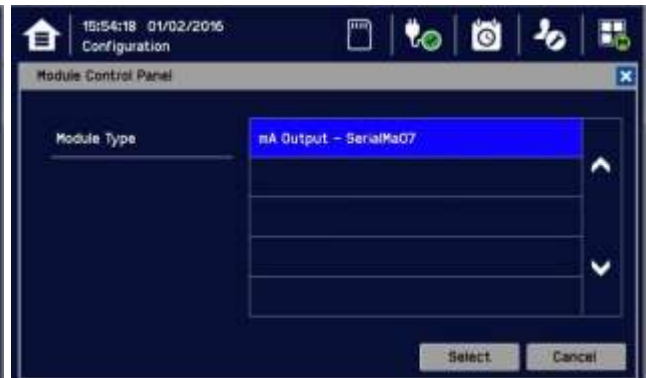
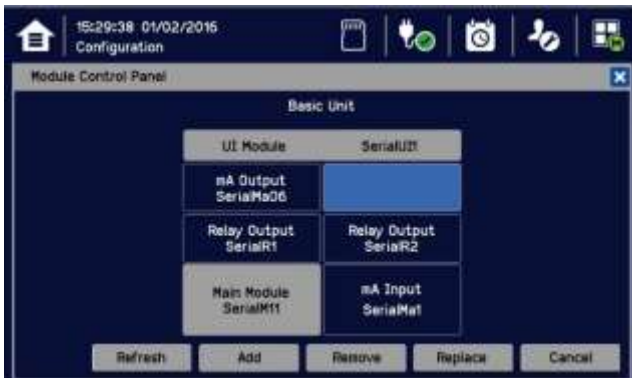

- 10) Touch the empty block corresponding to the new module and touch **[Add]**.
- 11) Select the Module Type to add, then touch **[Select]** and wait for the update to complete.
- 12) Commission each channel in turn.
- 13) Log out when finished.

Note: See Ch.6 Commissioning for detailed instructions for further information.

9.4 How to Update the Sensor Catalogue

From time to time, Honeywell will release new or updated versions of the sensor catalogue. It is not necessary to update the catalogue every time, and it can wait until you want to install a type of sensor not previously listed.

The sensor catalogue should be updated before configuring new sensor types.

CAUTION

The TPPL has limited capacity to store events in its onboard memory so do not keep the Event logging SD Card out any longer than necessary.

To implement the latest sensor catalogue, user shall delete the current configuration (e.g. channel remove) and then complete the configuration again after installing the latest sensor catalogue.

To Update the Sensor Catalogue:

- 1) Download or copy the new sensor catalogue [**TPP_CAT.bin**] to a device having a Read/Write SD Card slot.
- 2) Put an empty 2 to 32 GB (FAT32) standard SD card into the SD device.
- 3) Create a new folder called **CATALOG** on the SD card and copy the downloaded sensor catalogue file into it.
- 4) Login as an Administrator or Service.
- 5) Touch **Menu>Maintenance>Power-off>Yes**.
- 6) Switch off and isolate the TPPL power supplies.
- 7) Open the TPPL enclosure door.
- 8) Temporarily replace the TPPL SD Card with the sensor catalogue SD card.
- 9) Close the enclosure door.
- 10) Switch power back on and wait for the system to stabilise.
- 11) Login as an Administrator.
- 12) Touch **Menu>Maintenance>Update System>SensorCatalog**.
- 13) Touch [Update].
- 14) Wait for the sensor catalogue file to update, which may take several minutes.
- 15) Touch **Menu>Maintenance>Power-off>Yes**.
- 16) Switch off and isolate the TPPL power supplies.
- 17) Open the TPPL enclosure door.
- 18) Replace the SD Card with the original SD card.
- 19) Close and secure the enclosure door.
- 20) Switch power back on and wait for the system to stabilise.
- 21) See and touch the SD Card icon to check the SD Card status.

9.5 How to Backup / Restore the System Configuration

CAUTION

You should always take a new back up of the Touchpoint Plus system configuration after changes are made and confirmed.

9.5.1 To Create a Backup File

Note: The Touchpoint Plus system must be turned off to change the SD card so alternative safety arrangements should be put in place prior to starting this procedure.

CAUTION

The TPPL has limited capacity to store events in its onboard memory so do not keep the Event logging SD Card out any longer than necessary.

- 1) Login as Administrator.
- 2) Touch **Menu>Maintenance>Power-off>Yes**.
- 3) Switch off and isolate the TPPL power supplies.
- 4) Open the TPPL enclosure door.
- 5) Temporarily replace the TPPL SD Card with an empty SD card.
- 6) Close the enclosure door.
- 7) Switch power back on and wait for the system to stabilise.
- 8) Login as an Administrator.
- 9) Touch **Menu>Configuration>Config Manager>Export**.
- 10) Enter a file name for the backed-up configuration and touch **[Finish]**.



- 11) Touch **Export>Yes** and, if the file name is valid, it will start the configuration backup process. The backup may take several minutes, and progress is shown on screen.
- 12) When the backup is completed, touch **Menu>Maintenance>Power-off>Yes**.
- 13) Switch off and isolate the TPPL power supplies.
- 14) Open the TPPL enclosure door and replace the backup SD Card with the original or a spare card.
- 15) Close and secure the enclosure door and return the system to normal operation.

- Transfer the backup data to a dated folder on a PC or digital device for safekeeping. The Configuration backup file is stored on the SD Card in `\\CFG\[your file name]` and you can reuse the SD card once the data has been transferred.

Note: You cannot restore configuration files if the I/O module configuration has changed since the last backup.

9.5.2 To Restore the Configuration From a Backup File

Note: The Touchpoint Plus system must be turned off to change the SD card so alternative safety arrangements should be put in place prior to starting this procedure.

CAUTION

The TPPL has limited capacity to store events in its onboard memory so do not keep the Event logging SD Card out any longer than necessary.

- Login as Administrator.
- Touch `Menu>Maintenance>Power-off>Yes`.
- Switch off and isolate the TPPL power supplies.
- Open the TPPL enclosure door.
- Temporarily replace the TPPL SD Card with one holding the backup file `\\CFG\[your file name]`
- Close the enclosure door.
- Switch power back on and wait for the system to stabilise.
- Login as Administrator.
- Touch `Menu>Configuration>Config Manager>Import`, then choose your backup file and touch `Select>Yes`.

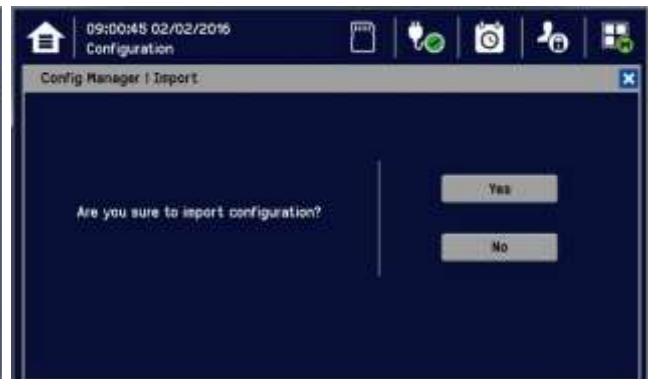
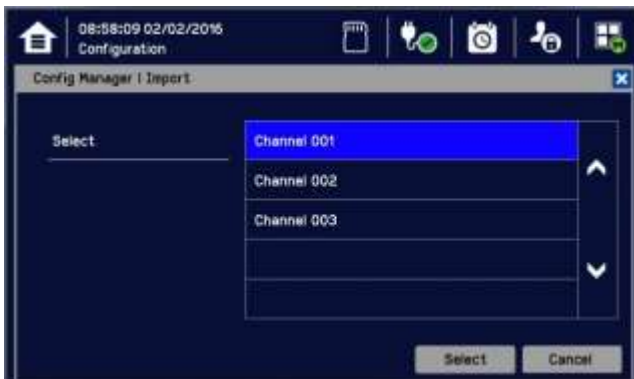

- Once the action is confirmed, the configuration restoration process starts and a progress message is displayed. The process may take several minutes depending on the system size.

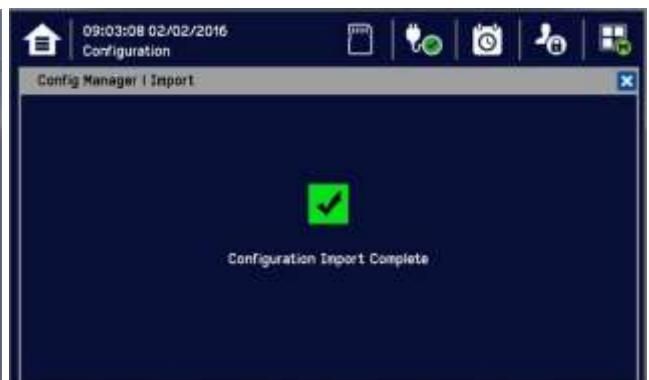
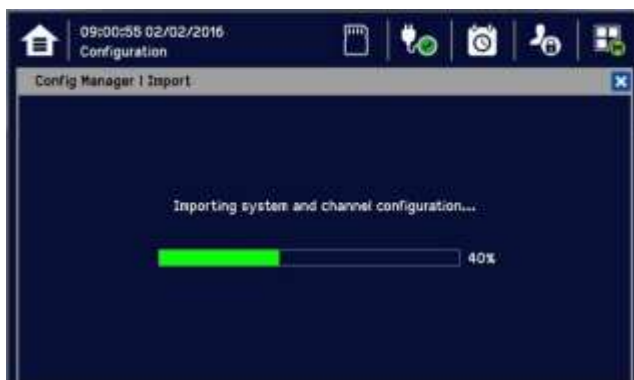

- 11) Touch **Menu>Maintenance>Power-off>Yes**.
- 12) Switch off and isolate the TPPL power supplies.
- 13) Open the TPPL enclosure door.
- 14) Replace the backup SD Card with the original or a spare card.
- 15) Close and secure the enclosure door and return the system to normal operation.
- 16) See and touch the SD Card Icon to confirm it has sufficient space to record events.

9.6 How to Update Firmware

Firmware and software updates should normally be carried out only by a Honeywell trained Engineer or a qualified Engineer trained in accordance with this Technical Manual.

CAUTION

Gas Detection will be inoperative during this procedure so alternative site safety arrangements should be made.

CAUTION

Before starting the firmware update, confirm that the new firmware is compatible with both the installed I/O Module firmware and the Main module (see below).

9.6.1 How to Check Firmware Compatibility

- 1) Touch **Menu>Information>System information**.
- 2) Note down the Serial Number from screen one and the Software Information from screen two. Touch **Next** to tab through screens.



- 3) Contact your local service representative and relay the information above. They can check compatibility and offer upgrade advice and download information (see next chapter).

9.6.2 How to Update the Firmware

WARNING

Gas Detection will be inoperative during this procedure so alternative site safety arrangements should be made.

CAUTION

Do not Power Off while the Firmware update is in progress as this may cause data corruption and render the system inoperable.

To update the Firmware:

- 1) Contact your local representative or Honeywell Analytics Support and ask for a copy of the latest download.
- 2) Download the required Firmware `\\FW*.bin` onto any device that can copy to a standard SD Card.
- 3) Copy this file onto the root directory of a 2 to 32 GB (FAT32) standard SD card; do not put it in a folder as TPPL will not be able to find it.)
- 4) Login as `Administrator`.
- 5) Touch `Menu>Maintenance>Power-off>Yes`.
- 6) Switch off and isolate the TPPL power supplies.
- 7) Open the TPPL enclosure door.
- 8) Temporarily replace the TPPL SD Card with the one holding `\\FW*.bin`
- 9) Close the enclosure door.
- 10) Switch power back on and wait for the system to stabilise.
- 11) Login as `Administrator`.
- 12) Touch `Menu>Maintenance>Update system>Software`.
- 13) Touch a Module and browse the appropriate firmware file in the SD card. Check the listed current and update versions. Touch `[Update]` when ready.
- 14) When the updates are completed, the system will reboot automatically if required.
- 15) Repeat steps 8 and 9 for all other affected modules.
- 16) Touch `Menu>Maintenance>Power-off>Yes`.
- 17) Switch off and isolate the TPPL power supplies.
- 18) Open the TPPL enclosure door.
- 19) Replace the SD Card with the original or a spare card.
- 20) Close and secure the enclosure door and return the system to normal operation.
- 21) See and touch the SD Card Icon to confirm it has sufficient space to record events.
- 22) Check that the system status is OK and no faults or inhibits or errors are shown.

9.7 Back up Battery Maintenance

DANGER

Replace the battery pack only with Honeywell Analytics part no. TPPLSIBB and the PCB CMOS battery only with battery type CR2032.

Use of other batteries may present a risk of fire or explosion.

Batteries shall only be fitted, removed or replaced in non-hazardous (safe) areas.

DANGER

Lithium batteries may cause severe injury or death if put in the mouth or swallowed.

Always keep them away from children and dispose of them as hazardous waste.

CAUTION

According to local laws and regulations the battery installed within your product should be disposed of separately from household waste. When the battery reaches its end of life, take it to a collection point designated by local authorities.

Note: The DC 24 V battery pack has an integral 15 A over-current protection fuse, and will accept a nominal input charge of 24 – 32 VDC. (<24 VDC will not charge the battery to the level required for backup power.)

Note: Refer to the Ch 5.3 for replacing CR2032

9.7.1 Recommended Backup Battery Maintenance

- Visually inspect the Touchpoint Plus Battery and (as the enclosure is open) all internal cabling.
- Check for signs of damage, deterioration, leakage or loose connections.
- Check that the cooling vents have not become obstructed.

9.7.2 How to Replace the Backup Battery

DANGER

Touchpoint Plus shall not be operated with the access door unsecured when in Normal mode. Failing to secure it properly will risk fire, explosion or electric shock, and will invalidate Regulatory Approval.

The battery pack goes into sleep mode when it is disconnected or switched off. Connecting the battery pack to a power source switches it to active mode and it will function normally after a short booster charge.

To replace the battery pack:

- 1) Ensure that the environment is safe and the atmosphere is below flammable levels.
- 2) Switch TPPL off and isolate its power supplies.
- 3) Unscrew the two locking handle security screws and open the enclosure.
- 4) Switch the backup battery On/Off switch to Off (Fig. 10 or 11) to protect the PCB from arcing/spiking when disconnecting / reconnecting
- 5) Push the On/Off switch for at least 15 seconds.
- 6) Disconnect the battery connector from the PCB.
- 7) Replace the battery pack with Honeywell Analytics Part No. TPPLSIBB.
- 8) Reconnect the battery connector to the PCB.
- 9) Switch the backup battery On/Off switch back to On.
- 10) Close the enclosure door and secure the handle with the two security screws.

11) Switch power on and restore TPPL to normal operation.

Touch the power icon to check battery power levels.



Figure 52. Battery On/Off Switch and Battery Connector

Note: Ensure that the battery On/Off switch is in the On position before closing the access door or the backup battery will not work when it is most required.

9.8 Return to Factory Default Settings

If required, the system Administrator or a Honeywell Service Technician can return the TPPL Controller to its Factory Default settings.

Passwords are not changed when resetting to Factory Default settings so this procedure cannot be used to restore forgotten passwords to the default password.

WARNING

Returning TPPL to its Factory Default settings will initialize all user settings including mA and mV Input channel calibrations, Relay and mA Output settings etc.

Your TPPL system will become inoperative until it is reconfigured (see Ch. 6 Commissioning), and you should put alternative safety arrangements in place until the system is returned to normal operation.

9.8.1 To Reset the Touchpoint Plus to its Factory Default Settings

12) Log in as Administrator.

13) Touch Maintenance>Service Mode>Reset to Default>Yes.

14) If required, recommission and reconfigure the Touchpoint Plus system (Ch. 6 Commissioning).

15) Log out.

Chapter 10. Troubleshooting

WARNING

Read Chapter 2 Safety and other related warnings and cautions before carrying out any work on the gas detection systems.

Problems are signalled by an error code shown on the control panel display. The error is recorded in the event log. The error messages are explained in Ch.18. Event Codes. Note the fault numbers / messages and check them in Ch.18 Event Codes before power-cycling the TPPL as they may not be reproducible following a system reboot. Contact Honeywell Analytics Technical Support if an error appears repeatedly, if it cannot be cleared, or if it is not listed in Ch.18. Event Codes.

10.1 Calling for Technical Support.

Contact Honeywell Analytics Technical Support if your problem cannot be resolved or if you need additional help. You can find our contact details on the rear cover of this manual.

To assist the Honeywell Helpdesk in giving you technical support, it would be helpful to have the following information ready:

- Your Company contact details and a contact name and department.
- The system model type, i.e. Touchpoint Plus, and its Serial Number, Part Number and Firmware versions for all Modules. These can be found on the system identification label on enclosure and under the System Information menu option. Label on the enclosure can show initially ordered product configuration.
- The software version found under the System Information menu option.
- Error messages and code numbers that were shown on the Event history screen and event log files.
- Details of the difficulty that you are experiencing.
- Status of the system (Inoperative, partially operative, still functioning etc.)

To assist with the fault diagnosis you may be asked to send a copy of your event log by email.

Chapter 11. Technical Specifications

11.1 Environmental

Sealed enclosures are rated IP65 NEMA 4x indoor, and can be installed indoors only in a Pollution Degree 2, 10 to 95% RH Non-Condensing environment that affords total protection from rain, snow and direct sunlight.

Operating Temperature	-10°C to +55°C
Storage Temperature	-25°C to +60°C
Operating Humidity (closed)	10 to 90% RH (non-condensing)

11.2 User Interface and Main Module

LCD Touch Screen Type	7" TFT Colour LCD with LED Backlight (resistive touch screen) 800 x 480 pixels (WVGA) Resolution Active area 155.08 mm (H) x 86.92 mm (V)
Front Display	Green Power LED
	Red Alarm LED
	Yellow Fault/Inhibit LED
	Alarm Mute /Reset Push Button
	Alarm Buzzer (Sound Level: 70 dB at 1 m)
Communication Outputs	1) 10/100 Mbps Ethernet Interface with standard RJ-45 connector 2) RS-485 Modbus connections supporting 115.2 kbps max.
Output Relays	Two configurable and one fixed System State Relays: 1.7 A @ 250 VAC, 1.7 A @ 30 VDC (non-inductive load)
Dedicated Audio and Visual alarm	Four outputs to external devices Supply voltage Vs (18 – 32 VDC) –1.8* VDC (max), max 300 mA per channel *Voltage drop at ambient temperature
Remote Terminals	Optional remote acknowledge, reset and inhibit
Module Power Consumption	4.4 W for User interface module and Main Module (Max 33.2W @ Audio/Visual Alarm device connected)

11.3 I/O Modules

11.3.1 mA Input Module

Description	2,4 and 8-channel Analogue Input Module for 2-wire or 3-wire 4 – 20 mA detector signals
Sensor Configuration	2-wire or 3-wire current source
Signal Measurement Range	0 – 24 mA
Sense Resistance	66 Ω
Module Power Consumption	Max 0.3 W (Excludes power to field device)
Field Device Power Supply Vmax (V _{max})	Supply voltage Vs (18 – 32 VDC) –*1.8 VDC (max) *Voltage drop in Touchpoint Plus
Field Device Power Supply Power max (single channel)	20 W
Field Device Power Supply Power max (eight channels)	40 W (Maximum for eight channel per a module)
Maximum cable length for mA Input loop (R _{loop})	$R_{loop} = (V_{controller} - 1.8 \text{ VDC} - V_{detector \text{ min}}) / I_{detector}$ Maximum Cable run length = $R_{loop} / (\Omega \text{ per metre})$. Example: $V_{controller} = 24 \text{ VDC}$, TPP Voltage drop = 1.8 VDC, $V_{detector} = 18 \text{ VDC}$ (18 to 32 VDC), $I_{detector} =$ From detector specification.

11.3.2 mV Input Module

Description	2,4 and 8-channel Analogue Input Module for mV-Bridge signals
Current Range for sensor (Fixed)	200 mA
Drive method	Constant current
Maximum Power Consumption	18.5 W (including power to detector @ loop resistance of 36 Ω)
Maximum Loop Resistance	36 Ω at 200 mA (including sensor)
Electrical Connections	3-wire mV-Bridge

11.3.3 Dual Input Module

Description	2/2 and 4/4-channel Analogue Input Module for 2-wire or 3-wire 4 – 20 mA detector signals and mV-Bridge signals
mA Input Channels	Refer to Ch.11.3.1 mA Input Module
mA Field Device Power Supply Power	20 W max. (Four channels)
mV Input Channels	Refer to Ch.11.3.2 mV Input Module

11.3.4 mA Output Module

Description	4-channel Analogue Output Module for 2 wire 4 – 20 mA signals
Module Power Consumption (Max.)	4.2 W (with 700 mA loop resistance @ 20 mA output)
Sensor Configuration	2-wire current source, Isolated current loop output
Signal Measurement Range	0 – 20 mA (4 – 20 mA = 0 – 100% scale)
Loop Resistance	33 – 700 Ω

11.3.5 Relay Output Module

Description	12-channel Relay Output Module incorporating 12 single pole change over (SPDT) relays
Power Consumption Maximum	2.5 W (with all relays energised)
Relay Contacts	1.7 A @ 250 VAC / 1.7 A @ 30 VDC
Relay Operation	Individually configurable for – normally energised / de-energised operation

11.3.6 Expansion Module

Cable between Basic and Expansion units	<10 m, 18 – 20 AWG, shielded twisted pair
---	---

11.4 Power Supplies

11.4.1 External Supplies

SMPS Power Supply	156 W
AC Input Voltage Range (-)	AC 110/220 V \pm 10 % of nominal (manual switching)
DC Input Voltage Range (⎓)	DC 18 – 32 V SELV Supply
Input Frequency Range (-)	AC 50 – 60 Hz \pm 6 %
Output Voltage (⎓)	DC 24 V
Dimension	199 x 98 x 38mm (L x W x H)

11.4.2 Backup Battery

Description	22.2 V Lithium - ion Battery, 2600mAh
Dimensions/Weight	124.8 x 78.9 x 29.2 mm, 425g
Operating Temperature	0 – 50 °C
Operating Humidity	10 to 90% RH (non-condensing)
Storage Life Limitations	1 Year: –20 °C to +25 °C (–4 °F to +077 °F) 3 months: –20 °C to +45 °C (–4 °F to +113 °F) 1 month: –20 °C to +60 °C (–4 °F to +140 °F)
Storage Lifetime without re-charge	1 year
Input Current (charging) (↔)	DC 24 – 32 V @ 0.25 A max.
Output Voltage (when supplying) (↔)	17.4 – 25.2 VDC
Maximum Input Current	250 mA
Maximum Output Current (Discharging)	5 A
Current Limit Protection	FUSE 15 A (non-replaceable)

11.5 Enclosures

11.5.1 Wall Mount Enclosure

Material	PC ABS
Cable Gland Plug	PG16
Environmental Protection	IP65 (when fully closed and locked), NEMA 4x indoors
Operating Humidity	10 to 90 %RH (non-condensing)
Mounting Bracket	W 423 x D 325 x H 16.5 mm – 1.5 Kg (approx.)
Enclosure Weight	8.5 Kg (approx.)
Dimension	426 mm x 300 mm x 156 mm (16.9 ins x 11.8 ins x 6.2 ins)

Chapter 12. Certifications

12.1 EU Declaration of Conformity

A full EC declaration of conformity is available on either original hardcopy or electronic file (Honeywell Analytics website). This document lists the European Standards with which Touchpoint Plus complies.

WARNING

Only the combustible gas detection portion of this instrument has been assessed for performance in accordance with the ATEX Directive.

AVERTISSEMENT

Seulement la partie détection de gaz explosif de cet équipement a fait l'objet de tests de performance métrologique suivant la directive ATEX.

WARNING

CSA performance is only valid when TPPL is connected to Honeywell Model MPD or 705 Catalytic Gas Detectors, or suitably approved 4 – 20 mA Gas Detectors.

AVERTISSEMENT

La performance en conformité avec la CSA est valide uniquement lorsque l'appareil est connecté aux détecteurs de gaz catalytiques Honeywell modèle MPD ou 705, ou à des détecteurs de gaz 4 – 20 mA dûment approuvés.

12.2 National and International Certificates of Compliance

The Touchpoint Plus Process Control Equipment holds the following National and International Certificates and Certification Codes:

Title	Standards	Certificates
Hazardous Locations (Non-Incendive)	Class 1, Division 2, Groups A,B,C,D, Temp. Code T4 ISA 12.12.01-2013 CSA C22.2 No. 213-M1987	UL File E480011
Ordinary Locations / Electrical Safety	UL/IEC/EN 61010-1, UL 508 CSA C22.2 No.61010-1/No.142	UL File E466771 UL File E470577
Ingression protection	IP65 and NEMA 4X indoor	–
EMC/RFI	EMC Directive (EN 50270:2015)	–
Battery Pack	UN 38.3 (IEC 62133), UL 2054, UL 60950-1 CSA C22.2 No.60950-1-07	UL File MH60522
Performance	ISA 12.13.01 and CSA C22.2 No.152	UL File E466771 and E480011
	EN 60079-29-1, EN 50104, EN 45544-1/2/3 and EN 50271	BVS 17 ATEX G 001 X, PFG 17 G 002 X
Safety Integrity	Designed to meet IEC/EN61508:2010 and SIL2 certification	FS/71/220/17/0178
Marine approval	MED (Item No.: 3.54)	MEDB00003YT

Copies of the certificates are available on request.

Note 1: OEMs are responsible for ensuring that their systems are certified in accordance with these tables and any 3rd-party requirements.

WARNING

Ambient temperature: Dependent on components fitted, check individual rating plates.

AVERTISSEMENT

Température ambiante : elle dépend des composants assemblés, vérifier individuellement les pages de température

12.3 European Performance Approval (DEKRA Testing and Certification GmbH) for Systems

Touchpoint Plus has been assessed and certified for European Performance. Touchpoint Plus has been approved by DEKRA Exam for use in the measurement of oxygen, combustible and toxic gases. The certification marking is shown below:

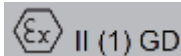

BVS 17 ATEX G 001 X for EN 60079-29-1 and EN50271

PFG 17 G 002 X for EN 50104, EN 45544-1/2/3 and EN 50271

12.3.1 Special Conditions for Use When Used for measurement of flammable gases

- 1) Refer to certificate BVS 17 ATEX G 001 X.
- 2) Only 4-20 mA output and relay output have been considered as safety functions. Other outputs (e.g. RS485 Modbus RTU, TCP/IP Modbus/HTTP) shall NOT be considered as safety functions.
- 3) BVS 17 ATEX G 001 X is only valid for operation with sensors Sensepoint and Sensepoint HT in the measuring range 0 - 100 % LEL, Sensepoint ppm in the measuring range 0 - 10 % LEL or a certified 4-20 mA transmitter.
- 4) When using 4-20 mA transmitters, pay particular attention to the followings:
 - The specifications of the 4-20 mA interface
 - Behaviour with currents less than 4 mA
 - Behaviour with currents in excess of 20 mA
- 5) Set the parameter "resolution" to 1 % of full scale range or to a smaller value.
- 6) Full scale ranges up to 20 % LEL:
 - Do not set both parameters "Lower deadband" and "Gas Under range" to values below -10 % of full scale range.
 - Do not set the parameter "Gas Under range" to a value below -20 % of full scale range.
- 7) Full scale ranges up above 20 % LEL:
 - Do not set the parameter "Gas Under range" to a value below -10 % of full scale range.
- 8) Set the parameter "Upper deadband" to 5 % of full scale range or to a smaller value.
- 9) Configure the alarms of all input channels as latching.
- 10) Configure relay outputs for safety-related switching operations in such a way that they cannot be reset while the alarm condition is present.
- 11) Time delayed relays should not be used for safety related purposes. If their use is unavoidable, the relay delay time shall be set to the minimum value which is feasible for the required operation. Take the maximum possible rate of increase of gas concentration into account when determining the relay delay time.
- 12) Transmission errors between modules cause a fault after 5 s at the latest.
- 13) Do not use Touchpoint Plus with 4-20 mA transmitters which may give indications within their measuring range at gas concentrations above full scale.
- 14) Perform the test routines for display, LED and buzzer in weekly intervals.
- 15) Set the parameters "Inhibit Output Level", "Fault Output Level" and "Warning Output Level" of mA outputs to values outside the range 4 mA to 20 mA so that the output of such a current can be unambiguously distinguished from a measured value. Avoid settings between 3.5 mA und 20.5 mA.
- 16) One of either RLY1 or RLY2 in main board shall be configured to System inhibit Relay.

12.3.2 Special Conditions for Use When Used for Measurement of Toxic Gases or Oxygen

- 1) Refer to certificate PFG 17 G 002 X
- 2) When use as EN45544-2 apparatus, Touchpoint Plus is suitable for use with transmitters where the output at the limit value is between 4.96mA and 12 mA. Refer to EN45544-1 Annex A for future information.
- 3) Only 4-20 mA output and relay output have been considered as safety functions. Other outputs (e.g. RS485 Modbus RTU, TCP/IP Modbus/HTTP) shall NOT be considered as safety functions.
- 4) When using 4-20 mA transmitters, pay particular attention to the followings:
 - The specifications of the 4-20 mA interface
 - Behaviour with currents less than 4 mA
 - Behaviour with currents in excess of 20 mA
- 5) Configure the alarms of all input channels as latching.
- 6) Configure relay outputs for safety-related switching operations in such a way that they cannot be reset while the alarm condition is present.
- 7) Time delayed relays should not be used for safety related purposes. If their use is unavoidable, the relay delay time shall be set to the minimum value which is feasible for the required operation. Take the maximum possible rate of increase of gas concentration into account when determining the relay delay time.
- 8) Transmission errors between modules cause a fault after 5 s at the latest.
- 9) Perform the test routines for display, LED and buzzer in weekly intervals.
- 10) Set the parameters "Inhibit Output Level", "Fault Output Level" and "Warning Output Level" of mA outputs to values outside the range 4 mA to 20 mA so that the output of such a current can be unambiguously distinguished from a measured value. Avoid settings between 3.5 mA und 20.5 mA.
- 11) Measurement of oxygen:
 - Set the parameter "resolution" to 0.1 %Vol or to a smaller value.
 - Do not set the parameter "Lower deadband" to a value below -0.5 %Vol.
 - Do not set the parameter "Upper deadband" to a value above 0.5 %Vol.
- 12) Operation according to EN 45544-2:
 - Touchpoint Plus is suitable for use with 4-20 mA transmitters where the output at the limit value is between 4.96 mA and 12 mA.
 - The lower limit of measurement represents 0.6 % of the upper limit of measurement (resolution set to 2 % of the limit value). It decreases when the resolution is set to smaller values.
 - Set the parameter "Upper deadband" to the lower limit of measurement (calculated for the combination of Touchpoint Plus and the connected transmitter) or to a smaller value.
 - Do not set both parameters "Lower deadband" and "Gas Under range" to values below -(2 times the lower limit of measurement).
 - Do not set the parameter "Gas Under range" below -10 % of the upper limit of measurement or -(4 times the lower limit of measurement). Use the value which is closer to zero.
- 13) Operation according to EN 45544-3:
 - Set the parameter "resolution" to 1 % of the upper limit of measurement or to a smaller value.
 - Set the parameter "Upper deadband" to 5 % of the upper limit of measurement or to a smaller value.
 - Do not set the parameter "Gas Under range" to a value below -10 % of the upper limit of measurement.
- 14) One of either RLY1 or RLY2 in main board shall be configured to System inhibit Relay.

12.3.3 Special Conditions for software update.

User is responsible for verification of all settings of Touchpoint Plus after successful update of software (e.g. Firmware, EEPROM and Sensor Catalogue Data). It is highly recommended to verify all settings are correct after software update. Follow Honeywell's software update guideline or contact Honeywell for any support in software update.

Chapter 13. Replacement Parts and Optional Extras

The following replacement parts and optional extras are available to order, but Honeywell Analytics cannot accept responsibility for their incorrect handling, storage, fitment or use.

All Honeywell supplied replacement parts are covered by the standard Honeywell warranty service.

With the exception of SD Cards, the equipment listed below is only to be installed or replaced by the Manufacturer's trained personnel, or by competent persons trained in accordance with the Manufacturer's installation instructions.

13.1 Spare Parts

Description	Part Number
Back Plane PCB Assembly	TPPLSBPM
Backup battery pack	TPPLSIBB
Cable gland	TPPLOGLD
Cable gland adaptor for M20 (13 ea.)	TPPLOGLDA
Cable gland metal ground	TPPLOMGND
CMOS Battery 3 V Type C2032 H	Local purchase
Dual Input Module 2 Channel mA: 2 Channel mV	TPPLSMAC14
Dual Input Module 4 Channel mA: 4 Channel mV	TPPLSMAC18
External Strobe	M-700123
Input Module 2 Channel mA	TPPLSMAAI2
Input Module 2 Channel mV	TPPLSMAVI2
Input Module 4 Channel mA	TPPLSMAAI4
Input Module 4 Channel mV	TPPLSMAVI4
Input Module 8 Channel mA	TPPLSMAAI8
Input Module 8 Channel mV	TPPLSMAVI8
Main Module	TPPLSMPM
Modbus RTU PCB	TPPLORTU
Output Module 12 Channel Relay	TPPLSMAROC
Output Module 4 Channel mA	TPPLSMAAO4
SD Card (2 to 32 GB) FAT32 standard format	Local purchase
SD Card (8GB)	TPPLOSDC
SMPS (150 W, 110 / 220 VAC)	TPPLSSAM
Touch Screen LCD	TPPLSLTSM
UI PCB (Motherboard)	TPPLSDPM
Wall Mounting Bracket	TPPLOWMB

13.2 Publications

These publications are available to download as printable .pdfs from the Honeywell Analytics website.

Description	Language	Part Number
TPPL Quick Start Guide (OSG)	Chinese (Simplified)	3011M5029
	Netherlands	3011M5030
	English (GB)	3011M5000
	French (Canada)	3011M5031
	French (France)	3011M5032
	German	3011M5033
	Italian	3011M5034
	Japanese	3011M5035
	Korean	3011M5036
	Portuguese (Brazil)	3011M5037
	Portuguese (Portugal)	3011M5038
	Russian	3011M5039
	Spanish (Mexico)	3011M5040
	Spanish (Spain)	3011M5041
	Swedish	3011M5058
USA	3011M5059	
TPPL Technical Handbook	English (GB)	3011M5001
Modbus Installation and Setup Guide	English (GB)	3011M5027

Description	Language	Part Number
TPPL User Guide	Chinese (Simplified)	3011M5042
	Netherlands	3011M5043
	English (GB)	3011M5044
	French (Canada)	3011M5045
	French (France)	3011M5046
	German	3011M5047
	Italian	3011M5048
	Japanese	3011M5049
	Korean	3011M5050
	Portuguese (Brazil)	3011M5051
	Portuguese (Portugal)	3011M5052
	Russian	3011M5053
	Spanish (Mexico)	3011M5054
	Spanish (Spain)	3011M5055
	Swedish	3011M5056
	USA	3011M5057

Chapter 14. TPPL Configuration Code

The following table shows how your TPPL configuration code (P/N) is displayed on the product label, which helps Technical Support to understand your system construction if you need additional help.

Product Name	Unit Type	Power	Mounting Type	Input Options	Relay Options	Output Options	Battery	External Comm's	Web Interface	Certification	
TPPL	B = Base Unit E = Expansion Unit	A = AC 110/220 V	W = Wall Mounted	A2 = 2ch mA Input	S = 12 relays	4 = 4ch mA Output	B = Backup Battery	N = None R = RTU (Modbus)	N = None R = Modbus, TCP + Web monitoring T = Modbus TCP/IP W = Modbus TCP + Web configuration	N = None	
				V2 = 2ch mV Input							
				A4 = 4ch mA Input	D = 24 relays	8 = 8ch mA Output					
				V4 = 4ch mV Input							
	D = DC 18 – 32 V	A8 = 8ch mA Input		N = No Relay	N = No mA Output	N = None					
		V8 = 8ch mV Input									
		D4 = Dual 4ch mA/mV Inputs									
		D8 = Dual 8ch mA/mV Inputs									
P/N Code: (Example)	TPPL	B	A	W	A4	S	4	B	N	N	N

Table 16. TPPL Configuration P/N Code Chart (example)

Chapter 15. Icon Glossary

#	Icon	Description	#	Icon	Description
1		Summary View Alarm	28		Trend Graph
2		Summary View Normal	29		Processing Ok
3		Summary View	30		Processing Failed
4		List View	31		Cancel
5		Tile View	32		Scroll Start
6		Output View	33		Scroll Stop
7		Information Menu	34		List Up
8		Event History Information	35		List Down
9		Event History Alarm	36		Move Up
10		Event History Fault	37		Move Down
11		Event History Inhibit	38		Move Left
12		Event History Warning	39		Move Right
13		No One Logged In	40		Maintenance Menu
14		Operator Logged In	41		System Setting Menu
15		Service Logged In	42		Configuration Menu
16		Administrator Logged In	43		Configuration
17		Menu Select	44		Calibration
18		Mains Power On	45		Inhibit
19		Mains Off, Batteries On	46		Channel Location
20		SD Card Good	47		Base Line Adjust
21		SD Card Not Good	48		Peak Reset
22		Alarm Filter	49		Trend
23		Fault Filter	50		Alarm Pop Up
24		Inhibit Filter	51		Error Pop Up
25		Warning Filter	52		Fault Pop Up
26		Filter Information	53		Inhibit Pop Up
27		Filter Refresh	54		Warning Pop Up
55		Battery Warning	58		Gas Calibration
56		Battery Critical			
57		Power Off			

Chapter 16. Compatible Sensors

The following table lists Honeywell supplied gas sensors that are known to be compatible with Touchpoint Plus.

Honeywell Gas Detectors	
Midas	Sensepoint Flammable
Searchpoint Optima Plus	Series 3000
RAEGuard 2 PID	Signalpoint Pro (now obsolescent)
Satellite XT	Signalpoint Toxic
Searchline Excel LR	Sensepoint XCD CAT
Searchline Excel MR	Sensepoint XCD EC
Searchline Excel SR	Sensepoint XCD IR
Sensepoint RFD	Sensepoint XNX CAT
Sensepoint Toxic	Sensepoint XNX EC
Sensepoint PPM	Sensepoint XNX IR
Sensepoint HT	Fire Sentry FSxx*
Flame Detector	

Refer to the respective sensor data sheets for more details.

Table 17. TPPL Gas Detectors

Note: Touchpoint Plus is not currently approved as a fire or flame detection system, but this chapter will be updated when its flammables capability is fully tested and certified.

Note: Customer-supplied 3rd Party sensors may be used, but Honeywell is unable to support them or guarantee their performance.

Note: * Only Fire Sentry FSxx mA output options are compatible. Relay contact and UV, IR alarms are not compatible.

Note: mV-bridge sensors are not suitable for use in oxygen enriched atmospheres (e.g. >21 %v/v) as the bridge bead will be too reactive, leading to false readings and premature burn-out. However Oxygen deficient atmospheres (e.g. <10 %v/v) may suppress sensor output because there will be insufficient bead reaction to change the bridge's resistance reading.

Chapter 17. Configurable Parameter Reference Guide

To avoid confusion between letter O and number 0, Ø represents number zero or logic null.

Parameter Name	Parameter Description	Applies to	Read/Write	Range	Default Value	Remark
Channel Enable	Channel Enable/Disable	mA Input	R/W	Disable/Enable	Disable	
Channel Number	Number	mA Input	R/W	1~16	-	An unique number (Auto assigning 1~16 LED) Channel ID will be automatically assigned
Channel Tag	25 characters	mA Input	R/W	Alphanumeric Character Range	50 chars	
Detector Name	20 characters	mA Input	R/W	Alphanumeric Character Range	40 chars	Write available when: Detector Name- User Detector
Target Gas Name	16 characters	mA Input	R/W	Alphanumeric Character Range	16 chars	Write available when: Detector Name- User Detector
Target Gas Unit	%, ppm, %LEL, %VOL, mA, User (6chars)	mA Input	R/W	Alphanumeric Character Range	%	Write available when: Detector Name- User Detector mg/m3, g/m3, %VOL, ppm, %LEL, UEG, Ratio, %LEL x M, ppm x m, EG x m, %Vol x m, LEL.m, LEL%.m, %V/V, mA, kppm, oC, oF, %RH
Target Gas Digit	Numbers of decimal point	mA Input		0~3	1	

Parameter Name	Parameter Description	Applies to	Read/Write	Range	Default Value	Remark
Target Resolution	Resolution	mA Input	R	0.001~100	0.1	0.001, 0.002, 0.005, 0.01, 0.02, 0.05, 0.1, 0.2, 0.5, 1, 2, 5, 10, 20, 50, 100
Inhibit Time-out	Inhibit Time-out	mA Input	R/W	0~60	10	0: Disable , minute
Alarm Latch	Alarm will be continued until manual user reset if latching is enabled.	mA Input	R/W	Disable/Enable	Enable	per channel
Calibration Interval	0, 30 to 365	mA Input	R/W	0, 30 to 365	180	0 : Disable
Target Full Range	Min full range, Max full range and user	mA Input	R/W	0~100000	Max full range	Write available when: Detector Name- User Detector. Max range in catalogue file
Threshold Alarm Hysteresis	Alarm hysteresis is to avoid the alarm from frequent on/off when the gas reading is close to the alarm threshold.	mA Input	R/W	0~10	2% of Full range	
Alarm 1 Enable	Alarm 1 enable/disable	mA Input	R/W	Disable/Enable	Disable	
Alarm 1 Threshold Trigger	Alarm 1 trigger option (Rising or Falling)	mA Input	R/W	Rising/Falling	Rising	
Alarm 1 Level	Alarm 1 threshold concentration	mA Input	R/W	2%FSD ~ 100%FSD	20% of Full range	
Alarm 2 Enable	Alarm 2 enable/disable	mA Input	R/W	Disable/Enable	Disable	
Alarm 2 Threshold Trigger	Alarm 2 trigger option (Rising or Falling)	mA Input	R/W	Rising/Falling	Rising	0 Rising, 1 Falling
Alarm 2 Level	Alarm 2 threshold concentration	mA Input	R/W	2%FSD ~ 100%FSD	40% of Full range	
Alarm 3 Enable	Alarm 3 enable/disable	mA Input	R/W	Disable/Enable	Disable	
Alarm 3 Threshold Trigger	Alarm 3 threshold concentration	mA Input	R/W	Rising/Falling	Rising	
Alarm 3 Level	Alarm 3 threshold concentration	mA Input	R/W	2%FSD ~ 100%FSD	60% of Full range	

Parameter Name	Parameter Description	Applies to	Read/Write	Range	Default Value	Remark
Gas Type	Gas Type	mA Input	R/W	0~2	Gas Type	Depend on Gas Name. Toxic(0) O2(1) Flammable(2) Flame(3)
STEL Interval *	10, 15, 20, 25, 30	mA Input	R/W	10, 15, 20, 25, 30	15	Minute
Lower Zero Dead Band	The gas concentration within the dead band limit will be suppressed to default base concentration. i.e. if the gas concentration is between the (default base concentration – lower dead band) and (default base concentration + upper dead band), then the reading will be the default base concentration.	mA Input	R/W	-20 ~ 0 % FSD	0	In case O2 :20.9%
Upper Zero Dead Band		mA Input	R/W	0 ~ 20% FSD	0	In case O2 :20.9%
Gas Over Range Limit	Over-range gas concentration limit. This parameter is used to generate over-range warning.	mA Input	R/W	100% ~ 110%FSD	110 %FSD	
Gas Under Range Limit	Negative reading limit	mA Input	R/W	-24% ~ 0%FSD	-10 %FSD	
Span Calibration Conc.	Target span gas concentration	mA Input	R/W	20 ~ 100 %FSD	50% of Full range	Oxygen needs just span calibration. No zero calibration required.
Signal Under Range Limit	Lower allowable limit for the input signal from the sensor/detector.	mA Input	R/W	0	0	To diagnose the mA input current
Signal Over Range Limit	Upper allowable limit for the input signal from the sensor/detector.	mA Input	R/W	20~24mA	Depend on detector	To diagnose the mA input current
Signal Inhibit Min.	minimum inhibit current from mA output sensor	mA Input	R/W	0~24	1.9 mA	if min/max is set to zero, mA input board will not detect inhibit condition.
Signal Inhibit Max.	maximum inhibit current from mA output sensor	mA Input	R/W	0~24	2.1 mA	
Signal Fault Min.	minimum fault current from mA output sensor	mA Input	R/W	0~24	0.0 mA	if min/max is set to zero, mA input board will not detect fault condition.

Parameter Name	Parameter Description	Applies to	Read/Write	Range	Default Value	Remark
Signal Fault Max.	maximum fault current from mA output sensor	mA Input	R/W	0~24	1.1 mA	
Signal Warning Min.	minimum warning current from mA output sensor	mA Input	R/W	0~24	2.9 mA	if min/max is set to zero, mA input board will not detect warning condition.
Signal Warning Max.	maximum warning current from mA output sensor	mA Input	R/W	0~24	3.1 mA	
Alarm 1 Function	Threshold, STEL, TWA	mA Input	R/W	0~2	Threshold	Threshold=0, STEL=1, TWA=2
Alarm 2 Function	Threshold, STEL, TWA	mA Input	R/W	0~2	Threshold	Threshold=0, STEL=1, TWA=2
Alarm 3 Function	Threshold, STEL, TWA	mA Input	R/W	0~2	Threshold	Threshold=0, STEL=1, TWA=2
Target Zero Range	Number	mA Input	R/W	0~100000	0	Write available when: Detector Name- User Detector.
Channel Enable	Channel Enable/Disable	mV Input	R/W	Disable/Enable	Disable	
Channel Number	Channel designate Number	mV Input	R/W	1~16	-	An unique number (Auto assigning 1~16 LED) Channel ID will be automatically assigned
Channel Tag	Channel description tag (25 characters)	mV Input	R/W	Alphanumeric Character Range	50 chars	
Detector Name	20 characters	mV Input	R/W	Alphanumeric Character Range	40 chars	Write available when: Detector Name- User Detector

Parameter Name	Parameter Description	Applies to	Read/Write	Range	Default Value	Remark
Target Gas Name	16 characters	mV Input	R/W	Alphanumeric Character Range	16 chars	Write available when: Detector Name- User Detector
Target Gas Unit	%, ppm, %LEL, %VOL, mA, User (6chars)	mV Input	R/W	Alphanumeric Character Range	%	Write available when: Detector Name- User Detector mg/m3, g/m3, %VOL, ppm, %LEL, UEG, Ratio, %LEL x M, ppm x m, EG x m, %Vol x m, LEL.m, LEL%.m, %V/V, mA, kppm, oC, oF, %RH
Target Gas Digit	Numbers of decimal point	mV Input	R/W	0~3	1	Changed by full scale setting
Target Resolution	Resolution	mV Input	R/W	0.1	0.1	0.01, 0.1, 0.2, 0.5, 1, 2, 5, 10, 20, 50, 100
Inhibit Time-out	Inhibit Time-out	mV Input	R/W	0~60	10	0: Disable, minute
Alarm Latch	Alarm will be continued until manual user reset if latching is enabled.	mV Input	R/W	Disable/Enable	Enable	per channel
Calibration Interval	0, 30 to 365	mV Input	R/W	0, 30 to 365	180	0: Disable
Target Full Range	1, 100, 1000, 10000, User	mV Input	R/W	100	100	Write available when: Detector Name- User Detector
Threshold Alarm Hysteresis	Alarm hysteresis is to avoid the alarm from frequent on/off when the gas reading is close to the alarm threshold.	mV Input	R/W	0~10	2% of Full range	
Alarm 1 Enable	Alarm 1 enable/disable	mV Input	R/W	Disable/Enable	Disable	
Alarm 1 Threshold Trigger	Alarm 1 trigger option (Rising or Falling)	mV Input	R/W	Rising/Falling	Rising	
Alarm 1 Level	Alarm 1 threshold concentration	mV Input	R/W	2~100%FS	20% of Full range	

Parameter Name	Parameter Description	Applies to	Read/Write	Range	Default Value	Remark
Alarm 2 Enable	Alarm 2 enable/disable	mV Input	R/W	Disable/Enable	Disable	
Alarm 2 Threshold Trigger	Alarm 2 trigger option (Rising or Falling)	mV Input	R/W	Rising/Falling	Rising	
Alarm 2 Level	Alarm 2 threshold concentration	mV Input	R/W	2~100%FS	40% of Full range	
Alarm 3 Enable	Alarm 3 enable/disable	mV Input	R/W	Disable/Enable	Disable	
Alarm 3 Threshold Trigger	Alarm 3 trigger option (Rising or Falling)	mV Input	R/W	Rising/Falling	Rising	
Alarm 3 Level	Alarm 3 threshold concentration	mV Input	R/W	2~100%FS	60% of Full range	
Gas Type	Gas type	mV Input	R/W	Flammable(2)	Flammable(2)	Depend on Gas Name Toxic(0) O2(1) Flammable(2) Flame(3)
Lower Zero Dead Band	The gas concentration within the dead band limit will be suppressed to default base concentration. i.e. if the gas concentration is between the (default base concentration – lower dead band) and (default base concentration + upper dead band), then the reading will be the default base concentration.	mV Input	R/W	-20%FSD ~ 0%FSD	0	Sensepoint ppm: -40%FSD ~ 0%FSD
Upper Zero Dead Band		mV Input	R/W	0%FSD ~ 20%FSD	0	Sensepoint ppm: 0%FSD ~ 40%FSD when the measuring range is 0 – 10 %LEL
Gas Over Range Limit	Over-range gas concentration limit. This parameter is used to generate over-range warning.	mV Input	R/W	100% ~ 105%FSD	105 %FSD	
Gas Under Range Limit	Negative reading limit	mV Input	R/W	-24% ~ 0%FSD	-10 %FSD	
Span Calibration Conc.	Target span gas concentration	mV Input	R/W	20 ~ 100 %FSD	50% of Full range	
Bridge Current	Different value Depend on Detector	mV Input	R/W	100~300mA	200 mA	
Unit Correction Factor	Correction factor for other target gas	mV Input	R/W	1	1	

Parameter Name	Parameter Description	Applies to	Read/Write	Range	Default Value	Remark
Span Calibration Gas	Span Calibration Gas name string	mV Input	R/W	Alphanumeric Character Range	16 chars	If custom is selected gas as target calibration gas, the span calibration gas name can be edited. Otherwise it should come from selected sensor catalogue.
Channel Enable	Channel Enable/Disable	Relay Output	R/W	Disable/Enable	Disable	
Channel Number	Number	Relay Output	R	1~48	-	An unique number (Auto assigning 1~16 LED) Channel ID will be automatically assigned
Channel Tag	25 characters	Relay Output	R/W	Alphanumeric Character Range	50 chars	
Normal State	Energized/De-Energised	Relay Output	R/W	Energized /De-Energised	Energized	
Alarm Update Function	If enabled, only unacknowledged alarm conditions will be considered during C&E evaluation for this output channel. An alarm acknowledgement will reset a relay output that is configured for alarm update function. However if the alarm update is NOT enabled the relay contact will only be reset if the alarm is reset.	Relay Output	R/W	Enable/Disable	Disable	
Activate Delay Time	Delay time to activate the relay	Relay Output	R/W	0~3000	0 sec	
Relay Hold Time	Delay time to de-activate the relay	Relay Output	R/W	0~3000	0 sec	

Parameter Name	Parameter Description	Applies to	Read/Write	Range	Default Value	Remark
Alarm 1 Event	Alarm 1 event	Relay Output	R/W	Enable/Disable	Disable	Total channel # = Anal_In(16) + Modbus(96)
Alarm 1 Vote Count	Set a minimum count of alarm 1 event to trigger a relay	Relay Output	R/W	0~16	0	1~selected channel #
Alarm 2 Event	Alarm 2 event	Relay Output	R/W	Enable/Disable	Disable	Total channel # = Anal_In(16) + Modbus(96)
Alarm 2 Vote Count	Set a minimum count of alarm 2 event to trigger a relay	Relay Output	R/W	0~16	0	1~selected channel #
Alarm 3 Event	Alarm 3 event	Relay Output	R/W	Enable/Disable	Disable	Total channel # = Anal_In(16) + Modbus(96)
Alarm 3 Vote Count	Set a minimum count of alarm 3 event to trigger a relay	Relay Output	R/W	0~16	0	1~selected channel #
Fault Event	Fault Event	Relay Output	R/W	Enable/Disable	Disable	Total channel # = Anal_In(16) + Modbus(96)
Fault Vote Count	Set a minimum count of Fault event to trigger a relay	Relay Output	R/W	0~16	0	1~selected channel #
Warning Event	Warning Event	Relay Output	R/W	Enable/Disable	Disable	Total channel # = Anal_In(16) + Modbus(96)
Warning Vote Count	Set a minimum count of Warning event to trigger a relay	Relay Output	R/W	0~16	0	1~selected channel #
Inhibit Event	Inhibit Event	Relay Output	R/W	Enable/Disable	Disable	Total channel # = Anal_In(16) + Modbus(96)
Inhibit Vote Count	Set a minimum count of Inhibit event to trigger a relay	Relay Output	R/W	0~16	0	1~selected channel #
Vote Count Reduction on fault	0: reduction, 1: no reduction	Relay Output	R/W	Check/not check	Check	
Vote Count Reduction on inhibit	0: reduction, 1: no reduction	Relay Output	R/W	Check/not check	Check	
Channel Enable	Channel Enable/Disable	mA Output	R/W	TRUE/FALSE	Disable	
Channel Number	Number	mA Output	R	1~16	-	Channel ID will be automatically assigned

Parameter Name	Parameter Description	Applies to	Read/Write	Range	Default Value	Remark
Channel Tag	25 characters	mA Output	R/W	unicode 50 chars	Output Channel	
Output Function Channel		mA Output	R/W	Enable/Disable	Disable	Only mA and mV input channel can be linked to this
Inhibit Output Level	1.0 1.5 2.0 2.5 3.0 3.5 User	mA Output	R/W	0~23.5	2.0 mA	
Fault Output Level	1.0 1.5 2.0 2.5 3.0 3.5 User	mA Output	R/W	0~23.5	1.0 mA	
Warning Output Level	1.0 1.5 2.0 2.5 3.0 3.5 User	mA Output	R/W	0~23.5	3.0 mA	
Over-range Output Level	20.5, 21.0, 21.5	mA Output	R/W	20.5, 21.0, 21.5	20.5	
Web Access	Enable/disable Web service	System	R/W	Enable/Disable	Disable	disable: Not available WEB
DHCP Enable	DHCP / manual IP setting	System	R/W	Enable/Disable	Disable	
Static IP Address	Static IP Address	System	R/W	Alphanumeric Character Range	192.168.0.100	xxx.xxx.xxx.xxx
Static Subnet Address	Static Subnet Address	System	R/W	Alphanumeric Character Range	255.255.255.0	xxx.xxx.xxx.xxx
Static Gateway Address	Static Gateway Address	System	R/W	Alphanumeric Character Range	192.168.0.1	xxx.xxx.xxx.xxx
MAC Address	max 20 characters	System	R	NA	NA	xx-xx-xx-xx-xx-xx. Writing is only possible during production.
Operator Password	Password for Access Level Operator	System	R/W	35 chars	TPPL	

Parameter Name	Parameter Description	Applies to	Read/Write	Range	Default Value	Remark
Maintainer Password	Password for Access Level Maintainer	System	R/W	35 chars	TPPL	
Admin Password	Password for Access Level Admin	System	R/W	35 chars	TPPL	
Web Operator password	Password for Access Level Web Operator	System	R/W	35 chars	TPPL	
Service Contact	Service contact	System	R/W	120 chars	tpp@honeywell.com	
System Label	System label	System	R/W	50 chars	TPPL	
Home Screen	Home Screen types	System	R/W	list, tile, sum	List(0)	
Enable Remote Inhibit	Enable/disable Remote inhibit	System	R/W	Enable/Disable	Disable(0)	
Remote Inhibit State	Get Remote inhibit state	System	R/W	Open/Close	Open(0)	Normal Open(0), Normal Close(1)
Menu Timeout	Set Menu time out	System	R/W	5~100	90	seconds
Auto Logout Timeout	Set auto logout time for menu	System	R/W	15~100	15	minutes
Dedicated Alarm1	Set an alarm event to Dedicated Alarm output #1	System	R/W	Alarm1/Alarm2 /Alarm3	0 (Alarm1)	
Dedicated Alarm2	Set an alarm event to Dedicated Alarm output #2	System	R/W	Alarm1/Alarm2 /Alarm3	1 (Alarm2)	
Enable Remote reset/ack	Remote reset enable/disable	System	R/W	Enable/Disable	Disable	
Gas log Interval	Gas log interval	System	R/W	0~600	15	0: Disable, second
Gas log Threshold	Gas log Threshold	System	R/W	0.1~2.0	0	%FS 0 means that gas log will be stored every log interval.
Buzzer Enable	Buzzer enable/disable	System	R/W	Enable/Disable	Disable	

Parameter Name	Parameter Description	Applies to	Read/Write	Range	Default Value	Remark
Buzzer activation on Warning enable	Buzzer enable/disable for warning	System	R/W	Enable/Disable	Enable	
LCD backlight Timeout	Set LCD backlight timeout	System	R/W	30	30	seconds
LCD Brightness	Set LCD brightness	System	R/W	10~100	100	
Language Setting	Select a language to display screen	System	R/W	0~9	English(0)	ENGLISH = 0u, CHINESE, FRENCH, GERMAN, DUTCH, ESPANOL, RUSSIAN, PORTUGUESE
Time Format	Time, date format	System	R/W	0~3	0	0 HH:MM:SS DD/MM/YYYY 1 HH:MM:SS DD/MM/YY 2 YY/MM/DD HH:MM:SS 3 HH:MM:SS MM/DD/YY

Chapter 18. Event Codes

Event Type	Code	Long Description	Triggered	Display in Event History	Details
Alarm	1	Alarm1 occurred	Main Board	Alarm1 occurred CH: xx, Type: xx, xxx[unit]	Type Threshold/STEL/TWA, value
Alarm	2	Alarm2 occurred	Main Board	Alarm1 occurred CH: xx, Type: xx, xxx[unit]	Type Threshold/STEL/TWA, value
Alarm	3	Alarm3 occurred	Main Board	Alarm1 occurred CH: xx, Type: xx, xxx[unit]	Type Threshold/STEL/TWA, value
Alarm	4	Alarm1 cleared	Main Board	Alarm1 cleared CH: xx, Type: xx, xxx[unit]	Type Threshold/STEL/TWA, value
Alarm	5	Alarm2 cleared	Main Board	Alarm1 cleared CH: xx, Type: xx, xxx[unit]	Type Threshold/STEL/TWA, value
Alarm	6	Alarm3 cleared	Main Board	Alarm1 cleared CH: xx, Type: xx, xxx[unit]	Type Threshold/STEL/TWA, value
Alarm	7	Reset all alarms by user	Main Board	Reset all alarms	
Fault	1	Internal communication fault	All	Communication fault [B/D Type], [Fault Description]	B/D type 0:Main, 1:UI, 2:mA Input, 3 : mV input, 4:Relay, 5:mA output, 7:Modbus, 7:Extension power Fault Description 0: SPI , 1: I2C , 2: IO CAN , 3: Main CAN, 4: UI CAN, 4: Ext CAN, 6: UART failure
Fault	2	internal memory fault	IO board / Main board	Memory fault [B/D Type], [Fault Description]	Fault Description 0: Internal RAM, 1: External RAM , 2: Code memory, 3: EEPROM, 4: Flash
Fault	3	Catalog memory corrupted	UI	Catalog memory fault	
Fault	4	Internal HW fault	IO board / Main board	Internal hardware fault [B/D Type]	B/D type 0:Main, 1:UI, 2:mA Input, 3 : mV input, 4:Relay, 5:mA output, 7:Modbus, 7:Extension power
Fault	5	Sensor circuit fault	IO board	Sensor circuit fault CH: xx, Code: xxx	Code 0: Gain setting error, 1: signal conditioning circuit error

Event Type	Code	Long Description	Triggered	Display in Event History	Details
Fault	6	Supplied voltage fault	IO board / Main board	Supplied voltage fault [B/D Type], Code: xxx	B/D type 0:Main, 1:UI, 2:mA Input, 3 : mV input, 4:Relay, 5:mA output, 7:Modbus, 7:Extension power Code 0: Vapp low, 1: V5 low, 2: V3.3 low, 3: V12 low, 4: V9 low
Fault	7	Internal software failure	IO board / Main board	Internal software fault [B/D Type], Code: xxx	B/D type 0:Main, 1:UI, 2:mA Input, 3 : mV input, 4:Relay, 5:mA output, 7:Modbus, 7:Extension power Code 0: BUFFER OVERFLOW, 1: instruction test failed 2: Sequence Checking failed
Fault	8	Modbus communication failure	IO board	Modbus Comm Fault CH: xx, Node: xx	
Fault	9	Sensor fault (including signal range fault)	IO board	Sensor Fault CH: xx, [B/D Type], Code: xx	B/D type 0:Main, 1:UI, 2:mA Input, 3 : mV input, 4:Relay, 5:mA output, 7:Modbus, 7:Extension power Code 0 : bead open/short 1 : line open/short 2 : detector short 3 : operating voltage fault 4: driver current fault
Fault	10	Analogue output mismatched	IO board	mA Output Error CH: xx	
Fault	11	Relay not controlled	IO board / Main board	Relay Output Error CH: xx	
Fault	12	Remote fault informed by detector (depending on fault signal range)	IO board	Detector In Fault CH: xx, [B/D Type]	B/D type 0:Main, 1:UI, 2:mA Input, 3 : mV input, 4:Relay, 5:mA output, 7:Modbus, 7:Extension power

Event Type	Code	Long Description	Triggered	Display in Event History	Details
Fault	13	Auxiliary battery fault	Main Board	Battery Fault [Enclosure]	Enclosure 0: master enclosure, 1: extension enclosure
Fault	14	IO board not matched or present	Main Board	IO B/D Not Matched Slot: xx-x, Prev: xxx, Curr: xxx	Prev, Curr B/D type 0:Main, 1:UI, 2:mA Input, 3 : mV input, 4:Relay, 5:mA output, 7:Modbus, 7:Extension power Slot Refer to the note 1
Fault	15	Cell is producing a negative reading (depending on gas under-range limit)	Main Board	Negative Reading CH: xx, Conc: xxxx [unit]	
Fault	16	Fault self-cleared	Main Board	Fault Cleared CH: xx, Code: xx	Code Code Number (1~17)
Fault	17	Reset all faults by a user	Main Board	Reset all faults	
Inhibit	1	Inhibited input channel by LUI	Main Board	Inhibited input channel CH: xx	
Inhibit	2	Cleared inhibit mode for input channel by LUI	Main Board	Cleared inhibit mode CH: xx	
Inhibit	3	Inhibited all input channels remotely	Main Board	Inhibited all channels remotely	
Inhibit	4	Cleared inhibit mode for all input channel remotely	Main Board	Cleared inhibit mode remotely CH: xx	
Inhibit	5	Detected inhibit input from detector	IO board	Detector In Inhibit CH: xx	
Warning	1	Battery low (not critical)	Main Board	Battery is low [Enclosure], xxx %	Enclosure 0: master enclosure, 1: extension enclosure
Warning	2	Battery is not being charged	Main Board	Battery not charged [Enclosure]	Enclosure 0: master and extension enclosure
Warning	3	RESERVED			
Warning	4	Over-range warning (depending on gas over-range limit)	Main Board	Over range CH: xx, Conc: xxxx [unit]	
Warning	5	Calibration is due soon	Main Board	Calibration is overdue CH: xx, Due: xxxx	Due Calibration interval - days passed after successful calibration
Warning	6	Time/date not set	UI Board	Date/Time not set [Date/Time]	

Event Type	Code	Long Description	Triggered	Display in Event History	Details
Warning	7	IP conflicts detected	UI Board	IP Conflicts xxx.xxx.xxx.xxx	
Warning	8	Remote warning informed by detector	IO board	Detector In warning CH: xx	
Warning	9	Language memory corrupted	UI Board	Language memory fault	
Warning	10	Log memory corrupted	UI Board	Log memory fault	
Warning	11	Warning self-cleared (non-latching)	Main Board	Warning Cleared CH: xx, Code: xx	Code A warning number (1~14)
Warning	12	Reset all warnings by a user	Main Board	Reset all warning	
Warning	13	SD Card Corrupted	UI Board	SD Card fault	
Warning	14	Too many unsuccessful login attempts	UI Board	10 times' login failed	
Info	1	Instrument power on	UI Board	Unit powered on	
Info	2	Switched into power-off mode	UI Board	RESERVED	
Info	3	Instrument rebooted automatically	UI Board	RESERVED	
Info	4	Instrument power changed from AC to DC	Main Board	Switched to Battery [Enclosure]	Enclosure 0: master enclosure, 1: extension enclosure
Info	5	Instrument power changed from DC to AC	Main Board	Switched to AC [Enclosure]	Enclosure 0: master enclosure, 1: extension enclosure
Info	6	Added IO board	UI Board	Added IO board [B/D Type], Slot: xx-x	B/D type 0:Main, 1:UI, 2:mA Input, 3: mV input, 4:Relay, 5:mA output, 7:Modbus, 7:Extension power Slot Refer to the note 1
Info	7	Removed IO board	UI Board	Remove IO board [B/D Type], Slot:xx-x	B/D type 0:Main, 1:UI, 2:mA Input, 3: mV input, 4:Relay, 5:mA output, 7:Modbus, 7:Extension power
Info	8	Replaced IO board	UI Board	Replaced IO board [B/D Type], Slot: xx-x	B/D type 0:Main, 1:UI, 2:mA Input, 3: mV input, 4:Relay, 5:mA output, 7:Modbus, 7:Extension power Slot Refer to Note 1

Event Type	Code	Long Description	Triggered	Display in Event History	Details
Info	9	Enabled IO channel	UI Board	Enabled channel CH: xx, [B/D Type]	B/D type 0:Main, 1:UI, 2:mA Input, 3: mV input, 4:Relay, 5:mA output, 7:Modbus, 7:Extension power
Info	10	Disabled IO channel	UI Board	Disabled channel CH: xx, [B/D Type]	B/D type 0:Main, 1:UI, 2:mA Input, 3: mV input, 4:Relay, 5:mA output, 7:Modbus, 7:Extension power
Info	11	Local Login	UI Board	Logged in unit [operator]	operator 0: Operator, 1:Maintainer, 2:Administrator
Info	12	Local Logout	UI Board	Logged out from unit [Role]	Role 0: Normal, 1:Time-out
Info	13	Local login failed	UI Board	Login failed [operator]	operator 0: Operator, 1:Maintainer, 2:Administrator
Info	14	Remote login via web	UI Board	RESERVED	
Info	15	Remote logout via web	UI Board	RESERVED	
Info	16	Remote login failed via web	UI Board	RESERVED	
Info	17	Calibration successful	Main Board	Calibration passed CH: xx, Conc: xxx[unit]	
Info	18	Calibration failed	Main Board	Calibration failed CH: xx, Conc: xxx[unit]	
Info	19	mA Input Configuration Changed	Main Board	Configured mA input channel CH: xx	
Info	20	mV Input Configuration Changed	Main Board	Configured mV input channel CH: xx	
Info	21	Modbus Input Configuration Changed	Main Board	Configured modbus channel CH: xx	
Info	22	Relay Output Configuration Changed	Main Board	Configured relay output channel CH: xx	
Info	23	mA Output Configuration Changed	Main Board	Configured mA output channel CH: xx	
Info	24	Button Press – Acknowledge alarms and faults	Main Board	Pressed Ack button [button type]	Button type 0:On Board, 1:Remote

Event Type	Code	Long Description	Triggered	Display in Event History	Details
Info	25	Button Press – Reset alarms and faults	Main Board	Pressed Reset button [button type]	Button type 0:On Board, 1:Remote, 2: LUI
Info	26	Reset peak readings	UI Board	Reset Peak Reading CH: xxx (it could be individual or All)	
Info	27	Exported system configuration	UI Board	Exported system Configuration	
Info	28	Imported system configuration	UI Board	Imported system Configuration	
Info	29	Changed system date/time settings via LUI	UI Board	Changed date/time YYYY:MM:DD hh:mm:ss	
Info	30	Changed system language	UI Board	Changed language [Language ID]	Language ID 0: English, 1: China, 2:French, 3:German, 4:Netherlands, 5:Spain, 6:Russian, 7:Portugal
Info	31	Changed network settings	UI Board	Changed network settings [Network Type]	Type 0: Ethernet, 1: RS485
Info	32	Changed web access settings	UI Board	RESERVED	
Info	33	Touch screen calibration successful	UI Board	Passed touch calibration	-
Info	34	Touch screen calibration failed	UI Board	Failed in touch calibration	-
Info	35	Changed LCD backlight settings	UI Board	Changed LCD settings	-
Info	36	SD Card was inserted	UI Board	SD Card inserted	
Info	37	SD card was removed	UI Board	SD Card removed	Type 0: gracefully, 1: abruptly
Info	38	Formatted SD card successfully	UI Board	SD Card formatted	
Info	39	SD card is not formatted / corrupted	UI Board	SD Card not formatted	
Info	40	SD card is almost full	UI Board	SD Card almost full	
Info	41	Changed password settings	UI Board	Changed password [operator]	Operator 0: Operator, 1:Maintainer, 2:Administrator
Info	42	Changed system Label	UI Board	Changed system label	
Info	43	mA Input calibration successful	UI Board	mA Input calibration passed Ch: xxx	
Info	44	mA Input calibration failed	UI Board	mA Input calibration failed CH: xx	

Event Type	Code	Long Description	Triggered	Display in Event History	Details
Info	45	mA Output calibration successful	UI Board	mA output calibration passed CH: xx	
Info	46	mA Output calibration failed	UI Board	mA output calibration failed CH: xx	
Info	47	mV baseline adjusted successfully	UI Board	mV base adjusted CH: xx	
Info	48	Failed in mV baseline adjustment	UI Board	mV base not adjusted CH: xx	
Info	49	mV bridge current adjusted successful	UI Board	mV current adjusted CH: xx	
Info	50	Failed in mV bridge current adjustment	UI Board	mV current not adjusted CH: xx	
Info	51	Performed LCD screen test	UI Board	RESERVED	
Info	52	Performed LED test	UI Board	RESERVED	
Info	53	Performed buzzer test	UI Board	RESERVED	
Info	54	Relay output forced	UI Board	Forced relay CH: xx	
Info	55	Relay output released	UI Board	Released Relay CH: xx	
Info	56	Analogue output forced	UI Board	Forced mA output CH: xx, xxx mA	
Info	57	Analogue output released	UI Board	Release mA output CH: xx	
Info	58	Started input channel test	UI Board	RESERVED	
Info	59	Ended input channel test	UI Board	RESERVED	
Info	60	Started Relay Output Simulation	UI Board	Started Relay Sim. CH: xx	
Info	61	Ended Relay Output Simulation	UI Board	Ended Relay Sim. CH: xx	
Info	62	Updated Firmware	UI Board	FW Updated [B/D Type], Ver: x.x.x	Type 0:Main, 1:UI, 2:mA Input, 3 : mV input, 4:Relay, 5:mA output, 7:Modbus, 7:Extension power
Info	63	Firmware Update failed	UI Board	FW Update Failed [B/D Type], Ver: x.x.x	B/D type 0:Main, 1:UI, 2:mA Input, 3 : mV input, 4:Relay, 5:mA output, 7:Modbus, 7:Extension power
Info	64	Updated sensor catalogue	UI board	Catalog Updated Ver: xxxx	

Event Type	Code	Long Description	Triggered	Display in Event History	Details
Info	65	Failed in Catalog update	UI Board	Catalog Update failed Ver: xxxx	
Info	66	Updated web pages	UI board	Webpage Updated Ver: x.x.x	
Info	67	Failed in webpage update	UI Board	Webpage Update Failed Ver: x.x.x	
Info	68	Updated language	UI Board	Font Updated Ver: xxxx	
Info	69	Failed in language update	UI Board	Font Update Failed Ver: xxxx	
Info	70	Removed IO channel	UI Board	Removed channel CH: xx, [B/D Type]	B/D type 0:Main, 1:UI, 2:mA Input, 3 : mV input, 4:Relay, 5:mA output, 7:Modbus, 7:Extension power
Info	71	Updated module data	UI Board	Updated module data [B/D type], Ver: xxxx	B/D type 0:Main, 1:UI, 2:mA Input, 3 : mV input, 4:Relay, 5:mA output, 7:Modbus, 7:Extension power
Info	72	Failed in module data update	UI Board	Failed in module data update [B/D type], Ver: xxxx	B/D type 0:Main, 1:UI, 2:mA Input, 3 : mV input, 4:Relay, 5:mA output, 7:Modbus, 7:Extension power

Chapter 19. List of Figures

Figure 1.	Quick Start Guide Label (Not to Scale)	16
Figure 2.	Rating Label (External – Not Shown Below)	16
Figure 3.	Protective Earth (Ground) Point	16
Figure 4.	Equipment Earth (Ground) Point	16
Figure 5.	Internal Label Positions	16
Figure 6.	Touchpoint Plus Wall-Mounted Controller	21
Figure 7.	Typical Installation Options	21
Figure 8.	TPPL Controller Exploded View	22
Figure 9.	Undoing the Two Security Screws and Opening the Enclosure	23
Figure 10.	Controller Unit Layout Before Installation	26
Figure 11.	Expansion Unit Layout Before Installation	27
Figure 12.	Backplane DIP Switch Settings	27
Figure 13.	Installation Clearance Measurements	28
Figure 14.	Wall Mounting Template	29
Figure 15.	Wall and Plate Mounting Points	29
Figure 16.	Switched Mode Power Supply (SMPS) Connections	31
Figure 17.	Connections for DC 24 V Supply	32
Figure 18.	Connecting the Touchpoint Plus and Optional Expansion Unit to a Mains Supply	34
Figure 19.	Basic Unit Main Module Connections	35
Figure 20.	Expansion Unit Main Module Connections	36
Figure 21.	Connecting the Expansion Unit to the Basic Unit	36
Figure 22.	Backplane DIP Switch Settings	37
Figure 23.	Ethernet Cable Fitting	37
Figure 24.	Dedicated Alarm Circuit Connections	38
Figure 25.	Optional Remote Reset and Inhibit Switch Connections	38
Figure 26.	Three Wire Device Powered by a mA Input Module	39
Figure 27.	Three Wire Device Powered by an External Source	40
Figure 28.	Two Wire Device Powered by a mA Input Module	40
Figure 29.	Two Wire Device Powered by an External Source	40
Figure 30.	Two Wire Device Barrier Device Powered by a mA Input Module	41
Figure 31.	Grounding for Screened Cable with Armour and with Metal Junction Box and Sensor	41
Figure 32.	Grounding for Screened Cable, No Armour, with Metal Junction Box and Sensor	41
Figure 33.	Grounding for Screened and Armoured Cable with Plastic Junction Box and Sensor	42
Figure 34.	Grounding for Screened Cable with Plastic Junction Box and Sensor	42
Figure 35.	Catalytic Detector Connections	43
Figure 36.	Dual Input Module Terminal Layout	44
Figure 37.	mA Output Module Connections	45
Figure 38.	Output Relay States	47
Figure 39.	PCB Cover Screws (Arrowed)	47
Figure 40.	Motherboard Showing the Modbus PCB Location	48
Figure 41.	Modbus RTU Connections	48
Figure 42.	Two Modbus Installation Examples (other methods may be used)	49

Figure 43.	Information Menu	50
Figure 44.	Configuration Menu	51
Figure 45.	Maintenance Menu	52
Figure 46.	System Test Menu	52
Figure 47.	Touchpoint Plus Controller User Interface	81
Figure 48.	Web Interface Channel List View	102
Figure 49.	Web Interface Channel Summary View	102
Figure 50.	Web Interface Connection Failed Dialog	102
Figure 51.	Web Interface Information Menu Showing Event History	103
Figure 52.	Battery On/Off Switch and Battery Connector	121

Chapter 20. List of Tables

Table 1.	Maximum Power Consumption Calculations	24
Table 2.	Power Supply (SMPS RS-150-24) Electrical Ratings	24
Table 3.	System Weights	25
Table 4.	System Dimensions	25
Table 5.	Regional Power Cable Colours	31
Table 6.	mA Input Module Connections	39
Table 7.	mV Input Module Connections	43
Table 8.	Firmware Requirements	44
Table 9.	Dual Input Module Connections	45
Table 10.	mA Output Module Connections	45
Table 11.	Relay Output Module Connections	46
Table 12.	Home Screen Menu Icons	53
Table 13.	Home Screen Menu Icons	82
Table 14.	User / Component Matrix	85
Table 15.	Home Screen Icons	88
Table 16.	TPPL Configuration P/N Code Chart (example)	133
Table 17.	TPPL Gas Detectors	135

Find out more

www.honeywellanalytics.com

Contact Honeywell Analytics:**Europe, Middle East, Africa**

Life Safety Distribution GmbH

Javastrasse 2

8604 Hegnau

Switzerland

Tel: +41 (0)44 943 4300

Fax: +41 (0)44 943 4398

gasdetection@honeywell.com

Customer Service

Tel: 00800 333 222 44 (Freephone number)

Tel: +41 44 943 4380 (Alternative number)

Fax: 00800 333 222 55

Middle East Tel: +971 4 450 5800 (Fixed Gas Detection)

Middle East Tel: +971 4 450 5852 (Portable Gas Detection)

Americas

Honeywell Analytics Inc.

405 Barclay Blvd.

Lincolnshire, IL 60069

USA

Tel: +1 847 955 8200

Toll free: +1 800 538 0363

Fax: +1 847 955 8210

detectgas@honeywell.com

Asia Pacific

Honeywell Analytics Asia Pacific

7F SangAm IT Tower,

434 Worldcup Buk-ro, Mapo-gu,

Seoul 03922, Korea

Tel: +82 (0)2 6909 0300

Fax: +82 (0)2 2025 0328

India Tel: +91 124 4752700

analytics.ap@honeywell.com

Technical Services

EMEA: HAexpert@honeywell.com

US: ha.us.service@honeywell.com

AP: ha.ap.service@honeywell.com

www.honeywell.com

Please note:

While every effort has been made to ensure accuracy in this publication, no responsibility can be accepted for errors or omissions. Data and legislation may change and you are strongly advised to obtain copies of the most recently issued regulations, standards and guidelines. This publication is not intended to form the basis of a contract.

Issue 4 EN 01/2019
H_MAN0984_EMEA
3011M5001 HAA190006
© 2019 Honeywell
Analytics

HoneywellTHE POWER OF **CONNECTED**