

# INSTALLATION

- The earth bonding arrangement must ensure that the maximum peak voltage between the unit case earth and any field cable conductor is less than 350V. Voltages in excess of this can cause permanent damage to the unit's RFI protection filters.
- The use of a single, screened cable for each gas detector ensures maximum screening and minimum crosstalk. Cabling arrangements which use a single cable for connecting a number of field devices compromise screening, increase the potential for crosstalk and prevent implementation of true star earthing.
- Any electrical interference induced onto the 4-20mA loop conductors by the installation must be kept below the levels necessary to comply with the general requirements of EN50054. In practice, this means that peak noise currents induced on the current loop should be no greater than  $\pm 0.25\text{mA}$ .
- The 0V rail of the control card / control system is often directly connected to one side of the 4-20mA current sensing resistor. Electrical noise on such a rail is therefore directly connected to the 4-20mA input. In order to avoid additional noise being induced on the 0V rail, it should not be commoned with the safety earth/ground, which frequently carries a high level of electrical noise.
- All electrical equipment connected to the system should comply with EN50081 & EN50082.
- The 24V supply should be free from large transients and fluctuations.
- The field cabling conductors should have sufficient cross sectional area to ensure that the minimum supply voltage applied to the system is 18V at a current of 420mA.  
  
This corresponds to a maximum round loop impedance of 14 ohms for a nominal 24V system supply.
- Receivers should not be installed in close proximity to the antennae of high powered radios, radar and satellite communication equipment.

11

# INSTALLATION

## 4.3.2 Electrical Installation

- Isolate all associated power supplies and ensure that they remain OFF during this procedure.
- If the units are to be installed with junction boxes other than DVC100/DX100 junction boxes, ensure that the boxes:
  - have M20 cable gland entries for BASEEFA units, or 3/4 NPT for UL and CSA.
  - have terminals for 5 wires and an earth.
- Remove the M20 blanking plugs (if fitted) and attach the Excel transmitter and receiver cables to their junction box. Fit the locking rings (if supplied) before terminating the cables in the junction box.
- Fit approved cable glands to the junction box cable entries, using sealing washers where necessary to maintain the ingress protection rating.
- Fit approved blanking plugs to all unused cable entries.
- Make appropriate electrical connections as shown in the following diagrams.

## 4.3.3 Receiver Connections via DVC100

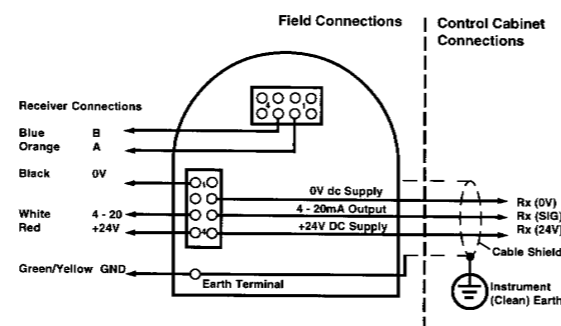

12

# INSTALLATION

## 4.3.4 Receiver Connections via DX100

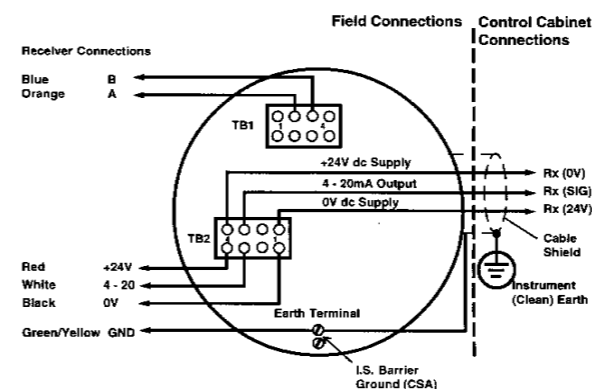

## 4.3.5 Transmitter Connections

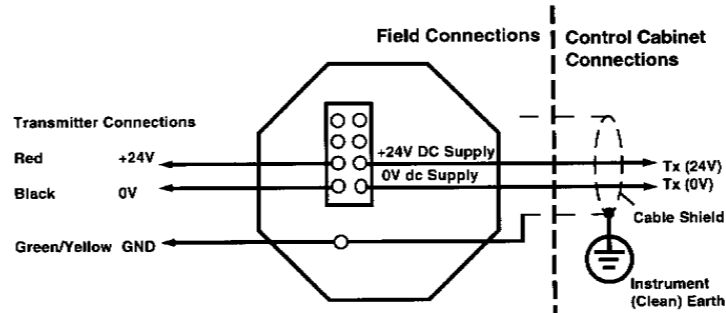

13

# INSTALLATION

## 4.3.6 Remote Installation Receiver Connections

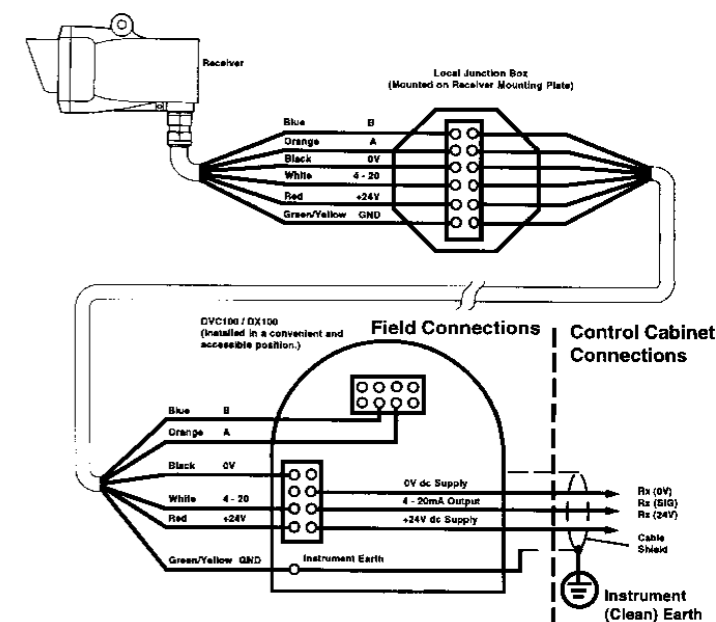

## 4.3.7 Transmitter Connections - Turbo Heating Disabled

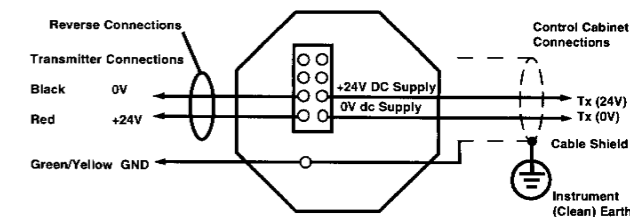

14

## Installation Guide

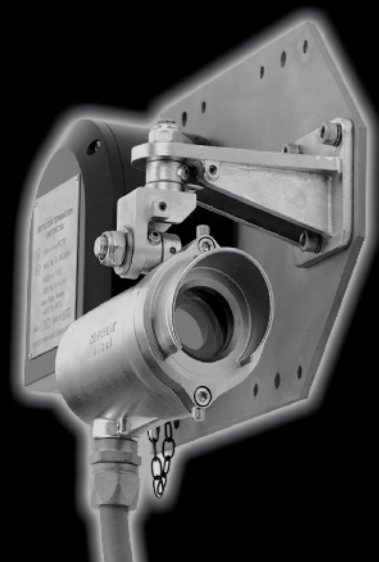

## Searchline Excel Open Path Infrared Gas Detector

# CONTENTS

1. Introduction	2
2. Safety	3
3. Mechanical assembly	4
3.1 General	4
3.2 Transmitter	4
3.3 Receiver	4
3.4 Adjustable Mountings	5
4. Installation	6
4.1 General	6
4.2 Mechanical Installation	6
4.3 Electrical Installation	10
4.3.1 Electrical Connections	10
4.3.2 Electrical Installation	12
4.3.3 Receiver Connections via DVC100	12
4.3.4 Receiver Connections via DX100	13
4.3.5 Transmitter Connections	13
4.3.6 Remote Installation Receiver Connections	14
4.3.7 Transmitter Connections - Turbo Heating Disabled	14

# 1. INTRODUCTION

This guide provides the installation personnel with the basic information necessary to mechanically install the Searchline Excel system units and make the necessary electrical connections.

This guide is not intended to replace the associated Searchline Excel Technical Handbook (2104M0505) which contains the full safety, installation, commissioning, maintenance and fault finding instructions.

These procedures assume that consideration of the location and mounting of the system units has already been taken into account in accordance with the guidelines in the Technical Handbook.

The following diagram shows a typical system configuration and identifies the main parts.

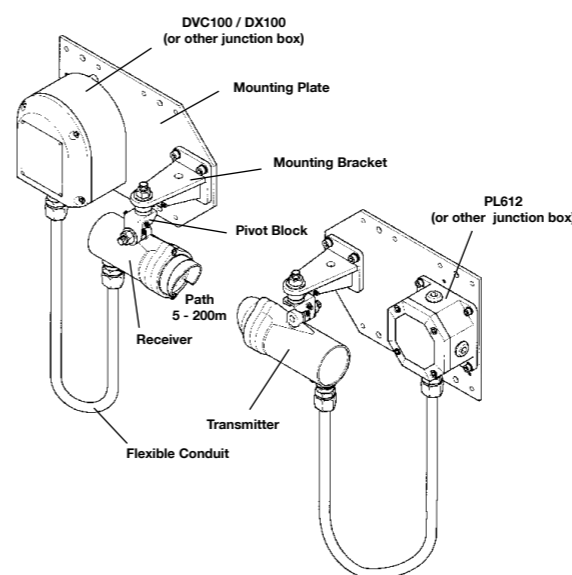

2

## Find out more

[www.honeywellanalytics.com](http://www.honeywellanalytics.com)

## Contact Honeywell Analytics:

### Europe, Middle East, Africa

Life Safety Distribution AG  
Wilstrasse 11-U31  
CH-8610 Uster  
Switzerland  
Tel: +41 (0)44 943 4300  
Fax: +41 (0)44 943 4398  
[gasdetection@honeywell.com](mailto:gasdetection@honeywell.com)

### Americas

Honeywell Analytics Distribution, Inc.  
405 Barclay Blvd.  
Lincolnshire, IL 60069  
USA  
Tel: +1 847 955 8200  
Toll free: +1 800 538 0363  
Fax: +1 847 955 8208  
[detectgas@honeywell.com](mailto:detectgas@honeywell.com)

### Asia Pacific

Honeywell Analytics Asia Pacific  
#508, Kolon Science Valley (1)  
187-10 Guro-Dong, Guro-Gu  
Seoul, 152-050,  
Korea  
Tel: +82 (0)2 2025 0307  
Fax: +82 (0)2 2025 0329  
[analytics.ap@honeywell.com](mailto:analytics.ap@honeywell.com)

## Technical Services

[ha.emea.service@honeywell.com](mailto:ha.emea.service@honeywell.com)

[www.honeywell.com](http://www.honeywell.com)

Issue 02 12/2005  
H\_MAN0558\_2104M0510  
09-07  
© 2007 Honeywell Analytics



11063

1

## 2. SAFETY

Ensure that you read and understand these instructions **BEFORE** handling or operating the equipment.

Please pay particular attention to the Safety Warnings.

### WARNINGS

The Searchline Excel System is certified for and intended for use in potentially hazardous areas. Install and use the Searchline Excel System in accordance with the latest regulations.

For installations in the UK, the Code of Practice SELECTION, INSTALLATION AND MAINTENANCE OF ELECTRICAL APPARATUS FOR USE IN POTENTIALLY EXPLOSIVE ATMOSPHERES should be strictly observed. General recommendations are given in BS5345:Part 1:1989. Specific requirements for flameproof (Type 'd'), intrinsically safe (Type 'i') and increased safety (type 'e') protection are given in BS 5345: Part 3: 1979, BS 5345:Part 4:1977 and BS 5345: Part 6:1978 respectively.

For installations in North America, the national Electrical Code (NFPA 70 - 1990) or later issues should be strictly observed.

Elsewhere, the appropriate local or national regulations should be used.

The Code of Practice regarding SELECTION, INSTALLATION, USE AND MAINTENANCE OF APPARATUS FOR THE DETECTION OF COMBUSTIBLE GASES (OTHER THAN FOR MINING APPLICATIONS OR EXPLOSIVE PROCESSING AND MANUFACTURE) must be complied with. Refer to BS6959:1988 in the UK or the appropriate local or national regulations.

Honeywell Analytics Limited reserve the right to change or revise the information supplied in this document without notice and without obligation to notify any person or organisation of such revision or change. If further details are required that do not appear in this document, contact Honeywell Analytics Limited or one of their agents.

3

## 3. MECHANICAL ASSEMBLY

### 3.1 GENERAL

This section details the mechanical assembly information and important dimensions necessary for installing the system units. Adjustable parts which form part of the mounting assemblies are also shown.

### 3.2 TRANSMITTER

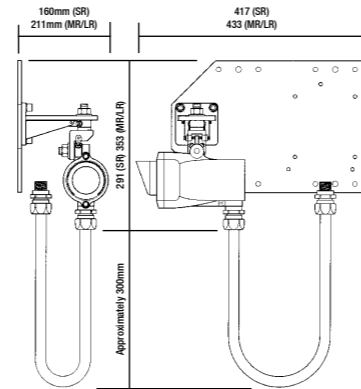

### 3.3 RECEIVER

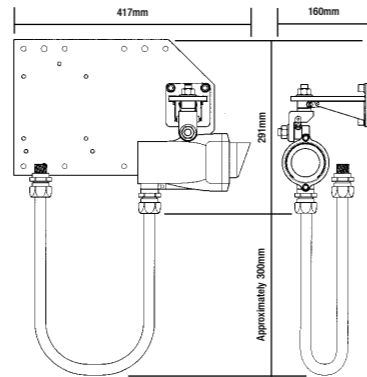

4

## MECHANICAL ASSEMBLY

### 3.4 ADJUSTABLE MOUNTINGS

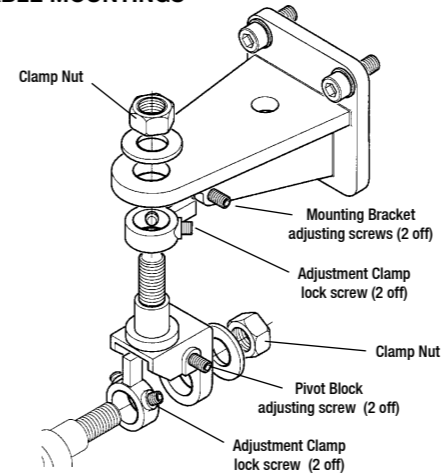

5

## 4. INSTALLATION

### 4.1 GENERAL

Searchline Excel is designed to allow installation to be performed by a single operator.

The installation procedure is split into mechanical installation and electrical installation. Each unit needs to be mounted to a supporting structure before making the electrical connections. The diagrams show different ways of orientation for the mountings.

### 4.2 MECHANICAL INSTALLATION

This mechanical installation procedure applies to both the receiver and the transmitter.

1. Ensure that the equipment to be installed is correct for the type of installation required (i.e. short/medium/long range).
2. Fit the mounting bracket to the mounting plate for the unit, as shown.
3. Fit the mounting plate to the supporting structure in one of the following ways:

- by through bolts directly to a flat surface.
- by U-bolts (2 off) to a single 150mm diameter pipe/pole.
- by U-bolts (4 off) to two 55mm diameter pipes/poles, 166mm apart.

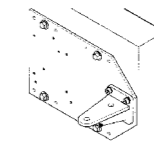
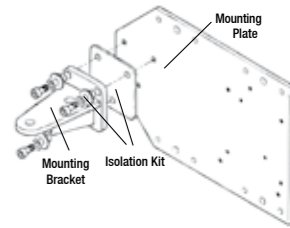

Surface Mounting

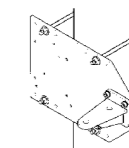

Single Pipe / Pole

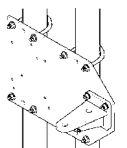

Dual Pipes / Poles

6

## INSTALLATION

Identify the mounting holes using the following diagram and the accompanying table. The subsequent diagrams show the different types of mountings.

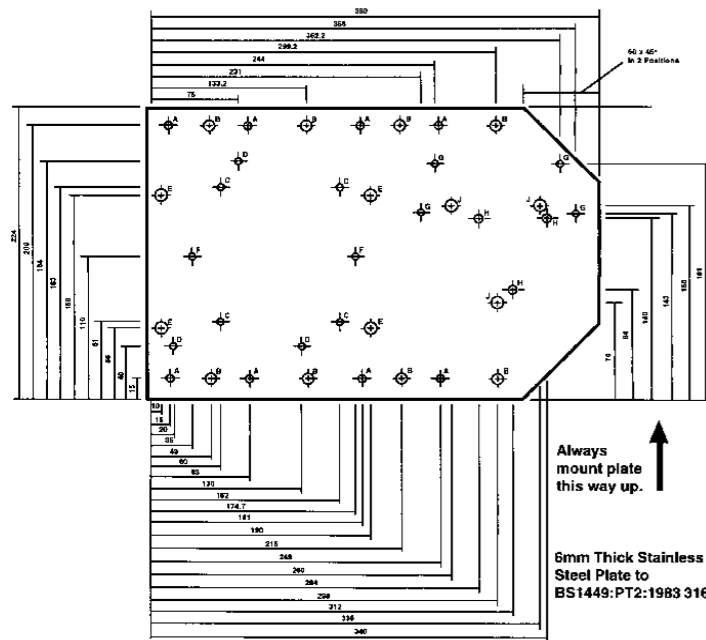

Notes: 1. Mounting plate fixing holes are clear. Searchline Excel system component mounting holes are threaded.

2. The mounting plate fixings are not supplied.

7

## INSTALLATION

Identity	Quantity	Size	Used For
A	8	Ø 7.5mm	Dual 2" pipe or pole mounting, flat surface mounting.
B	8	Ø 9.5mm	Single 6" pole, flat surface mounting, dual 2.5" ID pipe.
C	4	M6 tapped.	PL612/Bartec mounting.
D	3	M6 tapped.	DVC100 mounting.
E	4	M10 tapped	DX100 mounting.
F	2	M6 tapped	Killark/Akron mounting.
G	4	M6 tapped	Sun/heat shade mounting.
H	3	M8 tapped	Short range transmitter, all receiver brackets.
J	3	M10 tapped	Medium/Long range transmitter mounting bracket.

4. Fit an adjustment clamp to the unit's pivot block mounting stud so that it sits on the stud's shoulder with the correct orientation as shown in the diagram.

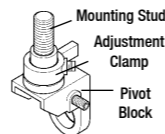

5. Tighten the adjustment clamp's grub screws until they just grip the unthreaded part of the mounting stud.

6. Fit the pivot block to the mounting bracket using a self-locking clamp nut and washer (M12 or M20) with the correct orientation as shown in the diagram. Do not fully tighten the nut.

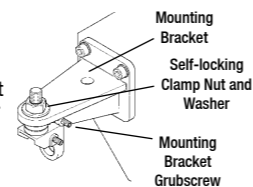

8

## INSTALLATION

Ensure that the adjustment clamp's stub lever is positioned approximately centrally between the mounting bracket's grub screws. Adjust the screws if required.

7. Fit an adjustment clamp to the unit's pivot block mounting stud so that it sits on the stud's shoulder with the correct orientation as shown in the diagram.
8. Tighten the adjustment clamp's grub screws until they just grip the unthreaded part of the unit's mounting stud.
9. Fit the unit to the pivot block using a self-locking clamp nut and washer (M12 or M20). Do not fully tighten the nut.

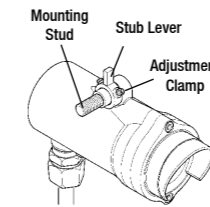

Ensure that the adjustment clamp's stub lever is approximately centrally positioned between the pivot block's grub screws. Adjust the screws if required.

10. Fit a suitable junction box, e.g. DVC100/DX100 or other suitable type of junction box, to the mounting plate

Note: For information about alternative types of junction box see Section 4.2 Electrical Installation.

11. Measure the distance (in metres) between the transmitter and receiver units.

This distance is required by the system commissioning personnel.

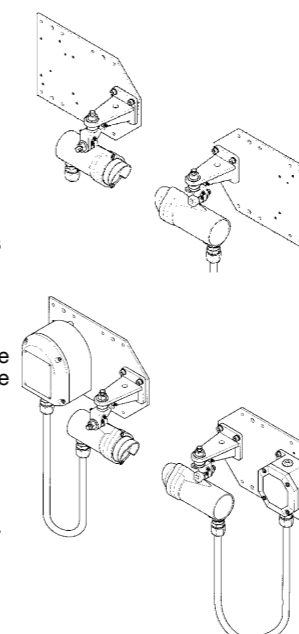

9

## INSTALLATION

### 4.3 ELECTRICAL INSTALLATION

#### 4.3.1 Electrical Connections

All ranges of Searchline Excel comply with the EMC requirements EN50081 & EN50082. In order to maintain compliance with these standards it is essential that the electrical installation of Excel is engineered correctly.

Electrical installation standards vary for different countries, companies and applications and it is the responsibility of the installation design authority to determine the applicable standards and ensure compliance with them. When designing electrical installations for Excel, Honeywell Analytics Limited recommend that the installation design authority considers the following:

1. Where possible the unit cases should not be electrically connected to electrically noisy (*dirty*) metalwork or conductors. An electrical isolation kit is available (see Technical Handbook) to provide the required electrical insulation between the units mountings and its mounting plate. The case is internally connected to the green/yellow GND wire which should preferably be connected to a low noise (*clean*) earth line. See also 5 of this section.
2. The entire length of the field cabling connected to each unit should be fully shielded with the shield connected to a low noise (*clean*) earth line.
3. The low noise (*clean*) earth line should only be connected to safety earth (usually *dirty*) at a single point. This connection should be made in such a manner that it does not introduce noise onto the low noise earth. Star earthing arrangements minimise earth current crosstalk.
4. The shields of the field cabling should not be connected such that earth loops are produced, or in a manner that will result in the shields carrying large currents from heavy plant or equipment.
5. Ideally, the field cable shield should be connected to the unit's green/yellow GND wire, providing a single, continuous earth shield. This connection **must not** be allowed to complete an earth loop.

10