

Fire Sentry SS2-AM & SS2-AML SPECIFICATIONS

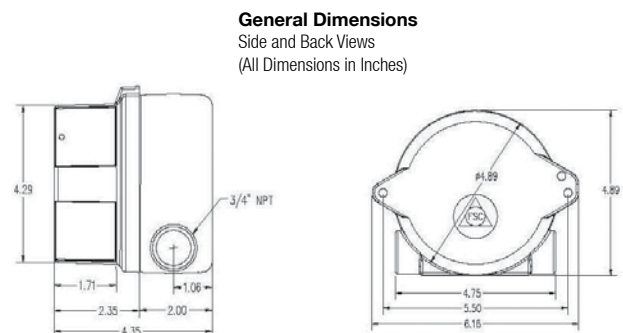

Multi-Spectrum Digital Electro-Optical Fire and Flame Detector

General Specifications	
Sensitivity	60 ft. to a 1 sq. ft. n-heptane fire
Response Time	3.9 milliseconds to explosive fire
Field-of-View	120 degrees cone of vision (60 degrees from on axis).
Spectral Sensitivity	Ultraviolet: 185 to 260 nanometers Wide Band Infrared: 0.7 to 3.5 micrometers Visible: 400 to 700 nanometers
Input Power	24 V _{DC} nominal (20.5 to 34 V _{DC})
Power Consumption	56 mA normal operation 68 mA alarm condition
Output Relays	Fire Alarm Relay: NO & NC contacts Latching / Non-Latching, factory set Normally de-energized Fault Relay: NO & NC contacts Normally energized Relay contact ratings: 0.5A at 120 V _{AC} , 1.0A at 24 V _{DC}
Operating Temperature	-40° to 185°F (-40° to 85°C)
Humidity Range	10 to 90% RH, non-condensing
Vibration	MIL.STD.810C
Weight	3.8 pounds - Aluminum 7.6 pounds - 316 Stainless Steel
Housing	Copper-free aluminum (less than 0.4%) powder coated NEMA4, NEMA4X-IP66, tamper resistant with integral dual 3/4" NPT conduit openings 316 Stainless steel housing available
Electrical Certifications	Explosion-proof Class I, Div. 1 & 2, Groups A, B, C and D Class II, Div. 1 & 2, Groups E, F and G Class III
Mounting	Swivel bracket assembly (SM4-optional); 316 Stainless Steel
Warranty	Two years from factory shipping date

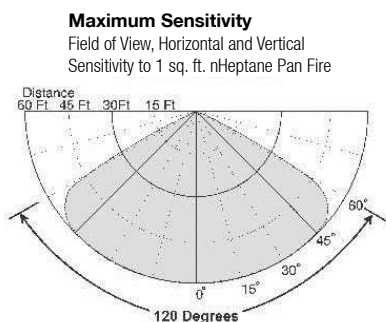

Find out more

www.honeywellanalytics.com

Toll-free: 800.538.0363

Please Note:

While every effort has been made to ensure accuracy in this publication, no responsibility can be accepted for errors or omissions. Data may change, as well as legislation, and you are strongly advised to obtain copies of the most recently issued regulations, standards, and guidelines. This publication is not intended to form the basis of a contract.