

User Manual

Honeywell BW™ Ultra

Portable Five-gas Detector
with Internal Pump

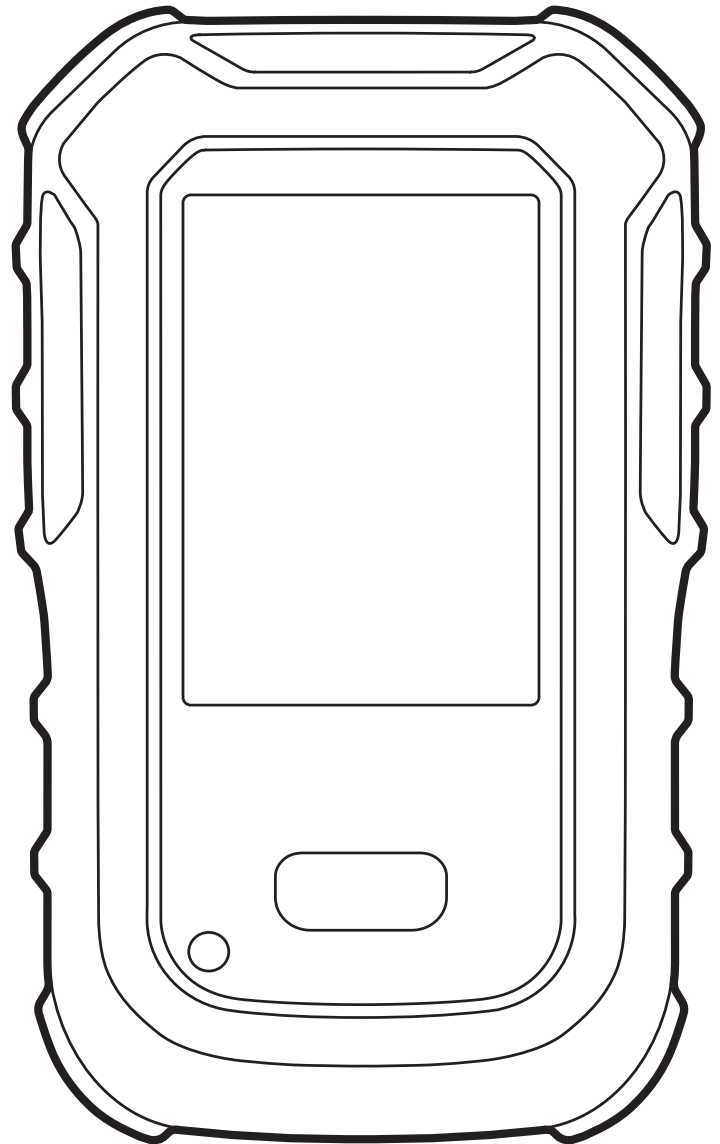

Limited Warranty and Limitation of Liability

BW Technologies by Honeywell LP (Honeywell) warrants the product to be free from defects in material and workmanship under normal use and service for a period of three years, beginning on the date of shipment to the buyer. This warranty extends only to the sale of new and unused products to the original buyer. Honeywell's warranty obligation is limited, at Honeywell's option, to refund of the purchase price, repair, or replacement of a defective product that is returned to a Honeywell authorized service center within the warranty period. In no event shall Honeywell's liability here under exceed the purchase price actually paid by the buyer for the product.

This warranty does not include:

- fuses, disposable batteries, or the routine replacement of parts due to the normal wear and tear of the product arising from use;
- any damage or defects attributable to repair of the product by any person other than an authorized dealer, or the installation of unapproved parts on the product
- any product which in Honeywell's opinion has been misused, altered, neglected, or damaged by accident or abnormal conditions of operation, handling, or use.

The obligations set forth in this warranty are conditional on:

- Proper storage, installation, calibration, use, maintenance, and compliance with the product manual instructions and any other applicable recommendations of Honeywell.
- The buyer promptly notifying Honeywell of any defect and, if required, promptly making the product available for correction. No goods shall be returned to Honeywell until receipt by the buyer of shipping instructions from Honeywell.
- The right of Honeywell to require that the buyer provides proof of purchase such as the original invoice, bill of sale, or packing slip to establish that the product is within the warranty period.

THE BUYER AGREES THAT THIS WARRANTY IS THE BUYER'S SOLE AND EXCLUSIVE REMEDY AND IS IN LIEU OF ALL OTHER WARRANTIES, EXPRESS OR IMPLIED, INCLUDING BUT NOT LIMITED TO ANY IMPLIED WARRANTY OF MERCHANTABILITY OR FITNESS FOR A PARTICULAR PURPOSE. HONEYWELL SHALL NOT BE LIABLE FOR ANY SPECIAL, INDIRECT, INCIDENTAL, OR CONSEQUENTIAL DAMAGES OR LOSSES, INCLUDING LOSS OF DATA, WHETHER ARISING FROM BREACH OF WARRANTY OR BASED ON CONTRACT, TORT, OR RELIANCE OR ANY OTHER THEORY.

Since some countries and states do not allow limitation of the term of an implied warranty, or exclusion or limitation of incidental or consequential damages, the limitations and exclusions of this warranty may not apply to every buyer. If any provision of this warranty is held invalid or unenforceable by a court of competent jurisdiction, such holding will not affect the validity or enforceability of any other provision.

Warranty Registration

www.honeywellanalytics.com/support/product-registration

Table of Contents

Before You Begin	1	Real Time Clock Display	11
About this Publication	1	Languages.....	11
Trademarks	1	Clean the Detector.....	11
Introduction.....	1	Upgrade the Firmware	11
What's in the Box	1	Service	12
Monitored Gases.....	1	Replace the Printed Circuit Board (PCB).....	12
Safety Information.....	2	Replace the LCD	14
Sensor Poisons and Contaminants.....	3	Replace the 1-Series Sensors.....	16
International Symbols.....	3	Replace the 4R+ Sensors.....	18
Getting Started	4	Replace the Pump.....	19
Appearance	4	Replace the Battery.....	20
Main Screen.....	4	Replace the Pump Inlet Filter	20
Screen Icons	4	Appendices	21
Alarms.....	5	Auto detect gas	21
Detector Operations	6	Gas Alarm Setpoints.....	21
Activate the detector.....	6	Sample Factory Alarm Setpoints.....	21
Activate the backlight.....	6	Specifications	21
Deactivate the detector	6	Standards and Certifications	22
Navigate the menu	6	Label Information.....	24
View detector's general information.....	6	BW Ultra Battery label.....	24
Reset TWA or STEL readings.....	6	BW Ultra Instrument label	24
Reset Peak readings.....	6	Part Number Format.....	25
Reset TWA/STEL and Peak readings.....	7	Troubleshooting	26
Zero sensors.....	7	Glossary	27
Acknowledge alarms and messages.....	7	Contact Honeywell	28
Latching Alarms.....	7		
Calibrate the detector	7		
Start a Bump Test.....	8		
Perform a manual bump test	8		
Set up IntelliFlash	8		
Set up Reverse IntelliFlash.....	8		
Set up the Confidence and Compliance Beep interval	8		
Select an operation mode.....	9		
Essentials mode.....	9		
Hole Watch mode.....	9		
Inert mode.....	9		
Configure the Detector.....	9		
Connect With IntelliDoX.....	9		
Connect With an IR Link.....	9		
Bluetooth Pairing	10		
Replace a Sensor	10		
Review Logs.....	10		
Maintenance	11		
Maintenance	11		
Gas Cylinder Guidelines	11		
Charge the Battery.....	11		
Maintain the Battery.....	11		

Before You Begin

About this Publication

While this information is presented in good faith and believed to be accurate, Honeywell disclaims the implied warranties of merchantability and fitness for a particular purpose and makes no express warranties except as may be stated in its written agreement with and for its customers.

In no event is Honeywell liable to anyone for any indirect, special, or consequential damages. The information and specifications in this document are subject to change without notice.

Trademarks

Brand or product names are trademarks of their respective owners. The following brand or product names are trademarks of Honeywell:

- Honeywell BW™ Ultra
- IntelliDoX
- IntelliFlash
- Reverse IntelliFlash

Introduction

The **Honeywell BW™ Ultra** gas detector warns of hazardous gas at levels above user-defined alarm setpoints.

The detector is a personal safety device. It is your responsibility to respond properly to the alarm.

This publication is intended for people who understand how to configure, maintain and use personal gas detectors, docking systems, and accessories.

What's in the Box

- Honeywell BW™ Ultra gas detector
- Battery (factory-installed)
- Charging adapter
- 3m PVC tube
- 5 Assembly-Hydrophobic filter
- 5 Pump filters
- 1 Screen protector
- Screwdriver telescope with double end
- Quick Reference Guide
- 1 Dust porous filter 7/16"
- 2 Fitting male Luer-Lock to 1/8"
- USB memory stick containing user manuals

Monitored Gases

The detector can monitor up to five gases at a time. Four gases detected by default, and one optional gas selected from the following list.

Monitored Gas	Unit of Measure
Default detected gases	
Hydrogen Sulfide (H ₂ S)	parts per million (ppm)
Carbon Monoxide (CO)	parts per million (ppm)
Oxygen (O ₂)	% volume
Combustible gases (LEL) Lower explosive limit	a) percent of lower explosive limit (%LEL) b) percent by volume methane 0-5.0% v/v
Optional gases	
IR Flammable (IR LEL)	% volume
Hydrogen (H ₂)	parts per million (ppm)
Sulfur Dioxide (SO ₂)	parts per million (ppm)
IR-Carbon Dioxide (CO ₂)	parts per million (ppm)
Ammonia (NH ₃)	parts per million (ppm)
Volatile Organic Compounds (VOC)	parts per million (ppm)
Chlorine (Cl ₂)	parts per million (ppm)
Nitrogen Dioxide (NO ₂)	parts per million (ppm)
Hydrogen Cyanide (HCN)	parts per million (ppm)
Nitric Oxide (NO)	parts per million (ppm)
CO sensor with a Hydrogen filter (CO-H)	parts per million (ppm)

Safety Information

CAUTION READ THIS FIRST

Use the detector only as specified in this manual, otherwise the protection provided by the detector may be impaired.

- Only the instrument capable of sounding the alarms and showing readings on a display should be used for immediate safety critical use. Wireless communication and infrastructure are only for informational monitoring.
- Use only Honeywell approved batteries (order number: HU-BAT (P/N: 50122982-130) with the Honeywell BW™ Ultra detector. Using any other battery can cause an explosion or fire.
- The lithium battery in this product presents a risk of fire, explosion, and chemical burn if misused. Do not open, crush, disassemble, incinerate, or heat above 212°F (100°C). Batteries exposed to heat at 266°F (130°C) for 10 minutes can cause fire and explosion. Follow the manufacturer's instruction. Batteries must only be charged in a hazardous free area.
- Deactivating the detector by removing the battery pack may cause improper operation and harm the detector.
- Use only Honeywell approved battery charger, that is certified for SELV/LVLC (isolated) with an output U_m of 6.3 V.
- If using the detector near its upper or lower operating temperature, Honeywell recommends zeroing or activating the detector in that environment.
- Charge the detector before first-time use. Honeywell recommends the detector also be charged after every workday.
- Calibrate the device on a regular schedule, depending on use and sensor exposure to poisons and contaminants. Honeywell recommends calibrating at least once every six months.
- For optimal performance, periodically zero the sensor in a normal atmosphere (20.9% v/v O_2) that is free of hazardous gas.
- The combustible sensor is factory calibrated to 50% LEL methane. If monitoring a different combustible gas in the % LEL range, calibrate the sensor using the appropriate gas.
- Only the combustible gas detection portion of this detector has been assessed for performance by CSA standard.
- Honeywell recommends that the combustible sensor is checked with a known concentration of calibration gas after any exposure to contaminants/poisons such as sulfur compounds, silicone vapors, halogenated compounds, etc.
- Honeywell recommends that the sensors be bump tested before each day's use to confirm their ability to respond to gas. Manually verify that the audible, visual, and vibrator alarms are activated. Calibrate if the readings are not within the specified limits.
- The detector is designed for use only in potentially explosive atmospheres where oxygen concentrations do not exceed 20.9% (v/v). Oxygen deficient atmospheres (<10% v/v) may suppress some sensor outputs.
- Extended exposure of the detector to certain concentrations of combustible gases and air may stress the detector element and seriously affect its performance. If an alarm occurs due to a high concentration of combustible gases, a calibration should be performed. If necessary, contact Honeywell service representative to replace the sensor.
- High concentrations of certain toxic gases, for example, H_2S , may hurt the LEL sensor. This effect, known as inhibition, is usually temporary but in extreme circumstances can impair the sensitivity of the LEL sensor after any gas exposure that causes alarm in the toxic gas sensors.

- The Honeywell BW™ Ultra is provided with an antistatic coating over the LCD window to minimize the risk of ignition due to electrostatic discharge. Periodic inspection of this coating is required to ensure no degradation, delamination, abrasions or other deformities to this surface.
- Care must be taken to avoid exposure to excessive heat, harsh chemicals or solvents, sharp edges and abrasive surfaces. Clean the exterior with a soft, damp cloth.
- Portable safety gas detectors are life safety devices. The accuracy of ambient gas reading(s) is dependent upon factors such as accuracy of the calibration gas standard used for calibration and frequency of calibration.
- When Honeywell BW™ Ultra detector is equipped with Infrared (IR) sensor, do NOT use BW Ultra at an atmospheric pressure exceeding 1.1 bar (110 kPa). The IR sensor used in the detector is intended for use at atmospheric pressure and shall not be used in pressures exceeding 1.1 bar (110 kPa).
- DO NOT rely on the Bluetooth BW Ultra output indication for security purposes.

WARNINGS

- FOR SAFETY REASONS THIS EQUIPMENT MUST BE OPERATED AND SERVICED BY QUALIFIED PERSONNEL ONLY. READ AND UNDERSTAND INSTRUCTION MANUAL COMPLETELY BEFORE OPERATING OR SERVICING.
- Substitution of components may impair Intrinsic Safety.
- Protect the combustible sensor from exposure to lead compounds, silicones, and chlorinated hydrocarbons. Although certain organic vapors (such as leaded gasoline and halogenated hydrocarbons) can temporarily inhibit sensor performance, in most cases the sensor will recover after calibration.
- The Canadian Standards Association (CSA) requires the LEL sensor to be bump tested before each day's use with calibration gas containing between 25% and 50% LEL. The instrument must be calibrated if the displayed LEL value during a bump test fails to fall between 100% and 120% of the expected value for the gas.
- High off-scale LEL readings may indicate an explosive concentration.
- Any rapid up scaling reading followed by a declining or erratic reading may indicate a gas concentration beyond the upper scale limit, which can be hazardous.
- Products may contain materials that are regulated for transportation under domestic and international dangerous goods regulations. Return product in compliance with appropriate dangerous goods regulations. Contact freight carrier for further instructions.
- Dispose of used lithium cells immediately. Do not disassemble and do not dispose of in fire. Do not mix batteries with the solid waste stream. Spent batteries should be disposed of by a qualified recycler or hazardous materials handler. Keep children away from the lithium cells.
- The pellistors used in the Catalytic flammable gas sensor can suffer from a loss of sensitivity when in the presence of poisons or inhibitors, e.g. silicones, sulphides, chlorine, lead or halogenated hydrocarbons.
- DO NOT rely on the Bluetooth BW Ultra output indication for security purposes.
- DO NOT use the screen protector in the hazardous location. The screen protector must be removed in the explosive atmospheres.
- The accessories (e.g., fitting mini quick-connector to 1/8", fitting male Luer-lock to 1/8" etc.) are not the scope of intrinsic safe certification
- Do not install or remove any components when an explosive gas atmosphere is present.

MISES EN GARDE

- POUR DES RAISONS DE SECURITE, CET EQUIPEMENT DOIT ETRE UTILISE, ENTRETENU ET REPARÉ UNIQUEMENT PAR UN PERSONNEL QUALIFIÉ. ETUDIER LE MANUEL D'INSTRUCTIONS EN ENTIER AVANT D'UTILISER, 'ENTREtenir OU DE REPARER L'EQUIPEMENT.
- Avertissement : Le remplacement d'un composant de l'appareil peut altérer sa sécurité intrinsèque.
- Pour éviter l'inflammation d'atmosphères inflammables ou combustibles, couper l'alimentation électrique avant tout entretien.
- Avertissement: Pour réduire le risque d'ignition dans les atmosphères inflammables, les piles doivent être chargées in a dans une zone sûre, exempte de gaz dangereux.
- Protégez le capteur de gaz combustibles contre toute exposition aux composés de plomb, aux silicones et aux hydrocarbures chlorés. Bien que certaines vapeurs organiques (comme l'essence au plomb ou les hydrocarbures halogénés) puissent neutraliser provisoirement les performances du capteur, dans la plupart des cas, le capteur retrouvera son fonctionnement normal après l'étalonnage.
- Attention : Des valeurs LIE hors échelle élevées peuvent indiquer la présence d'une concentration explosive.
- Toute mesure en rapide augmentation suivie d'une diminution ou d'une mesure fantaisiste peut indiquer une concentration de gaz au-delà de la limite d'échelle supérieure, risquant donc d'être dangereuse.
- Les produits peuvent contenir des matériaux qui sont réglementés pour le transport en vertu des règlements nationaux et internationaux de marchandises dangereuses. Retourner le produit conformément à la réglementation sur les marchandises dangereuses appropriées. Contactez transporteur pour plus d'instructions.
- Avertissement: La batterie au lithium peut présenter un risque d'incendie ou de brûlure chimique en cas de mauvaise utilisation. Elle ne doit jamais être démontée, incinérée ni chauffée au-delà de 100 °C.
- Avertissement: Les piles au lithium polymère exposées à une température supérieure à 130 °C pendant plus de 10 minutes peuvent provoquer un incendie et/ou une explosion.
- Mettez immédiatement au rebut les batteries au lithium usagées. Ne pas démonter et ne pas jeter au feu. Ne pas les mélanger aux autres déchets solides. Les piles usagées doivent être éliminées par un centre de recyclage agréé ou un centre de traitement des matières dangereuses. Éloignez les enfants des piles au lithium.
- Ne comptez PAS sur l'indication de sortie Bluetooth BW Ultra à des fins de sécurité.
- N'utilisez PAS le protecteur d'écran dans un endroit dangereux. Le protecteur d'écran doit être retiré dans les atmosphères explosives

Sensor Poisons and Contaminants

Many chemicals can contaminate and permanently damage sensors. Follow these guidelines when using cleaners, solvents, or lubricants near the detector:

- Use water-based (not alcohol-based) cleaners
- Clean the exterior only with a soft, damp, cloth

These products can damage the sensors. Do not use them around the detector:

- Soaps
- Solvents
- Alcohol-based cleaners
- Brake cleaners
- Dishsoaps
- Insect repellents
- Methanol (fuel or antifreeze)
- Polishes
- Window and glass cleaners
- Silicone-based cleaners or protectants
- Tissues containing silicone
- Aerosols
- Anionic detergents
- Citrus-based cleaners
- Hand sanitizers
- Lubricants
- Mold release agents
- Rust inhibitors
- Silicone-based adhesives, sealants, or gels
- Hand/body/medicinal creams containing silicone

International Symbols

Symbol	Meaning
	Approved to both United States and Canada standards by UL LLC.
	International Electrotechnical Commission Scheme for Certification to Standards for Electrical Equipment for Explosive Atmospheres
	Natural Institute of Metrology, Quality, and Technology. Conforms to Brazilian INMETRO Certification.
	Conforms to European ATEX Directives

Getting Started

Appearance



1. Visual alarm indicator
2. Exhaust port
3. Screen
4. Button
5. Beeper Aperture
6. Pump inlet
7. Alligator clip
8. Pump assembly
9. Charging connector and IR Interface

Main Screen

The start-up main screen is displayed as follows:

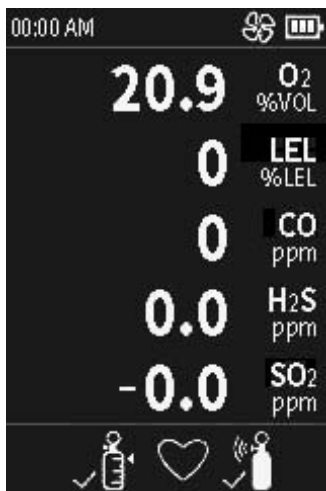

Screen Icons

The detector's screen, shown here with typical icons, will display those shown in the following table as conditions dictate.

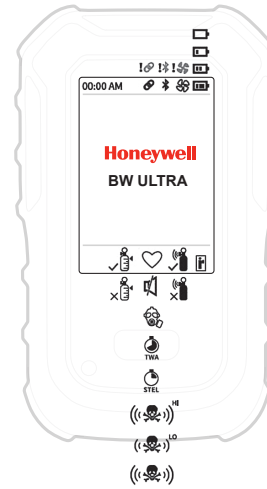

Screen Icons	
* BLE	☪ Pump/header
✖ BLE Pairing Error	✓☪ Pump passed
☑ Paired	☪☪ Pump critical fail
✖ Pairing failed	⚠ Warning/failure/error/low battery
🔇 Stealth mode	👆 Press button
🔋 Battery -three levels	👆 Press & hold button
🔋 Low battery	📏 HI Hole watch mode high
📏 IR LINK connection	📏 LO Hole watch mode low
👤 Calibration passed	📏 HI LO Hole watch -Oxygen bar
✖👤 Calibration failed	📏 Target gas
☪👤 Calibration cancelled	👤 Inert mode
☪👤 Bump test cancelled	✖ Sensor failure
👤 Bump test passed	📏 STEL STEL alarm
✖👤 Bump test failed	📏 TWA TWA alarm
👤 Correction factor	👤 Peak gas exposure
☪☪ Over limit alarm	🕒 Firmware update in progress
☪☪ ^{HI} High alarm	🚫 Sensor disabled
☪☪ ^{LO} Low alarm	📏 Heartbeat

Alarms

When the detector goes into alarm, it flashes, vibrates, and produces a loud siren noise. Depending on the type of alarm, these flashes, vibrations, and noises will be different.

NOTE: In Stealth mode the Honeywell BW™ Ultra only vibrates.

IMPORTANT: Regardless, when a detector goes into alarm, always take appropriate action. Never ignore or dismiss an alarm.

Refer to this information about the different alarm types and their corresponding screens.

Alarm Type	Description	Screen
Low Alarm	Slow siren (upward tone)	
	Slow flash	
	Black box around gas flashes	
	Vibrator alarm activates	
High Alarm	Fast siren (downward tone)	
	Fast flash	
	Black box around gas flashes	
	Vibrator alarm flashes	
Time Weighted Average (TWA) Alarm	Fast siren (downward tone)	
	Fast flash	
	Black box around gas flashes	
	Vibrator alarm activates	
Short Term Exposure Limit (STEL) Alarm	Fast siren (downward tone)	
	Fast flash	
	Black box around gas flashes	
	Vibrator alarm activates	
Multi Alarm	Alternating low and high alarm	
	Black box around gas flashes	
	Type of alarm alternates	
	Vibrator alarm alternates	
Sensor Failure Alarm	X is displayed	

Alarm Type	Description	Screen
Over Limit (OL) Alarm	Fast siren (downward tone)	
	Fast flash	
	Black box around gas flashes	
	Vibrator alarm activates	
Normal Deactivation	Sequence of alternating beeps and alternating flashes	
	Vibrator alarm activates	
	Countdown initiates	
	"OFF" is displayed	
Low Battery Alarm	Sequence of 10 rapid sirens and alternating flashes followed by 7 seconds of silence (continues for 15 minutes)	
	flashes	
	Vibrator alarm pulses	
	After 15 minutes of the low battery alarm sequence, the detector will enter critical alarm	
Critical Battery Alarm	Fifteen minutes after low battery alarm activates, sequence of 10 rapid sirens and alternating flashes with 1 second of silence in between (sequence reactivates seven times)	
	Vibrator alarm pulses	
	"Low Battery Powering Off" is displayed and the detector deactivates	
Pump Alarm	Detector is in pump alarm when gas is turned off during calibration.	

Detector Operations

Activate the detector

Turn-on the detector in a safe area with an atmosphere of 20.9% oxygen and free of hazardous gas.

1. For first time use, charge the battery for up to 8 hours or until LED light turns green using the charging adapter provided. Refer to Charge the battery for more information.
2. Press and hold the button for three seconds.
3. For first time use, a **Warming sensors** message is displayed and a 30 minutes countdown is displayed. In most cases, this countdown only lasts a couple of minutes.
4. When the detector displays **Pump test Block inlet**, block the pump inlet with a finger, and then after a couple of seconds unblock the pump inlet. The detector performs a quick pump test. A **Pump Test passed** message is displayed. If you do not block the pump inlet, the detector will turn off after two minutes. The detector will then perform a self-test, including testing the sensors. This process could take several minutes. If necessary, you will be instructed by screen prompts to calibrate newly-installed sensors.
5. When the self-test is complete, press and hold the button to zero sensors. After the autozero is complete, the detector then checks the sensors for calibration and bump test. If the detector identifies sensors requiring calibration or bump testing, press the button and follow the on-screen instructions.

Activate the backlight

To activate the backlight on the screen, press the button.

Deactivate the detector

1. Press and hold the button during the powering-off countdown.
2. Release the button when **OFF** is displayed.

Navigate the menu

There are four main menu items.

- **See Information**
- **Start Bump Test**
- **Zero Sensors**
- **Start Calibration**

1. Double pressing the button displays all four options on the screen. **See Information** is selected and highlighted by default.
2. Press the button to transition the selection to the next choice.
3. Press and hold for three seconds to enter the selected option.
4. Follow on-screen instructions for your selected operation. Most of the detector's procedures are described in this guide.

View detector's general information

1. Double-press the button to enter the main menu.
2. Select **See information** and press the button to scroll through the following information:
 - Peak readings
 - STEL readings
 - TWA readings
 - Bump test intervals
 - Calibration
 - BLE information (BLE should be enabled)
 - LEL Correction Factor
 - Low Alam setpoint
 - Hi Alam setpoints
 - STEL setpoints
 - TWA setpoints

Reset TWA or STEL readings

Before you begin.

You need to enable **TWA/STEL Reset** in Fleet Manager II to reset readings in the detector.

1. Go to the main menu and select > **See Information** > **TWA readings** or **STEL readings**.
2. Press and hold for 3 seconds to reset readings. A reset message is displayed.

Reset Peak readings

Before you begin.

You need to enable **Peak Reset** in Fleet Manager II to reset readings in the detector.

1. Go to the main menu and select > **See Information** > **Peak readings**.
2. Select **Hold** to reset peak readings. Press and hold for 3 seconds to reset readings.

Reset TWA/STEL and

Peak readings

Before you begin.

You need to enable **TWA/STEL Reset** and **Peak Reset** in Fleet Manager II to reset readings in the detector.

1. Go to the main menu and select > **See Information** > **Peak readings**.
2. Select **Hold** to reset all readings. Press and hold for 3 seconds to reset readings.

Zero sensors

Before you begin.

Connect the Nitrogen if this is a CO2 unit.

1. Go to the main menu and select **Zero Sensors**.
2. Press and hold for 3 seconds.
A Zeroing process starts automatically.
The screen displays all current gas measurements, highlighting entries above zero.
Ambient air is applied to zero all sensors that are not CO2.
The screen displays all current gas measurements, highlighting entries being reset to zero.
3. If you are not zeroing O2, Click **NO** in the prompted message: **Is this a CO2 unit?**
Zero results are displayed.
Press the button or wait for six seconds to end the Zeroing process.
4. Click **Yes** if this is a CO2 unit and you want to apply Nitrogen to zero CO2.
A two minutes gas measure process starts automatically.
All current gas measurements and entries reset to zero are displayed.
5. Turn off the gas following on-screen instructions.
Zero results are displayed.
6. Press the button or wait for six seconds to end the Zeroing process.

Zero results are displayed as follows:

- A check mark for sensors that passed Zero
- A cross mark for sensors that failed Zero
- An exclamation mark for sensors that skipped Zero

Acknowledge alarms and messages

Press and release the button to perform any of the following:

- To acknowledge a latching alarm
- To acknowledge a low alarm
- To acknowledge due today message (for example, calibration and bump test reminders). Note that the force calibration and force bump test features cannot be bypassed.

Latching Alarms

If enabled, during an alarm condition the Latching Alarms option causes the low and high gas alarms (audible, visual, and vibrator) to persist until the alarm is acknowledged and the gas concentration is below the low alarm setpoint. The LCD displays the peak concentration until the alarm no longer exists. Local regulations in your region may require the Latching Alarms option be enabled.

The detector is shipped with the Latching Alarms option disabled.

Calibrate the detector

Perform a calibration to adjust the sensitivity levels of sensors and ensure accurate responses to gases.

The detector can be calibrated in two ways:

- Apply gas from a cylinder to the sensors manually through the pump inlet.
- Use an IntelliDoX module.

Before you begin. Move to a normal atmosphere (20.9% v/v O₂) that is free of hazardous gas.

1. Go to the main menu and select > **Start Calibration**.
2. Press and hold the button for three seconds to display the **Powering Off** countdown and continue to hold for the **Starting Calibration** countdown.
The detector will enter the zero function. The Zeroing process starts automatically and lasts for five minutes.
Current gas measurements are displayed, and entries above zero are highlighted.
3. Connect the calibration hose to the pump inlet. Make sure to use a demand flow regulator.
4. Confirm that you want to apply Nitrogen to zero CO2.
5. When **Apply calibration gas now** is displayed, apply the gas and wait for a maximum of five minutes.
The detector first tests for a specific type of gas. When it detects enough of that gas for sensor calibration, a check box will be displayed next to that gas. Calibration then begins. Gas values will adjust on the screen during the calibration.
6. When **Turn gas off** is displayed, disconnect the device from gas. Check marks will be displayed next to the calibrated sensors. These sensors reset to the number of days until the next calibration is due (for example, 180 days).
The calibration cycle will take about two minutes after which the user will be prompted to **Press button to continue**.
7. If the calibration was successful, **Calibration Passed** will be displayed. Press the button to exit calibration.
If the calibration failed for some or all of the gases, either a **Cal Error All gases applied mixed results** message (if the detector was not successfully

calibrated for all gases) or a **Fail all gases** message will be displayed. After the button is pressed, a **Cal overdue** message will be displayed.

Start a Bump Test

Perform a bump test regularly to test sensors and alarms. To bump test, expose the sensors to a gas concentration that exceeds alarm setpoints and confirm that the sensors and alarms work correctly.

The detector can be bump tested in two ways:

- Apply gas from a cylinder to the sensors manually through the pump inlet.
- Use an IntelliDoX module.

Perform a manual bump test

Before you begin.

Connect the calibration hose to a demand flow regulator on the gas cylinder.

1. Double-press the button and select > **Start Bump test**.
2. Press and Hold the button for three seconds.
The detector displays **Starting Bump test**. **Bump test started** is displayed, and then the detector makes noise, flash, and vibrate.
3. The detector will prompt you **Did you see and hear the alarms?**, select **Pass**, and Press and hold for three seconds to confirm that the visual, audible, and vibrator alarms work correctly.
An **Audio-Visual test passed** message is displayed.
Skip to Step 5.
4. If the visual, audible, and vibrator alarms failed, select **Fail**, and press and hold the button. An **Audio-Visual test failed** message is displayed.

Then you can:

- a) Apply gas, Skip to Step 5
 - b) Press the button to skip gas application and follow on-screen instructions to end the Bump Test. Bump test results are displayed, and the test ends.
5. If you want to apply gas, follow on-screen instructions. Wait for about 30 seconds; gas measurements are displayed for each pertinent gas sensor.
A **Bump Test pass** confirmation is displayed.
 6. After the **Turn gas off** message is displayed, remove the hose from the pump inlet. The detector will remain in alarm until the gas clears from the sensors. Bump test results are displayed showing check marks next to the tested sensors. These sensors reset to the number of days until the next Bump Test is due.
 7. Press the button to finish the procedure.

CAUTION

Honeywell recommends to bump test the sensors before each day's use to confirm their ability to respond to gas by exposing the sensors to a gas concentration that exceeds the alarm setpoints.

Set up IntelliFlash

The IntelliFlash® feature causes the detector, if it is in compliance (for example, bump tested and calibrated), to flash a green light every second (the factory setting default) from the top visual alarm indicator. In Fleet Manager II, use the **IntelliFlash Interval** option to change how often the detector flashes.

Set up Reverse IntelliFlash

IntelliFlash flashes a green light when the detector is in compliance, but *Reverse IntelliFlash*® flashes an amber light when the detector is **not** in compliance (a bump test or calibration is overdue, or a sensor is not working and has been overridden).

Use Fleet Manager II to change how often the detector flashes for Reverse IntelliFlash.

IntelliFlash and Reverse IntelliFlash can be configured in one of four scenarios:

Scenario 1

When both IntelliFlash and Reverse IntelliFlash are enabled, the detector's green LED will flash until it goes out of compliance, then its amber LED will flash instead.

Scenario 2

If IntelliFlash is enabled and Reverse IntelliFlash is disabled, the detector's green LED flashes until it goes out of compliance, then it stops flashing.

Scenario 3

If IntelliFlash is disabled and Reverse IntelliFlash is enabled, neither LED will flash while the detector is in compliance. The amber LED will flash if it goes out of compliance.

Scenario 4

When both IntelliFlash and Reverse IntelliFlash are disabled, neither LED will flash under any circumstances.

Set up the Confidence and Compliance Beep interval

The Confidence Compliance Beep is a sound that tells the user the detector is in compliance (for example, bump tested and calibrated). In Fleet Manager II use the **Confidence/Compliance Beep** option to change how often the detector beeps for Confidence Compliance Beep.

Select an operation mode

The detector can be used in one of three modes: Essentials mode, Hole Watch mode, and Inert mode.

Note: Honeywell BW™ Ultra always monitors gas levels, regardless of the operating mode. If the detector detects a sudden gas exposure, it will flash, vibrate, and produce a loud siren noise. A gas level alarm takes precedence over all of the detector's other functions.

Essentials mode

The detector only shows the gas readings.

Hole Watch mode

The Hole Watch mode is the default operating mode. It is used for confined space monitoring. Use Hole Watch mode to monitor all gas levels in the same screen view. Hole Watch mode uses bar graphs that fill when the detector detects rising gas concentrations.

- When the detector detects normal gas levels, Hole Watch mode displays empty bar graphs.
- When the detector detects non-critical gas levels, Hole Watch mode displays filling bar graphs.
- When the detector activates a single gas alarm, Hole Watch mode highlights the detected gas level for that gas in a solid bar.
- When the detector activates a multiple gas alarm, Hole Watch mode continues to display the first detected gas level, as well as highlight other detected gas levels in a solid bar.
- For oxygen, Hole Watch mode displays low and high levels in a bar graph. As the detector detects a low oxygen level, the bar graph fills toward LO.
- As the detector detects a high oxygen level, the bar graph fills toward HI.

Inert mode

You can configure Inert Mode in Fleet Manager II. The threshold for operation is 10%. If oxygen readings fall below 10%, the detector prompts the user to enter the Inert mode. The detector does not start automatically in Inert Mode.

When the detector goes into Inert Mode, the alarms setpoint get activated. If the detector does not enter in Inert mode, The O2 readings are considered normal.

Configure the Detector

You can configure the Honeywell BW™ Ultra detector's device and sensor using Fleet Manager II.

Necessary to configure detector settings:

- Honeywell BW™ Ultra detector
- IR Link adapter or IntelliDoX docking station
- Computer with Fleet Manager II software installed.

For device settings, a startup message can be added; Confidence Compliance Beep can be activated, bump tests can be forced, stealth mode can be enabled, etc.

For sensor settings, the calibration gas type and frequency can be changed, the bump test interval and alarm setpoints can be set, STEL and TWA can be selected, etc.

You can perform some other calibrations with Fleet Manager II.

Note: When the operator configures the Honeywell BW™ Ultra using FleetManager II, Honeywell strongly recommends reviewing the detector's settings before the operation to ensure that settings were applied successfully and comply with performance requirements.

Custom configuration created in Fleet Manager II can be used to configure detector settings.

Example: Five detectors must have the same bump test reminders and alarm setpoints. Each detector could be configured separately or Fleet Manager II can be utilized to create a custom settings configuration. This configuration can then be loaded on each detector. This saves time and allows settings to be managed from one location.

Connect With IntelliDoX

If a detector's calibration is overdue and the forced calibration feature is enabled, the calibration can be performed with an IntelliDoX docking station or through the calibration option from the detector's main menu.

Connect With an IR Link

The detector can be paired with an IR link, aka dongle. There is an IR connection at the bottom of the detector that allows FleetManager II configurations to be efficiently transferred to multiple detectors. The IR link will also allow new firmware to be transferred to detectors or data/event logs to be transferred to FleetManager II.

Note: You should have the IR Connectivity Kit (sold separately) to transfer the data from a computer to the detector.

Bluetooth Pairing

The user can pair the Honeywell BW™ Ultra to a mobile device via built in Bluetooth Low Energy (BLE). The Honeywell Safety Communicator app, installed on the mobile phone, can then show gas readings and alarms from the Honeywell BW™ Ultra unit that is connected. Readings and alarms can then be sent to Honeywell's remote monitoring software.

1. On the mobile device, turn on the Bluetooth connection and look for available detectors.
On the Honeywell BW™ Ultra, the Bluetooth connection is on by default.
2. On the mobile device, select the detector and then enter 100000.

Note: Pairing is not allowed at start up, during calibration, or bump test.

Warning: Wireless communication and infrastructure should be used as informational monitoring only.

Replace a Sensor

Use only sensors designed by Honeywell for the Honeywell BW™ Ultra detectors. Replace the sensors in a non-hazardous location.

The Honeywell BW™ Ultra detector can be configured for a maximum of 5 gases and may contain dummy sensors.

Review Logs

Many of the detector events are logged and can be reviewed via IntelliDoX or BLE. Typical logged events would be:

- bump test failed
- last calibration failed
- calibration forced
- calibration error
- sensors in alarm
- sensors zeroed
- "Turn cal gas off..." message is displayed
- self-test failed
- calibration overdue
- calibration canceled
- calibration passed
- system reset
- event logs vs. data logs

Maintenance

Maintenance

Perform the following tasks to maintain the detector in good operating condition:

- Calibrate, bump test, and inspect the detector on a regular schedule.
- Maintain an operations log of all maintenance, bump tests, calibrations, and alarm events.
- Keep the exterior of the detector clean.

Gas Cylinder Guidelines

- Use a premium-grade calibration gas that is approved by the National Institute of Standards and Technology.
- Verify the expiration date on the cylinder before use.
- Do not use an expired gas cylinder.
- Contact Honeywell if a certified calibration of the detector is required.

Charge the Battery

You can charge the battery using the provided charging adapter, that is certified for SELV/LVLC (isolated) with an output U_m of 6.3 V.

It can take up to 8 hours to get the battery fully charged in a temperature range from 5 °C to 35 °C.

Note: If you charge with the power on, charging may not be completed within 8 hours.

Maintain the Battery

Lithium-ion batteries do not respond well to cycles of full discharge followed by a full charging cycle. Recharge the battery before it is exhausted.

Do not charge the battery at low or elevated temperatures. 30°C (86°F) is considered an elevated temperature and should be avoided whenever possible.

A rechargeable battery's runtime decreases approximately 20% over a two-year period of typical use.

Real Time Clock Display

The real time clock is displayed in the upper left corner of the detector's screen. It is configurable through FleetManager II in 12- or 24-hour formats.

The date display can also be configured in several formats through FleetManager II.

The time/date information is retained even when the detector's battery is being changed.

Languages

Honeywell BW™ Ultra supports eight languages: English, French, German, Portuguese, Spanish, Simplified Chinese, Russian, Italian, Dutch, Slovak, Czech, Polish, Norwegian, Danish, Swedish, Finnish, Turkish, and Arabic.

These are configurable through FleetManager II.

Custom startup text can be entered in all languages except Simplified Chinese through FleetManager II.

Clean the Detector

Clean the exterior of the detector with a soft, damp cloth. Use only water-based (non-alcohol) cleaners. Do not use soaps, solvents, or polishes.

Upgrade the Firmware

Upgrade the Firmware via IR Link using the Fleet Manager II Software.

Before you begin.

- You should have the IR Connectivity Kit (sold separately) to transfer the data from a computer to the detector.
 - Download and save the firmware update file to a PC or network drive. Do not rename the file.
 - Download the BWFleetManager2.exe file and install Fleet Manager II.
 - For more information refer to the Fleet Manager II User Manual.
1. Turn on the detector.
 2. Start Fleet Manager II application.
 - a) Expand **Administration** from the left pane.
 - b) Click **Login/Logout**.
 - c) Type in the default password: **Admin**.
 - d) Click **OK** to continue.
 3. In the left pane select **Devices > Configure device via IR link**.

In the Device Selection window:

 - a) Select **Honeywell BW™ Ultra**.
 - b) Click **OK**.
 4. In the Honeywell BW™ Ultra configuration window, click **Bootloader** to select the binary file.

In the Honeywell BW™ Ultra Bootloader window, click **Choose File**.
 5. In the Choose Firmware File to Upload window, select the downloaded file, and then click **Open**.
 6. Connect the Honeywell BW™ Ultra detector to the computer using the IR Link connector.
 7. Click **Send** to initiate the file transfer to the gas detector. After the file transfer is complete, the Bootload process will start. During Bootload, the display will go blank and the detector will beep several times.
 8. The **Programming Succeeded** message is displayed. Press the button to finish the procedure, and then disconnect the detector from the computer.

Service

Replace the Printed Circuit Board (PCB)

1. Turn the instrument off.
2. Remove the front shell:
 - a) Turn the instrument face down and unscrew on the battery pack.



- b) Remove the battery pack and the four screws in the battery compartment.



- c) Remove the two screws at the top of the instrument and pull the back shell apart from the front shell.



- d) Remove the two screws holding the PCBA in place.



- e) Remove the PCB assembly from the front shell.



3. Remove the LCD:
 - a) Disengage the two snaps on the upper sides of the LCD carrier.

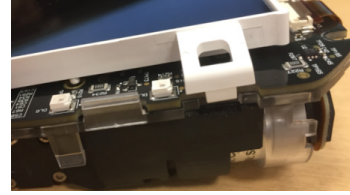

- b) Swing LCD forward watching for the ZIF connector.

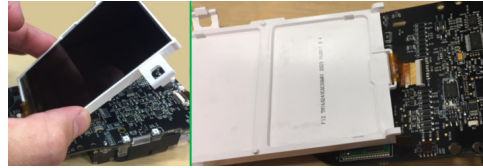

- c) Lift the latch on the ZIF connector, and then pull the LCD cable forward and remove LCD assembly.

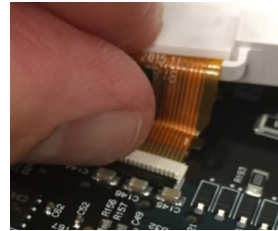

4. Disengage the two snaps holding the manifold carrier in place and carefully pull up the manifold carrier off the PCB.



5. Lift the latch on the 4R+ ZIF connector and pull out the 4R+ cable assembly to disconnect the pump connector from the PCB.

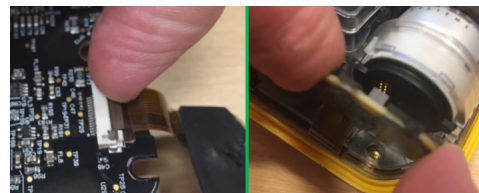

6. Retrieve the new PCB.
7. Connect the pump to the PCB.
8. Align the snaps on the manifold carrier and push down to engage the snaps to the PCB.



9. Insert the 4R+ ribbon cable into the ZIF connector and press down on the 4R+ ZIF latch to engage the cable.

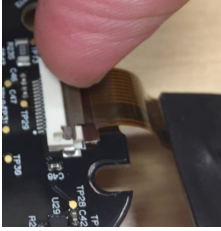

10. Re-connect the 4R+ sensor cable.



11. Attach the LCD:

- a) Insert the LCD ribbon cable into the ZIF connector and press down on the ZIF connector latch to engage the cable.

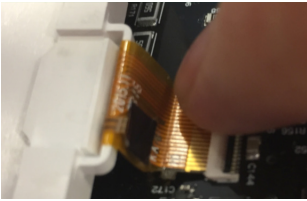

- b) Lever the LCD assembly back toward the PCB, then press down until the side snaps are engaged.

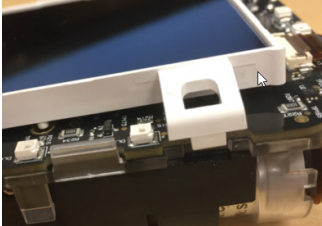

12. Attach the shells:

- a) On the front shell, ensure the LCD gasket is aligned with the pins. The frame should be facing up.



- b) Place the PCB into the front shell and insert the two screws (torque 3-4 in-lbs) to fasten both pieces.



- c) Replace the back shell and install the four screws back into the battery compartment (torque 4-5 in-lbs).

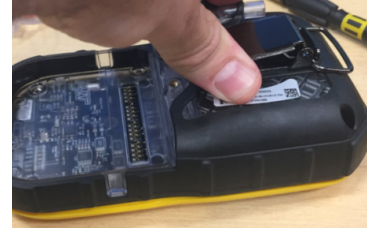

- d) Reinstall the two screws at the top of the instrument (torque 4-5 in-lbs).



13. Place the battery pack:

- a) Engage hooks on the bottom of the battery pack.



- b) Push the battery pack into place.

- c) Tighten the battery retention screw (torque 4-5 in-lbs).



14. Turn on the instrument and allow for the sensors to stabilize.

Calibrate sensors.

Replace the LCD

1. Turn the instrument off.
2. Remove the battery:
 - a) Turn the instrument face down and unscrew on the battery pack.



- b) Remove the battery pack and the four screws in the battery compartment.



3. Remove the front shell:
 - a) Remove the two screws at the top of the instrument and pull the back shell apart from the front shell.



- b) Remove the two screws holding the PCB in place.



- c) Remove the PCB assembly from the front shell.



4. Remove the LCD:
 - a) Disengage the two snaps on the upper sides of the LCD carrier.

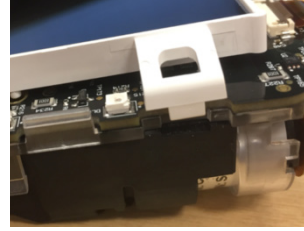

- b) Swing LCD forward watching for the ZIF connector.

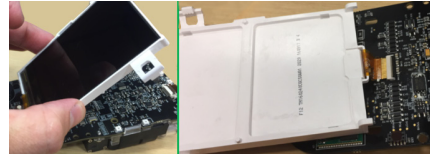

- c) Lift the latch on the ZIF connector, pull the LCD cable forward and remove LCD assembly to remove the LCD assembly.

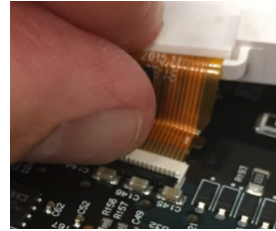

- d) Pull the LCD cable forward and remove the LCD assembly.

5. Retrieve the new LCD.

6. Attach the LCD:

- a) Insert the LCD ribbon cable into the ZIF connector and press down on the ZIF connector latch to engage the cable.

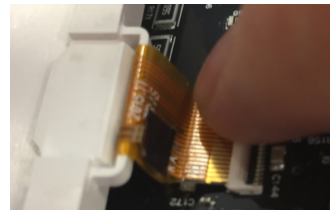

- b) Lever the LCD assembly back towards the PCB, then press down until the side snaps are engaged.

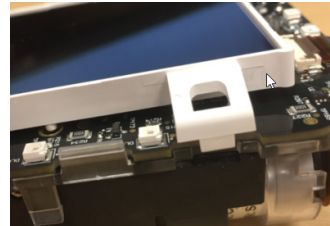

c) On the front shell, ensure the LCD gasket is aligned with the pins. The frame should be facing up.



b) Push the battery pack into place and tighten the battery retention screw (torque 4-5 in-lbs).



7. Attach the front shell:

a) Place the PCB into the front shell and insert the two screws (torque 3-4 in-lbs) to fasten both pieces.



b) Replace the back shell and install the four screws back into the battery compartment (torque 4-5 in-lbs).

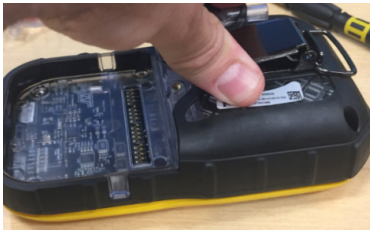

c) Reinstall the 2 screws at the top of the instrument (torque 4-5 in-lbs).



8. Attach the battery:

a) To place the battery pack correctly, first engage hooks on the bottom of the battery pack.



Replace the 1-Series Sensors

1. Turn the instrument off.
2. Remove the battery:
 - a) Turn the instrument face down and unscrew on the battery pack.



- b) Remove the battery pack and the four screws in the battery compartment.



3. Remove the sensor:
 - a) Remove the two screws at the top of the instrument and pull the back shell apart from the front shell.



- b) Pull back the two retaining clips on the manifold.



- c) Lift the manifold sideways, farthest from the pump.



- d) Pull the sensor manifold out from the pump manifold.

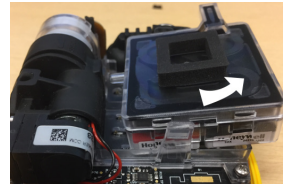

- e) Remove the desired sensor.



4. Install the new sensor:
 - a) Mind the orientation key, and then push the sensor down into manifold.



- b) Insert manifold inlet into pump manifold.

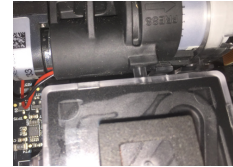

- c) Push manifold down and as the two latches engage, listen for two snapping sounds.

5. Replace the back shell and install the four screws back into the battery compartment (torque 4-5 in-lbs).



6. Reinstall the 2 screws at the top of the instrument (torque 4-5 in-lbs).



7. Attach the battery:
 - a) To place the battery pack correctly, first engage hooks on the bottom of the battery pack.



- b) Push the battery pack into place and tighten the battery retention screw (torque 4-5 in-lbs).
8. Turn on the instrument and allow for the sensors to stabilize.

Replace the 4R+ Sensors

1. Turn the instrument off.
2. Remove the battery:
 - a) Turn the instrument face down and unscrew on the battery pack.



- b) Remove the battery pack and the 4 screws in the battery compartment.



3. Remove the sensor:
 - a) Remove the two screws at the top of the instrument and pull the back shell apart from the front shell.



- b) Disconnect the 4R+ cable from the sensor.



- c) Push at the PRESS marking in the manifold toward the top of the instrument.



- d) Use the tabs on the sensor to pull it out of the manifold.



4. Install the new sensor:
 - a) Retrieve the new sensor and insert it into the manifold aligning the sensor guides to the instrument's slots.

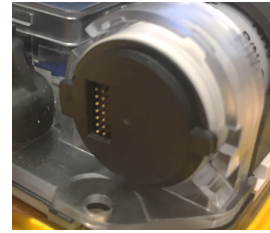

- b) Push sensor forward until it stops moving.
 - c) Re-connect the 4R+ sensor cable.



5. Replace the back shell and install the four screws back into the battery compartment (torque 4-5 in-lbs).

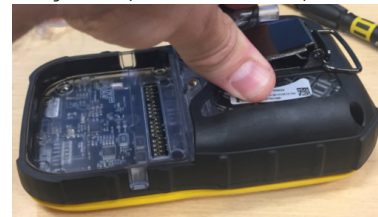

Reinstall the two screws at the top of the instrument (torque 4-5 in-lbs).



6. To place the battery pack correctly, first engage hooks on the bottom of the battery pack.



7. Push the battery pack into place and tighten the battery retention screw (torque 4-5 in-lbs).
8. Turn on the instrument and allow for the sensors to stabilize.
9. Calibrate new sensor.

Replace the Pump

1. Turn the instrument off.
2. Remove the battery:
 - a) Turn the instrument face down and unscrew on the battery pack.



- b) Remove the battery pack and the four screws in the battery compartment.



3. Remove the two screws at the top of the instrument and pull the back shell apart from the front shell.



4. Remove the pump:
 - a) Pull the pump out of the manifold assembly.



- b) Release the pump connector retainer clip and pull the pump connector out.



5. Install the new pump:
 - a) Retrieve the new pump and insert the pump connector.



- b) Fold the pump wires across the bottom of the pump motor.

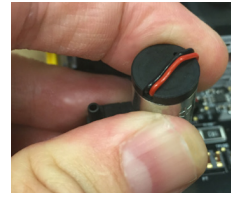

- c) Insert the pump into the manifold assembly.



6. Replace the back shell and install the 4 screws back into the battery compartment (torque 4-5 in-lbs).

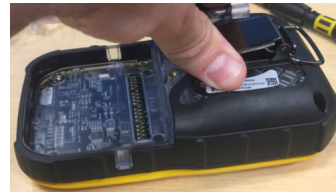

7. Reinstall the two screws at the top of the instrument (torque 4-5 in-lbs).



8. To place the battery pack correctly, first engage hooks on the bottom of the battery pack.



9. Push the battery pack into place and tighten the battery retention screw (torque 4-5 in-lbs).

Replace the Battery

1. Turn the instrument off.
2. Turn the instrument face down and unscrew on the battery pack.



3. Remove the battery pack.



4. To place the new battery pack correctly, first engage hooks on the bottom of the battery pack.
5. Push the battery pack into place and tighten the battery retention screw (torque 4-5 in-lbs).



Note: Use only the HU-BAT Honeywell battery pack.

Replace the Pump Inlet Filter

1. Turn the instrument off.
2. Unthread the screw on the pump inlet cover.



3. Rotate the cover counter-clockwise.



4. Remove the cover.



5. Remove both the particulate and hydrophobic filter.



6. First, Install both the hydrophobic and then the particulate filters.
7. Place the filter cover and rotate the filter cover clockwise until stop.



8. Tighten the screw (torque to 3-4 in-lbs).

Appendices

Auto detect gas

While the gas is applied during calibration, the detector will wait for up to 300 seconds to allow the gas to stabilize. If the gas has not stabilized by then, the detector will display a **Gas unstable** message. If the gas stabilizes within 300 seconds, it will be automatically detected and will not have to be selected from a menu. The name of the gas and a **Span calibration in progress** message will be displayed. If a quad gas mixture was used, the detector will display the names of all four gases.

Gas Alarm Setpoints

Gas alarms are activated when detected gas concentrations are above or below the user-defined setpoints. The gas alarms are described as follows.

Alarm	Condition
Low	Toxics and combustibles: Ambient gas level above low alarm setpoint. Oxygen: Ambient gas level may be set above or below 20.9% (or 20.8%).
High	Toxics and combustibles: Ambient gas level above high alarm setpoint. Oxygen: Ambient gas level may be set above or below 20.9% (or 20.8%).
TWA	Toxics only: Accumulated value above the TWA alarm setpoint.
STEL	Toxics only: Accumulated value above the STEL alarm setpoint.
Multi-gas	Two or more gas alarm conditions simultaneously.
Over Limit (OL)	OL or -OL displays when readings are above or below the sensor detection range, respectively.

Sample Factory Alarm Setpoints

Following table lists alarm setpoints as defined by the US Occupational Safety and Health Association (OSHA).

Gas	TWA	STEL	Low	High
H2S	10 ppm	15 ppm	10 ppm	15 ppm
CO	35 ppm	50 ppm	35 ppm	200 ppm
O2	N/A	N/A	19.5% vol.	23.5% vol.
LEL	N/A	N/A	10% LEL	20% LEL

Note: To disable an alarm, set the alarm setpoint to 0 (zero) in Fleet Manager II.

Specifications

Detector dimensions: 8.1 x 14.6 x 5.1cm

Weight: 444.2 g

Operating temperatures: -4°F to +122°F (-20°C to +50°C)

Battery operating times: 10 hours.

Rechargeable battery: 8 hours in a temperature range from 5 °C to 35 °C.

Storage temperature: -40°F to +122°F (-40°C to +50°C)

Operating humidity: 0% to 95% relative humidity (non-condensing)

Detection range:

H2S: 0 – 100 ppm (1 / 0.1 ppm increments)

CO: 0 – 500 ppm (1 ppm increments)

O2: 0 – 30.0% vol. (0.1% vol. increments)

Combustible (LEL): 0% to 100% LEL (1% LEL increments) or 0.0% to 5.0% v/v methane

Sensor type:

Alarm conditions: STEALTH, TWA alarm, STEL alarm, low alarm, high alarm, multi-gas alarm, low battery alarm, confidence beep, automatic deactivation alarm

Audible alarm: 95 dB at 30 cm (1 ft.) (100 dB typical) variable pulsed beeper

Visual alarm: Red light-emitting diodes (LED)

Display: Alphanumeric liquid crystal display (LCD)

Screen resolution: 160X240 pixels.

Backlight: Activates when the pushbutton is pressed and deactivates after 5 seconds; also activates during an alarm condition

Self-test: Initiated upon activation.

Calibration: Automatic zero and automatic span.

Standards and Certifications

The Honeywell BW™ Ultra gas detector is in conformity with the following standards and certifications:

Approvals:

Approved by UL to both U.S. and Canadian Standards

UL 913, 8th Edition

UL 60079-0, 6th Edition

UL 60079-1, 7th Edition.

UL 60079-11, 6th Edition

ANSI/ISA 60079-29-1 (12.13.01) - 2013

CSA C22.2 No.152-M1984 (R2016)

CSA C22.2 No. 60079-0:15

CSA C22.2 No. 60079-11:14

CSA C22.2 No. 60079-1:16

UL: E480011

Class I, Division I, Group A, B, C and D, Temperature code T4, $-40 \leq T_{amb} \leq +50^{\circ}\text{C}$

Class I, Zone 0, AEx ia IIC T4 Ga, $-40 \leq T_{amb} \leq +50^{\circ}\text{C}$
(without LEL and IR sensor installed)

Class I, Zone 0, AEx da ia IIC T4 Ga, $-40 \leq T_{amb} \leq +50^{\circ}\text{C}$
(with LEL sensor installed and without IR sensor installed)

Class I, Zone 0, AEx ia IIC T4 Ga, $-20^{\circ}\text{C} \leq T_{amb} \leq +50^{\circ}\text{C}$
(with IR sensor installed and without LEL sensor installed)

Class I, Zone 0, AEx da ia IIC T4 Ga, $-20^{\circ}\text{C} \leq T_{amb} \leq +50^{\circ}\text{C}$
(with LEL and IR sensor installed)

CSA: E480011

Class I, Division I, Group A, B, C and D, Temperature code T4, $-40 \leq T_{amb} \leq +50^{\circ}\text{C}$

Ex ia IIC T4 Ga, $-40 \leq T_{amb} \leq +50^{\circ}\text{C}$
(without LEL and IR sensor installed)

Ex da ia IIC T4 Ga, $-40 \leq T_{amb} \leq +50^{\circ}\text{C}$
(with LEL sensor installed and without IR sensor installed)

Ex ia IIC T4 Ga, $-20^{\circ}\text{C} \leq T_{amb} \leq +50^{\circ}\text{C}$ (with IR sensor installed and without LEL sensor installed)

Ex da ia IIC T4 Ga, $-20^{\circ}\text{C} \leq T_{amb} \leq +50^{\circ}\text{C}$ (with LEL and IR sensor installed)

ATEX: DEMKO 18 ATEX 1833X

EN IEC 60079-0:2018

EN 60079-11:2012

EN 60079-1:2014

I M1 Ex ia I Ma, II 1 G Ex ia IIC T4 Ga, $-40^{\circ}\text{C} \leq T_{amb} \leq +50^{\circ}\text{C}$
(without LEL and IR sensor installed)

I M1 Ex da ia I Ma, II 1 G Ex da ia IIC T4 Ga, $-40^{\circ}\text{C} \leq T_{amb} \leq +50^{\circ}\text{C}$
(with LEL sensor installed and without IR sensor installed)

I M1 Ex db ia I Ma, II 2 G Ex db ia IIC T4 Gb, $-20^{\circ}\text{C} \leq T_{amb} \leq +50^{\circ}\text{C}$
(with IR sensor installed)

IECEX: UL 18.0061X

IEC 60079-0:2017

IEC 60079-11:2011

IEC 60079-1:2014

Ex ia I Ma, Ex ia IIC T4 Ga, $-40^{\circ}\text{C} \leq T_{amb} \leq +50^{\circ}\text{C}$

(without LEL and IR sensor installed)

Ex da ia I Ma, Ex da ia IIC T4 Ga, $-40^{\circ}\text{C} \leq T_{amb} \leq +50^{\circ}\text{C}$

(with LEL sensor installed and without IR sensor installed)

Ex db ia I Ma, Ex db ia IIC T4 Gb, $-20^{\circ}\text{C} \leq T_{amb} \leq +50^{\circ}\text{C}$

(with IR sensor installed)

The following additional previous editions of Standards noted under the “Standards” section of this Certificate were applied to integral Components as itemized below. There are no significant safety related changes between these previous editions and the editions noted under the “Standards” section.

Product	Certificate Num	Standards
Dynament Ltd. Gas Sensors Type MSH2ia***	IECEX FTZU 15.0002U	IEC 60079-0 Edition 2011
City Technology Limited, Miniature Combustible Gas Sensor - 1 LEL 75	IECEX ULD 16.0016U	IEC 60079-0 Edition 2011

FCC Compliance

This device complies with part 15 of the FCC Rules.

Operation is subject to the following two conditions:

- (1) This device may not cause harmful interference, and
- (2) this device must accept any interference received, including interference that may cause undesired operation.

This transmitter must not be co-located or operated in conjunction with any other antenna or transmitter. This equipment complies with FCC radiation exposure limits set forth for an uncontrolled environment. End users must follow the specific operating instructions for satisfying RF exposure compliance.

NOTE: This equipment has been tested and found to comply with the limits for a Class A digital device, pursuant to part 15 of the FCC Rules. These limits are designed to provide reasonable protection against harmful interference when the equipment is operated in a commercial environment. This equipment generates, uses, and can radiate radio frequency energy and, if not installed and used in accordance with the instruction manual, may cause harmful interference to radio communications. Operation of this equipment in a residential area is likely to cause harmful interference in which case the user will be required to correct the interference at his own expense.

CAUTION

Changes or modifications not expressly approved by the manufacturer responsible for compliance could void the user's authority to operate the equipment.

This device complies with FCC radiation exposure limits set forth for an uncontrolled environment and meets the FCC radio frequency (RF) Exposure Guidelines. This device has very low levels of RF energy that it is deemed to comply without maximum permissive exposure evaluation (MPE).

RED Compliance

Honeywell Analytics Asia Pacific Co., Ltd. hereby declares that this gas detector, Honeywell BW™ Ultra, is in compliance with the essential requirements and other relevant provisions of Directive 2014/53/EU.

Canada, Industry Canada (IC) Notices

This device complies with Industry Canada license-exempt RSS. Operation is subject to the following two conditions:

- (1) this device may not cause interference, and
- (2) this device must accept any interference, including interference that may cause undesired operation of the device.

This device complies with FCC/ISED radiation exposure limits set forth for an uncontrolled environment and meets the FCC/ISED radio frequency (RF) Exposure Guidelines. This device has very low levels of RF energy that it is deemed to comply without maximum permissive exposure evaluation (MPE).

Canada, avis d'Industrie Canada (IC)

Cet appareil est conforme aux normes RSS exemptes de licence d'Industrie Canada. Son utilisation est soumise aux deux conditions suivantes :

- (1) cet appareil n'engendre pas d'interférences, et
- (2) cet appareil doit tolérer tout type d'interférences, notamment les interférences pouvant provoquer une utilisation non désirée de l'appareil.

Cet équipement est conforme aux limites établies par FCC/ Industrie Canada en matière d'exposition aux radiations dans un environnement non contrôlé. Cet équipement ne doivent pas être colocalisés ou fonctionner en conjonction avec tout autre antenne ou émetteur.

In terms of North America flammable gas performance approval:

Honeywell BW™ Ultra is approved for ISA 60079-29-1 and CSA C22.2 No.152.

Only Honeywell BW™ Ultra catalytic bead flammable sensor was evaluated for CSA C22.2 No.152 and ISA 60079-29-1. The evaluation is valid only with the pumping flow rate 300 ml/min, 3 m length tube and CH₄ (Methane) gas.

The other options are not the scope of CSA C22.2 No.152 and ISA 60079-29-1.

For the compliance of CSA C22.2 No.152 and ISA 60079-29-1, the adjustable alarm point shall not exceed 60 % LEL and the highest alarm shall be configured as latching alarm.

In ISA 60079-29-1, Honeywell BW™ Ultra was tested only for IP54. Other IP ratings are not the scope of ISA 60079-29-1. Honeywell BW™ Ultra was pressure tested for 80, 100 and 120 kPa in ISA 60079-29-1. Outside of 80 - 120 kPa is NOT the scope of ISA 60079-29-1.

Label Information

BW Ultra Battery label

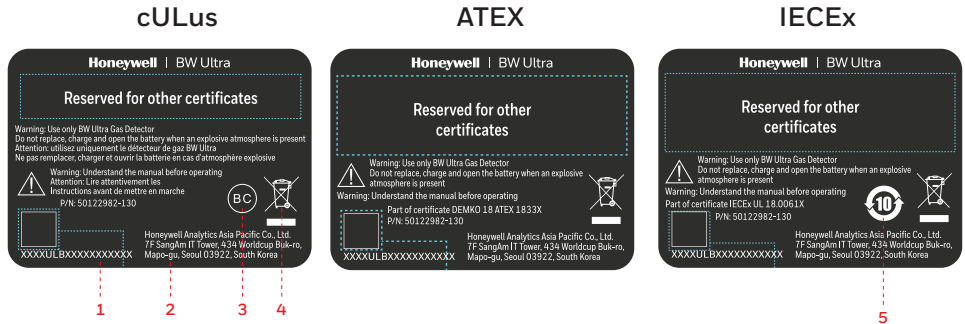

1. BW Ultra battery serial number and 2D barcode
2. Manufacturer information
3. CEC battery charging system approval marking
4. WEEE marking
5. Chinese EPUP marking

BW Ultra Instrument label

cULus

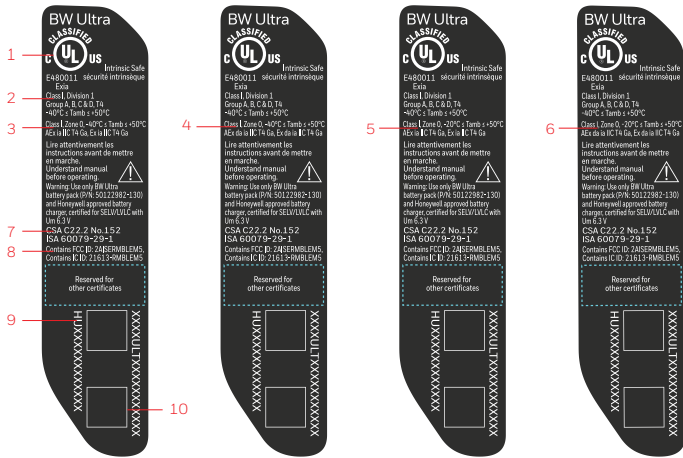

1. cULus certificate marking
2. Class Division protection marking
3. Class Zone protection marking when BW Ultra is configured without LEL and IR sensor
4. Class Zone protection marking when BW Ultra is configured with LEL and without IR sensor
5. Class Zone protection marking when BW Ultra is configured with IR sensor and without LEL sensor
6. Class Zone protection marking when BW Ultra is configured with IR sensor and with LEL sensor
7. North America flammable performance approval
8. FCC and IC certificate number
9. BW Ultra part number and 2D barcode
10. BW Ultra serial number and 2D barcode

ATEX

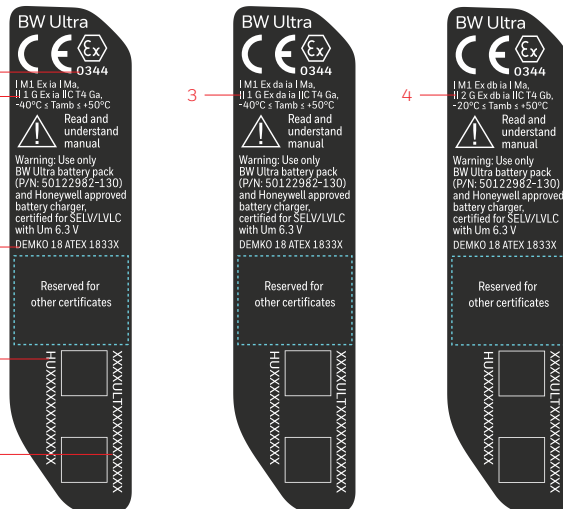

1. ATEX QAN notified body number
2. ATEX protection marking when BW Ultra is configured without LEL and IR sensor
3. ATEX protection marking when BW Ultra is configured with LEL and without IR sensor
4. ATEX protection marking when BW Ultra is configured with IR sensor
5. ATEX certificate number
6. BW Ultra part number and 2D barcode
7. BW Ultra serial number and 2D barcode

IECEX

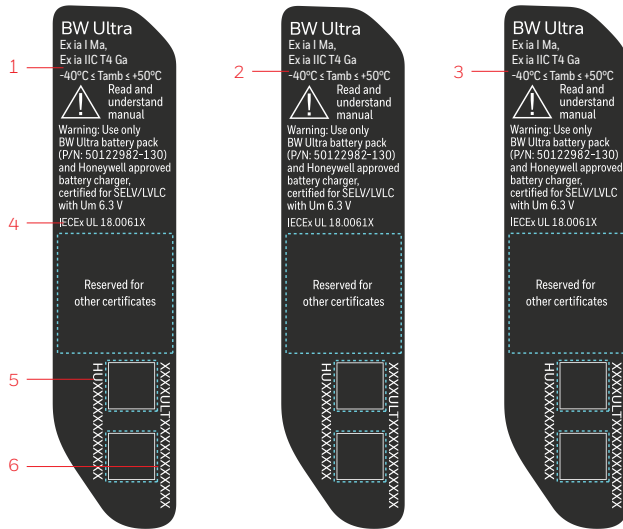

1. IECEX protection marking when BW Ultra is configured without LEL and IR sensor
2. IECEX protection marking when BW Ultra is configured with LEL and without IR sensor
3. IECEX protection marking when BW Ultra is configured with IR sensor
4. IECEX certificate number
5. BW Ultra part number and 2D barcode
6. BW Ultra serial number and 2D barcode

Part Number Format

BW Ultra's explosion-proof protection type varies per the sensor configuration. The user can notice the sensor configuration with the part number format.

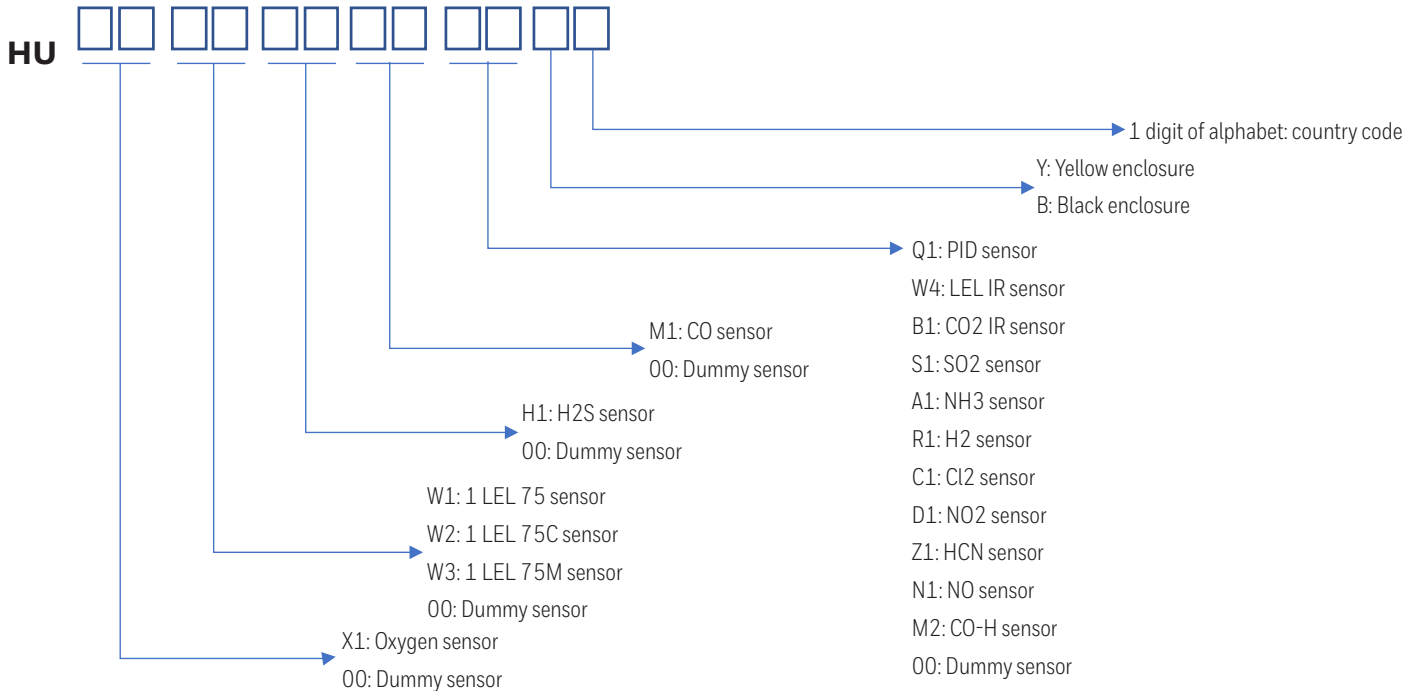

Troubleshooting

Problem	Probable Cause	Solution
Detector does not display normal gas reading after startup sequence	Sensor not stabilized	Used sensor: wait 60 seconds. New sensor: wait 5 minutes.
	Sensor requires calibration	Calibrate the detector.
	Target gas is present	Detector is operating properly. Use caution in suspect areas.
Detector does not respond to button	Battery is in critical low battery state or is completely depleted	Replace the battery.
	Detector is performing operations that do not require user input	Button operation restores automatically when the operation ends.
Detector does not accurately measure gas	Sensor requires calibration	Calibrate the detector.
	Detector is colder/hotter than gas temperature	Allow the detector to acquire ambient temperature before use.
	Sensor filter is blocked	Clean the sensor filter.
Detector does not enter alarm	Alarm setpoint(s) are set incorrectly	Reset the alarm setpoints.
	Alarm setpoint(s) set to zero	Reset the alarm setpoints.
	Detector is in calibration mode	Complete calibration.
Detector intermittently enters alarm without reason	Ambient gas levels are near alarm setpoint or the sensor is exposed to a puff of hazardous gas	Detector is operating normally. Use caution in suspect areas. Check MAX gas exposure reading.
	Alarm setpoints are set incorrectly	Reset the alarm setpoints.
	Detector requires calibration	Calibrate the detector.
	Missing or faulty sensor	Change the sensor.
Features and options are not operating as expected	Changes in Fleet Manager II	Verify the setup in Fleet Manager II.
Battery has been charging for 6 hours. Charging indicator on LCD shows the battery is still charging	Battery is trickle charging	Verify the charger is properly connected to the AC outlet.
Battery indicator does not display when charging	Battery is depleted below normal levels	Replace the battery.
Battery does not charge		Replace the battery.
Sensor fails to zero during startup self-test		Change the sensor.
The detector does not activate.	Depleted battery.	Replace the battery.
	Damaged detector.	Contact Honeywell.
Detector automatically deactivates.	Automatic deactivation due to critical low battery.	Replace the battery.
	Lockout on Self-Test Error is enabled and a sensor(s) has failed the startup self-test.	Change the sensor.
	Sensor(s) require calibration.	Calibrate the detector.

Glossary

ACGIH

The ACGIH method is defined as the infinite (total) accumulated average, whether it is 2 hours or 8 hours.

BLE

Bluetooth Low Energy.

Bump test

A compliance test that confirms the detector's ability to respond to target gases by exposing the detector to a known gas concentration. Other procedures that are specified to occur automatically when the detector is inserted into a docking module may be performed in conjunction with the bump test.

Calibration

A two-step compliance test that determines the measurement scale for the detector's response to gas. In the first step, a baseline reading is taken in a clean, uncontaminated environment. In the second step, the sensors are exposed to known concentrations of gas. The detector uses the baseline and known gas concentrations to determine the measurement scale.

Datalog

A datalog is a file that contains detailed, date-stamped records related to detector operations and configuration settings. The datalog is continuously updated. Records that span the operating life of the detector are retained.

Event log

An event log is a file that contains detailed, time-stamped records data related to gas events, and compliance tests. The event log is updated when an event occurs. A specified number records for the most recent events are retained.

Fleet Manager

A proprietary, Windows-based software developed by Honeywell to configure and manage docking modules, calibration, bump tests, and data logs. Fleet Manager II is available for download from www.honeywellanalytics.com

Gang

A group of two to five connected IntelliDoX modules. Modules that are connected share power, network and gas connections.

IntelliDoX Docking Module

An automatic bump test and calibration docking station for use with portable gas detectors manufactured by Honeywell.

IR

Infrared. IR is an invisible radiant energy that can be used for short-range wireless communications between enabled devices.

LCD

Liquid crystal display. LCD is a technology that is commonly used for display screens on mobile digital devices.

Normal atmosphere

A fresh air environment with 20.9% v/v oxygen (O₂) that is free of hazardous gas

Operating Life

The period of operational use required to attain the specified operating limit. Operating life includes normal operating time, alarm time, and all types of idle time.

OSHA

The US OSHA method is defined as a moving average that accumulates over an 8-hour average. If the worker is in the field longer, the oldest accumulated values (first hour) are replaced by the newest values (ninth hour). This continues for the duration of the work shift until the detector is deactivated.

PPM

Parts per million, a measure of concentration.

Reboot

Restart the operating system for the module

Service Life

The expected lifetime of a product, as specified by the manufacturer.

Station

An area or zone dedicated to a specific activity. A compliance testing station may contain several IntelliDoX modules and gangs of connected modules.

Stealth mode

When enabled, the backlight, visual alarms, and audible alarms are disabled. During an alarm, the vibrator activates and readings are displayed on the LCD.

STEL

The Short-Term exposure Limit is the maximum permissible gas concentration a worker can be safely exposed to for short periods of time (5-15 minutes maximum).

TWA Alarm

The time-weighted average (TWA) is a safety measure used to calculate accumulated averages of gases. Using the US Occupational Safety and Health Administration (OSHA) method or the American Conference of Governmental Hygienists (ACGIH) method, an average is calculated to ensure the detector alarms when the TWA has accumulated.

V/V

Volume percent concentration.

Contact Honeywell

Corporate Headquarters

Honeywell Analytics
Suite 110, 4411-6 St SE
Calgary, Alberta
Canada T2G 4E8
Toll free: 1-888-749-8878

United States

Honeywell Analytics
405 Barclay Boulevard
Lincolnshire, Illinois
USA 60069
Toll free: 1-888-749-8878

Asia

Honeywell Analytics Asia Pacific
7F SangAm IT Tower,
434 Worldcup Buk-ro, Mapo-gu,
Seoul 03922, Republic of Korea
Tel: +82 (0) 2 6909 0300
Analytics.ap@honeywell.com

Europe

Honeywell Analytics
Javastrasse 2
8604 Hegnau
Switzerland
Toll free: 00800-333-22244
Other countries, toll free: 1-403-248-9226
Bwa.customerservice@honeywell.com
www.honeywellanalytics.com



Revision History		
Rev B	March 2019 Writer: Dalai Gómez	Update to revision B and 2019 Update ATEX & IECEx info and labels Add table in "Standards" section
Rev B	July 2019 Elias Diaz	Add 100000 as BLE pairing code. From the What's in the Box section: * Added 5 Assembly-Hydrophobic filter * Removed "2 Fitting mini quick connector to 1/8"

© Honeywell, 2019
All rights reserved

Honeywell