

***GasAlertMicro5***

***GasAlertMicro5*** PID

***GasAlertMicro5*** IR

*1, 2, 3, 4, 5 Gas Detector*

***Quick Reference Guide***

**BW**  
Technologies  
by Honeywell

## ***Limited Warranty and Limitation Liability***

BW Technologies LP (BW) warrants the product to be free from defects in material and workmanship under normal use and service for a period of two years, beginning on the date of shipment to the buyer. This warranty extends only to the sale of new and unused products to the original buyer. BW's warranty obligation is limited, at BW's option, to refund of the purchase price, repair or replacement of a defective product that is returned to a BW authorized service center within the warranty period. In no event shall BW's liability hereunder exceed the purchase price actually paid by the buyer for the Product.

This warranty does not include:

- a) fuses, disposable batteries or the routine replacement of parts due to the normal wear and tear of the product arising from use;
- b) any product which in BW's opinion, has been misused, altered, neglected or damaged, by accident or abnormal conditions of operation, handling or use;
- c) any damage or defects attributable to repair of the product by any person other than an authorized dealer, or the installation of unapproved parts on the product; or

The obligations set forth in this warranty are conditional on:

- a) proper storage, installation, calibration, use, maintenance and compliance with the product manual instructions and any other applicable recommendations of BW;
- b) the buyer promptly notifying BW of any defect and, if required, promptly making the product available for correction. No goods shall be returned to BW until receipt by the buyer of shipping instructions from BW; and
- c) the right of BW to require that the buyer provide proof of purchase such as the original invoice, bill of sale or packing slip to establish that the product is within the warranty period.

THE BUYER AGREES THAT THIS WARRANTY IS THE BUYER'S SOLE AND EXCLUSIVE REMEDY AND IS IN LIEU OF ALL OTHER WARRANTIES, EXPRESS OR IMPLIED, INCLUDING BUT NOT LIMITED TO ANY IMPLIED WARRANTY OF MERCHANTABILITY OR FITNESS FOR A PARTICULAR PURPOSE. BW SHALL NOT BE LIABLE FOR ANY SPECIAL, INDIRECT, INCIDENTAL OR CONSEQUENTIAL DAMAGES OR LOSSES, INCLUDING LOSS OF DATA, WHETHER ARISING FROM BREACH OF WARRANTY OR BASED ON CONTRACT, TORT OR RELIANCE OR ANY OTHER THEORY.

Since some countries or states do not allow limitation of the term of an implied warranty, or exclusion or limitation of incidental or consequential damages, the limitations and exclusions of this warranty may not apply to every buyer. If any provision of this warranty is held invalid or unenforceable by a court of competent jurisdiction, such holding will not affect the validity or enforceability of any other provision.

### ***Warranty Registration***

<http://www.honeywellanalytics.com/support/product-registration>

### ***Contacting BW Technologies by Honeywell***

USA & Canada: 1-888-749-8878

[Bwa.customerservice@honeywell.com](mailto:Bwa.customerservice@honeywell.com)

Europe: 00800-333-222-44

[www.honeywellanalytics.com](http://www.honeywellanalytics.com)

Other countries: 1-403-248-9226

## Table of Contents

<b>Limited Warranty and Limitation Liability</b> .....	<b>0</b>	<b>Maintenance</b> .....	<b>22</b>
<b>Warranty Registration</b> .....	<b>0</b>	<b>Replacing Battery Cells and Packs</b> .....	<b>23</b>
<b>Contacting BW Technologies by Honeywell</b> .....	<b>0</b>	Replacing Alkaline Batteries .....	24
<b>Introduction</b> .....	<b>1</b>	Replacing Lithium Battery Packs .....	25
<b>Safety Information - Read First</b> .....	<b>1</b>	WEEE Directive and Battery Directive .....	25
<b>Informations de sécurité – À lire au préalable</b> .....	<b>4</b>	Removal and Disposal of the Battery Pack .....	25
<b>Sensor Poisons and Contaminants</b> .....	<b>7</b>	Removal and Disposal of the Coin Cell .....	26
<b>Parts of the GasAlertMicro 5/PID/IR</b> .....	<b>8</b>	Replacing a Sensor or Sensor Filter .....	28
<b>Display Elements</b> .....	<b>9</b>	Replacing the Pump Filter (Generation 2 Pump only) .....	29
<b>Button</b> .....	<b>10</b>	Replacing the Pump Nozzle (Generation 2 Pump only)	30
<b>Connecting the Gas Cylinder to the Detector</b> .....	<b>10</b>	<b>Specifications</b> .....	<b>30</b>
Single Gas Calibration Cap .....	11	<b>Information Required for European Regulations</b>	
Removing the Cap .....	11	<b>Compliance</b> .....	<b>34</b>
<b>Pump</b> .....	<b>12</b>	Tested Sensors .....	35
Identifying the Pump .....	12	Performance Data According to EN 45544 Part 1 and 2	35
Pump Features .....	13	<b>Troubleshooting</b> .....	<b>36</b>
Pump Alarm .....	13	<b>Replacement Parts and Accessories</b> .....	<b>42</b>
Confined Space Sampling .....	13		
Maximum Hose Length when Confined Space			
Sampling .....	14		
<b>Bump Test</b> .....	<b>15</b>		
Performing a Bump Test .....	15		
<b>Calibration</b> .....	<b>16</b>		
<b>Alarms</b> .....	<b>18</b>		
<b>User Options Menu</b> .....	<b>21</b>		



# GasAlertMicro 5/PID/IR

## Introduction

The quick reference guide provides basic information to operate the GasAlertMicro 5, GasAlertMicro 5 PID, and GasAlertMicro 5 IR gas detectors. For complete operating instructions, refer to the *GasAlertMicro 5/PID/IR User Manual* provided on the CD-ROM.

The GasAlertMicro 5, GasAlertMicro 5 PID, and GasAlertMicro 5 IR detectors (“the detector”) are designed to warn of hazardous gas levels above user-defined alarm setpoints.

### Note

*Unless reference is made to a specific detector model, the GasAlertMicro 5, GasAlertMicro 5 PID, and GasAlertMicro 5 IR detectors are referred to as GasAlertMicro 5/PID/IR.*

*The detector is shipped with English as the default displayed language. Additional languages provided are French, German, Spanish, and Portuguese. The screens for the additional languages are displayed on the detector and in the corresponding quick reference guide.*

## Safety Information - Read First

Use the detector only as specified in this quick reference guide and the user manual, otherwise the protection provided by the detector may be impaired.

The detector is a personal safety device. It is your responsibility to respond properly to the alarm.

Read the following **Cautions** before using the detector.

### Cautions

- **Warning:** Substitution of components may impair Intrinsic Safety.
- **Caution:** For safety reasons, this equipment must be operated and serviced by qualified personnel only. Read and understand the user manual completely before operating or servicing.
- **Charge the detector before first-time use.** BW recommends the detector be charged after every workday.
- **Charge the battery pack immediately when a low battery alarm occurs.**
- **Read and adhere to the battery cautions provided in [Replacing Battery Cells and Packs on page 23](#).**

- **BW** recommends that the combustible sensor be checked with a known concentration of calibration gas after any exposure to contaminants/poisons such as sulfur compounds, silicon vapors, halogenated compounds, etc.
- **BW** recommends to bump test the sensors before each day's use to confirm their ability to respond to gas by exposing the detector to a gas concentration that exceeds the alarm setpoints. Manually verify that the audible and visual alarms are activated. Calibrate if the readings are not within the specified limits.
- For an additional bump test caution relating to the European Regulations, refer to [page 15](#).
- Calibrate the detector before first-time use and then on a regular schedule, depending on use and sensor exposure to poisons and contaminants. The sensors must be calibrated regularly and at least once every 180 days (6 months).
- Calibrate only in a safe area that is free of hazardous gas in an atmosphere of 20.9% oxygen.
- Only the combustible gas detection portion of this instrument has been assessed for performance by CSA International.
- The combustible sensor is factory calibrated to 50% LEL methane. If monitoring a different combustible gas in the % LEL range, calibrate the sensor using the appropriate gas.
- Caution: High off-scale LEL readings may indicate an explosive concentration.
- Protect the combustible sensor from exposure to lead compounds, silicones, and chlorinated hydrocarbons. Although certain organic vapors (such as leaded gasoline and halogenated hydrocarbons) may temporarily inhibit sensor performance, in most cases, the sensor will recover after calibration.
- For use only in potentially explosive atmospheres where oxygen concentrations do not exceed 20.9% (v/v). Oxygen deficient atmospheres (<10% v/v) may suppress some sensor outputs.
- Any rapid up scaling reading followed by a declining or erratic reading may indicate a gas concentration beyond the upper scale limit, which can be hazardous.
- Extended exposure of the GasAlertMicro 5, GasAlertMicro 5 PID, or GasAlertMicro 5 IR to certain concentrations of combustible gases and air may stress the detector element that can seriously affect its performance. If an alarm occurs due to a high concentration of combustible gases, recalibration should be performed or, if needed, the sensor replaced.
- The BW pump module (M5-PUMP) is certified for use with the GasAlertMicro 5, GasAlertMicro 5 PID, and GasAlertMicro 5 IR models only.
- Protect the PID sensor from exposure to silicone vapors.
- When calibrating O<sub>3</sub> and ClO<sub>2</sub> sensors that are located in the Toxic 2 position of the detector, a single gas calibration cap must be used to ensure accurate calibration.

- Replace the sensors only in a safe and non-hazardous area that is free of hazardous gas in an atmosphere of 20.9% oxygen.
- **Warning:** The battery pack (M5-BAT08) is equipped with a lithium battery that may present a risk of fire or chemical burn hazard if misused. Do not disassemble, heat above 212°F (100°C), or incinerate.
- **Warning:** Do not use any other lithium batteries that are not designed for use with the GasAlertMicro 5, GasAlertMicro5 PID, or GasAlertMicro5 IR detectors. Use of any other cell can cause fire and/or explosion. To order and replace the M5-BAT07 or the M5IR-BAT08 lithium battery pack, contact BW Technologies by Honeywell.
- **Warning:** Lithium polymer cells exposed to heat at 266°F (130°C) for 10 minutes can cause fire and/or explosion.
- Dispose of used lithium cells immediately. Do not disassemble and do not dispose of in fire. Do not mix with the solid waste stream. Spent batteries must be disposed of by a qualified recycler or hazardous materials handler.
- Keep lithium cells away from children.
- Before using common products around sensors, refer to [Sensor Poisons and Contaminants on page 4](#).
- High concentrations of certain toxic gases, for example H<sub>2</sub>S, may have an adverse effect on the LEL sensor. This effect, known as inhibition, is usually temporary but in extreme circumstances can impair the sensitivity of the LEL sensor.
- After any gas exposure that causes an alarm in the toxic gas sensors, the LEL sensor should be verified with a bump test, and recalibrated if necessary.
- Products may contain materials that are regulated for transportation under domestic and international dangerous goods regulations. Return product in compliance with appropriate dangerous goods regulations. Contact freight carrier for further instructions.

The detector contains either alkaline batteries or a lithium polymer battery. Refer to the following warnings.

 **Warning**

This instrument contains alkaline batteries. Do not mix with the solid waste stream. Spent batteries must be disposed of by a qualified recycler or hazardous materials handler.

 **Warning**

This instrument contains a lithium polymer battery. Dispose of lithium cells immediately. Do not disassemble and do not dispose of in fire. Do not mix with the solid waste stream. Spent batteries should be disposed of by a qualified recycler or hazardous materials handler.

## **Informations de sécurité – À lire au préalable**

Utilisez le détecteur dans le seul but indiqué dans ce mémento et dans le manuel d'utilisation, sous peine de porter préjudice à la protection assurée par le détecteur.

Le détecteur est un appareil de sécurité individuel. Il est de votre responsabilité de réagir à l'alarme de manière appropriée.

Lisez les **Mises en garde** suivantes avant d'utiliser le détecteur.

### **⚠ Mises en garde**

- **Avertissement** : Le remplacement d'un composant de l'appareil peut compromettre la sécurité intrinsèque du détecteur.
- **Attention** : Pour des raisons de sécurité, cet appareil doit être utilisé et entretenu par du personnel qualifié uniquement. Lisez attentivement le manuel d'utilisation avant d'utiliser l'appareil ou d'en assurer l'entretien et assurez-vous d'en avoir bien compris les instructions.
- Chargez le détecteur avant sa première utilisation. BW recommande de recharger le détecteur après chaque journée d'utilisation.
- Chargez la batterie dès l'émission d'une alarme de batterie faible.
- Lisez et respectez les avertissements donnés à la section [Remplacement des batteries et des piles, page 23](#).

- BW recommande de contrôler le capteur de gaz combustibles à l'aide d'une concentration connue de gaz d'étalonnage après toute exposition à des contaminants/poisons (composés de soufre, vapeurs de silicium, produits halogénés, etc.)
- Avant chaque utilisation quotidienne, BW recommande d'effectuer un test fonctionnel des capteurs afin de vérifier qu'ils réagissent bien aux gaz présents, en exposant le détecteur à une concentration de gaz supérieure aux seuils d'alarme. Vérifiez manuellement que les alarmes sonore et visuelle sont activées. Étalonnez l'appareil si les relevés ne sont pas conformes aux limites spécifiées.
- Pour une mise en garde supplémentaire sur le test fonctionnel en rapport avec la réglementation européenne, reportez-vous à la [page 15](#).
- Étalonnez le détecteur avant sa première utilisation, puis de manière régulière, en fonction de l'utilisation et de l'exposition du capteur aux poisons et autres contaminants. Les capteurs doivent être étalonnés régulièrement et au moins une fois tous les 180 jours (6 mois).
- Veillez à effectuer l'étalonnage dans une zone sûre, exempte de gaz dangereux, dans une atmosphère contenant 20,9 % d'oxygène.
- Seul l'élément de détection de gaz combustibles de cet appareil a fait l'objet d'une évaluation des performances homologuée par CSA International.



- Le capteur de gaz combustibles est étalonné en usine au méthane, à une concentration de 50 % de la LIE. Si la surveillance porte sur un autre gaz combustible dans la plage % LIE, étalonnez le capteur en utilisant le gaz approprié.
- Attention : Des valeurs LIE hors échelle élevées peuvent indiquer la présence d'une concentration explosive.
- Protégez le capteur de gaz combustibles contre toute exposition aux composés de plomb, aux silicones et aux hydrocarbures chlorés. Bien que certaines vapeurs organiques (comme l'essence au plomb ou les hydrocarbures halogénés) puissent neutraliser provisoirement les performances du capteur, dans la plupart des cas, le capteur retrouvera son fonctionnement normal après étalonnage.
- Cet appareil est destiné uniquement à une utilisation dans des atmosphères potentiellement explosives, dans lesquelles la concentration d'oxygène ne dépasse pas 20,9 % (v/v). Les atmosphères appauvries en oxygène (<10 % v/v) peuvent inhiber certaines sorties du capteur.
- Toute mesure en rapide augmentation suivie d'une diminution ou d'une mesure fantaisiste peut indiquer une concentration de gaz au-delà de la limite d'échelle supérieure, risquant donc d'être dangereuse.
- L'exposition prolongée du GasAlertMicro 5, GasAlertMicro 5 PID ou GasAlertMicro 5 IR à certaines concentrations de gaz combustibles et d'air peut fortement solliciter l'élément du détecteur et nuire gravement à ses performances. En cas d'alarme suite à une forte concentration de gaz combustible, il convient d'effectuer un réétalonnage, voire de remplacer le capteur si nécessaire.
- Le module de pompe BW (M5-PUMP) est certifié pour les modèles GasAlertMicro 5, GasAlertMicro 5 PID et GasAlertMicro 5 IR uniquement.
- Protégez le capteur à photo-ionisation (PID) des expositions aux vapeurs de silicium.
- Pour garantir un étalonnage précis des capteurs d'O<sub>3</sub> et de ClO<sub>2</sub> placés en position toxique 2 du détecteur, employez un seul capuchon d'étalonnage monogaz.
- Remplacez les capteurs uniquement en zone sûre et non dangereuse, dans une atmosphère exempte de gaz dangereux et contenant 20,9 % d'oxygène.
- **Avertissement** : La batterie (M5-BAT08) est constituée d'une pile au lithium qui pourrait présenter un risque d'incendie ou de brûlure chimique en cas de mauvaise utilisation. Ne pas la démonter ni la chauffer au-delà de 100 °C (212 °F) ou l'incinérer.

- **Avertissement** : N'utilisez jamais d'autres piles au lithium avec les détecteurs GasAlertMicro 5, GasAlertMicro5 PID ou GasAlertMicro5 IR. Toute autre batterie pourrait provoquer un incendie et/ou une explosion. Pour commander ou remplacer la batterie au lithium M5-BAT07 ou M5IR-BAT08, contactez BW Technologies by Honeywell.
- **Avertissement** : Les batteries au lithium polymère exposées à une température supérieure à 130 °C (266 °F) pendant plus de 10 minutes peuvent provoquer un incendie et/ou une explosion.
- Mettez immédiatement au rebut les batteries au lithium usagées. Veillez à ne jamais les démonter ou les jeter au feu. Ne pas les mélanger aux autres déchets solides. Les piles usagées doivent être éliminées par un centre de recyclage agréé ou un centre de traitement des matières dangereuses.
- Conservez les batteries au lithium hors de portée des enfants.
- Avant d'utiliser des produits usuels à proximité des capteurs, reportez-vous à la section [Poisons et contaminants des capteurs, page 5](#).

- Des concentrations élevées en certains gaz toxiques, tels que H<sub>2</sub>S, peuvent avoir un effet néfaste sur le capteur LIE. Cet effet, appelé inhibition, est généralement temporaire, mais peut, dans des conditions extrêmes, altérer la sensibilité du capteur LIE.  
Après toute exposition à un gaz entraînant le déclenchement d'une alarme des capteurs de gaz toxiques, le capteur LIE devra subir un test fonctionnel et être réétalonné si nécessaire.
- Les produits peuvent contenir des matériaux qui sont réglementés pour le transport en vertu des règlements nationaux et internationaux de marchandises dangereuses. Retourner le produit conformément à la réglementation sur les marchandises dangereuses appropriées. Contactez transporteur pour plus d'instructions.

Le détecteur contient des piles alcalines ou une batterie au lithium polymère. Reportez-vous aux avertissements suivants.

#### Avertissement

Cet appareil contient des piles alcalines. Ne pas les mélanger aux autres déchets solides. Les piles usagées doivent être éliminées par un centre de recyclage agréé ou un centre de traitement des matières dangereuses.

#### Avertissement

Cet appareil contient une batterie au lithium polymère. Mettez immédiatement au rebut les batteries au lithium

usagées. Veuillez à ne jamais les démonter ou les jeter au feu. Ne pas les mélanger aux autres déchets solides. Les piles usagées doivent être éliminées par un centre de recyclage agréé ou par un centre de traitement des matières dangereuses.

### ***Sensor Poisons and Contaminants***

Several cleaners, solvents, and lubricants can contaminate and cause permanent damage to sensors. Before using cleaners, solvents, and lubricants in close proximity to the detector sensors, read and adhere to the following caution and table.

#### **⚠ Caution**

**Use only the following BW Technologies by Honeywell recommended products and procedures:**

- Use water based cleaners.
- Use non-alcohol based cleaners.
- Clean the exterior with a soft, damp cloth.
- Do not use soaps, polishes, or solvents.

The following table lists common products to avoid using around sensors.

<b>Cleaners and Lubricants</b>	<b>Silicones</b>	<b>Aerosols</b>
<ul style="list-style-type: none"><li>• Brake cleaners</li><li>• Lubricants</li><li>• Rust inhibitors</li><li>• Window and glass cleaners</li><li>• Dishsoaps</li><li>• Citrus based cleaners</li><li>• Alcohol based cleaners</li><li>• Hand sanitizers</li><li>• Anionic detergents</li><li>• Methanol (fuels and antifreezes)</li></ul>	<ul style="list-style-type: none"><li>• Silicone based adhesives, sealants, and gels</li><li>• Hand/body and medicinal creams containing silicone</li><li>• Tissues containing silicone</li><li>• Mold releasing agents</li><li>• Polishes</li></ul>	<ul style="list-style-type: none"><li>• Bug repellents and sprays</li><li>• Lubricants</li><li>• Rust inhibitors</li><li>• Window and glass cleaners</li></ul>

## GasAlertMicro 5/PID/IR

### Quick Reference Guide

### Parts of the GasAlertMicro 5/PID/IR

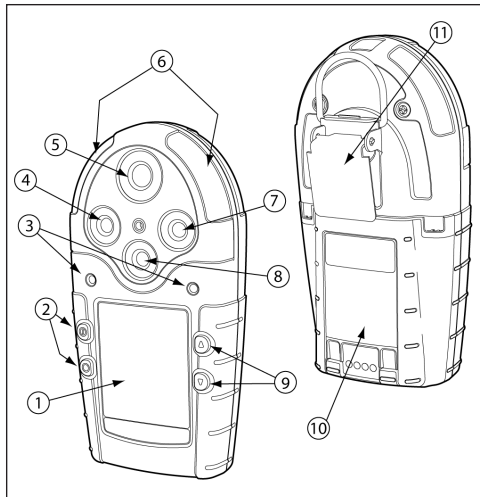

Item	Description
1	Liquid crystal display (LCD)
2	Pushbuttons
3	Audible alarms
4	Toxic 2 sensor
5	Toxic 1/PID sensor (GasAlertMicro 5 PID), or Toxic 1/IR (CO <sub>2</sub> ) sensor (GasAlertMicro 5 IR)
6	Visual alarm indicators (LEDs)
7	LEL sensor
8	Oxygen sensor
9	Pushbuttons
10	Battery pack
11	Alligator clip

## Display Elements

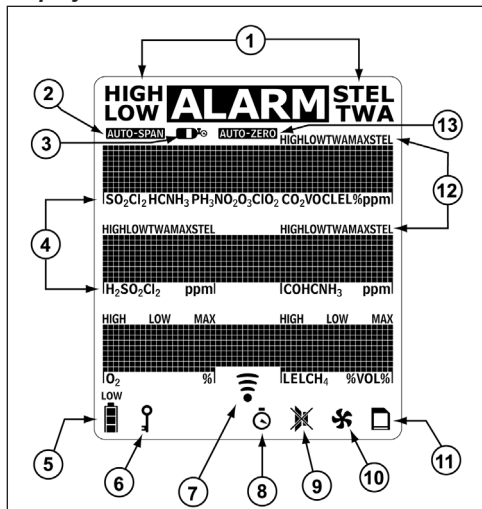

Item	Description
1	Alarm condition
2	Automatically span sensor
3	Gas cylinder
4	Gas identifier bars
5	Battery life indicator
6	Passcode lock
7	Data transmission
8	Clock
9	Stealth mode
10	Optional pump indicator
11	Datalog card indicator (optional)
12	Alarm condition (low, high, TWA, STEL, or multi) or view TWA, STEL and peak (MAX) gas exposures
13	Automatically zero sensor

**Button**

Button	Description
⓪	<ul style="list-style-type: none"> <li>To activate the detector, press ⓪.</li> <li>To deactivate the detector, press and hold ⓪ until the countdown is complete.</li> </ul>
▲	<ul style="list-style-type: none"> <li>To increment the displayed value or scroll up, press ▲.</li> <li>To enter the user option menu, press ▲ and ▼ simultaneously and hold until the countdown is complete.</li> <li>To clear the TWA, STEL, and peak (MAX) gas exposure readings, press ○ and ▲ simultaneously and hold until the countdown is complete.</li> <li>To view the date and time, alarm setpoints (TWA, STEL, low, and high) of all sensors, and the LEL correction factor (if applicable), press ▲.</li> </ul>
▼	<ul style="list-style-type: none"> <li>To decrement the displayed value or scroll down, press ▼.</li> <li>To initiate calibration and setting alarm setpoints, press ○ and ▼ simultaneously and hold until the countdown is complete.</li> </ul>
○	<ul style="list-style-type: none"> <li>To view the TWA, STEL, and peak (MAX) readings, press ○.</li> <li>To acknowledge latched alarms, press ○.</li> </ul>

**Connecting the Gas Cylinder to the Detector**

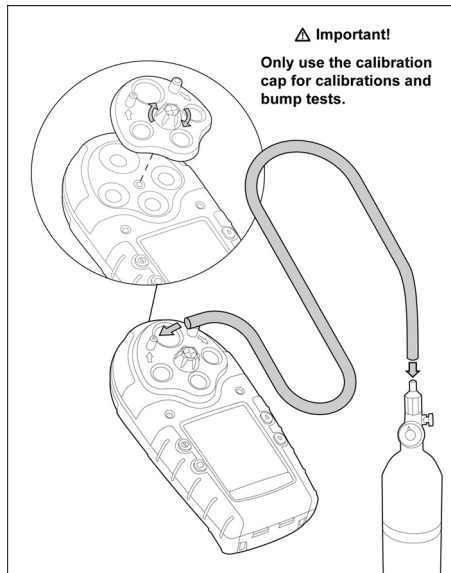

**Single Gas Calibration Cap****⚠ Caution**

If an O<sub>3</sub> or ClO<sub>2</sub> sensor is located in the Toxic 2 sensor position, a single gas calibration cap must be used to ensure accurate calibration.

Only use the single gas calibration cap during the calibration process.

To calibrate O<sub>3</sub> and ClO<sub>2</sub> sensors using the single gas calibration cap, refer to the following procedures and illustrations.

1. Insert the cap into the Toxic 2 sensor position on the detector. Press firmly until the release tabs click.

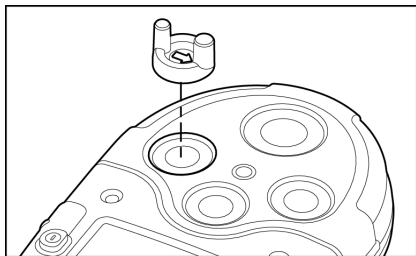

2. Connect the calibration hose to the gas cylinder and to the intake inlet on the cap.

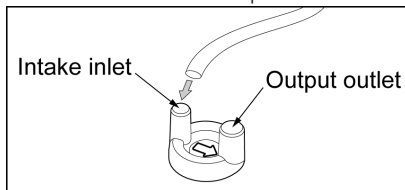
**Note**

The arrow on the cap indicates the direction of gas flow from intake to outtake.

**Removing the Cap**

Using your thumb, push forward against both the inlet and outlet simultaneously to remove the cap from the detector.

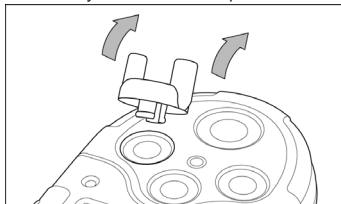

## Pump

When using the pump module, attach it and the pump accessories prior to activating the detector.

For more information on the pump, refer to the *GasAlertMicro 5/PID/IR User Manual*.

### ⚠ Warning

If the pump module is installed on the detector, the following three things must occur during start-up. If any one of the conditions below does not occur, discontinue use of the detector and contact BW Technologies by Honeywell immediately.

- The detector prompts for a pump test during start-up
- The pump module passes the pump test at start-up when the pump inlet or sample chain inlet is blocked
- The ☼ icon displays on the LCD

To ensure accurate gas detection, the sensors must be calibrated immediately when the pump module is replaced by the diffusion cap and vice versa.

When using the sample probe at -10°C to +0°C (14°F to 32°F), keep the sample probe in your hand.

### ⚠ Caution

A demand flow regulator must be used to manually calibrate the GasAlertMicro 5/PID/IR detector when the pump module is installed.

The calibration cap is designed for use with the diffusion cap only. It cannot be used with the pump module.

## Identifying the Pump

There are two generations of pump. The best way to differentiate the Generation 2 pump from the Generation 1 pump is the inline filter that is visible on the Generation 2 pump on the left-hand side.

Each model of pump has different operating specifications. Refer to [Maximum Hose Length when Confined Space Sampling on page 14](#).

**Generation 1: 116885-L3 (yellow) and 118933-L3 (black)**

**Generation 2: 130916-L3\* (yellow) and 130917-L3 (black)**



\*Note

*Performance approved conditions*



## Pump Features

To replace the pump filter and pump nozzle for the Generation 2 pump, refer to [Replacing the Pump Filter \(Generation 2 Pump only\) on page 29](#) and [Replacing the Pump Nozzle \(Generation 2 Pump only\) on page 30](#).

To replace the pump filter for the Generation 1 pump, refer to the *GasAlertMicro 5/PID/IR User Manual*. The pump nozzle cannot be replaced.

## Pump Alarm

The external pump draws air over the sensors continually. If the pump stops operating or becomes blocked, the detector activates the pump alarm and the pump alarm latches. The following screens display.



### ⚠ Caution

Ensure the blockage is cleared before pressing  to acknowledge the latched pump alarm.

When  is pressed, the detector automatically launches a pump test to reset the pump module.

If the pump test is successful, the detector returns to normal operation, otherwise the pump alarm continues. If the pump alarm persists, refer to the [Pump Operation Troubleshooting](#) in the guide or in the Pump Operation section in Troubleshooting in the *GasAlertMicro 5/PID/IR User Manual*.

## Confined Space Sampling

To measure hazardous gas in a confined space, refer to the following illustration and steps 1-5.

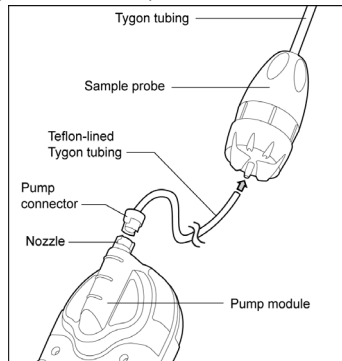

The detector and pump module can also be used with a sintered filter.

**⚠ Warning**

To measure hazardous gas in a confined space, the sample probe must be used with the pump module.

**⚠ Caution**

To prevent the teflon lining inside the Tygon tubing from causing a blockage when connecting it to the sample probe, the end of the tubing must be flared. Refer to steps 2 and 3.

1. Attach the pump connector end of the teflon-lined Tygon tubing to the pump module.
2. Gently insert needle nose pliers into the other end of the teflon-lined Tygon tubing. Using a circular motion, flare the end of the tubing.
3. Connect the flared end of the tubing to the sample probe. Ensure the teflon-lining does not separate from the Tygon tubing, as it will block the tube and generate a pump alarm.
4. Activate the detector. Ensure all connections are secure before sampling.
5. Insert the sample probe into the confined space.

**⚠ Warning**

Depending upon the length of the tubing and the type of gas in the confined space, allow a minimum of 3 seconds per foot of tubing to ensure the readings stabilize before entering the area.

Example: 10 ft. = 30 seconds

**Maximum Hose Length when Confined Space Sampling**

Maximum sample hose length is dependent on pump model, operating temperature, and sampling accessory. Refer to the tables below.

**⚠ Caution**

Maximum sample hose length is dependent on an inner 1/16" hose diameter.

**Table 1. Generation 1 Pump**

	<b>-10°C to +0°C (14°F to 32°F)</b>	<b>0°C to 50°C (32°F to 122°F)</b>
Sintered filter	3 m (10 ft.)	9.1 m (30 ft.)
Sample Probe	3 m (10 ft.)	3 m (10 ft.)

**⚠ Warning**

When using the sample probe at -10°C to +0°C (14°F to 32°F), keep the sample probe in your hand.

**Table 2. Generation 2 Pump**

	<b>-20°C to 50°C (-4°F to 122°F)</b>
Sintered filter	20 m (66 ft.)
Sample Probe	3 m (10 ft.)

## Bump Test

A bump test is the process of applying a small amount of test gas to force the detector into alarm. A bump test should be performed regularly to confirm the sensors are responding correctly to gas, and that the audible, visual, and vibrator alarms activate during an alarm condition. Calibrate if the readings are not within specified limits.

### Performing a Bump Test

#### Caution

**BW recommends to bump test the sensors before each day's use to confirm their ability to respond to gas by exposing the sensors to a gas concentration that exceeds the alarm setpoints.**

**Should the user wish to comply with European Regulations, a bump test must be completed before each day's use. Refer to EN 60079-29-2.**

To perform a manual bump test refer to [Connecting the Gas Cylinder to the Detector on page 10](#) and the following steps 1-6. Follow this procedure when Bump Daily is enabled.

#### Note

*If performing a bump test on a pump unit, connect the calibration hose directly to the pump module.*

1. Connect the calibration hose to the 0.5l/min regulator on the gas cylinder.

#### Note

*Only use the calibration cap for bump tests and calibrations.*

2. Connect the calibration hose to the intake inlet on the calibration cap. Arrows on the calibration cap indicate the direction of gas flow.
3. Attach the calibration cap and tighten the knob.  
Refer to [Connecting the Gas Cylinder to the Detector on page 10](#).

#### Note

*Ensure the knob is securely fastened before applying gas. Do not overtighten the calibration cap. Ensure strong air currents are kept away from the exhaust side of the calibration cap, as this can affect the bump test accuracy.*

4. Apply gas. Verify the visual, audible, and vibrator alarms activate.
5. Close the regulator and remove the calibration cap from the detector. The detector will temporarily remain in alarm until the gas clears from the sensors.
6. Disconnect the calibration hose from the cap and regulator.

### Calibration

Calibrate only in a safe area in an atmosphere of 20.9% oxygen.

1. Activate the detector. To enter calibration, press and hold  $\odot$  and  $\blacktriangledown$  simultaneously. The detector beeps and flashes to the corresponding countdown. The LCD then displays **Starting calibration**.

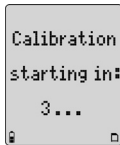

2. **AUTO-ZERO** flashes while the detector zeros all of the sensors (except CO<sub>2</sub>) and calibrates the oxygen sensor. If a sensor fails to auto zero, that sensor will bypass the span.

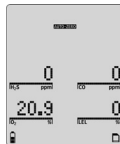

If calibrating a GasAlertMicro 5 or GasAlertMicro 5 PID, proceed to step #4.

#### Step #3 for Micro 5 IR Only

3. The **Zero CO2?** screen displays. Press  $\odot$  to zero the CO<sub>2</sub> sensor, or press  $\textcircled{+}$  to bypass.  
If  $\odot$  is pressed to zero the CO<sub>2</sub> sensor, the following screens display:
  - **Apply CO<sub>2</sub> zero gas now** (nitrogen must be used to zero the CO<sub>2</sub> sensor).
4. - The **Auto-Zero CO<sub>2</sub>** screen displays, and **AUTO-ZERO** flashes.

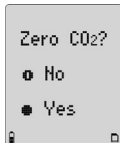

5. The following three screens display:

- **Apply span gas now to calibrate**
- or press  $\odot$  to select sensor(s)
- or press  $\textcircled{+}$  to skip calibration

If none of the buttons are pressed, proceed to step #6.

If  $\odot$  is pressed, proceed to step #5.

If  $\textcircled{+}$  is pressed, proceed to the end of step #7.

6. Select which sensor to span. Press  $\blacktriangle$  or  $\blacktriangledown$  to scroll to the required sensor and then press  $\odot$  to select. Sensors must be spanned in the following order:
  - Exotics (NH<sub>3</sub>, ClO<sub>2</sub>, O<sub>3</sub>, and CO<sub>2</sub>)
  - Single gases
  - Quad gases (H<sub>2</sub>S, CO, O<sub>2</sub> and LEL).

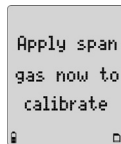

7. Attach the calibration cap and apply gas at a flow rate of 500 ml/min.

$\textcircled{+}$  flashes while the detector determines which gas is being applied.

After 30 seconds, **AUTO-SPAN** flashes and a countdown displays while the detector completes the span.

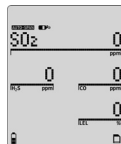
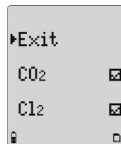

8. When the span is complete, the following three screens display:

- **Calibration successful**
- Press **▲** to apply a new cal gas
- Press **▼** to end span

Repeat steps #4-7 to calibrate the remaining sensors.

The LCD displays the following options:

- Press **○** to set the calibration due dates or press **Ⓢ** to bypass.

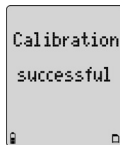

9. Press **▲** or **▼** to change the calibration due date. Press **○** to accept the value and proceed to the next due date. If a sensor fails or does not span, the calibration due date cannot be changed for that sensor.

The LCD displays the following options:

- Press **○** to change the calibration due dates or press **Ⓢ** to bypass.

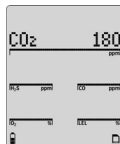

10. Press **▲** or **▼** to change the alarm setpoint. Press **○** to save the value and proceed to the next setpoint.

Define the remaining setpoints. The detector beeps twice when all of the alarm setpoints have been defined or bypassed.

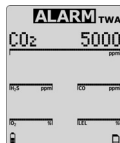

11. When calibration is complete, **Saving calibration** displays.

*Note*

*Only use the calibration cap and single gas calibration cap during calibration and bump tests.*

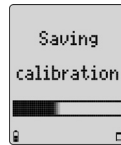

For additional information about performing calibrations and bump tests, refer to the *GasAlertMicro 5/PID/IR User Manual*.

**Alarms**

Refer to the following table for information about alarms and corresponding screens. During an alarm condition, the



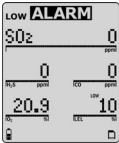
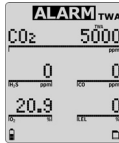
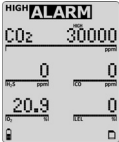
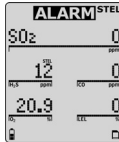

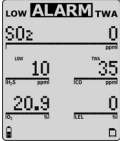
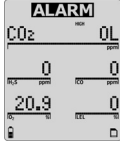
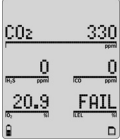
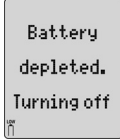
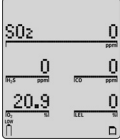
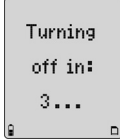
backlight activates and the LCD displays the ambient gas readings.

Alarm	Screen	Alarm	Screen
<p><b>Low Alarm</b></p> <ul style="list-style-type: none"> <li>• Fast beep</li> <li>• Slow flash</li> <li>• <b>ALARM</b> and target gas bar flash</li> <li>• Vibrator alarm activates</li> </ul>		<p><b>TWA Alarm</b></p> <ul style="list-style-type: none"> <li>• Fast beep</li> <li>• Slow flash</li> <li>• <b>ALARM</b> and target gas bar flash</li> <li>• Vibrator alarm activates</li> </ul>	
<p><b>High Alarm</b></p> <ul style="list-style-type: none"> <li>• Constant beep</li> <li>• Fast flash</li> <li>• <b>ALARM</b> and target gas bar flash</li> <li>• Vibrator alarm activates</li> </ul>		<p><b>STEL Alarm</b></p> <ul style="list-style-type: none"> <li>• Constant beep</li> <li>• Fast flash</li> <li>• <b>ALARM</b> and target gas bar flash</li> <li>• Vibrator alarm activates</li> </ul>	

Alarm	Screen	Alarm	Screen
<p><b>Multi Alarm</b></p> <ul style="list-style-type: none"> <li>Alternating low and high alarm beep and flash</li> <li><b>ALARM</b> and target gas bars flash</li> <li>Vibrator alarm activates</li> </ul>		<p><b>Over Limit (OL) Alarm</b></p> <ul style="list-style-type: none"> <li>Fast beep and flash</li> <li><b>ALARM</b> and target gas bar flash</li> <li>Vibrator alarm activates</li> </ul>	
<p><b>Sensor Alarm</b></p> <ul style="list-style-type: none"> <li><b>One beep every 15 seconds</b></li> <li><b>FAIL</b> flashes above the failed sensor</li> </ul>		<p><b>Automatic Deactivation Alarm</b></p> <ul style="list-style-type: none"> <li>Eight beeps and flashes</li> <li><b>LOW</b> displays</li> <li>Vibrator alarm temporarily activates</li> <li><b>Battery depleted screen</b> displays and the detector deactivates</li> </ul>	
<p><b>Low Battery Alarm</b></p> <ul style="list-style-type: none"> <li>One beep and two flashes every 25 seconds</li> <li><b>LOW</b> flashes</li> </ul> <p><b>⚠ Caution</b></p> <p>Charge the battery immediately when a low battery alarm occurs.</p>		<p><b>Normal Deactivation</b></p> <ul style="list-style-type: none"> <li>Three beeps and flashes</li> </ul>	

## GasAlertMicro 5/PID/IR

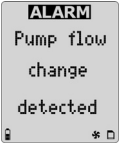
### Quick Reference Guide

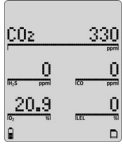
Alarm	Screen	Alarm	Screen
<p><b>Confidence Beep</b></p> <ul style="list-style-type: none"><li>One beep, one flash, and one vibration every 10 seconds</li></ul> <p><i>Note</i></p> <p><i>The Confidence Beep option is automatically disabled during a low battery alarm.</i></p>		<p><b>Pump Alarm</b></p> <ul style="list-style-type: none"><li>Screen flashes:<ul style="list-style-type: none"><li>Pump flow change detected</li><li>Check for blocked inlet</li><li>or press  to run a pump test</li></ul></li><li>Two fast beeps and alternating flashes</li><li>Vibrator alarm activates</li><li><b>ALARM</b> and  flash</li></ul>	
<p><b>MMC Fail Alarm</b></p> <ul style="list-style-type: none"><li>One beep every 5 seconds</li><li> flashes</li></ul>			

#### Note

If enabled, during an alarm condition the **Latch** (latching alarms) option causes the low and high gas alarms (audible, visual, and vibrator) to persist until the alarm is acknowledged by pressing  and the gas concentration is below the low alarm setpoint. The peak concentrations display continually until the alarm condition no longer exists. Local regulations may require the Latch option be enabled.

To comply with **European Regulations**, the **Latch** option must be enabled.



## User Options Menu

To access the user options, press and hold ▲ and ▼ simultaneously until the detector completes the countdown. To scroll through the options press ▲ or ▼. Press ○ to select the option. The following options are available.

**Exit:** Exits the user options menu.

### User Options:

- **Backlight (backlight):** Enables/disables the automatic backlight in low-light conditions.
- **Confibeep (confidence beep):** If enabled, the confidence beep provides continuous confirmation that the detector is operating correctly (audible beep every 10 seconds).
- **Due-lock (calibration user lockout):** If enabled, upon startup a passcode is required to operate a detector that is overdue for calibration.
- **Latch (latched alarm):** Enable to ensure an alarm persists until it is acknowledged (press ○ to acknowledge).
- **Passcode (passcode protection):** Enable to prevent unauthorized personnel from accessing the user options menu, calibration function, and alarm setpoint adjust function.
- **Safe (safe mode):** If enabled, Safe displays continuously on the LCD unless an alarm condition occurs.
- **Language:** Displays the LCD screens in **English**, **Français** (French), **Deutsch** (German), **Español** (Spanish), or **Português** (Portuguese).

#### Note

*The detector is shipped displaying English as the default language.*

### Sensors:

- **Sens on (sensor enabled):** Enables/disables a sensor (the detector continues to operate if a sensor is disabled).

### ⚠ Warning

**Use extreme caution when disabling a sensor. The disabled sensor cannot detect and alarm against the applicable gas.**

- **Span gas:** Define the span gas concentration for each sensor (must match the gas concentration on the gas cylinder).
- **Stel period (Short Term Exposure Limit):** The short term exposure limit (STEL) provides protection for workers from over exposure to high concentrations of gas, and is based on user-defined 5-15 minute intervals.  
When the maximum STEL is reached, the detector alarms to notify the worker. Set the STEL period from 5-15 minutes (applicable to toxic sensors only).
- **TWA method (Time Weighted Average):** This option is a safety measure that calculates the accumulated averages of gases to warn the worker when the maximum average has accumulated. Select one of the following options:
  - **OSHA Method:** 8 hour moving average—oldest value (first hour) is replaced by the newest value (ninth hour).
  - **ACGIH Method:** Infinite accumulated average to 8 hours - total accumulation, whether it is 2 hours or 8 hours.
- **Resolution:** Defines the resolution of the gas measurement as either regular or extra (if applicable).

- **%vol CO<sub>2</sub>**: Enable to display the carbon dioxide (CO<sub>2</sub>) reading as %vol.
- **%vol CH<sub>4</sub>**: Enable to display the LEL readings as %vol assuming a methane environment.

#### Note

*If changing the measurement unit from % LEL to % Vol. or from % Vol. to % LEL, a calibration must be completed and the alarm setpoints changed. For calibration information refer to [Calibration on page 16](#) and for alarm setpoint information refer to Alarm Setpoints in Calibration Procedure in the GasAlertMicro 5/PID/IR User Manual.*

- **Correction Factor (%)**: Enter a compensation factor for hydrocarbons other than methane. The factor can only be applied if the LEL sensor has been calibrated with methane (LEL only).
- **Autocal (automatic oxygen calibration)**: Enable/disable the detector to automatically calibrate the oxygen sensor during startup.

**Logger** (Datalogging): Define how often the detector records a datalog sample (once every 1 to 127 seconds).

**Clock**: Define the date and time for the detector.

## Maintenance

To maintain the detector in good operating condition, perform the following basic maintenance as required.

- Calibrate, bump test, and inspect the detector on a regular schedule.
- Maintain an operations log of all maintenance, bump tests, calibrations, and alarm events.
- Clean the exterior with a soft damp cloth. Do not use solvents, soaps, or polishes. Refer to [Sensor Poisons and Contaminants on page 4](#).
- Do not immerse the detector in liquids.

## **Replacing Battery Cells and Packs**

### **⚠ Warning**

To avoid personal injury and/or property damage, adhere to the following battery cautions:

- Replace the alkaline cells or rechargeable battery pack immediately when the detector emits a low battery alarm.
- Use only batteries that are recommended by BW Technologies by Honeywell.
- Use only approved alkaline batteries that are properly installed in the battery pack. Refer to Specifications.
- To order lithium battery packs (M5-BAT08/M5-BAT07), contact BW Technologies by Honeywell.
- Charge the batteries and battery packs using only a recommended BW charger. Failure to adhere to this caution can lead to fire and/or explosion.
- The detector must be deactivated to charge the battery pack.
- Do not calibrate the detector immediately after charging is complete.
- Both the lithium battery pack and the alkaline battery pack are user-changeable in hazardous locations, but the alkaline battery cells inside the pack can only be replaced in a safe area that is free of hazardous gas.
- **Warning:** The M5-BAT08 and M5-BAT07 battery packs are equipped with lithium batteries that can present a risk of fire or chemical burn hazard if misused. Do not recharge, disassemble, heat above 212°F (100°C), or incinerate.
- **Warning:** Do not use any other lithium batteries with the GasAlertMicro 5, GasAlertMicro 5 PID, and GasAlertMicro 5 IR detectors. Use of any other cell can cause fire and/or explosion.
- **Warning:** Lithium polymer cells exposed to heat at 266°F (130°C) for 10 minutes can cause fire and/or explosion.
- Dispose of used lithium cells immediately. Do not disassemble and do not dispose of in fire. Do not mix with the solid waste stream. Spent batteries must be disposed of by a qualified recycler or hazardous materials handler.
- Keep lithium cells away from children.

#### Replacing Alkaline Batteries

##### **⚠ Warning**

Always deactivate the detector before removing the battery pack. The battery packs are user-changeable in hazardous locations, but the alkaline battery cells inside the pack must be changed in a safe area that is free of hazardous gas.

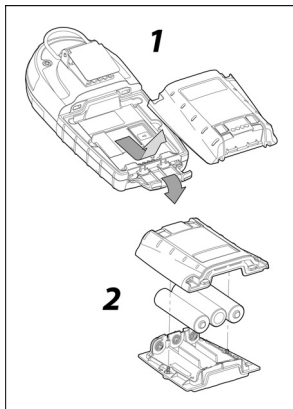

To charge the rechargeable battery pack, refer to the *GasAlertMicro 5/PID/IR Battery Charger User Manual*.

To replace the alkaline batteries, refer to the following procedures and illustration.

1. Press and hold  to deactivate the detector.
2. Open the latch on the bottom of the detector.
3. Remove the battery pack by lifting the bottom of the pack upward from the detector.
4. On the battery pack, unscrew the two captive screws and open.
5. Replace the three alkaline battery cells.
6. Replace the cover and reinsert the two captive screws.
7. Replace the battery pack on the detector.
8. Close the latch.

### **Replacing Lithium Battery Packs**

**⚠ Warning**

**Do not disassemble the lithium battery pack. Read and adhere to the cautions in [Replacing Battery Cells and Packs](#).**

To replace the lithium battery pack, refer to the following illustration and steps 1-4.

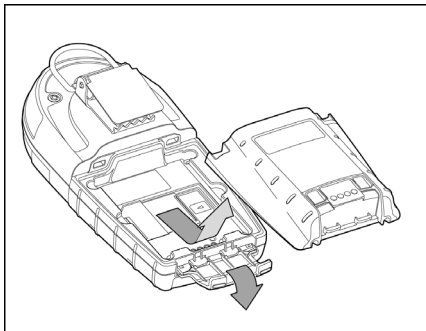

1. Press and hold ○ to deactivate the detector.
2. Open the latch on the bottom of the detector.
3. Remove the battery pack by lifting the bottom of the pack upward from the detector.
4. Replace the battery pack with a fully charged lithium battery pack.
5. Close the latch.

### **WEEE Directive and Battery Directive**

Failure to comply with the following battery removal and disposal instructions may result in battery shorting, battery leakage, and/or other damage. Ensure a qualified technician completes the following procedures.

### **Removal and Disposal of the Battery Pack**

Only a qualified technician should complete the following procedures.

To remove the alkaline batteries, refer to steps #1 to #4 in [Replacing Alkaline Batteries on page 24](#).

To remove the lithium battery pack, refer to steps #1 and #2 in [Replacing Lithium Battery Packs on page 25](#).

Dispose of the battery pack according to local laws.

## GasAlertMicro 5/PID/IR

### Quick Reference Guide

#### Removal and Disposal of the Coin Cell

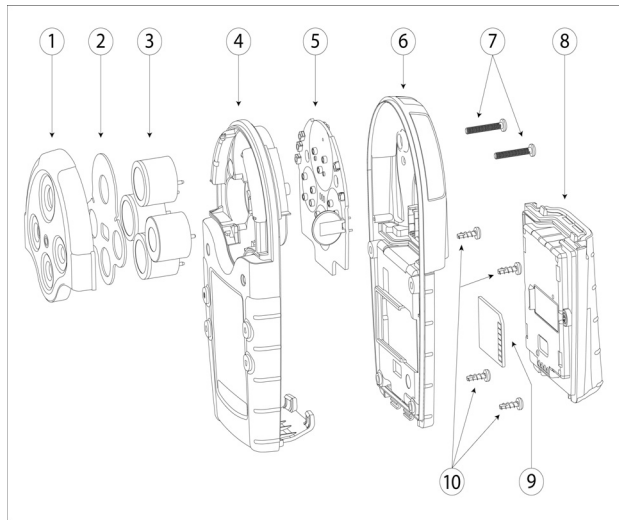

Item	Description
1	Diffusion cap
2	Sensor filter
3	Sensors
4	Front shell
5	Sensor board
6	Back shell
7	Machine screws (for diffusion cap)
8	Battery pack
9	Datalog card
10	Machine screws (for rear shell)

The detector contains a coin cell to power the real-time clock. Only a qualified technician should complete the following procedure.

1. Press and hold  to deactivate the detector.
2. Open the latch on the bottom of the detector.
3. Remove the battery pack by lifting the bottom of the pack upward from the detector.
4. Remove the MMC card.
5. Remove the two machine screws on the rear shell and then remove the diffusion cap or pump module.
6. Remove the sensors.
7. Remove the four machine screws in the battery pack cavity.
8. Remove the rear shell.
9. The coin cell sits on the sensor board.  
Gently remove the sensor board.
10. The coin cell is connected to the board by four leads.  
Clip the four leads individually to remove the coin cell.
11. Dispose of the coin cell according to local laws.

** Caution**

**Do not touch two or more leads while disconnecting the coin cell.**

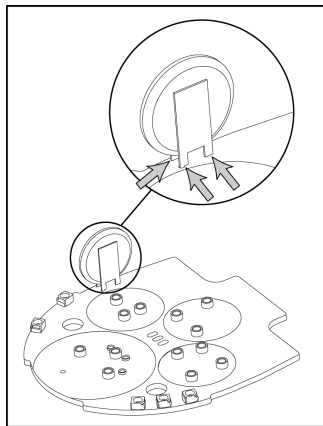

**Note**

*Image above shows three of the four battery leads that must be clipped.*

#### **Replacing a Sensor or Sensor Filter**

To replace a sensor or sensor filter, refer to the following illustration, table, and steps 1-7.

#### **⚠ Warning**

**To avoid personal injury and/or property damage, only use sensors that are specifically designed for the detector. Replace the sensors in a non-hazardous area.**

#### *Note*

*Detectors that are configured for 1, 2, or 3 gases may contain a dummy sensor in one of the four sensor locations.*

1. Deactivate the detector.
2. Remove the two machine screws on the rear shell and then remove the sensor cover or pump module cover.
3. Remove the sensor filter and/or sensor(s).
4. Insert the new filter and/or sensor(s). Ensure the sensor posts are aligned correctly.
5. Re-assemble the detector.
6. If the sensor is replaced with a different type of sensor (e.g. SO<sub>2</sub> to an H<sub>2</sub>S), the detector must be reconfigured. Refer to Sensors in the Tech Mode section of the *GasAlertMicro 5/PID/IR User Manual*.
7. Activate the detector and then calibrate the new sensor(s). Refer to [Calibration](#).



**Replacing the Pump Filter (Generation 2 Pump only)**

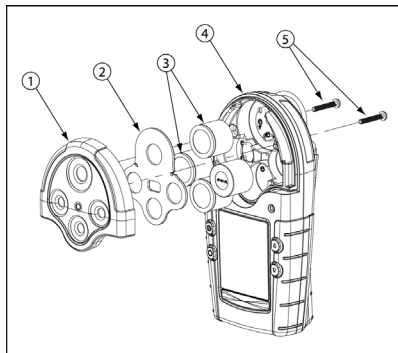

Item	Description
1	Sensor cover
2	Sensor filter
3	Sensors
4	Detector
5	Machine screws (2)

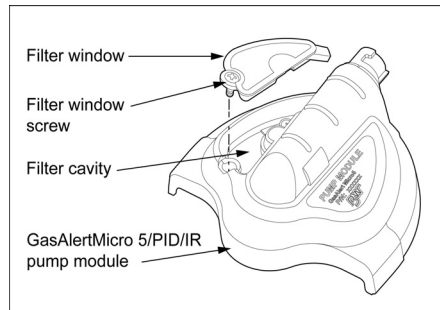

**Note**

*If replacing the pump filter on the Generation 1 pump, refer to the GasAlertMicro 5/PID/IR User Manual.*

1. Deactivate the detector.
2. Remove the filter window screw and the filter window.
3. Remove the old filter.
4. **Important!** Ensure the filter cavity and filter window are clean and free of debris. Insert a new filter.
5. Replace the filter window and screw.

**Replacing the Pump Nozzle (Generation 2 Pump only)**

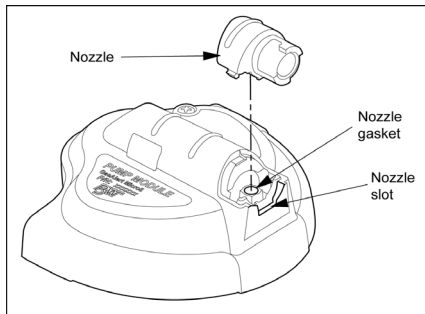

**Note**

*If the nozzle is damaged, replace it immediately to ensure accurate pump flow.*

*Only the Generation 2 pump has a replaceable nozzle.*

1. Deactivate the detector.
2. Gently insert a medium sized flathead screwdriver into the nozzle slot. Lift and remove the damaged nozzle.
3. Insert the new nozzle. Ensure the nozzle post inserts correctly into the nozzle gasket.

**Specifications**

**Instrument dimensions:** 14.5 x 7.4 x 3.8 cm  
(5.7 x 2.9 x 1.5 in.)

**Weight:** 370 g (13.1 oz.)

**Operating and storage conditions:**

**Operating Temperature:**

VOC: -10°C to +40°C (14°F to +104°F)<sup>1</sup>

Other gases: -20°C to +50°C (-4°F to +122°F)

Combustible gas sensor: Certified by CSA International to ±3% LEL accuracy from -10°C to +40°C (4°F to 104°F)

**Storage temperature:**

-25°C to +60°C

**Operating humidity:**

O<sub>2</sub>: 0% to 90%<sup>1</sup> relative humidity (non-condensing)

VOC: 0% to 95% relative humidity (non-condensing)

Combustibles: 5% to 95% relative humidity (non-condensing)

Cl<sub>2</sub>: 10% to 95% relative humidity (non-condensing)

HCN, ClO<sub>2</sub>: 15% to 90%<sup>1</sup> relative humidity (non-condensing)

Other gases: 15% to 90%<sup>1</sup> relative humidity (non-condensing)

**Pressure:** 95 to 110 kPa<sup>1</sup>

**Dust and moisture ingress:** IP65/66<sup>1</sup>

1. Standard release data. This product has extended characteristics. For specifications refer to EAC Ex certificate and Pattern Approval document

**Alarm setpoints:** May vary by region and are user-defined

**Detection range:**

O<sub>2</sub>: 0 - 30.0% vol. (0.1% vol. increments)<sup>1</sup>  
CO: 0 - 999 ppm (1 ppm increments)  
CO (TwinTox sensor): 0 - 500 ppm (1 ppm increments)  
H<sub>2</sub>S: 0 - 500 ppm (1 ppm increments)  
H<sub>2</sub>S TwinTox sensor: 0 - 500 ppm (1 ppm increments)  
Combustible (LEL): 0 - 100% LEL (1% LEL increments) or  
0 - 5.0% v/v methane; certified by CSA International to C22.2  
No. 152 and ISA 12.13.01 within 0 - 60% or 3.0% v/v methane  
PH<sub>3</sub>: 0 - 5.0 ppm (0.1 ppm increments)  
SO<sub>2</sub>: 0 - 150 ppm (1 ppm increments)  
Cl<sub>2</sub>: 0 - 50.0 ppm (0.1 ppm increments)  
NH<sub>3</sub>: 0 - 100 ppm (1 ppm increments)  
NO<sub>2</sub>: 0 - 99.9 ppm (0.1 ppm increments)  
HCN: 0 - 30.0 ppm (0.1 ppm increments)  
ClO<sub>2</sub>: 0 - 1.00 ppm (1.00 ppm increments)  
O<sub>3</sub>: 0 - 1.00 ppm (0.01 ppm increments)  
VOC: 0 - 1000 ppm (1.0 ppm increments)  
CO<sub>2</sub> IR: 0 - 50,000 ppm (50 ppm increments) or 0-5.0% v/v CO<sub>2</sub>

**(Sensors not certified for use with the GasAlertMicro 5 IR:  
ClO<sub>2</sub>, HCN, NO<sub>2</sub>, PH<sub>3</sub>, Cl<sub>2</sub>)**

**Sensor type:**

H<sub>2</sub>S/CO: Twin plug-in electrochemical cell  
Combustibles: Plug-in catalytic bead  
VOC: Photoionization detector (PID)  
CO<sub>2</sub>: IR detector  
Other gases: Single plug-in electrochemical cell

**O<sub>2</sub> measuring principle:** Capillary controlled concentration sensor

**Alarm conditions:** TWA alarm, STEL alarm, low alarm, high alarm, multi alarm, over limit (OL) alarm, sensor alarm, pump alarm, MMC/SD fail alarm, low battery alarm, confidence beep, automatic deactivation alarm

**Audible alarm:** 95 dB at 0.3 m (1 ft.) variable pulsed dual beepers

**Visual alarm:** Dual red light-emitting diodes (LEDs)

**Display:** Alphanumeric liquid crystal display (LCD)

**Backlight:** Activates briefly during startup, when there is insufficient light to view the display (if enabled), and during alarm conditions

**Self-test:** Initiated during activation

**Calibration:** Automatic zero and automatic span

**Oxygen sensor:** Automatic span during startup (if enabled)

**User field options:** Confidence beep, latching low and high alarms, passcode protection, enable/disable safe display mode, combustible sensor measurement, sensor enable/disable, language selection, enable/disable automatic O<sub>2</sub> calibration, set span concentration values, set STEL calculation period, set TWA method, gas measurement resolution, enable/disable automatic backlight, adjust clock/calendar, set datalogging rate (datalog models only), CO<sub>2</sub> sensor measurement

**Datalog Models:**

Approved for GasAlertMicro 5 and GasAlertMicro 5 PID  
Models: Delkin 128 MB SD card and 64 MB Unigen SD card

## GasAlertMicro 5/PID/IR

### Quick Reference Guide

---

**Approved for GasAlertMicro 5 IR Models:** Delkin 128 MB MMC, Delkin 128 MB SD card, Transcend 128 MB SD, and 64 MB Unigen SD card

**Battery operating time:**

**Toxic, O<sub>2</sub>, and LEL sensor configuration:** Three alkaline cells or one lithium battery pack at 20°C/68°F provides 20 hours operating runtime

**Toxic, O<sub>2</sub>, LEL, and PID sensor configuration:** Three alkaline cells or one lithium battery pack at 20°C/68°F provides 15 hours operating runtime

**Toxic, O<sub>2</sub>, LEL, and CO<sub>2</sub> sensor configuration:** Three alkaline cells or one lithium battery pack at 20°C/68°F provides 15 hours operating runtime

**Approved Batteries:**

**Approved batteries for GasAlertMicro 5, GasAlertMicro 5 PID, and GasAlertMicro 5 IR product:**

Alkaline (M5-BAT02): as per standards EN 60079-11, EN 60079-0, UL913, CSA C22.2 No. 157

Lithium-ion polymer (M5-BAT07), as per standards EN 60079-11, EN 60079-0, UL913, CSA C22.2 No. 157

Lithium-ion polymer (M5-BAT08): as per standards EN 60079-11, EN 60079-0, EN 60079-29-1, EN 50104, UL913, CSA C22.2 No. 157, EN 45544-1 and EN 45544-2.

**Rechargeable battery (M5-BAT08)      Temperature code**

Lithium polymer    -20°C ≤ Ta ≤ +50°C

T4

**Alkaline batteries<sup>1</sup>**

Duracell MN1500    -20°C ≤ Ta ≤ +50°C      T4 (129.9°C)

Energizer E91VP    -20°C ≤ Ta ≤ +50°C      T3C (135.3°C)

**Battery charger:** GasAlertMicro 5/PID/IR battery charger

**First-time charge:** Lithium 6 hours

**Normal charge:** Lithium 6 hours

**Warranty:** 2 years including sensors (1 year NH<sub>3</sub> sensor and PID lamp)

**Year of manufacture:** The detector's year of manufacture is determined from the serial number. The second and third number after the first letter determines the year of manufacture. Example: H311-001000 = 2011 year of manufacture.

**Approvals:**

**GasAlertMicro 5 and GasAlertMicro 5 PID (Zone 0):** Approved by CSA to both U.S. and Canadian Standards  
**Standards:** CAN/CSA C22.2 No. 157 and C22.2 152

ANSI/UL – 913 and ANSI/ISA – S12.13 Part 1

**ABS Type Approved:** VA-348169-X

<b>CSA</b>	Class I, Division 1, Group A, B, C, and D Class I, Zone 0, Group IIC
<b>ATEX</b>	CE 0539  II 1 G Ex da ia IIC Ga KEMA 06 ATEX 0206 EN 60079-0, EN 60079-1, EN 60079-11
<b>IECEx</b>	Ex da ia IIC Ga IECEx CSA 06.0011X IEC 60079-0, IEC 60079-1, IEC 60079-11

- 
1. Standard release data. This product has extended characteristics. For specifications refer to EAC Ex certificate and Pattern Approval document

<b>KTL</b>	12-KB4BO-0055X <sup>a</sup>
<b>Inmetro</b>	Ex ia IIC T4 Ga DNV 12.0138 X

a. <http://www.honeywellanalytics.com/~media/honeywell-analytics/products/gasalertmicro-5-series/documents/certifications/kc-certificate-gasalertmicro-550118920025.pdf?la=en>

### **GasAlertMicro 5 IR (Zone 1):**

Approved by CSA to both U.S. and Canadian Standards

**Standards:** CAN/CSA C22.2 No. 157 and C22.2 152  
ANSI/UL – 913 and ANSI/ISA – S12.13 Part 1

**ABS Type Approved:** VA-348169-X

<b>CSA</b>	Class I, Division 1, Group A, B, C, and D Class I, Zone 1, Group IIC
<b>ATEX</b>	CE 0539  II 2 G Ex d ia IIC Gb KEMA 06 ATEX 0206 EN 60079-0, EN 60079-1, EN 60079-11,
<b>IECEx</b>	Ex d ia IIC Gb IECEx CSA 06.0011X IEC 60079-0, IEC 60079-1, IEC 60079-11
<b>KTL</b>	12-KB4BO-0055X <sup>a</sup>
<b>Inmetro</b>	Ex d ia IIC T4 Gb DNV 12.0138 X

a. <http://www.honeywellanalytics.com/~media/honeywell-analytics/products/gasalertmicro-5-series/documents/certifications/kc-certificate-gasalertmicro-550118920025.pdf?la=en>

This equipment has been tested and found to comply with the limits for a Class B digital device, pursuant to Part 15 of the FCC Rules and ICES-003 Canadian EMI requirements. These limits are designed to provide reasonable protection against harmful interference in a residential installation. This equipment generates, uses and can radiate radio frequency energy and, if not installed and used in accordance with the instructions, may cause harmful interference to radio communications. However, there is no guarantee that interference will not occur in a particular installation. If this equipment does cause harmful interference to radio or television reception, which can be determined by turning the equipment off and on, the user is encouraged to try to correct the interference by one or more of the following measures:

- Reorient or relocate the receiving antenna.
- Increase the separation between the equipment and receiver.
- Connect the equipment into an outlet on a circuit different from that to which the receiver is connected.
- Consult the dealer or an experienced radio/TV technician for help.

## Information Required for European Regulations Compliance

Should the user wish to comply, the detector must be operated in the following manner.

**Daily bump test:** A bump test must be completed before each day's use.

**Condition of use:** The detector may only be used with the concussion-proof boot (GA-BM5-1 if it is a diffusion unit, or GA-BM5-2 if it is a pump unit).

**Stealth mode:** Stealth mode must be disabled.

**Latching alarms:** The latching alarm option must be enabled.

**Warm up time:** 60 seconds; ≤ 90 seconds for pump unit

**Stabilization time for methane sensor:** ≥ 120 seconds

**Stabilization time for oxygen sensor:** ≥ 120 seconds

**Methane response time  $t_{90}$ :** 10 seconds

**Oxygen response time  $t_{90}$ :** 15 seconds for oxygen deficiency

**Oxygen response time  $t_{90}$ :** 14 seconds for oxygen surplus

**Changing measurement range from % LEL to % Vol.:** If changing the measurement unit from % LEL to % Vol. or from % Vol. to % LEL, a calibration must be completed and the alarm setpoints changed. For calibration information refer to [Calibration on page 16](#) and for alarm setpoint information refer to Alarm Setpoints in Calibration Procedure in the *GasAlertMicro 5/PID/IR User Manual*.

**Effect of other toxic gases on the LEL sensor:** High concentrations of certain toxic gases, for example H<sub>2</sub>S, may have an adverse effect on the LEL sensor. This effect, known as inhibition, is usually temporary but in extreme circumstances can impair the sensitivity of the LEL sensor.

After any gas exposure that causes an alarm in the toxic gas sensors, the LEL sensor should be verified with a bump test, and recalibrated if necessary.

**Approved batteries for GasAlertMicro 5, GasAlertMicro 5 PID, and GasAlertMicro 5 IR product:** Lithium-ion polymer (M5-BAT08): as per standards EN 60079-11, EN 60079-0, UL913, CSA C22.2 No. 157

**General Use:** For use only in potentially explosive atmospheres where oxygen concentrations do not exceed 20.9% (v/v). Oxygen deficient atmospheres (<10% v/v) may suppress some sensor outputs.

**Tested Sensors**

<b>BW Part Number</b>	<b>Sensor Type</b>	<b>Manufacturer</b>	<b>Description</b>
BW 4COSH3	CO and H <sub>2</sub> S	City Technology Limited	City 4COSH CiTicel® rev.03
BW 4P-90 (USP 5601693)	LEL	City Technology Limited	CiTipel® 4P-90
Oxygen O <sub>2</sub> -A2	O <sub>2</sub>	Alphasense Ltd.	O <sub>2</sub> -A2 Oxygen Sensor

**Performance Data According to EN 45544 Part 1 and 2**

Target Gas	CO	H <sub>2</sub> S
Time of response	35s	17s
Time of recovery	33s	16s
Alarm response time	6s	4s
Zero variation	11 ppm (v/v)	1,3 ppm (v/v)
Overall uncertainty	8% of the measuring value	12%
Lower limit of measuring range	6 ppm (v/v)	0,7 ppm (v/v)*
Drift under zero gas (3 month)	1 ppm (v/v)	1 ppm (v/v)
Maximum calibration period under test conditions	3 month	3 month
(under operation conditions the calibration period may differ from value under test conditions)		
*Please Note: The configured dead band is 1.5 ppm (v/v) H <sub>2</sub> S		

**Troubleshooting**

If a problem persists, contact BW Technologies by Honeywell.



Problem	Possible Cause	Solution
<b>Startup Troubleshooting</b>		
The detector does not activate.	No batteries	Refer to <a href="#">Replacing Alkaline Batteries on page 24</a> or <a href="#">Replacing Lithium Battery Packs on page 25</a> .
	Depleted batteries	Refer to <a href="#">Replacing Alkaline Batteries on page 24</a> or <a href="#">Replacing Lithium Battery Packs on page 25</a>
	Damaged or defective detector	Contact BW Technologies by Honeywell
The detector immediately enters alarm mode when activated.	Sensor needs to stabilize	Used sensor: wait 60 seconds. New sensor: wait 5 minutes.
	Low battery alarm	Refer to cautions in <a href="#">Replacing Battery Cells and Packs on page 23</a> , <a href="#">Replacing Alkaline Batteries on page 24</a> , and <a href="#">Replacing Lithium Battery Packs on page 25</a> .
	Sensor alarm	Refer to <a href="#">Replacing a Sensor or Sensor Filter on page 28</a> .
	Pump alarm	If the sampling hose is attached, determine if it is obstructed. If not, clean or replace the pump filter. If the pump alarm persists, refer to the " <a href="#">Pump Operation Troubleshooting</a> " section in <a href="#">Troubleshooting on page 36</a> .



Problem	Possible Cause	Solution
The startup self-test fails.	General fault	Ensure that the sensors and battery pack are installed correctly and then reactivate the detector.  If the fault persists, record the error message and contact BW Technologies by Honeywell.
<b>Detector Operation Troubleshooting</b>		
Detector does not display normal ambient gas readings after startup self-test.	Sensor not stabilized	Used sensor: wait 60 seconds New sensor: wait 5 minutes
	Detector requires calibration	Calibrate the sensors. Refer to <a href="#">Calibration on page 16</a> .
	Target gas is present	Detector is operating properly. Use caution in suspect areas.
Detector does not respond to pushbuttons.	Batteries are depleted	Refer to cautions in <a href="#">Replacing Battery Cells and Packs on page 23</a> , <a href="#">Replacing Alkaline Batteries on page 24</a> , and <a href="#">Replacing Lithium Battery Packs on page 25</a> .
	Detector is performing operations that do not require user input	Pushbutton function restores automatically when the operation ends.

## GasAlertMicro 5/PID/IR

### Quick Reference Guide

Problem	Possible Cause	Solution
Detector does not accurately measure gas.	Detector requires calibration	Calibrate the sensors. Refer to <a href="#">Calibration on page 16</a> .
	Detector is colder/hotter than ambient gas	Allow the detector to adjust to ambient temperature before using.
	Sensor filter is blocked	Clean the sensor filter. Refer to <a href="#">Replacing a Sensor or Sensor Filter on page 28</a> .
<b>MMC/SD Card Troubleshooting</b>		
	The MMC/SD card is not inserted.	Insert the MMC/SD card. Refer to Inserting the MMC/SD Card in the <i>GasAlertMicro 5/PID/IR User Manual</i> .
	The MMC/SD card that is inserted in the detector has a storage size that is not supported by the detector.	Insert an approved MMC/SD card: <ul style="list-style-type: none"><li>• 128 MB Delkin MMC</li><li>• 128 MB Delkin SD card</li><li>• 128 MB Transcend SD card</li><li>• 64 MB Unigen SD card</li></ul>

Problem	Possible Cause	Solution
 <p>MMC/SD communica- tion error</p>	<p>The detector has lost communication with the MMC/SD card.</p>	<p>Retry communication</p> <p>Insert a new approved MMC or SD card. Refer to Inserting the MMC/SD Card in the <i>GasAlertMicro 5/PID/IR User Manual</i>.</p> <p>Reformat the MMC or SD card in windows and then reinsert into the detector.</p> <p>Contact BW Technologies by Honeywell.</p>
<b>Alarms Troubleshooting</b>		
<p>Detector does not enter alarm mode.</p>	<p>Alarm setpoint(s) are set incorrectly.</p>	<p>Reset alarm setpoints. Refer to <a href="#">Calibration on page 16</a></p>
	<p>Alarm setpoint(s) are set to zero.</p>	<p>Reset alarm setpoints. Refer to <a href="#">Calibration on page 16</a>.</p>
	<p>Detector requires calibration.</p>	<p>Calibrate the sensors. Refer to <a href="#">Calibration on page 16</a>.</p>
<p>Detector intermittently enters alarm without any apparent reason.</p>	<p>Ambient gas levels are near alarm setpoint or the sensor is exposed to a puff of the target gas.</p>	<p>Detector is operating normally. Use caution in suspect areas. Check MAX gas exposure reading.</p>
	<p>Alarms setpoints are set incorrectly.</p>	<p>Reset alarm setpoints. Refer to <a href="#">Calibration on page 16</a>.</p>
	<p>Missing or faulty sensor.</p>	<p>Refer to <a href="#">Replacing a Sensor or Sensor Filter on page 28</a>.</p>
<p>Detector enters alarm with LEL reading displaying as OL (over limit).</p>	<p>Pump flow rate is set too high.</p>	<p>Refer to the last solution in Pump Operation troubleshooting on the following page.</p>

## GasAlertMicro 5/PID/IR

### Quick Reference Guide

Problem	Possible Cause	Solution
<b>Automatic Deactivation Troubleshooting</b>		
Detector automatically deactivates.	Automatic shutdown activated because of weak batteries.	Refer to the <i>GasAlertMicro 5/PID/IR Charger Instruction Sheet</i> .
	Calibration is overdue and the <b>Due-lock</b> (calibration user lock-out) option is enabled.	Enter the password to enter calibration. Calibrate the sensor(s). Refer to <a href="#">Calibration on page 16</a> .
<b>Pump Operation Troubleshooting</b>		
	There is an obstruction in the tubing.	<a href="#">Generation 1: 116885-L3 (yellow) and 118933-L3 (black) on page 12</a> If using tubing that is attached to the sample probe, determine if it is obstructed. If not, replace the pump filter. Refer to the <i>GasAlertMicro 5/PID/IR User Manual</i> .
		<a href="#">Generation 2: 130916-L3* (yellow) and 130917-L3 (black) on page 12</a> If using tubing that is attached to the sample probe, determine if it is obstructed. If not, clean or replace the pump filter. Refer to <a href="#">Replacing the Pump Filter (Generation 2 Pump only) on page 29</a>
	Filter needs to be replaced.	<a href="#">Generation 1: 116885-L3 (yellow) and 118933-L3 (black) on page 12</a> If using tubing that is attached to the sample probe, determine if it is obstructed. If not, replace the pump filter. Refer to the <i>GasAlertMicro 5/PID/IR User Manual</i> .  <a href="#">Generation 2: 130916-L3* (yellow) and 130917-L3 (black) on page 12</a> If using tubing that is attached to the sample probe, determine if it is obstructed. If not, clean or replace the pump filter. Refer to <a href="#">Replacing the Pump Filter (Generation 2 Pump only) on page 29</a> .

<b>Problem</b>	<b>Possible Cause</b>	<b>Solution</b>
<b>Clock Errors Troubleshooting</b>		
Clock icon is flashing.	The clock has failed.	Contact BW Technologies by Honeywell.
	There is communication failure.	Contact BW Technologies by Honeywell.
The detector displays a clock error message using last recorded time.	General fault.	Reactivate the detector. If the same error message displays, reset the clock in the user options menu. Reactivate the detector. If the error message still displays, contact BW Technologies by Honeywell.

## Replacement Parts and Accessories

### ⚠ Warning

To avoid personal injury and/or damage to the detector, use only the specified replacement parts.

To order parts or accessories, contact BW Technologies by Honeywell.

**Table 3. Replacement Parts and Accessories**

Model No.	Description	Qty
<b>Sensors</b>		
SR-B04	Carbon dioxide (CO <sub>2</sub> ) sensor	1
SR-Q07	PID sensor	1
D4-RHM04	TwinTox CO/H <sub>2</sub> S sensor	1
PS-RH04S	Hydrogen sulfide (H <sub>2</sub> S) sensor	1
PS-RM04	Carbon monoxide (CO) sensor	1
PS-RS04	Sulfur dioxide (SO <sub>2</sub> ) sensor	1
PS-RC10	Chlorine (Cl <sub>2</sub> ) sensor	1
PS-RZ10	Hydrogen cyanide (HCN) sensor	1
PS-RD04	Nitrogen dioxide (NO <sub>2</sub> ) sensor	1
SR-A04	Ammonia (NH <sub>3</sub> ) sensor	1
SR-P04	Phosphine (PH <sub>3</sub> ) sensor	1
SR-X10-C1	Oxygen (O <sub>2</sub> ) sensor	1
SR-G04	Ozone (O <sub>3</sub> ) sensor	1

Model No.	Description	Qty
SR-V04	Chlorine dioxide (ClO <sub>2</sub> ) sensor	1
SR-W04	Combustible (LEL) sensor (with silicone protection filter)	1
SR-W04-UF	Combustible (LEL) sensor (no silicone protection filter)	1
SR-DUMM1	Dummy sensor 3-pin O <sub>2</sub> or TwinTox	1
SR-DUMM2	Dummy sensor for LEL location	1
SR-DUMM3	Dummy sensor for PID location	1
<b>Sensor Replacement Parts and Accessories</b>		
RL-PID10.6	Lamp for PID sensor	1
M5PID-ES-1	Electrode stack for PID sensor	2
M513PID-CLN-K1	Cleaning kit for PID sensor lamp	1
M5-SS	Sensor filters (quad) kit of 2	1
<b>Gas Cylinders</b>		
REG-0.5	Regulator (0.5 l/min)	1
CG-Q58-4	Quad calibration gas, CH <sub>4</sub> -2.5%, O <sub>2</sub> -18.0%, H <sub>2</sub> S-25 ppm, CO-100 ppm, bal. N <sub>2</sub> (58 l)	1
CG-Q34-4	Quad calibration gas, CH <sub>4</sub> -2.5%, O <sub>2</sub> -18.0%, H <sub>2</sub> S-25 ppm, CO-100 ppm, bal. N <sub>2</sub> (34 l)	1

**GasAlertMicro 5/PID/IR**  
Replacement Parts and Accessories

Model No.	Description	Qty
CG-2-JX-34	Two gas calibration cylinder, 50% LEL (CH <sub>4</sub> -2.5%) O <sub>2</sub> -20.9%, bal. N <sub>2</sub> (34 l)	1
CG2-C-5-58	Calibration gas, Cl <sub>2</sub> 5 ppm (58 l)	1
CG2-M-100-103	Calibration gas, CO 100 ppm (103 l)	1
CG2-Z-10-58	Calibration gas, HCN 10 ppm (58 l)	1
G0042-H25	Calibration gas, H <sub>2</sub> S 25 ppm, (58 l)	1
CG2-D-10-58	Calibration gas, NO <sub>2</sub> 10 ppm (58 l)	1
CG2-P-1-34	Calibration gas, PH <sub>3</sub> 1 ppm (34 l)	1
CG2-S-25	Calibration gas, SO <sub>2</sub> 25 ppm (58 l)	1
CG-BUMP1	Bump alarm gas aerosol (CH <sub>4</sub> -2.5%, O <sub>2</sub> -10%, H <sub>2</sub> S-40 ppm, CO-200 ppm)	1
CG-BUMP-H25	H <sub>2</sub> S bump test gas	1
<b>GasAlertMicro 5/PID/IR Alkaline Battery Packs</b>		
M5-BAT0501	Alkaline battery pack (yellow)	1
M5-BAT0502	Alkaline battery pack with European screw (yellow)	1
<b>GasAlertMicro 5/PID/IR Lithium Battery Packs</b>		
M5-BAT08	Lithium rechargeable battery pack (yellow)	1
M5-BAT08B	Lithium rechargeable battery pack (black)	
<b>GasAlertMicro 5/PID/IR Chargers and Kits</b>		

Model No.	Description	Qty
M5-C01*	GasAlertMicro 5 battery charger	1
M5-C01-BAT08*	GasAlertMicro 5 Lithium battery charger and battery pack kit	1
GA-V-CHRG4	Vehicle GasAlertMicro 5 battery charger	1
M5-BL-1	Battery latch replacement	1
<b>Datalogger Accessories</b>		
CR-MMC-USB1	USB memory card reader	1
M5-MMCD	Multimedia card	1
<b>Accessories</b>		
M5-PUMP	Motorized Pump Module Kit	1
M5-TC-1	Calibration cap and hose	1
GA-AG-2	Alligator clip (stainless steel)	1
GA-CH-2	Chest harness	1
GA-ES-1	Extension strap	1
GA-HM5	Belt holster	1
GA-BM5-1	Concussion-proof boot, diffusion unit	1
GA-BM5-2	Concussion-proof boot, pump unit	1
<b>Replacement Parts</b>		
M5-AF-K2	Pump replacement filters (kit of 5)	1
M5-AF-K2-100	Pump replacement filters (kit of 100)	1

\* Add suffix (-UK) for United Kingdom mains plug, (-EU) for European mains plug, (-AU) for Australian mains plug.

**Wear yellow. Work safe.**

50105442-036 EN-L

English

©BW Technologies 2017. All rights reserved