



INSTRUMENTS

GX-6000 Data Logger Management Program Operator's Manual

Part Number: 71-0383

Revision: E

Released: 4/8/19

Warranty

RKI Instruments, Inc. warrants gas alarm equipment sold by us to be free from defects in materials and workmanship, and performance for a period of one year from date of shipment from RKI Instruments, Inc. Any parts found defective within that period will be repaired or replaced, at our option, free of charge. This warranty does not apply to those items which by their nature are subject to deterioration or consumption in normal service, and which must be cleaned, repaired, or replaced on a routine basis. Examples of such items are:

Absorbent cartridges

Batteries

Pump diaphragms and valves

Filter elements

Fuses

Warranty is voided by abuse including mechanical damage, alteration, rough handling, or repairs procedures not in accordance with the instruction manual. This warranty indicates the full extent of our liability, and we are not responsible for removal or replacement costs, local repair costs, transportation costs, or contingent expenses incurred without our prior approval.

This warranty is expressly in lieu of any and all other warranties and representations, expressed or implied, and all other obligations or liabilities on the part of RKI Instruments, Inc. including but not limited to the warranty of merchantability or fitness for a particular purpose. In no event shall RKI Instruments, Inc. be liable for indirect, incidental, or consequential loss or damage of any kind connected with the use of its products or failure of its products to function or operate properly.

This warranty covers instruments and parts sold to users only by authorized distributors, dealers, and representatives as appointed by RKI Instruments, Inc.

We do not assume indemnification for any accident or damage caused by the operation of this gas monitor and our warranty is limited to replacement of parts or our complete goods.

Table of Contents

Introduction	5
System Requirements	6
Installing the GX-6000 Data Logger Management Program	6
IrDA Downloading Cable	8
Installing an IrDA Adapter Cable	8
Windows® Infrared Operation Note.....	9
Launching the Program	11
Control Buttons	12
Download Button	12
Instrument Information Button	13
Data Button	14
Last Calibration Button	16
Set Button	17
Accessing a Common Database	18
Downloading Data from an Instrument	22
GX-6000 Data Logging Capacity	27
Overwriting Data in the GX-6000	27
Viewing, Printing, Exporting & Deleting Data in the Data Window	28
Bump Test Data.....	30
Calibration History	34
Event Data	38
Snap Log Data	42
<i>Normal Operation Snap Log Data</i>	42
<i>Leak Check Snap Log Data</i>	45
Interval Trend Data	48
Alarm Trend Data	55
Deleting Data in the Data Window	61
Changing the Password	64

Last Calibration Window	66
Effects of BUMP DISP Parameter Setting on Appearance of Last Calibration Window	66
Viewing & Printing Last Calibration Data	68
<i>Need Calibration/Need Bump Test View Option</i>	68
<i>Calibration Date/Bump Test Date View Option</i>	71
<i>Calibration Record/Bump Test Record View Option</i>	72
Deleting Last Calibration Data	73
Set Window	75
Changing Instrument Parameters	75
Detail Settings Button	77
<i>Directly Editing Station and User ID Lists</i>	79
<i>Updating Station and User ID Lists Using CSV Files</i>	80
<i>Importing CSV Files</i>	83
Changing the Appearance of the Program Screens	85
Instrument Power Off	87
Spare Parts List	88

CAUTION: *Read and understand this manual before using the GX-6000 Data Logger Management Program. Also read and understand the GX-6000 Operator's Manual included with the GX-6000 portable gas detection unit.*

Introduction

Using an advanced detection system consisting of up to six gas sensors, the GX-6000 Personal Gas Monitors detects the presence of combustible gases, oxygen (O₂), carbon monoxide (CO), and hydrogen sulfide (H₂S) and various other toxic gases simultaneously. The compact size and easy-to-use design make them ideally suited for a wide range of applications as described in the GX-6000 Operator's Manual. Please read the GX-6000 Operator's Manual first before using the GX-6000 Data Logger Management Program.

The GX-6000 Data Logger Management Program downloads stored data in the GX-6000 to a Windows-based PC. After the data has been downloaded, you can view, save, or print it using your computer and the GX-6000 Data Logger Management Program.

The purpose of this manual is to explain how to use and set up the GX-6000 Data Logger Management Program. You will learn how to:

- install and launch the software
- install the downloading cable (if needed)
- access and store data in a common database
- download data from the GX-6000
- view, print, and save data
- change data logging parameters
- create user and station IDs
- change the appearance of the program screens
- change the color of graphed readings for a particular gas

Before you get started, be sure to review the system requirements in the next section.

CAUTION: *The GX-6000 unit detects oxygen deficiency and elevated levels of oxygen, combustible gases, carbon monoxide, and hydrogen sulfide, all of which can be dangerous or life threatening. When using the GX-6000, you must follow the instructions and warnings in the GX-6000 Operator's Manual to assure proper and safe operation of the unit and to minimize the risk of personal injury.*

CAUTION: *The operator of this instrument is advised that if the equipment is used in a manner not specified in this manual, the protection provided by the equipment may be impaired.*

System Requirements

To use the GX-6000 Data Logger Management Program, your personal computer must meet the following requirements:

- **Operating Systems:** Windows[®] 7, Windows[®] 8, or Windows[®] 10
- **Processor:** IBM[®] compatible PC running Pentium[®] 2 or higher.
- **Memory:** 32 MB RAM minimum
- **Available Hard Disk Space:** 32 MB minimum
- Infrared port or
USB port and a USB/IrDA adapter cable

Installing the GX-6000 Data Logger Management Program

1. Launch Windows[®].
2. Exit from all applications and open windows.
3. Go to www.rkiinstruments.com/gx6000.
4. Click on the **Download** tab.
5. Click the **GX-6000 Datalogging Program** link.
6. A .zip file will begin to download. Select whether you want to open or save the .zip file.
7. Extract the contents of the .zip file.
8. Double click the **setup.exe** file.

9. After a few seconds, a screen appears indicating that the InstallShield Wizard is preparing to install the Data Logger Management Program, then the GX-6000 InstallShield Wizard window appears to guide you through installation.

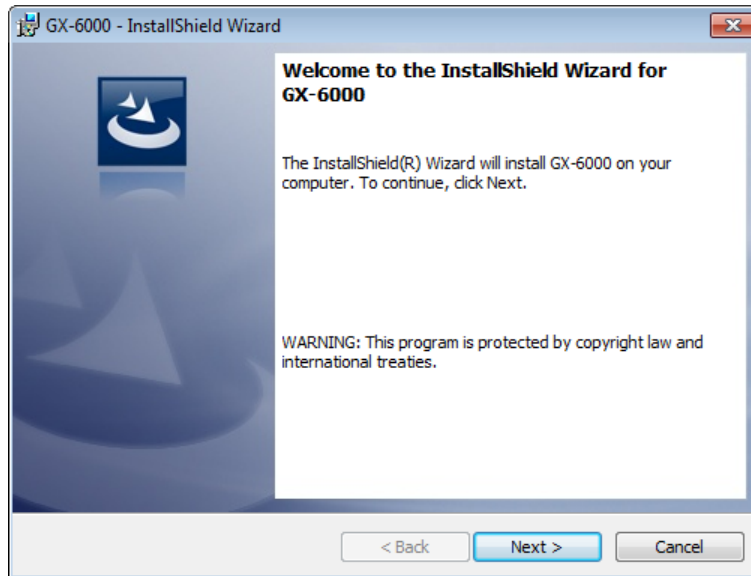

Figure 1: GX-6000 Data Logger Management Program Installation

10. Follow the on-screen instructions in the InstallShield Wizard Window to install the program.
11. If the InstallShield Wizard finds versions of Windows® files on your computer newer than those in the downloaded .zip file, it will ask you if you want to keep these newer files. Click **Yes**.
12. When the InstallShield Wizard indicates that installation is complete, click the **Finish** button.

IrDA Downloading Cable

The instrument communicates with a computer via an on-board infrared communication port that complies with IrDA 1.1 protocol standards.

NOTE: If your computer has a built-in infrared port that complies with IrDA 1.1 protocol, you do not need an adapter cable to download data.

If your computer does not have an infrared port, you will need to install an IrDA 1.1 compliant IrDA/USB adapter cable on your computer to use the GX-6000 Data Logger Management Program with your instrument. An IrDA/USB cable is available from RKI Instruments, Inc. See the Spare Parts List at the end of this manual for the RKI part number.

Some versions of Windows[®] already have several infrared device drivers loaded in Windows[®] and will automatically recognize a cable during the installation process and guide you in installing the drivers. Other versions of Windows[®] will require you to load device drivers provided by the manufacturer of the cable during the installation process. RKI makes no warranty for the operation or compatibility of the drivers with any particular device.

Installing an IrDA Adapter Cable

After installing the GX-6000 Data Logger Management Program, you must install the driver for the IrDA/USB adapter cable. Make sure the cable driver is compatible with your Windows[®] operating system.

NOTE: Do not plug in the IrDA/USB adapter cable into your computer before installing the driver.

Follow the manufacturer's instructions for installing the cable on your computer. If you do not have instructions from the cable manufacturer for installing your cable, see your Windows documentation. In general, you must go to the Control Panel and use the Add Hardware Wizard to install the cable drivers.

Windows® Infrared Operation Note

When using an IrDA adapter cable and the GX-6000 Data Logger Management Program on a Windows® computer, it is necessary to make a special setting in the Wireless Link Configuration window for proper communication between the instrument and the GX-6000 Data Logger Management Program. This must be done before attempting to use the program.

NOTE: If you have a Windows 7 computer, the Infrared Configuration window may not appear. If the Infrared Configuration window does not appear, disregard the directions below.

Follow these steps to make this setting:

1. Click **Start** on the Windows® Icon Tray.
2. If **Control Panel** is available to select in the **Start** menu, select it. The Control Panel will appear.

If **Control Panel** is not selectable in the Start menu but **Settings** is, select **Settings**, then select **Control Panel**. The Control Panel will appear.

3. If the Control Panel is viewed by category, open the **Hardware and Sound** folder then click "Send or Receive a File" under the **Infrared** section. The Infrared Configuration window will appear.

If the Control Panel is viewed by icon, click the **Infrared** icon. The Infrared Configuration window will appear.

4. Click on the Image Transfer tab.

5. Deselect the selection box for “Allow digital cameras to use infrared to transfer images directly to my computer”.

Deselect

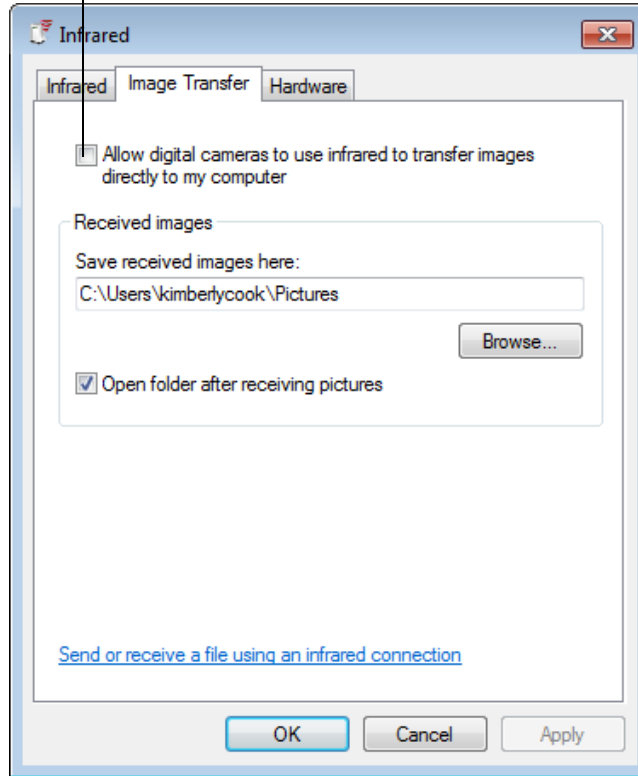

Figure 2: Image Transfer Tab

6. Click **OK**.
7. Close the Control Panel window.

Launching the Program

1. For Windows[®] 7 computers, click the **Start** icon in the Windows[®] Icon Tray, then select **Programs**, then select **GX-6000**. Your operating system may also have a shortcut installed in the **Start** menu.

For Windows[®] 8 and Windows[®] 10 computers, click the **Start** icon in the Windows[®] Icon Tray, then click the downward-pointing arrow icon in the lower left corner of the screen, then select **GX-6000** from the list of apps.

2. The program will launch and the Download window will appear. For more convenient viewing, the window can be enlarged by clicking and dragging the edges.

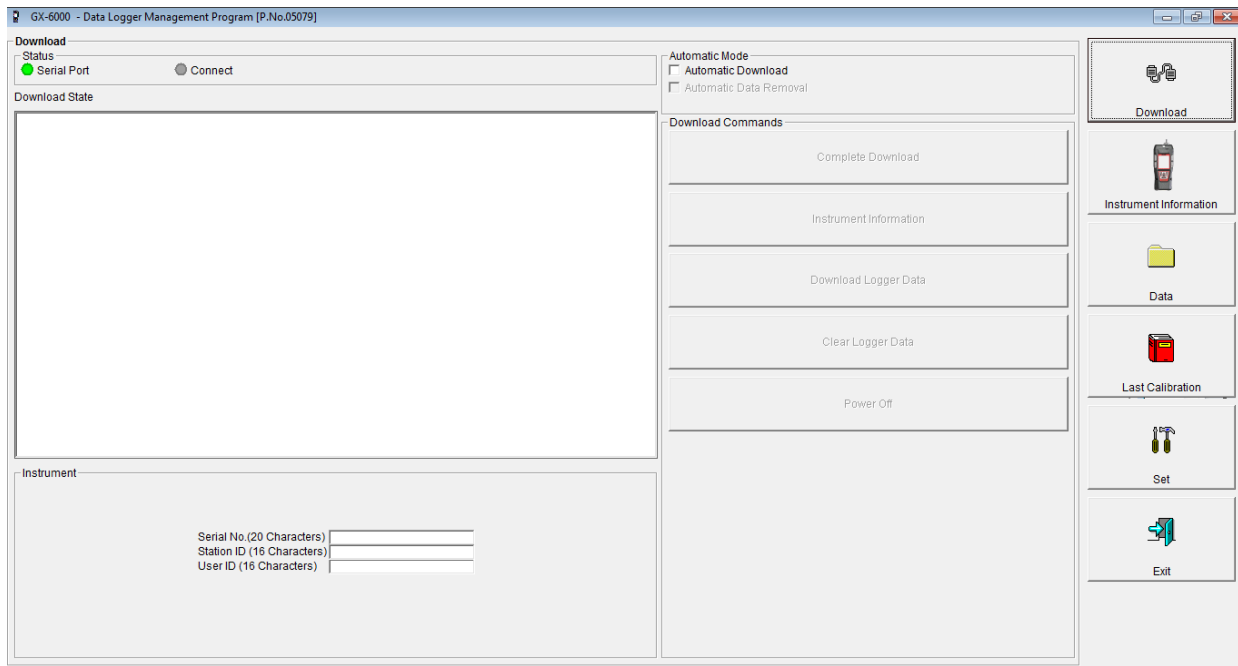

Figure 3: The Download Window

3. For convenience, make a shortcut of the GX-6000 Data Logger Management Program and place it on the Windows[®] desktop. See your Windows[®] documentation for information about making shortcuts.

Control Buttons

This section provides an overview of the control buttons. Instructions for using the various parts of the program accessed by the control buttons are given in other parts of this manual.

When the program is launched, it opens in the Download Window. Along the right side of the Download Window are six control buttons that access other windows in the program. The figure below shows the various windows that you can access when you click the control buttons.

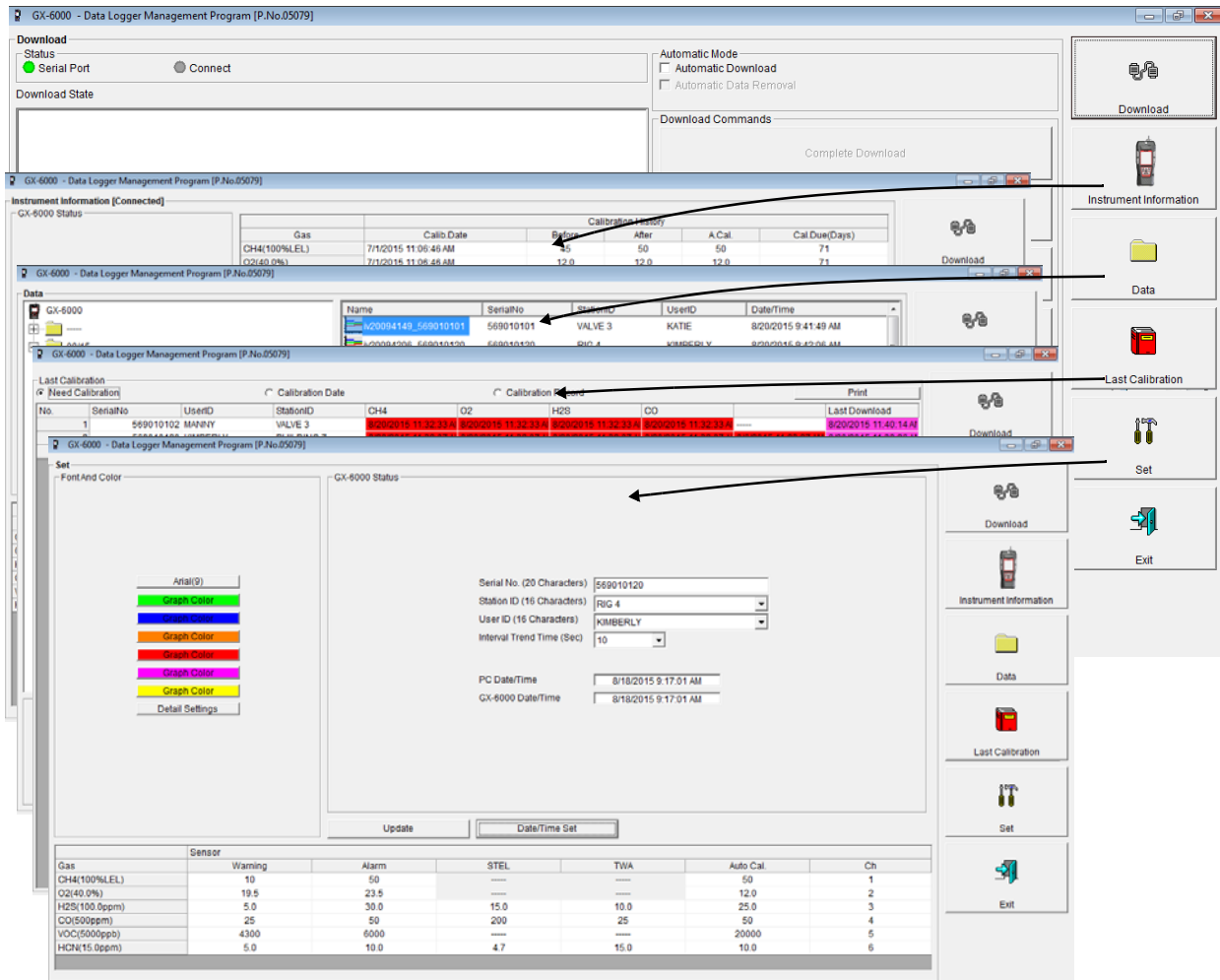

Figure 4: Windows Accessed by Control Buttons

Download Button

If you are in another program window, clicking the **Download** button opens the Download Window (see Figure 3). The Download window has several download commands that allow you to perform various data retrieval functions with an instrument that is connected to the software. Data can be retrieved from the instrument, data can be cleared from the instrument, and

the instrument can be turned off. See “Downloading Data from an Instrument” on page 22 for a complete description of downloading data from an instrument.

Instrument Information Button

Clicking the **Instrument Information** button opens the Instrument Information Window.

Instrument Information [Connected]
GX-6000 Status

Serial No. (20 Characters)
559010120

Station ID (16 Characters)
RIG 4

User ID (16 Characters)
KIMBERLY

Gas	Calib.Date	Calibration History			
		Before	After	A.Cal.	Cal.Due(Days)
CH4(100%LEL)	7/1/2015 11:06:46 AM	45	50	50	71
O2(40.0%)	7/1/2015 11:06:46 AM	12.0	12.0	12.0	71
H2S(100.0ppm)	7/1/2015 11:06:46 AM	24.0	25.0	25.0	71
CO(500ppm)	7/1/2015 11:06:46 AM	51	50	50	71
VOC(600.0ppm)	7/1/2015 11:08:22 AM	949.0	1000.0	100.0	71
HCN(15.0ppm)	7/1/2015 11:10:01 AM	10.0	10.0	10.0	71

Gas	Warning and Alarm point			
	Warning	Alarm	STEL	TWA
CH4(100%LEL)	10	50	----	----
O2(40.0%)	19.5	23.5	----	----
H2S(100.0ppm)	5.0	30.0	15.0	10.0
CO(500ppm)	25	50	200	25
VOC(600.0ppm)	4000.0	6000.0	600.0	420.0
HCN(15.0ppm)	5.0	10.0	4.7	15.0

Download

Instrument Information

Data

Last Calibration

Set

Exit

Figure 5: Instrument Information Window

The Instrument Information Window displays various instrument parameters for an instrument that has been downloaded using the **Complete Download** or **Instrument Information** download commands and is currently connected to the program. If an instrument is turned off after being connected to the program, then the program will lose the connection with the instrument and the fields in the Instrument Information Window will become empty.

Data Button

Clicking the **Data** button opens the Data Window.

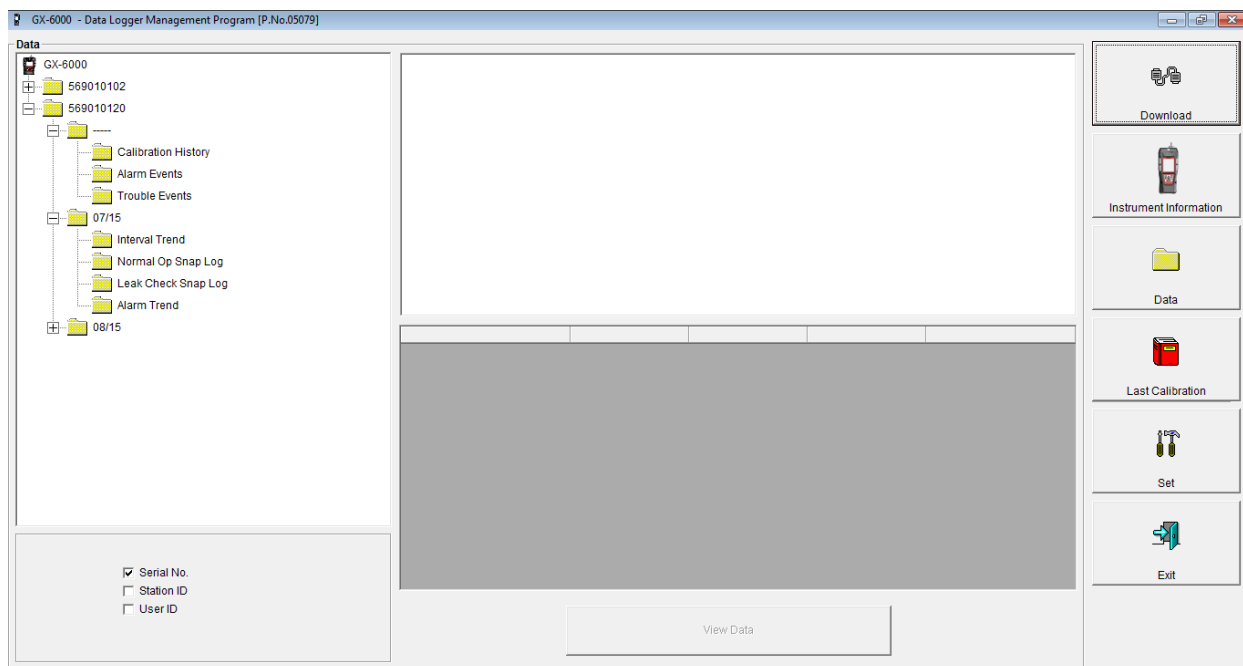

Figure 6: Data Window

In the Data Window, you can view, print, export, and delete data that has been downloaded from instruments.

NOTE: If the GX-6000 Data Logger Management Program database is on the user's computer (default setting), data will only appear for instruments downloaded to that computer. If the database is on a network, data will appear for all instruments downloaded to that database. See "Accessing a Common Database" on page 18 for more instruction.

The following types of data files are saved in the Data window:

- Bump Test Files

A bump test file is saved for each instrument that has been downloaded. It records the bump test information for every bump test that was downloaded. The instrument can save information for up to 100 bump tests and calibrations combined in its memory.

- **Calibration History Files**
A calibration history file is saved for each instrument that has been downloaded. It records the calibration information for every calibration that was downloaded. The instrument can save information for up to 100 bump tests and calibrations in its memory.
- **Alarm Event Files**
Alarm event files record gas alarm events that have been downloaded from instruments. The instrument can save up to 100 alarm events in its memory.
- **Trouble Event Files**
Trouble event files record sensor failure and system failure events that have been downloaded from instruments. The instrument can save up to 100 trouble events in its memory.
- **Interval Trend Data Files**
Interval trend data is logged at the interval time defined in the instrument. Each logged point is an average reading over the previous time interval.
- **Normal Operation Snap Log Files**
Normal operation snap log files contain gas reading information that was taken in Snap Log Mode in Normal Operation. A station ID is associated with each snap log.
- **Leak Check Operation Snap Log Files**
Leak check operation snap log files contain gas reading information that was taken in Snap Log Mode in Leak Check Operation. A station ID is associated with each snap log.
- **Alarm Trend Data Files**
Alarm trend data is logged around an alarm event. The instrument can save up to 8 alarm trend data files in its memory.

Last Calibration Button

Clicking the **Last Calibration** button opens the Last Calibration Window.

NOTE: The setting of the **BUMP DISP** instrument parameter affects whether the Bump Test portion of the Last Calibration Window is shown. For further explanation of the **BUMP DISP** parameter as it pertains to the Last Calibration Window, see “Effects of BUMP DISP Parameter Setting on Appearance of Last Calibration Window” on page 66.

The screenshot shows two windows from the GX-6000 Data Logger Management Program. The top window is titled "Last Calibration" and has a sub-header "Need Calibration". It contains a table with the following data:

No.	SerialNo	UserID	StationID	CH4	O2	H2S	CO	Last Download
1	569010102	MANNY	VALVE 3	8/20/2015 12:34:22 F	8/20/2015 12:34:22 F	8/20/2015 12:34:22 F	8/20/2015 12:34:22 F	8/21/2015 8:48:13 AM
2	569010101	KATIE	VALVE 3	8/20/2015 12:33:23 F	8/20/2015 12:33:23 F	8/20/2015 12:33:23 F	8/20/2015 12:33:23 F	8/20/2015 12:44:09 P
3	569010120	KIMBERLY	BUILDING 7	8/20/2015 12:32:23 F	8/20/2015 12:32:23 F	8/20/2015 12:32:23 F	8/20/2015 12:32:23 F	8/6/2015 11:23:27 AM

The bottom window is titled "Last Bump Test" and has a sub-header "Need Bump Test". It contains a table with the following data:

No.	SerialNo	UserID	StationID	CH4	O2	H2S	CO	Last Download
1	569010102	MANNY	VALVE 3	8/20/2015 12:34:22 F	8/20/2015 12:34:22 F	8/20/2015 12:34:22 F	8/20/2015 12:34:22 F	8/21/2015 8:48:13 AM
2	569010101	KATIE	VALVE 3	8/20/2015 12:33:23 F	8/20/2015 12:33:23 F	8/20/2015 12:33:23 F	8/20/2015 12:33:23 F	8/20/2015 12:44:09 P
3	569010120	KIMBERLY	BUILDING 7	8/20/2015 12:32:23 F	8/20/2015 12:32:23 F	8/20/2015 12:32:23 F	8/20/2015 12:32:23 F	8/6/2015 11:23:26 AM

Figure 7: Last Calibration Window

The Last Calibration Window stores the information for the most recent successful calibration and for the most recent successful bump test for each instrument that has been downloaded. Calibration data is displayed in the top part of the screen while bump test data is displayed in the bottom part. You can display the information three ways by using the Need Calibration/Need Bump Test, Calibration Date/Bump Test Date, or Calibration Record/Bump Test Record selection buttons. You can also print the information if you select the Need Calibration/Need Bump Test or Calibration Date/Bump Test Date display options.

Set Button

Clicking the **Set** button opens the Set Window.

Gas	Sensor	Warning	Alarm	STEL	TWA	Auto Cal.	Ch
CH4(100%LEL)		10	50	----	----	50	1
O2(40.0%)		19.5	23.5	----	----	12.0	2
H2S(100.0ppm)		5.0	30.0	15.0	10.0	25.0	3
CO(500ppm)		25	50	200	25	50	4
VOC(5000ppb)		4300	6000	----	----	20000	5
HCN(15.0ppm)		5.0	10.0	4.7	15.0	10.0	6

Figure 8: Set Window

In the Set Window, you can perform the following functions:

- Alter the appearance of the program windows with the Font and Color buttons
- Change parameters of a connected instrument by editing the fields in the GX-6000 Status frame and in the Gas/Sensor frame at the bottom of the window and clicking the **Update** button
- Update the date and time in a connected instrument by using the **Date/Time Set** button
- Update the station and user ID lists using the Detail Settings button

Accessing a Common Database

The GX-6000 Data Logger Management Program stores downloaded data in a database file. This database file is automatically stored on the computer's hard drive in the same folder as the GX-6000 Data Logger Management Program. In this configuration, a computer has access to its own database but no other computer's. Only data downloaded to that computer may be viewed. If the database was set up on a network location, multiple computers could access the same database. All computers accessing that database could view all data that was downloaded from any computer.

The GX-6000 Data Logger Management Program has the ability to map its database along any other valid path to another file location. That file location can be on the same computer or it can be on a network location. Putting it on a network location allows multiple users to save data to and access data from the same location. This allows access to instrument data that was downloaded at another computer.

NOTE: Only one computer at a time may access the database, so only one software installation mapped to a common database can be running at a time. If two installations attempt to access the same database, an error indication will occur when the second program is launched.

To set up this new database path:

1. You must first determine where the database is going to be located and make a note of that file path.
2. If the GX-6000 Data Logger Management Program hasn't been launched on the computer yet, you must launch and close the program. This creates a GX6000.ini file that contains configuration settings.

3. Locate the GX6000.ini file by searching your C drive for “GX6000.ini”.

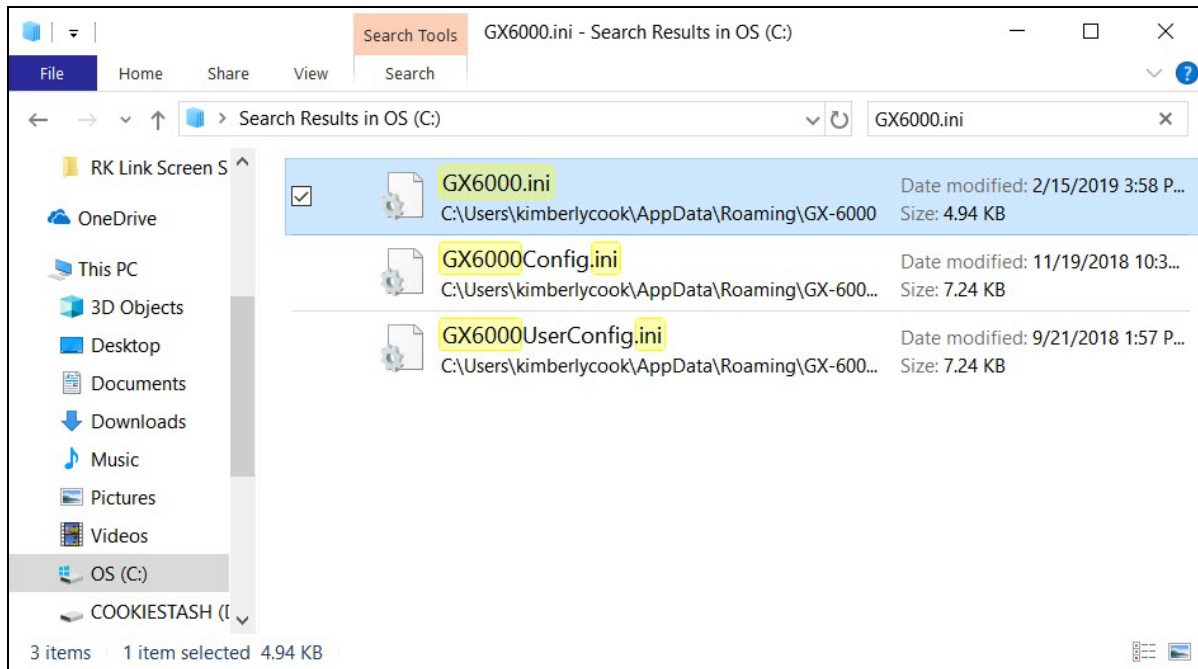

Figure 9: GX6000.ini File Found on C Drive

4. Double click the GX6000.ini file and open it in Notepad.

5. Scroll down to the very last line. This line is the Data Location path. An example of the path created by the program is shown in Figure 10. Replace the current path with the desired path (see Figure 11).

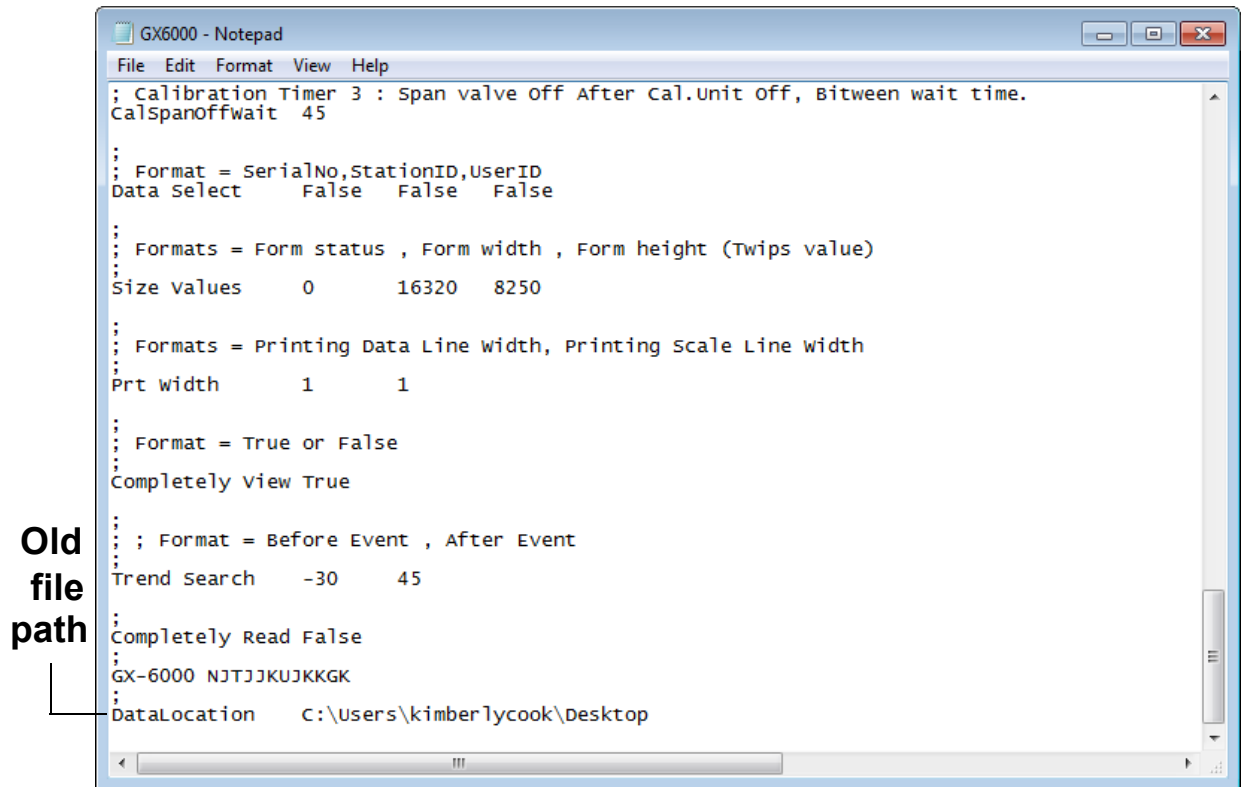

Figure 10: GX6000.ini File with Original Path

New file path

```
File Edit Format View Help
; Calibration Timer 3 : Span valve Off After Cal.Unit Off, Bitween wait time.
CalSpanOffwait 45
;
;
; Format = SerialNo,StationID,UserID
Data Select      False  False  False
;
; Formats = Form status , Form width , Form height (Twips value)
Size values      0      16320  8250
;
; Formats = Printing Data Line width, Printing scale Line width
Prt width        1      1
;
; Format = True or False
;
; Completely View True
;
; ; Format = Before Event , After Event
Trend Search     -30    45
;
; Completely Read False
;
; GX-6000 NJTJJKUJKKGK
;
; DataLocation    V:\MannyFlores\GX-6000 Log Database
```

Figure 11: GX6000.ini File with New Path

6. Save the file and reopen the GX-6000 Data Logger Management Program.
7. When you launch the program again, a database will be created in the specified location.
8. Repeat steps 2-5 for all installations that need access to the common database.

Downloading Data from an Instrument

You have the option of downloading data manually or automatically. If you want to download data using the automatic download feature, click the Automatic Download selection box in the Download Window before attempting to download data from the instrument. Remember that if Automatic Download is selected, the Instrument Information Window will remain blank and the instrument will turn off automatically after the data has been downloaded. If you want the data in the instrument to be cleared automatically after an automatic download, select the Automatic Data Removal box. The Automatic Data Removal box is only available for selection if the Automatic Download box is selected.

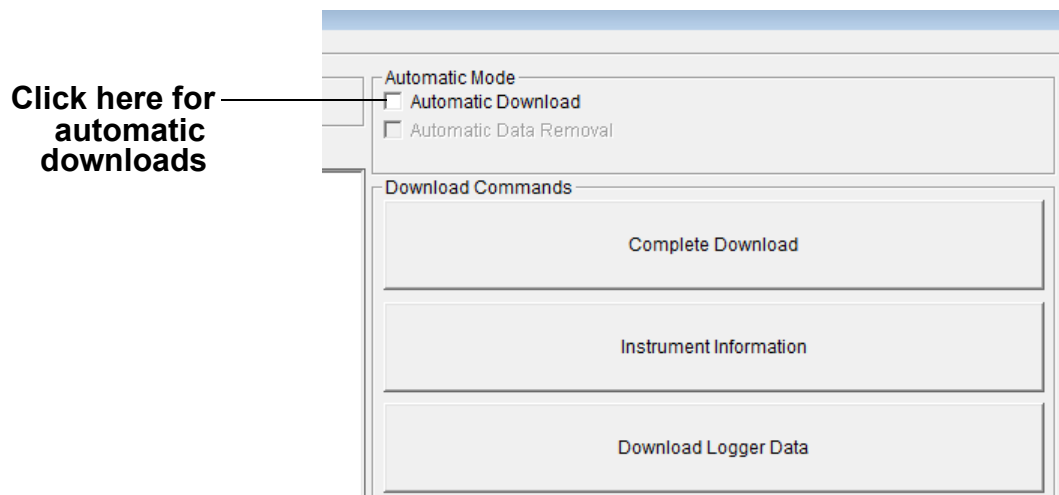

Figure 12: Automatic Download Selection Box

To download data from an instrument:

1. Launch the GX-6000 Data Logger Management Program. The Download Window displays. When the program comes up and no instrument is connected, the Download Commands are not selectable.
2. Place the instrument within an inch or two of the infrared port on your computer aligning the infrared port located below the POWER/ENTER button on the instrument with the infrared port on your computer.

If your computer does not have a built in infrared port, place the instrument within an inch or two of the infrared port on the IrDA adapter cable as shown in Figure 13 below, aligning the infrared port below the POWER/ENTER button on the instrument with the infrared port on the cable.

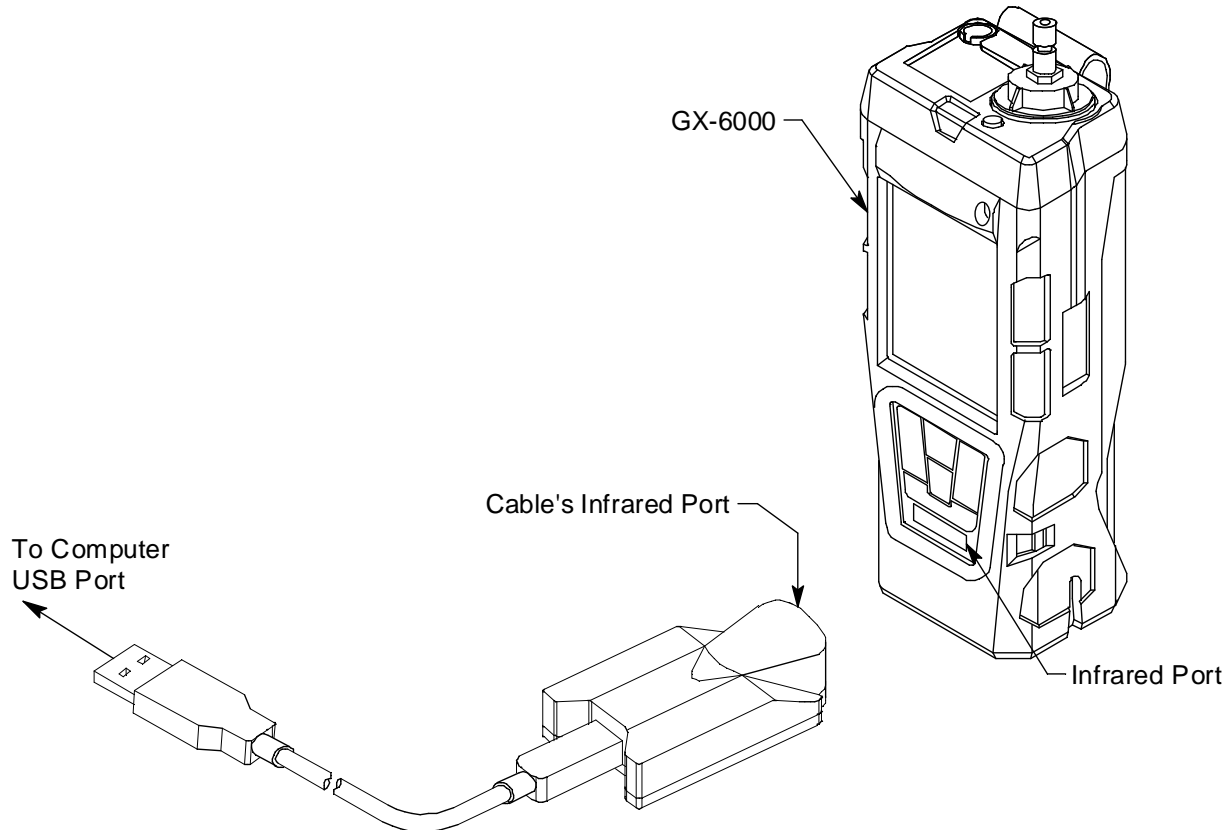

Figure 13: Aligning the Instrument with the Cable Infrared Receiver

3. Press and hold the POWER/ENTER button on the instrument until you hear a beep, then release it. The instrument will begin its power up sequence. If the **L/B MODE** menu item in Maintenance Mode is set to **LEAK CHECK MODE BAR HOLE MODE, BAR HOLE MODE, or LEAK CHECK MODE**, press and release the POWER/ENTER button to continue the power up sequence. If you do not press a button for 20 seconds, the instrument will automatically continue. If a successful connection between the instrument and the computer occurs, the Connect light in the Download window turns green after a few seconds

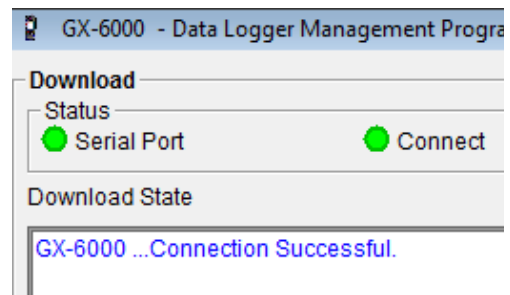

Figure 14: Connection Message

and “Connection Successful.” displays in the Download area of the Download window. The Windows® icon tray will indicate that a wireless connection is in effect.

4. If you selected Automatic Download, the downloading process begins automatically after a successful connection is made.

If Automatic Download is not selected, the Complete Download, Instrument Information, and Power Off Download Commands become selectable.

5. If you are going to download data manually, you can perform a complete download, download only the instrument information, or download only the data files by using the Download Commands.

- To download logged data and instrument information from the instrument, click **Complete Download**.

- To download instrument information only, click **Instrument Information**.

- To download logged data only, click **Download Logger Data**. **Download Logger Data** becomes selectable only after a Complete Download or Instrument Information Download Command has been performed.

6. While the data is being downloaded, messages in the download message area of the Download window indicate what actions the program is performing and if there are any communication or downloading problems. These messages also tell you what type of information has been downloaded.

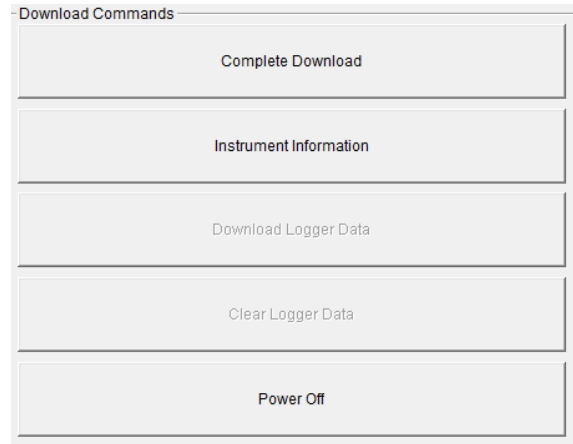

Figure 15: Download Commands

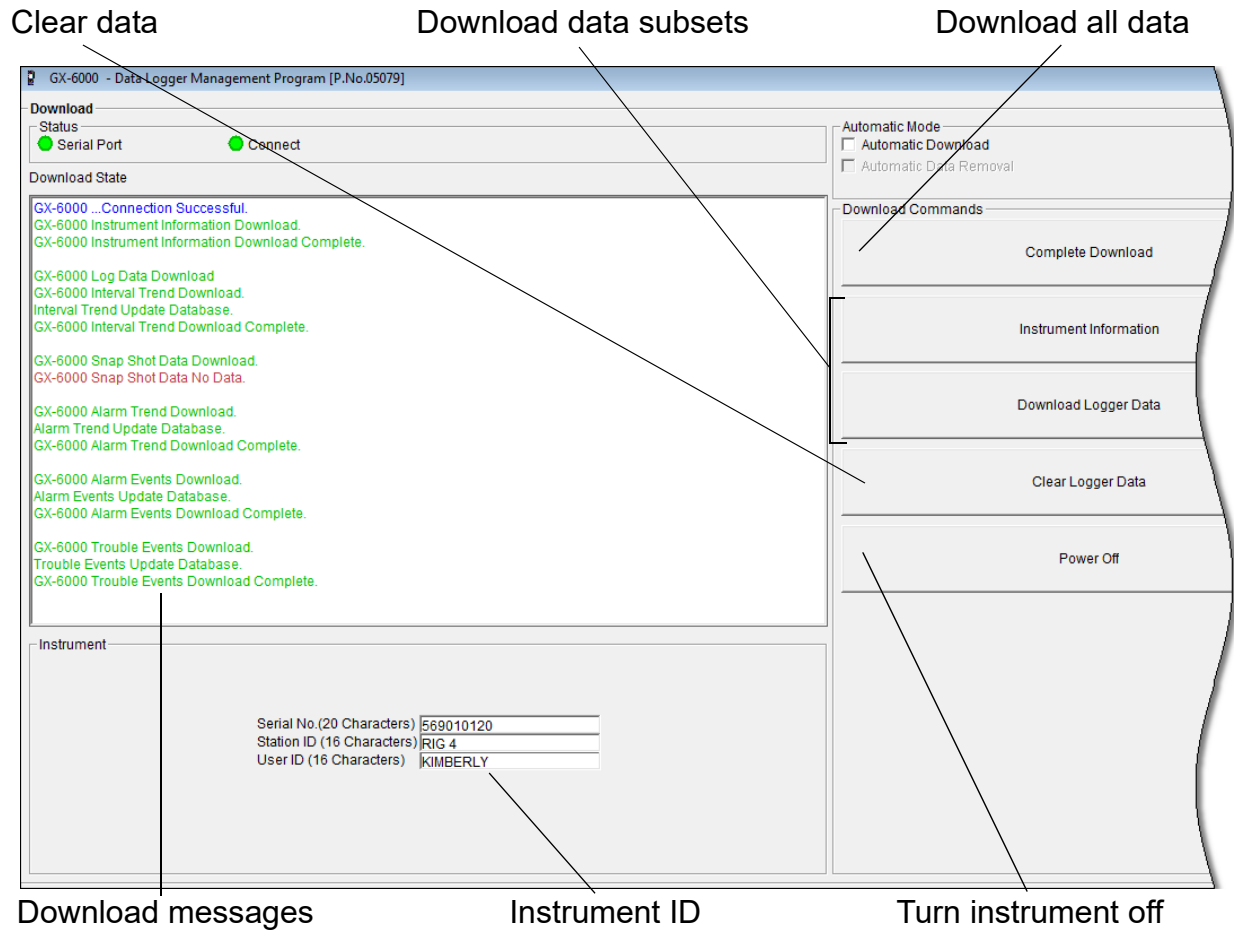

Figure 16: Download Messages & Download Commands

- If the unit has been downloaded manually (Automatic Download not selected), the unit's instrument information may be viewed after downloading by using the **Instrument Information** control button if the unit is still turned on and connected to the computer. The instrument information includes instrument parameters such as serial number and alarm points. It also includes the results of the most recent successful calibration for each channel and, if the bump test feature on the downloaded unit is activated, the most recent bump test results. To view instrument information for a unit, click **Instrument Information** along the right side of the Download Window. The Instrument Information Window displays. This screen cannot be printed from the downloading software. If the unit is turned off, the Instrument Information window will be blank.



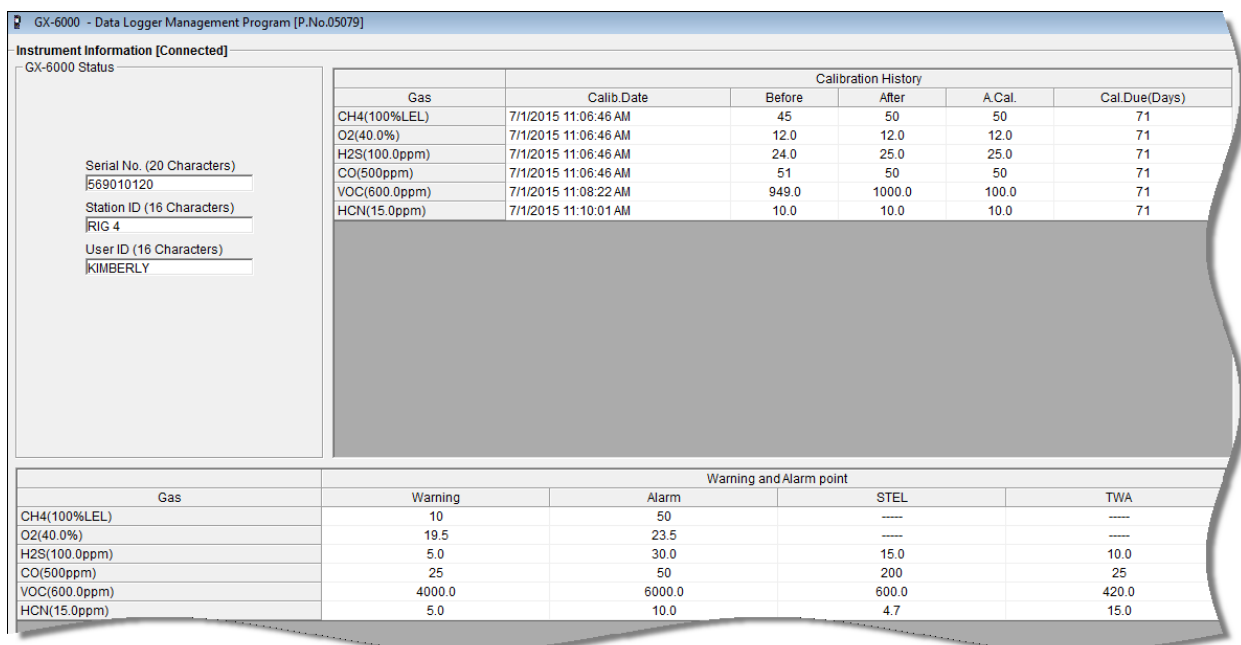

Figure 17: Instrument Information Window

- You can view, print, export, or delete downloaded data by entering the Data or Last Calibration Windows. These windows are accessed by clicking **Data** or **Last Calibration** along the right side of the Download Window. See “Viewing, Printing, Exporting, & Deleting Data in the Data Window” on page 28 or “Last Calibration Button” on page 16.
- After downloading data from an instrument, you can delete all the data in the instrument by clicking **Clear Logger Data** if desired. This will not delete instrument parameters such as serial number, alarm settings, or auto calibration settings.

WARNING: *If you click Clear Logger Data, all data is erased in the instrument, but not in your computer’s memory. So it’s advisable that you download the data from the instrument first before clearing the data.*

GX-6000 Data Logging Capacity

Table 1: GX-6000 Data Logging Capacity

Interval Trend Time	Data Logging Hours
10 seconds	10 hours
20 seconds	20 hours
30 seconds	30 hours
60 seconds	60 hours
180 seconds (3 minutes)	180 hours
300 seconds (5 minutes)	300 hours
600 seconds (10 minutes)	600 hours

Table 1 above lists the GX-6000's data logging capacity for each interval trend time setting assuming no alarms or other events. The interval trend time setting can be set using the Set Window (see "Changing Instrument Parameters" on page 75).

Overwriting Data in the GX-6000

The instrument's Data Log Overwrite setting is factory set to *On* so that when the instrument's data logging memory becomes full, it begins to overwrite the oldest interval trend data with new interval trend data. Download data regularly to avoid over-writing data in the instrument before it can be downloaded. The Data Log Overwrite setting is accessible in the instrument's Maintenance Mode. To set the Data Log Overwrite setting to *Off*, see the GX-6000 Operator's Manual. When the Data Log Overwrite setting is set to off, the instrument will stop saving data when its data logging memory is full.

The Data Log Overwrite setting applies only to interval trend data. All other data, such as alarm trend data, event data, or calibration data, will continue to be saved when the memory is full. If the maximum number of each of these types of data has been reached, the oldest data will be overwritten.

Viewing, Printing, Exporting, & Deleting Data in the Data Window

The instrument logs six types of data files: bump test data, calibration history, interval trend data, alarm trend data, snap log data, and event data.

You can view, print, and export (save to a file) each of these types of data files. All of these types of data files can also be deleted. The deleting of files is password protected and is described in “Deleting Data in the Data Window” on page 61.

NOTE: If the GX-6000 Data Logger Management Program database is on the user’s computer (default setting), data will only appear for instruments downloaded to that computer. If the database is on a network, data will appear for all instruments downloaded to that database. See “Accessing a Common Database” on page 18 for more instruction.

All the data, other than the most recent calibration and bump test information that is accessible in the Last Calibration Window, can be accessed in the Data Window. The Data Window is accessed by clicking **Data** along the right side of the program window.

Double click to show data folders

Click to expand folder

Click to show interval trend files

Name	SerialNo	StationID	UserID	Date/Time
iv20094149_569010101	569010101	VALVE 3	KATIE	8/20/2015 9:41:49 AM
iv20094206_569010120	569010120	RIG 4	KIMBERLY	8/20/2015 9:42:06 AM
iv20094909_569010101	569010101	VALVE 3	KATIE	8/20/2015 9:49:09 AM
iv20094914_569010120	569010120	RIG 4	KIMBERLY	8/20/2015 9:49:14 AM
iv20095528_569010120	569010120	RIG 4	KIMBERLY	8/20/2015 9:55:28 AM
iv20095529_569010101	569010101	VALVE 3	KATIE	8/20/2015 9:55:29 AM
iv20100139_569010101	569010101	VALVE 3	KATIE	8/20/2015 10:01:39 AM
iv20100144_569010120	569010120	BUILDING 7	KIMBERLY	8/20/2015 10:01:44 AM
iv20101237_569010101	569010101	VALVE 3	KATIE	8/20/2015 10:12:37 AM
iv20101240_569010120	569010120	BUILDING 7	KIMBERLY	8/20/2015 10:12:40 AM

Property	Value
Name	iv20094149_569010101
Sampling Date/Time	8/20/2015 9:41:49 AM to 8/20/2015 9:42:00 AM
Serial No.	569010101
Station ID	VALVE 3
User ID	KATIE
Data Count	1
Interval Time (sec)	10
Gas(FullScale)	CH4(100%LEL) O2(40.0%) H2S(100.0ppm) CO(500ppm)
Avg	0 %LEL 0.0 % 0.0 ppm 0 ppm
Max	0 %LEL 20.9 % 0.0 ppm 0 ppm
Max Date/Time	08/20 09:41:37 08/20 09:41:37 08/20 09:41:37 08/20 09:41:37
Min	***** 20.9 % ***** *****
Min Date/Time	***** 08/20 09:41:37 ***** *****
Warning	10 %LEL 19.5 % 5.0 ppm 25 ppm

Interval trend files

Figure 18: Data Window, Basic Data Organization

The Data Window is divided into four frames. The upper left frame is the Data Frame and displays all the data folders. They are grouped under the GX-6000 icon in the upper left part of the frame. When you open the program for the first time, the GX-6000 icon will appear. If the data folders are not visible, double click the GX-6000 icon to make them visible. If no data has been saved, then no folders will appear when the GX-6000 icon is double clicked.

The lower left frame contains three selection boxes for organizing data. If none of the boxes are selected, then the data is organized as shown in Figure 18. The data may be organized by one or more of the following parameters: serial number, station ID, or user ID. Click the selection box or boxes in the lower left frame to organize the data as desired.

NOTE: In the examples that follow, the data will be shown organized by serial number. If you do not select any of the organization boxes or select the Station ID or User ID boxes instead of or in addition to the Serial No. box, your Data Window will look slightly different. The following examples also show the combustible channel as “CH4”. The combustible channel may also be “HC”.

The upper right frame shows the contents of a data folder that is selected in the Data Frame. The lower right frame shows the summary information for a data file that is selected in the upper right frame.

The **View Data** control button is located at the bottom of the lower right frame. The **View Data** button becomes active when a data file is selected in the upper right frame. Clicking **View Data** opens the data file and displays the data.

NOTE: If data is being viewed and the data folders are left open before instrument downloading is done, close all folders after downloading and re-open them to be able to view newly downloaded files.

Bump Test Data

The instrument is capable of saving information for up to 100 of the most recent bump tests and calibrations combined. This bump test history is retrieved by the Data Logger Management Program when data is downloaded from the instrument using either the **Complete Download** download command or the **Download Logger Data** download command.

Instrument bump test information is also available in the Last Calibration Window. The information regarding the most recent successful calibration and bump test for each downloaded instrument along with whether or not an instrument is due for calibration or bump testing can be accessed using the **Last Calibration** button on the right side of the program window. See “Last Calibration Window” on page 66 for a complete description of the information that can be accessed by the **Last Calibration** button.

All downloaded bump test data for all downloaded instruments is available in the Bump Test folders in the Data Window. This information is saved in a Bump Test Folder that is located in an untitled folder for each instrument. The bump test files are differentiated by instrument. The bump test information available here is more comprehensive than that in the Last Calibration Window. The bump test information for all bump tests downloaded, whether successful or not, is saved instead of just the most recent successful bump test for each instrument.

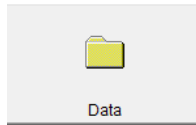

To view, print, or export the bump test information for any instrument in the database:

1. With the program already launched, click the **Data** control button along the right side of the program window. The Data Window will appear.

Double click to show data folders

Click to expand folder

Click to show bump test file

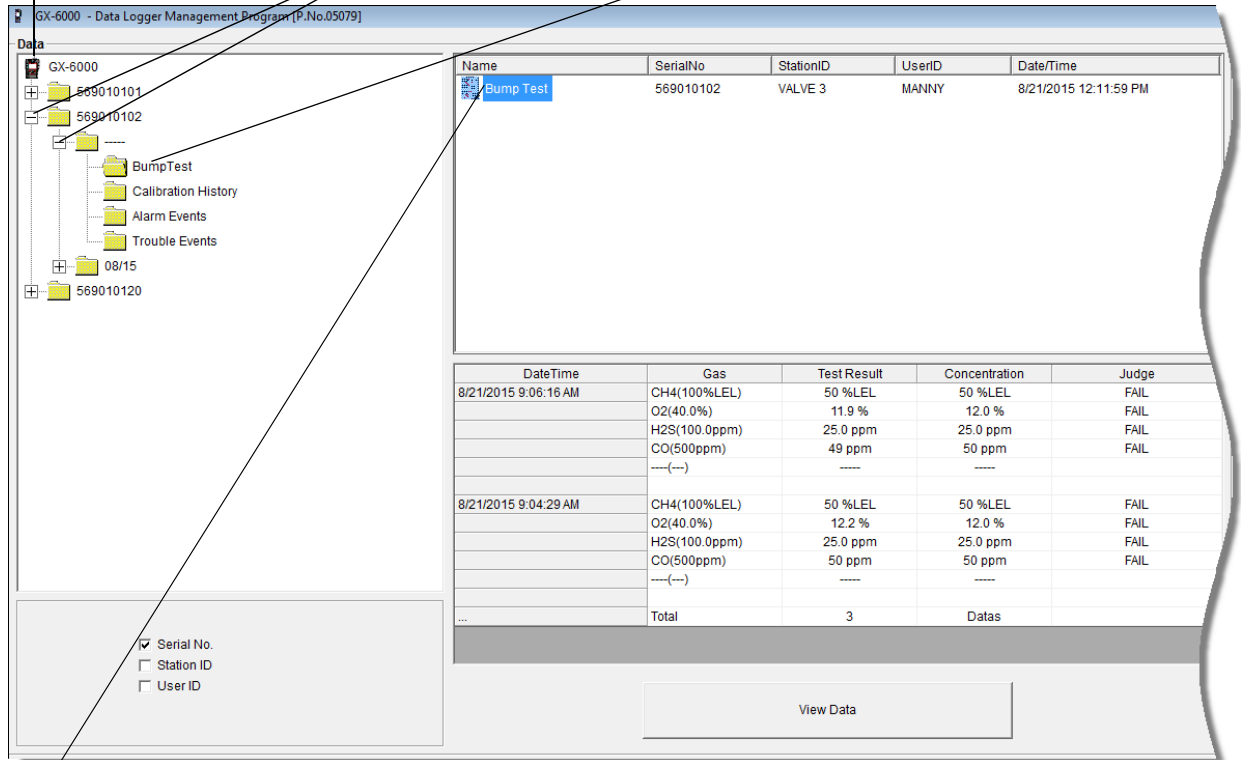

Bump test file

Figure 19: Data Window - Selecting Bump Test Files

2. If necessary, double-click the GX-6000 icon in the top of the Data Window's upper left frame to see the folders of downloaded data.
3. Find your instrument by serial number, then click the expanded view symbol (+) of or double-click the serial number folder to view the contents. The top folder is untitled and contains the Bump Test Folder along with folders for calibration history, alarm events, and trouble events. The rest of the folders contain folders for the interval trend files, snap log files, and alarm trend files and are named and organized by date (month/year).
4. Click the expanded view symbol (+) of or double-click the untitled folder. The Bump Test folder will appear below the untitled folder along with the Calibration History, Alarm Events, and Trouble Events folders.
5. Click the Bump Test folder. The Bump Test file or files for that

instrument will appear in the top right frame. If multiple Station ID's or User ID's are used for an instrument, then more than one Bump Test file will appear.

The serial number, station ID, user ID, and date/time appear on the line for each file. The date/time correspond to the date and time of the instrument download and not a date or time of a bump test.

- Click the file to select it. The first two bump tests saved will be shown in the bottom right frame along with the total number of bump tests saved if it is more than two.

Each saved bump test shows the date/time of the bump test, the gas, the test result, the concentration of gas used, and the result of the bump test.

- To view the Bump Test file in table format, double click the Bump Test file or click the View Data button. Bump Test files can only be viewed in table format.

No	Date/Time	Gas	Ch1	Ch2	Ch3	Ch4	Ch5	Ch6
1	8/21/2015 9:06:16 AM	Gas	CH4(100%LEL)	O2(40.0%)	H2S(100.0ppm)	CO(500ppm)	--(--)	--(--)
		Test Result	50 %LEL	11.9 %	25.0 ppm	49 ppm	----	----
		Concentration	50 %LEL	12.0 %	25.0 ppm	50 ppm	----	----
		Judge	FAIL	FAIL	FAIL	FAIL	----	----
2	8/21/2015 9:04:29 AM	Gas	CH4(100%LEL)	O2(40.0%)	H2S(100.0ppm)	CO(500ppm)	--(--)	--(--)
		Test Result	50 %LEL	12.2 %	25.0 ppm	50 ppm	----	----
		Concentration	50 %LEL	12.0 %	25.0 ppm	50 ppm	----	----
		Judge	FAIL	FAIL	FAIL	FAIL	----	----
3	8/21/2015 9:03:33 AM	Gas	CH4(100%LEL)	O2(40.0%)	H2S(100.0ppm)	CO(500ppm)	--(--)	--(--)
		Test Result	0 %LEL	0.0 %	0.0 ppm	0 ppm	----	----
		Concentration	50 %LEL	12.0 %	25.0 ppm	50 ppm	----	----
		Judge	PASS	PASS	PASS	FAIL	----	----

Figure 20: Data View, Bump Test

8. If you want to print the data, click the **Print** button. A Printer List dialog box will appear for you to select a printer.

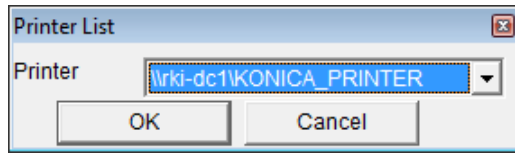

Figure 21: Printer List Dialog Box, Calibration History

9. Select a printer and click **OK** to print the data.
10. To export the data to another application, for example a spreadsheet or database, click the **Export** button. A “Save As” dialog box will appear for you to specify the filename, file type, and file location. The default file type is “.csv” (comma-separated values).

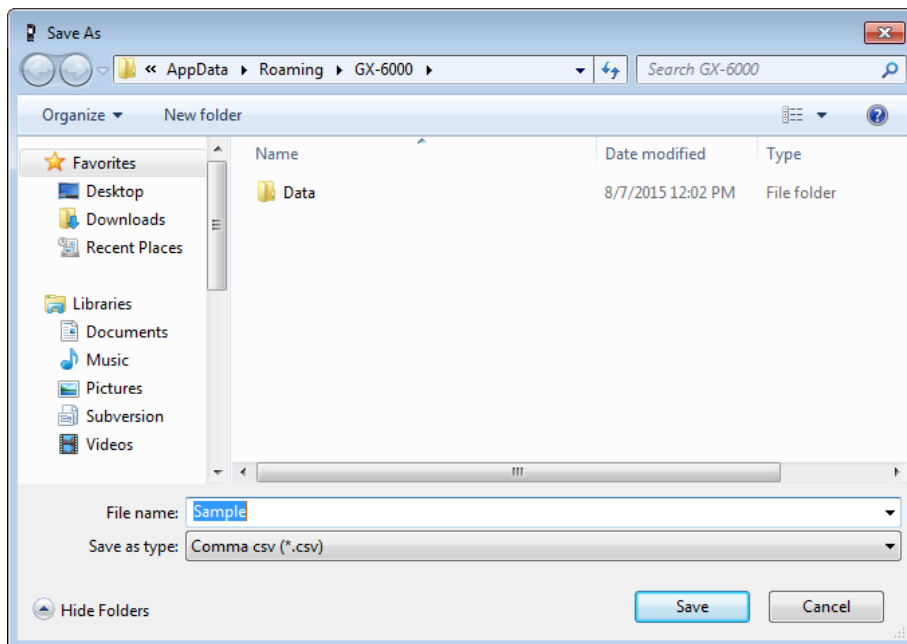

Figure 22: Save as Dialog Box

After specifying the file name, file type, and file location click the **Save** button to save the file to the specified location.

11. To go back and view other data, click the **Return** button in the upper right corner of the Data Window or the **Data** button on the right side of the program window and select the data you want to view.

Calibration History

The instrument is capable of saving information for up to 100 of the most recent bump tests and calibrations combined. This calibration history is retrieved by the Data Logger Management Program when data is downloaded from the instrument using either the **Complete Download** download command or the **Download Logger Data** download command.

Instrument calibration information is also available in the Last Calibration Window. The information regarding the most recent successful calibration and bump test for each downloaded instrument along with whether or not an instrument is due for calibration or bump testing can be accessed using the **Last Calibration** button on the right side of the program window. See “Last Calibration Window” on page 66 for a complete description of the information that can be accessed by the **Last Calibration** button.

All downloaded calibration information for all downloaded instruments is available in the Calibration History folders in the Data Window. This information is saved in a Calibration History Folder that is located in an untitled folder for each instrument. The calibration history files are differentiated by instrument. The calibration information available here is more comprehensive than that in the Last Calibration Window. The calibration information for all calibrations downloaded, whether successful or not, is saved instead of just the most recent successful calibration for each instrument.

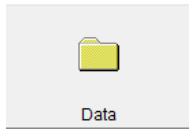

To view, print, or export the calibration history for any instrument in the database:

1. With the program already launched, click the **Data** control button along the right side of the program window. The Data Window will appear.

Double click to show data folders

Click to expand folder

Click to show calibration history file

The screenshot shows the 'GX-6000 - Data Logger Management Program' window. On the left is a tree view of data folders. The 'GX-6000' folder is expanded to show sub-folders: '569010101', '569010102', '08/15', and '569010120'. The '569010102' folder is further expanded to show 'BumpTest', 'Calibration History', 'Alarm Events', and 'Trouble Events'. The 'Calibration History' folder is selected. On the right, a table displays the calibration history data.

Name	SerialNo	StationID	UserID	Date/Time
Calibration Histories	569010102	VALVE 3	MANNY	8/21/2015 12:11:59 PM

DateTime	Gas	Before	After
8/21/2015 9:20:53 AM	CH4(100%LEL)	----	----
8/21/2015 9:20:53 AM	O2(40.0%)	----	----
8/21/2015 9:20:53 AM	H2S(100.0ppm)	----	----
8/21/2015 9:20:53 AM	CO(500ppm)	----	----
8/21/2015 9:20:53 AM	SO2(6.00ppm)	4.40 ppm	5.00 ppm
8/21/2015 9:05:29 AM	CH4(100%LEL)	50 %LEL	50 %LEL
8/21/2015 9:05:29 AM	O2(40.0%)	11.9 %	12.0 %
8/21/2015 9:05:29 AM	H2S(100.0ppm)	25.0 ppm	25.0 ppm
8/21/2015 9:05:29 AM	CO(500ppm)	49 ppm	50 ppm
8/21/2015 9:05:29 AM	SO2(6.00ppm)	----	----
...	Total	3	Datas

At the bottom left, there are checkboxes for 'Serial No.' (checked), 'Station ID', and 'User ID'. At the bottom center, there is a 'View Data' button.

Calibration history file

Figure 23: Data Window - Selecting Calibration History Files

2. If necessary, double-click the GX-6000 icon in the top of the Data Window's upper left frame to see the folders of downloaded data.
3. Find your instrument by serial number, then click the expanded view symbol (+) of or double-click the serial number folder to view the contents. The top folder is untitled and contains the Calibration History Folder along with folders for bump tests, alarm events, and trouble events. The rest of the folders contain folders for the interval trend files, snap log files, and alarm trend files and are named and organized by date (month/year).
4. Click the expanded view symbol (+) of or double-click the untitled folder. The Calibration History folder will appear below the untitled folder along with the Bump Test, Alarm Events, and Trouble Events folders.

- Click the Calibration History folder. The Calibration Histories file or files for that instrument will appear in the top right frame. If multiple Station ID's or User ID's are used for an instrument, then more than one Calibration Histories file will appear.

The serial number, station ID, user ID, and date/time appear on the line for each file. The date/time correspond to the date and time of the instrument download and not a date or time of calibration.

- Click the file to select it. The first two calibrations saved will be shown in the bottom right frame along with the total number of calibrations saved if it is more than two.

Each saved calibration shows the date/time of calibration, the gas, the concentration before calibration, and the concentration after calibration. If a calibration failed, dashes will appear in the After column rather than gas concentrations. If a channel was not calibrated, dashes will appear in the Before and After columns.

- To view the Calibration Histories file in table format, double click the Calibration Histories file or click the View Data button. Calibration Histories files can only be viewed in table format.

No	Date/Time	Gas	Ch1	Ch2	Ch3	Ch4	Ch5	Ch6
1	8/21/2015 9:20:53 AM	Gas	CH4(100%LEL)	O2(40.0%)	H2S(100.0ppm)	CO(500ppm)	--(--)	SO2(6.00ppm)
		Before	----	----	----	----	----	4.40 ppm
		After	----	----	----	----	----	5.00 ppm
2	8/21/2015 9:05:29 AM	Gas	CH4(100%LEL)	O2(40.0%)	H2S(100.0ppm)	CO(500ppm)	--(--)	--(--)
		Before	50 %LEL	11.9 %	25.0 ppm	49 ppm	----	----
		After	50 %LEL	12.0 %	25.0 ppm	50 ppm	----	----
3	8/21/2015 9:03:42 AM	Gas	CH4(100%LEL)	O2(40.0%)	H2S(100.0ppm)	CO(500ppm)	--(--)	--(--)
		Before	50 %LEL	12.2 %	25.0 ppm	50 ppm	----	----
		After	50 %LEL	12.0 %	25.0 ppm	50 ppm	----	----

Figure 24: Data View, Calibration History

8. If you want to print the data, click the **Print** button. A Printer List dialog box will appear for you to select a printer.

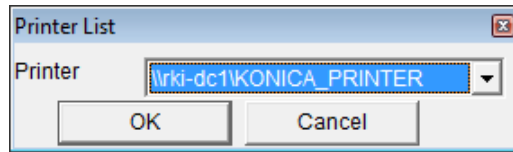

Figure 25: Printer List Dialog Box, Calibration History

9. Select a printer and click **OK** to print the data.
10. To export the data to another application, for example a spreadsheet or database, click the **Export** button. A “Save As” dialog box will appear for you to specify the filename, file type, and file location. The default file type is “.csv” (comma-separated values).

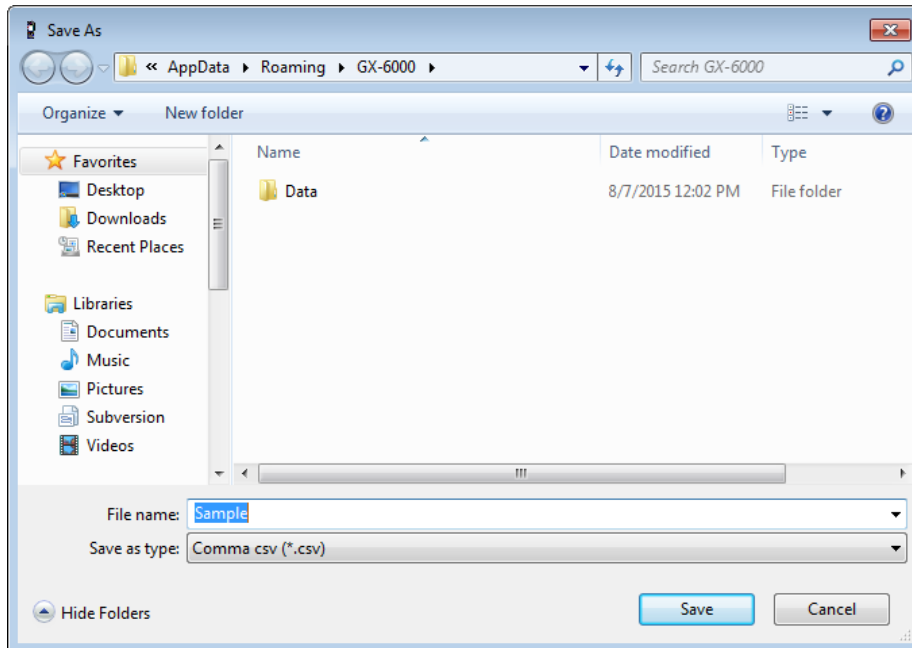

Figure 26: Save as Dialog Box

After specifying the file name, file type, and file location click the **Save** button to save the file to the specified location.

11. To go back and view other data, click the **Return** button in the upper right corner of the Data Window or the **Data** button on the right side of the program window and select the data you want to view.

Event Data

The instrument not only saves trend files which include logged data at scheduled times, but also saves the 100 most recent alarm events and the 100 most recent trouble events. When an instrument is downloaded, the GX-6000 Data Logger Management Program will retrieve these events from that instrument and save them in alarm event files and trouble event files for each instrument that is downloaded.

Alarm event files save the time, instrument channel, and alarm type of every gas alarm event that occurs on a particular instrument. Warning (low alarm), Alarm (high alarm), STEL, TWA, and overscale events are saved.

Trouble event files note the time, whether the event is an instrument system failure or sensor failure and the specific type of failure. Dead battery alarms and sensor failures are among the trouble events that are saved.

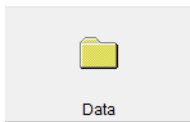

To view, print, or export the event data for any instrument in the database:

1. With the program already launched, click the **Data** control button along the right side of the program window. The Data Window will appear.

Double click to show data folders Click to expand folder Click to show alarm event files

Name	SerialNo	StationID	UserID	Date/Time
Alarm Events	569010102	VALVE 3	MANNY	8/21/2015 12:11:58 PM

DateTime	Ch	Gas	Event
8/21/2015 12:09:40 PM	6	SO2(6.00ppm)	ALARM
8/21/2015 12:09:21 PM	6	SO2(6.00ppm)	WARNING
8/21/2015 12:09:18 PM	2	O2(40.0%)	WARNING
8/21/2015 9:21:31 AM	6	SO2(6.00ppm)	WARNING
8/21/2015 9:21:31 AM	2	O2(40.0%)	WARNING
8/21/2015 9:21:10 AM	2	O2(40.0%)	WARNING
8/21/2015 9:02:36 AM	-	Body	DOWN
8/21/2015 9:00:46 AM	1	CH4(100%LEL)	WARNING
Total		21 Datas	

Serial No. Station ID User ID

View Data

Alarm event file

Figure 27: Data Window - Selecting Event Data Files

2. If necessary, double-click the GX-6000 icon in the top of the Data Window's upper left frame to see the folders of downloaded data.
3. Find your instrument by serial number, then click the expanded view symbol (+) of or double-click the serial number folder to view the contents. The top folder is untitled and contains the Alarm Events Folder and Trouble Events Folder along with the Calibration History Folder and Bump Test Folder. The rest of the folders contain folders for the interval trend files, snap log files, and alarm trend files and are named and organized by date (month/year).
4. Click the expanded view symbol (+) of or double-click the untitled folder. The Alarm Events Folder and Trouble Events Folder will appear below the untitled folder along with the Calibration History Folder and Bump Test Folder.
5. Click the Alarm Events or Trouble Events folder. One or more alarm or trouble event files will appear in the top right frame. An Alarm Events Folder has been opened in the example in Figure 27. If multiple user IDs or Station IDs are used for an instrument, then more than one event file will appear.

The serial number, station ID, user ID, and date/time appear on the line for each alarm event or trouble event file. The date/time correspond to the date and time that the instrument was downloaded and not the date and time of an alarm or trouble event.

6. Click the desired event file to select it. An event list will appear in the bottom right frame with the date, time, channel, and event type for the first eight events saved in the selected file. If more than eight events are saved, the first eight events are shown and the total number of events in the file is shown at the bottom of the list.

- Click the **View Data** button at the bottom of the Data Window or double-click the event file name to open the file and view it in table format. Event files can only be viewed in table format.

No	Date/Time	Ch	Gas	Event
1	8/21/2015 12:09:40 PM	6	SO2(6.00ppm)	ALARM
2	8/21/2015 12:09:21 PM	6	SO2(6.00ppm)	WARNING
3	8/21/2015 12:09:18 PM	2	O2(40.0%)	WARNING
4	8/21/2015 9:21:31 AM	6	SO2(6.00ppm)	WARNING
5	8/21/2015 9:21:31 AM	2	O2(40.0%)	WARNING
6	8/21/2015 9:21:10 AM	2	O2(40.0%)	WARNING
7	8/21/2015 9:02:36 AM	-	Body	DOWN
8	8/21/2015 9:00:46 AM	1	CH4(100%LEL)	WARNING
9	8/21/2015 9:00:46 AM	1	CH4(100%LEL)	ALARM
10	8/21/2015 9:00:42 AM	2	O2(40.0%)	WARNING
11	8/21/2015 9:00:41 AM	4	CO(500ppm)	WARNING
12	8/21/2015 9:00:40 AM	3	H2S(100.0ppm)	WARNING
13	8/21/2015 9:00:14 AM	-	Body	PANIC
14	8/21/2015 8:59:48 AM	1	CH4(100%LEL)	WARNING
15	8/21/2015 8:59:45 AM	4	CO(500ppm)	WARNING
16	8/21/2015 8:59:45 AM	2	O2(40.0%)	WARNING
17	8/21/2015 8:59:43 AM	3	H2S(100.0ppm)	WARNING
18	8/21/2015 8:59:13 AM	1	CH4(100%LEL)	WARNING
19	8/21/2015 8:59:10 AM	4	CO(500ppm)	WARNING
20	8/21/2015 8:59:09 AM	2	O2(40.0%)	WARNING
21	8/21/2015 8:59:09 AM	3	H2S(100.0ppm)	WARNING

Figure 28: Data View - Alarm Events

No	Date/Time	Ch	Gas/Body	Event
1	8/20/2015 12:31:24 PM	4	CO(500ppm)	Fail(BUMP)
2	8/20/2015 12:31:24 PM	3	H2S(100.0ppm)	Fail(BUMP)
3	8/20/2015 12:31:24 PM	2	O2(40.0%)	Fail(BUMP)
4	8/20/2015 12:31:24 PM	1	CH4(100%LEL)	Fail(BUMP)
5	8/20/2015 11:32:31 AM	4	CO(500ppm)	Fail(Span)
6	8/20/2015 11:32:31 AM	3	H2S(100.0ppm)	Fail(Span)
7	8/20/2015 11:32:31 AM	2	O2(40.0%)	Fail(Span)
8	8/20/2015 11:32:31 AM	1	CH4(100%LEL)	Fail(Span)
9	8/20/2015 10:18:21 AM	-	Body	Fail(FLOW)
10	8/20/2015 10:12:41 AM	2	O2(40.0%)	Fail(iSen.)
11	8/20/2015 10:12:36 AM	2	O2(40.0%)	Fail(iSen.)

Figure 29: Data View - Trouble Events

- If you click the **Summary** button, the Data Window will split into two frames one above the other with the event list in the lower frame and the summary information shown in the upper frame. The summary information is the same as the information shown in the upper right frame in Figure 27. To return to the one-frame format, click **Summary** again.

9. If you want to print the data, click the **Print** button. A Printer List dialog box will appear for you to select a printer.

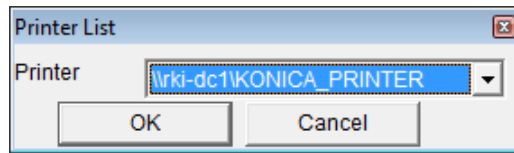

Figure 30: Printer List Dialog Box, Event Data

10. Select a printer and click **OK** to print the data.
11. To export the data to another application, for example a spreadsheet or database, click the **Export** button. A “Save As” dialog box will appear for you to specify the filename and file location. The default file type is “.csv” (comma-separated values).

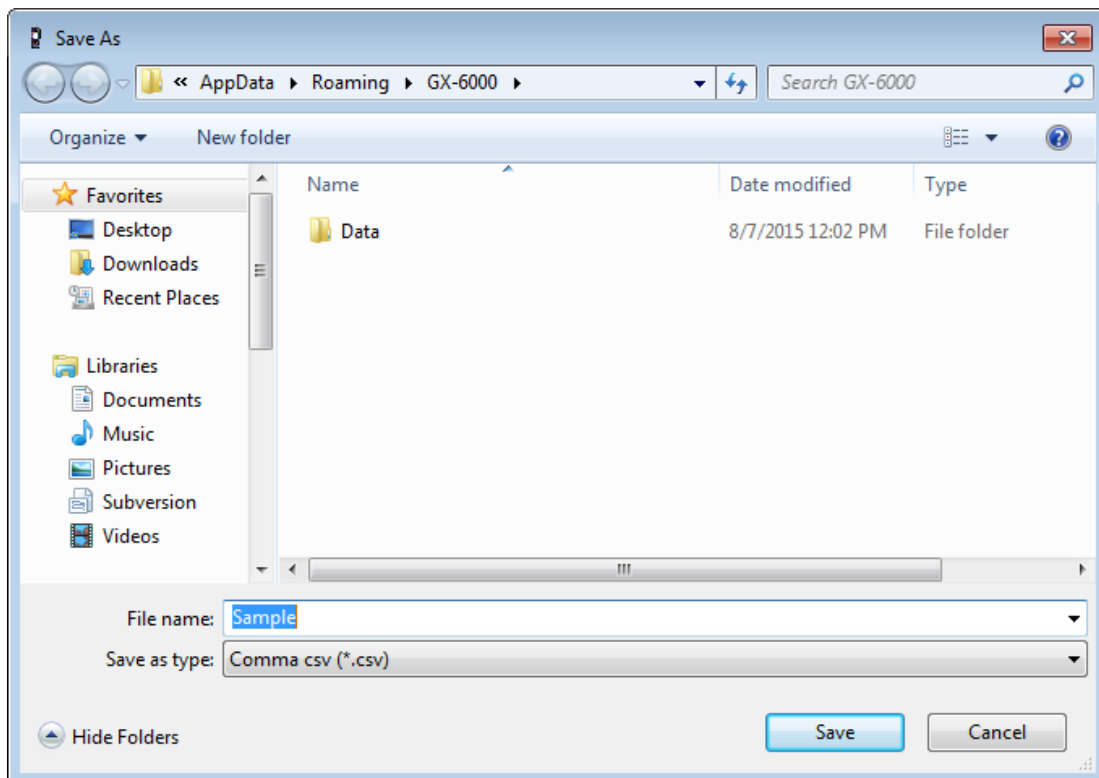

Figure 31: Save as Dialog Box

12. After specifying the file name, file location, and file type click the **Save** button to save the file to the specified location.
13. To go back and view other data, click the **Return** button in the upper right corner of the Data Window or the **Data** button on the right side of the program window and select the data you want to view.

Snap Log Data

Snap log data can be taken in Normal Operation or in Leak Check Mode Operation.

Normal Operation Snap Log Data

Normal Operation Snap Log Data can be taken on GX-6000 instruments. To view, print, or export normal operation snap log data for any instrument in the database:

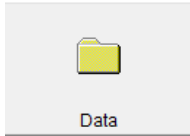

1. With the program already launched, click the **Data** control button along the right side of the program window. The Data Window will appear.

Double click to show data folders

Click to expand folder

Click to show normal op snap log files

Name	SerialNo	Start Date/Time	End Date/Time
ss21084700_569010102	569010102	8/21/2015 8:40:24 AM	8/21/2015 8:47:22 AM
ss21090028_569010102	569010102	8/21/2015 8:57:33 AM	8/21/2015 9:06:38 AM

Property	Value
Name	ss21084700_569010102
Sampling Date/Time	8/21/2015 8:47:00 AM
Serial No.	569010102
Station ID	VALVE 3
User ID	MANNY
-----	-----
Gas(FullScale)	CH4(100%LEL) O2(40.0%) H2S(100.0ppm) CO(500ppm)
Concentration	0 %LEL 20.9 % 0.0 ppm 0 ppm

Normal op snap log files

Figure 32: Data Window - Selecting Normal Op Snap Log Data Files

2. If necessary, double-click the GX-6000 icon in the top of the Data Window's upper left frame to see the folders of downloaded data.
3. Find your instrument by serial number, then click the expanded view symbol (+) of or double-click the serial number folder to view the contents. The top folder is untitled and contains the Alarm Events Folder and Trouble Events Folder along with the Calibration History

Folder and Bump Test Folder. The rest of the folders contain folders for the interval trend files, snap log files, and alarm trend files and are named and organized by date (month/year).

4. Click the expanded view symbol (+) of or double-click the dated folder whose contents you want to see.
5. Click the Normal Op Snap Log folder. One or more snap log files will appear in the top right frame. One snap log file is generated for all normal operation snap logs taken during an operating session. If you turn the instrument off and turn it back on, a new snap log file will be created.

The serial number, start date/time, and end date/time appear on the line for each snap log data file. The start date/time corresponds to the date and time that the instrument was turned on. The end date/time corresponds to the date and time that the instrument was turned off.

6. Click one of the snap log data file names. A summary will appear in the bottom right frame with instrument information. It will also show the gas reading that was saved for the first snap log in that snap log file.
7. If you want to view, print, or export the snap log data, double-click the filename or click the **View Data** button at the bottom of the window. Snap log files can only be viewed in table format.

No	User ID	Station ID	Date/Time	CH4(100%LEL)	O2(40.0%)	H2S(100.0ppm)	CO(500ppm)
1	MANNY	VALVE 3	8/21/2015 9:00:28 AM	0 %LEL	20.9 %	0.0 ppm	0 ppm
2	MANNY	VALVE 3	8/21/2015 9:00:50 AM	50 %LEL ALARM	13.6 % WARNING	24.5 ppm WARNING	47 ppm WARNING

Figure 33: Data View - Normal Op Snap Log

If a gas concentration increases above a warning or alarm point during a snap log, it will be displayed when the data is opened.

8. If you want to print the data, click the **Print** button. A Printer List dialog box will appear for you to select a printer.

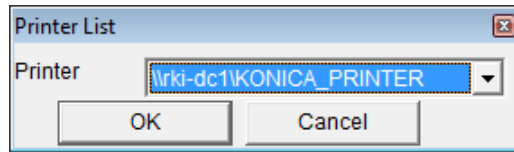

Figure 34: Printer List Dialog Box, Event Data

9. Select a printer and click **OK** to print the data.
10. To export the data to another application, for example a spreadsheet or database, click the **Export** button. A “Save As” dialog box will appear for you to specify the filename and file location. The default file type is “.csv” (comma-separated values).

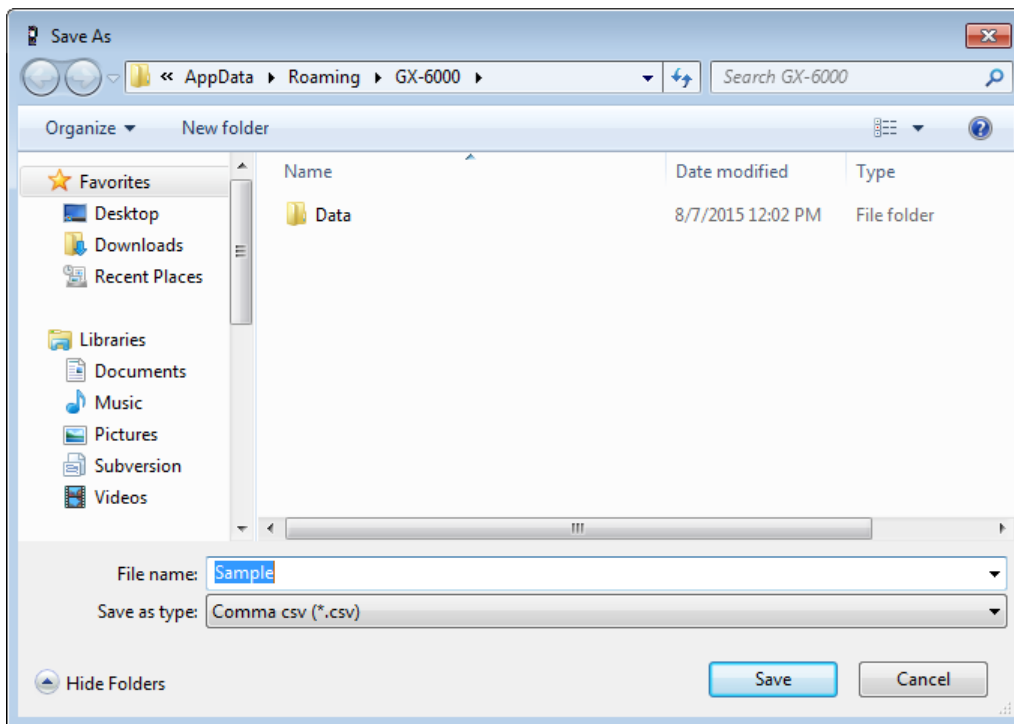
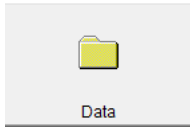

Figure 35: Save as Dialog Box

11. After specifying the file name, file location, and file type click the **Save** button to save the file to the specified location.
12. To go back and view other data, click the **Return** button in the upper right corner of the Data Window or the **Data** button on the right side of the program window and select the data you want to view.

Leak Check Snap Log Data

Leak Check Snap Log Data can be taken on GX-6000 instruments. To view, print, or export leak check snap log data for any instrument in the database:



1. With the program already launched, click the **Data** control button along the right side of the program window. The Data Window will appear.

Double click to show data folders

Click to expand folder

Click to show leak check snap log files

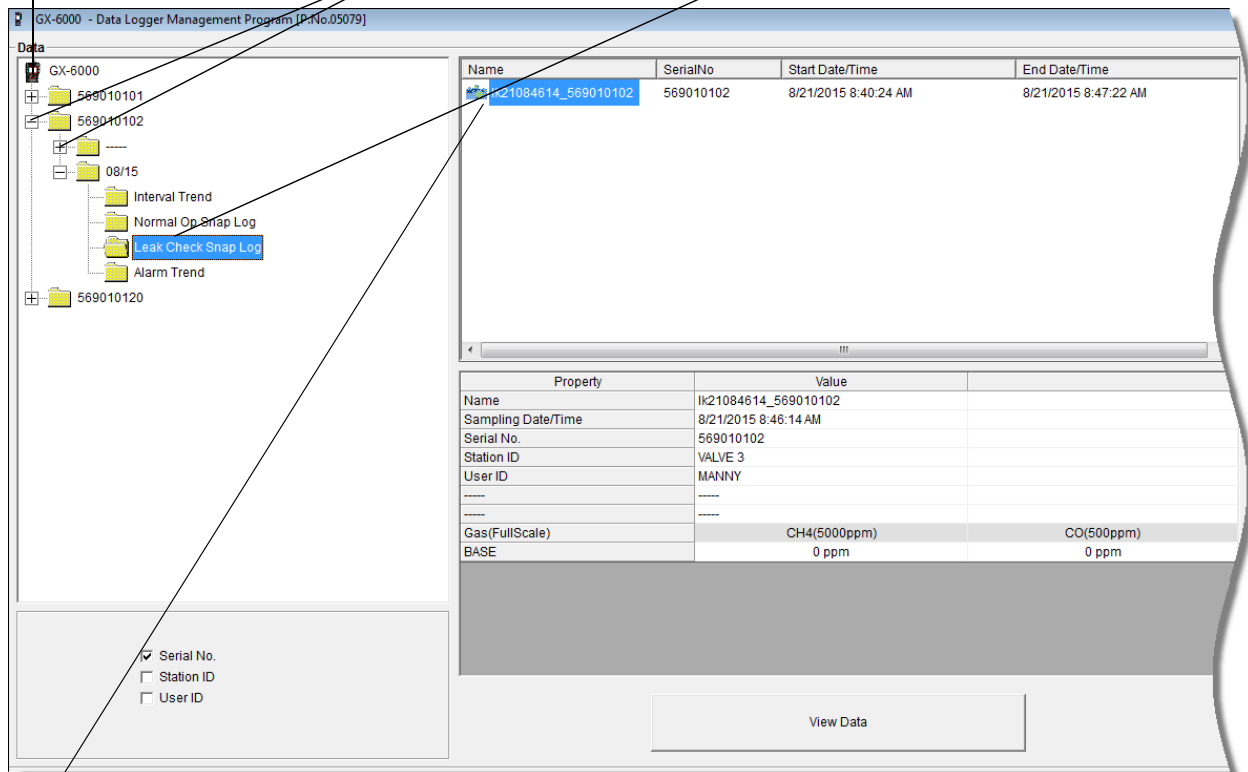

The screenshot shows the GX-6000 Data Window. On the left, a tree view shows the folder structure under 'GX-6000'. The 'Leak Check Snap Log' folder is selected. On the right, a table displays the selected file's details:

Name	SerialNo	Start Date/Time	End Date/Time
Ik21084614_569010102	569010102	8/21/2015 8:40:24 AM	8/21/2015 8:47:22 AM

Below the table is a property grid:

Property	Value
Name	Ik21084614_569010102
Sampling Date/Time	8/21/2015 8:46:14 AM
Serial No.	569010102
Station ID	VALVE 3
User ID	MANNY
Gas(FullScale)	CH4(5000ppm) CO(500ppm)
BASE	0 ppm 0 ppm

At the bottom, there is a 'View Data' button and a legend for checkboxes: Serial No., Station ID, User ID.

Leak check snap log files

Figure 36: Data Window - Selecting Leak Check Snap Log Data Files

2. If necessary, double-click the GX-6000 icon in the top of the Data Window's upper left frame to see the folders of downloaded data.
3. Find your instrument by serial number, then click the expanded view symbol (+) of or double-click the serial number folder to view the contents. The top folder is untitled and contains the Alarm Events Folder and Trouble Events Folder along with the Calibration History Folder and Bump Test Folder. The rest of the folders contain folders for the interval trend files, snap log files, and alarm trend files and are named and organized by date (month/year).
4. Click the expanded view symbol (+) of or double-click the dated folder whose contents you want to see.

- Click the Leak Check Snap Log folder. One or more snap log files will appear in the top right frame. One snap log file is generated for all leak check snap logs taken during an operating session. If you turn the instrument off and turn it back on, a new snap log file will be created.

The serial number, start date/time, and end date/time appear on the line for each snap log data file. The start date/time corresponds to the date and time that the instrument was turned on. The end date/time corresponds to the date and time that the instrument was turned off.

- Click one of the snap log data file names. A summary will appear in the bottom right frame with instrument information. It will also show the gas reading that was saved for the first snap log Base reading in that snap log file.
- If you want to view, print, or export the snap log data, double-click the filename or click the **View Data** button at the bottom of the window. Snap log files can only be viewed in table format.

No	User ID	Station ID	Date/Time	CH4(5000ppm)	CO(500ppm)
1	MANNY	VALVE 3	8/21/2015 8:46:14 AM	0 ppm	0 ppm
2	MANNY	VALVE 3	8/21/2015 8:46:19 AM	100 ppm	0 ppm

Figure 37: Data View - Leak Check Snap Log

Each leak check snap log consists of a Base reading and a Peak reading. Base readings are shown in yellow and Peak readings are shown in white. The User ID, Station ID, date/time, and methane reading are shown. If **CO DISPLAY** is set to **ON** in Maintenance Mode, the CO reading will also be displayed. The methane reading is based on a 5000 ppm scale. It does not matter what the display range was set to when the gas reading was taken. The actual gas reading will be displayed up to 5000 ppm. If the concentration was over 5000 ppm, OVER will replace the gas reading.

8. If you want to print the data, click the **Print** button. A Printer List dialog box will appear for you to select a printer.

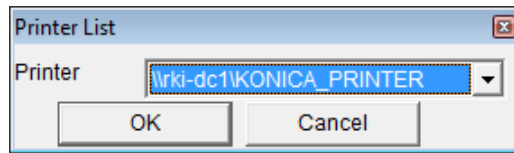

Figure 38: Printer List Dialog Box, Event Data

9. Select a printer and click **OK** to print the data.
10. To export the data to another application, for example a spreadsheet or database, click the **Export** button. A “Save As” dialog box will appear for you to specify the filename and file location. The default file type is “.csv” (comma-separated values).

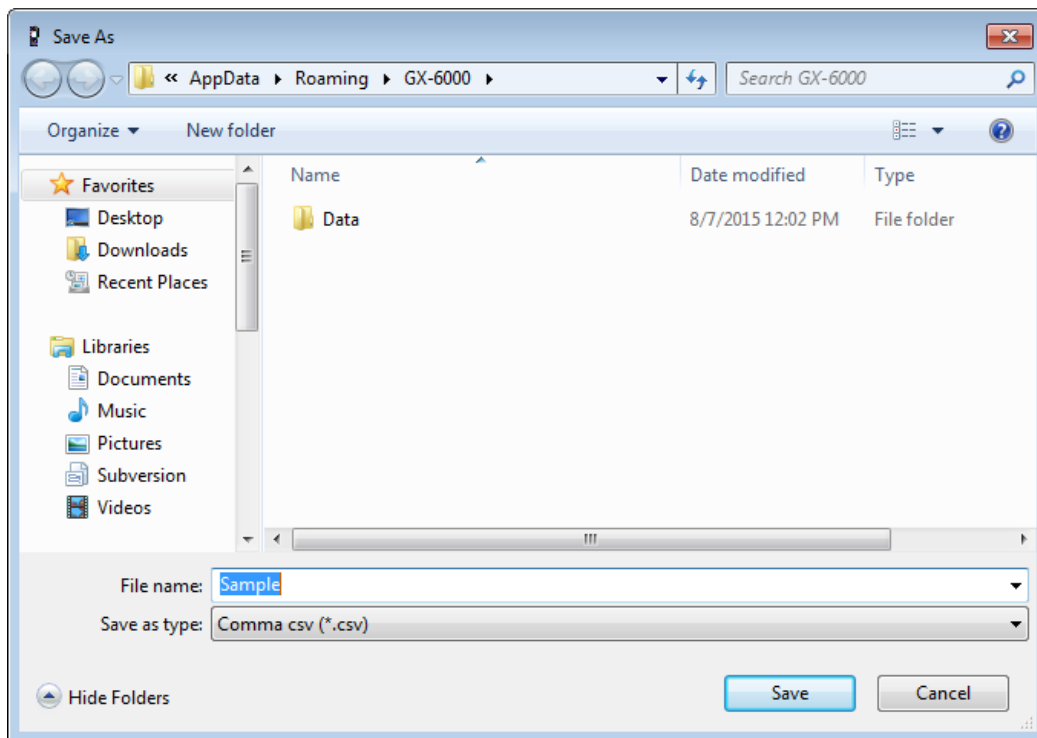

Figure 39: Save as Dialog Box

11. After specifying the file name, file location, and file type click the **Save** button to save the file to the specified location.
12. To go back and view other data, click the **Return** button in the upper right corner of the Data Window or the **Data** button on the right side of the program window and select the data you want to view.

Interval Trend Data

Average gas concentrations over the user defined interval trend time are logged in the interval trend data files. The interval trend time can be set in the Set window. See “Changing Instrument Parameters” on page 75. It can also be set in the instrument’s Maintenance Mode. See the GX-6000 Operator’s Manual for instructions to set the interval trend time. Events such as gas alarms or sensor failures are saved in the interval trend data file when they occur.

When the user ID of the instrument is changed during operation, a new interval trend file is created. When the station ID of the instrument is changed during operation, is it shown as an event in the interval trend file. A new interval trend file is not created for a station ID change done during operation.

An interval trend data file is created and saved in the instrument when the instrument is turned *off*. The serial number, user ID, and station ID that are entered in the instrument when it is turned *on* are saved for the corresponding interval trend file. If the instrument’s serial number, user ID, or station ID are changed in the Set window, any interval trend files that result from subsequent operating sessions will have the new serial number, user ID, or station ID saved in them.

The data may be viewed either in table format or graph format if at least 5 scheduled data points have been logged at the programmed interval trend time. This does not include events. If an interval data file has fewer than five scheduled data points, the graph controls are not functional and the data cannot be graphed.

To view and perform desired operations with the interval trend files:

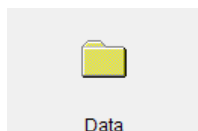

1. With the program already launched, click the **Data** control button along the right side of the program window. The Data Window will appear.

The screenshot shows the GX-6000 Data Window. On the left, a tree view shows the folder structure: GX-6000, 569010101, 569010102, 08/15, Interval Trend, Normal Op Snap Log, Leak Check Snap Log, Alarm Trend, and 569010120. The 'Interval Trend' folder is selected. On the right, a table lists data files with columns: Name, SerialNo, StationID, UserID, and Date/Time. The first row is selected. Below the table is a 'Property Value' section with fields for Name, Sampling Date/Time, Serial No., Station ID, User ID, Data Count, Interval Time (sec), Gas (Full Scale), Avg, Max, Max Date/Time, Min, Min Date/Time, and Warning. A 'View Data' button is at the bottom.

Annotations with arrows point to specific elements:

- "Double click to show data folders" points to the 'Data' button in the top left.
- "Click to expand folder" points to the '+' icon next to the 'Interval Trend' folder.
- "Click to show interval trend files" points to the '+' icon next to the '08/15' folder.
- "Interval trend files" points to the 'Interval Trend' folder in the tree view.

Figure 40: Data Window - Selecting Interval Trend Data Files

2. If necessary, double-click the GX-6000 icon in the top of the Data Window's upper left frame to see the folders of downloaded data.
3. Find your instrument by serial number, then click the expanded view symbol (+) of or double-click the serial number folder to view the contents. The top folder is untitled and contains the Calibration History, Bump Test Data, Alarm Event, and Trouble Event folders. The rest of the folders contain folders for the interval trend files, snap log data, and alarm trend files and are named and organized by date (month/year).
4. Click the expanded view symbol (+) of or double-click the dated folder whose contents you want to see.
5. Click on the Interval Trend Folder. In the upper right frame of the Data Window, a list of file names will appear in the Name column. A prefix of

“iv” indicates an interval trend data file.

The serial number, station ID, user ID, and date/time appear on the line for each interval trend file. The date/time is the date and time that the data file was created and data began being recorded in that file.

- Click one of the interval trend data file names. A summary will appear in the bottom right frame with instrument and alarm setting information. If you want to view, graph, print, or export the interval trend data, double-click the filename or click the **View Data** button at the bottom of the window.
- Interval trend data can be viewed in either table or graph format by selecting the Table or Graph selection buttons. The example below in Figure 41 is shown in table format.

The screenshot shows the 'Data View (Interval Trend)' window with the following callouts:

- View data as a table (points to the 'Table' button)
- View data as a graph (points to the 'Graph' button)
- View events only (points to the 'Event Only' button)
- View condensed data (points to the 'Condensed' button)
- Print data (points to the 'Print' button)
- Save data to a file (points to the 'Export' button)
- Show session summary (points to the 'Summary' button)
- Return to Data Window (points to the 'Return' button)

No	Date/Time	CH4(100%LEL)	O2(40.0%)	H2S(100.0ppm)	CO(500ppm)	VOC(50000ppb)	HCN(15.0ppm)
1	8/20/2015 9:49:24 AM	0 %LEL	20.9 %	0.0 ppm	0 ppm	0 ppb	0.3 ppm
2	8/20/2015 9:49:34 AM	0 %LEL	20.9 %	0.0 ppm	0 ppm	0 ppb	0.0 ppm
3	8/20/2015 9:49:44 AM	0 %LEL	20.9 %	0.0 ppm	0 ppm	0 ppb	0.0 ppm
4	8/20/2015 9:49:54 AM	0 %LEL	20.9 %	0.0 ppm	0 ppm	0 ppb	0.3 ppm
5	8/20/2015 9:50:04 AM	0 %LEL	20.9 %	0.0 ppm	0 ppm	0 ppb	0.0 ppm
6	8/20/2015 9:50:14 AM	0 %LEL	20.9 %	0.0 ppm	0 ppm	0 ppb	0.0 ppm
7	8/20/2015 9:50:24 AM	0 %LEL	20.9 %	0.0 ppm	0 ppm	0 ppb	0.3 ppm
8	8/20/2015 9:50:34 AM	0 %LEL	20.9 %	0.0 ppm	0 ppm	0 ppb	0.0 ppm
9	8/20/2015 9:50:44 AM	0 %LEL	20.9 %	0.0 ppm	0 ppm	0 ppb	0.0 ppm
10	8/20/2015 9:50:54 AM	0 %LEL	20.9 %	0.0 ppm	0 ppm	0 ppb	0.3 ppm
11	8/20/2015 9:51:04 AM	0 %LEL	20.9 %	0.0 ppm	0 ppm	0 ppb	0.0 ppm
12	8/20/2015 9:51:14 AM	0 %LEL	20.9 %	0.0 ppm	0 ppm	0 ppb	0.0 ppm
13	8/20/2015 9:51:24 AM	0 %LEL	20.9 %	0.0 ppm	0 ppm	136 ppb	0.3 ppm
14	8/20/2015 9:51:25 AM	----	----	WARNING	----	----	----
15	8/20/2015 9:51:27 AM	----	WARNING	----	WARNING	----	----
16	8/20/2015 9:51:28 AM	WARNING	----	----	----	----	----
17	8/20/2015 9:51:34 AM	16 %LEL	17.7 %	18.5 ppm	29 ppm	3459 ppb	0.0 ppm
18	8/20/2015 9:51:41 AM	----	----	-WARNING	NORMAL	----	----
19	8/20/2015 9:51:41 AM	----	----	NORMAL	-WARNING	----	----
20	8/20/2015 9:51:44 AM	29 %LEL	14.5 %	11.0 ppm	27 ppm	1047 ppb	0.0 ppm
21	8/20/2015 9:51:48 AM	-WARNING	----	----	----	----	----
22	8/20/2015 9:51:48 AM	NORMAL	----	----	----	----	----
23	8/20/2015 9:51:50 AM	----	-WARNING	----	----	----	----
24	8/20/2015 9:51:50 AM	----	NORMAL	----	----	----	----
25	8/20/2015 9:51:54 AM	0 %LEL	19.6 %	0.0 ppm	0 ppm	64 ppb	0.3 ppm
26	8/20/2015 9:52:04 AM	0 %LEL	20.8 %	0.0 ppm	0 ppm	52 ppb	0.0 ppm
27	8/20/2015 9:52:14 AM	0 %LEL	20.9 %	0.0 ppm	0 ppm	44 ppb	0.0 ppm
28	8/20/2015 9:52:24 AM	0 %LEL	20.9 %	0.0 ppm	0 ppm	43 ppb	0.4 ppm
29	8/20/2015 9:52:34 AM	0 %LEL	20.9 %	0.0 ppm	0 ppm	34 ppb	0.0 ppm
30	8/20/2015 9:52:44 AM	0 %LEL	20.9 %	0.0 ppm	0 ppm	27 ppb	0.0 ppm
31	8/20/2015 9:52:54 AM	0 %LEL	20.9 %	0.0 ppm	0 ppm	20 ppb	0.3 ppm
32	8/20/2015 9:53:04 AM	0 %LEL	20.9 %	0.0 ppm	0 ppm	14 ppb	0.0 ppm
33	8/20/2015 9:53:14 AM	0 %LEL	20.9 %	0.0 ppm	0 ppm	8 ppb	0.0 ppm
34	8/20/2015 9:53:24 AM	0 %LEL	20.9 %	0.0 ppm	0 ppm	6 ppb	0.3 ppm

Figure 41: Interval Trend Data in Table Format

- In table format, the interval trend data is shown as the average gas readings over the user defined interval trend time. So if the data logging session started at 4:13:38 PM and the interval time is set to 1 minute, then the readings logged at 4:14:38 PM are the average reading for each channel over that one minute period.
 - Events are displayed on the screen under the channel in which they occur and with the time of the event. Events are displayed whether they occurred at scheduled log times or in between them. Events include gas alarms such as a warning condition, trouble conditions such as a low sensor failure, an indication that the unit is returning to “normal” condition after an alarm has been reset using the RESET button on the instrument, and changing the station ID during operation.
 - If you click the **Summary** button, the Data Window will split into two frames, one above the other, with the data table in the lower frame and the summary information shown in the upper frame. The summary information is the same as the one shown in the lower right frame in Figure 40. To return to the one frame format, click **Summary** again.
8. When the data is viewed in table format, if you move the cursor over an alarm event, it will change into a small symbol that looks like an alarm trend data file while it is kept over the alarm event.

Alarm trend cursor symbol

The screenshot shows the 'Data View(Interval Trend)' window with a table of gas readings. The columns are: No, Date/Time, CH4(100%LEL), O2(40.0%), H2S(100.0ppm), CO(500ppm), VOC(5000ppb), and HCN(15.0ppm). The table contains 27 rows of data. Several rows show 'WARNING' or 'NORMAL' status for different channels, with corresponding numerical values. A cursor symbol, which is a small grid icon, is positioned over the 'WARNING' cell in row 16, column 3 (CH4). A line points from the text 'Alarm trend cursor symbol' to this symbol.

No	Date/Time	CH4(100%LEL)	O2(40.0%)	H2S(100.0ppm)	CO(500ppm)	VOC(5000ppb)	HCN(15.0ppm)
1	8/20/2015 9:49:24 AM	0 %LEL	20.9 %	0.0 ppm	0 ppm	0 ppb	0.3 ppm
2	8/20/2015 9:49:34 AM	0 %LEL	20.9 %	0.0 ppm	0 ppm	0 ppb	0.0 ppm
3	8/20/2015 9:49:44 AM	0 %LEL	20.9 %	0.0 ppm	0 ppm	0 ppb	0.0 ppm
4	8/20/2015 9:49:54 AM	0 %LEL	20.9 %	0.0 ppm	0 ppm	0 ppb	0.3 ppm
5	8/20/2015 9:50:04 AM	0 %LEL	20.9 %	0.0 ppm	0 ppm	0 ppb	0.0 ppm
6	8/20/2015 9:50:14 AM	0 %LEL	20.9 %	0.0 ppm	0 ppm	0 ppb	0.0 ppm
7	8/20/2015 9:50:24 AM	0 %LEL	20.9 %	0.0 ppm	0 ppm	0 ppb	0.3 ppm
8	8/20/2015 9:50:34 AM	0 %LEL	20.9 %	0.0 ppm	0 ppm	0 ppb	0.0 ppm
9	8/20/2015 9:50:44 AM	0 %LEL	20.9 %	0.0 ppm	0 ppm	0 ppb	0.0 ppm
10	8/20/2015 9:50:54 AM	0 %LEL	20.9 %	0.0 ppm	0 ppm	0 ppb	0.3 ppm
11	8/20/2015 9:51:04 AM	0 %LEL	20.9 %	0.0 ppm	0 ppm	0 ppb	0.0 ppm
12	8/20/2015 9:51:14 AM	0 %LEL	20.9 %	0.0 ppm	0 ppm	0 ppb	0.0 ppm
13	8/20/2015 9:51:24 AM	0 %LEL	20.9 %	0.0 ppm	0 ppm	136 ppb	0.3 ppm
14	8/20/2015 9:51:25 AM	----	----	WARNING	----	----	----
15	8/20/2015 9:51:27 AM	----	----	WARNING	----	WARNING	----
16	8/20/2015 9:51:28 AM	WARNING	----	----	----	----	----
17	8/20/2015 9:51:34 AM	16 %LEL	17.7 %	18.5 ppm	29 ppm	3459 ppb	0.0 ppm
18	8/20/2015 9:51:41 AM	----	----	-WARNING	NORMAL	----	----
19	8/20/2015 9:51:41 AM	----	----	NORMAL	-WARNING	----	----
20	8/20/2015 9:51:44 AM	29 %LEL	14.5 %	11.0 ppm	27 ppm	1047 ppb	0.0 ppm
21	8/20/2015 9:51:48 AM	-WARNING	----	----	----	----	----
22	8/20/2015 9:51:48 AM	NORMAL	----	----	----	----	----
23	8/20/2015 9:51:50 AM	----	-WARNING	----	----	----	----
24	8/20/2015 9:51:50 AM	----	NORMAL	----	----	----	----
25	8/20/2015 9:51:54 AM	0 %LEL	19.6 %	0.0 ppm	0 ppm	64 ppb	0.3 ppm
26	8/20/2015 9:52:04 AM	0 %LEL	20.8 %	0.0 ppm	0 ppm	52 ppb	0.0 ppm
27	8/20/2015 9:52:04 AM	0 %LEL	20.9 %	0.0 ppm	0 ppm	44 ppb	0.0 ppm
28	8/20/2015 9:52:04 AM	0 %LEL	20.9 %	0.0 ppm	0 ppm	43 ppb	0.4 ppm

Figure 42: Alarm Trend Cursor Symbol

If you click on the event, the corresponding alarm trend data file will be opened in a new window that pops up over the Data Window. No control buttons will be visible along the right side of the new window when an alarm trend data file is displayed in this way. To return to the interval trend data file, click the **Return** button or click the “X” in the upper right corner of the new window to close the window.

Click to return to interval trend data

No	Date/Time	CH4(100%LEL)	O2(40.0%)	H2S(100.0ppm)	CO(500ppm)	VOC(5000ppb)	HCN(15.0ppm)
344	8/20/2015 9:50:00 AM	0 %LEL	20.9 %	0.0 ppm	0 ppm	0 ppb	0.0 ppm
345	8/20/2015 9:50:05 AM	0 %LEL	20.9 %	0.0 ppm	0 ppm	0 ppb	0.0 ppm
346	8/20/2015 9:50:10 AM	0 %LEL	20.9 %	0.0 ppm	0 ppm	0 ppb	0.0 ppm
347	8/20/2015 9:50:15 AM	0 %LEL	20.9 %	0.0 ppm	0 ppm	0 ppb	0.0 ppm
348	8/20/2015 9:50:20 AM	0 %LEL	20.9 %	0.0 ppm	0 ppm	0 ppb	3.6 ppm
349	8/20/2015 9:50:25 AM	0 %LEL	20.9 %	0.0 ppm	0 ppm	0 ppb	0.0 ppm
350	8/20/2015 9:50:30 AM	0 %LEL	20.9 %	0.0 ppm	0 ppm	0 ppb	0.0 ppm
351	8/20/2015 9:50:35 AM	0 %LEL	20.9 %	0.0 ppm	0 ppm	0 ppb	0.0 ppm
352	8/20/2015 9:50:40 AM	0 %LEL	20.9 %	0.0 ppm	0 ppm	0 ppb	0.0 ppm
353	8/20/2015 9:50:45 AM	0 %LEL	20.9 %	0.0 ppm	0 ppm	0 ppb	0.0 ppm
354	8/20/2015 9:50:50 AM	0 %LEL	20.9 %	0.0 ppm	0 ppm	0 ppb	3.8 ppm
355	8/20/2015 9:50:55 AM	0 %LEL	20.9 %	0.0 ppm	0 ppm	0 ppb	0.0 ppm
356	8/20/2015 9:51:00 AM	0 %LEL	20.9 %	0.0 ppm	0 ppm	0 ppb	0.0 ppm
357	8/20/2015 9:51:05 AM	0 %LEL	20.9 %	0.0 ppm	0 ppm	0 ppb	0.0 ppm
358	8/20/2015 9:51:10 AM	0 %LEL	20.9 %	0.0 ppm	0 ppm	0 ppb	0.0 ppm
359	8/20/2015 9:51:15 AM	0 %LEL	20.9 %	0.0 ppm	0 ppm	73 ppb	0.0 ppm
360	8/20/2015 9:51:20 AM	0 %LEL	20.9 %	0.0 ppm	0 ppm	812 ppb	3.7 ppm
361	8/20/2015 9:51:25 AM	0 %LEL	20.9 %	12.5 ppm	6 ppm	3388 ppb	0.0 ppm
362	8/20/2015 9:51:30 AM	30 %LEL	15.6 %	23.5 ppm	43 ppm	3567 ppb	0.0 ppm
363	8/20/2015 9:51:35 AM	38 %LEL	13.7 %	24.0 ppm	45 ppm	3588 ppb	0.0 ppm
364	8/20/2015 9:51:40 AM	38 %LEL	13.1 %	24.0 ppm	46 ppm	3579 ppb	0.0 ppm
365	8/20/2015 9:51:45 AM	20 %LEL	14.6 %	0.0 ppm	13 ppm	88 ppb	0.0 ppm
366	8/20/2015 9:51:50 AM	0 %LEL	18.7 %	0.0 ppm	1 ppm	69 ppb	0.0 ppm
367	8/20/2015 9:51:55 AM	0 %LEL	20.1 %	0.0 ppm	2 ppm	62 ppb	3.8 ppm
368	8/20/2015 9:52:00 AM	0 %LEL	20.7 %	0.0 ppm	0 ppm	58 ppb	0.0 ppm
369	8/20/2015 9:52:05 AM	0 %LEL	20.9 %	0.0 ppm	0 ppm	49 ppb	0.0 ppm
370	8/20/2015 9:52:10 AM	0 %LEL	20.9 %	0.0 ppm	0 ppm	45 ppb	0.0 ppm
371	8/20/2015 9:52:15 AM	0 %LEL	20.9 %	0.0 ppm	0 ppm	50 ppb	0.0 ppm
372	8/20/2015 9:52:20 AM	0 %LEL	20.9 %	0.0 ppm	0 ppm	49 ppb	0.0 ppm
373	8/20/2015 9:52:25 AM	0 %LEL	20.9 %	0.0 ppm	0 ppm	42 ppb	4.0 ppm
374	8/20/2015 9:52:30 AM	0 %LEL	20.9 %	0.0 ppm	0 ppm	37 ppb	0.0 ppm
375	8/20/2015 9:52:35 AM	0 %LEL	20.9 %	0.0 ppm	0 ppm	35 ppb	0.0 ppm
376	8/20/2015 9:52:40 AM	0 %LEL	20.9 %	0.0 ppm	0 ppm	32 ppb	0.0 ppm
377	8/20/2015 9:52:45 AM	0 %LEL	20.9 %	0.0 ppm	0 ppm	29 ppb	0.0 ppm

Figure 43: Data Displayed by Alarm Trend Cursor Symbol

9. To view only events in the interval trend data file, click the **Events Only** selection box to select it.
10. To view the interval trend data in condensed form, click the **Condensed** selection box to select it. When the data is condensed, the software shows only important and eventful data as follows:
 - The first and last scheduled data points in the session are shown.
 - If there are more than two consecutive data points with the same readings for all channels, only the first and last of these consecutive data points are shown.
 - All events, such as gas alarms or sensor failures, are shown.
 - For any event, the data point before and after the event is always shown.

11. To view the data in graph format, click the **Graph** selection button. Five or more scheduled data points are required in an interval trend data file to be able to display it in graph format.

NOTE: The data count shown when you have selected an interval trend data file, as in Figure 40 above, can be more than five if you have events, such as the instrument going into and out of alarm, but you may not have five scheduled data points.

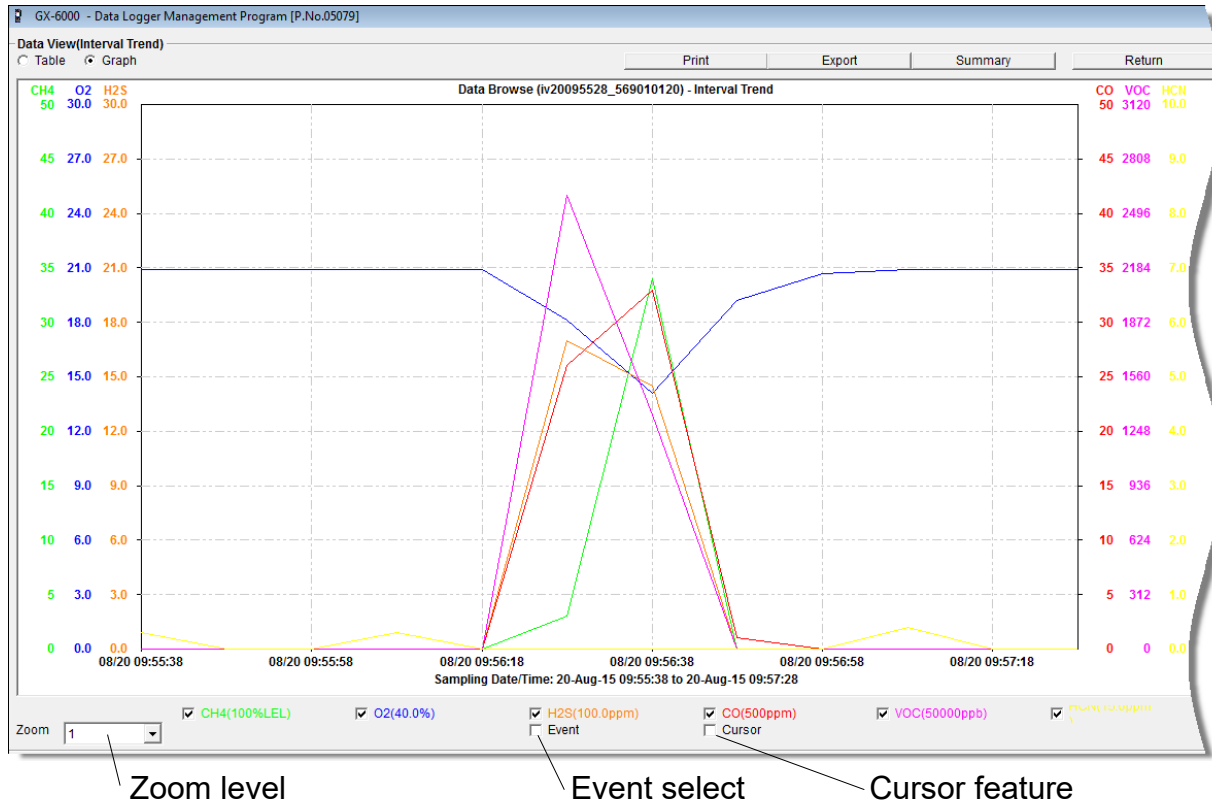

Figure 44: Interval Trend Data in Graph Format

When viewing interval trend data in graph format, you have several options:

- You can choose which gas you want to graph
- You can choose the zoom level, or displayed time interval, on the graph. The zoom feature shows greater detail relative to time. Thus, the length of a time division on the graph will depend on both the length of the datalogging session and on the zoom factor. Depending on the length of the data session, data sessions that show changing readings will normally have more choices for zoom levels than sessions that show stable data to allow for viewing of gas reading changes in greater detail.

- When selected, the Cursor feature allows you to display the gas reading and log time for each data point saved on the graph. The number of data points on the graph is minimized depending on the length of a data session by several means including omitting consecutive data points that have the same gas readings. As you use the left and right arrow buttons on your keyboard to move the cursor across the graph horizontally, readings at specific log times are displayed. Use the up and down arrows on the keyboard to move the readings up or down on the screen.
 - If you click the **Summary** button, the data window will split into two frames, one above the other, with the graph in the lower frame and the summary information shown in the upper frame. The summary information is the same as the information shown in the lower right frame in Figure 40. To return to the one frame format, click **Summary** again.
 - When you select the Event box, indications appear on the graph pointing to the exact time that a warning, alarm, start of calibration, or end of calibration occurred. Each indication is color coded to each gas color.
12. To print the data, whether it is viewed in table or graph format, click the **Print** button. A Printer List dialog box will appear for you to select a printer.

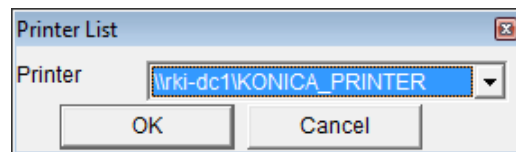

Figure 45: Printer List Dialog Box, Interval Data

13. Select a printer and click **OK** to print the data. Data displayed in Graph view will print as a graph and data displayed in Table view will print as a table.

14. To export the data to a file so it can be used by another application, for example a spreadsheet or database (for table data) or a word processing or presentation program (for graph data), click the **Export** button. A “Save As” dialog box will appear for you to specify the filename, file location, and file type.

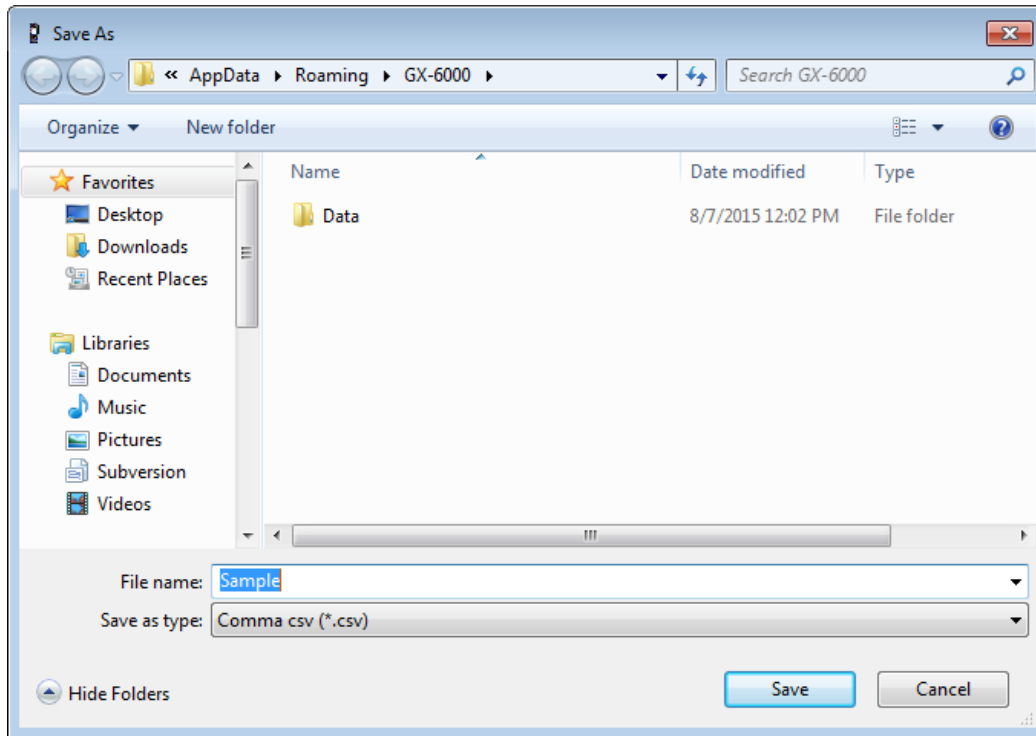

Figure 46: Save as Dialog Box

For Graph view, the export file type is Windows bitmap (.bmp). For Table view, the default file type is “.csv” (comma-separated values). After specifying the file name, file location, and file type click the **Save** button to save the file to the specified location.

15. To go back and view other data, click the **Return** button in the upper right corner of the Data Window or the **Data** button on the right side of the program window and select the data you want to view.

Alarm Trend Data

In addition to the interval trend data, the instrument also saves files that describe the most recent gas alarm events. If a gas alarm event occurs, then an alarm trend file that is centered around the event is saved separately from the interval trend data files. It shows the readings up to 30 minutes before and 30 minutes after the event, with the log interval time every five seconds. The gas readings logged at the alarm event time are highlighted in red and the gas readings logged every 5 seconds around the alarm event are the peak (minimum for oxygen) readings for the previous five seconds. If the instrument has not been on for 30 minutes before the

alarm event occurs, the data during this time is left blank. If the instrument is turned off less than 30 minutes after an alarm event occurs, the data file will only have logged data until the unit was turned off.

NOTE: If you are operating your instrument in Inert Mode with the oxygen alarm pattern set to H-HH, the maximum reading for the oxygen channel will be saved every 5 seconds instead of the minimum.

The instrument saves up to 8 alarm trend files. When an alarm event triggers an alarm trend file to be saved, subsequent alarm events must occur 15 minutes after the previous triggering event in order to trigger the saving of another alarm trend file. If 8 alarm trend files are already saved in the instrument's memory, the oldest alarm trend file is overwritten when a new alarm trend file is saved. Alarm trend data can always be displayed in either table or graph format.

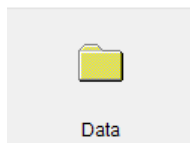

To view and perform desired operations with the alarm trend files:

1. With the software already launched, click the **Data** control button along the right side of the program window. The Data Window will appear.

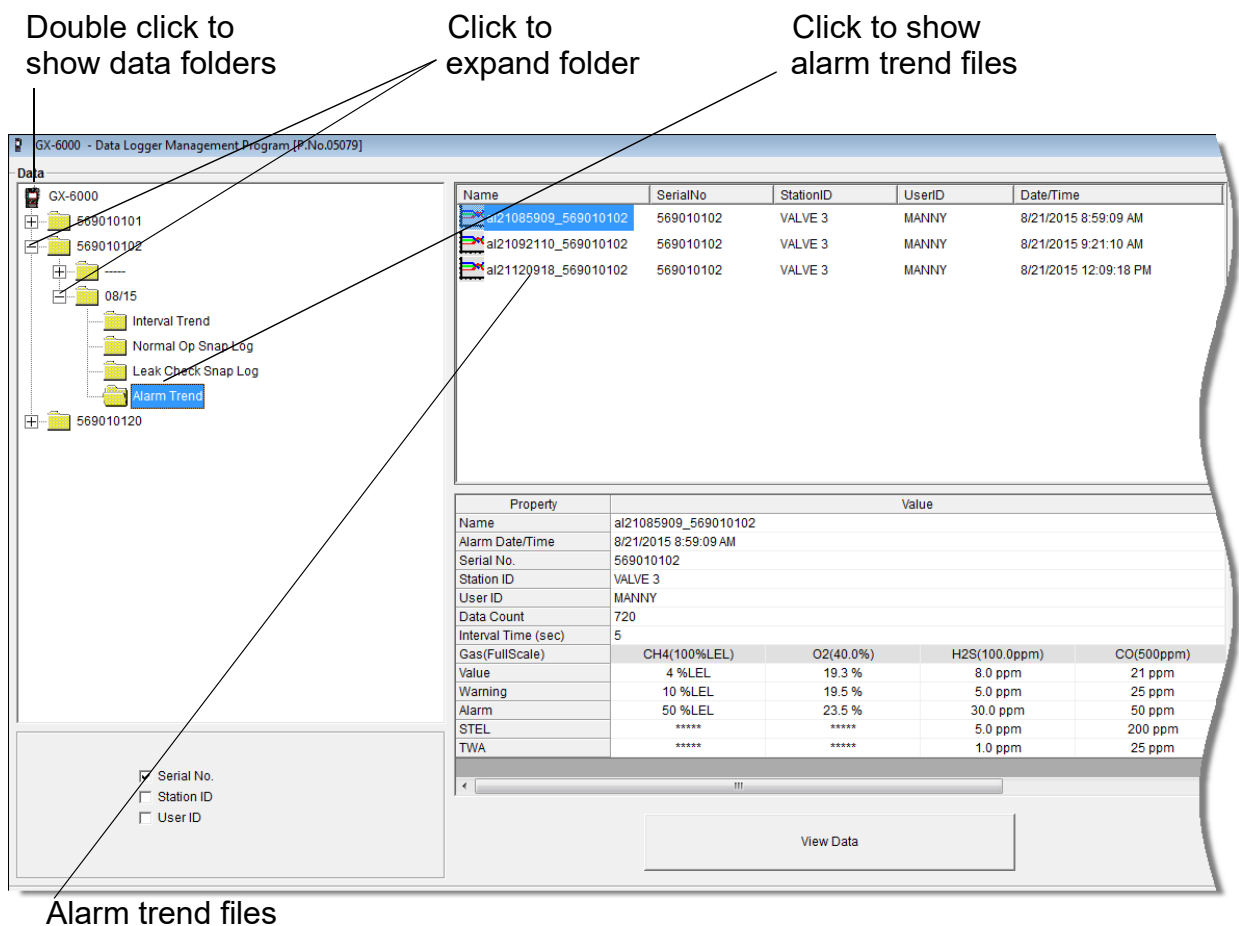

Figure 47: Data Window - Selecting Interval Trend Data Files

2. If necessary, double-click the GX-6000 icon in the top of the Data window's upper left frame to see the folders of downloaded data.
3. Find your instrument by serial number, then click the expanded view symbol (+) of or double-click the serial number folder to view the contents. The top folder is untitled and contains the Calibration History folder and Bump Test Data Folder along with folders for alarm events and trouble events. The rest of the folders contain folders for the interval trend files, snap log data, and alarm trend files and are named and organized by date (month/year).
4. Click the expanded view symbol (+) of or double-click the dated folder whose contents you want to see.
5. Click on the Alarm Trend Folder in the upper left frame. In the upper right frame of the Data window, a list of file names will appear in the Name column. A prefix of "al" indicates an alarm trend data file. The serial number, station ID, user ID, and date/time appear on the line

for each alarm trend file. The date/time is the date and time that the data file was created and data began being recorded in that file.

- Click one of the alarm trend data file names. A summary will appear in the bottom right frame with instrument and alarm setting information. If you want to view, graph, print, or export the alarm trend data, double-click the filename or click the **View Data** button at the bottom of the window.
- Alarm trend data can be viewed in either table or graph format by selecting the Table or Graph selection buttons. The example below in Figure 48 is in table format.

Table or graph view

Print data

Save data to a file

Data summary

No	Date/Time	CH4(100%LEL)	O2(40.0%)	H2S(100.0ppm)	CO(500ppm)	VOC(5000ppb)	HCN(15.0ppm)
345	8/20/2015 9:55:00 AM	----	----	----	----	----	----
346	8/20/2015 9:55:05 AM	----	----	----	----	----	----
347	8/20/2015 9:55:10 AM	----	----	----	----	----	----
348	8/20/2015 9:55:15 AM	----	----	----	----	----	----
349	8/20/2015 9:55:20 AM	----	----	----	----	----	----
350	8/20/2015 9:55:25 AM	----	----	----	----	----	----
351	8/20/2015 9:55:30 AM	0 %LEL	20.9 %	0.0 ppm	0 ppm	0 ppb	3.8 ppm
352	8/20/2015 9:55:35 AM	0 %LEL	20.9 %	0.0 ppm	0 ppm	0 ppb	0.0 ppm
353	8/20/2015 9:55:40 AM	0 %LEL	20.9 %	0.0 ppm	0 ppm	0 ppb	0.0 ppm
354	8/20/2015 9:55:45 AM	0 %LEL	20.9 %	0.0 ppm	0 ppm	0 ppb	0.0 ppm
355	8/20/2015 9:55:50 AM	0 %LEL	20.9 %	0.0 ppm	0 ppm	0 ppb	0.0 ppm
356	8/20/2015 9:55:55 AM	0 %LEL	20.9 %	0.0 ppm	0 ppm	0 ppb	0.0 ppm
357	8/20/2015 9:56:00 AM	0 %LEL	20.9 %	0.0 ppm	0 ppm	0 ppb	3.5 ppm
358	8/20/2015 9:56:05 AM	0 %LEL	20.9 %	0.0 ppm	0 ppm	0 ppb	0.0 ppm
359	8/20/2015 9:56:10 AM	0 %LEL	20.9 %	0.0 ppm	0 ppm	0 ppb	0.0 ppm
360	8/20/2015 9:56:15 AM	0 %LEL	20.9 %	0.0 ppm	0 ppm	0 ppb	0.0 ppm
361	8/20/2015 9:56:20 AM	0 %LEL	20.9 %	10.5 ppm	4 ppm	3003 ppb	0.0 ppm
362	8/20/2015 9:56:25 AM	0 %LEL	16.6 %	24.0 ppm	40 ppm	3237 ppb	0.0 ppm
363	8/20/2015 9:56:30 AM	36 %LEL	14.0 %	24.5 ppm	45 ppm	3263 ppb	0.0 ppm
364	8/20/2015 9:56:35 AM	36 %LEL	13.0 %	25.0 ppm	47 ppm	3256 ppb	0.0 ppm
365	8/20/2015 9:56:40 AM	33 %LEL	14.2 %	1.5 ppm	17 ppm	0 ppb	0.0 ppm
366	8/20/2015 9:56:45 AM	1 %LEL	18.6 %	0.0 ppm	3 ppm	0 ppb	0.0 ppm
367	8/20/2015 9:56:50 AM	1 %LEL	20.1 %	0.0 ppm	0 ppm	0 ppb	0.0 ppm
368	8/20/2015 9:56:55 AM	0 %LEL	20.6 %	0.0 ppm	1 ppm	0 ppb	0.0 ppm
369	8/20/2015 9:57:00 AM	0 %LEL	20.9 %	0.0 ppm	0 ppm	0 ppb	0.0 ppm
370	8/20/2015 9:57:05 AM	0 %LEL	20.9 %	0.0 ppm	0 ppm	0 ppb	4.0 ppm
371	8/20/2015 9:57:10 AM	0 %LEL	20.9 %	0.0 ppm	1 ppm	0 ppb	0.0 ppm
372	8/20/2015 9:57:15 AM	0 %LEL	20.9 %	0.0 ppm	0 ppm	0 ppb	0.0 ppm
373	8/20/2015 9:57:20 AM	0 %LEL	20.9 %	0.0 ppm	0 ppm	0 ppb	0.0 ppm
374	8/20/2015 9:57:25 AM	0 %LEL	20.9 %	0.0 ppm	0 ppm	0 ppb	0.0 ppm
375	8/20/2015 9:57:30 AM	----	----	----	----	----	----
376	8/20/2015 9:57:35 AM	----	----	----	----	----	----
377	8/20/2015 9:57:40 AM	----	----	----	----	----	----
378	8/20/2015 9:57:45 AM	----	----	----	----	----	----

Alarm event

Figure 48: Alarm Trend Data in Table Format

- In table format, the log times are shown along with the peak (minimum for oxygen) gas readings for the previous five seconds.
- The gas readings at the time of the alarm event around which the logged data are centered are highlighted in red and are the instantaneous readings at that time.

- If you click the **Summary** button, the data window will split into two frames, one above the other, with the data table in the lower frame and the summary information shown in the upper frame. The summary information is the same as the information shown in the lower right frame in Figure 47.
8. To view the data in graph format, click the **Graph** button. An alarm trend file can always be graphed regardless of the number of logged points.

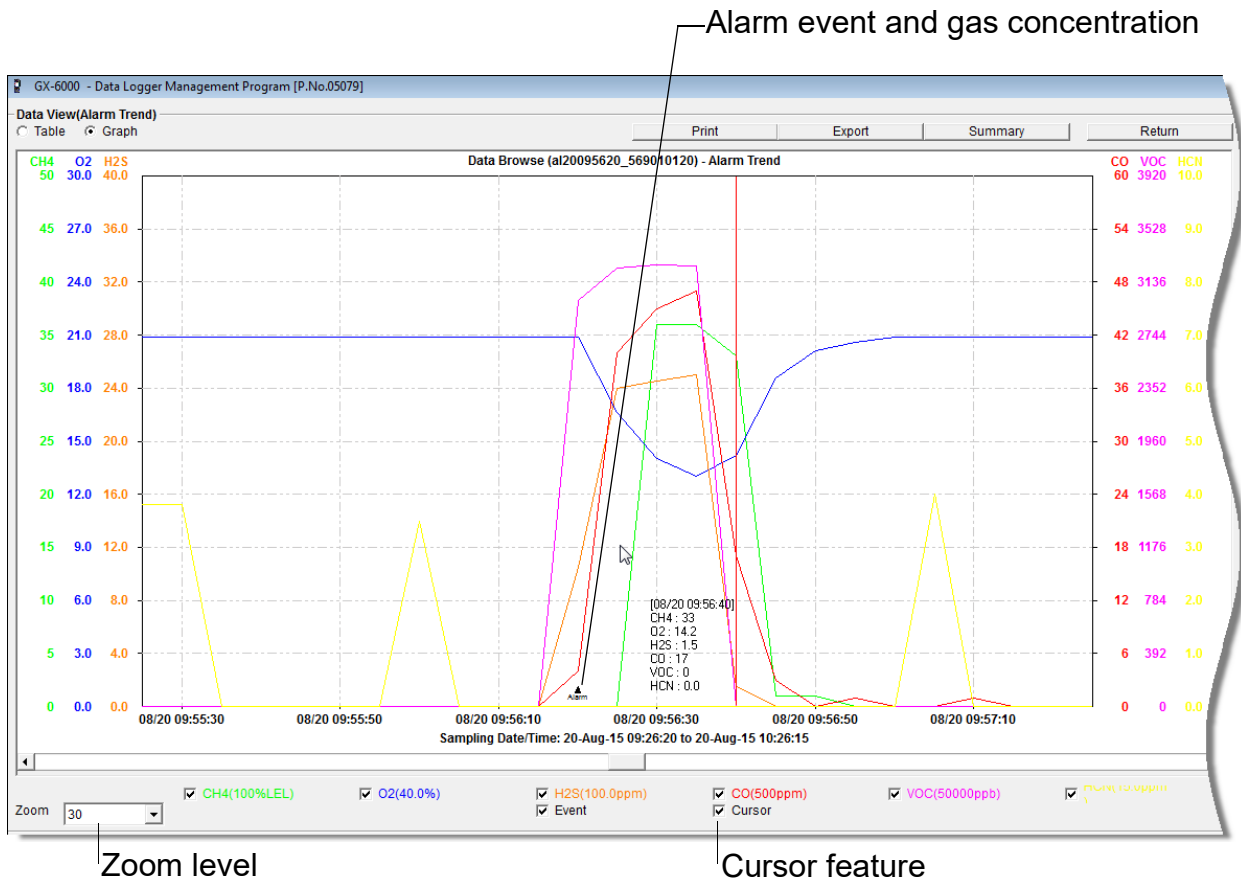

Figure 49: Alarm Trend Data in Graph Format

When viewing alarm trend data in graph format, you have several options:

- You can choose which gas you want to graph
- You can choose the zoom level, or displayed time interval, on the graph. The zoom feature shows greater detail relative to time. Thus, the length of a time division on the graph will depend on both the length of the datalogging session and on the zoom factor.

- When selected, the Cursor feature allows you to display the gas reading and log time for each data point in the alarm trend file. As you use the left and right arrow buttons on your keyboard to move the cursor across the graph horizontally, readings at specific log times are displayed. Use the up and down arrows on the keyboard to move the readings up or down on the screen.
 - If you click the **Summary** button, the data window will split into two frames, one above the other, with the graph in the lower frame and the summary information shown in the upper frame. The summary information is the same as the information shown in the lower right frame in Figure 47. To return to the one frame format, click **Summary** again.
 - When you select the Event box, an indication appears to show which alarm event created the alarm trend file that was opened.
9. To print the data, whether it is viewed in table or graph format, click the **Print** button. A Printer List dialog box will appear for you to select a printer.

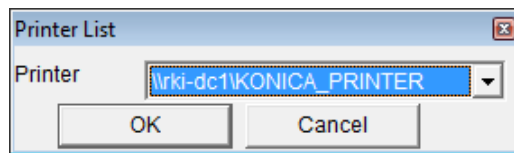

Figure 50: Printer List Dialog Box, Interval Data

10. Select a printer and click **OK** to print the data. Data displayed in Graph view will print as a graph and data displayed in Table view will print as a table.

11. To export the data to another application, for example a spreadsheet or database (for table data) or a word processing or presentation program (for graph data), click the **Export** button. A “Save As” dialog box will appear for you to specify the filename, file location, and file type.

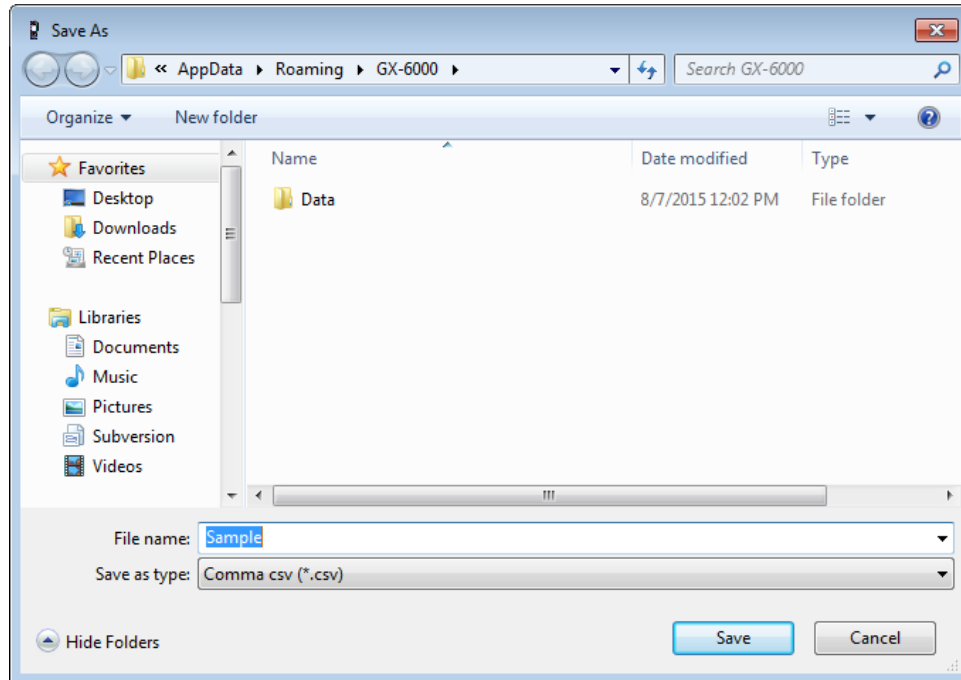

Figure 51: Save as Dialog Box

For Graph view the export file type is Windows bitmap (.bmp). For Table view the default file type is “.csv” (comma-separated values). After specifying the file name, file location, and file type click the **Save** button to save the file to the specified location.

12. To go back and view other data, click the **Return** button in the upper right corner of the Data Window or the **Data** button on the right side of the program window and select the data you want to view.

Deleting Data in the Data Window

The following items can be deleted in the Data Window:

- Data folders
- Calibration History files
- Bump Test Data files
- Alarm and Trouble Event files
- Snap Log Data files
- Interval Trend and Alarm Trend data files

To delete any of the above items in the Data Window:

1. With the program launched, click the Data control button on the right side of the program window.
2. Find the folder or file you want to delete.
3. Place the cursor on the folder or file you want to delete and click it with the right mouse button. The Delete box will appear.

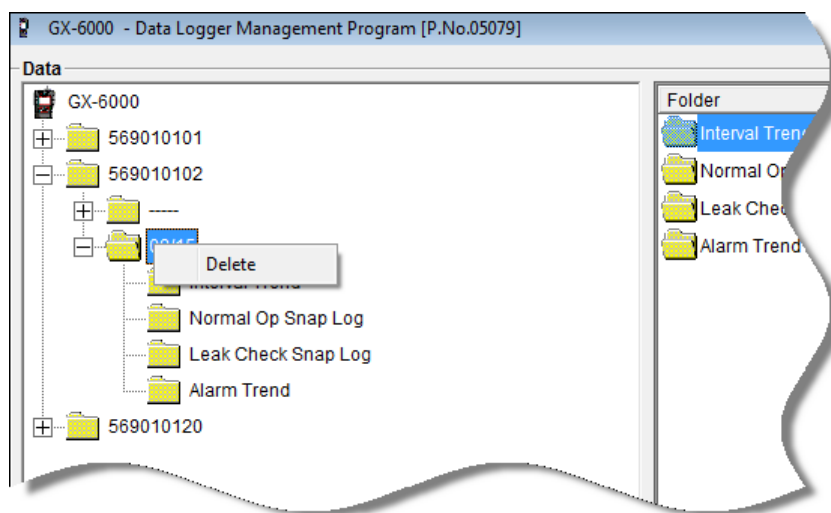

Figure 52: Delete Box

4. Click Delete with the left mouse button. The Password Window appears.

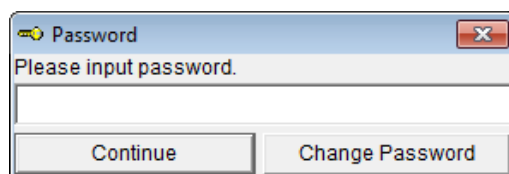

Figure 53: Password Window

5. Enter the password and click **Continue**. The password when the program is first installed is "rki". The password is case sensitive. See "Changing the Password" on page 64 for instructions to change the password if desired.

- When the password has been entered and **Continue** clicked, the Delete Data Window (if a folder is selected for deletion) or Delete Sample Window (if a file is selected for deletion) will appear asking you to confirm that you want to delete the selected folder or file. In the example below, the Delete Data Window appears because the data folder shown in Figure 52 has been selected for deletion.

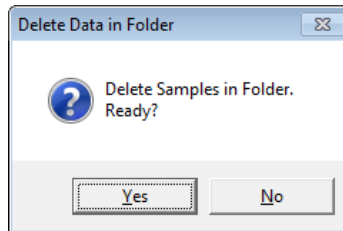

Figure 54: Delete Data Window

- If you want to delete the selected item, click **Yes**. The item will be deleted by the program.

If you do not want to delete the selected item, click **No** and the operation will be cancelled.

Changing the Password

CAUTION: *Changing the password requires use of the Delete box. Take care to avoid accidentally deleting data if you decide to change the password.*

It is possible to change that password as follows:

1. Right-click a data folder, data file, or event file. The Delete box will appear.

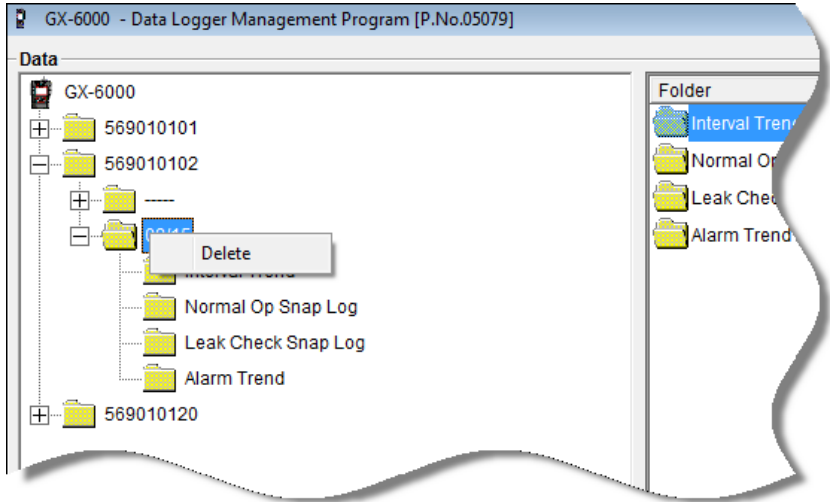

Figure 55: Delete Box

2. Click Delete with the left mouse button. The Password Window appears.

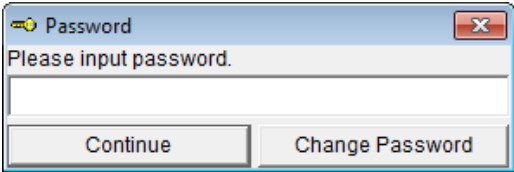

Figure 56: Password Window

3. Click **Change Password**. The Password Window asks you to input the current password.

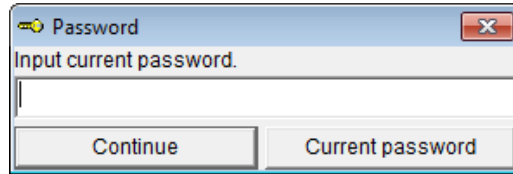

Figure 57: Inputting Current Password

4. Type the current password, then click **Current password**. The Password Window asks you to input the new password.

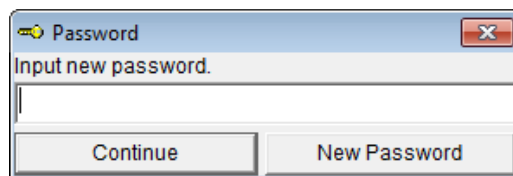

Figure 58: Inputting New Password

5. Type the new password and click **New Password**. The Password Window asks you to input the new password again to confirm it.

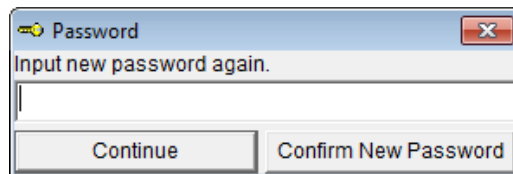

Figure 59: Confirming New Password

6. Type the new password again, then click **Confirm New Password**.
7. Click **OK** when the program confirms that you have changed the password.

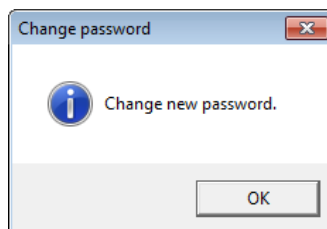

Figure 60: Confirming New Password

8. Close the Password Window by clicking the red "X" in the upper right corner of the window.

Last Calibration Window

You can access data on the most recent successful calibration and bump test for each instrument that has been downloaded in the Last Calibration Window. You can view, print (calibration date/bump test date only), and delete this data in the Last Calibration Window.

NOTE: If the GX-6000 Data Logger Management Program database is on the user's computer (default setting), data will only appear for instruments downloaded to that computer. If the database is on a network, data will appear for all instruments downloaded to that database. See "Accessing a Common Database" on page 18 for more instruction.

Effects of BUMP DISP Parameter Setting on Appearance of Last Calibration Window

The setting of the **BUMP DISP** instrument parameter has an effect on the appearance of the Last Calibration Window. This instrument parameter can be set in the instrument's Maintenance Mode. The factory setting is **OFF**.

If the **BUMP DISP** parameter is set to **OFF** for every instrument that has been downloaded to the GX-6000 Data Logger Management Program using the Complete Download or Instrument Information download buttons, the Last Calibration Window will appear as shown in the screen below. The screen is shown with the Need Calibration option selected. The Bump Test portion of this window is not shown.

GX-6000 - Data Logger Management Program [P.No.05079]

Last Calibration

Need Calibration Calibration Date Calibration Record

No.	SerialNo	UserID	StationID	CH4	O2	H2S	CO		Last Download
1	569010102	MANNY	VALVE 3	8/20/2015 11:32:33 A	8/20/2015 11:32:33 A	8/20/2015 11:32:33 A	8/20/2015 11:32:33 A	----	8/20/2015 11:40:14 A
2	569010120	KIMBERLY	BUILDING 7	8/20/2015 11:32:07 A	8/20/2015 11:32:07 A	8/20/2015 11:32:07 A	8/20/2015 11:32:07 A	8/6/2015 11:23:27 AM	8/20/2015 11:38:26 A
3	569010101	KATIE	VALVE 3	8/20/2015 11:31:31 A	8/20/2015 11:31:31 A	8/20/2015 11:31:31 A	8/20/2015 11:31:31 A	----	8/20/2015 11:36:55 A

Figure 61: Last Calibration Window: BUMP DISP Off

If any instrument has been downloaded to the GX-6000 Data Logger Management Program using the Complete Download or Instrument Information download buttons that has the **BUMP DISP** parameter set to **ON**, the Last Calibration Window will appear as below. The screen below is shown with the Need Calibration and Need Bump Test options selected. Only instruments that had the **BUMP DISP** instrument parameter turned **ON** when downloaded will appear in the Bump Test portion of the window. It should be noted that once an instrument that has the **BUMP DISP** parameter set to **ON** has been downloaded using the Complete Download or Instrument Information download buttons, the Bump Test portion of this screen will always appear.

GX-6000 - Data Logger Management Program [P.No.05079]									
Last Calibration									
<input checked="" type="radio"/> Need Calibration <input type="radio"/> Calibration Date <input type="radio"/> Calibration Record <input type="button" value="Print"/>									
No.	SerialNo	UserID	StationID	CH4	O2	H2S	CO		Last Download
1	569010102	MANNY	VALVE 3	8/20/2015 12:34:22 F	8/20/2015 12:34:22 F	8/20/2015 12:34:22 F	8/20/2015 12:34:22 F	----	8/21/2015 8:48:13 AM
2	569010101	KATIE	VALVE 3	8/20/2015 12:33:23 F	8/20/2015 12:33:23 F	8/20/2015 12:33:23 F	8/20/2015 12:33:23 F	----	8/20/2015 12:44:09 P
3	569010120	KIMBERLY	BUILDING 7	8/20/2015 12:32:23 P	8/20/2015 12:32:23 P	8/20/2015 12:32:23 P	8/20/2015 12:32:23 P	8/6/2015 11:23:27 AM	8/20/2015 12:42:21 P

Last Bump Test									
<input checked="" type="radio"/> Need Bump Test <input type="radio"/> Bump Test Date <input type="radio"/> Bump Test Record <input type="button" value="Print"/>									
No.	SerialNo	UserID	StationID	CH4	O2	H2S	CO		Last Download
1	569010102	MANNY	VALVE 3	8/20/2015 12:34:22 F	8/20/2015 12:34:22 F	8/20/2015 12:34:22 F	8/20/2015 12:34:22 F	----	8/21/2015 8:48:13 AM
2	569010101	KATIE	VALVE 3	8/20/2015 12:33:23 F	8/20/2015 12:33:23 F	8/20/2015 12:33:23 F	8/20/2015 12:33:23 F	----	8/20/2015 12:44:09 P
3	569010120	KIMBERLY	BUILDING 7	8/20/2015 12:32:23 P	8/20/2015 12:32:23 P	8/20/2015 12:32:23 P	8/20/2015 12:32:23 P	8/6/2015 11:23:26 AM	8/20/2015 12:42:21 P

Figure 62: Last Calibration Window: BUMP DISP On

The following screens are shown with the Bump Test portion of the window active. If the **BUMP DISP** on all of the instruments you have downloaded is set to **OFF**, you will not see the Bump Test portion of these screens. For more information on setting the **BUMP DISP** parameter, see the GX-6000 Operator's Manual.

Viewing and Printing Last Calibration Data

Open the Last Calibration Window by clicking **Last Calibration** along the right side of the program window. When you open the Last Calibration Window the first time after launching the program, it will open with the Need Calibration/Need Bump Test view options selected. There are three view options in the Last Calibration window: Need Calibration/Need Bump Test, Calibration Date/Bump Test Date, and Calibration Record/Bump Test Record.

Need Calibration/Need Bump Test View Option

Selecting this option shows the last calibration date, last bump test date, and the last download date for the instruments that are due for calibration or bump testing. The calibration data appears at the top half of the screen while the bump test data appears in the bottom half of the screen.

NOTE: The calibration interval, the number of days after a calibration that a new calibration is due, is saved in the instrument but it is only accessible in the instrument's Maintenance Mode. If the calibration time limit is changed in the instrument using Maintenance Mode, the new calibration time limit value will not be known by the program until the instrument is downloaded.

The screenshot shows the 'Last Calibration' window in the GX-6000 Data Logger Management Program. The 'Need Calibration' view option is selected. The table below represents the data shown in the window:

No.	SerialNo	UserID	StationID	CH4	O2	H2S	CO	Last Download
1	569010102	MANNY	VALVE 3	8/20/2015 12:34:22 F	8/20/2015 12:34:22 F	8/20/2015 12:34:22 F	8/20/2015 12:34:22 F	8/21/2015 8:48:13 AM
2	569010101	KATIE	VALVE 3	8/20/2015 12:33:23 F	8/20/2015 12:33:23 F	8/20/2015 12:33:23 F	8/20/2015 12:33:23 F	8/20/2015 12:44:09 P
3	569010120	KIMBERLY	BUILDING 7	8/20/2015 12:32:23 P	8/20/2015 12:32:23 P	8/20/2015 12:32:23 P	8/20/2015 12:32:23 P	8/20/2015 12:42:21 P

Figure 63: Last Calibration Window: Need Calibration View Option

The Need Calibration/Need Bump Test view option shows the following fields for both calibration and bump test data:

- No. — lists, in numerical order, the sequence of instruments whose data have been downloaded to the computer. The most recently downloaded instrument will be No. 1.
- SerialNo — shows the serial number of the instrument that was downloaded.
- UserID — shows the user ID of the of the instrument that was downloaded.
- StationID — shows the station ID of the instrument that was downloaded.
- Target Gases (CH4 or HC, O2, H2S, CO) — shows when the unit was calibrated or bump tested for each of the target gases using the **MM/DD/YY** format and 24-hour military standard time.

- Last Downloaded — shows when the last download took place for a unit using the **MM/DD/YY** format and 24-hour military time standard.

The instruments that are due for calibration or bump testing (in the case of the Need Calibration/Need Bump Test view option, that will be all of them), will have their last calibration date or last bump test date highlighted in red. The instruments that have not been downloaded for more than 90 days will have their last download date highlighted in purple.

To print a list of the instruments shown in the Need Calibration/Need Bump Test view option along with their user ID and last calibration date or last bump test date, click the **Print** button. A Printer List dialog box will appear.

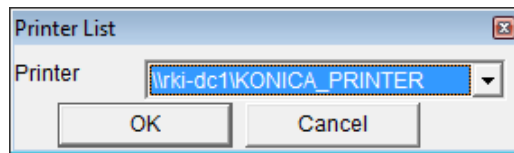

Figure 64: Printer List Dialog Box, Need Calibration View Option

Select a printer and click the **OK** button to print the instrument list.

Calibration Date/Bump Test Date View Option

Selecting this option shows the last calibration date, last bump test date, and the last download date for all the instruments that are in the program's database. The fields for the Calibration Date/Bump Test Date view option are the same as for the Need Calibration/Need Bump Test view option.

GX-6000 - Data Logger Management Program [P.No.05079]

Last Calibration
 Need Calibration Calibration Date Calibration Record

No.	SerialNo	UserID	StationID	CH4	O2	H2S	CO	VOC	Last Download
1	569010120	KIMBERLY	BUILDING 7	8/20/2015 12:32:23 F	8/20/2015 12:32:23 F	8/20/2015 12:32:23 F	8/20/2015 12:32:23 F	8/6/2015 11:23:27 AM	12/1/2015 11:56:15 AM
2	569010102	MANNY	VALVE 3	8/20/2015 12:34:22 F	8/20/2015 12:34:22 F	8/20/2015 12:34:22 F	8/20/2015 12:34:22 F	----	8/21/2015 8:48:13 AM
3	569010101	KATIE	VALVE 3	8/20/2015 12:33:23 F	8/20/2015 12:33:23 F	8/20/2015 12:33:23 F	8/20/2015 12:33:23 F	----	8/20/2015 12:44:09 P

Last Bump Test
 Need Bump Test Bump Test Date Bump Test Record

No.	SerialNo	UserID	StationID	CH4	O2	H2S	CO	VOC	Last Download
1	569010120	KIMBERLY	BUILDING 7	8/20/2015 12:32:23 F	8/20/2015 12:32:23 F	8/20/2015 12:32:23 F	8/20/2015 12:32:23 F	8/6/2015 11:23:26 AM	12/1/2015 11:56:15 AM
2	569010102	MANNY	VALVE 3	8/20/2015 12:34:22 F	8/20/2015 12:34:22 F	8/20/2015 12:34:22 F	8/20/2015 12:34:22 F	----	8/21/2015 8:48:13 AM
3	569010101	KATIE	VALVE 3	8/20/2015 12:33:23 F	8/20/2015 12:33:23 F	8/20/2015 12:33:23 F	8/20/2015 12:33:23 F	----	8/20/2015 12:44:09 P

Figure 65: Last Calibration Window: Calibration Date View Option

To print a list of the instruments shown in the Calibration Date/Bump Test Date view option along with their user ID and last calibration date or last bump test date, click the **Print** button. A Printer List dialog box will appear.

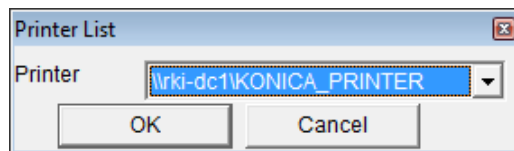

Figure 66: Printer List Dialog Box, Calibration Date View Option

Select a printer and click the **OK** button to print the instrument list.

Calibration Record/Bump Test Record View Option

Selecting the Calibration Record/Bump Test Record view option shows detailed calibration or bump test information for each instrument's most recent successful calibration or bump test.

GX-6000 - Data Logger Management Program [P.No.05079]									
- Last Calibration									
<input type="radio"/> Need Calibration <input type="radio"/> Calibration Date <input checked="" type="radio"/> Calibration Record <input type="button" value="Print"/>									
No.	SerialNo	UserID	StationID	Gas	Before	After	A.Cal.	Cal.Due(Days)	
1	569010120	KIMBERLY	BUILDING 7	CH4	61	50	50	50	Now
				O2	11.8	12.0	12.0	12.0	Now
				H2S	25.5	25.0	25.0	25.0	Now
				CO	51	50	50	50	Now
				VOC	10545	10000	20000	20000	Now
2	569010102	MANNY	VALVE 3	CH4	50	50	50	50	Now
				O2	11.6	12.0	12.0	12.0	Now
				H2S	25.0	25.0	25.0	25.0	Now
				CO	52	50	50	50	Now
3	569010101	KATIE	VALVE 3	CH4	51	50	50	50	Now
				O2	11.8	12.0	12.0	12.0	Now
				H2S	25.5	25.0	25.0	25.0	Now
				CO	51	50	50	50	Now

- Last Bump Test									
<input type="radio"/> Need Bump Test <input type="radio"/> Bump Test Date <input checked="" type="radio"/> Bump Test Record <input type="button" value="Print"/>									
No.	SerialNo	UserID	StationID	Gas	Test Result	Concentration	Bump Test Due(Days)		
1	569010120	KIMBERLY	BUILDING 7	CH4		50	50	50	Now
				O2		12.0	12.0	12.0	Now
				H2S		25.0	25.0	25.0	Now
				CO		50	50	50	Now
				VOC		10000	1000	1000	Now
2	569010102	MANNY	VALVE 3	CH4		50	50	50	Now
				O2		12.0	12.0	12.0	Now
				H2S		25.0	25.0	25.0	Now
				CO		50	50	50	Now
3	569010101	KATIE	VALVE 3	CH4		50	50	50	Now
				O2		12.0	12.0	12.0	Now
				H2S		25.0	25.0	25.0	Now
				CO		50	50	50	Now

Figure 67: Last Calibration Window: Calibration Record View Option

The fields on this screen include SerialNo, UserID, and StationID just as in the Need Calibration/Need Bump Test and Calibration Date/Bump Test Date screens. The Calibration Record fields also include the following:

- Gas — Lists the target gas for which the Before, After, and A.Cal readings are displayed.
- Before — shows the settings prior to calibration.
- After — shows the settings after calibration.
- A. Cal. — lists the auto-calibration setting for each channel of the instrument. If an instrument passes its calibration, the “After” column should match the “A. Cal.” column. If the instrument fails calibration on any of its channels, those channels will retain the previous calibration information.

NOTE: If a unit is calibrated using One Cal in the instrument's Calibration Mode (see the GX-6000 Operator's Manual) it is possible for the “After” reading to be different from the “A.Cal” setting if the unit was set to a level different than the “A.Cal” setting.

- Cal. Due (Days) — shows when calibration is due in days (e.g., “Remaining 25 Day” means that calibration is due in 25 days, and “Now” means that calibration is due immediately). If the instrument is due now, the box will be highlighted in red.

The Bump Test Record fields also include the following:

- Gas — Lists the target gas for which the Test Result and Concentration readings are displayed.
- Test Result — Shows the gas reading resulting from the bump test.
- Concentration — Shows the concentration values of the applied gas.
- Bump Test Due — Indicates what day a bump test is due for the instrument. If the instrument is due now, the box will be highlighted in red.

It is not possible to print any information when the Calibration Record/ Bump Test Record view option is selected.

To view and print all past calibrations for an instrument, see “Calibration History” on page 34.

Deleting Last Calibration Data

To delete an instrument and its calibration or bump test data from the Last Calibration Window:

1. With the program launched, click **Last Calibration** on the right side of the program window. The Last Calibration Window will appear.
2. Select the Need Calibration/Need Bump Test or Calibration Date/Bump Test Date option.
3. Click the row for the instrument whose calibration or bump test information you want to delete to select it. It will be highlighted to show that it is selected.
4. Click the row with the right mouse button. The Delete box appears.

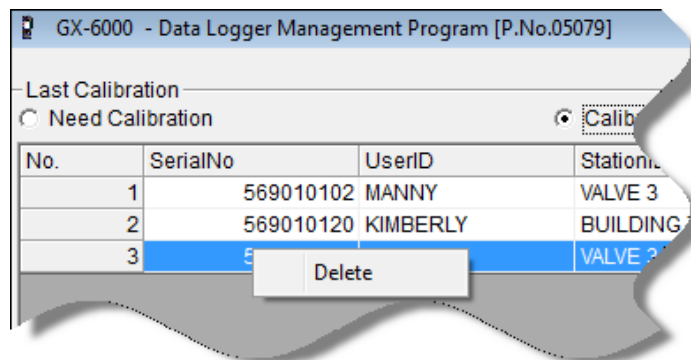

Figure 68: Delete Box

5. Click Delete with the left mouse button. The Password window appears.

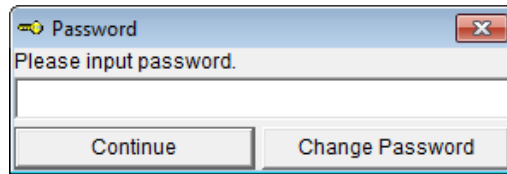

Figure 69: Password Window, Deleting Last Calibration Data

6. Enter the password and click the **Continue** button. The password when the software is first installed is “rki”. The password is case sensitive. See “Changing the Password” on page 64 for instructions to change the password if desired.
7. When the password has been entered and the **Continue** button clicked, the Delete History window will appear asking you to confirm that you want to delete the most recent calibration or bump test information for the selected instrument.

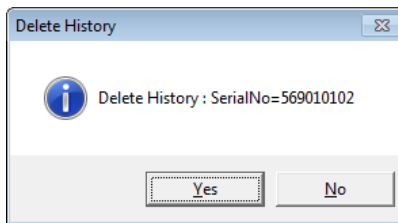

Figure 70: Delete History Window

8. If you want to delete the calibration or bump test information, click **Yes**. The information will be deleted by the program.

If you do not want to delete the calibration or bump test information, click **No** and the operation will be cancelled.

NOTE: Deleting instrument data from the folder list along the left side of the Data screen will not delete calibration data from the Last Calibration screen. Data in the Last Calibration screen must be deleted manually.

Set Window

Changing Instrument Parameters

To make changes to parameters stored in the instrument, use the GX-6000's Data Logger Management Program's Set Window. Follow the steps below to make these changes.

1. Launch the GX-6000 Data Logger Management Program.
2. If the Automatic Download selection box is selected, deselect it.
3. Connect an instrument to the program. See "Downloading Data from an Instrument" on page 22, instruction 1 through instruction 3, to connect an instrument to the program.
4. Once the connection is made, the **Complete Download**, **Instrument Information**, and **Power Off** download commands will be selectable. Click the **Instrument Information** download command to retrieve the instrument information from the instrument. If you wish to download data before making changes, click **Complete Download** instead of **Instrument Information**.

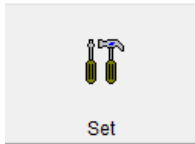

- Click the **Set** button to display the Set Window. Use the GX-6000 Status Frame and the Gas/Sensor Frame to change parameters stored in the instrument.

Click to upload changes to instrument

Sensor	Warning	Alarm	STEL	TWA	Auto Cal.	Ch
Gas						
CH4(100%LEL)	10	50	----	----	50	1
O2(40.0%)	19.5	23.5	----	----	12.0	2
H2S(100.0ppm)	5.0	30.0	15.0	10.0	25.0	3
CO(500ppm)	25	50	200	25	50	4
VOC(5000ppb)	4300	6000	----	----	20000	5
HCN(15.0ppm)	5.0	10.0	4.7	15.0	10.0	6

Figure 71: Set Window

- To change the serial number stored in the instrument, click the serial number field and use the backspace key to remove the current entry, then type the new serial number.
- To change the station ID or user ID, click on the down arrow in the desired box and select a new station ID or user ID from the list. The available station and user IDs are ones that are stored in the instrument's memory.
- To change the datalogging trend interval time, click on the down arrow in the Interval Trend Time box and select the desired interval time in seconds. The available choices are 10, 20, 30, 60, 180, 300, and 600 seconds.
- To change the channel parameters, double-click the field you wish to change (e.g. H2S AutoCal.) to select it, then type the new information.

10. After you have finished entering new parameters, you must upload this information to the instrument by clicking the **Update** button, then confirming that you want to update the information by clicking the **Yes** button when the Update window appears.

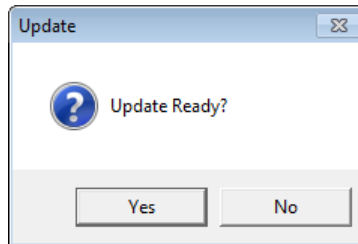

Figure 72: Update Window

11. To update the instrument's date and time to match the computer's, click the **Date/Time Set** button and then click the **Yes** button when the Update window appears.

Detail Settings Button

The detail settings button allows the user to create or change a User ID list or Station ID list and upload it to an instrument. The detail settings button is located along the left part of the Set window under the font and graph color buttons. To update the Station ID or User ID list in an instrument, you must first connect the instrument to the program.

1. Launch the GX-6000 Data Logger Management Program.
2. If the Automatic Download selection box is selected, deselect it.
3. Connect an instrument to the program. See "Downloading Data from an Instrument" on page 22, instruction 1 through instruction 3, to connect an instrument to the program.
4. Once the connection is made, the **Complete Download**, **Instrument Information**, and **Power Off** download commands will be selectable. Click the **Instrument Information** download command to retrieve the instrument information from the instrument. If you wish to download data before making changes, click **Complete Download** instead of **Instrument Information**.

5. Click the **Set** button to display the Set window.

Gas	Sensor	Warning	Alarm	STEL	TWA	Auto Cal.	Ch
CH4(100%LEL)		10	50	----	----	50	1
O2(40.0%)		19.5	23.5	----	----	12.0	2
H2S(100.0ppm)		5.0	30.0	15.0	10.0	25.0	3
CO(500ppm)		25	50	200	25	50	4
VOC(5000ppb)		4300	6000	----	----	20000	5
HCN(15.0ppm)		5.0	10.0	4.7	15.0	10.0	6

Figure 73: Set Window

Directly Editing Station and User ID Lists

The station and user ID lists can be edited directly or through the use of csv files. Editing them directly is often more convenient if your station or user ID list is short. For longer ID lists, using csv files will be more convenient. See “Updating Station and User ID Lists Using CSV Files” on page 80 for instructions to use csv files.

1. Click the Detail Settings button in the Set window. If you do not currently have any User IDs or Station IDs programmed into the instrument, the screen will appear as shown below.

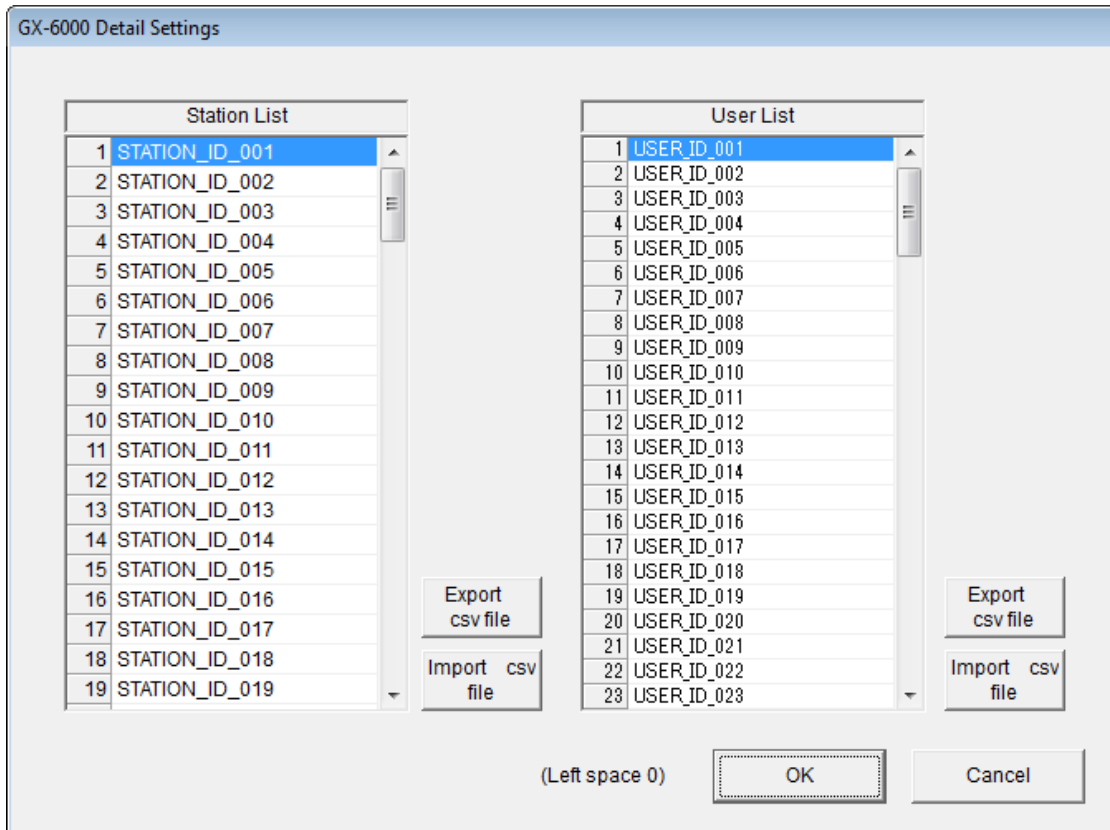

Figure 74: Detail Settings Window

The Station ID list is shown on the left and the User ID list is shown on the right. Both lists have Export csv file and Import csv file buttons located to the right of each list.

If the instrument had any station or user IDs, they would be displayed in the appropriate list.

2. Double click the station or user ID you wish to change and delete the existing information. Type in the new station or user ID. The computer's caps lock must be on in order for text to appear. Each ID can be up to 16 characters long and can contain uppercase letters, lowercase letters, or numbers.

3. Click OK to save the changes and return to the Set window.
Click Cancel to return to the Set window without saving changes.
4. The new station and user ID lists will be visible in the Station ID and User ID selection boxes in the Set window. Use the drop down menu to select a current station and user ID for the instrument.
5. To upload the updated station and/or user ID list to the instrument and upload any other changes you have made, click Update and click OK when the confirmation box appears.

Updating Station and User ID Lists Using CSV Files

Station and user ID lists can also be edited by using csv files. A Station csv file and a User csv file are provided with the program but you can also create your own csv file.

1. Click the Detail Settings button in the Set window. If you do not currently have any User IDs or Station IDs programmed into the instrument, the screen will appear as shown below.

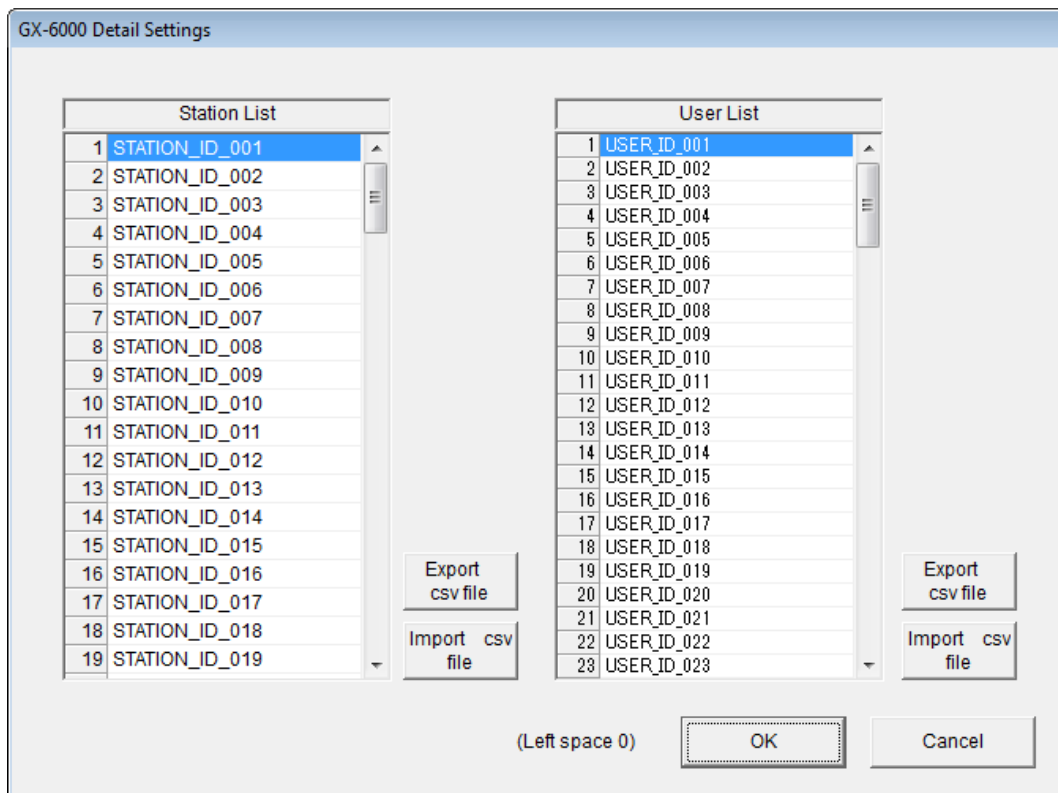

Figure 75: Detail Settings Window

The Station ID list is shown on the left and the User ID list is shown on the right. Both lists have Export csv file and Import csv file buttons located to the right of each list.

2. To create a new ID list, click the Export csv file button located to the right of the Station ID list or the User ID list. In the example below, the Export csv file button to the right of the Station ID list was clicked.

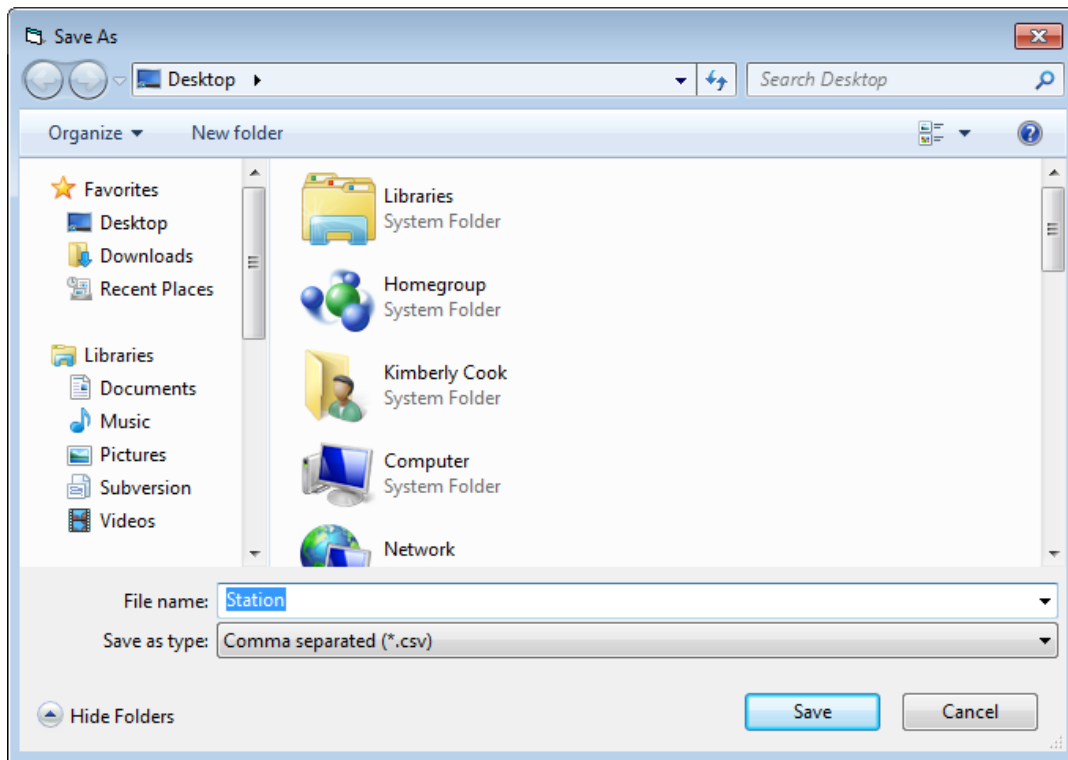

Figure 76: Station ID CSV File Save As

Navigate to the location you would like to save the csv file, type in a file name, and click Save.

3. The csv files can be opened, edited, and saved using a word processing program such as Word, WordPad, or Notepad. The Station and User csv files consist of the Station or User ID number and its associated name. Below is an example of the Station csv file opened in WordPad.

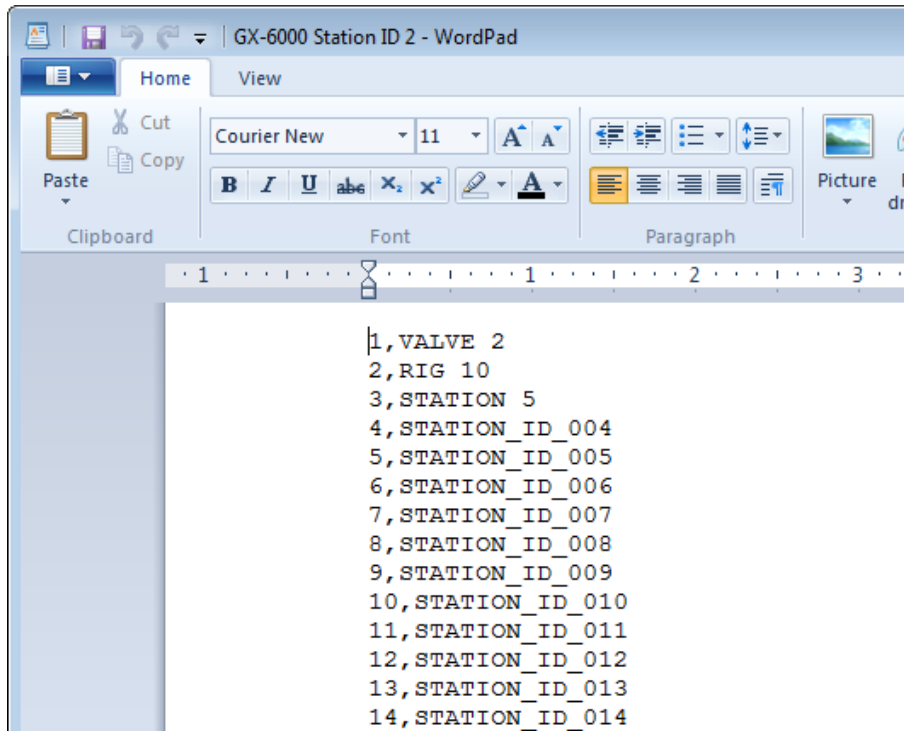

Figure 77: Station ID CSV File Opened in WordPad

Any existing Station or User IDs will be displayed. Undefined Station or User IDs have a STATION_ID_XXX or USER_ID_XXX appearance. To edit a Station or User ID, delete either the existing name and replace it with the desired name. The name can be up to 16 characters long and may consist of any uppercase letter, lowercase letter, or number.

Importing CSV Files

1. Locate an existing Station ID or User ID csv file. See above for instructions to generate a csv file.
2. In the Detail Settings window, click "Import csv file" for either the Station ID or User ID and select a csv file.

Press to import Station csv

Press to import User csv

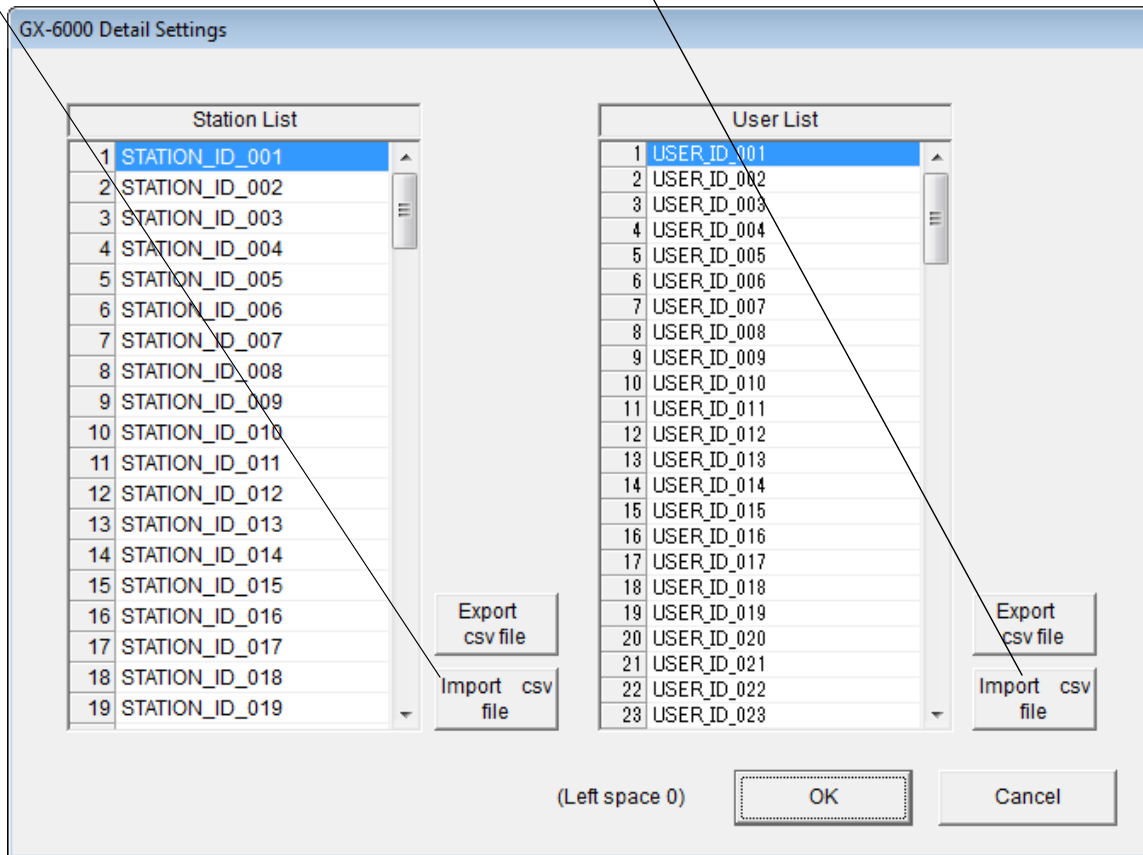

Figure 78: Import csv File

3. Select the file you want to import and click Open.

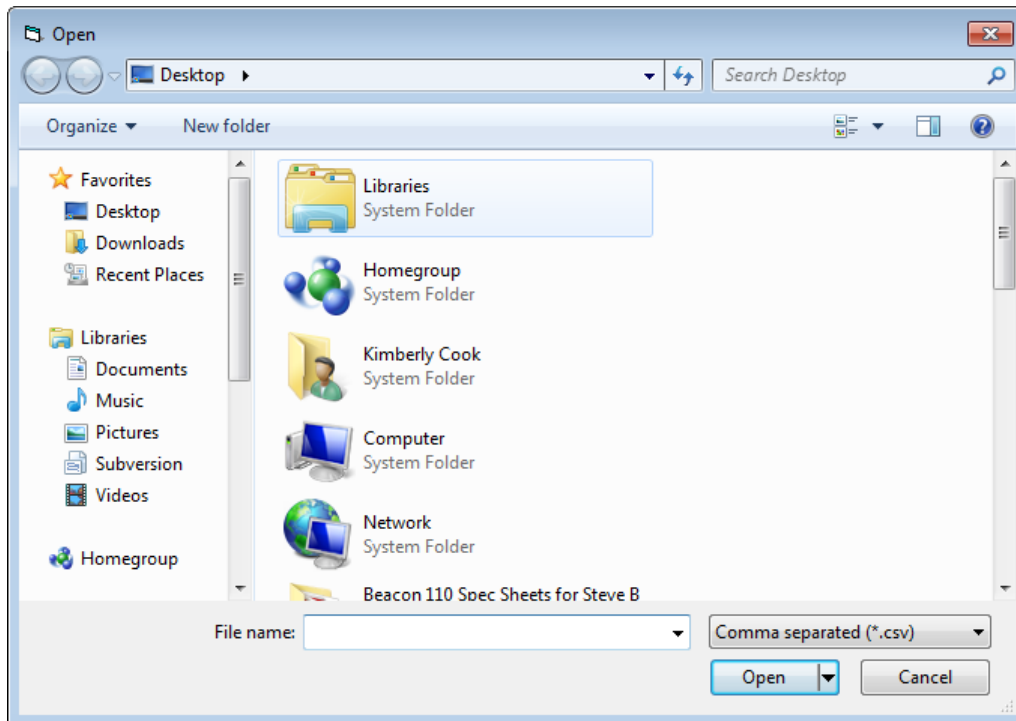

Figure 79: Import csv File

4. Once the Station ID and/or User ID lists have been imported, click OK to save changes and return to the Set window.

If you do not want to save the changes, click Cancel.

5. The new station and user ID lists will be visible in the Station ID and User ID selection boxes in the Set window. Use the drop down menu to select a current station and user ID for the instrument.

6. To upload the new information from the GX-6000 Data Logger Management Program to the instrument, click the Update button in the Set window.

7. Click Yes when the Update window appears.

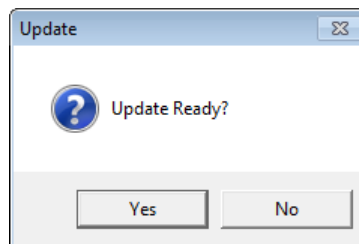
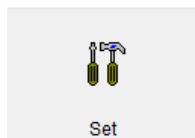

Figure 80: Update Window

Changing the Appearance of the Program Screens

To change how information is displayed in the program (e.g., text font or graph colors), use the program's Set Window. Follow the steps below to make changes.



1. Launch the GX-6000 Data Logger Management Program.
2. Click the **Set** button to display the Set window. Use the Font And Color Frame in the left side of the window to change fonts and graph colors.

Click to
change
font type

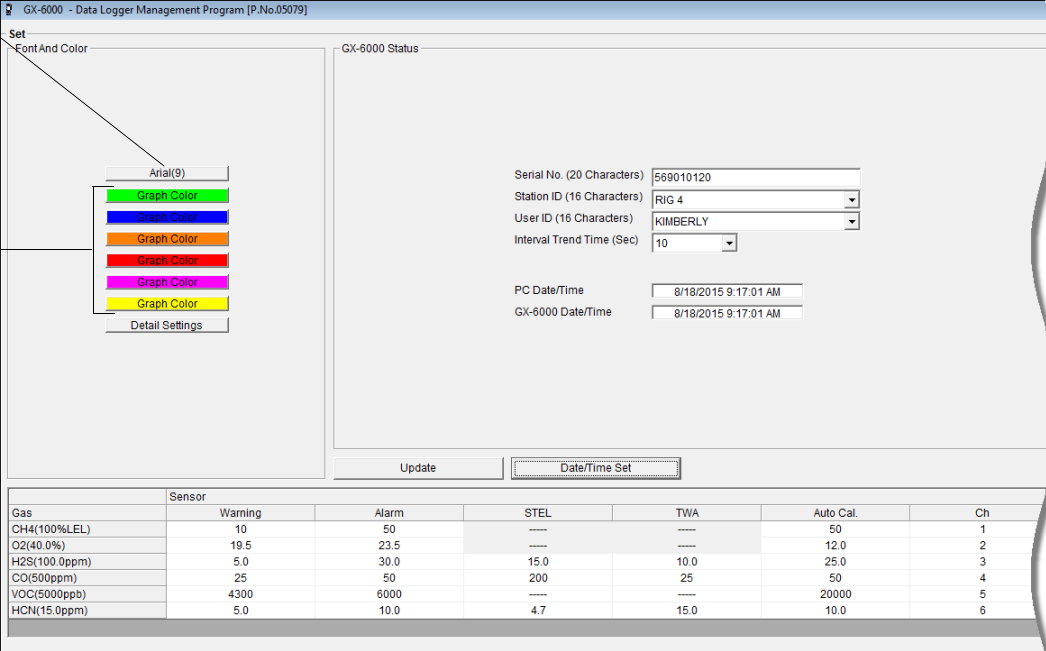

Sensor	Warning	Alarm	STEL	TWA	Auto Cal.	Ch
Gas						
CH4(100%LEL)	10	50	---	---	50	1
O2(40.0%)	19.5	23.5	---	---	12.0	2
H2S(100.0ppm)	5.0	30.0	15.0	10.0	25.0	3
CO(500ppm)	25	50	200	25	50	4
VOC(5000ppb)	4300	6000	---	---	20000	5
HCN(15.0ppm)	5.0	10.0	4.7	15.0	10.0	6

Choose these options to change the graph colors for the target gases

Figure 81: Set Window, Changing Fonts and Graph Colors

3. Specify new fonts by clicking the button with the name of a font inscribed on it. This action will display the Font Window. Choose the font type, style, size, and script, then click **OK**.

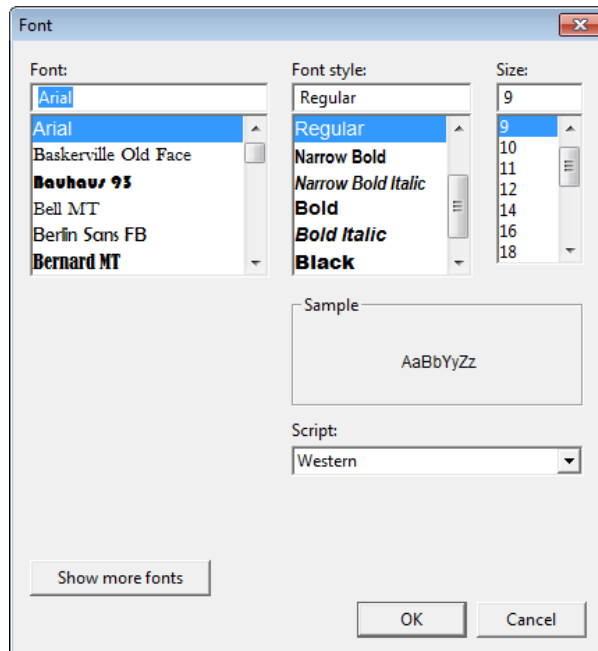

Figure 82: Font Window

4. Select the colors used to graph the various target gases in the interval trend and alarm trend data files by clicking the appropriate **Graph Color** button on the left side of the Set Window in the Font and Color frame.

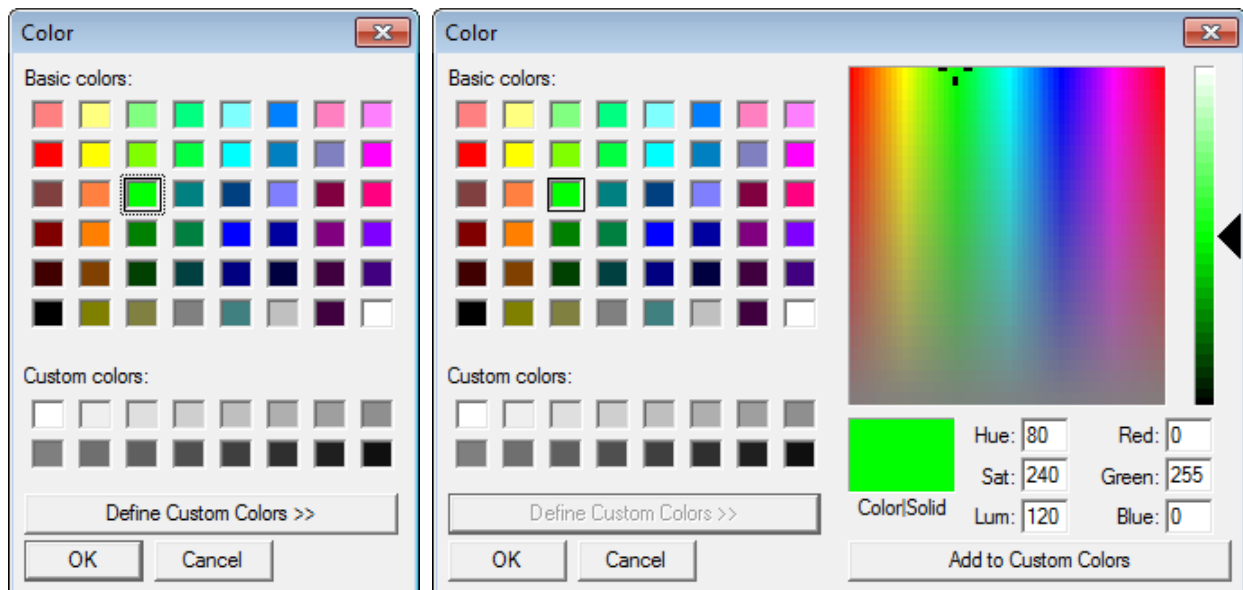

Figure 83: Color and Custom Color Windows

- The Color Window shown on the left above appears when the **Graph Color** button is clicked.

- If you want to define a custom color, click the **Define Custom Colors** button and the Custom Color Window shown on the right above replaces the Color Window.
5. After making the desired changes, click **OK**.
 6. The changes you have made will take effect after you exit and restart the program.

Instrument Power Off

To turn a connected instrument off:

1. Select the Download button if you are not already in the Download window.
2. Click the Power Off button. The instrument will shut off.
3. Exit the program by clicking the Exit button in the bottom right corner of the program.

NOTE: If you shut down the GX-6000 Data Logger Management Program without first turning off the instrument, the instrument will go into alarm after 3 minutes to indicate that it is still on but not connected to a program. Starting up the GX-6000 Data Logger Management Program and establishing a connection will reset the alarm. Using the POWER/ENTER button to turn the instrument off will also reset the alarm.

Spare Parts List

Table 2: Spare Parts List

Part Number	Description
47-5084RK	USB/IrDA adapter module, Legasic, for use with all premier portables (without USB cable)
47-5084RK-01	USB/IrDA adapter assembly, Legasic, for use with all premier portables (with module and USB cable)
47-5085RK	Cable, USB A to USB mini, 6 feet, for USB/IrDA adapter module
47-5093	USB/IrDA adapter with cable and CD (not for use with Eagle 2)
71-0375	GX-6000 Data Logger Management Program Operator's Manual (this document)
71-8010	GX-6000 Product CD, Includes the GX-6000 Data Logger Management Program, and Operator's Manuals