

# FM-300H and FM-300HR

## Electronic Disc Meter Owner's Manual



5252 East 36th Street North  
Wichita, KS USA 67220-3205  
TEL: 316-686-7361  
FAX: 316-686-6746

***GREAT PLAINS INDUSTRIES, INC.***

*"A Great Plains Ventures Subsidiary"*

[www.gpipumps.net](http://www.gpipumps.net)

1-800-835-0113

## To the owner...

Congratulations on receiving your GPI Electronic Disc Meter. We are pleased to provide you with a meter designed to give you maximum reliability and efficiency.

Our business is the design manufacture, and marketing of liquid handling, agricultural, and recreational products. We succeed because we provide customers with innovative, reliable, safe, timely, and competitively-priced products. We pride ourselves in conducting our business with integrity and professionalism.

We are proud to provide you with a quality product and the support you need to obtain years of safe, dependable service.

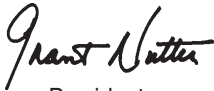

President  
Great Plains Industries, Inc.

## TABLE OF CONTENTS

General Information.....	2
Before Installation.....	3
Installation .....	3
Before Each Use.....	3
Operation.....	4
Calibration .....	5
Maintenance.....	6
Troubleshooting.....	9-10
Illustrated Parts List.....	11
Specifications.....	12
Service.....	12

## GENERAL INFORMATION

This manual assists you in operating and maintaining your meter. Please take a few moments to acquaint yourself with the information here.

If you need assistance, contact the dealer from whom you purchased your meter.

### If You Measure in Litres

This manual commonly refers to “gallons.” If your meter is factory calibrated in litres, consider all references to “gallons” apply equally to “litres.”



This symbol is used throughout the manual to call your attention to safety messages.

### WARNING

**Warnings** alert you to the potential for personal injury.

### CAUTION

**Cautions** call your attention to practices or procedures which may cause damage to your equipment.

**Notes** give you information that can improve efficiency of operations.

### It is your responsibility to:

- make sure all operators have access to adequate instructions about safe operating and maintenance procedures.
- know and follow all safety precautions as specified by your chemical manufacturer for handling of the fluid being metered.

### Read Me!

For your safety, review the major warnings and cautions below before operating your meter.

1. This meter is approved to handle water, pesticides, fertilizers, and most industrial fluids. Do not use for gasoline, diesel or other fluids. Do not use this meter with flammable liquids.

2. When handling hazardous chemicals, always follow the chemical manufacturer's safety precautions. Wear protective clothing such as goggles, gloves, and respirators, as instructed.
3. To avoid damage, **DO NOT** blow compressed air through the meter.

Your electronic disc meter is designed for measuring a wide range of chemicals. The meter translates flow data from the nutator disc into calibrated units shown on the meter's readout. A field replaceable battery provides power.

## BEFORE INSTALLATION

Upon receipt, examine your meter for visible damage. Remove protective plugs and caps for a thorough inspection. If any items are damaged or missing, contact your distributor.

### ⚠ CAUTION

**To avoid damage, DO NOT blow compressed air through the meter.**

If the meter is located in a rigid piping system where the fluid is trapped (for example, by gravity, valves or nozzles) thermal expansion of the fluid can create pressure spikes that can damage a meter. Install a thermal relief valve or otherwise allow for thermal expansion of the fluid.

## Connect Battery

To save power, this meter is shipped with the battery disconnected. Before using, connect the battery using the instructions below:

1. Remove the two large and two small screws from the battery coverplate located on the lower portion of the meter face.
2. Remove the battery and plug into battery connections. When connected properly, numbers appear in the meter readout.

3. Replace the gasket and battery cover and tighten securely. Torque the screws to 9 to 10 in. lbs.

## INSTALLATION

**NOTE:** To avoid damage to the inlet and outlet, install this meter **ONLY** on plastic hose end or pipe fittings.

1. To protect against leakage, seal all threads with two or three turns of Teflon® tape or a pipe thread sealant compatible with the liquid being measured. Make sure the Teflon® tape or sealant does not interfere with flow.
2. Hand-tighten the meter onto the fittings until snug. (Figure 1)

**Figure 1**



### ⚠ CAUTION

**To avoid damage to the housing, DO NOT use a wrench.**

## BEFORE EACH USE

If the meter has been used before, make sure it is flushed and cleaned as outlined in the Maintenance Section.

Press and release the DISPLAY button to ensure the meter is operating. Numbers will display from the last use.

If the display becomes dim, faded or the low battery message appears (see below), battery needs to be replaced. Reference the Maintenance Section for details. Also check battery terminals for corrosion. To prevent corrosion from condensation, coat the terminals with petroleum jelly.



### Verify Meter Accuracy

Before using, verify calibration and check the meter's accuracy.

1. If desired, hold down DISPLAY for three seconds to zero the meter's Batch Total. When zeros appear, release the button.
2. Meter an exact known volume into an accurate container. For best results, meter with one continuous full stream.
3. Check the readout. If the amount metered is accurate, field calibration is not needed. If not, refer to the Calibration Section for further instructions.

NOTE: Best performance can be obtained by using the factory calibration.

## OPERATION

**⚠ WARNING**

**This meter is approved to handle water, pesticides, fertilizers and most industrial fluids. Do not use for gasoline, diesel or other fuels. Do not use this meter with flammable liquids.**

### Computer Display

All operations are reflected in the LCD readout. The large center digits indicate amounts, where smaller words or "icons" located above and below indicate specific information regarding totals, flow, calibration and units of measure.

### Activate the Meter

Computer is on continuously and always ready to perform. The computer is powered by a field replaceable battery. When display becomes dim, faded or the low battery message appears, the battery needs to be replaced. Reference the Maintenance Section for details.

### Batch and Cumulative Totals

The computer maintains two totals. The Cumulative Total provides continuous measurement and cannot be manually reset. The Batch Total can be reset to measure flow during a single use. The Cumulative Total is labeled TOTAL 1, Batch Total is labeled TOTAL 2 BATCH.

When the Cumulative Total reaches a display reading of 999,999 the computer will highlight an X10 icon. This indicates to the operator that a zero must be added to the 6 digits shown. When the next rollover occurs, the computer will highlight an X100 icon. This indicates to the operator that two zeros must be added to the 6 digits shown.

Press the DISPLAY button briefly to switch between the TOTAL 1, TOTAL 2 BATCH and FLOWRATE (if applicable). Press DISPLAY briefly to display the TOTAL 2 BATCH. Hold the DISPLAY button for 3 seconds to reset the Batch Total to zero.

When fluid is flowing through the meter, a small propeller icon is highlighted.

## Flowrate Feature

Some models have of Rate of Flow mode. To use this feature, press and release DISPLAY until FLOWRATE icon appears. The factory set time base will be highlighted to the right of FLOWRATE (M = minutes). When FLOWRATE is invoked, the display will be indicating rate of flow.

# CALIBRATION

## Factory and Field Calibration

All calibration information is visible to the user as icons on the top line of the display, above the numeric digits.

All units are configured with a “factory” calibration. Some models are calibrated with gallons (GL) and others calibrated with litres (LT). This factory calibration (indicated with FAC) is permanently programmed into the computer and is not user adjustable.

The “field” calibration may be set by the user, and can be changed or modified at any time using the calibration procedure described in the Calibration Section. Totals or flowrate derived from the field calibration are invoked when the FAC icon is no longer visible on the top line of the display.

## Field Calibration

Factory calibration settings are custom-programmed into each flowmeter during production, and are correct for light fluids such as water or heavier liquids like pesticides or light oil. However, readings using the standard factory calibration curves may not be accurate in some situations – variations in chemical formulation, viscosity, temperature, and flowrates all effect meter accuracy. To ensure accuracy, it is important to check accuracy frequently and field calibrate when necessary.

## Field Calibration Procedures (Dispense/Display Method)

1. To field calibrate, press and hold the CALIBRATE and DISPLAY buttons for about 3 seconds until you see FLdCAL. Release both buttons and you will see dd000.0. You are now in the field calibration mode.
2. Dispense a known amount of fluid at a flowrate representative of the application. Any amount between .1 and 999.9 units can be used. Display will count up while fluid is flowing through the meter.
3. The DISPLAY button can then be pushed to select the digit location and the CALIBRATE button can be pushed to scroll the desired value at the blinking position. Edit the amount shown with the value that was dispensed above. Values from 000.1 to 999.9 can be entered.
4. When satisfied with the value, press both CALIBRATE and DISPLAY buttons simultaneously. CALEnd will be displayed and unit will go back to normal operation, less the FAC (factory calibration) icon.
5. The meter will now be operating with a custom calibration number unique to the above dispense procedure. No unit of measure (gallon, litre, etc.) icon will be highlighted.

**NOTE:** If the field calibration mode is entered and NO fluid is dispensed, then upon leaving, the computer will use data from the last successful field calibration.

## Calibration Container

The desired calibration container should be uniformly dependable and constructed with a graduated neck. The container's volume indicator should be clearly and precisely marked. It is helpful if the container's material allows a window through which the level of liquid can be viewed. GPI offers a properly designed calibration container for volumes of 5 gallons or 5 litres.

**DONOT** use several smaller containers or a larger container with a 5-gallon marking.

For the most accurate results, dispense at flowrates that best simulate your actual operating conditions. Avoid "dribbling" more fluid or repeatedly starting and stopping the flow. These actions will result in less accurate calibrations.

During calibration, make sure you meet the meter's minimum flowrate requirements of 2 GPM (7 LPM).

Before calibrating, purge the system of air using instructions in the Before Each Use section.

## MAINTENANCE

This meter is virtually maintenance free. It is important, however, that the nutator disc moves freely.

To prevent drying of chemical on internal assemblies, meters should be kept free of chemical when not in use for extended periods of time. Flush and clean after each use to promote trouble-free operation.

## Removal

### **⚠ WARNING**

**During meter removal, chemical may spill. Follow the chemical manufacturer's safety precautions for cleanup of minor spills.**

1. Ensure all chemical is drained from the meter. This could include draining the hose, meter and nozzle.
2. Wearing protective clothing, loosen the meter from fittings by hand.

### **⚠ CAUTION**

**To avoid damage to the housing, do not use a wrench.**

If the meter is not immediately installed again, cap the hose end to prevent spills and drying. The nozzle could be used for this purpose. Flush the meter if it will not be in use for more than two weeks.

## Flushing

When removed or not in use for more than two weeks, flush the meter to remove chemical residue.

### **⚠ CAUTION**

**Do not submerge the meter.**

If needed, clean the meter using Cleaning instructions.

## Cleaning

During use, the meter should be kept free of liquid to ensure drying does not occur inside the meter. If drying should occur, the nutator will stick or drag, affecting accuracy. If this occurs, cleaning is required.

## Cleaning the Nutator

1. Loosen the screws on the back of the meter about 1/4 inch (0.6 cm). (Figure 2)

**Figure 2**



2. Tap the screws with a hammer to loosen the coverplate from the housing. (Figure 3) Remove the screws and washers.

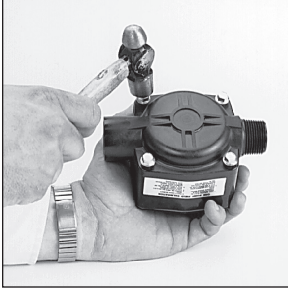

**Figure 3**

5. Gently remove the metal clips holding the nutator in place. (Figure 6) Take care not to damage the O-ring on the nutator inlet.

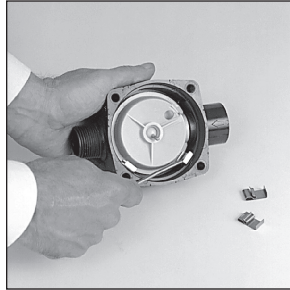

**Figure 6**

3. Gently pry the coverplate from the housing. Take care not to damage the coverplate, housing, or O-ring. (Figure 4)

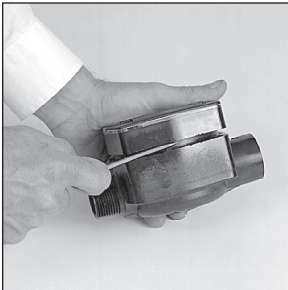

**Figure 4**

6. Remove the nutator.
7. Using water or a solvent-based fluid and a brush, carefully remove residue from the nutator disc, nutator halves, signal generator, and inside of housing. Allow all parts to dry.

### **⚠ CAUTION**

**Do not submerge the meter.**

4. Remove the signal generator from the pin on the nutator disc. (Figure 5)

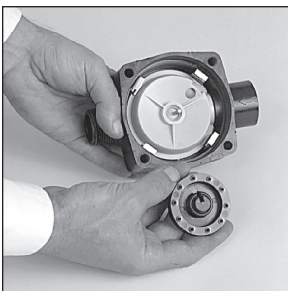

**Figure 5**

8. When the nutator turns freely, assemble and install following the instructions below.

### **Assemble Nutator**

1. Assemble the nutator disc and nutator halves. Install the O-ring on the nutator inlet.
2. Install the nutator in the meter housing. Make sure the nutator O-ring fits properly against the meter inlet.
3. Secure the nutator with the metal clips. Beginning opposite the inlet, install a clip in each slot in the housing. Push each clip down firmly until seated.
4. Place the signal generator on the nutator pin. Make sure it rotates freely on the pin.

5. Coat the O-ring lightly with bearing grease and seat securely on the coverplate.
6. With the display facing up, turn the coverplate to the desired orientation. Align holes on coverplate and housing.
7. Secure the coverplate by evenly tightening screws to 25 to 35 in. lbs.

## Storage

After thoroughly cleaning the meter, disconnect the battery and store the meter in a clean, dry location.

## Battery Replacement

Your meter is equipped with a field-replaceable 9-volt alkaline battery.

If the meter's readout should become dim, blank, faded, or the low battery message appears, replace the battery.

Batch and Cumulative Totals, as well as, Factory and Field Calibrations are not lost when the battery is replaced or power is lost. They are saved in the meter's computer and are available after a new battery is installed. You do not need to repeat Field Calibration.

Check the battery and terminals at least every year to ensure proper operation. It is strongly recommended that terminals be cleaned annually.

**NOTE:** The battery can be replaced without removing the meter from the hose or pipe.

### To replace battery or clean terminals:

1. Remove the two large and two small screws from the battery coverplate located on the lower portion of the meter face. (Figure 7)

**Figure 7**

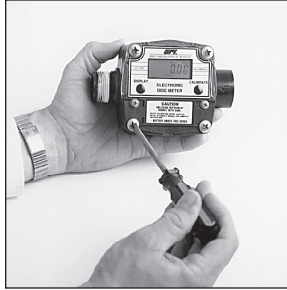

2. Remove the battery coverplate and gasket. (Figure 8)

**Figure 8**



3. Remove the battery and, if necessary, clean corrosion from the battery terminals. (Figure 9) To prevent corrosion from condensation, coat the terminals with petroleum jelly.

**Figure 9**

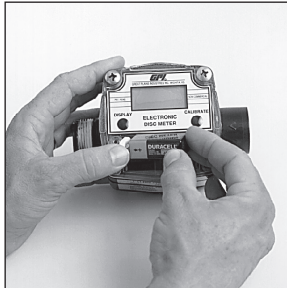



4. Install the new battery.

When the battery is installed correctly, the computer powers on automatically. Check the readout to make sure normal meter functions have resumed before assembling again. If necessary, seat the battery again.

5. Make sure the coverplate gasket is in good condition and properly seated. Replace, if needed.
6. Replace the battery cover. Torque the screws to 9 to 10 in. lbs.

## End of Season

To ensure proper operation, the meter should be cleaned prior to extended periods of inactivity and at the end of the season before storage. Disconnect the battery before storage.

## TROUBLESHOOTING

SYMPTOM	PROBABLE CAUSE	CORRECTIVE ACTION
A. METER IS NOT ACCURATE	<ol style="list-style-type: none"> <li>1. Field Calibration not performed properly</li> <li>2. Factory Calibration not suitable for liquid being measured</li> <li>3. Meter operated below minimum flowrate</li> <li>4. Meter partially clogged with dried liquid</li> <li>5. Teflon® tape or other material in flow path</li> <li>6. Nutator misaligned</li> </ol>	<p>Field calibrate again or select Factory Calibration.</p> <p>Perform a Field Calibration according to Calibration Section.</p> <p>Increase flowrate. See Specifications Section.</p> <p>Remove meter. Disassemble and carefully clean dried chemical from the nutator. Make sure the nutating disc moves freely. Assemble again.</p> <p>Remove meter. Clear material from flow path and seal fittings. Install again.</p> <p>Disassemble meter and install nutator again. Ensure O-ring and retainer clips are in place.</p>
B. READOUT FADED OR BLANK	<ol style="list-style-type: none"> <li>1. Batteries weak, dead or not connected</li> <li>2. Battery terminal corroded</li> <li>3. Computer defective</li> </ol>	<p>Replace battery. Install again, making sure the gasket seats evenly around the coverplate.</p> <p>Clean corrosion from the terminals.</p> <p>Contact the factory.</p>

<b>SYMPTOM</b>	<b>PROBABLE CAUSE</b>	<b>CORRECTIVE ACTION</b>
C. NORMAL FLOW-RATE BUT METER DOES NOT COUNT (Meter comes on when DISPLAY button pushed.)	<ol style="list-style-type: none"> <li>1. Field Calibration not performed correctly</li> <li>2. Nutator misaligned</li> <li>3. Signal generator disc missing or damaged</li> <li>4. Computer defective</li> </ol>	<p>Field calibrate again or select Factory Calibration.</p> <p>Disassemble meter and install nutator again. Ensure O-ring and retainer clips are in place.</p> <p>Replace signal generator disc. Contact the factory.</p> <p>Contact the factory.</p>
D. REDUCED FLOW-RATE & METER DOES NOT COUNT (Meter comes on when DISPLAY button pushed.)	<ol style="list-style-type: none"> <li>1. Meter clogged with dried liquids</li> </ol>	<p>Remove meter. Disassemble and clean dried chemical from the nutator. Make sure the nutating disc moves freely. Assemble again.</p>
E. CANNOT GET METER INTO FIELD CALIBRATION	<ol style="list-style-type: none"> <li>1. Button push sequence incorrect</li> <li>2. Computer circuit board defective</li> </ol>	<p>Make sure CALIBRATE is held down while DISPLAY is pushed. Hold both buttons for 3 seconds. Readout will then show dd-000.0. Release both buttons. Proceed with calibration according to Calibration Section.</p> <p>Contact the factory.</p>
F. METER CONNECTIONS LEAK	<ol style="list-style-type: none"> <li>1. Meter installed without thread sealant</li> <li>2. Connecting threads damaged</li> <li>3. Screws on back of meter loose</li> <li>4. Coverplate O-ring missing, damaged, or improperly installed</li> <li>5. Meter housing cracked</li> </ol>	<p>Remove meter. Wrap male connections with 3 to 4 wraps of thread tape or compatible sealing compound. Install again.</p> <p>Remove meter and inspect threads. Replace damaged connections. If threads are damaged, contact the factory.</p> <p>Tighten screws. Torque to 25 to 35 in. lbs.</p> <p>Install O-ring on coverplate again.</p> <p>Inspect housing for cracks. If cracks present, contact the factory.</p>

# ILLUSTRATED PARTS LIST

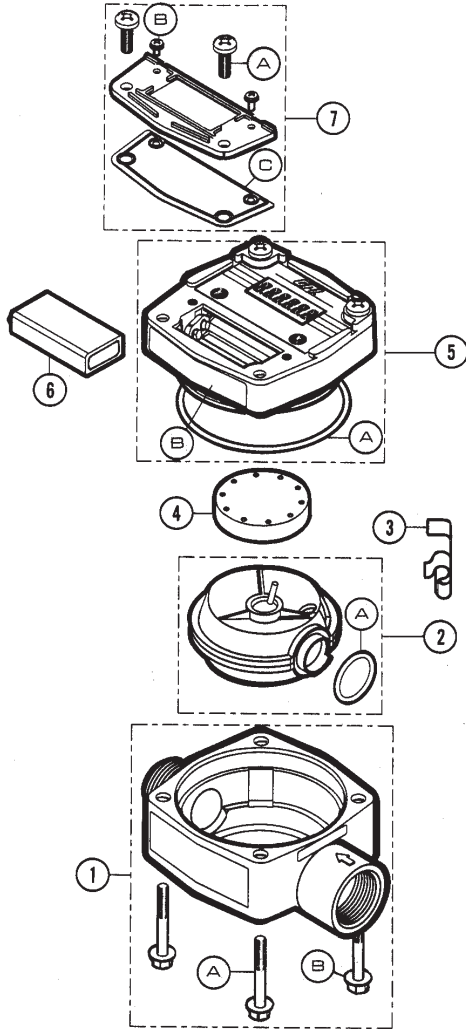

Item No.	Part No.	Description	No. Req'd.
1	120505-1	Housing Kit.....	1
1-A	904004-19	Screw, 1/4-20 x 1-3/4 in.....	4
1-B	904005-29	Washer, 1/4 in.....	4
2	120503-1	Nutator Kit.....	1
2-A	111045-4	Nutator Seal .....	1
3	120013-1	Clip.....	4
4	120504-1	Signal Generator Kit.....	1
5*	120502-11	Coverplate Assy Kit, gallon. 1	
	120502-18	Coverplate Assy Kit, litre.....	1

Item No.	Part No.	Description	No. Req'd.
5-A	901001-78	O-ring.....	1
6	902004-20	9 Volt Transistor Battery .....	1
7*	120501-3	Battery Cover and Gasket Kit.....	1
7-A	904005-28	Self-Sealing Screw, 1/4-20 x 5/8 in.....	2
7-B	904005-27	Sems Screw, 6-32 x 3/8 in.....	2
7-C	120028-1	Gasket.....	1

\* The Battery Cover and Gasket Kit, Item 7, is included in the Coverplate Assembly Kit, Item 5.

## SPECIFICATIONS

### Applications

Flow Range: 2-20 GPM (7-75 LPM)  
Operating Environment: Outdoor, operating temperature range of 0° F to +130° F (-18° C to +54° C).  
Electronic Nutating Disc designed for mounting on hoses or pumps of fluid transfer systems.  
Power: 9 Volt alkaline battery  
Maximum Working Pressure: 50 PSIG (3.4 bar)  
Maximum Display Value: 999,999 (x100)

### Accuracy

Factory Calibration:  $\pm 2\%$   
Field Calibration:  $\pm 0.5\%$

### Materials

Housing: PBT Polyester  
Seals: Viton  
Wetted Parts: PBT Polyester, 303/304 Stainless Steel, Ferrite

### Mechanical

Inlet: 1 inch NPT female  
Outlet: 1 inch NPT male

### Dimensions

Height: 4 inches (10.3 cm)  
Depth: 3.1 inches (8.1 cm)  
Width: 6 inches (15.2 cm)

### Shipping Weight

3 lbs. (1.4 kg)

### Storage Temperature

-40° F to +158° F (-40° C to +70° C)

## SERVICE

For warranty consideration, parts, or other servicing information, please contact your local distributor. If you need further assistance, call the GPI Customer Service Department in Wichita, Kansas, during normal business hours.

**1-800-835-0113**

To obtain prompt, efficient service, always be prepared with the following information:

1. The model number of your meter.
2. The serial number or manufacturing date code of your meter.
3. Specific information about part numbers and descriptions.

For warranty work always be prepared with your original sales slip or other evidence of purchase date.

### Returning Parts

Please contact the factory before returning any parts. It may be possible to diagnose the trouble and identify needed parts in a telephone call or letter. GPI can also inform you of any special handling requirements you will need to follow covering the transportation and handling of equipment which has been used to transfer hazardous liquids.

### **⚠ CAUTION**

**Do not return meters without specific authority from the GPI Customer Service Department. Due to strict regulations governing transportation, handling, and disposal of hazardous liquids, GPI will not accept meters for rework unless they are completely free of chemical.**







## Limited Warranty Policy

Great Plains Industries, Inc. 5252 E. 36<sup>th</sup> Street North, Wichita, KS USA 67220-3205, hereby provides a limited warranty against defects in material and workmanship on all products manufactured by Great Plains Industries, Inc. This product includes a 2 year warranty from date of purchase as evidenced by the original sales receipt. A 30 month warranty from product date of manufacture will apply in cases where the original sales receipt is not available. Reference product labeling for the warranty expiration date based on 30 months from date of manufacture. Manufacturer's sole obligation under the foregoing warranties will be limited to either, at Manufacturer's option, replacing or repairing defective Goods (subject to limitations hereinafter provided) or refunding the purchase price for such Goods theretofore paid by the Buyer, and Buyer's exclusive remedy for breach of any such warranties will be enforcement of such obligations of Manufacturer. The warranty shall extend to the purchaser of this product and to any person to whom such product is transferred during the warranty period.

This warranty shall not apply if:

- A. the product has been altered or modified outside the warrantor's duly appointed representative;
- B. the product has been subjected to neglect, misuse, abuse or damage or has been installed or operated other than in accordance with the manufacturer's operating instructions.

To make a claim against this warranty, contact the GPI Customer Service Department at 316-686-7361 or 800-835-0113. Or by mail at:

Great Plains Industries, Inc.  
5252 E. 36<sup>th</sup> St. North  
Wichita, KS, USA 67220-3205

GPI will step you through a product troubleshooting process to determine appropriate corrective actions.

**GREAT PLAINS INDUSTRIES, INC., EXCLUDES LIABILITY UNDER THIS WARRANTY FOR DIRECT, INDIRECT, INCIDENTAL AND CONSEQUENTIAL DAMAGES INCURRED IN THE USE OR LOSS OF USE OF THE PRODUCT WARRANTED HEREUNDER.**

The company herewith expressly disclaims any warranty of merchantability or fitness for any particular purpose other than for which it was designed.

This warranty gives you specific rights and you may also have other rights which vary from U.S. state to U.S. state.

Note: In compliance with MAGNUSON MOSS CONSUMER WARRANTY ACT – Part 702 (governs the resale availability of the warranty terms).



5252 East 36th Street North  
Wichita, KS USA 67220-3205  
TEL: 316-686-7361  
FAX: 316-686-6746

***GREAT PLAINS INDUSTRIES, INC.***

*"A Great Plains Ventures Subsidiary"*

[www.gpipumps.net](http://www.gpipumps.net)

**1-800-835-0113**

GPI is a registered trademark of Great Plains Industries, Inc.  
© 2010 by GREAT PLAINS INDUSTRIES, INC., Wichita, KS.

Printed in U.S.A.

06/10

Rev. C 920679-06