

# Signet 8630-3 Chlorine Transmitter



3-8630.090-3 Rev. D 08/10 English



## CAUTION!

- Remove power to unit before wiring input or output connections.
- Follow instructions carefully to avoid personal injury or damage to the transmitter.

|   |                            |     |      |                            |      |      |                        |      |
|---|----------------------------|-----|------|----------------------------|------|------|------------------------|------|
| 1 | Description                | p.1 | 9    | The View Menu              | p.5  | 15   | Chlorine Calibration   | p.13 |
| 2 | System Overview            | p.1 | 10   | Editing Procedure          | p.5  | 15.3 | In Process Calibration | p.14 |
| 3 | Start-up Procedure         | p.2 | 10.1 | Example: Calibrate         | p.6  | 16   | Output Settings        | p.14 |
| 4 | Transmitter Installation   | p.2 | 11   | Calibrate Menu Definitions | p.7  | 16.1 | Current Loop Settings  | p.14 |
| 5 | Wiring                     | p.3 | 12   | Options Menu Definitions   | p.9  | 16.2 | Relay Functions        | p.15 |
| 6 | Terminal Identification    | p.3 | 13   | pH Calibration             | p.11 | 17   | Troubleshooting        | p.17 |
| 7 | Sensor Connections         | p.4 | 13.3 | Manual pH Compensation     | p.12 | 18   | Ordering               | p.19 |
| 8 | Power and Loop Connections | p.4 | 14   | Cl Sensor Conditioning     | p.12 | 19   | Specifications         | p.20 |

## 1. Description

The Signet 8630 ProcessPro® Chlorine Transmitter displays and transmits free chlorine along with pH information when connected to Signet Amperometric Chlorine Sensors and a Signet pH Sensor.

Features of the 8630 include:

- Displays a wide range of free chlorine concentration inputs from 0 to 5 ppm.
- Displays the full range of the chlorine sensors offered.
- Automatic pH and temperature compensation or manual pH input to calculate accurate chlorine measurements.
- Simple setup and easy customization with the 4 button keypad.
- Dual 4 to 20 mA outputs with two built-in SPDT mechanical relays.
- Easy viewing via the bright backlit LCD display.

## 2. System Overview

If you have a Signet 463X integrated chlorine panel system, skip to Section 3. If you have individual components to build your chlorine system, refer to the diagram to the right for a basic plumbing reference. View the diagram in relation to gravity with the Sampling Port being physically lower than the sensors and the Overflow being higher than everything else.

The Discharge and Overflow must be a gravity feed. The only head pressure the chlorine sensor should be subjected to is the water column to the discharge.

Once the plumbing has been constructed and tested for integrity and a suitable location for the transmitter found, follow the steps outlined in Section 3 (New System Start-up Procedure) to get your chlorine system up and running.

The start-up procedure is identical for integrated panel systems as well.

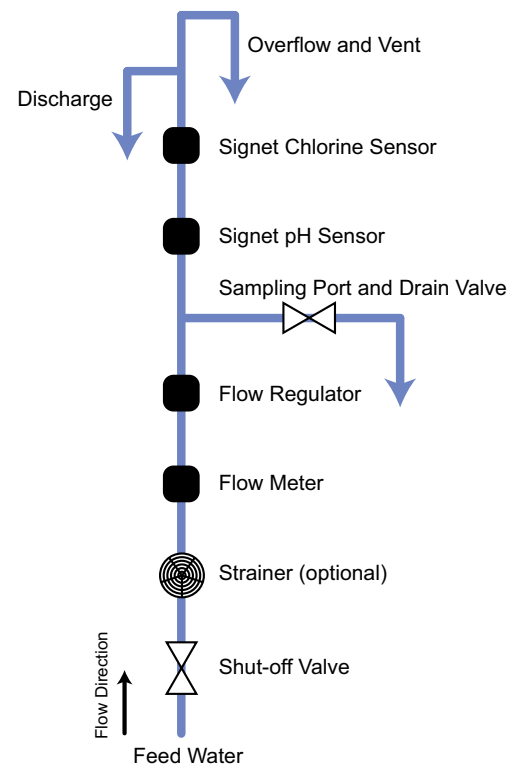

Basic Plumbing Layout

### 3. New System Start-up Procedure

Your new Signet Chlorine System needs to be calibrated and the chlorine sensor needs to be conditioned prior to use. The following steps outline the recommended procedure to start up a new system.

1. Transmitter Installation (Section 4)
2. Wiring (Section 5)
3. Calibrating pH (Section 13)
4. Chlorine Sensor Selection and Conditioning (Section 14)
5. Calibrating Chlorine (Section 15)
6. Configuring Output Settings (Section 16)



Note this icon in the manual for New System Start-up Procedures.

### 4. Transmitter Installation



#### System Start-up: Step 1

Prepare the transmitter installation location. If the back of the transmitter is difficult to access when installed, wire it first, then install it completely.

**Next step: Wiring (see section 5).**

- The 8630 panel mount transmitter is designed for installation using a ¼ DIN Punch.
- The panel opening is 92 mm x 92 mm (3.6 in. x 3.6 in.).
- ¼ DIN punches are available and recommended for creating clean, precise openings quickly and easily in most transmitter panels.
- If a punch is not available, a jigsaw or other cutting tool can be used. An adhesive template is provided to help guide the cutting process. De-burr and smooth the opening with a file.
- The recommended minimum clearance on all sides between transmitters and panel edges is 25 mm (1 in.).

#### Panel Installation

1. Slide the transmitter into the cutout from the front of the panel with the gasket seated against the flange.
2. Slide the mounting bracket over the back of transmitter until the quick-clips snap into the grooves on the side of transmitter.

To remove, secure the transmitter temporarily with tape from the front or grip from the rear of the transmitter. Press the quick-clips outward and remove.

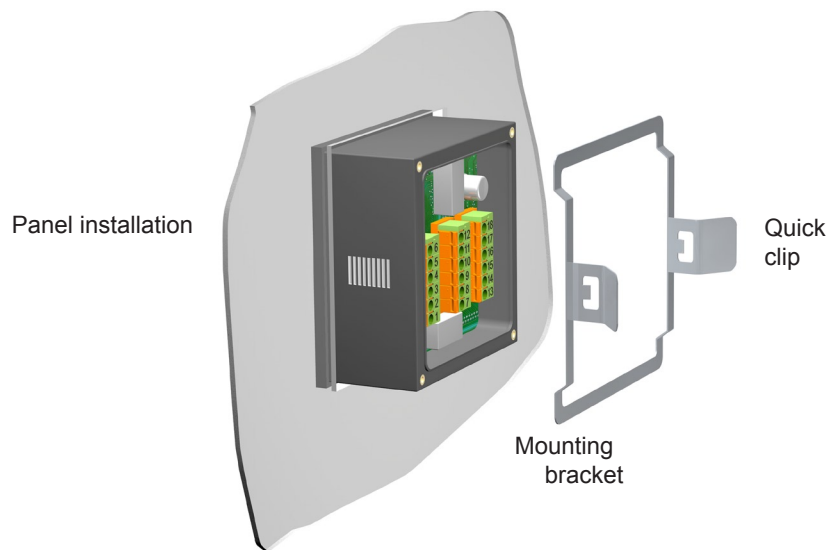

## 5. Wiring

### System Start-up: Step 2

Wire the transmitter for all connections with the power off. Keep any 4 to 20 mA and relay actuated output devices that are connected to it offline at this time.

Next step: **Calibrating pH** (see section 13). ▶

### Wiring Procedure

1. Remove 13 to 16 mm (0.5 to 0.625 in.) of insulation from the end of the wire to be connected to the transmitter.
2. Press the orange terminal lever all the way down with a small screwdriver to open terminal jaws.
3. Insert wire into terminal until it bottoms out.
4. Release the orange terminal lever to secure the wire in place.
5. Gently pull on each wire to ensure a good connection.

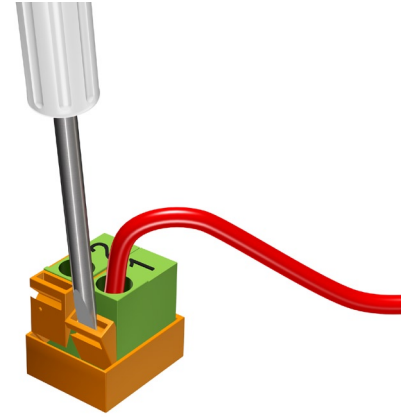

### Wiring Tips:

- Do not route the sensor cable in conduit containing AC power wiring. Electrical noise may interfere with sensor signal.
- Routing the sensor cable in grounded metal conduit can help prevent electrical noise and mechanical damage.
- Seal the cable entry points to prevent moisture damage.
- Only one wire should be inserted into a terminal. Splice double wires outside the terminal.



NO



YES



YES



**Caution:** Failure to fully open terminal jaws before removing wire may permanently damage transmitter.

## 6. Terminal Identification

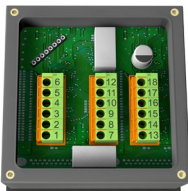

The transmitter requires regulated 12 to 24 VDC  $\pm 10\%$  from an external power supply. Maximum current draw is 250 mA.

**Power must be supplied to terminals 1 & 3 (+) and 2 & 4 (-).**

|   |                       |    |                |    |                            |
|---|-----------------------|----|----------------|----|----------------------------|
| 6 | Loop 2 -              | 12 | Relay 2 (N.O.) | 18 | Ground                     |
| 5 | Loop 2 +              | 11 | Relay 2 (COM)  | 17 | Digital (S <sup>3</sup> L) |
| 4 | System Power Loop 1 - | 10 | Relay 2 (N.C.) | 16 | V+                         |
| 3 | System Power Loop 1 + | 9  | Relay 1 (N.O.) | 15 | Ground                     |
| 2 | AUX Power -           | 8  | Relay 1 (COM)  | 14 | Digital (S <sup>3</sup> L) |
| 1 | AUX Power +           | 7  | Relay 1 (N.C.) | 13 | V+                         |

(N.O.) = Normally Open (no contact)  
(N.C.) = Normally Closed (contact)

- **Terminals 1–2: System Power and Auxiliary Power**  
Required by the transmitter
  - Provides DC power to sensors, relays and the LCD backlight.
- **Terminals 3–4: System Power and Loop 1 Power**  
12 to 24 VDC  $\pm 10\%$   
Max. loop impedance:
  - 50  $\Omega$  max. @ 12 V
  - 325  $\Omega$  max. @ 18 V
  - 600  $\Omega$  max. @ 24 V
- **Terminals 5–6: Loop 2 Power**  
12 to 24 VDC  $\pm 10\%$   
Max. loop impedance:
  - 50  $\Omega$  max. @ 12 V
  - 325  $\Omega$  max. @ 18 V
  - 600  $\Omega$  max. @ 24 V
- **Terminals 7–12: Relay Outputs**  
Two mechanical SPDT relays programmable as:
  - High or Low setpoint with adjustable hysteresis.
  - Proportional Pulse (400 pulses per minute maximum).
  - May be disabled (Off) if not used.
  - Auxiliary power (Terminals 1 and 2) MUST be connected.
- **Terminals 13–18: Digital (S<sup>3</sup>L) Input/Output**  
Two sensors connect here.
  - 13: +5 VDC out to sensor 1 (Chlorine)
  - 14: Digital (S<sup>3</sup>L) signal in from sensor 1 (Chlorine)
  - 15: Sensor 1 ground
  - 16: +5 VDC out to sensor 2 (pH)
  - 17: Digital (S<sup>3</sup>L) signal in from Sensor 2 (pH)
  - 18: Sensor 2 ground

## 7. Sensor Connections

- The 8630 provides two sets of Input/Output terminals to connect Digital (S<sup>3</sup>L) serial data from the chlorine and pH sensor electronics.
- The total cable length from a sensor to the transmitter must not exceed 30 m (100 ft).
- Do not route sensor or output cables in conduit containing AC power wiring.
- Routing cable in grounded metal conduit will help prevent electrical noise and mechanical damage.
- Seal cable entry points to prevent moisture damage.
- For best performance, ground the sensor shield wires to a local earth ground at a point near the sensor.

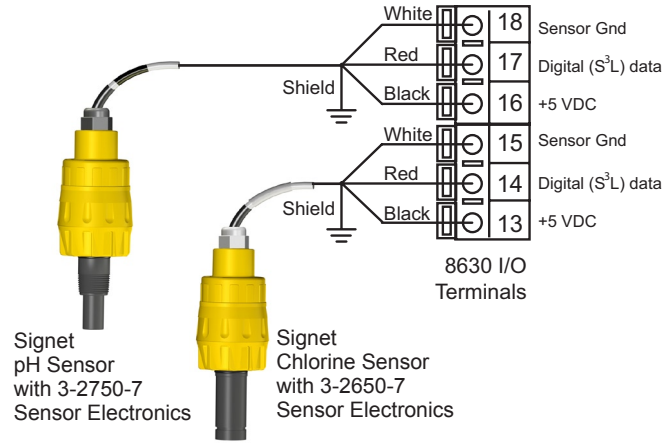

## 8. System Power and Loop Connections

**8630-3 stand-alone application, no loop used.** Always splice wires outside of terminals.

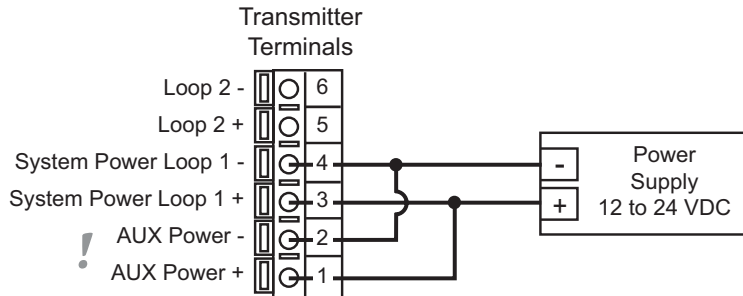

### Connection to a PLC/Recorder, separate supply

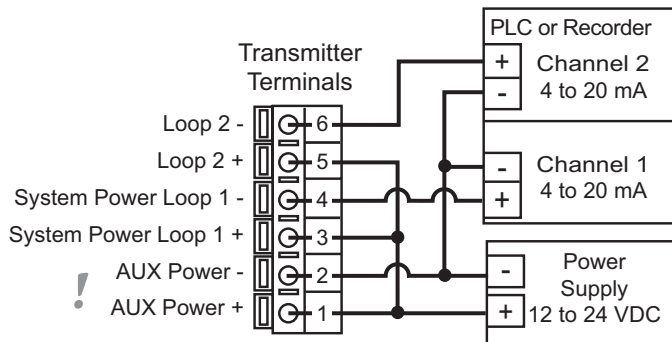

### Connection to a PLC with built-in power supply

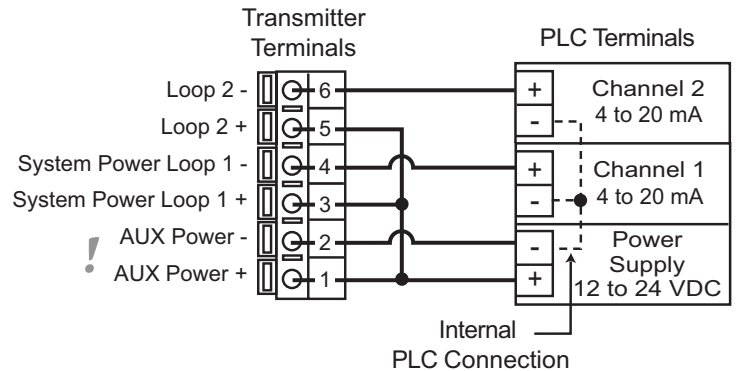

**! Note: 8630 transmitters require both terminals 1 & 3 (+) and 2 & 4 (-) to be wired.**

## 9. The View Menu

- The View Menu is displayed during normal operation.
- To select a VIEW display, press the UP or DOWN arrow keys. The selections will scroll in a continuous loop. There are four pages to view.
- Changing the VIEW display does not interrupt system operations.
- No key code is necessary to change display selection.
- Output settings cannot be edited from the VIEW menu.
- All menus timeout after 10 minutes and return to the previous operating display.
- When editing the CALIBRATE or OPTIONS menus, the transmitter will return to the non-edit display after 10 minutes and then the VIEW menu in another 10 minutes if no activity occurs.

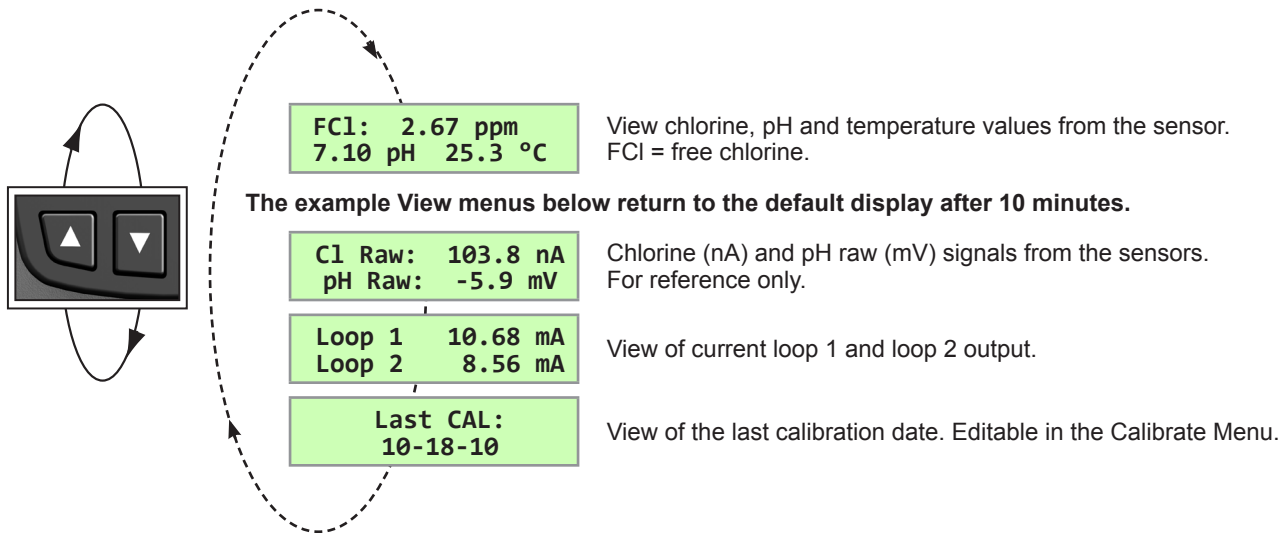

View chlorine, pH and temperature values from the sensor. FCI = free chlorine.

The example View menus below return to the default display after 10 minutes.

Chlorine (nA) and pH raw (mV) signals from the sensors. For reference only.

View of current loop 1 and loop 2 output.

View of the last calibration date. Editable in the Calibrate Menu.

## 10. Transmitter Editing Procedure

- The 8630-3 has two menus the user can edit; CALIBRATE and OPTIONS.
- The CALIBRATE menu allows you to calibrate and initialize sensors, define current loops and set relay functions.
- The OPTIONS menu allows you to set sensor type, adjust and test current loops, test relays and more.

- Step 1. Press and hold the ENTER key:**
  - 2 seconds to select the CALIBRATE menu.
  - 5 seconds to select the OPTIONS menu.
- Step 2. Enter the Key Code.**

The Key Code is UP-UP-UP-DOWN keys in sequence.

  - After entering the Key Code, the display will show the first item in the selected menu.
- Step 3. Scroll the menu in a loop with the DOWN or UP arrow keys.**
- Step 4. Press the RIGHT ARROW key to select the menu item to be edited.**
  - The first display element will begin flashing.
- Step 5. Press the UP or DOWN keys to edit the flashing element.**
  - The RIGHT ARROW key advances the flashing element.
- Step 6. Press the ENTER key to save the new setting and return to Step 3.**

### Made an Error?

Press the UP and DOWN keys simultaneously while any element is flashing. This will recall the last saved value of the item being edited and will return you to Step 3.



### Finished Editing?

Press the UP and DOWN keys simultaneously after saving the last setting to return to view menu.



## 10.1 Example: Calibraton

### Access the CALIBRATE Menu:

The CALIBRATE and OPTIONS menus require a KEY CODE. Press and hold the ENTER key for 2 seconds to access the CALIBRATE menu.

### Enter the Key Code:

Pressing the UP, UP, UP, DOWN keys in sequence unlocks the display and the first menu item will appear. If no key is pressed for 5 minutes while the display is showing "Enter Key Code", it will return to the VIEW menu.

### Scroll the Menu:

Press the DOWN or UP keys to scroll through the Menu. Refer to pages 7 and 8 for complete listing of these items. While in this mode, pressing the UP and DOWN keys simultaneously will return the display to the VIEW menu. If no key is pressed for 10 minutes, the display will return to the VIEW menu.

### Select the item to be edited:

In this example, "Last Cal" (last calibration date) is chosen to edit. Pressing the RIGHT arrow key selects the menu item and enters the screen into edit mode.

### Edit the flashing element:

This is the edit mode. The UP or DOWN keys change the flashing element. The RIGHT arrow key advances the flashing element in a continuous loop. In this example, the Last Cal date was changed from 09-18-09 to 10-18-09. All output functions remain active during editing. Only the flashing element can be edited.

### Press ENTER to save the new value.

When you have set your desired value, pressing the ENTER key stores the value on the screen, making it immediately available to output functions and exits you back to Step 3.

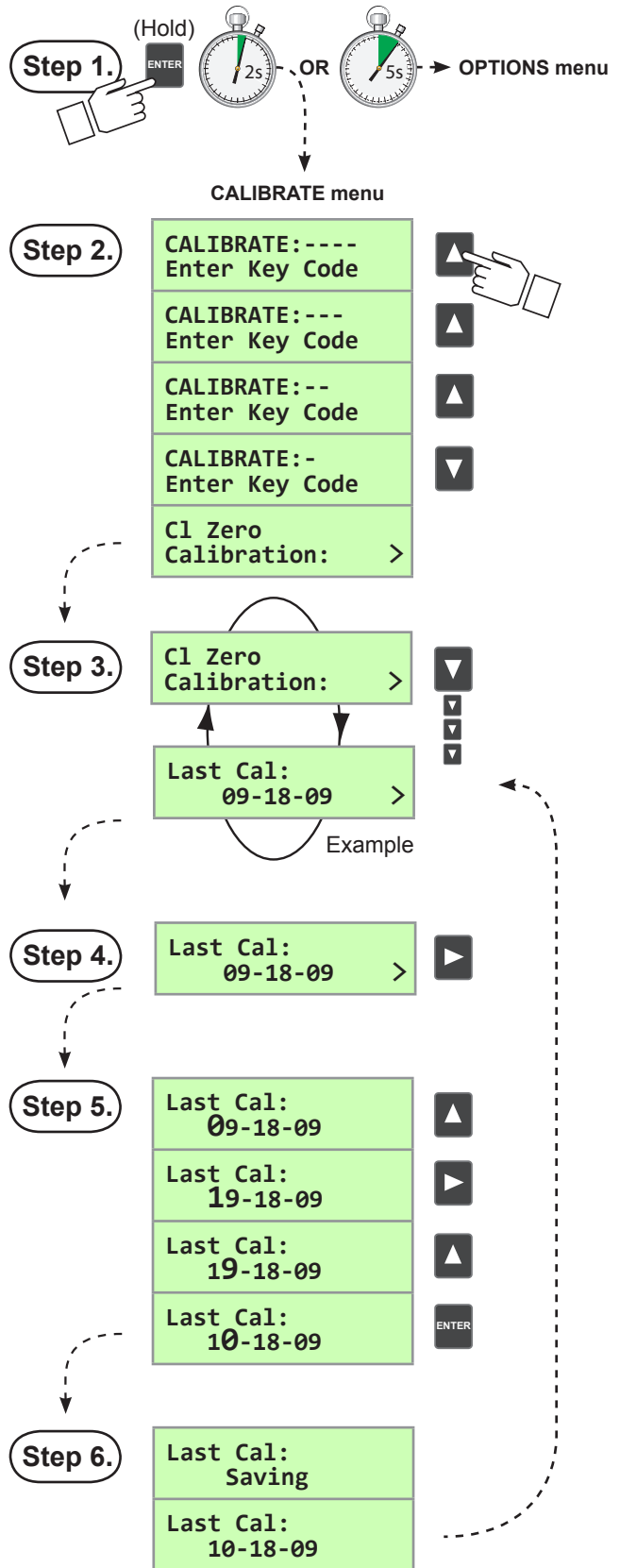

### Made an Error?

Press the UP and DOWN keys simultaneously while any element is flashing. This will recall the last saved value of the item being edited and return you to Step 3.



### Finished Editing?

Press the UP and DOWN keys simultaneously after saving the last setting to return to the View Menu.





## 11. Calibrate Menu Definitions

The menus below are displayed here in the order seen when scrolling down through the Calibrate Menu.

- ! NOTE:
- Although the Calibrate Menu can be navigated upwards or downwards, it is best to navigate downwards when editing Current Loop and Relay settings as previous entries can influence subsequent menus.
  - Chlorine and pH calibration screens will be shown only when a valid sensor is detected.

 Press the Down Arrow key to scroll through the menus

 Press the Right Arrow key to enter edit mode

 Press the Enter key to save your settings

| Calibrate Menus<br>- Factory settings shown - | Description  |
|---|--|
| <b>Chlorine Units:</b><br>ppm >               | This is the first screen. Choose units of measurement of ppm or mg/l.  |
| <b>Cl Zero Calibration:</b> >                 | When > is pressed, the "live" readings are shown. The nA value is displayed, but cannot be edited and is used for diagnostic and calibration purposes. When in Edit Mode, pressing Enter stores the displayed value as your zero reference. Example on Section 15. |
| <b>Cl In Process Calibration:</b> >           | Enter process chlorine value determined from a DPD test kit here. Example on Section 15.   |
| <b>Cl Temperature Calibration:</b> >          | Enter process temperature from a reference thermometer: °C or °F. Units are set up in the Options Menu. Example on Section 15.   |
| <b>Reset Cl to Factory Cal:</b> >             | This menu resets Cl readings, Zero Calibration and temperature back to Factory Calibration. WARNING! User entered Cl calibration settings will be lost.  |

NOTE: The next two pH calibration screens will be shown only when a valid pH sensor is detected.

|                                   |   |
|-----------------------------------|---|
| <b>pH Standard Calibration:</b> > | Set pH offset value. This applies a linear offset to the pH measurement. Example on Section 13.                                   |
| <b>pH Slope Calibration:</b> >    | Applies a slope to the pH measurement. The slope and standard value must be at least 2 pH units apart. Example on Section 13.     |
| <b>Reset pH to Factory Cal:</b> > | Reset pH standard, slope and temperature back to Factory Calibration. WARNING! User entered pH calibration settings will be lost. |

### Current Output Functions

|   |  |
|---|--|
| <b>Loop 1 Source:</b><br>Chlorine >     | Choose chlorine or pH for this 4 to 20 mA current loop. Example on Section 16.   |
| <b>Loop 1 Rng:</b> ppm<br>0.00 → 5.00 > | Select the minimum and maximum values for the current loop output. Units are derived from Loop 1 Source. If the Source 1 is changed, be sure to re-edit this page. |
| <b>Loop 2 Source:</b><br>pH >           | Choose pH or chlorine for this 4 to 20 mA current loop.  |
| <b>Loop 2 Rng:</b> pH<br>00.0 → 14.00 > | Select the minimum and maximum values for the current loop output. Units are derived from Loop 2 Source. If Source 2 is changed, be sure to re-edit this page.     |



Relay Functions

**!** Verify all relay settings if the Relay Source is changed.

**Relay 1 Mode:**  
Off > Choose mode of operation: Off, Low, High, Window, or Pulse. If Off, all subsequent Relay 1 functions are inactive and not visible. Example on Section 16.3.

*If Low or High Mode was chosen:*

**Relay 1 Source:**  
Chlorine > Choose chlorine or pH for Relay 1.

**Relay 1 Setpnt:**  
0.00 ppm > In Low or Hi Mode, Relay 1 will be activated when the process reaches this value. Units of measure reflect Relay 1 Source.

**Relay 1 Hys:**  
0.20 ppm > Relay 1 will be deactivated at Relay 1 Setpoint  $\pm$  this hysteresis setting depending on High or Low Setpoint selection.

**Relay 1 Delay:**  
0.0 secs > Set the time delay for Relay 1 to activate after reaching the Setpoint. Range: 0 to 6400 seconds.

*If Window Mode was chosen:*

**Relay 1 Source:**  
Chlorine > Choose chlorine or pH for Relay 1.

**Relay1 Rng: ppm**  
0.00  $\rightarrow$  5.00 > Enter the range where Relay 1 will activate above and below this setpoint.

**Relay 1 Hys:**  
0.20 ppm > Relay 1 will be deactivated at Range setpoints  $\pm$  this hysteresis setting.

**Relay 1 Delay:**  
0.0 secs > Set time delay for Relay 1 to activate after reaching the setpoints set in Relay 1 Range.

*If Pulse Mode was chosen:*

**Relay 1 Source:**  
Chlorine > Choose chlorine or pH for Relay 1.

**Relay1 Rng: ppm**  
0.00  $\rightarrow$  5.00 > Enter the range where Relay 1 will activate above and below this setpoint.

**Relay1 PlsRate:**  
120 pulses/min > Set the maximum pulse rate. Range: 1 to 400 pulses/min.

**Relay 2 Mode:**  
Off > Choose Relay 2 mode of operation: Off, Low, High, Window, or Pulse. To disable this relay choose Off.

*If Low or High Mode was chosen:*

**Relay 2 Source:**  
pH > Choose pH or chlorine for Relay 2. This menu screen and all subsequent Relay 2 screens below do not appear if Relay 2 Mode is set to Off.

**Relay 2 Setpnt:**  
0.00 pH > In Low or High Mode, Relay 2 will be activated when the process reaches this value. Units of measure reflect Relay 2 Source.

**Relay 2 Hys:**  
0.20 pH > Relay 2 will be deactivated at Relay 2 Setpoint  $\pm$  this hysteresis setting depending on High or Low Setpoint selection.

**Relay 2 Delay:**  
0.0 secs > Set the time delay for Relay 2 to activate after reaching the Setpoint. Range: 0 to 6400 seconds.



If Window Mode was chosen:

- Relay 2 Source:**  
 pH >

Choose pH or chlorine for Relay 2.
- Relay 2 Rng: ppm**  
 0.00 → 5.00 >

Enter the range where Relay 2 will activate above and below this setpoint.
- Relay 2 Hys:**  
 0.20 ppm >

This relay will be deactivated at Relay 2 Range setpoints ± this hysteresis.
- Relay 2 Delay:**  
 0.0 secs >

Set the time delay for Relay 2 to activate after reaching the setpoints set in the Relay 2 Range.

If Pulse Mode was chosen:

- Relay 2 Source:**  
 pH >

Choose pH or chlorine for Relay 2.
- Relay2 Rng: pH**  
 0.00 → 14.0 >

Enter the range where Relay 2 will activate above and below this setpoint.
- Relay2 PlsRate:**  
 120 pulses/min >



Set the maximum pulse rate. Range: 1–400 pulses/min.
- Find New Sensor(s):** >

Required only when a new sensor is changed while the power is on. Choose Yes or No.
- Last Cal**  
 10-18-09 >

Edit the calibration date.

————— End of Calibrate Menu —————

## 12. Options Menu Definitions

-  Press the Down key to scroll through the menus
-  Press the Right Arrow key to enter edit mode
-  Press the Enter key to save your settings

| Options Display<br>(Factory settings shown) | Description   |
|---|---|
| <b>Contrast:</b><br>3 >                     | Adjust the LCD contrast for best viewing. A setting of 1 is lower contrast, 5 is higher.  |
| <b>Cl Sensor Type:</b><br>Free Cl >         | Select the chlorine sensor: Free Cl.  |
| <b>pH Input Sensor</b> >                    | Choose Manual or Sensor. If Sensor is chosen, the pH value from the connected pH sensor will be used. Choose Manual to enter a pH value manually when no sensor is connected. |

If Manual pH input was chosen:

- Manual pH Value**  
 7.000 pH

Enter your pH value here if a pH sensor is not connected.
- Temp Display:**  
 °C >

Choose units of °C or °F.
- Averaging:**  
 Off >

OFF gives the fastest response to input changes. LOW = 4.5 seconds, HIGH = 9 seconds of averaged response. Increase averaging to steady the display.

| Options Display<br>(Factory settings shown) | Description  |
|---|--|
| Decimal:<br>***.** >                        | Select the decimal point for the display. Maximum of 2 decimal places.   |
| Loop 1 Adjust:<br>4.00 mA >                 | Adjust the minimum current output for Loop 1. The display value represents the precise current output. Range: 3.80 mA to 5.00 mA.  |
| Loop 1 Adjust:<br>20.00 mA >                | Adjust maximum current output for Loop 1. Range: 19.00 mA to 21.00 mA.   |
| Loop2 Adjust:<br>4.00 mA >                  | Adjust the minimum current output for Loop 2. Range: 3.80 mA to 5.00 mA.   |
| Loop2 Adjust:<br>20.00 mA >                 | Adjust maximum current output for Loop 2. Range: 19.00 mA to 21.00 mA.   |
| Test Loop 1:<br>>                           | Press UP or DOWN keys to manually output any current value from 3.6 mA to 21.00 mA to test Loop 1 output.                          |
| Test Loop 2:<br>>                           | Press UP or DOWN keys to manually output any output current value from 3.6 mA to 21.00 mA to test Loop 2 output.                   |
| Test Relay 1:<br>>                          | Press UP or DOWN keys to manually toggle Relay 1 Off and On. The left LED on the front of the transmitter confirms operation.      |
| Test Relay 2:<br>>                          | Press UP or DOWN keys to manually toggle Relay 2 Off and On. The right red LED on the front of the transmitter confirms operation. |
| Read Sens Data:<br>No >                     | If "YES" is selected the following ( <b>Read Only</b> ) screens will be shown. If "NO" then this menu ends the Options Menu.       |
| <i>If Yes was chosen:</i>                   |  |
| Cl Sensor S/N:<br>xxxxxxxxxx                | View the sensor serial number.   |
| Cl Type & Range:<br>2630 xxx.x ppm          | Identify the chlorine sensor type connected and its ppm range.   |
| Zero Cal: ppm&nA<br>xxx.xx xxxx.x           | View user entered Zero Calibration data in ppm and nA.   |
| In Proc: ppm&nA<br>xxx.xx xxxx.x            | View user In-Process Calibration value when it was entered in the Calibrate Menu.  |
| Temp at Cal:<br>xxxx.x °C                   | Temperature recorded during user In-Process Calibration.   |
| pH at Cal:<br>xxx.xx pH                     | pH value recorded during user In-Process Calibration.  |
| Temp Offset:<br>xxxx.x °C                   | Temperature offset calculated from user entered temperature calibration from Calibrate Menu.                                       |
| Elapsed Time:<br>xxxxx. hrs                 | Total hours of operation.  |
| Low & High: °C<br>-xxxx.x +xxxx.x           | Lowest and highest temperatures the Cl sensor has been subjected to during operation.  |

---

End of Options Menu

---

## 13. pH Sensor Calibration

### System Start-up: Step 3

If a pH sensor is part of the system, it must be calibrated before use and before the chlorine sensor is calibrated. If a pH sensor is not available but pH determination is necessary, measure process pH with a separate test and enter the value in the Options Menu.

Next step: **Chlorine Sensor Conditioning** (see section 14). ▶

Refer to your pH sensor manual.

The pH sensor needs to be calibrated against two different pH buffer references to calibrate the offset (standard) and slope. Electrode offset is any deviation from 0 mV in a pH 7 buffer at 25 °C. Slope is the ratio of mV to pH units.

- Always keep any output devices offline when calibrating.

### 13.1 pH Offset (Standard)

The transmitter must be powered on and the pH sensor must be connected.

- Turn off the water flow through the system, then remove the pH sensor from its flow cell.
- Using pH buffer 7.0, place enough pH buffers into a clean calibration cup, supplied with the pH calibration kit 3-2700.395 (159 001 605), to cover the tip of the electrode.
- Pour distilled water in another clean cup for rinsing the electrode between buffers
- Place the pH sensor in the pH 7.0 buffer and allow the reading to stabilize.

#### Example: Set pH Standard to 7.00.

- Go to the Calibrate Menu.
- Scroll down ▼ 5 menus to the **pH Standard** menu.
- Press ▶ to enter Edit Mode.
- Enter the pH value of the buffer that the electrode is placed in; **7.00** in this case. Note: the mV readings will not change.
- Press the Enter button to save the setting.
- Exit to the View Menu. (▲▼)

EXAMPLE

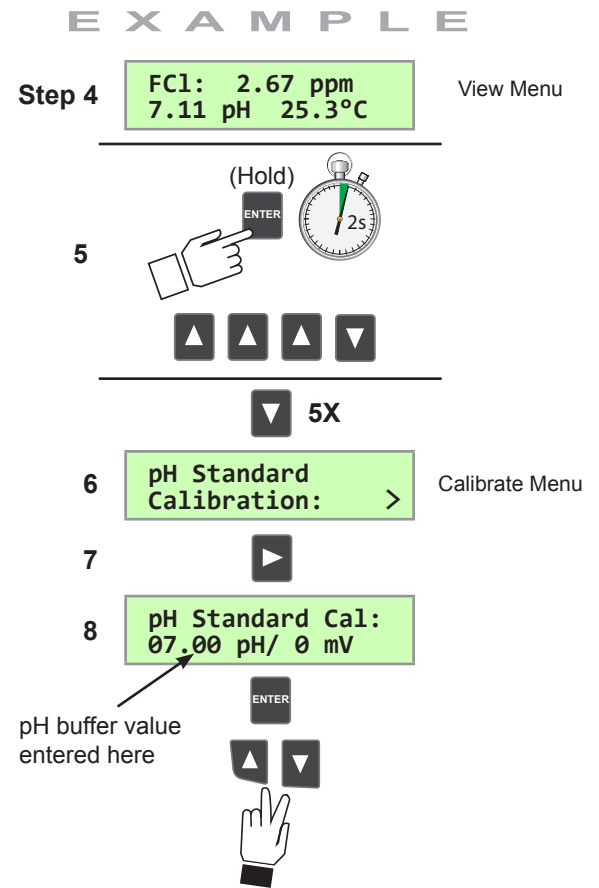

### 13.2 pH Slope

- Remove the pH sensor from the first buffer solution and rinse it in distilled water.
- Place the pH sensor in a different buffer solution (example: pH 4.01). The pH standard and slope must be at least 2 pH units apart.
- Note the pH reading on the View Menu and allow it to stabilize.

#### Example: Set pH slope to 4.01.

- Go to the Calibrate Menu.
- Scroll down ▼ 6 menus to the **pH Slope** menu.
- Press ▶ to enter Edit Mode.
- Enter the pH value of the buffer that the electrode is placed in; **4.01** in this case. Note: the mV readings will not change.
- Press the Enter button to save the settings.
- Exit to the View Menu. (▲▼)
- Replace the pH sensor back into its flow cell.

Calibration is complete for the pH sensor.

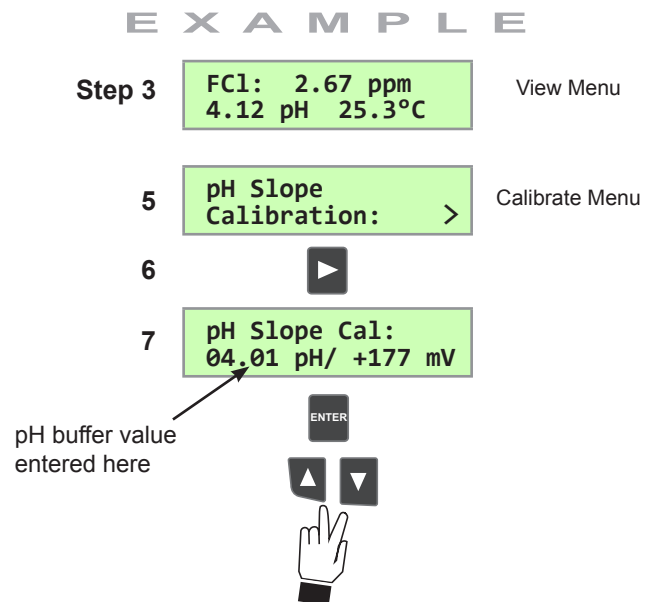

If the pH of the application is stable, then the pH of the application can be entered manually and will be used to calculate the chlorine measurements.

**Example: Change the pH input from Sensor to Manual and enter a pH value of 7.22.**

- E X A M P L E**

  1. Go to the Options Menu.
  2. Scroll down ▼ 2 menus to the **pH Input** menu.
  3. Press ► to enter Edit Mode.
  4. Choose **Manual** and press Enter.
  5. Scroll down ▼ 1 menu to the **Manual pH Value** menu.
  6. Press ► to enter Edit Mode.
  7. Enter your new process pH value: **7.22**.
  8. Press the Enter button to save the setting.
  9. Exit to the View Menu. (▲▼)

**E X A M P L E**

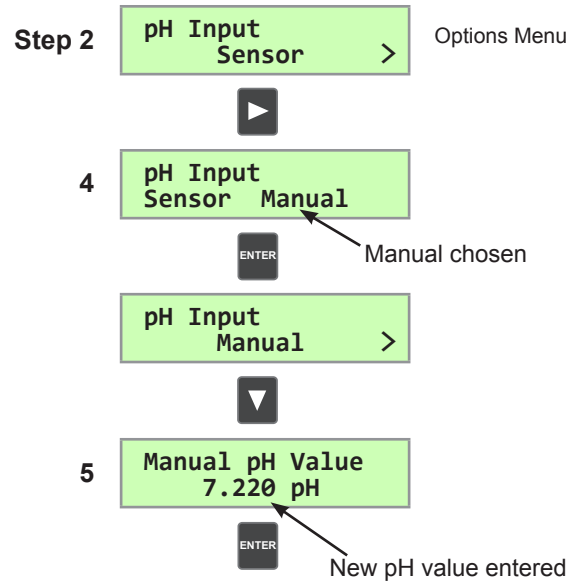

## 14. Chlorine Sensor Conditioning



**System Start-up: Step 4**

*A new chlorine sensor or one that has had the electrolyte or membrane replaced must be conditioned to generate stable and accurate readings. To condition a chlorine sensor, the sensor and sensor electronics must be installed and powered and must also have water flow across the membrane:*

**Next step: Calibrating Chlorine (see section 15).** ►

**Chlorine Sensor Conditioning**

1. Turn on and adjust water flow rate. Condition a new chlorine sensor for 4 hours. Conditioning time for a membrane cap replacement or electrolyte refill is 2 hours.
2. Keep any 4 to 20 mA devices or relay actuated output devices that connect to the transmitter offline.

## 15. Chlorine Sensor Calibration

### System Start-up: Step 5

Chlorine sensors need to be calibrated for accuracy. After the 4 hour conditioning period, Temperature Calibration, Zero Point Calibration and In-Process Calibration needs to be performed. Any 4 to 20 mA or relay output devices should be offline.

Next step: **Setting Output Settings** (see section 16). ▶

### 15.1 Chlorine Sensor Temperature Calibration

The temperature element inside the chlorine sensor needs to be calibrated. Use a reference thermometer at the same temperature and in the same medium as the immersed sensor.

**Example: Set the calibrated temperature to 25.3 °C.**

1. Go to the Calibrate Menu. EXAMPLE
2. Scroll down ▼ 3 menus to the **Cl Temperature** menu.
3. Press ▶ to enter Edit Mode.
4. Enter the temperature reading. **Example: 25.3.**
5. Press the Enter button to save the setting.
6. Exit to the View Menu. (▲▼)

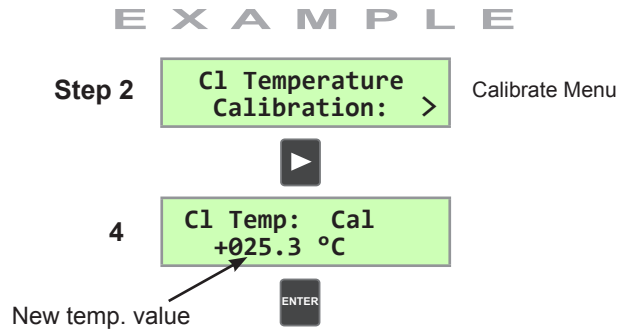

### 15.2 Zero Point Calibration

The chlorine sensor needs to be calibrated against two chlorine references: zero chlorine and the process chlorine. Typically the zero point calibration is very stable. Calibration must be done with every new sensor and any time a membrane cap is replaced.

1. Ensure any output devices are offline and disable relays.
2. Turn off the water flow and remove the powered chlorine sensor with the electronics still attached.
3. Place the sensor tip in distilled water.
4. Wait until the reading stabilizes, then save the calibration. Stirring the sensor in water is not necessary, but allows the signal to stabilize faster.

**Example: Set the Zero Point Calibration at 1.0 nA.**

5. Go to the Calibrate Menu. EXAMPLE
6. Scroll down ▼ one menu to the **Cl Zero** menu.
7. Press ▶ to enter Edit Mode. You will see flashing the live sensor readings in ppm and nA. These readings cannot be modified, but can only be saved as displayed.
8. Press the Enter button at the lowest reading to save the setting or press (▲▼) to escape without changes.
9. Exit to the View Menu. (▲▼)
10. After Zero Point Calibration is complete, replace the sensor back into the flow cell and turn the water flow back on.
11. Wait until the chlorine readings stabilize once again, then perform a chlorine In-Process Calibration.

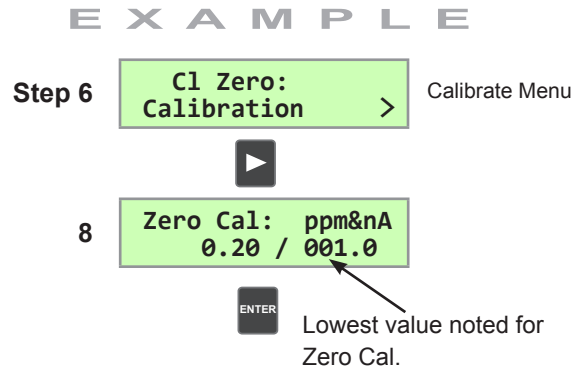

**The signal level during a Zero Point Calibration must be at least 1 nA away from the In-Process Calibration point.**

### 15.3 In-Process Calibration

1. Take a water sample from the Sampling Port (after purging it) from a stabilized and running system.
2. Use this sample to measure the chlorine content with a colorimetric DPD test kit (not included). Refer to the DPD kit instructions on how to perform this test.
3. Record the test results.

**Example: Set the Chlorine In-Process to 2.67 ppm.**

- E X A M P L E**

  4. Go to the Calibrate Menu.
  5. Scroll down ▼ 2 menus to the **CI In-Process** menu.
  6. Press ► to enter Edit Mode.
  7. Enter the chlorine reading determined from the DPD test into the edit screen: **2.67 ppm**. The CI ppm is editable and must be at least 0.2 ppm.
  8. Press the Enter button to save the setting.
  9. Exit to the View Menu. (▲▼)

Calibration is complete for the chlorine sensor.

**The signal level during an In-Process Calibration must be at least 1 nA away from the previous Zero Calibration point.**

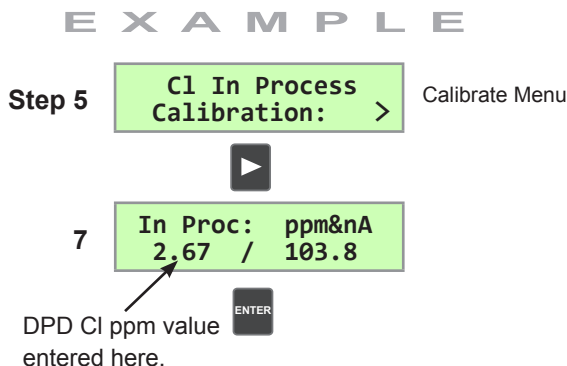

## 16. Output Settings - Current Loops and Relays

### System Start-up: Step 6 (last step)

Configure the current loop and relay functions if applicable. The current and relay outputs can be tested in the Options Menu. This concludes the system start-up procedure.

### 16.1 Current Loop Settings

Current outputs are passive outputs that can be spanned in the forward and reverse direction. Example: 0 to > 5 or 5 to > 0.

**Example: Set a current loop source as chlorine and the operational range to 0 to 5 ppm.**

- E X A M P L E**

  1. Go to the Calibrate Menu.
  2. Scroll down ▼ to the **Loop 1 Source** menu.
  3. Press ► to enter Edit Mode.
  4. Choose either the chlorine or pH sensor as the source that will control this loop: **Chlorine**.
  5. Press the Enter button to save the setting.
  6. Scroll down ▼ 1 menu to the **Loop 1 Rng** menu.
  7. Press ► to enter Edit Mode.
  8. Select the minimum and maximum process values for the current loop output: **0 to 5 ppm**.
  9. Press the Enter button to save the setting.
  10. Exit to the View Menu. (▲▼)

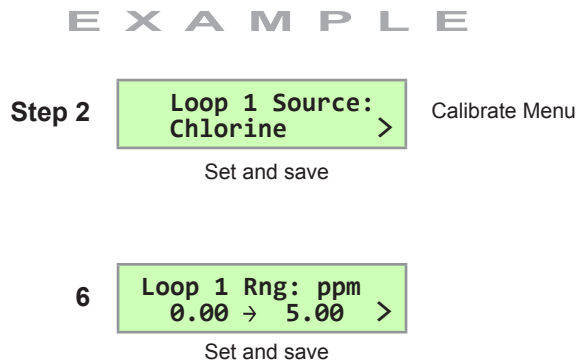

The 8630 relays are selectable and configurable and can be used as switches that respond when the process value moves above or below a user defined setpoint. They can be used for Low Alarm, High Alarm or Proportional Pulse triggering related to the process value. Relay functions, hysteresis and time delay settings are set up in the CALIBRATE menu and can be tested in the OPTIONS menu.

◇ **Low Setpoint:**

Relay is activated when the measured value is less than the setpoint.

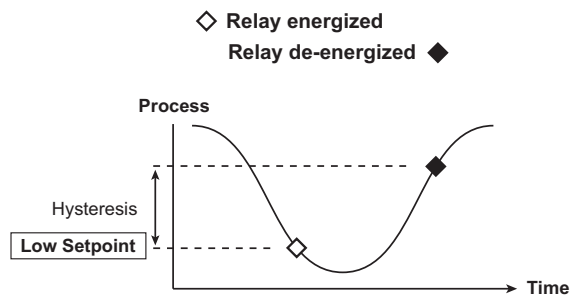

◇ **High Setpoint:**

Relay is activated when the measured value is higher than the setpoint.

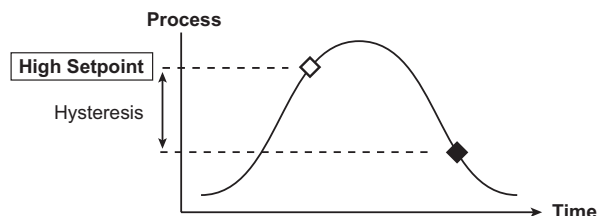

◆ **Window:**

Relay is off within the window of two setpoints minus the hysteresis. Relay is activated when the value is higher or lower than the high and low setpoint.

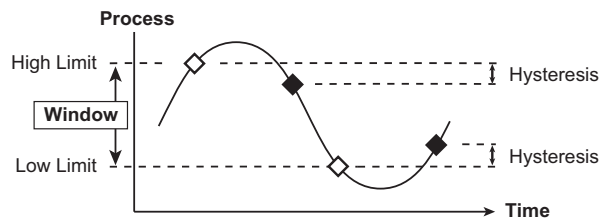

□□ **Pulse-frequency Operation:**

The transmitter can output a pulse at the rate defined by the settings in the CALIBRATE menu and the sensor input. The maximum pulse square wave output from the relays is 400 pulses per minute. Example usage would be to control solenoid operated dosing pumps.

Example: As the process value drops below the setpoint (4 mg/l) the output will start pulsing in relation to the process value, the maximum pulse endpoint and the programmed pulses/minute. The pulse rate will increase as the process value decreases and approaches the programmed endpoint. This functionality can be used to precisely control the process.

- The output will be 0 pulses/minute when the input value is greater than 4 mg/l.
- The output will be 35 pulses/minute when the input value is 3 mg/l.
- The output will be 100 pulses/minute when the input value is 1 or less.

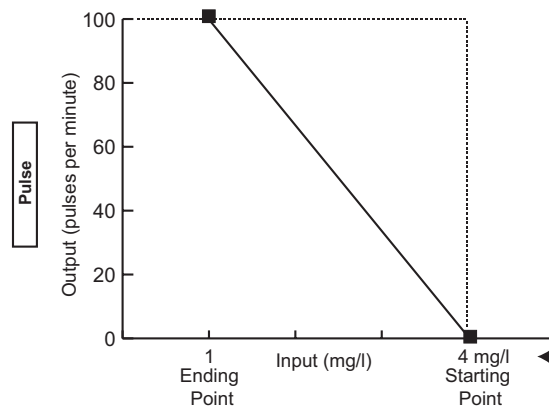

The starting point, endpoint and maximum pulse rate are selectable in the CALIBRATE menu.



**Example:** Set a relay to trigger on at a low setpoint of 1.0 ppm with a time delay of 15 seconds and turn off at 1.30 ppm.

- Once a setting is saved it becomes immediately active.

- E X A M P L E**
1. Go to the Calibrate Menu.
  2. Scroll down ▼ to the **Relay 1 Mode** menu.
  3. Press ► to enter Edit Mode.
  4. Scroll down ▼ and choose **Low**.
  5. Press Enter.
  6. Scroll down ▼ to the **Relay 1 Source** menu. The default is Chlorine which is what we want in this example.
  7. Scroll down ▼ to the **Relay 1 Setpnt** menu.
  8. Press ► to enter Edit Mode.
  9. Set the ppm value to trigger the relay: **1.00 ppm**.
  10. Press Enter.
  11. Scroll down ▼ to the **Relay 1 Hys** menu.
  12. Press ► to enter Edit Mode.
  13. Set the hysteresis (dead zone) for this relay. This affects the turn off only: **0.3 ppm**.
  14. Press Enter.
  15. Scroll down ▼ to the **Relay 1 Delay** menu.
  16. Press ► to enter Edit Mode.
  17. Set the turn-on delay in seconds for the relay: **15 secs**.
  18. Press Enter.
  19. Exit to View Mode. (▲▼)

- Relay function can be tested in the Options Menu.

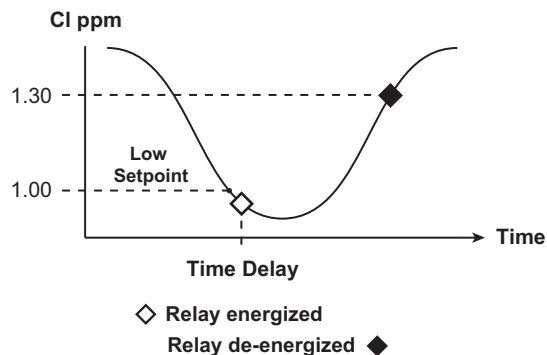

- E X A M P L E**
- Step 4** Relay 1 Mode:  
Low > Calibrate Menu  
Set and save
- 6** Relay 1 Source:  
Chlorine >  
Set and save
- 9** Relay 1 Setpnt:  
1.00 ppm >  
Set and save
- 13** Relay 1 Hys:  
0.30 ppm >  
Set and save
- 17** Relay 1 Delay:  
15.0 secs >  
Set and save

## 17. Troubleshooting

Several factors can cause irregular or incorrect readings. The first thing to check is to verify that the transmitter and sensors have been installed correctly. The list below outlines possible causes and remedies.

| <b>Transmitter Troubleshooting</b>                                    |  |   |
|---|--|---|
| <b>Problem</b>  | <b>Possible Cause</b>  | <b>Remedies</b>   |
| Transmitter does not turn on.   | Incorrect wiring.<br>No or low voltage supplied to transmitter.<br>Blown fuse.<br>Bad wire connections or splices. | Check wiring, power supply and wiring connections.  |
| Display screen is too dark or too dim.                                | Contrast set incorrectly or ambient temperature is too high.   | Adjust contrast in Options Menu.  |
| LCD backlight, relays and sensors do not work.                        | No power supplied to terminals 1 and 2.  | Transmitter requires power to terminals 1, 2, 3 and 4.  |
| Incorrect temperature reading.  | Faulty chlorine sensor.<br>Bad sensor connection.  | Check connections, or replace sensor.   |
| Digital or Current output is erratic.                                 | Electrical noise interfering with the measurement.<br>Sensor malfunction.  | Ensure system is properly grounded.<br>See Sensor Troubleshooting.  |
| Output is not zero when electrode is placed in non-chlorinated water. | Electrode not properly conditioned.<br>Noise interfering with the measurement.<br>Calibration incorrect.           | Condition new sensor for 4 hours. Cap replacement or electrolyte refill: 2 hours.<br>Properly ground system.<br>Replace sensor. |
| 4 to 20 mA output is incorrect.                                       | 4 to 20 mA is not scaled same as Loop device.<br>Loop device is not scaled same as sensor.                         | Re-span loop device to match sensor.  |
| <b>Chlorine Sensor Troubleshooting (see 2630 sensor manual)</b>       |  |   |
| Incorrect readings  | Sensor conditioning time too short.  | Run for 4 hours before calibrating.   |
|   | Membrane cap damaged or contaminated.  | Clean or replace cap.   |
|   | Interference from water contaminants.  | See technical data (Section 19).  |
|   | Low flow rate.   | Check flow.   |
|   | Air bubbles on membrane.   | Install flow cell vertically with upwards flow.   |
|   | pH outside working range (see technical data, Section 19).   | Check pH.   |
|   | Low or no electrolyte in sensor.   | Fill sensor with electrolyte.   |
|   | Membrane cap loose.  | Inspect/tighten (do not use tools).   |
|   | Only combined chlorine present when measuring free chlorine.   | Validate with DPD test.   |
|   | Sensor not making good contact with electronics.   | Inspect and reconnect.  |
|   | Defective sensor.  | Replace.  |
|   | No pH compensation being used.   | Manually enter pH value in Options or calibrate pH sensor.  |
| Cl sensor not calibrated.   | Calibrate Cl sensor.   |   |

## 17.1. Error Messages

The 8630 error warnings are self-explanatory. An error message can appear under the following circumstances:

- User input value is out of range
- Poor electrical connection
- Sensor is not connected or detected
- Temperature error
- Incorrect sensor type chosen in the Options Menu
- Two calibration points are too close together when calibrating pH or chlorine.

| Error Messages                                 | Problem  | Possible Cause   | Remedies  |
|--|--|--|---|
| <b>Sens Data Error</b>                         | Cl sensor data memory error.   | Cl sensor is not connected.<br>Damaged sensor.   | Check Cl sensor wiring and connection.  |
| <b>CHK Cl SENSOR</b>                           | Cl sensor is not detected.   | Cl sensor not connected.<br>Wrong wiring.<br>Damaged sensor.   | Check wiring and connection.  |
| <b>CHK pH SENSOR</b>                           | pH sensor is not detected.   | pH sensor is not connected.<br>Wrong wiring.<br>Damaged sensor.  | Check wiring and connection.  |
| <b>Out Of Range<br/>CHECK SENSOR</b>           | pH calibration error.  | pH values are out of range.  | Enter proper values during calibration.   |
| <b>Standard Too Close<br/>To Slope!</b>        | pH standard calibration point is too close to slope point.                                     | Wrong data is entered. pH buffer solution used has value too close to standard point.                          | Re-enter correct data.<br>Use proper buffer solution at least 2 pH units apart from slope buffer solution.      |
| <b>Slope Too Close<br/>To Standard!</b>        | pH slope calibration point is too close to standard point.                                     | Wrong data is entered. pH buffer solution used has value too close to standard point.                          | Re-enter correct data.<br>Use proper buffer solution at least 2 pH units apart from standard buffer solution.   |
| <b>Signal Too Close<br/>To Other Cal Pt</b>    | The signal level of Cl for In-process calibration is too close to the Zero Cal Point.          | The Cl solution used for In-process calibration is too close to Zero Cal. These two points must be 1 nA apart. | Use proper solution at least 1 nA apart.  |
| <b>Cl Value Must Be<br/>&gt; = 0.2 ppm</b>     | The Cl value entered during In-process calibration is too small.                               | Wrong data is entered. The value entered must be at least 0.2 ppm (mg/l).                                      | Re-enter correct value.   |
| <b>Signal Too High<br/>Must Be =&lt; 10 nA</b> | The signal level during Zero calibration is too high. Signal must be equal or less than 10 nA. | The sensor is not stabilized.<br>The solution used has too much chlorine.                                      | Wait for sensor stabilization.<br>Check solution to ensure that the chlorine level is close to zero ppm (mg/l). |
| <b>pH Too High<br/>Must be =&lt; 9</b>         | pH value is too high.  | During In-Process calibration the pH value is too high and must be less than or equal to 9.                    | Check pH.   |
| <b>pH Too Low<br/>Must be &gt;= 4</b>          | pH value is too low.   | During In-process calibration the pH value is too low and must be greater than or equal to 4.                  | Check pH.   |
| <b>FC1=<br/>CHK pH Sensor</b>                  | pH sensor is not detected.   | pH sensor is not connected.<br>Wrong wiring.<br>Damaged pH sensor.   | Check wiring and connections or change pH input to Manual in Options Menu.                                      |

## 18. Ordering Information

| Mfr. Part No. | Code        | Description                             |
|---------------|-------------|---|
| 3-8630-3P     | 159 001 673 | Panel mount chlorine and pH transmitter |

### Accessories and Replacement Parts

| Mfr. Part No. | Code        | Description   |
|---------------|-------------|---|
| 3-2630.391    | 159 001 674 | Free Chlorine electrolyte, 30 ml  |
| 3-2630.392    | 159 001 675 | Free Chlorine replacement membrane (1)  |
| 3-2630.396    | 159 001 676 | Free Chlorine replacement kit - (2) electrolyte and (2) membranes                                     |
| 3-0700.390    | 198 864 403 | pH Buffer Kit (1 each 4, 7, 10 pH buffer in powder form, makes 50 mL)                                 |
| 3822-7004     | 159 001 581 | pH 4.01 buffer solution, 1 pint (473 ml)  |
| 3822-7007     | 159 001 582 | pH 7.00 buffer solution, 1 pint (473 ml)  |
| 3822-7010     | 159 001 583 | pH 10.00 buffer solution, 1 pint (473 ml)   |
| 3-2700.395    | 159 001 605 | Calibration kit: included 3 polypropylene cups, box used as cup stand, 1 pint pH 4.01, 1 pint pH 7.00 |

## 19. Specifications

## Signet 3-8630-3 Chlorine Transmitter

### Dimensions

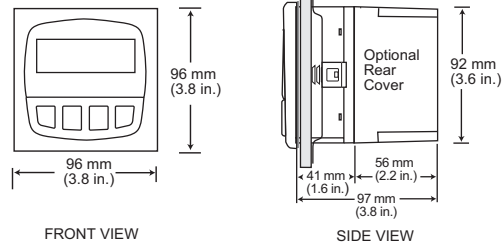

### General

#### Compatible Sensors:

- Signet 3-2630-2 Free Chlorine Sensor
- Signet 3-2724-00 Flat pH Sensor

#### Compatible Electronics

- Signet 3-2650-7 Amperometric Electronics
- Signet 3-2750-7 pH Sensor Electronics

#### Materials:

- Case: PBT
- Panel case gasket : Neoprene
- Window: Polyurethane-coated polycarbonate
- Keypad: Silicone rubber

#### Display:

- LCD: Backlit alphanumeric 2 x16 dot matrix
- Keypad: Silicone rubber
- Display update rate: 1 second
- Contrast: User selected, 5 levels

### Performance

#### System Operational Ranges/Limits (Chlorine):

- Free Cl  
0 ppm to 5 ppm

#### pH Input Range:

- 0 pH to 14 pH

#### Chlorine Compensation Range:

- pH: 5.0 pH to 9.0 pH (Free Chlorine)
- Temperature range: 0 °C to 45 °C (32 °F to 113 °F)

#### Maximum Cable Distance (sensor to transmitter):

- Digital (S<sup>3</sup>L): 30 m (100 ft) maximum
- 4 to 20 mA output: 305 m (1000 ft) maximum

### Electrical

#### Power Supply Requirement:

- 12 to 24 VDC ±10% regulated, 250 mA max current

#### Sensor Power (provided by 8630):

- 5 VDC ±1% @ 25 °C, regulated
- 2-wire system: 1.5 mA maximum current
- 4-wire system: 20 mA maximum current

### Input Specifications:

- One Digital (S<sup>3</sup>L) input from Free Chlorine,
- One Digital (S<sup>3</sup>L) input from pH sensor

### Output Specifications:

- Current Loop (2 loops provided)
  - 4 to 20 mA, isolated, adjustable span, reversible with minimum and maximum endpoint adjustment.
  - Ability to use chlorine or temperature as input.
- Update Rate: 300 ms
- Max Loop impedance:
  - 50 Ω max. @ 12 V
  - 325 Ω max. @ 18 V
  - 600 Ω max. @ 24 V
- Relay Outputs:
  - 2 mechanical SPDT contacts with adjustable hysteresis and programmable High, Low, Off, Pulse or Window range.
  - Maximum voltage rating:
    - 5 A @ 30 VDC
    - 5 A @ 250 VAC, resistive load
  - May be disabled if not used
  - Time delay: Programmable from 0 to 6400 s

### Environmental Requirements

#### Operating Temperature:

- 25 °C to 120 °C (-13 °F to 248 °F) transmitter only

#### Storage Temperature:

- 15 °C to 80 °C (5 °F to 176 °F)

#### Relative Humidity:

- 0 to 95%, non-condensing

#### Maximum Altitude:

- 2000 m (6562 ft)

#### Enclosure:

- NEMA 4X/IP65 front

### Standards and Approvals

CE

UL

Manufactured under ISO 9001 and ISO 14001

China RoHS (Go to [www.gfsignet.com](http://www.gfsignet.com) for details)



Georg Fischer Signet LLC, 3401 Aerojet Avenue, El Monte, CA 91731-2882 U.S.A. • Tel. (626) 571-2770 • Fax (626) 573-2057  
For Worldwide Sales and Service, visit our website: [www.gfsignet.com](http://www.gfsignet.com) • Or call (in the U.S.): (800) 854-4090  
For the most up-to-date information, please refer to our website at [www.gfsignet.com](http://www.gfsignet.com)