

RSTi-OM Fieldbus Module with PROFINET IO and Modbus/TCP

USER MANUAL



Contents

Section 2: Introduction	6
2.1.1 Revisions in this Manual.....	6
2.2 Locating the Latest Software and Documentation	6
2.3 IO-Link Master Description	7
2.3.1 Features	7
2.3.2 Front Panel Description	7
2.3.3 Connectors Overview	8
2.3.4 Specifications.....	9
Section 3: Hardware Installation	10
3.1 IOLM Hardware Installation.....	10
3.1.1 Setting the Rotary Switch	10
Changing the Default Rotary Switch Settings	10
3.1.2 Connecting to the Network	12
3.1.3 Connecting the Power.....	13
Section 4: Configuring the IOLM with PAC Machine Edition ..	15
4.1 Overview	15
4.2 Installing the GSDML File	16
4.3 Configuring the IOLM	17
4.4 IP Address Assignment	18
4.4.1 Assigning an IP Address via IO Controller (DCP)	18
4.4.2 Assigning an IP Address via DHCP	20
Assign IP Address Statically Using the Web Page	22
4.5 Device Name Assignment.....	24
4.5.1 Assign the Device Name in PAC Machine Edition.....	24
4.5.2 Using the Web Interface to Assign the Device Name	25
4.6 Setting the IO Device Update Time	27
4.7 Configuring IO-Link Ports.....	27
4.7.1 IO-Link Port Modules	29
IO-Link Port Settings (IO-Link Port Module Parameters)	30
Parameter Configuration	32
SIO Digital In/Out Module Parameters	34
4.7.2 Port Status Modules	36
IO-Link Status Module.....	36
Auxiliary Input Parameters (for port 1 to port 8)	38
4.7.3 Configuring IO-Link Ports with the Web Interface	38
Section 5: Updating the IOLM Firmware and Application Files	43
5.1 Images (firmware) and Application Sub-Assemblies Overview	43
5.1.1 Images	44
5.1.2 Application Subassemblies	45
5.2 Using the Web Interface to Update Software	45
5.2.1 Updating Images.....	45
5.2.2 Updating Application Subassemblies.....	47

Section 6:	Connecting Devices	48
6.1	Overview	48
6.2	IOLM IO-Link Ports	48
Section 7:	IO-Link Master Port Configuration	51
7.1	Preparing for Port Configuration	51
7.2	IO-Link Configuration Page	54
7.2.1	Editing IO-Link Port Settings	54
7.2.2	IO-Link Settings Parameters	56
7.3	PROFINET IO Settings Configuration Page	59
7.4	Modbus/TCP Settings Configuration Page	60
	Editing Modbus/TCP Settings	61
7.4.1	Modbus/TCP Settings Parameters	62
7.5	OPC UA Settings Configuration Page	64
7.5.1	Edit OPC UA Settings	65
7.5.2	OPC UA Settings Parameters	66
Section 8:	Configuring IO-Link Devices	67
8.1	Port Pages Overview	67
8.2	Editing Parameters - IO-Link Device - Port Table	70
8.3	Resetting IO-Link Device Parameters to Factory Defaults	71
8.4	Editing Parameters - IO-Link Device ISDU Interface - Port	72
8.4.1	Overview	72
8.4.2	How to Use the Interface	73
Section 9:	Utilizing IOLM Features	75
9.1	Setting User Accounts and Passwords	76
9.2	Data Storage	77
9.2.1	Uploading Data Storage to the IOLM	78
9.2.2	Downloading Data Storage to the IO-Link Device	78
9.2.3	Automatic Device Configuration	79
9.2.4	Automatic Device Configuration Backup	80
9.3	Device Validation	80
9.4	Data Validation	82
9.5	IOLM Configuration Files	83
9.5.1	Saving Configuration Files (Web Interface)	83
9.5.2	Loading Configuration Files (Web Interface)	84
9.6	Configuring Miscellaneous Settings	85
9.6.1	Using the Menu Bar Hover Shows Submenu Option	86
9.6.2	Enable PDO Write From Attached Devices Port Page	86
9.6.3	IO-Link Test Event Generator	87
9.7	Clearing Settings	90
Section 10:	Using the Diagnostics Pages	91
10.1	IO-Link Port Diagnostics	91
10.2	PROFINET IO Diagnostics Page	94
10.3	Modbus/TCP Diagnostics	98
10.4	OPC UA Diagnostics Page	100
10.5	MQTT Diagnostic Page	100

Section 11: PROFINET IO Reference Information	102
11.1 Read PDI Data of IO-Link Device in PLC.....	102
11.2 Write PDO Data to IO-Link Device From PLC.....	104
11.3 Diagnostic Alarm	106
11.3.1 IO-Link Event Mapping Overview	106
11.3.2 IO-Link EventCode Mapping.....	106
Section 12: Modbus/TCP Interface.....	109
12.1 Modbus Function Codes	110
12.2 Modbus Address Definitions	110
12.2.1 Port Models.....	112
12.3 Multiple Port Process Data (PDI/PDO) Access via Modbus/TCP	113
Section 13: MQTT Interface	115
13.1 MQTT Settings Configuration Page	116
13.2 Process Data Publish Interval	117
13.3 Topics and Payloads	117
13.3.1 MqttTopicBase/clientinfo	117
13.3.2 MqttTopicBase/clientstatus	117
13.3.3 MqttTopicBase/port/n/status	118
13.3.4 MqttTopicBase/port/n/deviceinfo	119
13.3.5 MqttTopicBase/port/n/event.....	120
13.3.6 MqttTopicBase/port/n/pdi	120
13.3.7 MqttTopicBase/port/n/pdo	121
13.3.8 MqttTopicBase/port/n/auxin	121
13.3.9 ISDU Read/Write	122
13.4 ISDU Request Payload.....	122
13.5 ISDU Response Payload	123
13.6 PDO Write	124
13.7 MQTT Settings Parameters	126
13.8 Configuring MQTT	127
Section 14: Functionality Descriptions	128
14.1 Process Data Block Descriptions	128
14.1.1 Input Process Data Block Description.....	128
14.1.2 Input Process Data Block-8 Bit Data Format	129
14.1.3 Input Process Data Block-16 Bit Data Format	130
14.1.4 Input Process Data Block-32 Bit Data Format	130
14.1.5 Output Process Data Block Description.....	130
14.1.6 Output Process Data Block-8 Bit (SINT) Data Format.....	131
14.1.7 Output Process Data Block-16 Bit (INT) Data Format	131
14.1.8 Output Process Data Block-32 Bit (DINT) Data Format	132
14.2 Event Handling	133
14.2.1 Clear Event After Hold Time Process	133
14.2.2 Clear Event in PDO Block Process	134
14.2.3 Clear Event Code in PDO Block and Clear Event After Hold TimeProcess- PDO Block First	134

14.2.4 Clear Event Code in PDO Block and Clear Event After Hold Time Process- Hold Time Expires.....	135
14.3 ISDU Handling	136
14.3.1 ISDU Request/Response Structure	136
Single ISDU Command Request	136
Multiple ISDU Command Structure	137
Multiple Command ISDU Request/Response of Same Data Area Length.....	137
Standard ISDU Request Command Format	139
Integer (16-Bit Word) ISDU Request Command Format	140
ISDU Response Message Format	140
Standard ISDU Response Command Format	140
Integer (16-Bit Word) ISDU Response Command Format	141
14.3.2 ISDU Blocking and Non-Blocking Methods	142
Single Command Blocking	142
Multiple Command Blocking	143
Single Command Non-Blocking	144
Multiple Command Non-Blocking.....	145
Section 15: Troubleshooting	146
15.1 Troubleshooting.....	146
15.2 IOLM LEDs	147
15.2.1 IOLM LEDs	147
15.3 Contacting Technical Support	148
15.4 Using Log Files	149
15.4.1 View a Log File.....	149
15.4.2 Export a Log File	150
15.4.3 Clear a Log File	151
Appendix A: IO-Link Master Splitter Cables	152
A.1 Application #1: Injecting Additional/Auxiliary Input (Reference Part # V1S-T-V1)	152
A.2 Application #2: Providing Power to a Class B IO-Link Device (Reference part # V15S-YEE-V15/V15).....	154
General Contact Information	156
Technical Support.....	156

Warnings and Caution Notes as Used in this Publication

WARNING

Warning notices are used in this publication to emphasize that hazardous voltages, currents, temperatures, or other conditions that could cause personal injury exist in this equipment or may be associated with its use.

In situations where inattention could cause either personal injury or damage to equipment, a Warning notice is used.

CAUTION

Caution notices are used where equipment might be damaged if care is not taken.

Note: Notes merely call attention to information that is especially significant to understanding and operating the equipment.

These instructions do not purport to cover all details or variations in equipment, nor to provide for every possible contingency to be met during installation, operation, and maintenance. The information is supplied for informational purposes only, and Emerson makes no warranty as to the accuracy of the information included herein. Changes, modifications, and/or improvements to equipment and specifications are made periodically and these changes may or may not be reflected herein. It is understood that Emerson may make changes, modifications, or improvements to the equipment referenced herein or to the document itself at any time. This document is intended for trained personnel familiar with the Emerson products referenced herein.

Emerson may have patents or pending patent applications covering the subject matter in this document. The furnishing of this document does not provide any license whatsoever to any of these patents.

Emerson provides the following document and the information included therein as-is and without warranty of any kind, expressed or implied, including but not limited to any implied statutory warranty of merchantability or fitness for a particular purpose.

Section 1: Introduction

This document provides installation, configuration, and embedded web interface information for the Emerson IO-Link Master (IOLM). In addition, it includes detailed information about PROFINET IO (PNIO) and Modbus/TCP.

The web interface provides a platform so that you can easily configure, review diagnostic pages, and access advanced features, such as the ability to:

- Upload the latest IOLM images or applications
- Set up user accounts with different user levels and passwords
- Load IODD files and configure IO-Link device parameters
- Implement manual or automatic data storage (upload or download)
- Implement device and/or data validation

1.1.1 Revisions in this Manual

Revision	Date	Description
A	Jun 2021	Initial Release

1.2 Locating the Latest Software and Documentation

You can use the links in the following tables to locate the latest images, utilities, and documentation. For more information on using the following images, please consult Section 4: Updating the IOLM Firmware and Application Files.

OMIOLM001 (IP67 With L-Coded Power Connector) Latest Images	
U-Boot Bootloader	https://emerson-mas.force.com/communities/en-US/Article/RSTi-OM-Landing-Page
FPGA	
System ulmage (Primary/Backup)	
Application Base	

Note: The Application Base image contains all of the latest applications. If a feature enhancement or bug fix is required, the application will be available on the [Download](#) page.

Latest GSDML Files	
If you need information about installing the GSDML file, see Section 3.2, <i>Installing the GSDML File</i> .	https://emerson-mas.force.com/communities/en-US/Article/RSTi-OM-Landing-Page

1.3 IO-Link Master Description

The module is a PROFINET or Modbus/TCP Fieldbus module with 8 Class A IO-Link master ports according to IO-Link standard V1.1. The Fieldbus module serves as an interface between the PROFINET controller or Modbus TCP controller Fieldbus system and IO-Link devices at the field level. The integrated web server and IODD interpreter enabling complete configuration of the Fieldbus module and attached IO-Link devices without the need for special software tools. Information regarding the status of the module is also displayed and network parameters such as the IP address and subnet mask can be configured. The module is capable of storing all configurations enabling stand-alone usage without a higher-level PLC. MutliLink simultaneously provides data access via different communication protocols like PROFINET, Modbus/TCP, MQTT, and OPC UA to multiple controllers. An L-coded M12 connector plug used for supplying power enables a current rating of up to 2 x 16 A. The inputs and outputs are equipped with A-coded M12 connector plugs. Connection to the Fieldbus is achieved using a D-coded M12 connector plug. Status information for each channel is displayed via LEDs as a diagnostic function

1.3.1 Features

The IOLM's web interface provides a platform so that you can easily configure, review diagnostic pages, and access advanced features, such as the ability to:

- Setup Passwords for pre-defined user accounts
- Utilize data storage to provide automatic and manual data storage to upload or download IO-Link v1.1 device parameters
- Run device validation to support identical or compatible device validation to dedicate a port or ports to specific IO-Link devices
- Run data validation to support strict or loose data validation to verify data integrity
- Back up configuration files or load the same configuration to multiple IOLM units
- Generate diagnostics data to support maintenance

1.3.2 Front Panel Description

Figure 1: Front Panel and Indicators

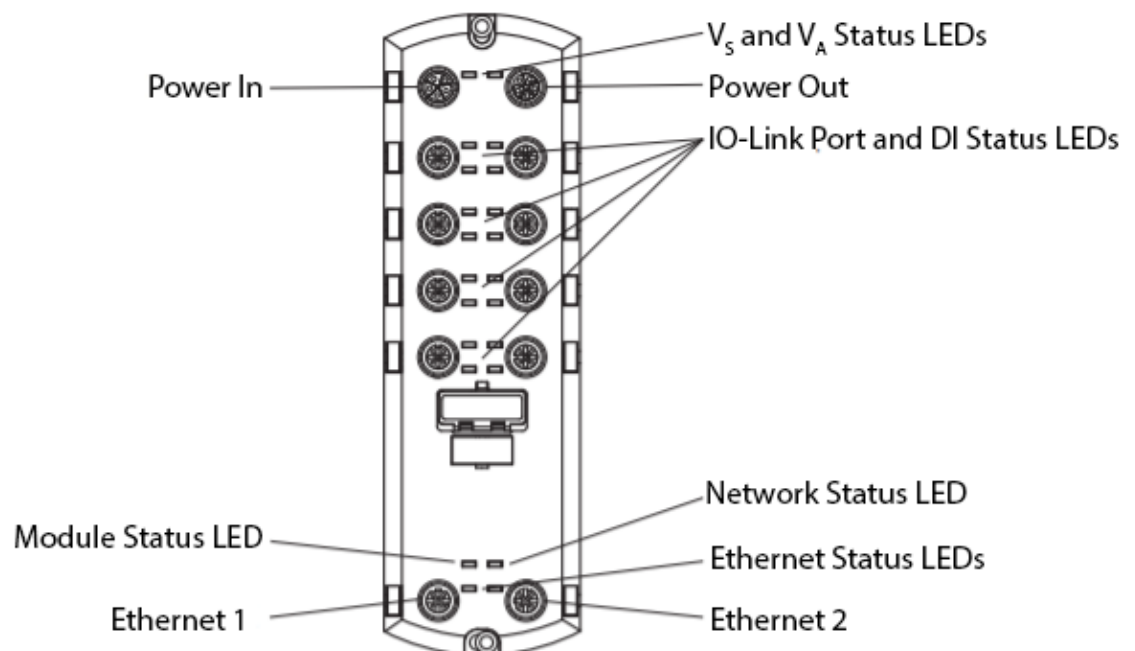

1.3.3 Connectors Overview

Figure 2: Front Panel Connectors

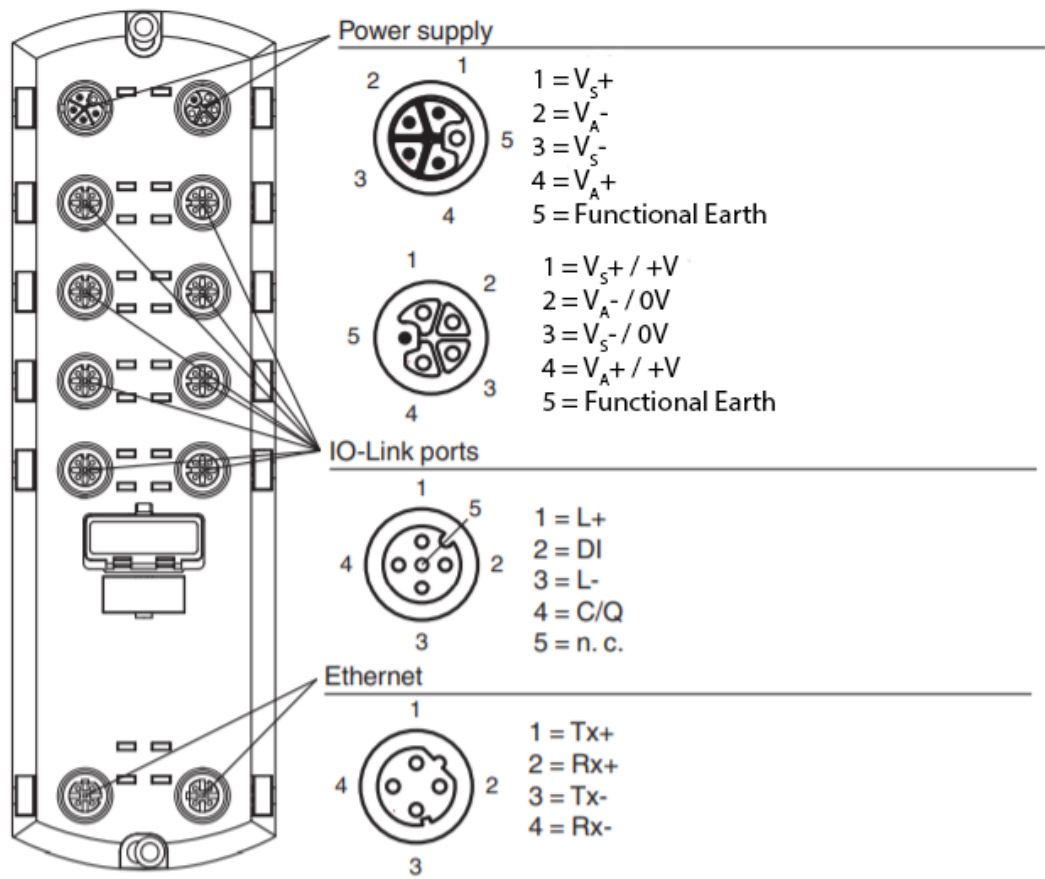

1.3.4 Specifications

General specifications	
UL File Number	E105285
Indicators/operating means	
LED indication	see manual
Rotary switch	Setting the IP address and resetting to factory defaults
Electrical specifications	
Rated operating voltage	20 ... 30 V
Nominal voltage	24 V DC
Current consumption	typ. 120 mA
Current loading capacity	Max. 2 x 16 A per module (Loop-through current via L-coded power supply) Total current: max. 6.7 A per module
Galvanic isolation	between V_S and V_A
Interface	
Interface type	Industrial Ethernet
Physical	M12, D-coded
Protocol	PROFINET IO with media redundancy protocol (MRP), Modbus/TCP, OPC UA, MQTT
Transfer rate	10/100 Mbps
Inputs/Outputs	
Number/Type	8 x IO-Link Class A (X1 – X4) Configurable as: max. 8 IO-Link and 8 digital inputs max. 16 digital inputs max. 8 digital inputs and 8 digital outputs short-circuit protected
Sensor supply	Port 1: max. 1.6 A via L+ (pin 1) Port 3: max. 1 A via L+ (pin 1) Ports 2 and 4 to 8: max. 500 mA per port via L+ (pin 1)
Output rated operating current	max. 200 mA per port via C/Q (pin 4)
Directive conformity	
Electromagnetic compatibility	
Directive 2014/30/EU	EN 61000-6-2, EN 61000-6-4
Standard conformity	
Degree of protection	EN 60529
Fieldbus standard	Type 1 according to IEC 61131-2, EN 61131-9
Electrical Safety	CSA C22.2 No. 61010-1-12, UL 61010-1, IEC 61010-2-201
Emitted interference	EN 61000-6-4, FCC part 15 subpart B, ICES-001, AS/NZS CISPR 11
Noise immunity	EN 61000-6-2, EN 61131-2, EN 61131-9
Shock resistance	EN 60068-2-27
Ambient conditions	
Ambient temperature	-25 ... 60 °C (-13 ... 140 °F)
Storage temperature	-40 ... 85 °C (-40 ... 185 °F)
Relative humidity	max. 95 %
Altitude	0 ... 2000 m
Shock and impact resistance	15 g, 11 ms, half-sine
Mechanical specifications	
Degree of protection	IP67
Connection	Power Supply M12, L-coded Fieldbus M12, D-coded Inputs/Outputs M12, A-coded
Material	
Housing	Molded Polyamide 66
Mass	454 g
Tightening torque, fastening screws	8 Nm
Tightening torque, cable gland	max. 0.5 Nm
Construction type	Field housing
Tightening torque of mounting screws	8 Nm

Section 2: Hardware Installation

Note: Refer to Section 5: Connecting Devices for information about connecting IO-Link or digital devices to the ports after you program the network information using the next section.

2.1 IOLM Hardware Installation

Use the following subsections to install the hardware and verify operation.

- Setting the Rotary Switch (Section 2.1.1)
- Connecting to the Network (Section 2.1.2)
- Connecting the Power (Section 2.1.3)
- Mounting the IOLM (Section 2.1.4)

Note: Refer to Section 5.2 *IOLM IO-Link Ports* for information about connecting IO-Link or digital devices to the ports after you program the network information using the next section.

2.1.1 Setting the Rotary Switch

You can use the rotary switches under the configuration window on the IOLM to set the lower 3-digits (8 bits) of the static IP address (192.168.11.XXX).

For example, the **default IP address is 192.168.11.202**. When the rotary switches are set to 000, the final segment of the IP address will remain at 250. However, if the rotary switches are changed to 022, then the IOLM module will obtain the IP address 192.168.11.22

If the rotary switches are set to a non-default position, the upper 9-digits (24 bits) of the IP address are then taken from the static network address. The switches only take effect during startup, but the current position is always shown on the **Help | SUPPORT** page.

Using the rotary switches to set the IP address may be useful in the following situations:

- A permanent method to assign IP addresses while setting machines for a special application where a PC or laptop is not available.
- A temporary method to assign IP addresses to several IOLMs so that they do not have duplicate addresses, making IP address configuration easier when using the web page. After using the web page to change the IP address, reset the rotary switches back to 000.
- An emergency method to reset the IOLM to factory defaults, so that software can be used to program the appropriate IP address, and then reset the switches to 000.

Note: If you set the network address using the rotary switches, the rotary switch setting overrides the network settings in the web interface when the IOLM is initially powered on or after cycling the power.

Note: The default subnet mask is **255.255.255.0**

Changing the Default Rotary Switch Settings

Use the following steps if you want to change the default rotary switch settings.

1. With a small flathead screwdriver, gently pop open the configuration window.
2. Gently swing open the switch window from the top to the bottom, allowing it to pivot on the hinge on the bottom of the window.

- Turn each dial to the appropriate position using a small flathead screwdriver.

Figure 3: Rotary Switches



Note: The default setting is 000 as shown above.

- The arrow points to switch location 0 is located at the 9:00 position. Turn the dial clockwise to the appropriate setting.
- Close the window and make sure that it snaps shut tightly.

Note: Failure to close the configuration window properly may compromise IP67 integrity.

Switch Setting	Node Address
000 (Default setting)	Use the network configuration stored in the flash. The default network configuration values are: IP address = 192.168.11.202 Subnet mask = 255.255.255.0 IP gateway = 0.0.0.0 After completing the hardware installation, see Section 3: <i>Configuring the IOLM with PAC Machine Edition</i> to set the network address using the web interface.
001-254	This is the last three digits in the IP address. This uses the first three numbers from the configured static address, which defaults to 192.168.11.xxx. <i>Note: If the software is used to change the IP address to another range before setting the rotary switches, the IOLM uses that IP address range. For example, if the IOLM is set to 10.0.0.250 and the first rotary switch is set to 2, the IP address would be 10.0.0.200.</i>
255-887	Reserved.
888	Reset to factory defaults. If the IOLM is set to 888 and the IP address is changed using other methods, the IP address is returned to the default IP address if the IOLM is rebooted or power cycled.
889-997	Use the network configuration values stored in the flash (reserved).
998	Setting the rotary switches to 998 configures the IOLM to use DHCP addressing.
999	Use the default IP address. If the IOLM is set to 999 and the IP address is changed using other methods, the IP address is returned to the default IP address if the IOLM is rebooted or power cycled.

2.1.2 Connecting to the Network

The IOLM provides two Fast Ethernet (10/100BASE-TX) M12, 4-pin female D-coded connectors.

Figure 4: IOLM Fast Ethernet Connectors Pinout

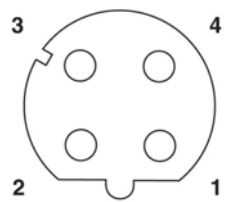

Pin	Signal
1	Tx+
2	Rx+
3	Tx-
4	Rx-

You can use this procedure to connect the IOLM to the network.

1. Securely connect one end of a shielded twisted-pair (Cat 5 or higher) M12 Ethernet cable to either Ethernet port.
2. Connect the other end of the cable to the network.
3. Optionally, use the other Ethernet port to daisy-chain to another Ethernet device.
4. If you did not connect both Ethernet ports, make sure that the unused port is covered with a connector cap to keep dust and liquids from getting in the connector.

Note: Ethernet ports must have an approved cable or protective cover attached to the connector to guarantee IP67 integrity.

2.1.3 Connecting the Power

The IOLM provides M12 (5-poles) L-coded input and output power connectors. Use a 24VDC power supply capable of the total output current required.

Note: Power connectors must have an approved cable or protective cover attached to the port guarantee to IP67 compliance. If you require cables or protective covers, see the Emerson website.

Figure 5: IOLM Power Connectors Pinout

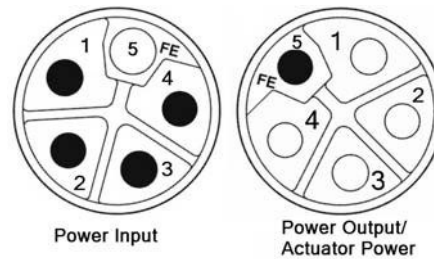

Pin	Power Input (Male)	Power Output or Actuator Power (Female)	Description
1	V_S^+	V_S^+ or +V	IO-Link Master's system electronics and IO-Link devices
2	V_A^-	V_A^- or 0V	Actuator supply
3	V_S^-	V_S^- or 0V	IO-Link Master's system electronics and IO-Link devices
4	V_A^+	V_A^+ or +V	Actuator supply
5	FE		

Note: The IOLM requires a UL-listed power supply with an output rating of 24VDC.

Power Supply	Values
Power Supply In - Maximum V_S and V_A	16A (Maximum)
IO-Link Connector <i>Port 1</i> C/Q (Pin 4) L+/L- Sensor Supply (Pins 1 and 3)	200 mA (Maximum) 1.6 A (Maximum)
IO-Link Connector <i>Port 3</i> C/Q (Pin 4) L+/L- Sensor Supply (Pins 1 and 3)	200 mA (Maximum) 1 A (Maximum)
IO-Link Connectors Ports 2 and 4 - 8 C/Q (Pin 4) L+/L- Sensor Supply (Pins 1 and 3)	200 mA (Maximum) 500 mA (Maximum)/up to 1A Output Budget Note: See <i>IOLM Hardware Installation</i> for information about how to divide up the power output between ports.
IOLM Power	100 mA @ 24 VDC (U_S)
Power Supply Out V_S V_A	16A † (Maximum) 16A †† (Maximum)
† V_S output available is determined by subtracting the following from the available input current. IO-Link Master module electronics current. Total L+/L- current for all IO-Link ports. Total C/Q current for all IO-Link ports. †† V_A output available is the same as the available U_A input current.	

You can use the following procedure to connect the IOLM to a power supply.

Note: Power should be disconnected from the power supply before connecting it to the IOLM. Otherwise, your screwdriver blade can inadvertently short your power supply terminal connections to the grounded enclosure.

1. Securely attach the power cable between the male power connector (**PWR In**) and the power supply.
2. Either attach a power cable between the female power connector and another device to which you want to provide power or securely attach a connector cap to prevent dust or liquids from getting into the connector. Contact your Customer Sales Representative if you need to order connector caps for the IOLM.
3. Apply the power and verify that the following LEDs are lit indicating that you are ready to attach your IO-Link or digital I/O devices.
 - a. The **V_S** LED lights.
 - b. The **ETH1/ETH2** LED lights on the connected port.
 - c. The **MOD** and **NET** LEDs are lit.
 - d. The IO-Link LEDs  flash (if no IO-Link device attached) or are lit if an IO-Link device is attached.

Note: It takes approximately 25 seconds after power-up for the IO-Link Master to be ready for operation.

If a PLC is connected, the **NET** LED is lit and green.

If the LEDs indicate that you are ready to go to the next installation step:

- Program the IP address using a web interface. Refer to 3.4, *IP Address Assignment*.
- If using the rotary switches to set the IP address, then you are ready to attach devices using Section 5: *Connecting Devices*.

2.1.4 Mounting the IOLM

Use the following procedure to mount the IOLM. You can mount the IOLM on a mounting panel or a machine.

1. Verify that the mounting surface is level (flat) to prevent mechanical stress to the IOLM.
2. Attach the IOLM to the surface with two 6 mm screws and washers, torque down to 8 Nm.

Figure 6: Mounting the IOLM 8 PNIO L

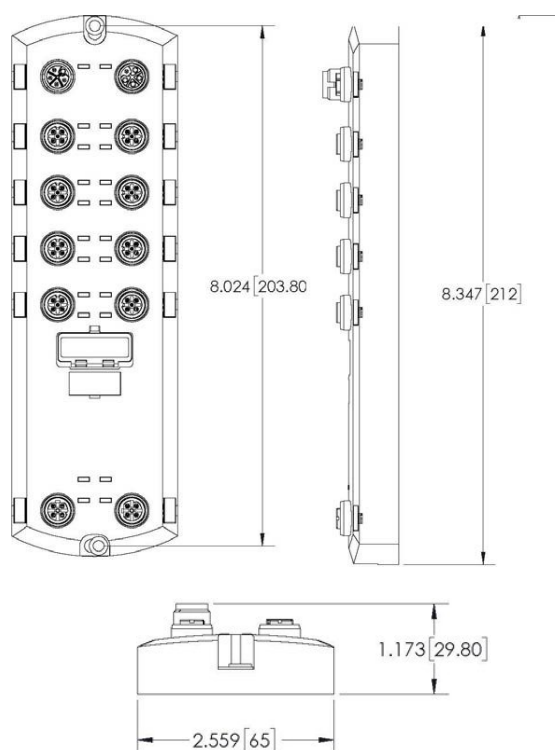

Section 3: Configuring the IOLM with PAC Machine Edition

3.1 Overview

PROFINET IO configuration procedures vary between software versions but the following configuration steps are required in all cases. Refer to your PAC Machine Edition documentation if you require step-by-step procedures.

1. Download, unzip, and upload the GSD file for the IO-Link Master (IOLM) (Section 3.2)
2. Insert the IOLM in the PROFINET IO system (Section 3.3)
3. Configure the IP address for the IOLM (Section 3.4)
4. Assign the PROFINET Device Name (Section 3.5)
5. Set the IO Device Update Time (Section 3.6)
6. Configure the IO-Link port (Section 3.7)
 - a. Configure IO-Link port modules.
 - b. Configure port status modules.
 - c. If desired, configure data storage, automatic or manual - upload or download.
 - d. If desired, configure device validation and data validation.
7. Configure EPXPNS001/EPXPNS101 modules. (See Section 8.2 in GFK-2958, PACSystems RSTi-EP User Manual.) (If desired or required.)
8. Use Section 11: Modbus/TCP Interface to complete configuration after attaching the IO-Link devices.

3.2 Installing the GSDML File

Use the following procedure to install the GSDML file for PROFINET IO.

Note: GSDML files are available at Emerson’s support site. Please see the links provided at the end of this document.

1. Launch PAC Machine Edition.
2. From the Navigator right-click on the PROFINET or PNC in the Hardware Configuration of the controller section and select **Add IO-Device** (Figure 7).

Figure 7: Installing the GSDML File

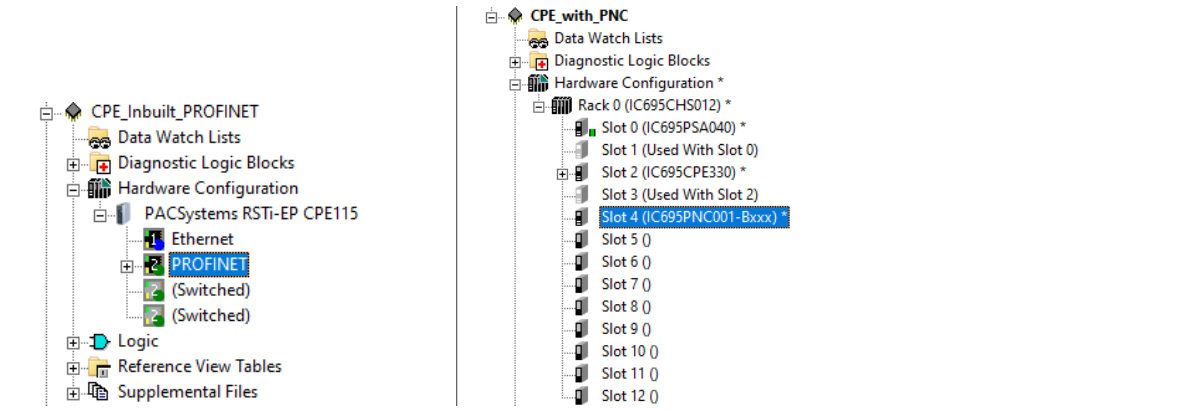

The PROFINET Device Catalog displays, select **Have GSDML** from the dialogue box. (Figure 8)

Figure 8: PROFINET Device Catalog

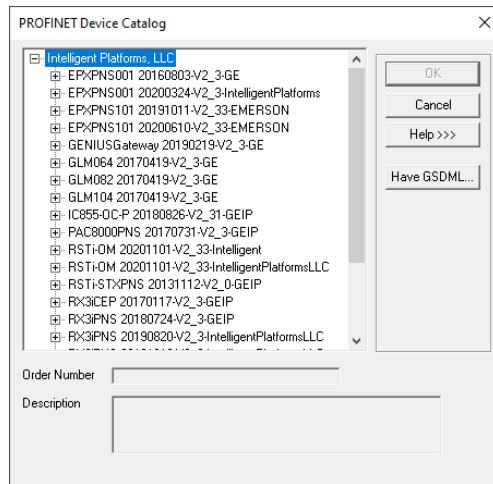

Navigate to the folder where the GSDML for IOLM is located, select the **GSDML-xxxx.zip** and click on **Open**.

The GSDML file for RSTi-OM IOLM would then be successfully added to the PROFINET Device Catalog.

3.3 Configuring the IOLM

To add the IOLM to the controller, select the appropriate device from the catalog, and click OK (Figure 9).

Figure 9: Adding the IOLM to the Controller

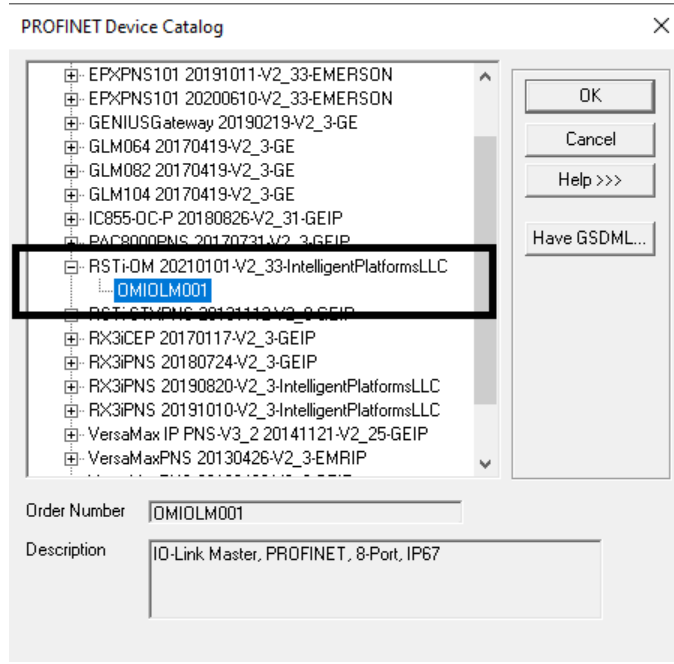

The PROFINET device will then added under the PROFINET controller or PROFINET section of the CPE as shown in Figure 10.

Figure 10: Locate the PROFINET Device

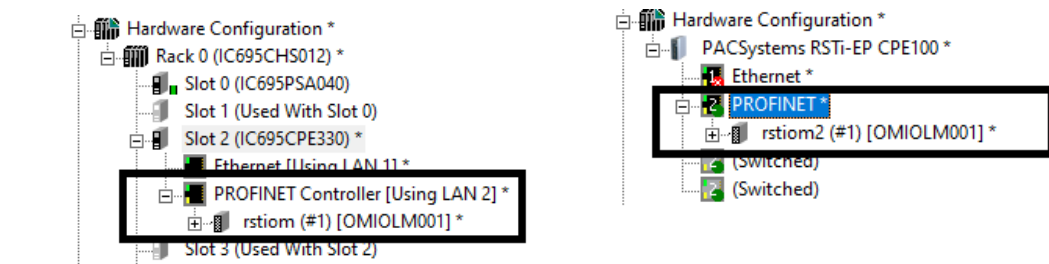

3.4 IP Address Assignment

RSTi-OM IOLM gateways support three methods for IP address assignment according to *GSDML Specification*.

- **DCP** - The IOLM supports IP address assignment via Discovery and basic Configuration Protocol (DCP). See 3.4.1 Assigning an IP Address via IO Controller (DCP) for procedures.
- **DHCP** - The IOLM supports the Dynamic Host Configuration Protocol for IP address assignment. See 3.4.2, Assigning an IP Address via DHCP for procedures.
- **LOCAL** - The IOLM supports a device-specific method for IP address assignment. See Section *Assign IP Address Statically Using the Web Page*.

3.4.1 Assigning an IP Address via IO Controller (DCP)

A PROFINET IO controller can assign an IP address to the IOLM gateway via DCP. The IO controller and the Emerson IOLM gateway have to be on the same subnet. The IOLM default IP address is: 192.168.11.202 and the subnet mask is 255.255.255.0.

To assign IP address/device name from the DCP tool, navigate to **Utilities** menu item in PAC Machine Edition and select **PROFINET DCP**

Figure 11: PROFINET DCP Utility

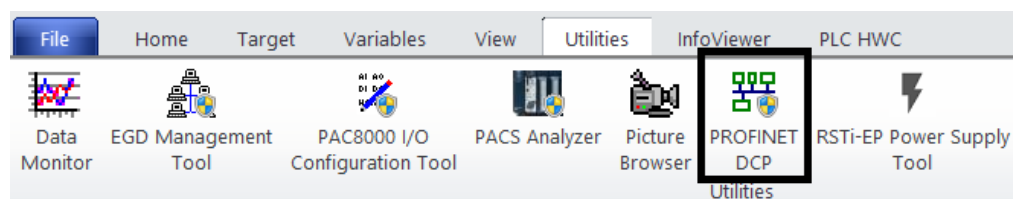

The **PROFINET DCP dialogue** will pop up. Select the appropriate connection to which the PROFINET controller and IO device are connected. Click on **Refresh Device List** to list all PROFINET controllers and IO devices connected.

Figure 12: PROFINET Connection

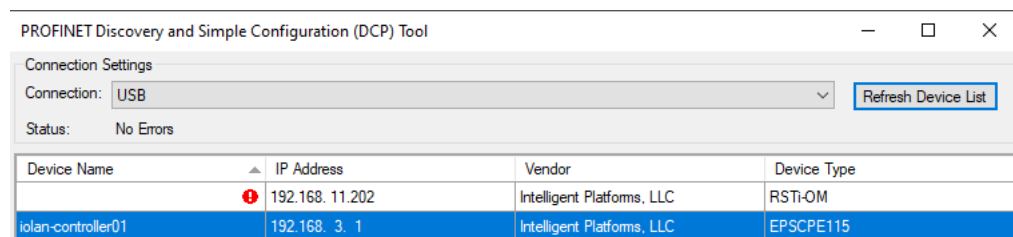

Any unconfigured device will be indicated by the blank **Device Name** field. Click on the device to which the device name or IP address is to be assigned.

Figure 13: RSTi-OM

RSTi-OM Properties

Vendor Name: Intelligent Platforms, LLC Vendor ID: 015A
MAC Address: 00-09-91-AE-9A-55 Device ID: 101A Identify Device
Device Type: RSTi-OM Device Role: Device

Device Name
[Input Field] Set Device Name

IP Address
IP Address: 192.168.11.202
Subnet Mask: 255.255.255.0 Set IP Information
Gateway: 0.0.0.0

Reset device to factory settings
Reset Device

[Empty List Box]

Exit

Configure the **Device Name** or **IP Address** as desired, the configured Device Name or the IP address should be matching with what had been configured in the PROFINET controller to successfully establish the communication with the controller.

The subnet mask and gateway need to be configured to be within the subnet as the PROFINET controller.

⚠ CAUTION

Check Firewall Settings

Please check the firewall setting if there are no devices listed when using PROFINET DCP. The DCP port should be enabled/whitelisted in the firewall settings for listing the devices when scanned.

3.4.2 Assigning an IP Address via DHCP

The IOLM gateway supports DHCP for IP address assignment. DHCP is disabled by default. Use the following steps to enable DHCP.

Note: The IOLM default IP address is: 192.168.11.202 and the subnet mask is 255.255.255.0. You may need to change your laptop or PC IP address range to access the IOLM web interface.

1. Open a web browser and enter the IOLM IP address.
2. Click **Configuration | Network**.
3. Click the **EDIT** button.

Figure 14: Web Network Configuration Page

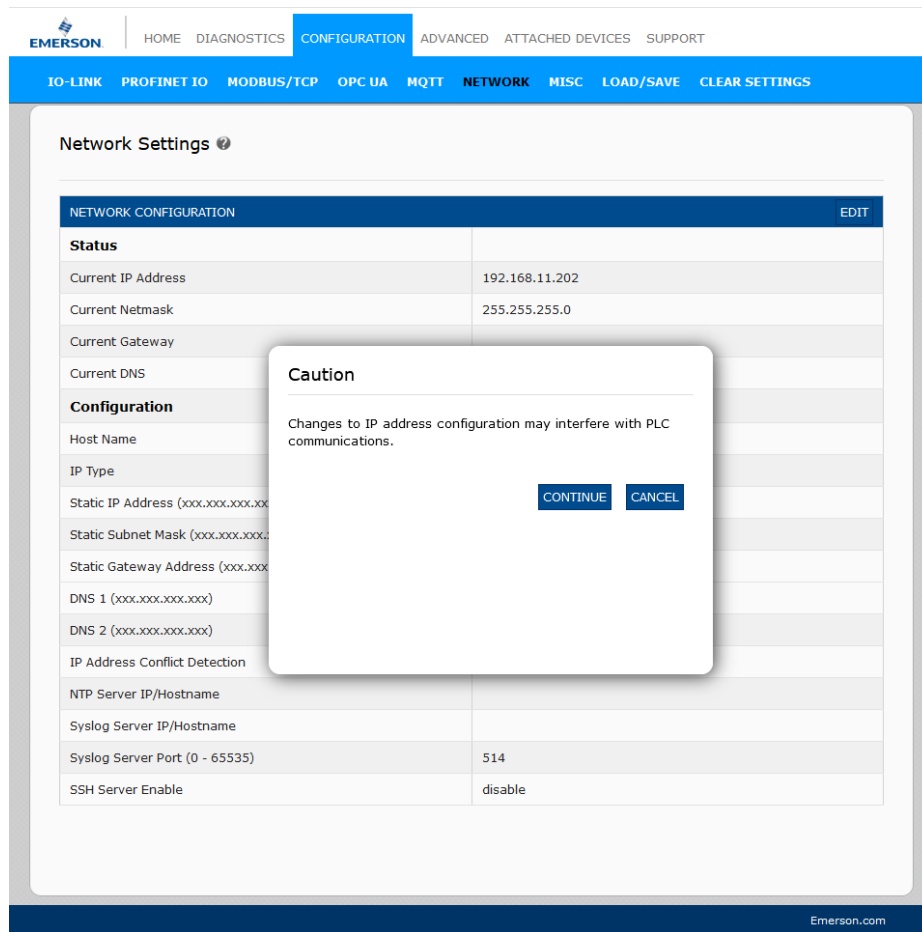

4. Change IP Type from **static** to **DHCP**.

Figure 15: Select IP Type

The screenshot shows the 'Network Settings' page with the following configuration details:

NETWORK CONFIGURATION		CANCEL	SAVE
Status			
Current IP Address	192.168.11.202		
Current Netmask	255.255.255.0		
Current Gateway			
Current DNS			
Configuration			
Host Name	<input type="text"/>		
IP Type	static		
Static IP Address (xxx.xxx.xxx.xxx)	dhcp 1.202		
Static Subnet Mask (xxx.xxx.xxx.xxx)	255.255.255.0		
Static Gateway Address (xxx.xxx.xxx.xxx)	0.0.0.0		
DNS 1 (xxx.xxx.xxx.xxx)	<input type="text"/>		
DNS 2 (xxx.xxx.xxx.xxx)	<input type="text"/>		
IP Address Conflict Detection	enable		
NTP Server IP/Hostname	<input type="text"/>		
Syslog Server IP/Hostname	<input type="text"/>		
Syslog Server Port (0 - 65535)	514		

5. Click the **SAVE** button.

Once DHCP is enabled, the IOLM attempts to obtain an IP address from a DHCP server. If a new IP address is assigned by a DHCP server, then the IOLM switches to the new IP address immediately. This may interfere with communications between the device and the IO controller.

The next configuration step is to assign the device name, go to Section 3.5, *Device Name Assignment*.

Assign IP Address Statically Using the Web Page

You can use the following procedure to configure a static IP address. The IOLM web interface switches to the new IP address immediately.

Note: The IOLM default IP address is: 192.168.11.202 and the subnet mask is 255.255.255.0. You may need to change your laptop or PC IP address range to access the IOLM web interface.

1. Open a web browser and enter the IOLM IP address.
2. Click Configuration | Network.
3. Click the **EDIT** button.
4. If necessary, change the **IP Type** to **static**.
5. Enter an IP address, subnet mask, and gateway address.

Figure 16: Enter IP Address

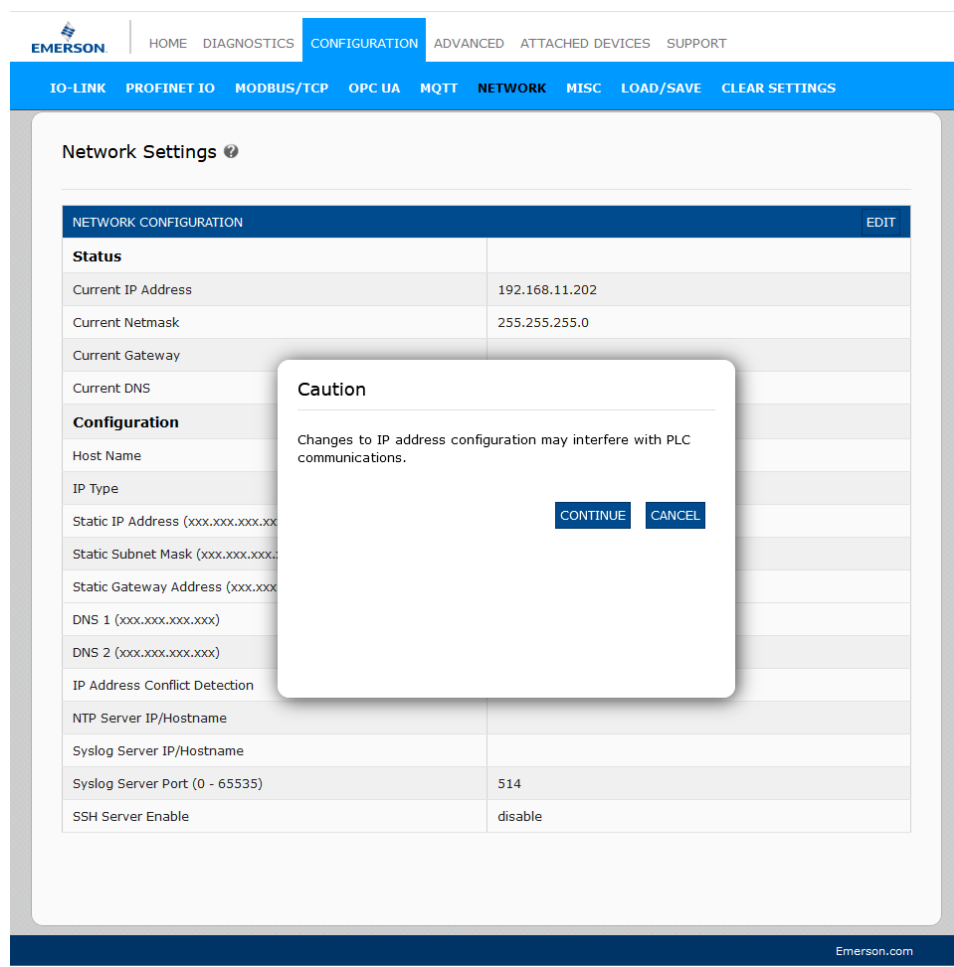

6. If applicable, enter the DNS1 and DNS2 addresses.

Figure 17: Enter the DNS1 and DNS2 Addresses

NETWORK CONFIGURATION		CANCEL	SAVE
Status			
Current IP Address	192.168.11.202		
Current Netmask	255.255.255.0		
Current Gateway			
Current DNS			
Configuration			
Host Name	<input type="text"/>		
IP Type	static		
Static IP Address (xxx.xxx.xxx.xxx)	192.168.11.202		
Static Subnet Mask (xxx.xxx.xxx.xxx)	255.255.255.0		
Static Gateway Address (xxx.xxx.xxx.xxx)	0.0.0.0		
DNS 1 (xxx.xxx.xxx.xxx)	<input type="text"/>		
DNS 2 (xxx.xxx.xxx.xxx)	<input type="text"/>		
IP Address Conflict Detection	enable		
NTP Server IP/Hostname	<input type="text"/>		
Syslog Server IP/Hostname	<input type="text"/>		
Syslog Server Port (0 - 65535)	514		

7. Click the **SAVE** button.

The next configuration step is to assign the device name, go to.

3.5 Device Name Assignment

Use one of the following methods to configure the Device Name.

- PAC Machine Edition & DCP tool
- Web interface - see Section 3.5.2, *Using the Web Interface to Assign the Device Name* for information about using the IOLM **Configuration | PROFINET IO** page.

3.5.1 Assign the Device Name in PAC Machine Edition

Use the DCP tool as mentioned in section 3.4.1 and assign the device name. The device name should match with the Hardware Configuration for successful communication with the controller.

Example: The configured name in the DCP tool is **rstiom-node1** (Figure 18).

Figure 18: Device Name

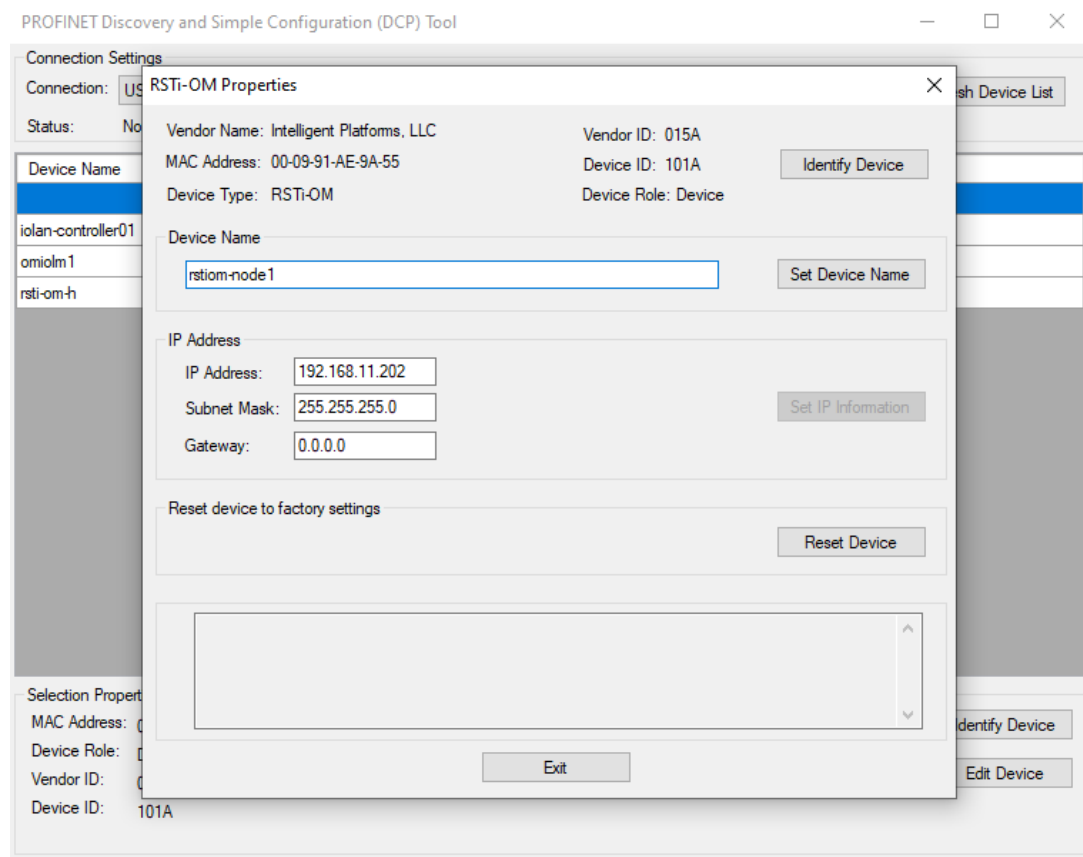

The configuration in the PROFINET controller in **Hardware Configuration** (Figure 19).

Figure 19: Device Name in HWC

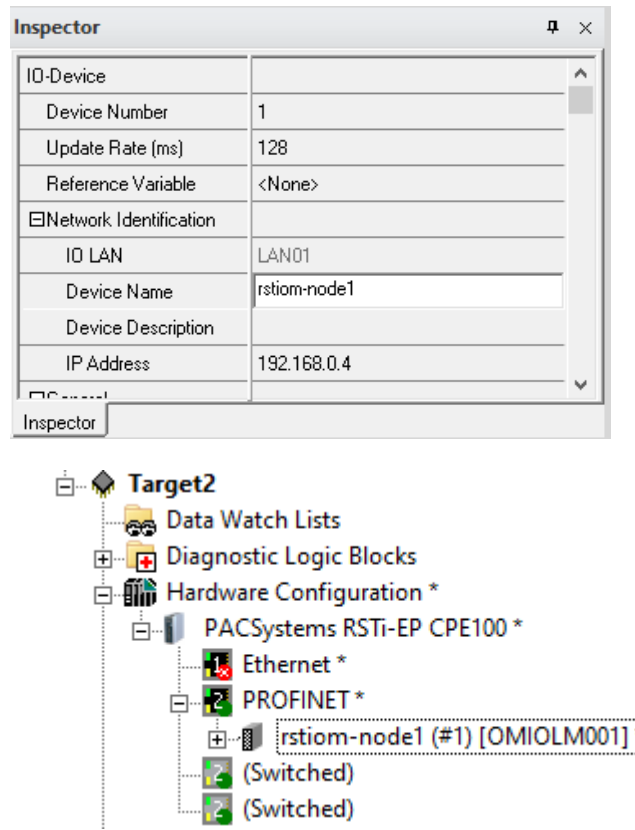

3.5.2 Using the Web Interface to Assign the Device Name

You can use the **Configuration | Profinet IO Settings** page to assign the device name for PROFINET IO with the IO-Link Master.

Note: Changes to the device name using the web interface takes effect immediately. It may interfere with the communication between the device and the IO controller.

1. If necessary, open the IOLM web interface with your web browser using the IP address.
2. Click Configuration | PROFINET IO Settings.
3. Click the **EDIT** button.
4. Enter the PROFINET IO Device Name.

The **PROFINET IO Device Name** is the same as the name later used to configure PROFINET IO for the IOLM. The **PROFINET IO Device Name** is not case-sensitive.

Figure 20: PROFINET IO Settings

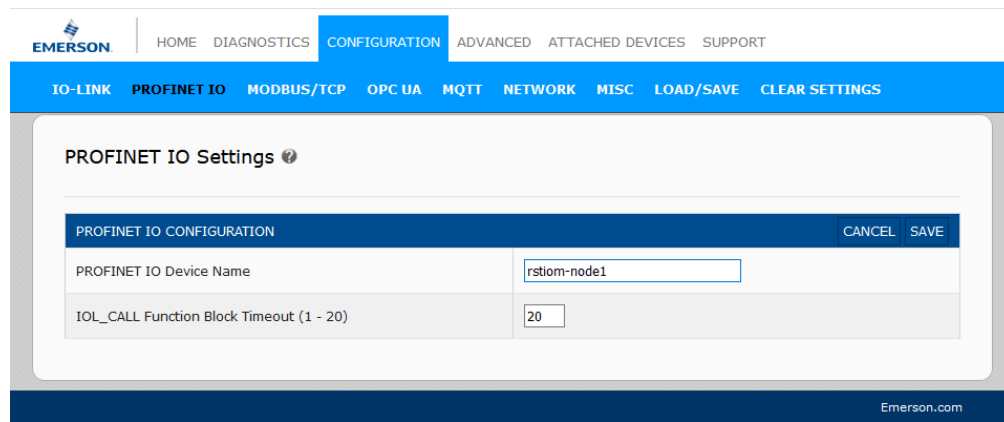

5. Click **SAVE**.

Parameter	Description
PROFINET IO Device Name (Default: empty)	<p>The device name must be specified according to DNS conventions.</p> <p>Restricted to a total of 240 characters (letters, digits, dash, or period)</p> <p>Parts of the name within the device name; in other words, a string between two periods, must not exceed a maximum of 63 characters.</p> <p>No special characters such as umlauts (ä, ö, etc.), brackets, underscore, slash, blank, etc. The dash is the only permitted special character.</p> <p>The device name must not begin or end with the "-" character.</p> <p>The device name must not begin with numbers.</p> <p>The device name must not have the structure n.n.n.n (n = 0...999).</p> <p>The device name must not begin with the character string "port-xyz-" (x, y, z = 0...9).</p>
IOL_CALL Function Block Timeout (1-20) (Default: 20)	<p>The timeout value in seconds for the IOL_CALL function block when used with controller supporting IOL_CALL Function block.</p>

3.6 Setting the IO Device Update Time

The PROFINET device **Update Rate** can be set in the Inspector window of the PAC Machine Edition. The unit of update rate is in milli-seconds. The allowable rates are 8, 16, 32, 64, 128, 256, and 512.

The default update rate is 128ms

Figure 21: IO Device Update Time

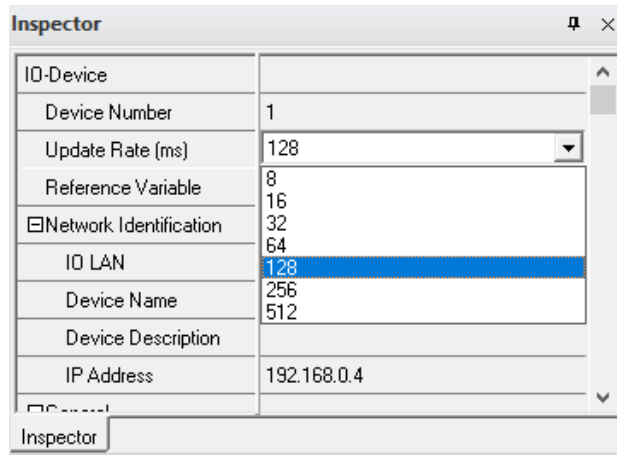

3.7 Configuring IO-Link Ports

The IO-Link Master gateway has two categories of IO modules:

- IO-Link Port Modules (Section 3.7.1)
- Port Status Modules (Section 3.7.2)
- Configuring IO-Link Ports with the Web Interface (Section 3.7.3)

To access the modules to be configured under the IO-Link master, right-click on the IOLM module in the Hardware configuration and select **Change Module List**.

Figure 22: Change Module

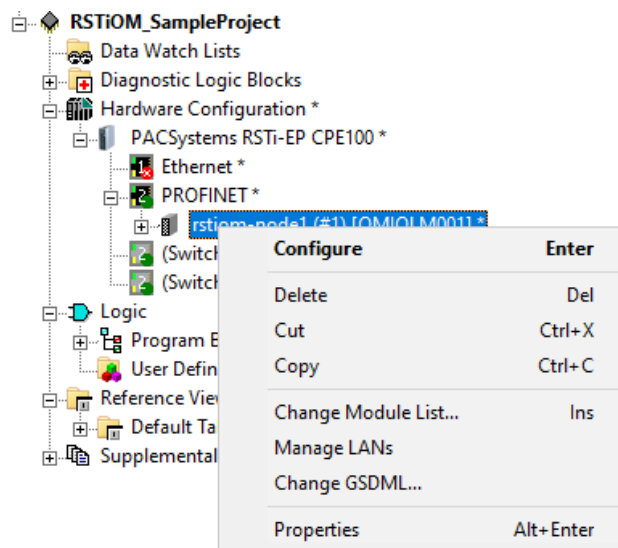

The list of modules are as listed below

Figure 23: Configuring IO-Link Ports

Change Module List - rstiom-node1 (#1) [OMIOLM001] *

New modules can be added by dragging a module from the list of available modules on the right to an empty row.
 Modules can be moved by dragging them to an empty row.
 Modules can be copied by dragging them to an empty row while holding the Ctrl key down.

Location	Content	Status
0	OMIOLM001	Fixed
1		
2		
3		
4		
5		
6		
7		
8		
9		
10		

- [-] IO-Link Port
 - ... IO-Link Reset
 - ... SIO Digital In
 - ... SIO Digital Out
 - ... IO-Link In 1 byte
 - ... IO-Link In 2 bytes
 - ... IO-Link In 3 bytes
 - ... IO-Link In 4 bytes
 - ... IO-Link In 8 bytes
 - ... IO-Link In 16 bytes
 - ... IO-Link In 32 bytes
 - ... IO-Link Out 1 byte
 - ... IO-Link Out 2 bytes
 - ... IO-Link Out 3 bytes
 - ... IO-Link Out 4 bytes
 - ... IO-Link Out 8 bytes
 - ... IO-Link Out 16 bytes
 - ... IO-Link Out 32 bytes
 - ... IO-Link In/Out 1 byte
 - ... IO-Link In/Out 2 bytes
 - ... IO-Link In/Out 3 bytes
 - ... IO-Link In/Out 4 bytes
 - ... IO-Link In/Out 8 bytes
 - ... IO-Link In/Out 16 bytes
 - ... IO-Link In/Out 32 bytes
- [-] Port Status
 - ... IO-Link Status

IO modules are used to configure IO-Link ports and exchange PDI and PDO data with various IO-Link devices and digital I/O devices.

3.7.1 IO-Link Port Modules

An IO-Link port can be configured as one of the following:

- IO-Link Mode
- SIO Digital In Mode
- SIO Digital Out Mode.

IO-Link Port modules are used to configure the mode of an IO-Link port.

All the IO-Link modules start with the **IO-Link** (that is: IO-Link In, IO-Link Out and IO-Link In/Out) configure the corresponding IO-Link port as IO-Link Mode. An SIO Digital In module configures the IO-Link port as SIO Digital In Mode. Similarly, an SIO Digital Out module configures the port as SIO Digital Out Mode.

- An **IO-Link module** can be input only, output only, or both. In addition, there are different modules with various IO data sizes (1 to 32 bytes). For example, the IO-Link In/Out 4 bytes module is for an IO-Link device that supports up to 4-byte PDI data and 4-byte PDO data. If you do not find an exact matching IO size, select the next size (larger). For instance, use IO-Link is a 16-bytes module for an IO-Link device that has 10-byte PDI data. The unused PDI data is filled with zeros.
- For **SIO Digital In the module**, the PDI data is fixed at 1-byte. A high voltage on the IO-Link port C/Q Pin results in a 0x01 PDI data; a low voltage on the C/Q Pin results in a 0x00 PDI data.
- For the **SIO Digital Out module**, the PDO data is fixed at 1-byte. A zero output value from an SIO Digital Out module sets the IO-Link port C/Q pin to low voltage. Any non-zero output value sets the C/Q pin to high voltage.

IO-Link Port Module Input Data Format	
Byte Offset	Description
0	PDI Data Block byte 0
1	PDI Data Block byte 1
...	...
31	PDI Data Block byte 31

IO-Link Port Module Output Data Format	
Byte Offset	Description
0	PDO Data Block byte 0
1	PDO Data Block byte 1
...	...
31	PDO Data Block bytes 31

IO-Link Port modules are allowed in Slots 1 to 8 on the IOLM. Slot 1 is corresponding to IO-Link Port 1. Slot 2 is for IO-Link Port 2, so on and so forth. If a slot is unpopulated, the corresponding IO-Link port is not configured. That port uses the previously configured settings, or default settings if it has not been configured before.

IO-Link Port Settings (IO-Link Port Module Parameters)

Additional IO-Link port settings can be configured by using module parameters.

IO-Link Port Module Parameters	
<i>IO-Link Port Config</i>	
Minimum Cycle Time (Default: 4) Valid range: 4-538ms	The minimum or fastest cycle time at which the IO-Link device may operate. You can leave the Minimum Cycle Time set to the default value and the IO-Link Master negotiates with the IO-Link device for its minimum cycle time. The <i>IO-Link Diagnostics</i> page displays the Actual Cycle Time, which is the negotiated cycle time.
<i>Data Storage Config</i>	
Automatic Data Storage Upload Enable <i>Default: Off</i>	When this option is initially set to On, the IOLM saves the data storage (if the data storage is empty) from the IO-Link device to that port. Some IO-Link devices update the data storage contents if you use the Teach buttons on the IO-Link device, but that is determined by the IO-Link device manufacturer. Automatic upload occurs when the Automatic Upload Enable option is set to On and one of these conditions exists: There is no upload data stored on the gateway. The IO-Link device executes a request_ at the upload function (generally because you have changed the configuration via Teach buttons). Do not enable both Automatic Upload and Automatic Download at the same time, the results are not reliable among IO-Link device manufacturers. When a port contains data storage for an IO-Link device and if you attach a device whose Vendor and Device ID do not match, the IO-Link LED on the IOLM flashes red to indicate a wrong device is attached. In addition, the IO-Link Diagnostics page displays DV: Wrong Sensor in the IO-Link State field. You should not enable Automatic Upload until after you have configured the IO-Link device attached to the port unless you want to capture the default settings. Refer to 10.2. Data Storage on Page 136 for more information.

<p>Automatic Data Storage Download Enable <i>Default: Off</i></p>	<p>The data stored on the IOLM port is downloaded to the IO-Link device if: This option is selected. The data stored on the IOLM port contains the same Vendor ID and ProductID as the IO-Link device connected to the port. The data stored on the IOLM port is different than that of the IO-Link device. The IO-Link device requests an upload and the Automatic Upload Enable option is set to Off. If you change configuration parameters on the IO-Link device and want the parameters to remain loaded on the IO-Link device, you must disable the Automatic Download option because otherwise, the IOLM will reload the data storage on the port down to the IO-Link device. Do not enable both Automatic Upload and Automatic Download at the same time, the results are not reliable among IO-Link device manufacturers.</p>
<p><i>Validation Config</i></p>	
<p>Device Validation Mode (Default: None)</p>	<p>Device Validation Mode provides these options: None - this disables Device Validation Mode. Compatible - permits a compatible IO-Link device (same Vendor ID and Device ID) to function on the corresponding port. Identical - only permits an IO-Link device to function on the corresponding port as defined in the following fields. Vendor ID Device ID - Serial Number</p>
<p>Vendor Id (0-65535)</p>	<p>This is required if you select a Device Validation Mode other than None.</p>
<p>Device Id (0-16777215)</p>	<p>This is required if you select a Device Validation Mode other than None.</p>
<p>Serial Num</p>	<p>This is required if you select Identical for the Device Validation Mode.</p>
<p>Data Validation Mode (Default: None)</p>	<p>There are three Data Validation Modes: None - no data validation is performed on the port. Loose - the slave device's PDI/PDO lengths must be less than or equal to the user-configured values. Strict - the slave device's PDI/PDO lengths must be the same as the user-configured values.</p>
<p>PDI Length (0-32)</p>	<p>This is the input length of the PDI data field. This is required if you select a Data Validation Mode other than None.</p>
<p>PDO Length (0-32)</p>	<p>This is the input length of the PDO data field. This is required if you select a Data Validation Mode other than None.</p>

5. Navigate to the **Validation Config** tab.

Figure 27: Validation Config tab

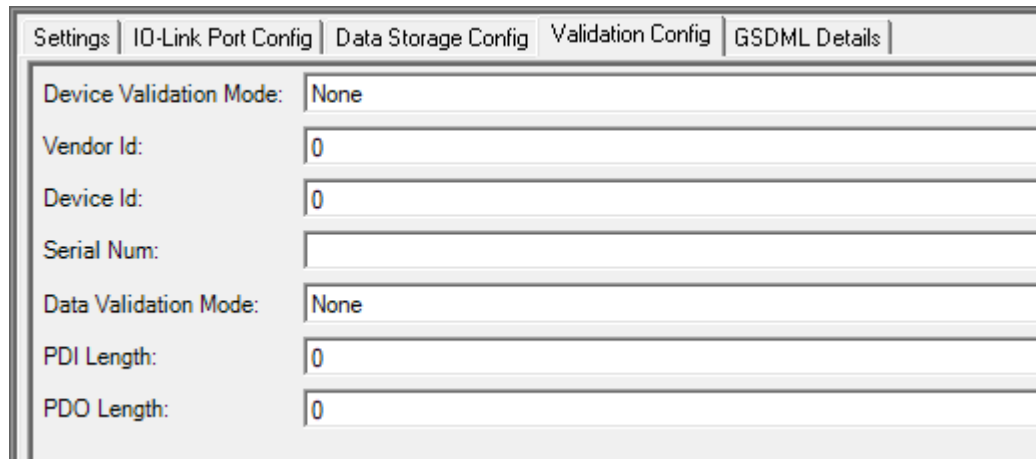

The screenshot shows the 'Validation Config' tab selected in a software interface. The tab bar at the top includes 'Settings', 'IO-Link Port Config', 'Data Storage Config', 'Validation Config', and 'GSDML Details'. The main content area contains the following fields:

Device Validation Mode:	None
Vendor Id:	0
Device Id:	0
Serial Num:	
Data Validation Mode:	None
PDI Length:	0
PDO Length:	0

6. Navigate to the **GSDML Details** tab. This tab provides details of the sub-module.

Figure 28: GSDML Details

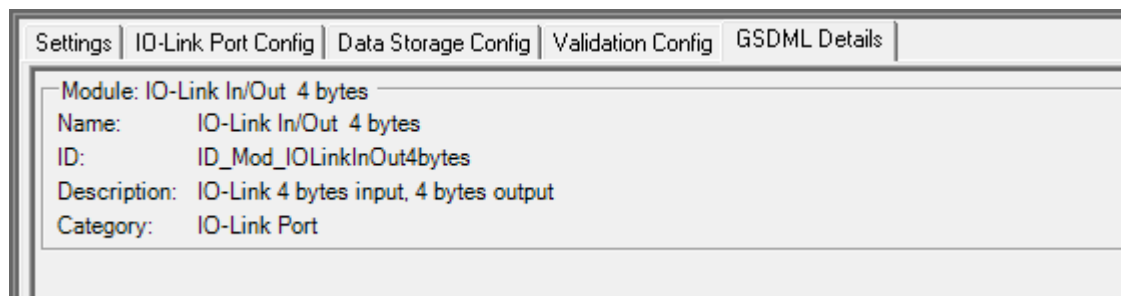

The screenshot shows the 'GSDML Details' tab selected in the software interface. The tab bar at the top includes 'Settings', 'IO-Link Port Config', 'Data Storage Config', 'Validation Config', and 'GSDML Details'. The main content area displays the following details for a sub-module:

Module:	IO-Link In/Out 4 bytes
Name:	IO-Link In/Out 4 bytes
ID:	ID_Mod_IOLinkInOut4bytes
Description:	IO-Link 4 bytes input, 4 bytes output
Category:	IO-Link Port

SIO Digital In/Out Module Parameters

Additional IO-Link port settings can be configured by using module parameters.

To configure the **SIO Digital In**

1. Navigate to the **Settings** tab and enter the **IO-Link Input Data** value seen in Figure 29

Figure 29: Settings

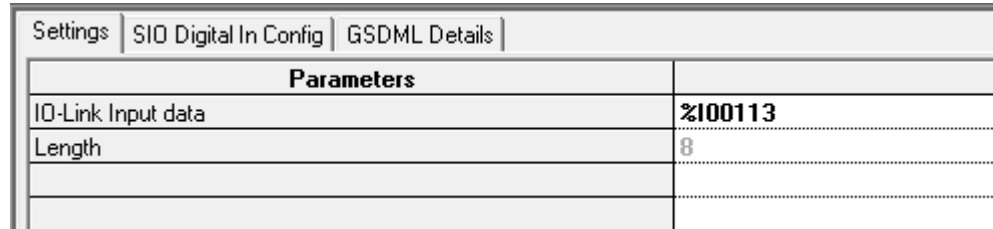

Parameters	
IO-Link Input data	2100113
Length	8

2. Navigate to the **SIO Digital In Config** tab and match the values seen in Figure 30.

Figure 30: SIO Digital In Config

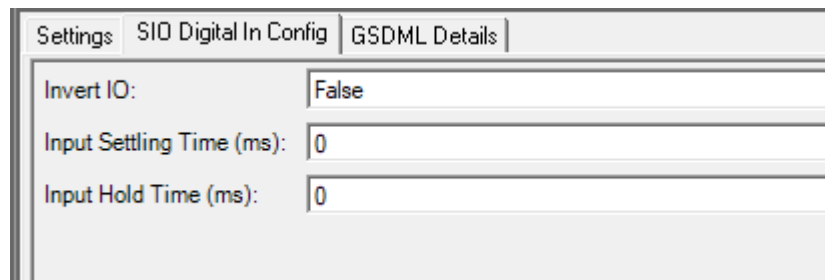

Invert IO:	False
Input Settling Time (ms):	0
Input Hold Time (ms):	0

3. Navigate to the **GSDML Details** tab. This tab provides details of the sub-module.

Figure 31: GSDML Details

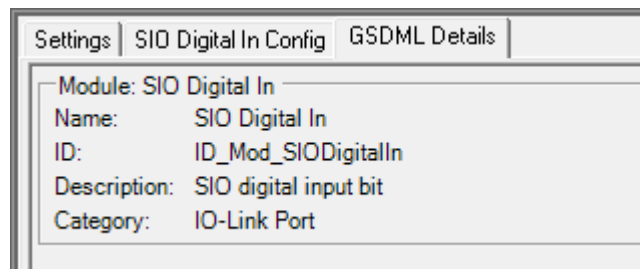

Module: SIO Digital In	
Name:	SIO Digital In
ID:	ID_Mod_SIODigitalIn
Description:	SIO digital input bit
Category:	IO-Link Port

To configure the **SIO Digital Out**, please visit the tabs in the following figures and match the parameter values.

1. Navigate to the **Settings** tab. Match the parameter value see in the **IO-Link Output data** (Figure 32).

Figure 32: Settings tab

Parameters	
IO-Link Output data	%Q00001
Length	8

2. Navigate to the **SIO Digital Output Config**. Match the values for **Invert IO** and **Default Digital Output** (Figure 33).

Figure 33: SIO Digital Output Config

Parameters	
Invert IO:	False
Default Digital Output:	Off

3. Navigate to the **GSDML Details** tab. This tab provides details of the sub-module.

Figure 34: GSDMLDetails

Module: SIO Digital Out	
Name:	SIO Digital Out
ID:	ID_Mod_SIODigitalOut
Description:	SIO digital output bit
Category:	IO-Link Port

SIO Digital Input and Output Module Parameters	
<i>SIO Digital Input</i>	
Invert IO (Default: False)	If enabled, this inverts the I/O value. False (Disabled - Do not invert IO) True (Enabled - Invert IO) <i>Note: This does not affect the Auxiliary Input.</i>
Input Settling Time (0 - 10000ms) <i>Default= 0ms</i>	If non-zero and Mode is set to Digital-Input, the required time that the input status must remain constant before an input status change is reported.
Input Hold Time (0 - 10000ms) (Default: 0ms)	This is how long the IOLM keeps the input at its present value. For example, if the IOLM detects the input to go too high, and the hold time is X milliseconds, then the IOLM reports the input as high for X milliseconds, even though the input itself may have gone away already. If X is zero, then you get the behavior currently in the field.
<i>SIO Digital Output</i>	
Invert IO (Default: False)	If enabled, this inverts the I/O value. False (Disabled - Do not invert IO) True (Enabled - Invert IO) <i>Note: This does not affect the Auxiliary Input.</i>
Default Digital Output (Default: Off)	Defines the default digital output value that is used at startup and when there is no active PDO controller. Off (low voltage) On (high voltage)

3.7.2 Port Status Modules

Port Status module can be configured in slot 9 or 10 of the IO-Link master module

- IO-Link Status Module

IO-Link Status Module

IO-Link Status module is a 4-byte input-only module that provides status information of all IO-Link ports. The following table shows the data format of the IO-Link Status module.

Byte Offset	Status Byte Description
0	IO-Link Active
1	IO-Link PDI Valid
2	IO-Link Auxiliary Input
3	IO-Link Error

Each IO-Link port is mapped into one bit of each byte in the IO-Link Status module as shown in this table.

Bit Map of IO-Link Active, IO-Link Error, and Auxiliary Input Modules								
Model	Bit 7	Bit 6	Bit 5	Bit 4	Bit 3	Bit 2	Bit 1	Bit 0
IOLM	Port 8	Port 7	Port 6	Port 5	Port 4	Port 3	Port 3	Port 1

For IO-Link Active status byte (offset 0), a bit one means the corresponding IO-Link port is active. An IO-Link port is considered active when it is configured correctly and has a working IO-Link device attached.

A bit one in IO-Link PDI Valid status byte (offset 1) means the PDI data from the corresponding IO-Link port is valid. PDI Valid is only applicable to IO-Link port modules that have input data.

- If there are any errors detected when communicating with the IO-Link device, the corresponding bit in the IO-Link Error status byte (offset 2) will be set to 1.
- If a high voltage is detected on the auxiliary input of an IO-Link port, the corresponding bit in the IO-Link Auxiliary Input status byte (offset 3) will be set to 1.

See the following table for the description of each byte of the IO-Link Status module.

Status Byte	Status Bit Description
IO-Link Active	<p>0: IO-Link port is not active, no IO-Link device is detected.</p> <p>1: IO-Link port is active, an IO-Link device is detected and operational.</p>
IO-Link PDI Valid	<p>0: IO-Link port PDI data is not valid.</p> <p>1: IO-Link port PDI data is valid.</p>
IO-Link Auxiliary Input	<p>0: Low voltage detected on the auxiliary pin of an IO-Link port.</p> <p>1: High voltage detected on the auxiliary pin of an IO-Link port.</p>
IO-Link Error	<p>0: No error detected</p> <p>1: An error detected. Further information about the error is available in PROFINET IO channel diagnostics.</p>

Auxiliary Input Parameters (for port 1 to port 8)

The following parameters can be configured for port 1 to port 8 under the **Auxiliary Input** tab for each port.

Figure 35: Auxiliary Input Parameters

Settings	Port 1 Auxiliary Input	Port 2 Auxiliary Input	Port 3 Auxiliary Input	Port 4 Auxiliary Input	Port 5 Auxiliary Input	Port 6 Auxiliary Input	Port 7 Auxiliary Input	Port 8 Auxiliary Input	GSDML Details
Enable:	True								
Invert Input:	False								
Input Settling Time (ms):	0								
Input Hold Time (ms):	0								

Port N Auxiliary Input Parameters	
Enable (Default: False)	<p>If enabled, the auxiliary input of Port n will be used.</p> <ul style="list-style-type: none"> • True (Enabled – Enable auxiliary input) • False (Disable – Do not use auxiliary input)
Invert Input (Default: False)	<p>If enabled, this inverts the auxiliary input of port n.</p> <ul style="list-style-type: none"> • False (Disabled - Do not auxiliary input) • True (Enabled – Invert auxiliary input)
Input Settling Time (ms) (Default: 0)	<p>The auxiliary input settling time that remains constant before that input is considered/accepted</p>
Input Hold Time (ms) (Default: 0)	<p>This is how long the IO-Link Master keeps the input at its present value. For example, if the IO-Link Master detects the input to go too high, and the hold time is X milliseconds, then the IO-Link Master reports the input as high for X milliseconds, even though the input itself may have gone away already. If X is zero, then you get the behavior currently in the field.</p>

3.7.3

Configuring IO-Link Ports with the Web Interface

IO-Link port settings (for example, port mode, minimum cycle time, data storage, validation, and device validation) should be configured through the controller by adding correct modules and setting modules' parameters via the PAC Machine Edition HW configuration. Optionally, the same settings can be changed through the web interface.

Note: Any changes made through the web interface are overwritten when an application relation is established between a gateway and an IO controller.

This page provides special features such as Data Storage, Device Validation, and Data Validation.

Note: Do not configure Data Storage until the IO-Link device is configured. Data Storage, Device Validation, and Data Validation are discussed in Section 8: *Utilizing IOLM Features*.

You can use this procedure to configure IO-Link settings for each IO-Link port.

If an IO-Link device is attached to the port, no configuration is required for operation. If a digital input or output device is attached, it is necessary to change the **Port Mode**.

1. If necessary, open the IO-Link Master web interface with your web browser using the default or configured IP address.
2. Click Configuration | IO-Link Settings.
3. Click the **EDIT** button for the port or ports that you want to configure.

Note: You can click each **EDIT** button and open all ports to quickly configure port parameters.

4. Make appropriate selections for the device that you connected to that port.

Make sure you select the **DigitalIn** option for a digital input device and the **DigitalOut** option for a digital output device for the **Port Mode**.

The IOLM negotiates the **Minimum Cycle Time** so it is not necessary to set a cycle time unless you need a specific cycle time.

Note: Setting a higher cycle time will impact the performance of the webserver, as it would take a longer time to read the parameters from the IO link device and update on the webpage.

You can use the help system if you require definitions or values for the options or refer to the following table.

Note: Do not configure Data Storage until the IO-Link device is configured.

Note: Do not enable **Automatic Download** and then attempt device configuration as Automatic Download changes the settings back to what is stored on the IOLM. Data Storage, Device Validation, and Data Validation are discussed in Section 8: Utilizing IOLM Features.

5. Click the **SAVE** button for each port.
6. Return to the **IO-Link Diagnostics** page to verify that your changes have taken effect.

The **Configuration | IO-Link Settings** page supports the following options.

IO-LINK Settings Page	
Port Name	User-defined port or device description. Standard ASCII characters Max length = 80 characters
Port Mode <i>Default: IO-Link</i>	Selected IO-Link port mode. Valid settings are: Reset - Select to disable a port or to reset/restart an IO-Link port. IO-Link - Select to connect and operate an IO-Link device on the port. Digital In - Select if a DI device is attached to the port. Digital Out - Select if a DO device is attached to the port.
Invert SIO <i>Default: False</i>	If enabled and the Port Mode is Digital In or Digital Out, this option inverts the SIO value. False (Disabled - Do not invert SIO) True (Enabled - Invert SIO) <i>Note: This option does not affect the Auxiliary Input.</i>
Invert Auxiliary Input	If this option is enabled, the Auxiliary bit is inverted.
Default Digital Output <i>Default: Off</i>	If the port mode is Digital Out, defines the default digital output value that is used at startup and when there is no active PDO controller. Off (low voltage) - 0 On (high voltage) - 24V
Minimum Cycle Time <i>Default: 4</i>	The minimum, or fastest, cycle time at which the IO-Link device may operate. The valid range is 4-538 ms. You can leave the Minimum Cycle Time set to the default value and the IO-Link Master negotiates with the IO-Link device for its minimum cycle time. The IO-Link Diagnostics page displays the Actual Cycle Time, which is the negotiated cycle time.
Auxiliary Input Settling Time (0 - 10000)	The auxiliary input settling time that remains constant before that input is considered/accepted
Auxiliary Input Hold Time (0 - 10000)	This is how long the IO-Link Master keeps the input at its present value. For example, if the IO-Link Master detects the input to go too high, and the hold time is X milliseconds, then the IO-Link Master reports the input as high for X milliseconds, even though the input itself may have gone away already. If X is zero, then you get the behavior currently in the field.
SIO Input Settling Time (0 - 10000)	The SIO input settling time remains constant before that input is considered/ accepted.
SIO Input Hold Time (0 - 10000)	This is how long the IO-Link Master keeps the input at its present value. For example, if the IO-Link Master detects the input to go too high, and the hold time is X milliseconds, then the IO-Link Master reports the input as high for X milliseconds, even though the input itself may have gone away already. If X is zero, then you get the behavior currently in the field.
Data Storage Config	
Storage Contents	Indicates that the data storage for the port is empty or displays the Vendor ID and Product ID of the data stored on that port.
Automatic Data Storage Upload Enable <i>Default: Off</i>	When this option is initially set to On, the IOLM saves the data storage parameters (if the data storage is empty) from the IO-Link device to the IOLM. Automatic upload occurs when the Automatic Upload Enable option is set to On and one of these conditions exists: There is no upload data stored on the gateway and the IO-Link device is connected to the port. The IO-Link device has the DS upload bit on (generally because you have changed the configuration via Teach buttons or web page). When a port contains data storage for an IO-Link device and if you attach a device whose Vendor and Device ID do not match, the IO-Link LED on the IOLM flashes red to indicate a wrong device is attached. In addition, the <i>IO-Link Diagnostics</i> page displays DS: Wrong Sensor in the IO-Link State field. <i>Note: Not all device parameters are sent to data storage, this is determined by the IO-Link device manufacturer.</i>

IO-LINK Settings Page	
Automatic Data Storage Download Enable <i>Default: Off</i>	The data storage parameters on the IOLM are downloaded to the connected IO-Link device if: The Automatic Download option is enabled. The data stored on the IOLM port contains the same Vendor ID and ProductID as the IO-Link device connected to the port. Data storage parameters are also downloaded to the IO-Link device if configuration changes are made on the device causing the DS upload bit to turn on and automatic upload is not enabled. The IO-Link device requests an upload and the Automatic Upload Enable option is set to Off. If you change configuration parameters on the IO-Link device and want the parameters to remain loaded on the IO-Link device, you must disable the Automatic Download option because otherwise, the IOLM will reload the data storage on the port down to the IO-Link device.
Data Storage Manual Ops	The Manual Data Storage Ops option provides the following functionality if data storage is supported by the IO-Link device. CLEAR - this clears any stored data for an IO-Link device on this port. UPLOAD - this uploads and stores the IO-Link device configuration on the IOLM. DOWNLOAD - this downloads the stored IO-Link device configuration from the IOLM to the IO-Link device attached to this port if the Vendor ID and Device ID match.
Validation Config	
Device Validation Mode (Default: None)	Device Validation Mode provides these options: None - this disables Device Validation Mode. Compatible - permits a compatible IO-Link device (same Vendor ID and Device ID) to function on the corresponding port. Identical - only permits an IO-Link device to function on the corresponding port as defined in the following fields. Vendor ID Device ID Serial Number <i>Note: Connecting an IO-Link device that is different than the configured with Data Validation enabled will generate a DV: wrong sensor error.</i>
Vendor Id (0-65535)	This is required if you select a Device Validation Mode other than <i>None</i> . The Vendor ID can be manually entered in this field or click the GET ATTACHED button and the IO-Link Master populates the Vendor ID in this field.
Device Id (0-16777215)	This is required if you select a Device Validation Mode other than <i>None</i> . The Device ID can be manually entered in this field or click the GET ATTACHED button and the IO-Link Master populates the Device ID in this field.
Serial Num	This is required if you select Identical for the Device Validation Mode. The Serial Number can be manually entered in this field or click the GET ATTACHED button and the IO-Link Master populates the serial number in this field.
Data Validation Mode (Default: None)	There are three Data Validation Modes: None - no data validation is performed on the port. Loose - the slave device's PDI/PDO lengths must be less than or equal to the user-configured values. Strict - the slave device's PDI/PDO lengths must be the same as the user-configured values.
PDI Length (0-32)	This is the input length of the PDI data field. This is required if you select a Data Validation Mode other than <i>None</i> . The PDI Length can be manually entered in this field or click the GET ATTACHED button and the IO-Link Master populates the PDI length in this field.

IO-LINK Settings Page	
PDO Length (0-32)	<p>This is the input length of the PDO data field. This is required if you select a Data Validation Mode other than <i>None</i>. The PDO Length can be manually entered in this field or click the GET ATTACHED button and the IO-Link Master populates the PDO length in this field</p>
GET ATTACHED (Button)	<p>After opening a port for editing, you can click the GET ATTACHED button to automatically populate the following fields with data from the IO-Link device:</p> <ul style="list-style-type: none"> Vendor Id Device Id Serial Num PDI Length PDO Length

Section 4: Updating the IOLM Firmware and Application Files

This section provides an overview of the software images (firmware) and applications on the IOLM. In addition, it contains procedures to update images (Section 4.2.1) and application sub-assemblies (Section 0).

After verifying that the IOLM contains the latest software, the next step is to configure the port characteristics using the instructions in Section 3: *Configuring the IOLM with PAC Machine Edition*.

4.1 Images (firmware) and Application Sub-Assemblies Overview

The IOLM is loaded with the latest images (firmware) at the factory but you may need to update images or application sub-assemblies to have access to the latest features. You can view all image and application versions on the IOLM **ADVANCED | Software** page.

Figure 36: Advanced Settings

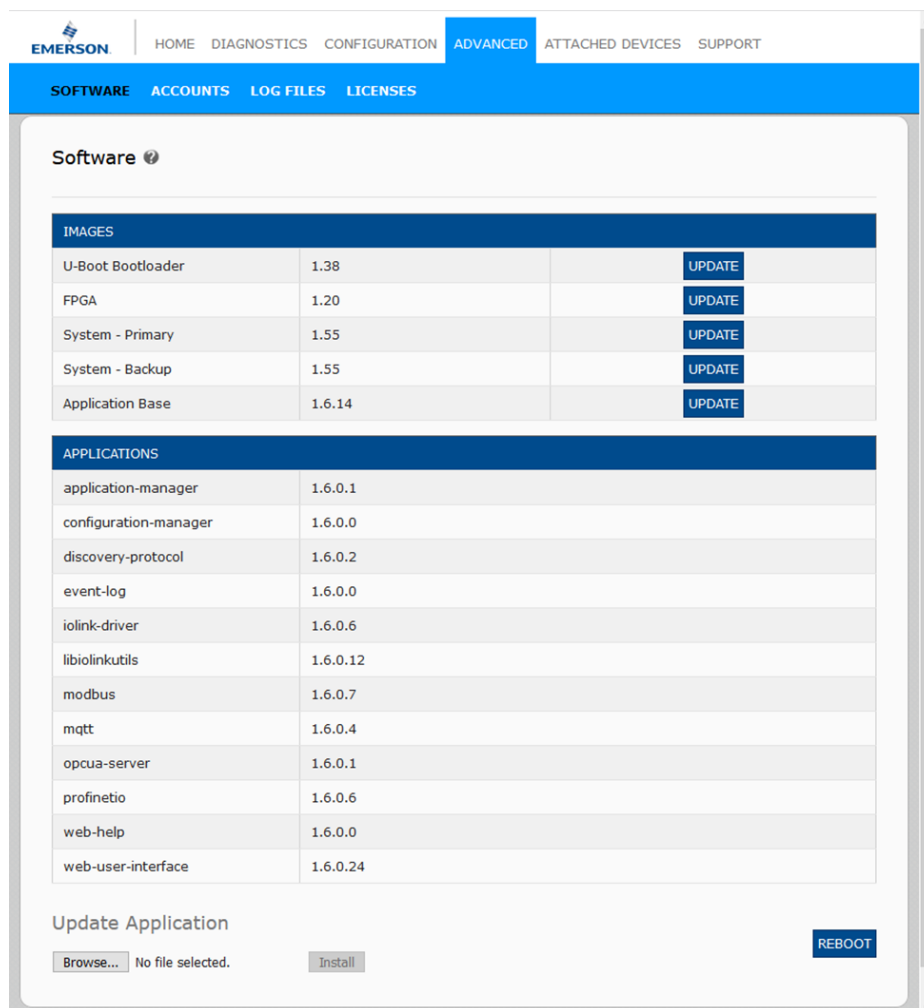

4.1.1 Images

The following table discusses IOLM images.

IOLM Images	
U-Boot Bootloader	<p>U-Boot is a high-level Bootloader that has networking and console command-line capabilities. Among other things, it implements a TFTP server and Emerson Corporation's discovery protocol.</p> <p>This verifies that a Linux kernel image exists in NAND, then copies it to RAM and starts the IOLM. The U-Boot version is displayed after the image name.</p>
FPGA	<p>The FPGA partition/image contains configuration data used by programmable hardware within the IOLM unit.</p> <p>FPGA images are unique to the hardware and protocol type. Make sure you download the correct image for your platform.</p>
ulmage - Primary/Backup	<p>The ulmage contains the Linux kernel and the RAM-resident root file system. It does not contain industrial protocol support or application-specific features.</p> <p>There is a Primary and Backup version loaded on the IOLM. The IOLM automatically reloads the Backup ulmage if the file system is corrupted. The ulmage version is displayed after the Primary/Backup ulmage.</p>
Application Base	<p>The Application Base image comprises a flash-resident file system containing applications and protocol support.</p> <p>The Application Base is built from a collection of application subassemblies -- each of which may be updated individually between releases of the application base as a whole.</p> <p>The application sub-assemblies in the Application Base image are displayed in the lower portion of the SOFTWARE page.</p> <p>The Application Base assembly has a 3-tuple version number: (for example, 1.3.18).</p>

4.1.2 Application Subassemblies

Application sub-assemblies are the components of the Application Base image. Application sub-assemblies have a 4-tuple version number (for example, 1.3.18.3). The first two values in a subassembly version correspond to the version of the application base assembly for which it was built and tested.

For example, a subassembly with version 1.3.18.3 was tested with application base version 1.3.18. When using the **Software** page, an application subassembly can install only if its version number matches that of the installed application base assembly. A subassembly with a version of 1.20.2.4 only installs if the application base version is 1.20.2. It will not install on a device with application base version 1.21.5.

IOLM Application Sub-assemblies	
application-manager	The Application Manager version is loaded on the IOLM.
configuration-manager	The Configuration Manager version is loaded on the IOLM.
discovery-protocol	The Discovery Protocol version is loaded on the IOLM.
event-log	The Event log version is loaded on the IOLM.
iolink-driver	The IO-Link driver version is loaded on the IOLM.

IOLM Application Sub-assemblies (Continued)	
libiolinkutils	The IO-Link utility library version is loaded on the IOLM.
modbus	If applicable, the Modbus/TCP interface version is loaded on the IOLM.
opcua-server	If applicable, the opc ua-server interface version is loaded on the IOLM.
profinetio	The PROFINET IO version is loaded on the IOLM.
web-help	The web interface help version is loaded on the IOLM.
web-user-interface	The web interface version loaded on the IOLM.

4.2 Using the Web Interface to Update Software

The upper portion of the **Advanced | Software** page is used to update the IOLM images. The lower portion of this page is used for updating application sub-assemblies that are integrated into the Application Base.

Typically, the latest application sub-assemblies are available in the Application Base image. There may times when a feature enhancement or bug fix is available in an application subassembly and not yet available in the Application Base image.

4.2.1 Updating Images

Use this procedure to upload images using the **SOFTWARE** page.

1. Download the latest image from the [Emerson](#) website.

Note: Make sure that you download the appropriate software for your model. For example, the FPGA images are unique for different hardware models and protocols.

2. Open your browser and enter the IP address of the IOLM.
3. Click **Advanced | SOFTWARE**.
4. Click the **UPDATE** button next to the image you want to update.
5. Click the **Browse** button, navigate to the file location, highlight the image, and click **Open**.

6. Click the **Install** button.

Figure 37: Software Page

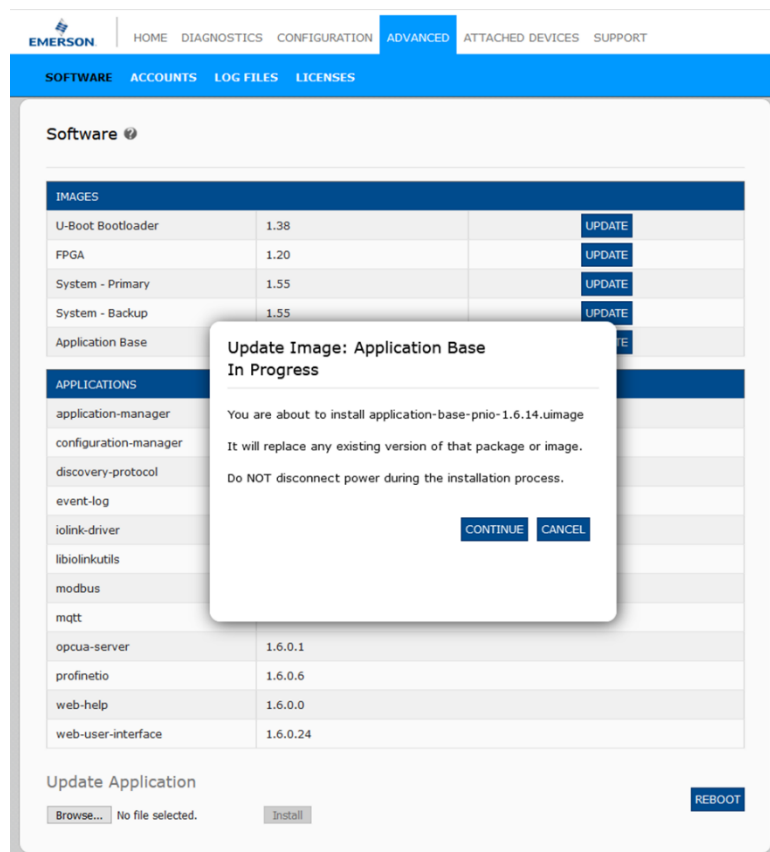

7. Click the **CONTINUE** button to the *Update Image* message.
8. Click **OK** to close the *Update Image Successful* message.

Note: Some images may require the IOLM web server to restart.

4.2.2 Updating Application Subassemblies

Use this procedure to upload applications using the **Software** page.

1. Download the latest application from the [Emerson website](#).
2. Open your browser and enter the IP address of the IOLM.
3. Click Advanced and SOFTWARE.
4. Click the **Browse** button under **Update Application** navigate to the file location, highlight the application, and click **Open**.
5. Click the **Install** button.

Figure 38: Installation

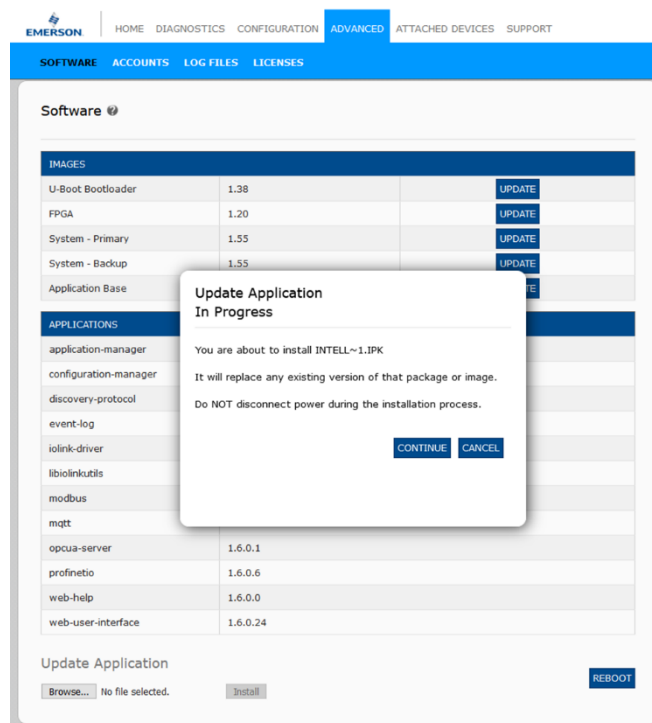

6. Click the **CONTINUE** button to the *Update Application* message.
7. Click **OK** to close the *Update Application Successful* message.

Section 5: Connecting Devices

This section discusses connecting devices to the IOLM.

- Overview (Section 5.1)
- IOLM IO-Link Ports (Section 5.2)

5.1 Overview

The C/Q pin for the IO-Link ports in SIO mode for all models:

- DI – sinking input

The DI pin on the IO-Link ports for all models is a sinking input.

- DO – PNP/NPN (push/pull) output

5.2 IOLM IO-Link Ports

The IOLM provides eight IO-Link ports with M12, 5-pin female/A coded connectors. Each port has robust over-current protection and short circuit protection on its L+/L- power output and C/Q IO-Link signal. The pin-out for each IO-Link port is per the IO-Link standard and is provided in the following table:

This table provides signal information for the IO-Link connectors.

Pin	Signal	Description
1	L+	IO-Link device power supply (+24V)
2	DI	Digital input
3	L-	IO-Link device power supply (0V)
4	C/Q	Communication signal, which supports SDCl (IO-Link) or SIO (standard input/output) digital I/O
5	FE	Functional Earth (electronics wiring)

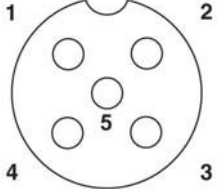

The standard SDCI (IO-Link) transmission rates are supported:

- COM1 at 4.8Kbps
- COM2 at 38.4Kbps
- COM3 at 230.4Kbps

There are active over-current limiter electronics for each port in the IOLM that detects the overload/short-circuit condition within a few milliseconds and shuts off the output power to protect the port and the devices connected to it. The port's power output self-recovers and restores to normal immediately after the overload or short-circuit condition is removed.

The over-current limiter circuit for L+/L- pins are separate circuits from the over-current limiter circuit for the C/Q output pin. When a port is affected by overload/short-circuit conditions, it does not affect the operation of the other ports. All other ports will continue to operate normally without any glitch or interruption. The current output capacity, cutoff current, and power-sharing/budgeting for L+/L- and C/Q signal for the ports on the IOLM are as follows:

IOLM	L+/L-			C/Q		
	Output Current Capacity (max.)	Overload Cutoff Current	Short-Circuit Protection	Output Current Capacity (max.)	Overload Cutoff Current	Short-Circuit Protection
Port 1: Independent over-current limiter circuits/IC for L+/L- and C/Q pins	1.6A	1.65A	Yes	200mA	400mA	Yes
Port 3: Independent over-current limiter circuits/IC for L+/L- and C/Q pins	1A	1.05A	Yes	200mA	400mA	Yes

IOLM		Ports 2 and 4 (Pair)	Ports 5 and 7 (Pair)	Ports 6 and 8 (Pair)
L+/L-	Output Current Capacity (max.)	500 mA/ port pair (1 A output power budget per-port pair)	500 mA/ port pair (1 A output power budget per-port pair)	500 mA/ port pair (1 A output power budget per-port pair)
	Overload Cutoff Current	1.05 A/port pair	1.05 A/port pair	1.05 A/port pair
	Short-Circuit Protection	Yes	Yes	Yes
C/Q	Output Current Capacity (max.)	200 mA*/ port	200 mA*/ port	200 mA*/ port
	Overload Cutoff Current	400 mA*/ port	400 mA*/ port	400 mA*/ port
	Short-Circuit Protection	Yes	Yes	Yes
* Each port's C/Q pin has its own independent over-current limiter circuit and is not combined. The current output of the C/Q pin for each port is also independently controlled and cannot be budgeted with other ports.				

Note: There is one independent over-current limiter that protects L+/L- pins on each pair of ports, for example: Port 2 and 4.

This allows you to do power budgeting on pair of ports that allows flexibility in the application. The combined overload cutoff current on a pair of ports is 1.05 A for the L+/L- pins.

As long as the cutoff current of 1.05 A is not exceeded, the current output could be budgeted between a pair of ports such as Port 2 and 4 any way you want.

For example, Port 2 output can be at 900 mA and Port 4 output can be at 100 mA. Or, Port 2 could be left open and Port 4 output can be at 1 A.

Use the following procedure to attach IO-Link or digital input/output devices to the ports.

1. Securely attach the IO-link cable between the IO-Link or digital input/output device and the IO-Link port.

Note: Make sure that you tighten the cables properly to maintain IP67 integrity.

2. If necessary, securely attach a connector cap to prevent dust or liquids from getting into any unused ports. Connector caps were shipped with the IOLM.

Note: IO-Link ports must have an approved cable or protective cover attached to the port to guarantee IP67 compliance.

3. If necessary, configure IO-Link port parameters using the **Configuration | IO-Link Settings** page to configure the port mode.
 - If an IO-Link device is attached to the port, the IO-Link LED should now be lit green and the device is receiving power.
 - If a digital input or output device is attached to the IO-Link port after the port is configured for digital input or output on the **IO-Link Settings** page, the IO-Link LED does not light but when an event occurs:
 - Digital input causes the DI LED to flash.
 - Digital output causes the IO-Link LED to flash.

You can refer to the help system or 3.7.1, *IO-Link Port Modules* for configuration information.

Section 6: IO-Link Master Port Configuration

This section discusses port configuration, which includes these topics:

- Preparing for Port Configuration
- IO-Link Configuration Page (Section 6.2)
- PROFINET IO Settings Configuration Page (Section 6.3)
- Modbus/TCP Settings Configuration Page (Section 6.4)
- OPC UA Settings Configuration Page (Section 6.5)

Note: See Section 3.7, *Configuring IO-Link Ports* for information about configuring dedicated digital I/O ports.

Although you can make configuration changes using the web interface, PROFINET IO configuration parameters overwrite the values on the following *Configuration* pages:

- IO-Link Settings
- PROFINET IO Settings
- Network Settings

6.1 Preparing for Port Configuration

Before beginning port configuration, you may want to verify that the connected device is functioning.

1. If necessary, log into the IO-Link Master.
2. Click Diagnostics | IO-Link Diagnostics.
3. Review the Port Status and IO-Link State.

Port Status	Operational, PDI Valid	An IO-Link device is operating on the port that has received valid PDI data.
	Operational	An IO-Link device is operating on the port that has not received valid PDI data.
	Inactive	One of the following conditions exists: A valid IO-Link device is not connected to the port. A digital input or output device is connected to the port but the configured Port Mode is not correct.
IO-Link State	Operate	Port is functioning correctly in IO-Link mode but has not received valid PDI data. This may also display during a data storage upload or download.
	Init	The port is attempting initialization.
	Reset	One of the following conditions exists: The Port Mode configuration is set to Reset . The Port Mode configuration is set to DigitalIn or DigitalOut .
	DS: Wrong Sensor	Hardware failure (IO-Link LED also flashes red) because there is Data Storage on this port, which does not reflect the attached device.
	DV: Wrong Sensor	Hardware failure (IO-Link LED also flashes red) because Device Validation is configured for this port and the wrong device is attached.
	DS: Wrong Size	Hardware failure (IO-Link LED also flashes red) because the size of the configuration on the device does not match the size of the configuration stored on the port.
	Comm Lost	Temporary state after a device is disconnected and before the port is re-initialized.
	Pre-operate	Temporary status displayed when the device: It is starting up after connection or power-up. Uploading or downloading automatic data storage.

Note: If a digital input or output device is connected to an IO-Link port, there is no valid data until the port is set to the correct **Port Mode**.

4. Review the Device IO-Link Version.
 - If the field is blank, it is not a valid IO-Link device, which could mean that it is a digital device and the port has not been configured for digital input or digital output.
 - The field displays the Device IO-Link version.
5. Optionally, review the following to see if you need to change the **Configured Minimum Cycle Time**:
 - Actual Cycle Time
 - Device Minimum Cycle Time
 - Configured Minimum Cycle Time

The **Configured Minimum Cycle Time** is the minimum cycle time that the IO-Link Master allows the port to operate at. The **Actual Cycle Time** is negotiated between the IO-Link Master and the device and will be at least as long as the greater of the **Configured Minimum Cycle Time** and the **Device Minimum Cycle Time**.

Verify that the **Auxiliary Input Bit Status** field displays **On** if the device is connected to DI.

Figure 39: Software Diagnostics

The screenshot shows the 'IO-Link Diagnostics' page with a table of port status and device information. The table has columns for 'IO-LINK PORT STATUS', 'PORT 1', 'PORT 2', and 'PORT 3'. The rows include various diagnostic fields such as Port Name, Port Mode, Port Status, IOLink State, Device Vendor Name, Device Product Name, Device Serial Number, Device Hardware Version, Device Firmware Version, Device IO-Link Version, Actual Cycle Time, Device Minimum Cycle Time, Configured Minimum Cycle Time, Data Storage Capable, Automatic Data Storage Configuration, and Auxiliary Input Status.

IO-LINK PORT STATUS	PORT 1	PORT 2	PORT 3
Port Name	IO-Link Port 1	IO-Link Port 2	IO-Link Port 3
Port Mode	IOLink	IOLink	IOLink
Port Status	Operational	Operational, PDI Valid	Operational, PDI Valid
IOLink State	Operate	Operate	Operate
Device Vendor Name	Banner Engineering Corporation	Pepperl+Fuchs	Rosemount Inc.
Device Product Name	KS0L2	ICA-10016DO-G60A-IO	326T-L100T32A
Device Serial Number	20-10-0814-01:53	40000058722091	00005256048
Device Hardware Version	V00-01	HW01.00	AA
Device Firmware Version	2.0.28	FW01.00	109
Device IO-Link Version	1.1	1.1	1.1
Actual Cycle Time	4.0ms	4.0ms	4.0ms
Device Minimum Cycle Time	4.0ms	2.0ms	2.3ms
Configured Minimum Cycle Time	4ms	4ms	4ms
Data Storage Capable	Yes	Yes	Yes
Automatic Data Storage Configuration	Disabled	Disabled	Disabled
Auxiliary Input Status	Off	Off	On

For additional information see Section 9.1, *IO-Link Port Diagnostics*.

6.2 IO-Link Configuration Page

You can use the **Configuration | IO-Link Settings** page to configure IO-Link port settings. When the IO-Link device is attached to a port, it begins operating without requiring any configuration. The IOLM and attached IO-Link device automatically negotiate the **Minimum Cycle Time**. If required by an application, you can set a specific **Minimum Cycle Time**.

This page provides special features such as Data Storage, Device Validation, and Data Validation.

Although you can make configuration changes using the web page, PROFINET IO configuration parameters overwrite the values on the *IO-Link Settings* page. See Section 3: *Configuring the IOLM with PAC Machine Edition* for detailed configuration procedures.

Figure 40: IO-Link Configuration Page

The screenshot shows the 'IO-Link Settings' page in a web browser. The page has a navigation bar with 'EMERSON' and 'HOME DIAGNOSTICS CONFIGURATION ADVANCED ATTACHED DEVICES SUPPORT'. Below that is a sub-navigation bar with 'IO-LINK PROFINET IO MODBUS/TCP OPC UA MQTT NETWORK MISC LOAD/SAVE CLEAR SETTINGS'. The main content area is titled 'IO-Link Settings' and contains a table with 9 columns: 'IO-LINK PORT CONFIG', 'PORT 1', 'PORT 2', 'PORT 3', 'PORT 4', 'PORT 5', 'PORT 6', 'PORT 7', and 'PORT 8'. Each port column has an 'EDIT' button above it. The table rows include: 'Port Name', 'Port Mode', 'PDO Lock Enable', 'Invert SIO', 'Invert Auxiliary Input', 'Default SIO Digital Output State', 'Minimum Cycle Time (4 - 538)', 'Auxiliary Input Settling Time (0 - 10000)', 'Auxiliary Input Hold Time (0 - 10000)', 'SIO Input Settling Time (0 - 10000)', 'SIO Input Hold Time (0 - 10000)', 'Data Storage Config', 'Storage Contents', 'Automatic Upload Enable', and 'Automatic Download Enable'. Below the table are 'Data Storage Manual Ops' with 'CLEAR', 'UPLOAD', and 'DOWNLOAD' buttons for each port.

IO-LINK PORT CONFIG	PORT 1	PORT 2	PORT 3	PORT 4	PORT 5	PORT 6	PORT 7	PORT 8
	EDIT	EDIT	EDIT	EDIT	EDIT	EDIT	EDIT	EDIT
Port Name	IO-Link Port 1	IO-Link Port 2	IO-Link Port 3	IO-Link Port 4	IO-Link Port 5	IO-Link Port 6	IO-Link Port 7	IO-Link Port 8
Port Mode	IOLink	IOLink	IOLink	IOLink	IOLink	IOLink	IOLink	IOLink
PDO Lock Enable	true	true	true	true	true	true	true	true
Invert SIO	false	false	false	false	false	false	false	false
Invert Auxiliary Input	false	false	false	false	false	false	false	false
Default SIO Digital Output State	Off	Off	Off	Off	Off	Off	Off	Off
Minimum Cycle Time (4 - 538)	4 ms	4 ms	4 ms	4 ms	4 ms	4 ms	4 ms	4 ms
Auxiliary Input Settling Time (0 - 10000)	0 ms	0 ms	0 ms	0 ms	0 ms	0 ms	0 ms	0 ms
Auxiliary Input Hold Time (0 - 10000)	0 ms	0 ms	0 ms	0 ms	0 ms	0 ms	0 ms	0 ms
SIO Input Settling Time (0 - 10000)	0 ms	0 ms	0 ms	0 ms	0 ms	0 ms	0 ms	0 ms
SIO Input Hold Time (0 - 10000)	0 ms	0 ms	0 ms	0 ms	0 ms	0 ms	0 ms	0 ms
Data Storage Config								
Storage Contents	empty	1:983554	empty	empty	empty	empty	empty	empty
Automatic Upload Enable	Off	Off	Off	Off	Off	Off	Off	Off
Automatic Download Enable	Off	Off	Off	Off	Off	Off	Off	Off
Data Storage Manual Ops								
	CLEAR	CLEAR	CLEAR	CLEAR	CLEAR	CLEAR	CLEAR	CLEAR
	UPLOAD	UPLOAD	UPLOAD					
	DOWNLOAD	DOWNLOAD	DOWNLOAD					

6.2.1 Editing IO-Link Port Settings

You can use this procedure to configure IO-Link settings for each IO-Link port.

If an IO-Link device is attached to the port, no configuration is required for operation. If a digital input or output device is attached, it is necessary to change the **Port Mode**.

1. If necessary, open the IO-Link Master web interface with your web browser using the IP address.
2. Click Configuration | IO-Link Settings.
3. Click the **EDIT** button for the port or ports that you want to configure.

Figure 41: IO-Link Settings

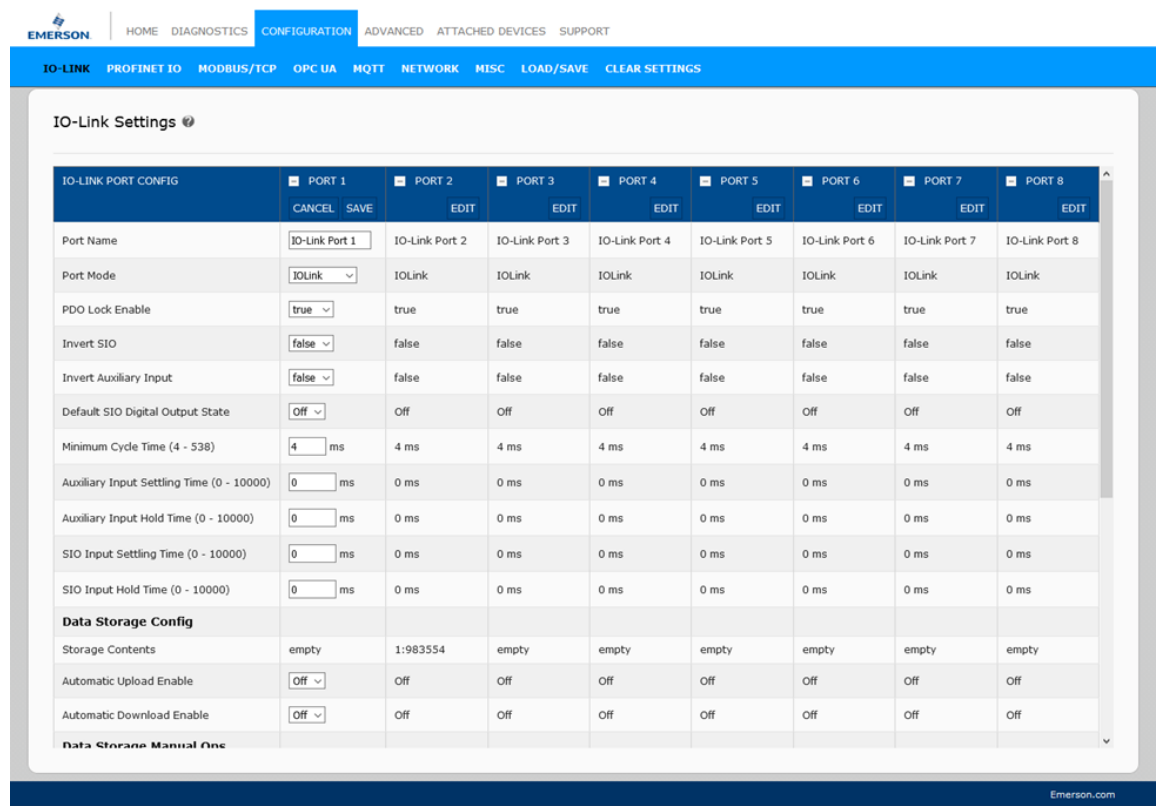

Note: You can click each **EDIT** button and open all ports to quickly configure port parameters.

1. Make appropriate selections for the device that you connected to that port.

Make sure you select the **DigitalIn** option for a digital input device and the **DigitalOut** option for a digital output device for the **Port Mode**.

The IOLM negotiates the **Minimum Cycle Time** so it is not necessary to set a cycle time unless you need a specific cycle time.

You can use the help system if you require definitions or values for the options or refer to the following subsection (*IO-Link Settings Parameters*).

Note: Do not enable **Automatic Download** and then attempt device configuration as Automatic Download changes the settings back to what is stored on the IOLM. Data Storage, Device Validation, and Data Validation are discussed in Section 9: *Using the Diagnostics Pages*.

1. Click the **SAVE** button for each port.
2. Return to the **IO-Link Diagnostics** page to verify that your changes have taken effect.

6.2.2 IO-Link Settings Parameters

The **Configuration | IO-Link Settings** page supports the following options.

IO-LINK Settings Page	
Port Name	User-defined port or device description. Standard ASCII characters Max length = 80 characters
Port Mode <i>Default: IO-Link</i>	Selected IO-Link port mode. Valid settings are: Reset - Select to disable a port or to reset/restart an IO-Link port. IO-Link - Select to connect and operate an IO-Link device on the port. Digital In - Select if a DI device is attached to the port. Digital Out - Select if a DO device is attached to the port.
Invert SIO <i>Default: False</i>	If enabled and the Port Mode is Digital In or Digital Out , this option inverts the SIO value. False (Disabled - Do not invert SIO) True (Enabled - Invert SIO) <i>Note: This option does not affect the Auxiliary Input.</i>
Invert Auxiliary Input	If this option is enabled, the Auxiliary bit is inverted.
Default Digital Output <i>Default: Off</i>	If the port mode is Digital Out , defines the default digital output value that is used at startup and when there is no active PDO controller. Off (low voltage) - 0 On (high voltage) - 24V
Minimum Cycle Time <i>Default: 4</i>	The minimum, or fastest, cycle time at which the IO-Link device may operate. The valid range is 4-538 ms. You can leave the Minimum Cycle Time set to the default value and the IO-Link Master negotiates with the IO-Link device for its minimum cycle time. The IO-Link Diagnostics page displays the Actual Cycle Time , which is the negotiated cycle time.
Auxiliary Input Settling Time (0 - 10000)	The auxiliary input settling time that remains constant before that input is considered/accepted
Auxiliary Input Hold Time (0 - 10000)	This is how long the IO-Link Master keeps the input at its present value. For example, if the IO-Link Master detects the input to go too high, and the hold time is X milliseconds, then the IO-Link Master reports the input as high for X milliseconds, even though the input itself may have ceased. If X is zero, then you get the behavior currently in the field.
SIO Input Settling Time (0 - 10000)	The SIO input settling time remains constant before that input is considered/ accepted.
SIO Input Hold Time (0 - 10000)	This is how long the IO-Link Master keeps the input at its present value. For example, if the IO-Link Master detects the input to go too high, and the hold time is X milliseconds, then the IO-Link Master reports the input as high for X milliseconds, even though the input itself may have ceased. If X is zero, then you get the behavior currently in the field.
Data Storage Config	
Storage Contents	Indicates that the data storage for the port is empty or displays the Vendor ID and Product ID of the data stored on that port.

<p>Automatic Data Storage Upload Enable <i>Default: Off</i></p>	<p>When this option is initially set to On, the IOLM saves the data storage parameters (if the data storage is empty) from the IO-Link device to the IOLM.</p> <p>Automatic upload occurs when the Automatic Upload Enable option is set to On and one of these conditions exists:</p> <ul style="list-style-type: none"> There is no upload data stored on the gateway and the IO-Link device is connected to the port. The IO-Link device has the DS_upload bit on (generally because you have changed the configuration via Teach buttons or web page). <p>When a port contains data storage for an IO-Link device and if you attach a device whose Vendor and Device ID do not match, the IO-Link LED on the IOLM flashes red to indicate a wrong device is attached. In addition, the <i>IO-Link Diagnostics</i> page displays DS: Wrong Sensor in the IOLink State field.</p> <p><i>Note: Not all device parameters are sent to data storage, this is determined by the IO-Link device manufacturer.</i></p>
<p>Automatic Data Storage Download Enable <i>Default: Off</i></p>	<p>The data storage parameters on the IOLM are downloaded to the connected IO-Link device if:</p> <ul style="list-style-type: none"> The Automatic Download option is enabled. The data stored on the IOLM port contains the same Vendor ID and ProductID as the IO-Link device connected to the port. <p>Data storage parameters are also downloaded to the IO-Link device if configuration changes are made on the device causing the DS_upload bit to turn on and automatic upload is not enabled.</p> <p>The IO-Link device requests an upload and the Automatic Upload Enable option is set to Off.</p> <p>If you change configuration parameters on the IO-Link device and want the parameters to remain loaded on the IO-Link device, you must disable the Automatic Download option because otherwise, the IOLM will reload the data storage on the port down to the IO-Link device.</p>
<p>Data Storage Manual Ops</p>	<p>The Manual Data Storage Ops option provides the following functionality if data storage is supported by the IO-Link device.</p> <ul style="list-style-type: none"> CLEAR - this clears any stored data for an IO-Link device on this port. UPLOAD - this uploads and stores the IO-Link device configuration on the IOLM. DOWNLOAD - this downloads the stored IO-Link device configuration from the IOLM to the IO-Link device attached to this port if the Vendor ID and Device ID match.
<p>Validation Config</p>	
<p>Device Validation Mode (Default: None)</p>	<p>Device Validation Mode provides these options:</p> <ul style="list-style-type: none"> None - this disables Device Validation Mode. Compatible - permits a compatible IO-Link device (same Vendor ID and Device ID) to function on the corresponding port. Identical - only permits an IO-Link device to function on the corresponding port as defined in the following fields. <p>Vendor ID Device ID Serial Number</p> <p><i>Note: Connecting an IO-Link device that is different than the configured with Data Validation enabled will generate a DV: wrong sensor error.</i></p>
<p>Vendor Id (0-65535)</p>	<p>This is required if you select a Device Validation Mode other than <i>None</i>.</p> <p>The Vendor ID can be manually entered in this field or click the GET ATTACHED button and the IO-Link Master populates the Vendor ID in this field.</p>

Device Id (0-16777215)	<p>This is required if you select a Device Validation Mode other than <i>None</i>. The Device ID can be manually entered in this field or click the GET ATTACHED button and the IO-Link Master populates the Device ID in this field.</p>
Serial Num	<p>This is required if you select Identical for the Device Validation Mode. The Serial Number can be manually entered in this field or click the GET ATTACHED button and the IO-Link Master populates the serial number in this field.</p>
Data Validation Mode (Default: None)	<p>There are three Data Validation Modes: None - no data validation is performed on the port. Loose - the slave device's PDI/PDO lengths must be less than or equal to the user-configured values. Strict - the slave device's PDI/PDO lengths must be the same as the user-configured values.</p>
PDI Length (0-32)	<p>This is the input length of the PDI data field. This is required if you select a Data Validation Mode other than <i>None</i>. The PDI Length can be manually entered in this field or click the GET ATTACHED button and the IO-Link Master populates the PDI length in this field.</p>
PDO Length (0-32)	<p>This is the input length of the PDO data field. This is required if you select a Data Validation Mode other than <i>None</i>. The PDO Length can be manually entered in this field or click the GET ATTACHED button and the IO-Link Master populates the PDO length in this field.</p>
GET ATTACHED (Button)	<p>After opening a port for editing, you can click the GET ATTACHED button to automatically populate the following fields with data from the IO-Link device: Vendor Id Device Id Serial Num PDI Length PDO Length</p>

6.3 PROFINET IO Settings Configuration Page

The following table provides information about the Configuration | PROFINET IO page options.

You can refer to Section 3.5, *Device Name Assignment*.

for PROFINET IO configuration procedures. You must have Administrator or Operator privileges to change any settings on this page.

Figure 42: Configuration Page

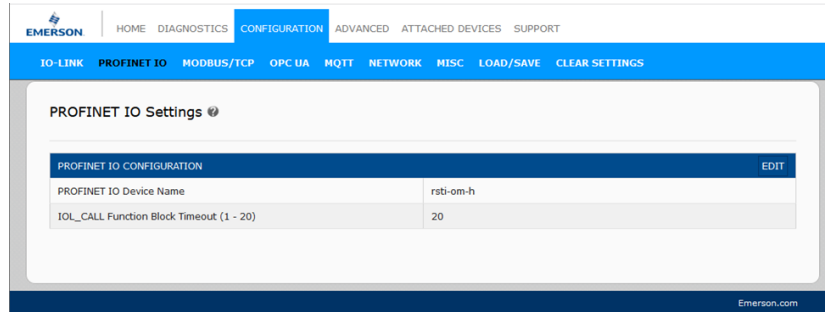

PROFINET IO Settings Page	
PROFINET IO Device Name	<p>The PROFINET IO Device Name is the same as the name later used to configure PROFINET IO for the IO-Link Master.</p> <p>The device name must be specified according to DNS conventions.</p> <p>Restricted to a total of 240 characters (letters, digits, dash, or period)</p> <p>Parts of the name within the device name; in other words, a string between two periods, must not exceed a maximum of 63 characters.</p> <p>No special characters such as umlauts (ä, ö, etc.), brackets, underscore, slash, blank, etc. The dash is the only permitted special character.</p> <p>The device name must not begin or end with the "-" character.</p> <p>The device name must not begin with numbers.</p> <p>The device name must not have the structure n.n.n.n (n = 0...999).</p> <p>The device name must not begin with the character string "port-xyz-" (x,y, z = 0...9).</p>
IOL_CALL Function Block Timeout (1-20)	<p>The IOL_CALL Function Block Timeout range is 1 - 20 and the default is 20.</p>

6.4 Modbus/TCP Settings Configuration Page

You can use the **Configuration | Modbus/TCP Settings** page to configure Modbus/TCP with the IO-Link Master. Additional Modbus information is available in the following sections:

- Section 11: Modbus/TCP Interface
- Section 13: Functionality Descriptions

Figure 43: Modbus/TCP Settings

The screenshot displays the 'Modbus/TCP Settings' configuration page. The interface includes a navigation bar with 'EMERSON' and menu items like 'HOME', 'DIAGNOSTICS', 'CONFIGURATION', 'ADVANCED', 'ATTACHED DEVICES', and 'SUPPORT'. Below this is a secondary navigation bar with options: 'IO-LINK', 'PROFINET IO', 'MODBUS/TCP', 'OPC UA', 'MQTT', 'NETWORK', 'MISC', 'LOAD/SAVE', and 'CLEAR SETTINGS'. The main content area is titled 'Modbus/TCP Settings' and contains a table with columns for 'MODBUS/TCP PORT CONFIG' and 'PORT 1' through 'PORT 8'. Each port column has an 'EDIT' button. The table is divided into two sections: 'ISDU Data Settings' and 'Process Data Settings'. The 'ISDU Data Settings' section includes 'ISDU Response Timeout (1 - 10000)' with a value of 20 sec for all ports. The 'Process Data Settings' section includes 'PDI Data Block Size (To PLC)' (36 bytes), 'PDI Byte-Swap Method' (no byte-swap), 'PDO Data Block Size (From PLC)' (32-bytes), 'PDO Byte-Swap Method' (no byte-swap), 'Append PDO to PDI Data' (false), 'Clear Event Code In PDO Block' (false), 'Clear Event Code After Hold Time' (true), 'Active Event Hold Time (1 - 65535)' (1000), 'Event Hold Time Units' (ms), 'Clear Event Hold Time (1 - 65535)' (500), and 'Event Clear Time Units' (ms). At the bottom, there is a 'MODBUS/TCP CONFIGURATION' section with an 'EDIT' button and a 'Modbus Enable' checkbox set to 'enable'. The Emerson logo and 'Emerson.com' are visible at the bottom right of the page.

MODBUS/TCP PORT CONFIG	PORT 1	PORT 2	PORT 3	PORT 4	PORT 5	PORT 6	PORT 7	PORT 8
	EDIT	EDIT	EDIT	EDIT	EDIT	EDIT	EDIT	EDIT
ISDU Data Settings:								
ISDU Response Timeout (1 - 10000)	20 sec	20 sec	20 sec	20 sec	20 sec	20 sec	20 sec	20 sec
Process Data Settings:								
PDI Data Block Size (To PLC)	36 bytes	36 bytes	36 bytes	36 bytes	36 bytes	36 bytes	36 bytes	36 bytes
PDI Byte-Swap Method	no byte-swap	no byte-swap	no byte-swap	no byte-swap	no byte-swap	no byte-swap	no byte-swap	no byte-swap
PDO Data Block Size (From PLC)	32-bytes	32-bytes	32-bytes	32-bytes	32-bytes	32-bytes	32-bytes	32-bytes
PDO Byte-Swap Method	no byte-swap	no byte-swap	no byte-swap	no byte-swap	no byte-swap	no byte-swap	no byte-swap	no byte-swap
Append PDO to PDI Data	false	false	false	false	false	false	false	false
Clear Event Code In PDO Block	false	false	false	false	false	false	false	false
Clear Event Code After Hold Time	true	true	true	true	true	true	true	true
Active Event Hold Time (1 - 65535)	1000	1000	1000	1000	1000	1000	1000	1000
Event Hold Time Units	ms	ms	ms	ms	ms	ms	ms	ms
Clear Event Hold Time (1 - 65535)	500	500	500	500	500	500	500	500
Event Clear Time Units	ms	ms	ms	ms	ms	ms	ms	ms
MODBUS/TCP CONFIGURATION EDIT								
Modbus Enable	enable							

Note: Modbus is disabled by default. To use Modbus, click the **EDIT** button and select **Enable**.

Editing Modbus/TCP Settings

If necessary, open the IO-Link Master web interface with your web browser using the IP address.

1. Click **Configuration | Modbus/TCP**.
2. Click the **EDIT** button for the port that you want to configure.

Figure 44: Edit Changes

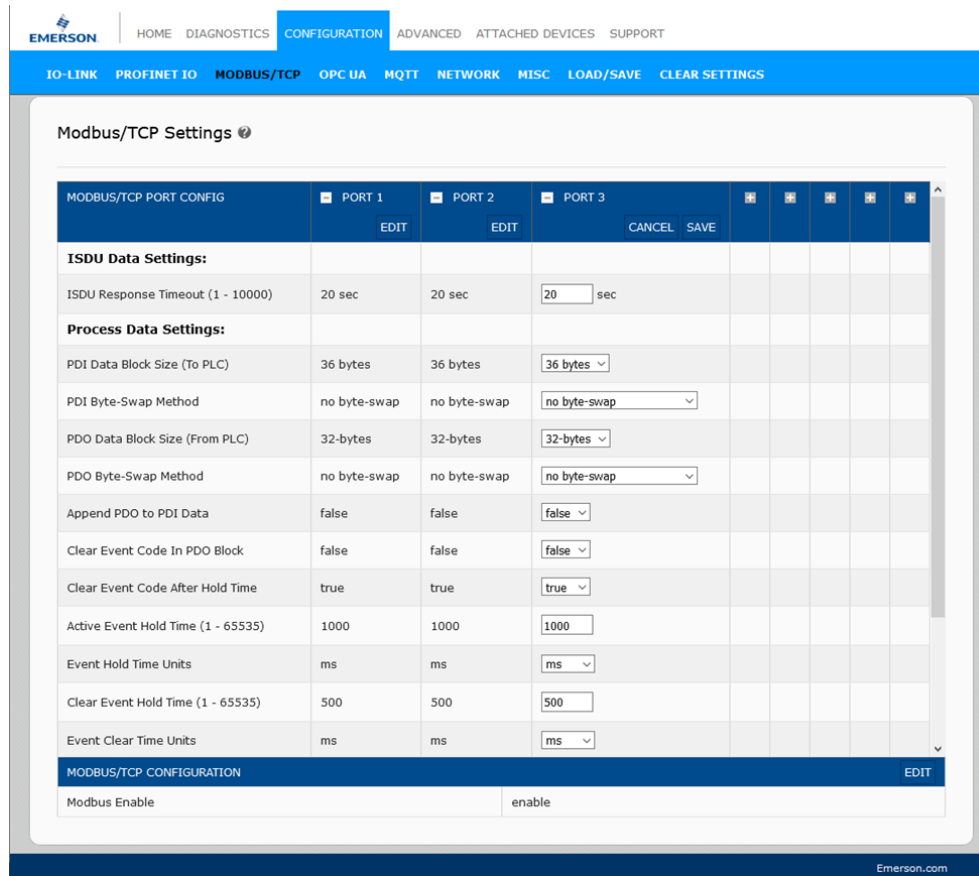

Note: You can click each **EDIT** button and open all ports to quickly configure port parameters.

1. Make appropriate selections for the IO-Link device that you will connect to that port. You can use the help system if you require definitions or values for the options or [Modbus/TCP Settings Parameters](#)
2. Scroll to the top of the page and click the **SAVE** button. Make sure that the port now displays the **EDIT** button.

If it displays the **SAVE** and **CANCEL** buttons, that means that one of the parameters contains an incorrect value. If necessary, scroll down the page, make the needed corrections, and click **SAVE**.

6.4.1 Modbus/TCP Settings Parameters

The following table provides detailed information about the **Modbus/TCP Settings** page.

Modbus/TCP Settings Page	
<i>ISDU Data Settings</i>	
ISDU Response Timeout <i>Default = 20 seconds</i>	The time that the IO-Link Master's Modbus/TCP interface waits for a response to an ISDU request. The timeout needs to set long enough to allow all commands within the ISDU request to be processed. Valid range: 1-10,000 seconds
<i>Process Data Settings</i>	
PDI Data Block Size <i>Default: 36-bytes</i>	The configurable PDI data block length. Optional lengths are: 4-bytes (header only) 8-bytes (4 bytes data) 16-bytes (12 bytes data) 24-bytes (20 bytes data) 36-bytes (32 bytes data)
PDI Byte-Swap Method <i>Default: No byte-swap</i>	If enabled, the IO-Link Master swaps the data bytes in word (2 bytes) format or dword (4 bytes) format. Options include: No byte-swap – data passed through as received Word (16-bit) byte-swap – data is byte-swapped in wordformat Dword (32-bit) byte-swap – data is byte-swapped in dwordformat Reverse registers – data passed through after being reversed <i>Note: Because both IO-Link and Modbus/TCP use big-endian byte ordering, byte swapping typically is not required for word and dword data. Byte swapping is most commonly required when receiving byte (8-bit) data and it is desired to place the first data byte in the least significant byte position of the holding register. For these cases, word (16 bit) byte-swap is typically used.</i>
Include Digital I/O in PDI Data Block <i>Default: False</i>	If enabled, the IO-Link Master includes the current digital I/O pins D1 to D4 status in the PDI data block header. False – Do not include the digital I/O pins status True (enable check box) – Include the digital I/O pins status in the PDI data block header <i>Note: Does not affect the Auxiliary Input.</i>
PDO Data Block Size (From PLC) <i>Default: 32-bytes</i>	The configurable PDO data block length. Optional lengths are Event code not included: 4-bytes = 2 data words 8-bytes = 4 data words 16-bytes = 8 data words 24-bytes = 12 data words 32-bytes = 16 data words 34-bytes = 16 data words, 1 pad word Event code included: 4-bytes = event code word, 1 dataword 8-bytes = event code word, 3 data words 16-bytes = event code word, 7 data words 24-bytes = event code word, 11 data words 32-bytes = event code word, 15 data words 34-bytes = event code word, 16 data words
PDO Byte-Swap Method <i>Default: No byte-swap</i>	If enabled, the IO-Link Master swaps the data bytes in word (2 bytes) format or dword (4 bytes) format. Options include: No byte-swap – data passed through as received Word (16-bit) byte-swap – data is byte-swapped in wordformat Dword (32-bit) byte-swap – data is byte-swapped in dwordformat Reverse registers – data passed through after being reversed <i>Note: Because both IO-Link and Modbus/TCP use big-endian byte ordering, byte swapping typically is not required for word and dword data. Byte swapping is most commonly required when sending byte (8-bit) data to the IO-Link device and it is desired to send the least significant byte of the holding register first. For these cases, word (16 bit) byte-swap is typically used.</i>
Append PDO to PDI Data <i>Default: False</i>	If selected, the IO-Link Master appends any PDO data to the end of the PDI data. False = Do not append PDO data True (enable check box) = Append PDO data
Clear Event Code in PDO Block <i>Default: False</i>	If enabled, the IO-Link Master expects the first word of the PDO block to be used for event code handling. Values are: True (enable check box) = expect event code False = no event code, expect only PDO data

Modbus/TCP Settings Page	
Clear Event Code After Hold Time <i>Default: True</i>	If enabled, the IO-Link Master clears any event code reported in the PDI data block after the Event Active Hold Time. Values are: True (enable check box) = clear event code after hold time False = do not clear event code after the hold time
Active Event Hold Time <i>Default: 1000 ms</i>	If Clear Event Code After Hold Time is enabled, the time period an event code is reported in the PDI block before it is cleared. Valid range: 1-65535 Valid Units are: ms (milliseconds) sec (seconds) min (minutes) hours days
Event Hold Time Units	Valid Units: ms (milliseconds) sec (seconds) min (minutes) hours days
Clear Event Hold Time <i>Default: 500 ms</i>	Once an event code has been cleared, the time an event code stays cleared in the PDI block before another event code can be reported. Valid range: 1-65535 Valid Units: ms (milliseconds) sec (seconds) min (minutes) hours days
Event Clear Time Units	Valid Units: ms (milliseconds) sec (seconds) min (minutes) hours days
Include Digital Output(s) in PDO Data Block <i>Default: False</i>	If enabled, the IO-Link Master expects the digital output settings to be included in the PDO data block. False – The digital pin setting(s) are not included in the PDO data block True (enable check box) – The digital pin setting(s) are included in the PDO data block
Transfer Mode Settings	
Slave Mode Device ID <i>Default: 1</i>	The Modbus Device ID was used to access this IO-Link port. Range: 1-247
PDI Receive Mode(s) <i>Default: Slave</i>	Determines which PDI Receive (To PLC) Modes are enabled. The selectable modes are: <i>Slave</i> <i>Master</i>
PDO Transmit Mode <i>Default: Slave</i>	Selectable Modes are: <i>Disabled</i> <i>Slave</i> <i>Master</i>
Modbus Master PLC IP Address	The IP address of the Modbus slave.
Modbus Master PLC Device ID (1-247) (Default: 1)	The Modbus Device ID was used to access the slave.
Modbus Master PLC PDI Data Address (base 1) (1-65535) (Default: 1)	The address of the slave's PDI (determined by the slave).
Modbus Master PLC Max Update Rate (0-10000) (Default: 0)	How often to write PDI to the slave.
Modbus Master PLC PDO Data Address (base 1) (1-65535) (Default: 1)	The address of the slave's PDO (determined by the slave).
Modbus Master PLC Poll Rate (40- 65535) (Default: 40)	How often to read PDO from the slave.

6.5 OPC UA Settings Configuration Page

Use the **Configure | OPC UA Settings** page to configure OPC UA with the IOLM.

Note: Not all models support OPC UA.

This subsection includes these topics:

- Edit OPC UA Settings (Section 6.5.1)
- OPC UA Settings Parameters (Section 6.5.2)

Figure 45: OPC UA Configuration Page

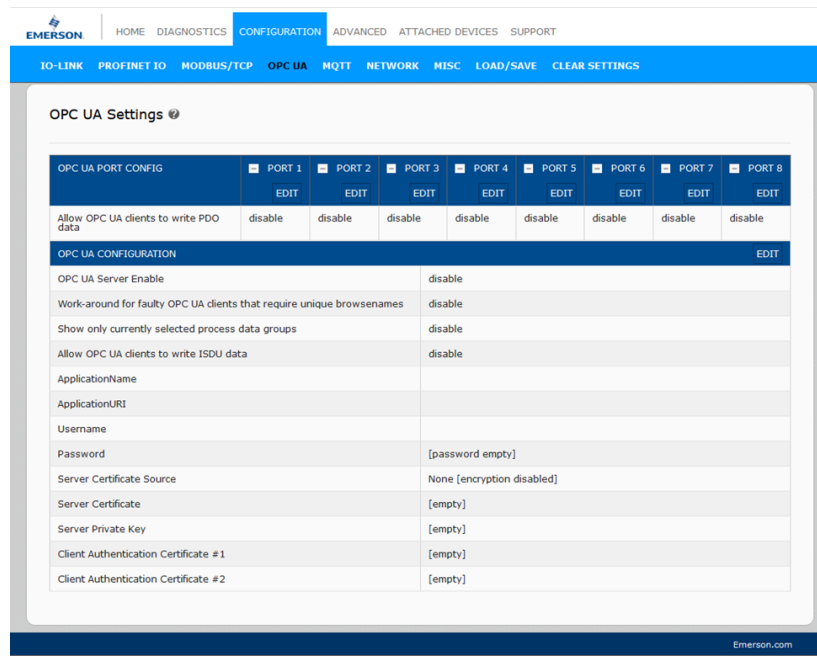

Note: OPC UA is disabled by default.

6.5.1 Edit OPC UA Settings

You can use this procedure to edit OPC UA settings.

1. If necessary, open the IO-Link Master web interface with your web browser using the IP address.
2. Click Configuration | OPC UA.
3. Click the **EDIT** button.

Figure 46: OPC UA Settings

1. Make the appropriate selections for your environment. You can use the help system if you require definitions or values for the options or 6.5.2 *OPC UA Settings Parameters*.
2. Click the **SAVE** button.

6.5.2 OPC UA Settings Parameters

The following table provides information about the **OPC UA Setting** page.

Option	OPC UA Configuration Descriptions
OPC UA Port CONFIG	
Allow OPC UA clients to write PDO data (Default = disable)	Determines whether OPC UA clients are allowed to write PDO data to the IO-Link devices.
OPC UA CONFIGURATION	
OPC UA Server Enable (Default = disable)	This option controls whether or not the OPC UA server runs on the IO-Link Master.
Work-around for faulty OPC UA clients that require unique browsenames (Default = disable)	Enables an alternative set of browsenames where each node's browsename is unique. Normally only browsepaths are required to be unique.
Allow OPC UA clients to write ISDU data (Default = disable)	Determines whether OPC UA clients are allowed to write ISDU data to the IO-Link devices.

Section 7: Configuring IO-Link Devices

This section discusses using the **Attached Devices | Port** pages to change IO-Link device parameters.

Note: Optionally, you can use traditional methods such as: PLC interfaces or HMI/SCADAs, depending on your protocol to configure the IO-Link devices.

7.1 Port Pages Overview

You can use the **Attached Devices | Port** page for a port to review and easily edit the IO-Link device configuration or view Process Data.

Figure 47: Attached Devices | Port

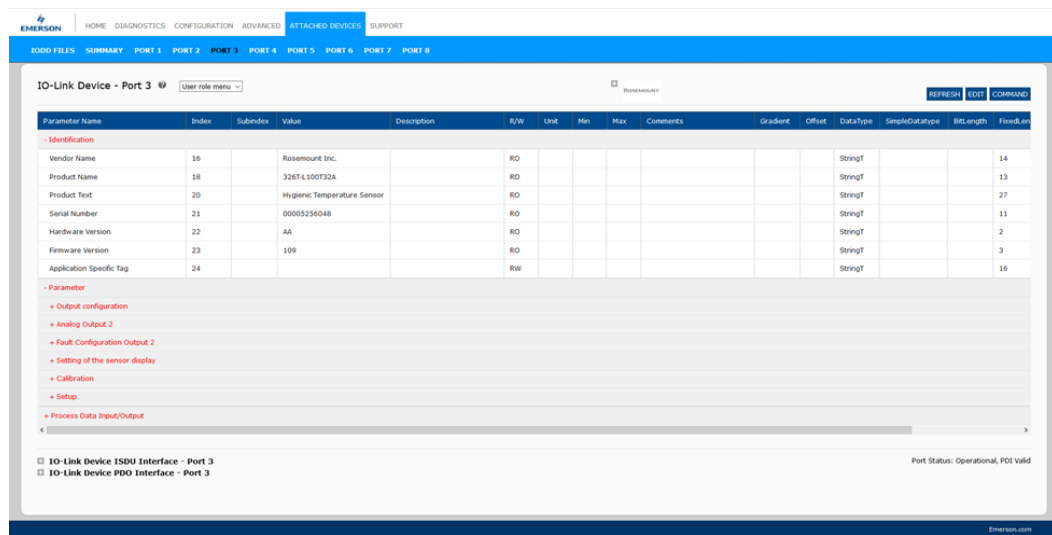

The **Port** page provides two IO-Link device configuration methods:

- **IO-Link Device Port** table (GUI), which depends on the appropriate IODD file loaded from the IO-Link device manufacturer onto the IOLM. To use the **IO-Link Device Port** table for configuring IO-Link devices, refer to the following subsections:
 - Editing Parameters - IO-Link Device - Port Table on Page 127
 - Resetting IO-Link Device Parameters to Factory Defaults on Page 128
- **IO-Link Device ISDU Interface - Port**, which can be used with or without IODD files loaded. Refer to the following information to use the **IO-Link Device ISDU Interface - Port** method:
 - The *IO-Link Device Operator Manual* from the device manufacturer is needed to use the **IO-Link Device ISDU Interface** since the ISDU block index and ISDU sub-index numbers are required.
 - Editing Parameters - IO-Link Device ISDU Interface - Port on Page 130

The **IO-Link Device Port** table provides detailed information about the indexes and sub-indexes. Not all indexes have sub-indexes.

Figure 48: IO-Link Device Port Table

Parameter Name	Index	Subindex	Value	Description	R/W	Link	Min	Max	Comments	Gradient	Offset	Data Type	SimpleOutputType	BitLength	Fixed
- Identification															
Vendor Name	16		Rosemount Inc.		RO							StringT		14	
Product Name	18		326T-L100T32A		RO							StringT		13	
Product Text	20		Hygienic Temperature Sensor		RO							StringT		27	
Serial Number	21		00005256048		RO							StringT		11	
Hardware Version	22		AA		RO							StringT		2	
Firmware Version	23		109		RO							StringT		3	
Application Specific Tag	24				RW							StringT		16	
- Parameter															
- Output configuration															
io2	65	1		1 / Analog signal 4...20 mA 2 / Analog signal 20...4 mA	RW		1	10	value range: 1:10			IntegerT		8	
- Analog Output 2															
- Analog Output 2															
ASP2	66		0.0	-58.0~293.0	RW	*F	-58.0	293.0	value range: -58.0~293.0	0.1	0	IntegerT		16	
AEP2	67		300.0	-49.0~302.0	RW	*F	-49.0	302.0	value range: -49.0~302.0	0.1	0	IntegerT		16	
- Fault Configuration Output 2															

- If the IODD file follows IO-Link specifications, an asterisk next to RW means that parameter is not included in Data Storage.
- If a Sub-index has an asterisk next to it in the GUI, that means that sub-index is not sub-indexable. This may be useful information when using the IO-Link Device ISDU Interface or programming your PLC.

This example shows that Index 21.

When you perform a **GET** on Index 21 using the ISDU Interface, these are the results:

Figure 49: Get command on Index 21

IO-Link Device ISDU Interface - Port 3

ISDU Block Index:

ISDU Sub-index:

30 30 30 30 35 32 35 36 30 34 38

The GUI displays this information about Index 21.

Figure 50: Index 21 Information

Parameter Name	Index	Subindex	Value
- Identification			
Vendor Name	16		Rosemount Inc.
Product Name	18		326T-L100T32A
Product Text	20		Hygienic Temperature Sensor
Serial Number	21		00005256048

Figure 51: Process Data

Parameter Name	Index	Subindex	Value	Description	R/W	Unit	Min	Max	Comments	Gradient	Offset	DataType	SimpleDataType	BitLength	FixedLength
- Identification															
Vendor Name	16		Rosemount Inc.		RO							StringT			14
Product Name	18		3287L100732A		RO							StringT			13
Product Text	20		Hygienic Temperature Sensor		RO							StringT			27
Serial Number	21		00005256048		RO							StringT			11
Hardware Version	22		AA		RO							StringT			2
Firmware Version	23		109		RO							StringT			3
Application Specific Tag	24				RW							StringT			16
- Parameter															
- Output configuration															
ou2	65		1	1:1 / Analog signal 4...20 mA 10:INEG / Analog signal 20... 4 mA	RW		1	10	value range:1:10			UIntegerT			8
- Analog Output 2															

This shows a typical Process Data page.

Figure 52: Process Data

Parameter Name	Value	Description	DataType	SimpleDataType	BitLength	BitOffset	FixedLength
- Process Data							
- Process Data Input/Output							
Temperature	786	-580-3020	RecordT	IntegerT	16	0	

IO-Link Device ISDU Interface - Port 3
IO-Link Device PDO Interface - Port 3

Port Status: Operational, PDI Valid

If the correct IODD file has not been loaded or the IO-Link device does not support PDO, then you will receive this message.

Figure 53: Missing IODD File

IO-Link Device - Port 1

Parameter Name | Value | Description | DataType | SimpleDataType | BitLength | BitOffset | FixedLength

IO-Link Device ISDU Interface - Port 1

Port Status: Operational, PDI Valid, PDO Invalid

No Process Data

Unable to load the Process Data! Make sure the attached IO-Link device is supported and the corresponding IODD file is loaded.

OK

7.2 Editing Parameters - IO-Link Device - Port Table

Use the following procedure to edit IO-Link device parameters using the **IO-Link Device Port** table.

Note: You may want to verify that the **Automatic Download Enable for Data Storage** option on the **Configuration | IO-Link Settings** page is **NOT** set to **On** as this can cause unreliable results on the corresponding port.

1. If you have not done so, load the IODD file from the IO-Link device manufacturer ()
2. Access the appropriate **Port** page by clicking **Attached Devices** and then the **Port** number that you want to configure.
3. Click the **EDIT** button after all of the device information is populated in the table.
4. Scroll down the table and make appropriate parameter changes for your environment.

Note: An IODD file may not contain all IO-Link device settings depending on the IO-Link device manufacturer. If you need to change a parameter that is not displayed in the **IO-Link Device-Port** table, you can refer to the IO-Link Device Operators Manual and use the **IO-Link Device ISDU Interface** to change the settings.

You may need to scroll to the right in the table to view applicable parameter values if the parameter is not selectable in a drop list.

Figure 54:

Parameter Name	Index	Subindex	Value	Description	R/W	Unit	Min	Max	Comments	Gradient	Offset	DataType	SimpleDataType	BitLength	Field
Identification															
Vendor Name	16		Rosemount Inc.		RO							StringT		14	
Product Name	18		3265L100T32A		RO							StringT		13	
Product Text	20		Hygienic Temperature Sensor		RO							StringT		27	
Serial Number	21		00003256048		RO							StringT		11	
Hardware Version	22		AA		RO							StringT		2	
Firmware Version	23		109		RO							StringT		3	
Application Specific Tag	24		test		RW							StringT		16	
Parameter															
Output configuration															
ou2	65		1	1 / Analog signal 4...20 mA 2 / Analog signal 0...4 mA	RW		1	10	value range:1:10			Integer		8	
<ul style="list-style-type: none"> • Analog Output 2 • Fault Configuration Output 2 • Setting of the sensor display • Calibration • Setup 															

5. Click the **SAVE** button after editing the parameters.

7.3 Resetting IO-Link Device Parameters to Factory Defaults

In the event you want to reset the IO-Link device to factory default, typically the IODD file provides the ability from the IO-Link device manufacturer. Use the following example to reset an IO-Link device.

1. Click the **COMMAND** button and locate the **Restore Factory** button.
2. Click the Restore Factory or Load Factory Settings button.

Note: The name of the button is determined by the IO-Link device manufacturer.

Figure 55: Restore Factory Settings

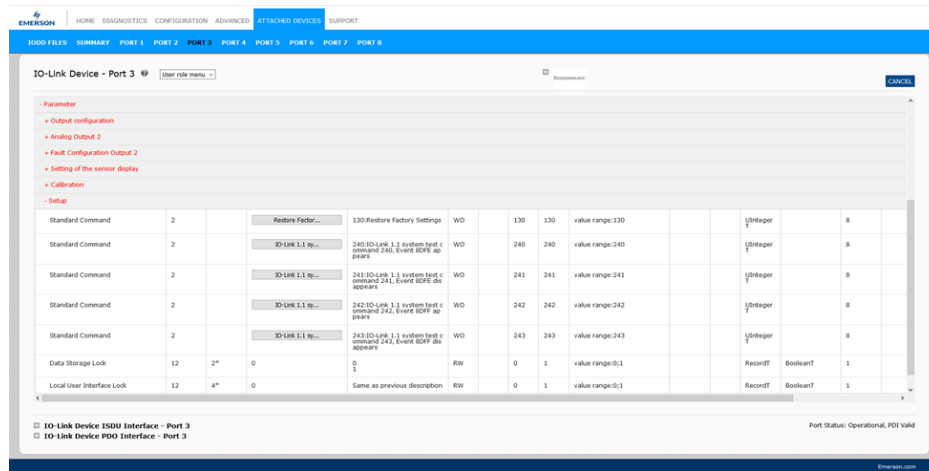

3. Click **OK** when the *Refresh?* message appears.

Figure 56: Refresh

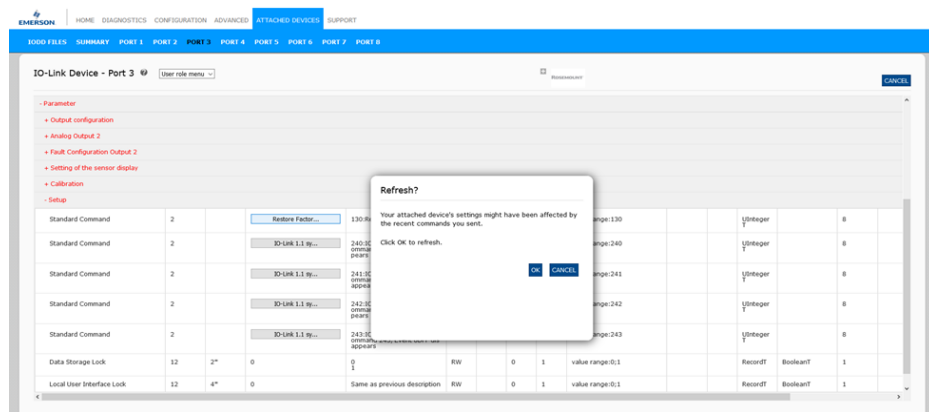

7.4 Editing Parameters - IO-Link Device ISDU Interface - Port

The IO-Link Device ISDU Interface follows these guidelines:

- If necessary, convert hexadecimal ISDU index numbers to decimal, you must enter the decimal value for the ISDU Block Index and ISDU Sub-index numbers.
- You must enter the hexadecimal value for the IO-Link device parameters.

If the appropriate IODD files have been loaded, you can use the **IO-Link Device-Port** table to determine the index numbers and acceptable values for each parameter.

Note: An IODD file may not contain every IO-Link device setting depending on the IO-Link device manufacturer. If you need to change a parameter that is not displayed in the **IO-Link Device-Port** table, you can refer to the IO-Link Device Operators Manual.

If an IODD file has not been loaded for an IO-Link device, you can use the *IO-Link Device Operator's Manual* to determine the ISDU indexes.

7.4.1 Overview

The following provides some basic information about the command usage and responses when using the ISDU Interface.

1. You must enter the decimal value for the ISDU Block Index and ISDU Sub-index.
2. The **GET** button retrieves the parameter value in hex from the IO-Link device. You may want to retrieve values to determine the data length.

Figure 57: Response from GET

The screenshot shows the 'IO-Link Device ISDU Interface - Port 3' window. On the left, there are two input fields: 'ISDU Block Index' with the value '22' and 'ISDU Sub-index' which is empty. Below these fields are two buttons: 'GET' and 'SET'. On the right, a text area displays the response '41 41'.

3. The **SET** button sends the value to the IO-Link device.

Figure 58: SET button sends the value to the IO-Link Device

The screenshot shows the 'IO-Link Device ISDU Interface - Port 3' window. The 'ISDU Block Index' field contains '22' and the 'ISDU Sub-index' field is empty. The 'GET' and 'SET' buttons are visible. The text area on the right displays the error message 'other failure (write)'.

The screenshot shows the 'IO-Link Device ISDU Interface - Port 3' window. The 'ISDU Block Index' field contains '24' and the 'ISDU Sub-index' field is empty. The 'GET' and 'SET' buttons are visible. The text area on the right displays the response '31 32 00 00 00 00 00 00 00 00 00 00 00 00 00 00'.

- After successfully changing a parameter, the IO-Link Master responds with a command executed notification.

Figure 59: IO-Link Master Response

IO-Link Device ISDU Interface - Port 3

ISDU Block Index:

ISDU Sub-index:

GET

SET

command executed

- This message means that the IO-Link device defines the entry as an invalid setting.

Figure 60: Invalid Setting Error

IO-Link Device ISDU Interface - Port 3

ISDU Block Index:

ISDU Sub-index:

GET

SET

other failure (read)

7.4.2 How to Use the Interface

Use the following procedure to edit parameters using the **IO-Link Device ISDU Interface - Port**.

Note: You may want to verify that the **Automatic Download Enable for Data Storage** option on the **Configuration | IO-Link Settings** page is NOT set to **On** as this can cause unreliable results on the corresponding port.

- Click the **+** next to the **IO-Link Device ISDU Interface** to open the interface.

Figure 61: IO-Link Device

IO-Link Device - Port 3 User role menu ROSEMOUNT REFRESH EDIT COMMAND

Parameter Name	Index	Subindex	Value	Description	R/W
- Identification					
Vendor Name	16		Rosemount Inc.		RO
Product Name	18		326T-L100T32A		RO
Product Text	20		Hygienic Temperature Sensor		RO
Serial Number	21		00005256048		RO
Hardware Version	22		AA		RO
Firmware Version	23		109		RO
Application Specific Tag	24				RW
- Parameter					
+ Output configuration					
+ Analog Output 2					

IO-Link Device ISDU Interface - Port 3 Port Status: Operational, PDI Valid

IO-Link Device PDO Interface - Port 3

Emerson.com

- Enter the ISDU Block Index number (decimal) that you want to edit.
- If applicable, enter the ISDU Sub-index (decimal).

- Edit the parameter (hex) and click the **SET** button.

Figure 62: Parameter HEX

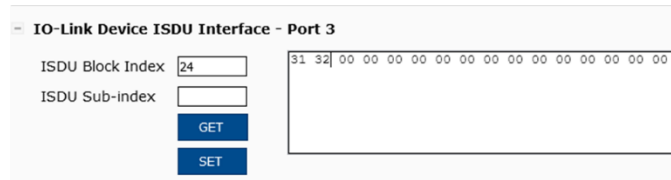

- Verify that a *command executed* message returns.
- If the IODD file is loaded, optionally click **REFRESH** to verify your changes.

Figure 63: Refresh

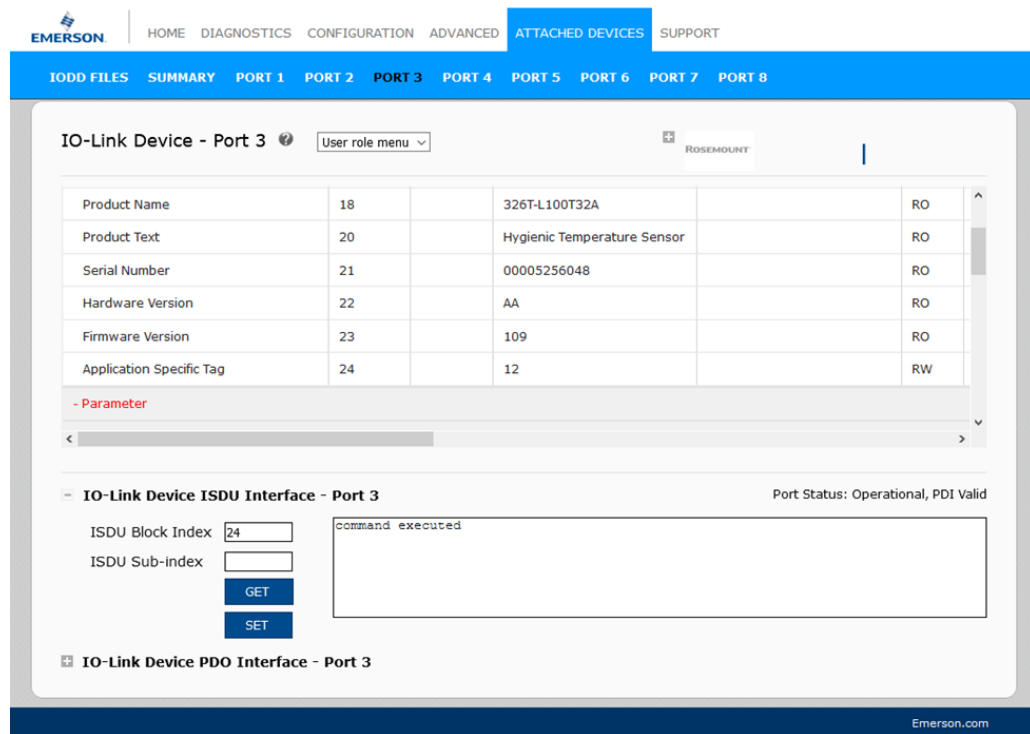

Section 8: Utilizing IOLM Features

This section discusses using the following features:

1. Setting User Accounts and Passwords
2. *Data Storage* which provides automatic and manual data storage to upload or download IO-Link v1.1 device parameters
3. *Device Validation* which supports identical or compatible device validation to dedicate a port or ports to specific IO-Link devices
4. *Data Validation* which supports strict or loose data validation to verify data integrity
5. *IOLM Configuration Files* that supports a method to back up configuration files or load the same configuration to multiple IOLM units
6. *Configuring Miscellaneous Settings* which provides the following options:
 - a. *Using the Menu Bar Hover Shows Submenu Option*
 - b. *Enable PDO Write From Attached Devices Port Page*
 - c. *IO-Link Test Event Generator*
7. *Clearing Settings* which allows you to reset the IOLM to factory default values

Note: You must configure data storage, device validation, data validation in PROFINET IO using PAC Machine Edition. You can use data stored on the web page for temporary data storage-related tasks.

8.1 Setting User Accounts and Passwords

The IOLM is shipped from the factory without passwords. See the following table if you want to see how permissions are granted.

Page	Admin	Operator	User
Log-in	Yes	Yes	Yes
Home	Yes	Yes	Yes
Diagnostics - All	Yes	Yes	Yes
Configuration - IO-Link Settings	Yes	Yes	View-only
Configuration - Modbus/TCP	Yes	Yes	View-only
Configuration - PROFINET IO	Yes	Yes	View-only
Configuration - OPC UA	Yes	Yes	View-only
Configuration - Network	Yes	View-only	No
Configuration - Misc	Yes	Yes	Yes
Configuration - Load/Save	Yes	Yes	View-only
Configuration - Clear Settings	Yes	No	No
Advanced - Software	Yes	No	No
Advanced - Accounts	Yes	No	No
Advanced - Log Files	Yes	Yes	Yes
Advanced - Licenses	Yes	Yes	Yes
Attached Devices - IO-Link Device Description Files	Yes	Yes	View-only
Attached Devices - IO-Link Device Configuration Summary	Yes	Yes	View-only
Attached Devices - IO-Link Device - Port	Yes	Yes	View-only

You can use this procedure to set up passwords for the IOLM.

1. Open your browser and enter the IOLM IP address.
2. Click **Advanced | ACCOUNTS**.

Figure 64: Accounts

1. Click the **ADMIN** check box.
2. If applicable, enter the old password in the **Old Password** text box.
3. Enter the new password in the **New Password** text box.
4. Re-enter the password in the **Confirm Password** text box.
5. Optionally, click the **Operator** check box, enter a new password, and re-enter the password in the **Confirm Password** text box.
6. Optionally, click the **User** check box, enter the new password, and re-enter the password in the **Confirm Password** text box.
7. Click **Apply**.
8. Close the new window that displays a *Password saved* banner.
9. Click the **Log out** button on the top navigation bar.
10. Re-open the web interface by selecting the appropriate user type in the drop list and entering the password.

8.2 Data Storage

Data storage is typically supported by IO-Link v1.1 devices. *Data storage* means that you can upload parameters from an IO-Link device to the IOLM and/or download parameters from the IOLM to the IO-Link device. This feature can be used to:

1. Quickly and easily replace a defective IO-Link device
2. Configure multiple IO-Link devices with the same parameters as fast as it takes to connect and disconnect the IO-Link device

To determine whether an IO-Link (v1.1) device supports data storage, you can check one of the following:

- **IO-Link Diagnostics** page - check the **Data Storage Capable** field to see if it displays **Yes**.
- **IO-Link Configuration** page - check to see if **UPLOAD** and **DOWNLOAD** buttons display under the **Data Storage Manual Ops** group. If only a **Clear** button displays, the device on the port does not support data storage.

Although you can make configuration changes using the web page, PROFINET IO configuration parameters overwrite the values on the *IO-Link Settings* page. See *IO-Link Port Settings (IO-Link Port Module Parameters)* for PROFINET IO configuration procedures.

8.2.1 Uploading Data Storage to the IOLM

The IO-Link device manufacturer determines which parameters are saved for data storage. Remember, the IO-Link device should be configured before enabling data storage unless you are using data storage to back up the default device configuration.

There are two methods to upload Data Storage using the **Configuration | IO-Link** page:

- **Automatic Enable Upload** - If a port is set to **On** for this option, the IOLM saves the data storage parameters (if the data storage is empty) from the IO-Link device to the IOLM.
- When this option is enabled and another IO-Link device (different Vendor ID and Device ID), the **IO-Link Diagnostics** page displays a *DS: Wrong Sensor* in the **IOLink State** field, and the IO-Link port LED flashes red, indicating a hardware fault.
- Automatic upload occurs when the **Automatic Upload Enable** option is set to **On** and one of these conditions exists:
 - There is no upload data stored on the gateway and the IO-Link device is connected to the port.
 - The IO-Link device has the **DS upload** bit on; generally because you have changed the configuration through Teach buttons or the web interface.

Note: Not all device parameters are sent to data storage. The IO-Link device manufacturer determines what parameters are sent to data storage.

- **Data Storage Manual Ops: UPLOAD** - Selecting the **UPLOAD** button saves the data storage from the IO-Link device to the IOLM. The contents of the data storage do not change unless it is uploaded again or cleared. Another IO-Link device with a different Vendor ID and Device ID can be attached to the port without causing a hardware fault.

8.2.2 Downloading Data Storage to the IO-Link Device

There are two methods to download Data Storage using the **Configuration | IO-Link Device** page:

- **Automatic Download Enable** - An automatic download occurs when the **Automatic Download Enable** option is set to **On** and one of these conditions exists:
 - The original IO-Link device is disconnected and an IO-Link device whose configuration data differs from the stored configuration data.
 - The IO-Link device requests an upload and the **Automatic Upload Enable** option is set to **Off**.

Note: Do not enable both Automatic Upload and Download at the same time, the results are not reliable *among IO-Link device manufacturers*.

- **Data Storage Manual Ops: DOWNLOAD** - Selecting the **DOWNLOAD** button downloads the data storage from that port to the IO-Link device.

If an IO-Link device with a different Vendor ID and Device ID is attached to the port and a manual download is attempted, the IOLM issues a hardware fault.

8.2.3 Automatic Device Configuration

Use the following steps to use an IOLM port to configure multiple IO-Link devices with the same configuration parameters.

Note: You must configure data storage in PROFINET IO using PAC Machine Edition. You can use data storage on the web page for temporary data storage-related tasks.

1. If necessary, configure the IO-Link device as required for the environment.
2. Click Configuration | IO-Link.
3. Click the **EDIT** button for the port for which you want to store the data on the IOLM.
4. Click the **UPLOAD** button.
5. Click the **CONTINUE** button to the *Continue to upload the data storage on the IO-Link Master port [number]* message.

Figure 65: Upload

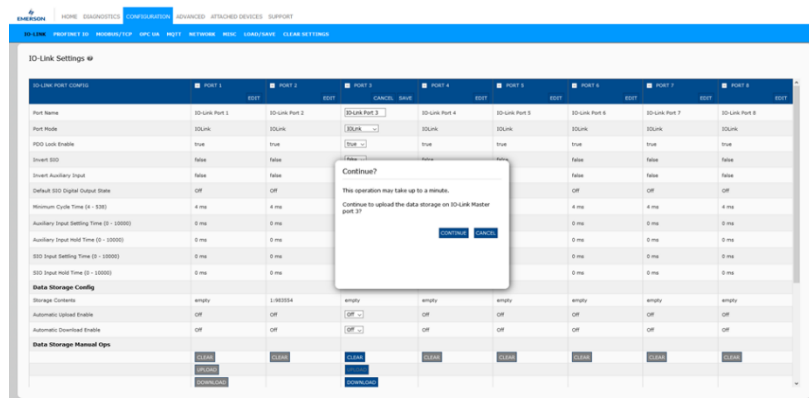

6. Click the **OK** button to the Data storage upload successfully on the Port [number] message.
7. Set the Automatic Download Enable option to On.

Figure 66: Enable Automatic Download

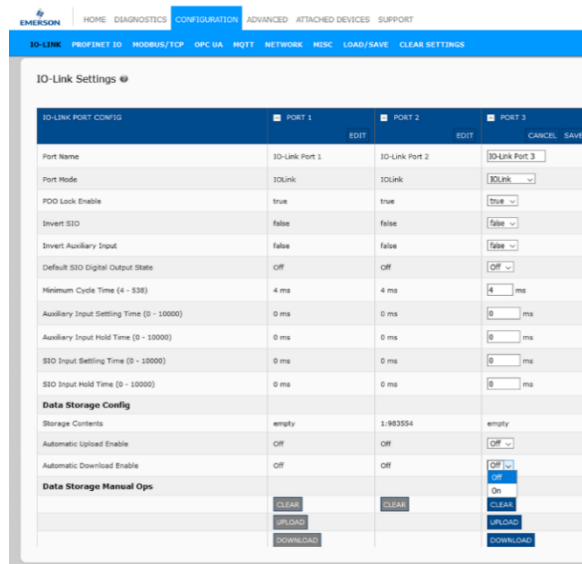

8. Click **SAVE**.
9. Click Diagnostics | IO-Link.
10. Replace the IO-Link device on that port with the IO-Link device for which you want to be configured automatically.
11. Verify that the IO-Link device displays operational **Port Status** and the appropriate IO-Link State.
12. Repeat Steps 10 and 11 for as many devices as you want to configure.

8.2.4 Automatic Device Configuration Backup

The following procedure shows how to utilize data storage to automatically backup an IO-Link device configuration.

Note: You must configure data storage in PROFINET IO using PAC Machine Edition. You can use data storage on the web page for temporary data storage-related tasks.

Remember, if you adjust parameters using **Teach** buttons those values may or not may be updated in the data storage, which depends on the IO-Link device manufacturer. If you are unsure, you can always use the manual **UPLOAD** feature to capture the latest settings.

1. Click Configuration | IO-Link.
2. Click the EDIT button for the port for which you want to store the data on the IOLM.
3. Select On in the drop list for Automatic Data Storage Upload Enable.

Figure 67: Automatic Data Storage Upload

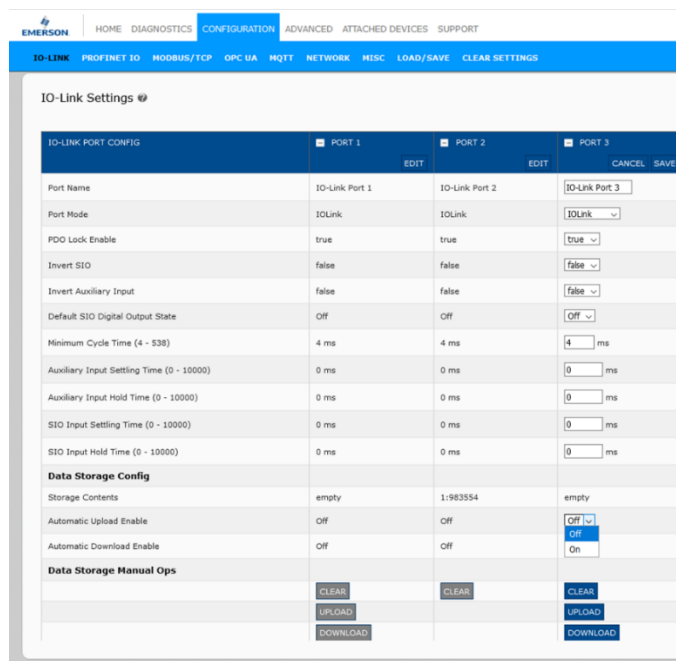

4. Click **SAVE**.

When the Configuration | IO-Link page is refreshed, the Storage Contents field displays the Vendor ID and Device ID. In addition, the IO-Link Diagnostics page displays Upload-Only in the Automatic Data Storage Configuration field.

8.3 Device Validation

Device validation is supported by many IO-Link devices. **Device Validation Mode** provides these options:

- **None** - Disables Device Validation Mode
- **Compatible** - Permits a compatible IO-Link device (same Vendor ID and Device ID) to function on the corresponding port. **Note:** When set to Compatible, the IO-Link master module will detect the connected IO-Link device and if the device and vendor ID matches, will operate with the configured settings. This option would be beneficial when user need to replace the faulty device.
- **Identical** - Permits an IO-Link device (same Vendor ID, Device ID, and serial number) to function on the corresponding port.

Although you can make configuration changes using the web page, PROFINET IO configuration parameters overwrite the values on the *IO-Link Settings* page. See *IO-Link Port Settings (IO-Link Port Module Parameters)* for PROFINET IO configuration procedures.

Use this procedure to configure device validation.

1. Click **Configuration | IO-Link Settings**.
2. Click the **EDIT** button.
3. Select Compatible or Identical for the Device Validation mode.

Note: Identical Device Validation requires a device serial number to operate.

4. Click the **GET ATTACHED** button or manually complete the Vendor ID, Device, ID, and serial number.
5. If the device does not have a serial number, you should not select **Identical** because the IOLM requires a serial number to identify a specific device.

Figure 68: GET ATTACHED Button

IO-LINK PORT CONFIG	PORT 1	PORT 2	PORT 3
	<input type="button" value="EDIT"/>	<input type="button" value="EDIT"/>	<input type="button" value="CANCEL"/> <input type="button" value="SAVE"/>
Port Name	IO-Link Port 1	IO-Link Port 2	IO-Link Port 3
Port Mode	IOLink	IOLink	IOLink
PDO Lock Enable	true	true	true
Invert SIO	false	false	false
Invert Auxiliary Input	false	false	false
Default SIO Digital Output State	Off	Off	Off
Minimum Cycle Time (4 - 538)	4 ms	4 ms	4 ms
Auxiliary Input Settling Time (0 - 10000)	0 ms	0 ms	0 ms
Auxiliary Input Hold Time (0 - 10000)	0 ms	0 ms	0 ms
SIO Input Settling Time (0 - 10000)	0 ms	0 ms	0 ms
SIO Input Hold Time (0 - 10000)	0 ms	0 ms	0 ms
Data Storage Config			
Storage Contents	empty	1:983554	empty
Automatic Upload Enable	Off	Off	Off
Automatic Download Enable	Off	Off	Off
Data Storage Manual Ops			
	<input type="button" value="CLEAR"/>	<input type="button" value="CLEAR"/>	<input type="button" value="CLEAR"/>
	<input type="button" value="UPLOAD"/>		<input type="button" value="UPLOAD"/>
	<input type="button" value="DOWNLOAD"/>		<input type="button" value="DOWNLOAD"/>
Validation Config			
Device Validation Mode	None	None	Identical
Vendor Id (0 - 65535)	0	0	0
Device Id (0 - 16777215)	0	0	0
Serial Num			
Data Validation Mode	None	None	None
PDI Length (0 - 32)	0 byte	0 byte	0 byte
PDO Length (0 - 32)	0 byte	0 byte	0 byte
	<input type="button" value="GET ATTACHED"/>	<input type="button" value="GET ATTACHED"/>	<input type="button" value="GET ATTACHED"/>

6. Click the **SAVE** button. If the wrong or incompatible device is connected to the port, the IO-Link port LED flashes red and no IO-Link activity occurs on the port until the issue is resolved.

In addition, the **IO-Link Diagnostics** page displays the following information:

Figure 69: IO-Link Diagnostics

IO-LINK PORT STATUS	PORT 1	PORT 2	PORT 3
Port Name	IO-Link Port 1	IO-Link Port 2	IO-Link Port 3
Port Mode	IO-Link	IO-Link	IO-Link
Port Status	Operational	Inactive	Operational, PDI Valid
IO-Link State	Operate	CommLost	Operate
Device Vendor Name	Banner Engineering Corporation		Rosemount Inc.
Device Product Name	K50L2		326T-L100T32A
Device Serial Number	20-10-0814:01:53		00005256048
Device Hardware Version	V00-01		AA
Device Firmware Version	2.0.28		109
Device IO-Link Version	1.1		1.1

8.4 Data Validation

You can use this procedure to configure data validation.

Although you can make configuration changes using the web page, PROFINET IO configuration parameters overwrite the values on the *IO-Link Settings* page. See *IO-Link Port Settings (IO-Link Port Module Parameters)* for PROFINET IO configuration procedures.

1. Click Configuration | IO-Link Settings.
2. Click the **EDIT** button on the port you want to configure for data validation.
3. Select **Loose** or **Strict** to enable data validation.
 - **Loose** - the slave device's PDI/PDO lengths must be less than or equal to the user-configured values.
 - **Strict** - the slave device's PDI/PDO lengths must be the same as the user-configured values.
4. Click the **GET ATTACHED** button or manually enter the PDI and PDO length.

Figure 70: Data Validation: Strict

Data Storage Manual Ops	PORT 1	PORT 2	PORT 3
	CLEAR	CLEAR	CLEAR
	UPLOAD		UPLOAD
	DOWNLOAD		DOWNLOAD
Validation Config			
Device Validation Mode	None	None	None ▾
Vendor Id (0 - 65535)	0	0	38
Device Id (0 - 16777215)	0	0	48
Serial Num			00005256048
Data Validation Mode	None	None	Strict ▾
PDI Length (0 - 32)	0 byte	0 byte	2 byte
PDO Length (0 - 32)	0 byte	0 byte	0 byte
	GET ATTACHED	GET ATTACHED	GET ATTACHED

5. Click the **SAVE** button.
6. If data validation fails, the IO-Link port LED flashes red and the **IO-Link Diagnostics** page displays an error.

8.5 IOLM Configuration Files

You can use the web interface to save or load IOLM configuration files.

Use one of the following procedures to save or load configuration files:

- Saving Configuration Files (Web Interface) (Section 8.5.1)
- Loading Configuration Files (Web Interface) (Section 8.5.2)

8.5.1 Saving Configuration Files (Web Interface)

Use this procedure to save configuration files for the IOLM. The configuration files include all port settings, network settings, and encrypted passwords.

1. Click **Configuration | Load/Save**.
2. Click the **SAVE** button.

Figure 71: Save Button

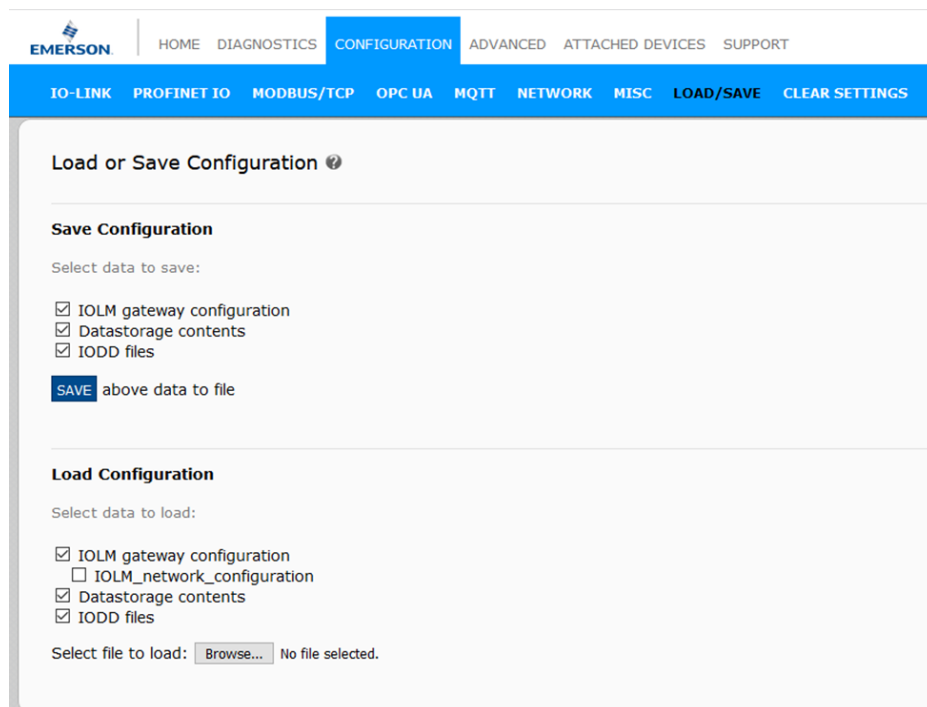

3. Click the **Save as** option and browse to the location that you want to store the configuration file.

8.5.2 Loading Configuration Files (Web Interface)

Use this procedure to load a configuration file onto the IOLM.

1. Click **Configuration | Load/Save**.
2. Click the **Browse** button and locate the configuration file (.dcz extension).
3. Click the **LOAD** button.

Figure 72: Load Configuration Files

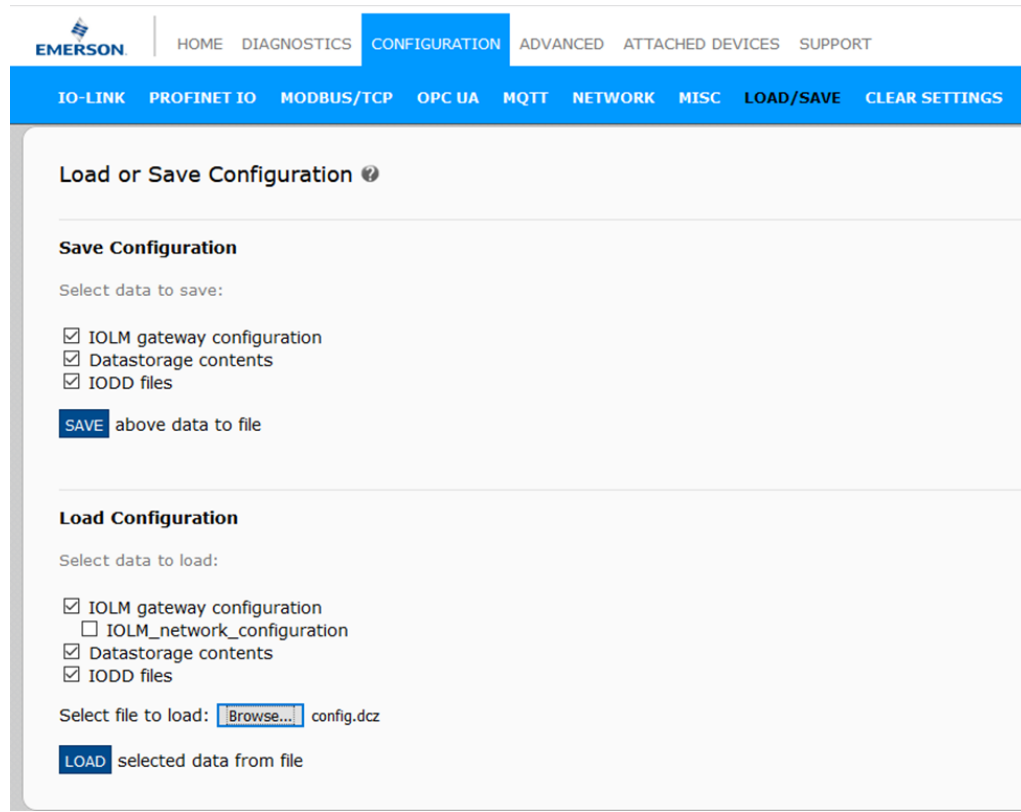

4. Click the **OK** button to close the *Configuration Uploaded* message that notifies you of what configuration parameters loaded.

8.6 Configuring Miscellaneous Settings

The **Miscellaneous Settings** page includes the following options:

Figure 73: Miscellaneous Settings Screen

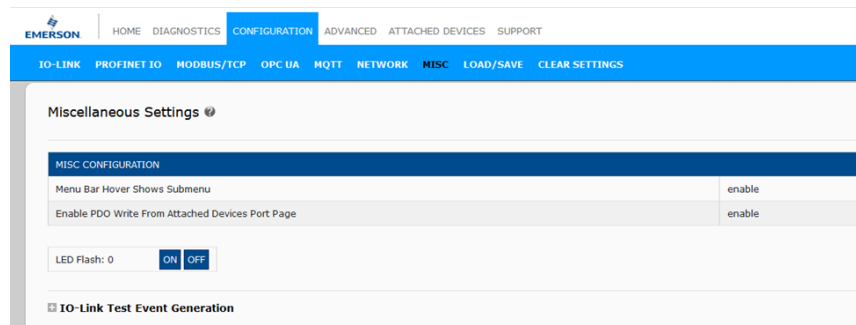

Menu Bar Hover Shows Submenu

This option displays sub-menus for a category when you hover over the category name.

For example, if you hover over **Advanced**, the **SOFTWARE**, **ACCOUNTS**, **LOG**

FILES, and **LICENSES** sub-menus display. You can click any sub-menu and avoid opening the default menu for a category.

Enable PDO Write From Attached Devices Port Page

When enabled, it allows you to write PDO data to IO-Link slaves from the **Attached Devices | Port** page in the web user interface. See [10.6.2. Enable PDO Write From Attached Devices Port Page](#) on Page 149 for more information.

Note: The PDO write will not allow writes if the IOLM has a PLC connection. **This should never be enabled in a production environment.**

LED Flash

You can force the IO-Link port LEDs on the IOLM into a flashing tracker pattern that allows you to easily identify a particular unit.

- Click the **ON** button to enable the LED tracker feature on the IOLM. The LEDs remain flashing until you disable the LED tracker feature
- Click the **OFF** button to disable the LED tracker.

8.6.1 Using the Menu Bar Hover Shows Submenu Option

Use this procedure to enable the **Menu Bar Hover Shows Submenu** option. If you enable this feature it displays the sub-menus for a category when you hover over the category name.

For example, if you hover over **Advanced**, the **SOFTWARE**, **ACCOUNTS**, **LOG FILES**, and **LICENSES** sub-menus display. You can click any sub-menu and avoid opening the default menu for a category.

1. Click **Configuration | MISC**.
2. Click the **EDIT** button.
3. Click **Enable** next to the Menu Bar Hover Shows Submenu option.
4. Click **SAVE**.

Figure 74:

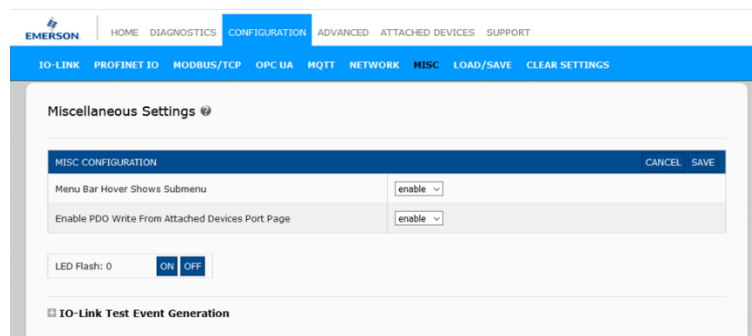

8.6.2 Enable PDO Write From Attached Devices Port Page

The purpose of this feature is for a **non-production** type of demonstration of the IOLM. You can enable this feature to get familiar with IO-Link or if you are commissioning a system and want to be able to test/get familiar with devices. It allows you to interact with a PDO device that does not have a PLC connection.

You must have set and signed into the IO-Link Master using an **admin** password.

Note: The PDO write will not allow writes if the IOLM has a PLC connection. **This should never be enabled in a production environment.**

Use this procedure to enable PDO to write from the **Attached Devices | Port** page.

1. If necessary, log into the IOLM using the Administrator account.
2. Click **Configuration | MISC**.
3. Click the **EDIT** button.
4. Click **Enable** next to the Enable PDO Write From Attached Devices Port Page option.
5. Click the **SAVE** button.
6. If this will not cause an unstable environment, click the **CONTINUE** button.

Figure 75: PDO Warning

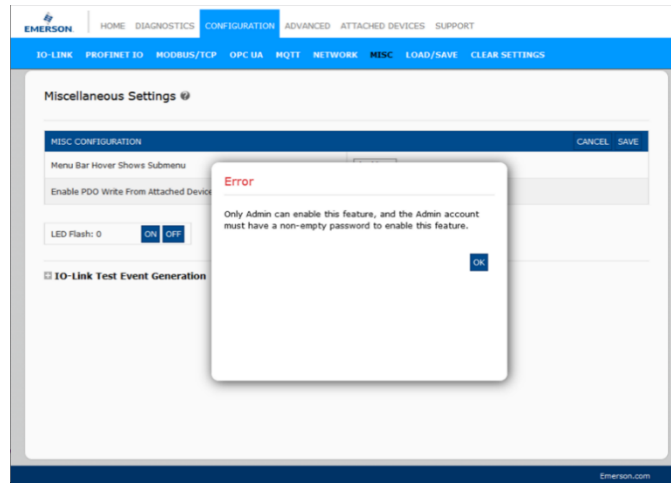

8.6.3 IO-Link Test Event Generator

You can use the **IO-Link Test Event Generator** to send messages to an IOLM port. The generated events are displayed in the **Diagnostics | IO-Link Settings** page under the **Last Events** field and the Syslog. This can test a port to verify that it is functioning correctly through

1. Click **Configuration | Misc.**
2. Expand the **IO-Link Test Event Generator**.

Figure 76: IO-Link Test Event Generator

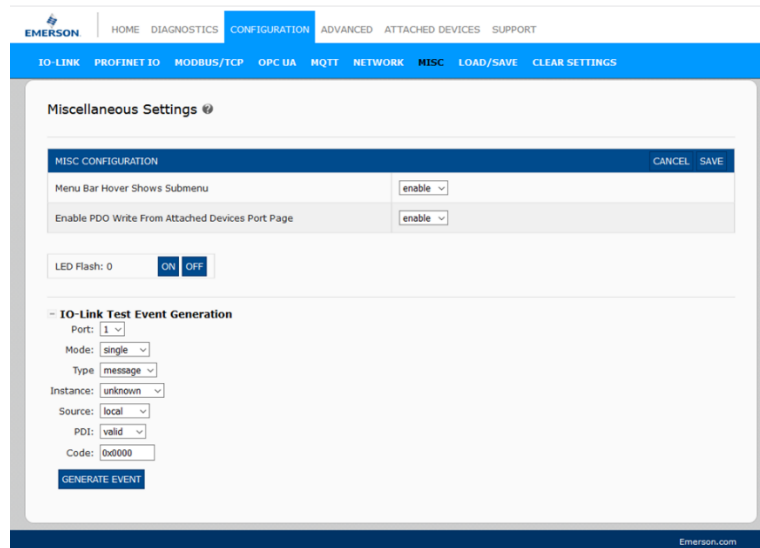

3. Select the port and type of event that you want to test.

Use the following table to determine what type of event you want to generate.

Figure 77: IO-Link Test Event Generation

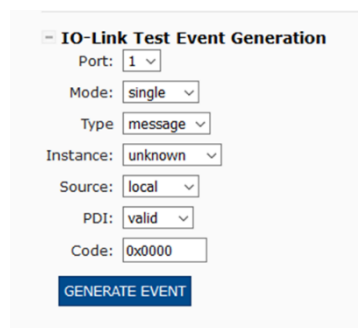

IO-Link Test Event Generator Descriptions	
Port	Port
Mode	Mode
Type	This is the second item in the event generated. Message: generates Message in the event. Warning: generates Warning in the event. Error: generates an Error in the event.
Instance	This is the level at which the event is generated. This is not displayed in the generated event. unknown physical datalink applayer application
Source	This is the source from which the event is generated. This is the third item in the generated event. local: simulation generated from the IOLM, which displays as Local in the event. remote: simulation of an IO-Link device event, which displays as Device in the generated event.
PDI	This indicates whether to send valid or invalid PDI, which is not displayed in the generated event. valid invalid
Code	This is the fourth and fifth items in the generated event. 0x0000: generates a s_pdu_check event 0x0001: generates a s_pdu_flow event 0x0002: generates a m_pdu_check event 0x0003: generates a s_pdu_illegal event 0x0004: generates a m_pdu_illegal event 0x0005: generates a s_pdu_buffer event 0x0006: generates a s_pdu_inkr event 0x0007: generates an s_pd_len event 0x0008: generates an s_no_pdin event 0x0009: generates an s_no_pdout event 0x000a: generates an s_channel event 0x000b: generates an m_event event 0x000c: generates an a_message event 0x000d: generates an a_warning event 0x000e: generates an a_device event 0x000f: generates an a_parameter event 0x0010: generates a devicelost event 0x0011, 13 - 17: generates an unknown event 0x0012: generates a s_desina event

- Click **Diagnostics** and scroll down to **Last Events**.

Figure 78: Diagnostics

The screenshot shows the 'IO-Link Diagnostics' page in the Emerson RSTi-OM interface. The page has a blue header with navigation tabs: HOME, DIAGNOSTICS (selected), CONFIGURATION, ADVANCED, ATTACHED DEVICES, and SUPPORT. Below the header is a sub-header with tabs: IO-LINK, PROFINET IO, MODBUS/TCP, OPC UA, and MQTT. The main content area is titled 'IO-Link Diagnostics' and contains a table with diagnostic data and ISDU statistics.

Device PDI Data Length	0		2
PDI Data Valid			Yes
Last Rx PDI Data (MS Byte First)			03 17
PDO Lock Enable	Yes	Yes	Yes
PDO Locked	Yes	Yes	No
Device PDO Data Length	4		0
PDO Data Valid	Yes		
Last Tx PDO Data (MS Byte First)	02 23 0a 0b		
Time Since Initialization	7:59:17		0:52:26
Process Data Errors	0		0
Process Data Retries	0		1
Total Events	3	5	8
First Events	1)Single,Message,Local,0024h m_preoperate 2)Cleared,Error,Local,0010h s_devicelost 3)Single,Message,Local,0026h s_devinfo	1)Single,Message,Local,0024h m_preoperate 2)Cleared,Error,Local,0010h s_devicelost 3)Single,Message,Local,0026h s_devinfo 4)Single,Warning,Local,001bh s_retry	1)Single,Message,Local,0024h m_preoperate 2)Cleared,Error,Local,0010h s_devicelost 3)Single,Message,Local,0026h s_devinfo 4)Single,Warning,Local,001bh s_retry
Last Events	1)Single,Message,Local,0024h m_preoperate 2)Cleared,Error,Local,0010h s_devicelost 3)Single,Message,Local,0026h s_devinfo	2)Cleared,Error,Local,0010h s_devicelost 3)Single,Message,Local,0026h s_devinfo 4)Single,Warning,Local,001bh s_retry 5)Active,Error,Local,0010h s_devicelost	5)Active,Error,Local,0010h s_devicelost 6)Single,Message,Local,0024h m_preoperate 7)Cleared,Error,Local,0010h s_devicelost 8)Single,Message,Local,0026h s_devinfo
ISDU Statistics			
ISDU Read Cmd Attempts	71	49	114
ISDU Read Cmd Errors	0	0	0
ISDU Write Cmd Attempts	12	0	30
ISDU Write Cmd Errors	0	0	0

8.7 Clearing Settings

You can return the IOLM to factory default values and can choose whether you want to restore these default values:

- Uploaded IODD files
- IO-Link data storage
- Hostname, network settings (DHCP/Static, static IP address, static network mask, and static IP gateway) Use the following procedure to restore factory default values on the IOLM.

1. Click **Configuration | Clear Settings**.
2. Click the **OK** button next to the **Done Configuration Cleared** message.

Figure 79: Clear Settings

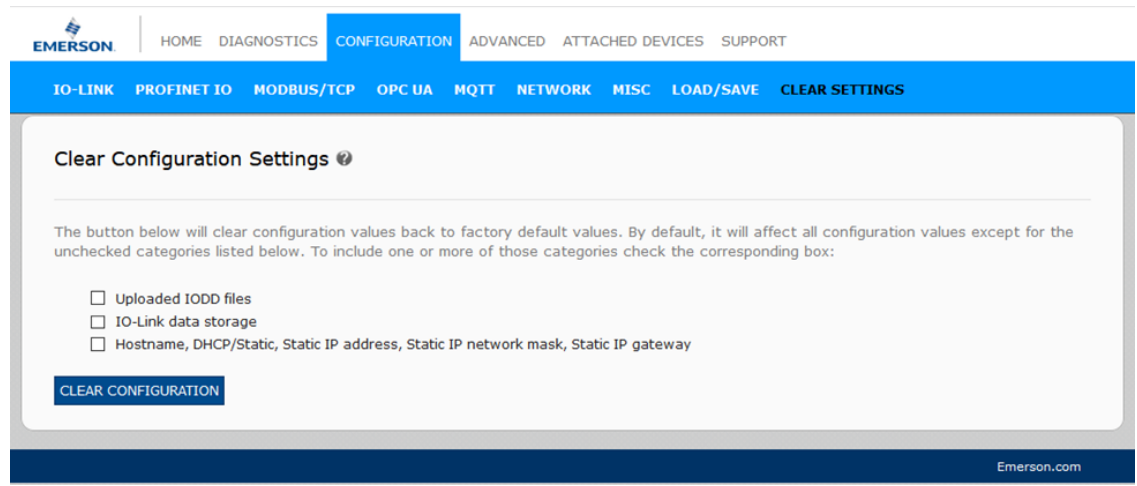

Section 9: Using the Diagnostics Pages

This section provides information about the following **Diagnostics** pages:

- IO-Link Port Diagnostics (Section 9.1)
- PROFINET IO Diagnostics Page (Section 9.2)
- Modbus/TCP Diagnostics (Section 9.3)
- OPC UA Diagnostics Page (Section 9.4)
- MQTT Diagnostic Page (Section 9.5)

9.1 IO-Link Port Diagnostics

Use the **IO-Link Diagnostics** page to determine the status of the IO-Link configuration.

Figure 80: IO-LINK Diagnostics

IO-LINK PORT STATUS	PORT 1	PORT 2	PORT 3
Port Name	IO-Link Port 1	IO-Link Port 2	IO-Link Port 3
Port Mode	IO-Link	IO-Link	IO-Link
Port Status	Operational	Inactive	Operational, PDI Valid
IO-Link State	Operate	CommLost	Operate
Device Vendor Name	Banner Engineering Corporation		Rosemount Inc.
Device Product Name	K50L2		326T-L100T32A
Device Serial Number	20-10-0814:01:53		00005256048
Device Hardware Version	V00-01		AA
Device Firmware Version	2.0.28		109
Device IO-Link Version	1.1		1.1
Actual Cycle Time	4.0ms		4.0ms
Device Minimum Cycle Time	4.0ms		2.3ms
Configured Minimum Cycle Time	4ms		4ms
Data Storage Capable	Yes		Yes
Automatic Data Storage Configuration	Disabled	Disabled	Disabled
Auxiliary Input Status	Off	Off	On
Device PDI Data Length	0		2
PDI Data Valid			Yes
Last Rx PDI Data (MS Byte First)			03 16
PDO Lock Enable	Yes	Yes	Yes

The following table provides information about the **IO-Link Diagnostics** page.

IO-Link Diagnostics	
Port Name	This is an optional friendly port name, which can be configured in the Configuration IO-Link page.
Port Mode	Displays the active device mode: Reset = The port is configured to disable all functionality. IO-Link = The port is configured to IO-Link mode. Digital In = The port is configured to operate as a digital input. Digital Out = The port is configured to operate as a digital output.

Port Status	<p>Displays the port status:</p> <p>Inactive = The port is in an active state. Typically, this indicates that the device is either not attached or not detected.</p> <p>Initializing = The port is in the process of initializing.</p> <p>Operational = The port is operational and if in IO-Link mode, communications to the IO-Link device have been established.</p> <p>PDI Valid = The PDI data is now valid.</p> <p>Fault = The port has detected a fault and is unable to re-establish communications.</p>
IO-Link State	<p>Operate - Port is functioning correctly in IO-Link mode but has not received valid PDI data. This may also display during a data storage upload or download.</p> <p>Init - The port is attempting initialization.</p> <p>Reset - One of the following conditions exists: The Port Mode configuration is set to Reset. The Port Mode configuration is set to DigitalIn or DigitalOut.</p> <p>DS - Wrong Sensor - Hardware failure (IO-Link LED also flashes red) because there is Data Storage on this port, which does not reflect the attached device.</p> <p>DV - Wrong Sensor - Hardware failure (IO-Link LED also flashes red) because Device Validation is configured for this port and the wrong device is attached.</p> <p>DS - Wrong Size - Hardware failure (IO-Link LED also flashes red) because the size of the configuration on the device does not match the size of the configuration stored on the port.</p> <p>Comm Lost - Temporary state after a device is disconnected and before the port is re-initialized.</p> <p>Pre-operate - Temporary status displayed when the device: It starting up after connection or power-up. Uploading or downloading automatic data storage.</p>
Device Vendor Name	Displays the Device Vendor Name as stored in ISDU Index 16.
Device Product Name	Displays the device product name as stored in ISDU Index 18.
Device Serial Number	Displays the device serial number as stored in ISDU Index 21.
Device Hardware Version	Displays the device hardware version as stored in ISDU Index 22.
Device Firmware Version	Displays the device firmware version as stored in ISDU Index 23.
Device IO-Link Version	The supported device IO-Link version is stored in ISDU Index 0.
Actual Cycle Time	This is the actual, or current, a cycle time of the IO-Link connection to the device.
Device Minimum Cycle Time	This is the minimum, or fastest, cycle time supported by the connected IO-Link device.
Configured Minimum Cycle Time	Configured in the Configuration IO-Link page, this is the minimum cycle time the IO-Link Master will allow the port to operate at. The Actual Cycle Time , which is negotiated between the IO-Link Master and the device, will be at least as long as the greater of the Configured Minimum Cycle Time and the Device Minimum Cycle Time .
Data Storage Capable	Displays whether the IO-Link device on a port supports the data storage feature. Not all IO-Link devices support the data storage feature.

Automatic Data Storage Configuration	Displays whether a port is configured to automatically upload data from the IO-Link device or download data from the IOLM to the IO-Link device. Disabled displays if automatic upload or download are not enabled.
Auxiliary Input (AI) Bit Status	The current status of the auxiliary bit as received on DI (Pin 2 on the IOLM) of the IO-Link port.
Device PDI Data Length	The supported Device PDI Data Length, in bytes, as stored in ISDU Index 0.
PDI Data Valid	Current status of PDI data as received from the IO-Link device.
Last Rx PDI Data (MS Byte First)	The last Rx PDI data was received from the IO-Link device.
PDO Lock Enable	If enabled on the Configuration IO-Link Settings page, an industrial protocol application (PROFINET IO, EtherNet/IP, or Modbus TCP) can lock the write access to the PDO value so that the PDO value cannot be changed by other protocols (including OPC UA or the Web interface). Such a lock is released when the PLC to IO-Link Master network link disconnects.
PDO Locked	Indicates whether or not one of the industrial protocol applications has locked the write access to the PDO value.
Device PDO Data Length	The supported Device PDO Data Length, in bytes, as stored in ISDU Index 0.
PDO Data Valid	Status of PDO data being received from the controller(s).
Last Tx PDO Data (MS Byte First)	The last Tx PDO data.
Time Since Initialization	The time since the last port initialization.
Process Data Errors	The number of process data errors the port received.
Process Data Retries	The number of process data retries the port performed.
Total Events	The total number of events that were received on this port.
First Events	Up to the first, or oldest, three events that were received on this port.
Last Events	Up to the last, or most recent, three events that were received on this port.
ISDU Statistics	
ISDU Read Cmd Attempts	The number of read ISDU command attempts.
ISDU Read Cmd Errors	The number of read ISDU command errors.
ISDU Write Cmd Attempts	The number of write ISDU command attempts.
ISDU Write Cmd Errors	The number of write ISDU command errors.

9.2 PROFINET IO Diagnostics Page

The **PROFINET IO Diagnostics** page may be useful when trying to troubleshoot communications or port issues related to PROFINET IO configuration.

Figure 81: PROFINET IO Diagnostics

The screenshot displays the 'PROFINET IO Diagnostics' page. At the top, there is a navigation bar with 'EMERSON' logo and links for HOME, DIAGNOSTICS (highlighted), CONFIGURATION, ADVANCED, ATTACHED DEVICES, and SUPPORT. Below this is a secondary navigation bar with links for IO-LINK, PROFINET IO (highlighted), MODBUS/TCP, OPC UA, and MQTT. The main content area is titled 'PROFINET IO Diagnostics' and includes three buttons: UPDATE, STOP LIVE UPDATES, and RESET STATISTICS. The primary data is presented in a table under the heading 'PROFINET IO GENERAL STATUS'.

PROFINET IO GENERAL STATUS	
Active Application Relationships	1
Application Relationship 1 Uptime	1:35:49
Application Relationship 2 Uptime	
Total Application Relationships Established	3
IOL_CALL Function Block Requests	0
IOL_CALL Function Block Errors	0
Configuration Errors	0
System Errors	0
PROFINET IO Frames Transmitted	237103
PROFINET IO Transmit Errors	0
PROFINET IO Frames Received	240867
PROFINET IO Receive Errors	0
Record Reads	0
Record Read Errors	0
Digital IO Input Status Changes	0
Digital IO Writes	0
Digital IO Write Errors	0
IP Assignment	IO Controller
Ethernet Port 1 Link Status	100Mbps Full Duplex
Ethernet Port 2 Link Status	100Mbps Full Duplex

The following table provides information about the **PROFINET IO Diagnostics** page.

PROFINET IO Diagnostics	
Active Application Relationships	Displays the current number of active PROFINET IO connections.
Application Relationship 1 Uptime	The uptime of the first application relationship.
Application Relationship 2 Uptime	The uptime of the second application relationship.
Total Application Relationships Established	The total number of application relationships that have been established since power-up.
IOL_CALL Function Block Requests	The total number of IOL_CALL function block requests received.
IOL_CALL Function Block Errors	The number of errors when handling IOC_CALL function block requests.
Configuration Errors	The number of system configuration-related errors.
System Errors	Displays the number of system resource errors. These errors indicate a system error on the IO-Link such as operating system errors or full message queues. These errors typically occur when the PLC(s) are sending messages to the IO-Link Master faster than the IO-Link Master can process them.
PROFINET IO Frames Transmitted	The total number of transmitted PROFINET IO frames.
PROFINET IO Transmit Errors	The number of errors when transmitting PROFINET IO frames.
PROFINET IO Frames Received	The total number of received PROFINET IO frames.
PROFINET IO Receive Errors	The number of errors when receiving PROFINET IO frames.
Record Reads	The total number of the record read requests received.
Record Read Errors	The number of errors when handing record read requests.
Digital IO Input Status Changes	The number of times that the status of all digital I/O pins has changed.
Digital IO Writes	The number of times that the status of the digital output pins has changed.
Digital IO Write Errors	The number of errors when writing to digital output pins.
IP Assignment	The current IP assignment method.
Ethernet Port 1 Link Status	Current link status of Ethernet Port 1.
Ethernet Port 2 Link Status	Current link status of Ethernet Port 2.
First Error String	Text description of the first error that occurred.
Last Error String	Text description of the last error that occurred.
PROFINET IO Port Status	
Application Relationship	The application relationship (1 or 2) that the IO-Link port belongs to.

PDI Reads	The number of PDI reads.
PDI Reads Truncated	The number of PDI reads that are truncated due to size.
PDI Read Errors	The number of errors when reading PDI.
PDO Writes	The number of PDI writes.
PDO Write Errors	The number of errors when reading PDO.
SIO Input Status Changes	The number of times the status of the C/Q pin has changed when a port is in SIO input mode.
SIO Output Writes	The number of times the status of the C/Q pin has changed when a port is in SIO output mode.
SIO Output Write Errors	The number of errors when writing to the C/Q pin when a port is in SIO output mode.
Auxiliary Input Status Changes	The number of times the status of the auxiliary pin has changed.
Event Reads	The number of IO-Link events.
Event Read Errors	The number of errors when reading IO-Link events.
Get Port Mode Errors	The number of errors when getting IO-Link port mode.
Set Port Mode Errors	The number of errors when setting IO-Link port mode.
ISDU Request Msgs From PLC(s)	Displays the number of ISDU request messages received from the PLC(s) or other controllers. These request messages may contain one or multiple ISDU commands.
ISDU Invalid Requests	Displays the number of ISDU requests received over PROFINET IO with one or more invalid commands.
Valid ISDU Responses From Port	Displays the number of valid ISDU response messages returned from the IO-Link port interface and available to the PLC(s). The response messages contain results to the ISDU command(s) received in the request message.
ISDU Response Timeouts	Displays the number of ISDU requests that did not receive a response within the configured ISDU Response Timeout .
Maximum ISDU Request Msg Response Time	Displays the maximum time period required to process all commands within an ISDU request message. The response is not available until all ISDU command(s) contained in the request have been processed.
Average ISDU Request Msg Response Time	Displays the average time period required to process the ISDU request message(s). The response is not available until all ISDU command(s) contained in the request have been processed.
Minimum ISDU Request Msg Response Time	Displays the minimum time period required to process all commands within an ISDU request message. The response is not available until all ISDU command(s) contained in the request have been processed.
ISDU Read Commands	Displays the number of ISDU read commands received over PROFINET IO.
ISDU Read Failures	The number of errors when processing ISDU read commands.
ISDU Write Commands	Displays the number of ISDU write commands received over PROFINET IO.

ISDU Write Failures	The number of errors when processing ISDU write commands.
Process Alarms	The number of process alarms sent to PLC.
Return of Submodule Alarms	The number of Return of Submodule alarms sent to PLC.
Channel Diagnostics Alarms Added	The number of channel diagnostics alarms sent to PLC.
Channel Diagnostics Alarms Removed	The number of channel diagnostics alarms removed from PLC.
Alarm Errors	The number errors when handling PROFINET IO alarms.

9.3 Modbus/TCP Diagnostics

The **Modbus/TCP Diagnostics** page may be useful when trying to troubleshoot Modbus/TCP communications or port issues related to Modbus/TCP configuration.

Figure 82: Diagnostics Page

The screenshot displays the 'Modbus/TCP Diagnostics' page. At the top, there is a navigation bar with 'EMERSON' logo and menu items: HOME, DIAGNOSTICS (selected), CONFIGURATION, ADVANCED, ATTACHED DEVICES, and SUPPORT. Below this is a secondary navigation bar with 'IO-LINK', 'PROFINET IO', 'MODBUS/TCP' (selected), 'OPC UA', and 'MQTT'. The main content area is titled 'Modbus/TCP Diagnostics' and includes three buttons: 'UPDATE', 'STOP LIVE UPDATES', and 'RESET STATISTICS'. The primary data is presented in a table under the heading 'MODBUS/TCP GENERAL STATUS':

MODBUS/TCP GENERAL STATUS	
Modbus/TCP Server Enable	enable
Active Connections	0
Messages Received From Masters	0
Responses Sent To Masters	0
Broadcasts Received	0
Invalid Message Length Errors	0
Invalid Message Data Errors	0
Invalid Message Address Errors	0
Unknown Device ID Errors	0
Invalid Protocol Type Errors	0
Unsupported Function Code Errors	0
Configuration Errors	0
No Available Connection Errors	0
System Resource Errors	0
First Error String	No Error Detected
Last Error String	

Below this table is a section titled 'MODBUS/TCP PORT STATUS' with a tabbed interface for PORT 1 through PORT 8. The 'Active PDO Controller(s)' row is currently empty. The 'PDO Writes to Offline or Read-Only Ports' row shows a count of 0 for each of the eight ports.

MODBUS/TCP PORT STATUS	PORT 1	PORT 2	PORT 3	PORT 4	PORT 5	PORT 6	PORT 7	PORT 8
Active PDO Controller(s)								
PDO Writes to Offline or Read-Only Ports	0	0	0	0	0	0	0	0

Note: The complete **Modbus/TCP Diagnostics** page is not illustrated.

The following table provides information about the **Modbus/TCP Diagnostics** page.

Modbus/TCP Diagnostics	
Active Connections	Displays the current number of active Modbus/TCP connections.
Messages Received from Masters	Displays the number of Modbus messages received from Modbus/TCP Masters.
Responses Sent to Masters	Displays the number of Modbus responses sent to Modbus/TCP Masters.
Broadcasts Received	Displays the number of broadcasts Modbus/TCP messages received.
Invalid Message Length Errors	Displays the number of Modbus messages received with incorrect length fields.
Invalid Message Data Errors	Displays the number of invalid message data errors. These errors occur when the IO-Link Master receives a message that cannot be performed due to invalid data.
Invalid Message Address Errors	Displays the number of invalid message address errors. These errors occur when the IO-Link Master receives a message that cannot be performed due to an invalid address.
Unknown Device ID Errors	Displays the number of unknown device ID errors. These errors occur when the IO-Link Master receives a message that is addressed to a device ID other than the configured Slave Mode Device ID.
Invalid Protocol Type Errors	Displays the number of invalid message protocol type errors. These errors occur when the IO-Link Master receives a Modbus/TCP message that specifies a non-Modbus protocol.
Unsupported Function Code Errors	Displays the number of invalid Modbus function code errors. These errors occur when the IO-Link Master receives a message that cannot be performed due to an unsupported Modbus function code.
Configuration Errors	Displays the number of improper configuration errors. These errors occur when the IO-Link Master receives a message that cannot be performed due to an invalid configuration.
No Available Connection Errors	Displays the number of Modbus/TCP connection attempts that were rejected due to no available connections. This occurs when the number of Modbus/TCP connections has reached the limit.
System Resource Errors	Displays the number of system resource errors. These errors indicate a system error on the IO-Link such as operating system errors or full message queues. These errors typically occur when the PLC(s) are sending messages to the IO-Link Master faster than the IO-Link Master can process them.
First Error String	Text description of the first error that occurred.
Last Error String	Text description of the last error that occurred.
<i>Modbus/TCP Port Specific Diagnostics</i>	
Active PDO Controller(s)	Lists IP addresses that are controlling the PDO data.
PDO Writes to Offline or Read-Only Ports	Displays the number of PDO write messages that were dropped due to any of the following: The port is configured in IO-Link mode: There is no device connected to the port. The IO-Link device is offline. The IO-Link device does not support PDO data. The PDO Transmit Mode (To PLC) is disabled. The port is configured in Digital Input mode.
ISDU Request Msgs From PLC(s)	Displays the number of ISDU request messages received from the PLC(s) or other controllers. These request messages may contain one or multiple ISDU commands.
ISDU Invalid Requests	Displays the number of ISDU requests received over Modbus/TCP with one or more invalid commands.

Modbus/TCP Diagnostics	
ISDU Requests When Port Offline	Displays the number of ISDU requests received over Modbus/TCP when the IO-Link port was offline. This can occur when: The IO-Link port is initializing, such as after start-up. There is no IO-Link device attached to the port. The IO-Link device is not responding. Communication to the IO-Link device has been lost.
Valid ISDU Responses From Port	Displays the number of valid ISDU response messages returned from the IO-Link port interface and available to the PLC(s). The response messages contain results to the ISDU command(s) received in the request message.
ISDU Response Timeouts	Displays the number of ISDU requests that did not receive a response within the configured ISDU Response Timeout .
Unexpected ISDU Responses	Displays the number of unexpected ISDU responses. Unexpected responses may occur when an ISDU response is received after the ISDU request has timed out. This typically requires setting the ISDU Response Timeout to a longer value.
Maximum ISDU Request Msg Response Time	Displays the maximum time period required to process all commands within an ISDU request message. The response is not available until all ISDU command(s) contained in the request have been processed.
Average ISDU Request Msg Response Time	Displays the average time period required to process the ISDU request message(s). The response is not available until all ISDU command(s) contained in the request have been processed.
Minimum ISDU Request Msg Response Time	Displays the minimum time period required to process all commands within an ISDU request message. The response is not available until all ISDU command(s) contained in the request have been processed.
ISDU Read Commands	Displays the number of ISDU read commands received over Modbus/TCP.
ISDU Write Commands	Displays the number of ISDU write commands received over Modbus/TCP.
ISDU NOP Commands	Displays the number of ISDU NOP (no operation) commands received over Modbus/TCP.

9.4 OPC UA Diagnostics Page

The **OPC UA Diagnostics** page displays status for OPC UA:

1. Whether the OPC UA feature is enabled or disabled
2. Number of TCP connections

Figure 83: OPC UA Diagnostics Page

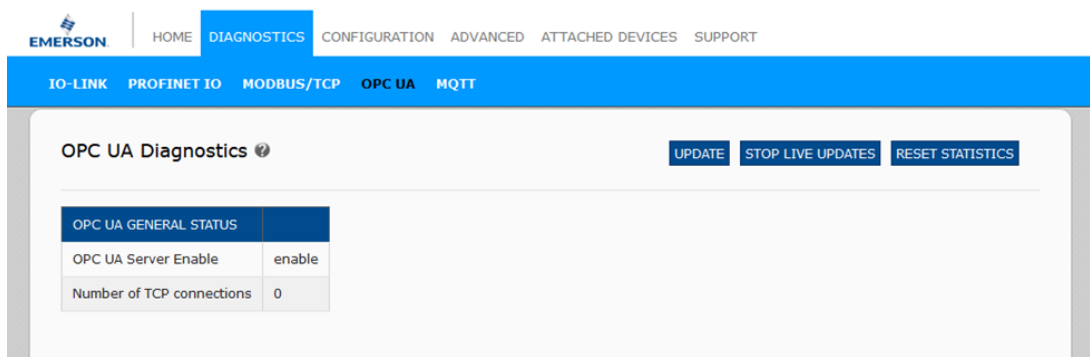

Note: Not all models support OPC UA.

9.5 MQTT Diagnostic Page

The MQTT Diagnostic Page would be useful when diagnosing the communication issues or protocol connectivity status. The following are the diagnostic details available for the user to debug/troubleshoot communication.

The details of various parameters as shown in the diagnostic window are:

MQTT Client Enable	Displays whether the MQTT client has been enabled or disabled.
MQTT Client State	Displays connection status: <ul style="list-style-type: none"> • Connected • Disconnected
Connect Successes	The number of successful attempts to connect to the MQTT broker.
Connect Failures	The number of failed attempts to connect to the MQTT broker.
Connections Lost	The number of connections to the MQTT broker has been lost.
Last Connection Error	Displays the last type of connection error.
Publish Attempts	The number of attempts to publish a data message to an MQTT topic.
Publish Successes	The number of successfully published MQTT data messages.
Publish Failures	The number of failed attempts to publish an MQTT data message.
Last Publish Error	Displays the last publish error.
Subscribe Attempts	The number of attempts to subscribe to an MQTT topic.
Subscribe Successes	The number of successful attempts to subscribe to an MQTT topic.
Subscribe Failures	The number of failed attempts to subscribe to an MQTT topic.
Last Subscribe Error	The last error that occurred when attempting to subscribe to an MQTT topic.
Subscribed Messages Received	The number of MQTT data messages received on subscribed topics.

Section 10: PROFINET IO Reference Information

10.1 Read PDI Data of IO-Link Device in PLC

This section demonstrates how to configure the IO-Link input device on the PLC.

Figure 84: IO-Link Device Configuration in PLC

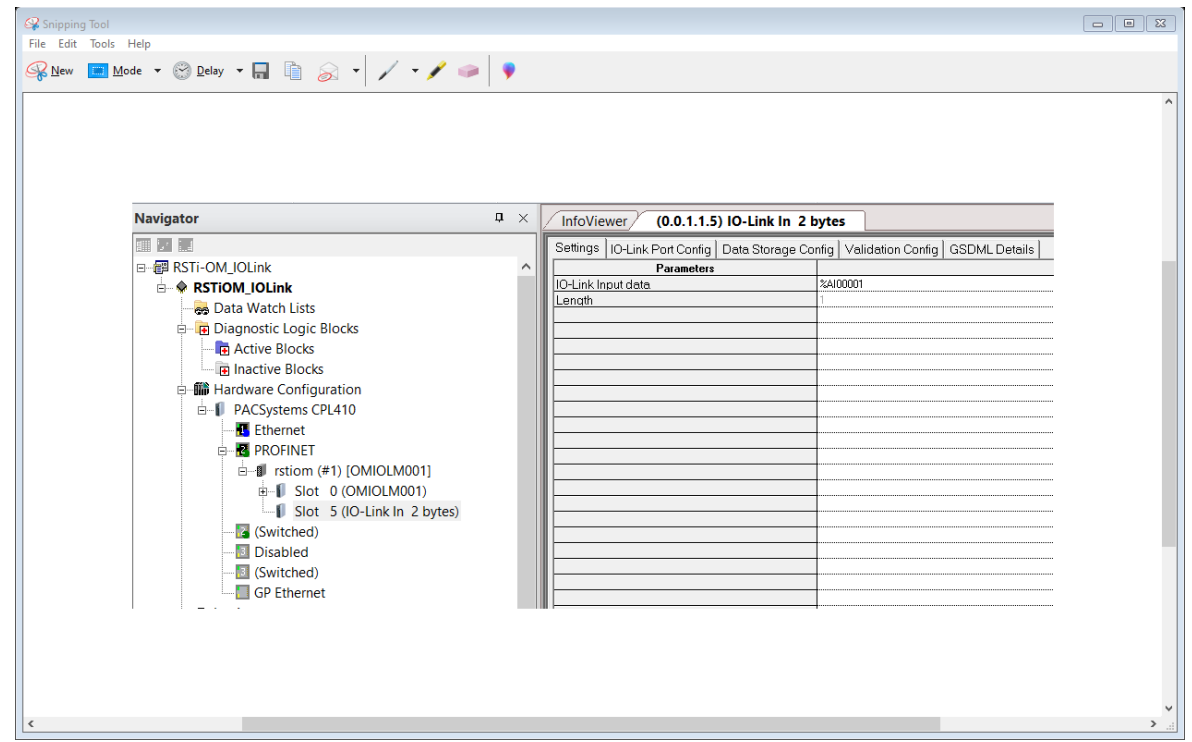

The IO-Link device, which supports 2 bytes of PDI data, is connected to IO-Link Port 5. The PDI data is mapped into the process image at address %AI00001, as shown in the figure above. The IO controller could read the current PDI data from the IO-Link device at %AI00001.

Figure 85: IO-Link Device PDI Value in Webserver

Parameter Name	Value	Description	Data Type	Simple Datatype	Bit Length	Bit Offset	Fixed Length
- Process Data							
- Process Data Input							
Temperature	296	-500~2000	RecordT	IntegerT	16	0	

Figure 86: IO-Link Device PDI Value in PLC

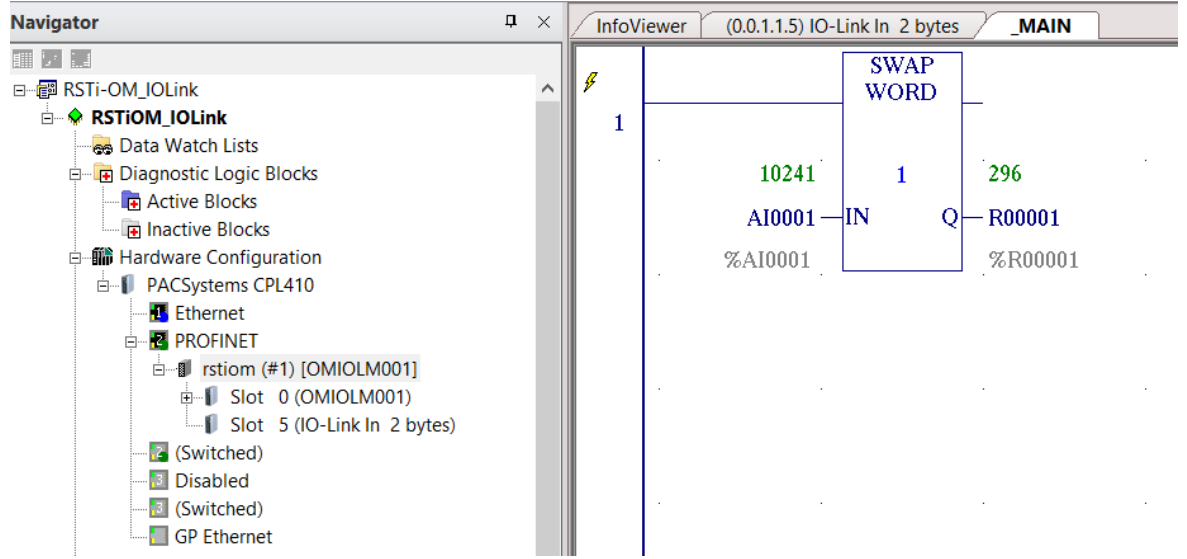

The IO-Link device PDI value received in PLC at address %AI0001 is in byte swap format. Using swap word instruction, we got PDI value at reference address %R00001 equal to PDI value shown in webserver.

Figure 89: IO-Link Device PDO Value in PLC

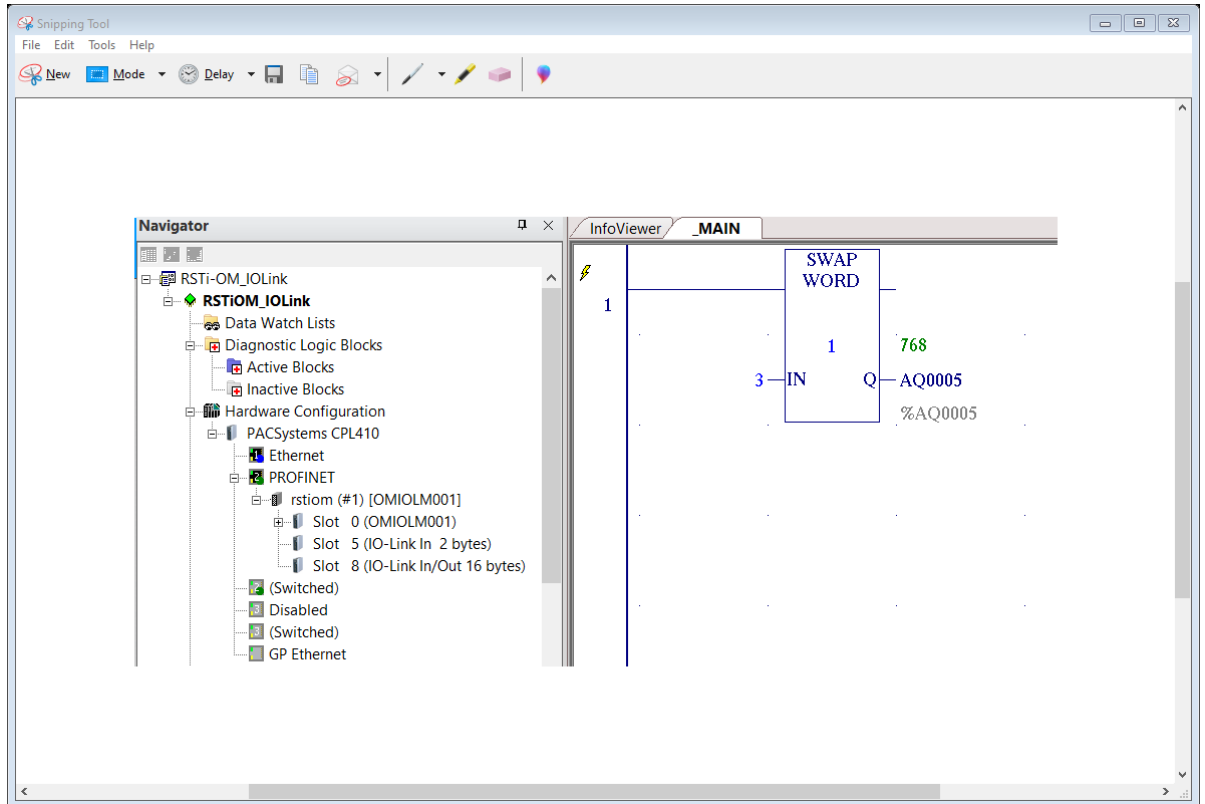

Now we are changing the PDO value to 3, here due to data swap we used swap instruction as shown in the above image. From PLC we are wiring value 768 at reference address %AQ0005 to set PDO value to 3.

Figure 90: IO-Link Device PDO Value in Webserver

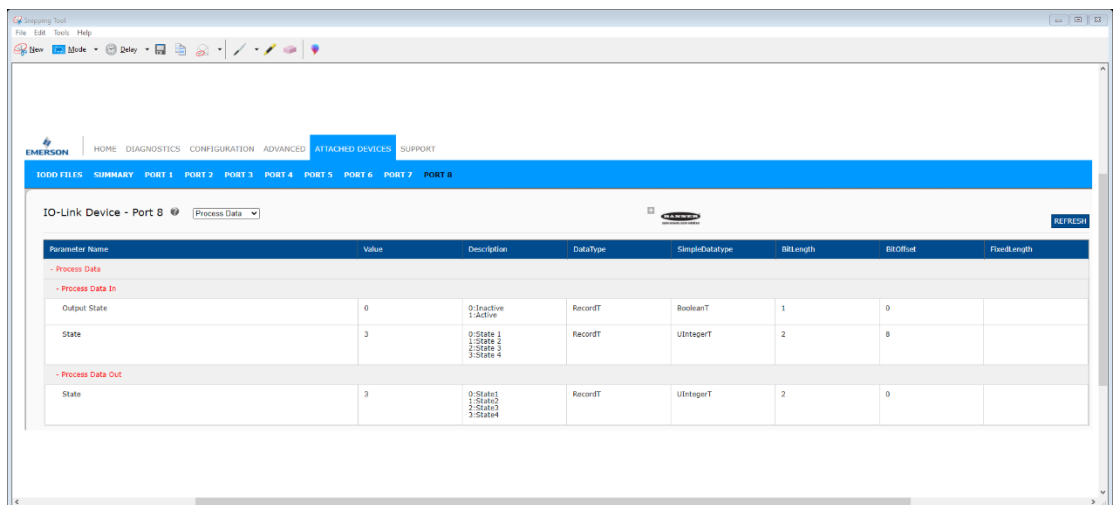

10.3 Diagnostic Alarm

Events from IO-Link Master and IO-Link devices are mapped to PROFINET alarms and channel diagnostics according to the IO-Link on *PROFINET Working Document Version 13.4.2015* with some modifications.

10.3.1 IO-Link Event Mapping Overview

IO-Link events are mapped into **PROFINET Alarms and Channel Diagnostics** using the following table. Each appearing IO-Link event (mode Coming) results in adding channel diagnostics. Each disappearing IO-Link event (mode Going) results in removing channel diagnostics. IO-Link events that have mode Single will be mapped to the PROFINET process alarm.

IO-Link Event Mapping	
IO-Link Event Mode	PROFINET
Single	Process alarm
Coming	Add channel diagnostics
Going	Remove channel diagnostics

In addition, only IO-Link events that have the type of Error or Warning are mapped to PROFINET channel diagnostics. Type Message IO-Link events are not mapped.

Note: Process alarms are reported as ‘Unexpected PROFINET Alarms’ in the IO fault table of the PLC.

10.3.2 IO-Link EventCode Mapping

IO-Link events that are generated by IO-Link devices (remote events) are mapped to PROFINET diagnostics using **ChannelErrorType** 0x500 and 0x501.

- For an **EventCode** that is between 0x0000 and 0x7FFF, **ChannelErrorType** 0x500 is used. The **EventCode** is directly mapped to **ExtChannelErrorType**.
- For an **EventCode** that is between 0x8000-0xFFFF, **ChannelErrorType** 0x501 is used. The **EventCode** is mapped to **ExtChannelErrorType** with the MSB set to 0.
- For IO-Link events that are generated by IO-Link Master (local events), **ChannelErrorType** 0x502 is used.
- **EventCode** is directly mapped to **ExtChannelErrorType**.

The following table summarizes how IO-Link **EventCode** is mapped to PROFINET diagnostics.

IO-Link EventCode Mapping				
Source	EventCode	ChannelError Type	ExtChannel ErrorType	Comment
IO-Link Device (remote)	0x0000-0x7FFF	0x500	0x0000-0x7FFF	Direct mapping of EventCode to ExtChannelErrorType (e.g. EventCode 0x6321 will be mapped to ExtChannelErrorType 0x6321)
IO-Link Device (remote)	0x8000-0xFFFF	0x501	0x0000-0x7FFF	Mapping of EventCode to ExtChannelErrorType. Set MSB (EventCode) to “0” (e.g. EventCode 0x8005 ExtChannelErrorType 0x0005)
IO-Link Master (local)	0x0000-0x7FFF	0x502	0x0000-0x7FFF	Direct mapping of local EventCode to ExtChannelErrorType

The following table lists some of the **EventCode** that the Emerson IO-Link Master generates.

IO-Link EventCode	ExtChannelErrorType	Description
0x0001	0x0001	Slave PDU Flow
0x0002	0x0002	Master PDU checksum error
0x0003	0x0003	Slave illegal PDU
0x0004	0x0004	Master illegal PDU
0x0005	0x0005	Slave PDU buffer
0x0006	0x0006	Slave PD INKR
0x0007	0x0007	Slave PD length
0x0008	0x0008	Slave no PDI
0x0009	0x0009	Slave no PDO
0x000A	0x000A	Slave channel
0x000B	0x000B	Master event
0x000C	0x000C	Application message
0x000D	0x000D	Application warning
0x000E	0x000E	Application device
0x000F	0x000F	Application parameter
0x0010	0x0010	Slave device lost
0x0012	0x0012	Slave DESINA
0x001A	0x001A	Slave wrong sensor
0x001B	0x001B	Slave retry
0x001E	0x001E	Power short circuit
0x001F	0x001F	Power sensor
0x0020	0x0020	Power actuator
0x0021	0x0021	Power fault
0x0022	0x0022	Power reset
0x0023	0x0023	Slave fallback
0x0024	0x0024	Master preoperate
0x0028	0x0028	Data storage ready
0x0029	0x0029	Data storage identity fault
0x002A	0x002A	Data storage size fault
0x002B	0x002B	Data storage upload fault
0x002C	0x002C	Data storage download fault
0x002F	0x002F	Data storage device locked fault

The following images show a *Slave device lost* event that was available in the diagnostics when an IO-Link device was disconnected from an IO-Link port. In the figure, s1 means that the device was connected to IO-Link Port 1. The event will be removed from the diagnostics when the device is reconnected to the same IO-Link port.

Figure 91: PLC IO fault table

The screenshot shows the 'Fault Table Viewer' window with the following data:

Loc	CIRC No.	Variable Name	Ref. Address	Fault Category	Fault Type	Date/Time
0.0.D5	n/a			Unexpected Profinet Alarm		02-08-2021 15:00:09
1	5		n/a	2:Diagnostic	37	0
Fault Extra Data: 02 cb 0c 8c 80 6c 00 63 00 02 05 00 00 01 00 01 00 00 00 00 00 Lan Name: LAN01 Device Name: rsti-om-h						
0.0.D5.r0.s1.s1	1		%AQ 00007	Extended Channel Diagnosis Appears	Manufacturer specific (1282)	02-08-2021 15:00:09
1	5		1	2:Diagnostic	42	1282
Fault Extra Data: a8 00 48 04 05 02 00 10 00 00 00 00 00 00 00 00 00 00 00 00 00 Lan Name: LAN01 Device Name: rsti-om-h						
0.0.D5	n/a			Unexpected Profinet Alarm		02-08-2021 15:00:09
1	5		n/a	2:Diagnostic	37	0
Fault Extra Data: 02 cb 0c 8c 80 6c 00 63 00 02 05 00 00 01 00 01 00 00 00 00 00 Lan Name: LAN01 Device Name: rsti-om-h						

Section 11: Modbus/TCP Interface

The IOLM provides a slave-mode Modbus/TCP interface that provides:

- Read access to the Process Data Input (PDI) and Process Data Output (PDO) data blocks for each IO-Link port
 - Write access to the PDO data block for each IO-Linkport
 - Write access to send ISDU requests to each IO-Linkport
 - Read access to ISDU responses from each IO-Link port
 - Read access to the Port Information Block for each IO-Link port
- The Modbus interface is disabled by default. To enable Modbus/TCP:
1. Click **Configuration | Modbus/TCP**.
 2. Click the **EDIT** button in the Modbus/TCP Configuration table.
 3. Select enable in the Modbus Enable drop box.
 4. Click the **SAVE** button.

Figure 92: Modbus/TCP to IO-Link

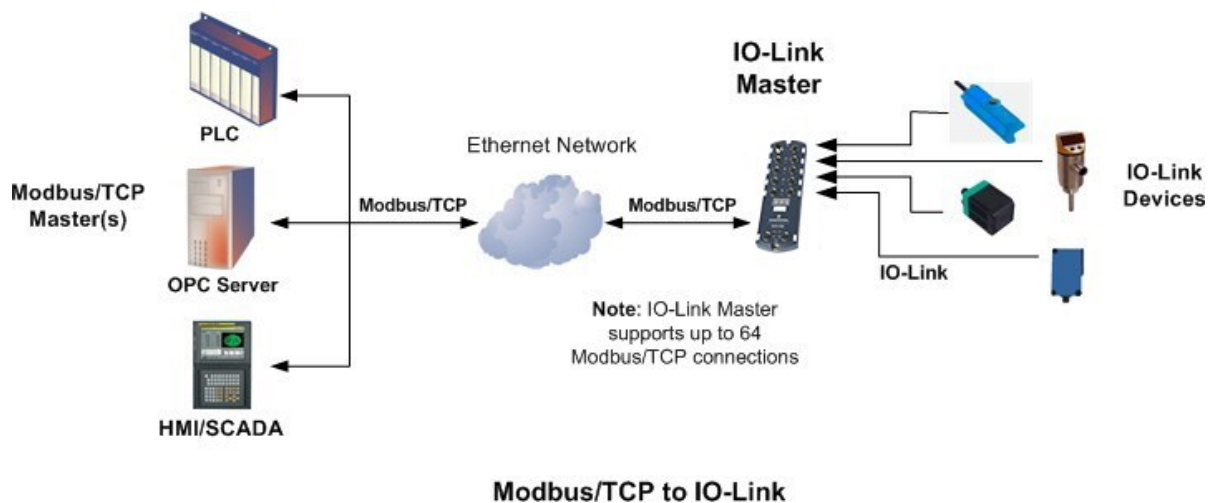

Refer to Section 13: *Functionality Descriptions* for detailed information about process data block descriptions, event handling, and ISDU handling.

11.1 Modbus Function Codes

This table shows the supported Modbus function codes.

Message Type	Function Code	Maximum Message Size
Read Holding Registers	3	250 Bytes (125 Words)
Write Single Register	6	2 bytes (1 Word)
Write Multiple Registers	16 (10 hex)	246 Bytes (123 Words)
Read/Write Holding Registers	23 (17 hex)	Write: 242 bytes (121 Words) Read: 246 bytes (123 Words)

11.2 Modbus Address Definitions

The address definitions for the Modbus/TCP interface are shown in the following tables.

	IO-Link Port 1	IO-Link Port 2	IO-Link Port 3	IO-Link Port 4	Access	Length
Multiple Port PDI Data Block(s)	999 (Base 0) 1000 (Base 1)	1999 (Base 0) 2000 (Base 1)	2999 (Base 0) 3000 (Base 1)	3999 (Base 0) 4000 (Base 1)	Read-Only	Configurable per port (s)
Port Specific PDI Data Block	1000 (Base 0) 1001 (Base 1)	2000 (Base 0) 2001 (Base 1)	3000 (Base 0) 3001 (Base 1)	4000 (Base 0) 4001 (Base 1)	Read-Only	Configurable per port
Multiple Port PDO Data Block(s)	1049 (Base 0) 1050 (Base 1)	2049 (Base 0) 2050 (Base 1)	3049 (Base 0) 3050 (Base 1)	4049 (Base 0) 4050 (Base 1)	Read/Write	Configurable per port(s)
Port Specific PDO Data Block	1050 (Base 0) 1051 (Base 1)	2050 (Base 0) 2051 (Base 1)	3050 (Base 0) 3051 (Base 1)	4050 (Base 0) 4051 (Base 1)	Read/Write	Configurable per port
Receive ISDU Response	1100 (Base 0) 1101 (Base 1)	2100 (Base 0) 2101 (Base 1)	3100 (Base 0) 3101 (Base 1)	4100 (Base 0) 4101 (Base 1)	Read-Only	4 to 125 Words
Transmit ISDU Request	1300 (Base 0) 1301 (Base 1)	2300 (Base 0) 2301 (Base 1)	3300 (Base 0) 3301 (Base 1)	4300 (Base 0) 4301 (Base 1)	Write-Only	4 to 123 Words
<i>Port Information Block (Continuous Block)</i>						232 Words
Vendor Name	1500 (Base 0) 1501 (Base 1)	2500 (Base 0) 2501 (Base 1)	3500 (Base 0) 3501 (Base 1)	4500 (Base 0) 4501 (Base 1)	Read-Only	64 Chars 32 Words
Vendor Text	1532 (Base 0) 1533 (Base 1)	2532 (Base 0) 2533 (Base 1)	3532 (Base 0) 3533 (Base 1)	4532 (Base 0) 4533 (Base 1)	Read-Only	64 Chars 32 Words
Product Name	1564 (Base 0) 1565 (Base 1)	2564 (Base 0) 2565 (Base 1)	3564 (Base 0) 3565 (Base 1)	4564 (Base 0) 4565 (Base 1)	Read-Only	64 Chars 32 Words

	IO-Link Port 1	IO-Link Port 2	IO-Link Port 3	IO-Link Port 4	Access	Length
Product Id	1596 (Base 0)	2596 (Base 0)	3596 (Base 0)	4596 (Base 0)	Read-Only	64 Chars
	1597 (Base 1)	2597 (Base 1)	3597 (Base 1)	4597 (Base 1)		32 Words
Product Text	1628 (Base 0)	2628 (Base 0)	3628 (Base 0)	4628 (Base 0)	Read-Only	64 Chars
	1629 (Base 1)	2629 (Base 1)	3629 (Base 1)	4629 (Base 1)		32 Words
Serial Number	1660 (Base 0)	2660 (Base 0)	3660 (Base 0)	4660 (Base 0)	Read-Only	16 Chars
	1661 (Base 1)	2661 (Base 1)	3661 (Base 1)	4661 (Base 1)		8 Words
Hardware Revision	1668 (Base 0)	2668 (Base 0)	3668 (Base 0)	4668 (Base 0)	Read-Only	64 Chars
	1669 (Base 1)	2669 (Base 1)	3669 (Base 1)	4669 (Base 1)		32 Words
Firmware Revision	1700 (Base 0)	2700 (Base 0)	3700 (Base 0)	4700 (Base 0)	Read-Only	64 Chars
	1701 (Base 1)	2701 (Base 1)	3701 (Base 1)	4701 (Base 1)		32 Words
Device PDI Length	1732 (Base 0)	2732 (Base 0)	3732 (Base 0)	4732 (Base 0)	Read-Only	1 Word
	1733 (Base 1)	2733 (Base 1)	3733 (Base 1)	4733 (Base 1)		
Device PDO Length	1733 (Base 0)	2733 (Base 0)	3733 (Base 0)	4733 (Base 0)	Read-Only	1 Word
	1734 (Base 1)	2734 (Base 1)	3734 (Base 1)	4734 (Base 1)		

11.2.1 Port Models

	IO-Link Port 5	IO-Link Port 6	IO-Link Port 7	IO-Link Port 8	Access	Length
Multiple Port PDI Data Block(s)	4999 (Base 0) 5000 (Base 1)	5999 (Base 0) 6000 (Base 1)	6999 (Base 0) 7000 (Base 1)	7999 (Base 0) 8000 (Base 1)	Read-Only	Configurable per port (s)
Port Specific PDI Data Block	5000 (Base 0) 5001 (Base 1)	6000 (Base 0) 6001 (Base 1)	7000 (Base 0) 7001 (Base 1)	8000 (Base 0) 8001 (Base 1)	Read-Only	Configurable per port
Multiple Port PDO Data Block(s)	5049 (Base 0) 5050 (Base 1)	6049 (Base 0) 6050 (Base 1)	7049 (Base 0) 7050 (Base 1)	8049 (Base 0) 8050 (Base 1)	Read/Write	Configurable per port(s)
Port Specific PDO Data Block	5050 (Base 0) 5051 (Base 1)	6050 (Base 0) 6051 (Base 1)	7050 (Base 0) 7051 (Base 1)	8050 (Base 0) 8051 (Base 1)	Read/Write	Configurable per port
Receive ISDU Response	5100 (Base 0) 5101 (Base 1)	6100 (Base 0) 6101 (Base 1)	7100 (Base 0) 7101 (Base 1)	8100 (Base 0) 8101 (Base 1)	Read-Only	4 to 125 Words
Transmit ISDU Request	5300 (Base 0) 5301 (Base 1)	6300 (Base 0) 6301 (Base 1)	7300 (Base 0) 7301 (Base 1)	8300 (Base 0) 8301 (Base 1)	Write-Only	4 to 123 Words
<i>Port Information Block (Continuous Block)</i>						232 Words
Vendor Name	5500 (Base 0) 5501 (Base 1)	6500 (Base 0) 6501 (Base 1)	7500 (Base 0) 7501 (Base 1)	8500 (Base 0) 8501 (Base 1)	Read-Only	64 Chars 32 Words
Vendor Text	5532 (Base 0) 5533 (Base 1)	6532 (Base 0) 6533 (Base 1)	7532 (Base 0) 7533 (Base 1)	8532 (Base 0) 8533 (Base 1)	Read-Only	64 Chars 32 Words
Product Name	5564 (Base 0) 5565 (Base 1)	6564 (Base 0) 6565 (Base 1)	7564 (Base 0) 7565 (Base 1)	8564 (Base 0) 8565 (Base 1)	Read-Only	64 Chars 32 Words
Product Id	5596 (Base 0) 5597 (Base 1)	6596 (Base 0) 6597 (Base 1)	7596 (Base 0) 7597 (Base 1)	8596 (Base 0) 8597 (Base 1)	Read-Only	64 Chars 32 Words
Product Text	5628 (Base 0) 5629 (Base 1)	6628 (Base 0) 6629 (Base 1)	7628 (Base 0) 7629 (Base 1)	8628 (Base 0) 8629 (Base 1)	Read-Only	64 Chars 32 Words
Serial Number	5660 (Base 0) 5661 (Base 1)	6660 (Base 0) 6661 (Base 1)	7660 (Base 0) 7661 (Base 1)	8660 (Base 0) 8661 (Base 1)	Read-Only	16 Chars 8 Words
Hardware Revision	5668 (Base 0) 5669 (Base 1)	6668 (Base 0) 6669 (Base 1)	7668 (Base 0) 7669 (Base 1)	8668 (Base 0) 8669 (Base 1)	Read-Only	64 Chars 32 Words
Firmware Revision	5700 (Base 0) 5701 (Base 1)	6700 (Base 0) 6701 (Base 1)	7700 (Base 0) 7701 (Base 1)	8700 (Base 0) 8701 (Base 1)	Read-Only	64 Chars 32 Words
Device PDI Length	5732 (Base 0) 5733 (Base 1)	6732 (Base 0) 6733 (Base 1)	7732 (Base 0) 7733 (Base 1)	8732 (Base 0) 8733 (Base 1)	Read-Only	1 Word
Device PDO Length	5733 (Base 0) 5734 (Base 1)	6733 (Base 0) 6734 (Base 1)	7733 (Base 0) 7734 (Base 1)	8733 (Base 0) 8734 (Base 1)	Read-Only	1 Word

11.3 Multiple Port Process Data (PDI/PDO) Access via Modbus/TCP

The process data have been grouped together to minimize the number of Modbus messages required to interface to the IO-Link master. The PDI and PDO data for multiple ports can be received or transmitted by one message.

Read (Input) Process Data Input					
Starting Modbus Holding Register Address (base 1)	IO-Link Port 1	IO-Link Port 2	IO-Link Port 3	IO-Link Port 4	Length
1000					Data length = Port 1 to Port 4
2000					Data length = Port 2 to Port 4
3000					Data length = Port 3 to Port 4
4000					Data length = Port 4
Read (Input) Process Data Output					
Starting Modbus Holding Register Address (base 1)	IO-Link Port 1	IO-Link Port 2	IO-Link Port 3	IO-Link Port 4	Length
1050					Data length = Port 1 to Port 4
2050					Data length = Port 2 to Port 4
3050					Data length = Port 3 to Port 4
4050					Data length = Port 4
Write (Output) Process Data Output					
Starting Modbus Holding Register Address (base 1)	IO-Link Port 1	IO-Link Port 2	IO-Link Port 3	IO-Link Port 4	Length
1050					Data length = Port 1 to Port 4
2050					Data length = Port 2 to Port 4
3050					Data length = Port 3 to Port 4
4050					Data length = Port 4
Read (Input) Process Data Input					
Starting Modbus Holding Register Address (base 1)	IO-Link Port 5	IO-Link Port 6	IO-Link Port 7	IO-Link Port 8	Length
5000					Data length = Port 5 to Port 8
6000					Data length = Port 6 to Port 8
7000					Data length = Port 7 to Port 8
8000					Data length = Port 8
Read (Input) Process Data Output					
Starting Modbus Holding Register Address (base 1)	IO-Link Port 5	IO-Link Port 6	IO-Link Port 7	IO-Link Port 8	Length
5050					Data length = Port 5 to Port 8
6050					Data length = Port 6 to Port 8
7050					Data length = Port 7 to Port 8
8050					Data length = Port 8
Write (Output) Process Data Output					
Starting Modbus Holding Register Address (base 1)	IO-Link Port 5	IO-Link Port 6	IO-Link Port 7	IO-Link Port 8	Length
5050					Data length = Port 5 to Port 8
6050					Data length = Port 6 to Port 8
7050					Data length = Port 7 to Port 8
8050					Data length = Port 8

To receive and transmit process data for eight ports, it may be necessary to adjust the size of the PDI/PDO data blocks.

Modbus Read/Write Access *where*:

- All PDI data can be read with one Modbus Read Holding Registers message.
- All PDO data can be read with one Modbus Read Holding Registers read the message.
- All PDO data can be written with one Modbus Write Holding Registers message.

- Controller Read access:
 - The PDI data from one or more ports may be read with one message. (i.e.: If addressing port 1, at address 1000, ports one to four may be read in one message.)
 - The PDO data from one or more ports may be read with one message. (i.e.: If addressing port 1, at address 1050, ports one to four may be read in one message.)
 - Partial PDI and PDO data reads are allowed.
 - The length of the Read message can range from 1 to the total, configured PDI or PDO length for all ports starting at the addressed port.
- Controller Write (Output) access:
 - Only PDO data may be written.
 - The PDO data for one or more ports may be written with one Write Holding Registers message.
 - Partial PDO data writes are not allowed.
 - The length of the Write message must be equal to the total of the configured PDO lengths for all ports to be written. The one exception is that the data length of the last port to be written must be equal to or greater than the device PDO length for that port.

Section 12: MQTT Interface

The following topics are discussed.

- MQTT Settings Configuration Page (Section 12.1)
- Process Data Publish Interval (Section 12.2)
- Topics and Payloads (Section 12.3)
- ISDU Request Payload (Section 12.4)
- ISDU Response Payload (Section 12.5)
- PDO Write (Section 12.6)
- MQTT Settings Parameters (Section 12.7)
- Configuring MQTT (Section 12.8)

12.1 MQTT Settings Configuration Page

MQTT support provides a way to publish various data to an MQTT broker. MQTT is a simple publish-subscribe messaging protocol that is becoming popular for use in Internet of Things (IoT) type applications.

The MQTT standard does not define any format for the published messages, but JSON has been almost universally adopted by the MQTT implementation in the IoT area, so JSON is the format chosen for use by the IO-Link Master MQTT implementation.

Figure 93: MQTT Settings

The screenshot displays the MQTT Settings configuration page. At the top, there is a navigation bar with the Emerson logo and menu items: HOME, DIAGNOSTICS, CONFIGURATION (selected), ADVANCED, ATTACHED DEVICES, and SUPPORT. Below this is a secondary menu with options: IO-LINK, PROFINET IO, MODBUS/TCP, OPC UA, MQTT (selected), NETWORK, MISC, LOAD/SAVE, and CLEAR SETTINGS.

The main content area is titled "MQTT Settings" and contains two primary sections:

- MQTT PORT CONFIG:** A table with 9 columns (PORT 1 to PORT 9) and 3 rows of settings. Each column has an "EDIT" button.

MQTT PORT CONFIG	PORT 1	PORT 2	PORT 3	PORT 4	PORT 5	PORT 6	PORT 7	PORT 8	PORT 9
MqttPdIntervalMin (100 - 999999)	1000 ms	1000 ms	1000 ms	1000 ms	1000 ms	1000 ms	1000 ms	1000 ms	1000 ms
MqttPdIntervalMax (0 - 999999)	0 s	0 s	0 s	0 s	0 s	0 s	0 s	0 s	0 s
MqttPdoWriteEnable	disable	disable	disable	disable	disable	disable	disable	disable	disable
- MQTT CONFIGURATION:** A scrollable list of settings with an "EDIT" button at the top right.

MQTT CONFIGURATION	EDIT
MqttClientEnable	disable
MqttServerName	
MqttServerPort (0 - 65535)	1883
MqttUseTls	false
MqttServerAuthCertificate	[empty]
MqttVerifyServerCertName	false
MqttClientCertificate	[empty]
MqttClientPrivateKey	[empty]
MqttUsername	
MqttPassword	
MqttClientId	
MqttPubRetain	false
MqttPubQoS	

The footer of the page contains the text "Emerson.com".

12.2 Process Data Publish Interval

The PD Interval Min/Max configuration values control how often a PDI/PDO message is published. With the default configuration (min=1000ms max=0s), a value will be published when it has changed and at least 1 second has elapsed since the previous message was published. With max=0, a value will never be published unless it changes (except for once on startup).

If Interval Max is configured to a non-zero value, then the PD messages will always be published after the configured interval even when the data is unchanged.

For example, with a configuration of min=5000ms max=60s, a changing value will only be published once every 5 seconds regardless of how often it changes, and a non-changing value will be published once every 60 seconds even when it has not changed.

12.3 Topics and Payloads

All published payloads are JSON objects. The initial set of published paths and data are listed below.

12.3.1 MqttTopicBase/clientinfo

A summary of information about the IO-Link Master is published once each time the MQTT client starts.

Example payload:

```
{
  "hostname" : "grant-ice2",
  "manufacturer" : "Pepperl-Fuchs Control, Inc.",
  "model" : "ICE2-8IOL-K45P-DIN",
  "serial" : "9710-000064",
  "version" : "EtherNet/IP 1.5.0.201",
  "numdioports" : 0,
  "numiolinkports" : 8
}
```

12.3.2 MqttTopicBase/clientstatus

A periodic message containing IO-Link Master status is published under the **clientstatus** topic at a user-configured interval. The publishing period is user-configurable and can be disabled completely. An example payload is shown below.

```
{
  "uptime": 3464,
  "ports": [
    {
      "port": 1,
      "mode": "SIOInput", "status":
      "Operational", "state":
      "None", "pd_retries": 0,
      "pd_errors": 0,
      "pdi_valid": true,
      "pdo_valid": false
    }
  ]
}
```

```

    },
    {
      "port": 2,
      "mode": "IOLinkInput",
      "status": "Operational",
      "state": "Operate",
      "pd_retries": 1,

      "pd_errors": 0,
      "pdi_valid": false,
      "pdo_valid": false
    },
    {
      "port": 3, "mode":
      "Reset",

      "status": "Inactive",
      "state": "None",
      "pd_retries": 0,

      "pd_errors": 0,
      "pdi_valid": true,
      "pdo_valid": false
    },
    ...
    {
      "port": 8,
      "mode": "IOLinkInput",
      "status": "Inactive",
      "state": "Init",
      "pd_retries": 0,

      "pd_errors": 0,
      "pdi_valid": true,
      "pdo_valid": false
    }
  ]
}

```

12.3.3 MqttTopicBase/port/n/status

A port status object is published on startup and each time the port changes state. Example payloads:

```
{
```

```

"port":2,
"mode":"IOLinkInput",

"status":"Operational, PDI Valid",
"state":"Operate"

}

{
"port":5,
"mode":"IOLinkInput",
"status":"Inactive",
"state":"Init"

}

{
"port":3, "mode":"Reset",
"status":"Inactive",
"state":"None"

}

{
"port":1,
"mode":"SIOOutput",
"status":"Operational",
"state":"Reset"

}

```

12.3.4 MqttTopicBase/port/n/deviceinfo

A port deviceinfo object is published each time the communication to an IO-Link device is established successfully. Example payloads:

```

{
"port": 4,
"vendorid": 1,
"deviceid": 1120516,
"functionid": 0,
"vendname": "Pepperl+Fuchs",
"vendtext": "www.pepperl-fuchs.com/io-link",
"prodname": "OMT300-R200-2EP-IO-V1", "prodid":
"295670-100140",
"prodtext": "Distance sensor",
"serial": "40000077249691",

```

```
"hwvers": "HW01.00",  
"fwvers": "FW01.02",  
"apptag": "Your automation, our passion.",  
"functag": "R200 series",  
  
"loctag": "***",  
"pdibytes": 4,  
  
"pdobytes": 1,  
"isducapable": true,  
"dscapable": true,  
"dslength": 213,  
  
"iolinkvers": "11"  
}
```

12.3.5 MqttTopicBase/port/n/event

An event data object is published each time an event occurs for any port. Example payload:

```
{  
  "port" : 1,  
  "instance" : 3,  
  "mode" : 1,  
  "type" : 1,  
  "pdvalid" : 0,  
  "local" : 1,  
  "code" : 36,  
  
  "description" : "inst=AL mode=SINGLE type=MESSAGE  
pd=INVALID local=ff code=0x0024:M_PREOPERATE"  
}
```

12.3.6 MqttTopicBase/port/n/pdi

PDI values are published when they change. Raw byte array data is always present. If PDI length is 4 or less, an unsigned integer version is also present. If an IODD file is present, dissected field values will be present for the configured process data group as defined by the IODD. If enabled, the process data field names will be "sanitized" so that they are legal JavaScript identifiers by replacing illegal characters with underscores.

Example payloads:

```
{  
  "port" : 2,  
  "valid" : 1,  
  "uint" : 366,  
  "raw" : [1,137]  
}  
  
{
```

```

    "port" : 4,
    "valid" : 1,
    "raw" : [9,124,9,79,9,127,0,0]
  }
  {
    "port": 1,
    "valid": 1,
    "V_PdT": {
      "Temperature": 0,
      "Switch status [OUT1].": 0
    },
    "raw": [9,140,9,136,9,90,0,0]
  }
  {
    "port": 1,
    "valid": 1,
    "V_PdT": {
      "Temperature": 0,
      "Switch_status_OUT1_": 0
    },
    "raw": [9,140,9,136,9,90,0,0]
  }

```

12.3.7 MqttTopicBase/port/n/pdo

PDO values are published when they change (subject to the minimum publish interval setting) or periodically according to the maximum publish interval setting. Raw byte array data is always present. If PDO length is 4 or less, an unsigned integer version is also present. If an IODD file is present, dissected field values will be present for the configured process data group as defined by the IODD. If enabled, the process data field names will be "sanitized" so that they are legal JavaScript identifiers by replacing illegal characters with underscores.

```

{
  "port" : 1,
  "valid" : 1,
  "uint" : 252,
  "raw" : [252]
}

```

12.3.8 MqttTopicBase/port/n/auxin

IO-Link port DI (auxiliary input) pin values will be published when they change (subject to minimum publish interval setting) or periodically according to the maximum publish interval setting. The payload comprises the port number and a single "value" field having an integer value of 0 or 1.

```

{

```

```
"port": 2,
"value": 0
}
```

12.3.9 ISDU Read/Write

Since MQTT lacks intrinsic support for request/response semantics, ISDU read/write requests and responses are handled via a pair of topics:

- MqttTopicBase/port/n/isdu/request/client_transaction_id
- MqttTopicBase/port/n/isdu/response/client_transaction_id

Requests for ISDU read/write are published by other clients to the "request" topic shown above. The client_transaction_id is an arbitrary string chosen by the requesting client and should be chosen to be unique. After the ISDU operation is completed, the IO-Link Master will publish the response to the corresponding "response" topic (with the same client_transaction_id as the request).

12.4 ISDU Request Payload

The ISDU request payload is a JSON object with the fields described below.

Name	Type	Description
op	string	Required — must be "read" or "write"
index	integer	Required
subindex	integer	Optional (defaults to 0 if not provided)
Fields specific to read requests:		
format	string	Optional — if present, it determines the format of the returned read data in the response. Should be one of "str" "raw" "uint". If not provided, read data will be returned in all formats.
Fields specific to write requests (exactly one of uint, raw, or str must be present)		
raw	array	The array of integer byte values (decimal)
uint	integer	Integer data value (requires len field)
str	string	UTF-8 data string (len field is optional)
len	integer	Required for uint data, optional for str data. Controls the number of data bytes written.

In a written request with str data and a len field, the string will be NULL-padded to the requested length before being written to the device.

12.5 ISDU Response Payload

The ISDU response payload is a JSON object with the fields described below:

Name	Type	Description
op	string	"op" value from request
index	integer	"index" value from request
subindex	integer	"subindex" value from request (if present and non-zero)
status	string	"OK" if the request was successful, otherwise an error message.
Fields specific to read response (one or more of raw, str, uint may be present:		
raw	array	An array of integer byte values (decimal)
uint	integer	Unsigned integer value
str	string	UTF-8 string data
len	integer	Number of bytes read

If no format is specified in the read request, then the read response will contain data in all three formats when $len \leq 4$. If $len > 4$, only raw and str formats will be returned. If the read operation fails, no len value or data values will be returned.

In a read response, the str value will have any trailing NULL bytes removed. The len field will always indicate the total number of bytes read (including any trailing NULL bytes for string values)

Below is an example of a write-string request/response followed by a read-string request/response and a read-raw request/response where the topic base path is IOLM:

```
IOLM/port/1/isdu/request/66b127b7-f39d-40e7-b786- 1cffc8d344a0
```

```
{
  "op": "write", "index": 24,
  "str": "hi there"
}
```

```
IOLM/port/1/isdu/response/66b127b7-f39d-40e7-b786- 1cffc8d344a0
```

```
{
  "op": "write", "index": 24,
  "status": "OK"
}
```

```
IOLM/port/1/isdu/request/2ee5141e-335b-4e33-bf4e- dedf01a0ff7b
```

```
{
  "op": "read", "index": 24,
  "format": "str"
}
```

```
IOLM/port/1/isdu/response/2ee5141e-335b-4e33-bf4e- dedf01a0ff7b
```

```
{
```



```

"op": "read", "index": 24,

"str": "hi there"

"len": 16,

"status": "OK"

}

IOLM/port/1/isdu/request/1c510d4d-151e-49b3-bbad- 0847a272812e

{

"op": "read", "index": 24,

"format": "raw"

}

IOLM/port/1/isdu/response/1c510d4d-151e-49b3-bbad- 0847a272812e

{

"op": "read",

"index": 24, "raw": [104,105,32,116,104,101,114,101,0,0,0,0,0,0,0],

"len": 16,

"status": "OK"

}

IOLM/port/3/isdu/request/1234

{

"op": "read", "index": 15,

"format": "str"

}

IOLM/port/3/isdu/response/1234

Example: negative response 'Index not available'

{

"op": "read", "index": 15, "status": "Error",

"errmsg": "index invalid", "errortype": {

"status": 1,

"code": 128,

"addcode": 17

}

}

```

12.6 PDO Write

PDO values may be written by publishing to `MqttTopicBase/port/n/pdo/wr`. The payload may contain PDO data fields in one of two formats: raw or uint. Data in raw format must match the PDO length exactly. Data in uint format is supported only for PDO lengths of 4 bytes or less. If an IODD file is present that defines Process Data groups and fields, then those may be used to write to individual field values. The available groups/fields

are shown on the MQTT diagnostics page as "PDGroups" in the MQTT Port Status table. The published object may also contain a boolean valid flag.

Example payloads:

```
IOLM/port/5/pdo/wr
```

```
{  
  "uint": 349718  
}
```

```
IOLM/port/1/pdo/wr
```

```
{  
  "raw": [1,254,75]  
}
```

```
IOLM/port/1/pdo/wr
```

```
{  
  "uint": 15, "valid": true  
}
```

```
IOLM/port/5/pdo/wr
```

```
{  
  "raw": [1, 243,79,103, 253,12],  
  "valid": true  
}
```

```
IOLM/port/3/wr
```

```
{  
  "PDOOut": {  
    "LevelSetpoint": 119.34  
  },  
  "valid": true  
}
```

```
IOLM/port/1/pdo/wr
```

```
{  
  "valid": true  
}
```

```
IOLM/port/8/pdo/wr
```

```
{  
  "valid": false  
}
```

12.7 MQTT Settings Parameters

The following table illustrates the MQTT Port Configuration settings.

Field	Type	Default	Description
Process Data Publish Interval min (100 - 999999)	int	1000	The minimum interval (milliseconds) between successive PDI (or PDO) messages for the port.
Process Data Publish Interval max(100 - 999999)	int	0	Maximum interval (seconds) between successive PDI (or PDO) messages for a port (0 == infinite).
PDO Write Enable	enum	disable	Enable PDO to write

The following table provides information about MQTT Configuration for client data that are global MQTT configuration settings.

Field	Type	Default	Description
MQTT Client Enable	enum	disable	Enable/disable the MQTT client
Server Name/IP	string		MQTT server hostname or IPv4 address
Server Port (0 - 65535)	int	1883	MQTT server port (0-65535). Probably 8883 if TLS is enabled.
Use SSL/TLS	boolean	false	Use SSL/TLS encryption
Server Authentication Certificate	file		The Server Authentication Certificate is used by the IO-Link Master to verify the server's identity. The X509 certificate is used to verify server identity (PEM encoding). The Use SSL/TSL option must be enabled for this option to work.
Verify Server Certificate Name	boolean	false	Enable verification of information (e.g. name) in server auth certificate.
Client Certificate	file		The Client Authentication Certificate is sent by the IO-Link Master (the client) to the server to verify the client's identity. The X509 certificate was sent to the server for authentication (PEM encoding). The Use SSL/TSL option must be enabled for this option to work.
Client Private Key	file		The Client Private Key is required to use the Client Authentication Certificate as described above. This is the private key for the above certificate (PEM encoding). The Use SSL/TSL option must be enabled for this option to work.
Username	string		Username sent to the server for authentication

Password	string		Password sent to the server for authentication
Client ID	string		Client ID sent to the server when connecting
Request Broker Retention	boolean	false	Request that broker retains published messages
Publish Request QoS	enum	at most once	QoS level 0 requested when publishing
Subscribe Request QoS	enum	at most once	QoS level 0 requested when subscribing
Topic Base Path	string		The path prefix used for all published messages
Don't Allow Illegal Characters in PDI/PDO Field Names	boolean	true	Convert PDI/PDO field names to valid JavaScript identifiers by replacing illegal characters with underscores
Client Status Publish Interval (0 - 999999)	int	10	Publishing interval (seconds) for the client status message (0 == disable)
ISDU Write Enable	enum	disable	Enable ISDU to write.

12.8 Configuring MQTT

1. Refer to the MQTT Settings table if you require definitions or values for the options.
2. If necessary, click **Configuration | MQTT**.
3. To configure port-level values, click the **EDIT** button below the port that you want to update.
4. Click the **SAVE** button after updating the settings.
5. Click the **MQTT Configuration EDIT** button.
6. Select enable from the **MQTT Client Enable** option dropdown.
7. Enable other options that your environment requires.
8. Scroll to the top of the page and click the **SAVE** button.

Section 13: Functionality Descriptions

This section discusses the following for Modbus/TCP:

Process Data Block Descriptions (Section 13.1)

Event Handling (Section 13.2)

ISDU Handling (Section 13.3)

13.1 Process Data Block Descriptions

13.1.1 Input Process Data Block Description

The Input Process Data Block format is dependent on the configured PDI Data Format. The following tables describe the Input Process Data Block in the possible formats.

Parameter Name	Data Type	Description
Port Status	BYTE	<p>The status of the IO-Link device.</p> <p>Bit 0 (0x01): 0 = IO-Link port communication initialization process is inactive 1 = IO-Link port communication initialization process is active</p> <p>Bit 1 (0x02): 0 = IO-Link port communication is not operational 1 = IO-Link port communication is operational</p>
		<p>Bit 2 (0x04): 0 = IO-Link input process data is not valid. 1 = IO-Link input process data is valid.</p> <p>Bit 3 (0x08): 0 = No fault detected 1 = Fault detected A minor communication fault is indicated by the Operational status bit is set to 1. A minor communication fault results from:</p> <ul style="list-style-type: none"> - A temporary loss of communication to the IO-Link device.
		<ul style="list-style-type: none"> - A recoverable IOLM software or hardware fault. <p>A major communication fault is indicated by the Operational bit being set to 0.</p> <ul style="list-style-type: none"> - An unrecoverable loss of communication to the IO-Link device.
		<ul style="list-style-type: none"> - An unrecoverable IOLM software or hardware fault. <p>Bits 4-7: Reserved (0)</p>

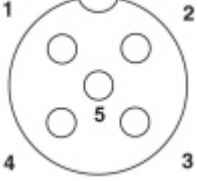
Parameter Name	Data Type	Description
Auxiliary I/O	BYTE	<p>The auxiliary bit on the IO-Link port is:</p> <p>Pin 2 on the IOLM</p>  <p>Bit 0 (0x01): The status of the auxiliary bit.</p> <p>0 = off</p>
		<p>1 = on</p> <p>Bits 1-3: Reserved (0)</p> <p>If Include Digital I/O in PDI Data Block is disabled:</p> <p>Bits 4-7: Reserved (0)</p>
		<p>Bit 4 (0x10) – D1 = DI status Bit 5 (0x20) – D2 = DIO status Bit 6 (0x40) – D3 = D2 status Bit 7 (0x80) – D4 = DIO status</p>
Event Code	INT	16-bit event code received from the IO-Link device.
PDI Data <i>Default Length = 32 bytes</i>	An array of up to 32 BYTES	<p>The PDI data was received from the IO-Link device. May contain from 0 to 32 bytes of PDI data. The definition of the PDI data is device-dependent.</p> <p><i>Note: Length is configurable using the web page interface.</i></p>

13.1.2 Input Process Data Block-8 Bit Data Format

The following table provides detailed information about the Input Process Data Block-8 Bit data format.

Byte	Bit 7	Bit 0
0	Port Status	
1	Auxiliary I/O	
2	Event Code LSB	
3	Event Code MSB	
4	PDI Data Byte 0	
5	PDI Data Byte 1	
..	..	
..	..	
N+3	PDI Data Byte (N-1)	

13.1.3 Input Process Data Block-16 Bit Data Format

The following table provides detailed information about the Input Process Data Block-16 data format.

Word	Bit 15	Bit 8	Bit 7	Bit 0
0	Port Status		Auxiliary I/O	
1	Event Code			
2	PDI Data Word 0			
3	PDI Data Word 1			
..	..			
..	..			
N+1	PDI Data Word (N-1)			

13.1.4 Input Process Data Block-32 Bit Data Format

The following table provides detailed information about the Input Process Data Block-32 Bit data format.

Long Word	Bit 31	Bit 24	Bit 23	Bit 16	Bit 15	Bit 0
0	Port Status		Auxiliary I/O		Event Code	
2	PDI Data Long Word 0					
3	PDI Data Long Word 1					
..	..					
N	PDI Data Long Word (N-1)					

13.1.5 Output Process Data Block Description

The contents of the Output Process Data Block are configurable.

Parameter Name	Data	Description
Clear Event Code in PDO Block (Configurable option) <i>Default:</i> Not included	INT	If included, allows clearing of 16-bit event code received in the PDI data block via the PDU data block.
Include Digital Output(s) in PDO Data Block <i>Default:</i> Not included	INT	If included, allows setting the Digital Output Pins D2 and D4.
PDO Data <i>Default Length</i> = 32 bytes	An array of up to 32 BYTES	The PDO data are written to the IO-Link device. May contain from 0 to 32 bytes of PDO data. The definition and length of the PDO data are device-dependent. <i>Note:</i> Length is configurable via web page interface.

13.1.6 Output Process Data Block-8 Bit (SINT) Data Format

Without either the Clear Event Code in PDO Block or Include Digital Output(s) in PDO Data Block options selected:

Byte	Bit 7 Bit 0
0	PDO Data Byte 0
1	PDO Data Byte 1
..	..
..	..
N-1	PDO Data Byte (N-1)

With the Clear Event Code in PDO Block option selected and without the Include Digital Output(s) in PDO Data Block option selected:

Byte	Bit 7 Bit 0
0	Event Code LSB
1	Event Code MSB
2	PDO Data Byte 0
3	PDO Data Byte 1
..	..
..	..
N+1	PDO Data Byte (N-1)

With both the Clear Event Code in PDO Block and Include Digital Output(s) in PDO Data Block options selected:

Byte	Bit 7 Bit 0
0	Event code LSB
1	Event code MSB
2	Digital Output Settings: Bit 1 (0x02) - DI setting Bit 3 (0x08) - C/Q setting
3	0 (Unused)
4	PDO Data Byte 0
5	PDO Data Byte 1
..	..
..	..
N + 3	PDO Data Byte (N-1)

13.1.7 Output Process Data Block-16 Bit (INT) Data Format

Without either the Clear Event Code in PDO Block or Include Digital Output(s) in PDO Data Block options selected:

Word	Bit 15 Bit 0
0	PDO Data Word 0
1	PDO Data Word 1
..	..
..	..
N-1	PDO Data Word (N-1)

With the Clear Event Code in PDO Block option selected and without the Include Digital Output(s) in PDO Data Block option selected:

Word	Bit 15 Bit 0
0	Event Code
1	PDO Data Word 0
2	PDO Data Word 1
..	..
..	..
N	PDO Data Word (N-1)

With both the Clear Event Code in PDO Block and Include Digital Output(s) in PCO Data Block options selected:

Word	Bit 15 Bit 0
0	Event Code
1	Digital Output Settings: Bit 1 (0x02) - DI setting Bit 3 (0x08) - C/Q setting
2	PDO Data Word 0
3	PDO Data Word 1
..	..
..	..
N+1	PDO Data Word (N-1)

13.1.8 Output Process Data Block-32 Bit (DINT) Data Format

Without either the Clear Event Code in PDO Block or Include Digital Output(s) in PDO Data Block options selected:

Long Word	Bit 31 Bit 0
0	PDO Data Long Word 0
1	PDO Data Long Word 1
..	..
..	..
N-1	PDO Data Long Word (N-1)

With the Clear Event Code in PDO Block option selected and without the Include Digital Output(s) in PDO Data Block option selected:

Long Word	Bit 31 Bit 16	Bit 15 Bit 0
0	0	Event Code
1	PDO Data Long Word 0	
2	PDO Data Long Word 1	
..	..	
..	..	
N - 1	PDO Data Long Word (N-1)	

With both the Clear Event Code in PDO Block and Include Digital Output(s) in PDO Data Block options selected:

Long Word	Bit 31 Bit 16	Bit 15 Bit 0
0	Digital Output Settings: Bit 17 (0x2000) – DI setting Bit 19 (0x8000) – C/Q setting	Event Code
1	PDO Data Long Word 0	
2	PDO Data Long Word 1	
..	..	
..	..	
N - 1	PDO Data Long Word (N-1)	

13.2 Event Handling

The IOLM event handling is designed to provide real-time updates of event codes received directly from the IO-Link device. The IO-Link event code:

- Is included in the second 16-bit word of the Input Process Data (PDI) block.
 - An active event is indicated by a non-zero value.
 - Inactive or no event is indicated by a zero value.
- Two methods are provided to clear an event:
 - Enable the *Clear Event After Hold Time* option.
 - The IOLM keeps or holds, the active event code in the PDI block until the configured *Active Event Hold Time* has passed.
 - The IOLM then clears the event code in the PDI block and waits until the *Clear Event Hold Time* has passed before including another event code in the PDI block.
 - Enable the *Clear Event In PDO Block* option.
 - The IOLM monitors the PDO block received from the PLC.
 - The IOLM expects the first entry of the PDO block to indicate an event code to be cleared.
 - If there is an active event code in the PDI block and the PDO block both contain the same event code, the event code is cleared in the PDI block.
 - The IOLM then clears the event code in the PDI block and waits until the *Clear Event Hold Time* has passed before including another event code in the PDI block.
- The two methods can be used separately or together to control the clearing of events. The next subsections illustrate the event clearing process for the various event configurations.

13.2.1 Clear Event After Hold Time Process

Figure 94: Illustrates clearing the event after the hold time process.

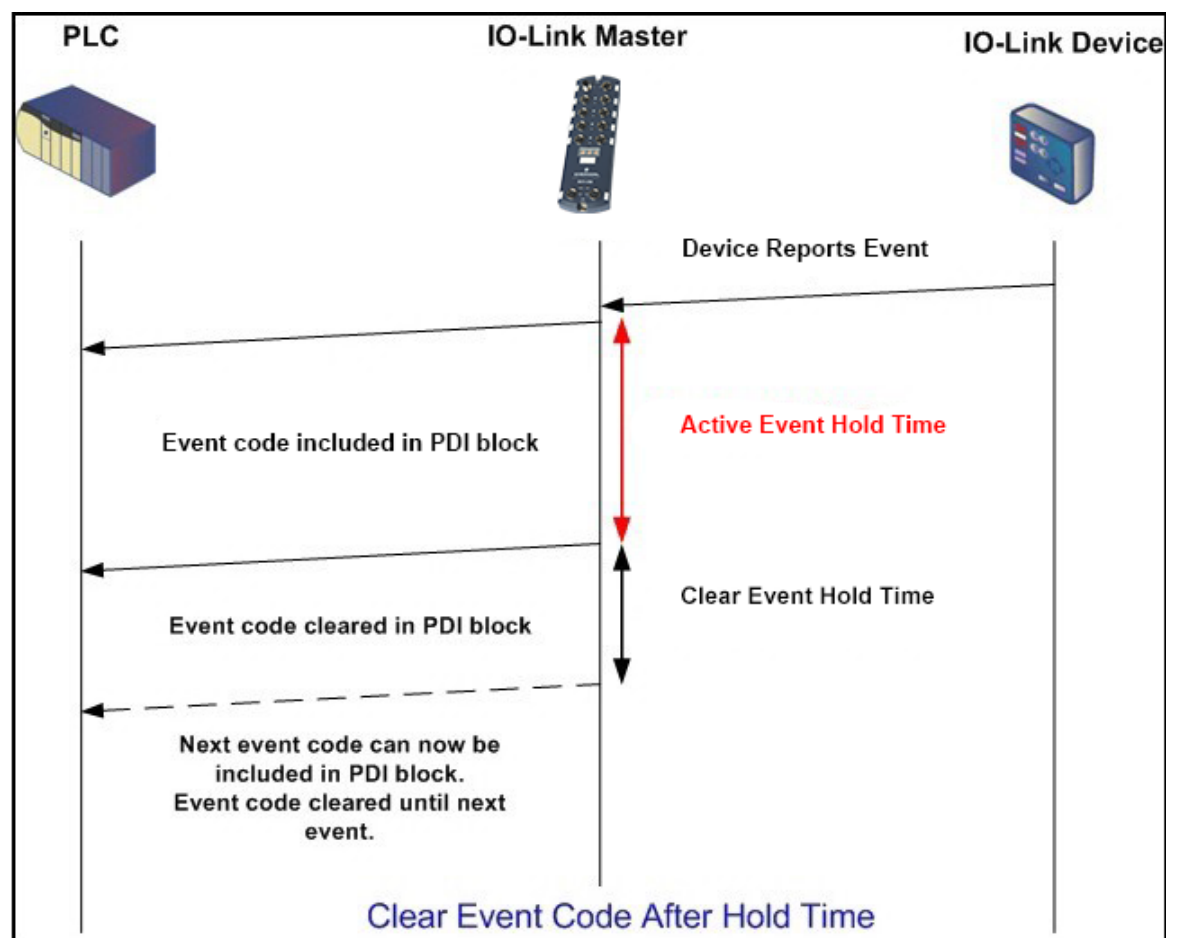

13.2.2 Clear Event in PDO Block Process

Figure 95: Illustrates Clearing the Event in the PDO Block Process

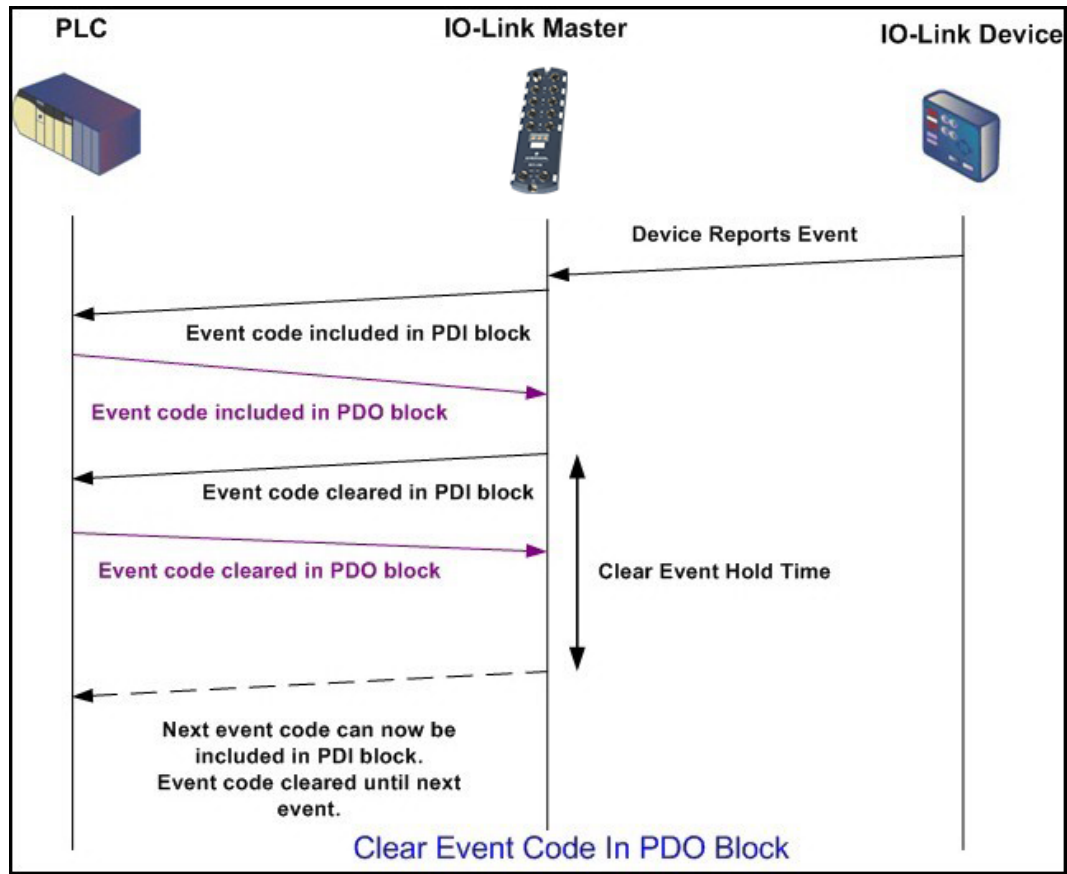

13.2.3 Clear Event Code in PDO Block and Clear Event After Hold Time Process- PDO Block First

Figure 96: Illustrates clearing the event code in the PDO block and clearing the event after the hold time process with the PDO block first.

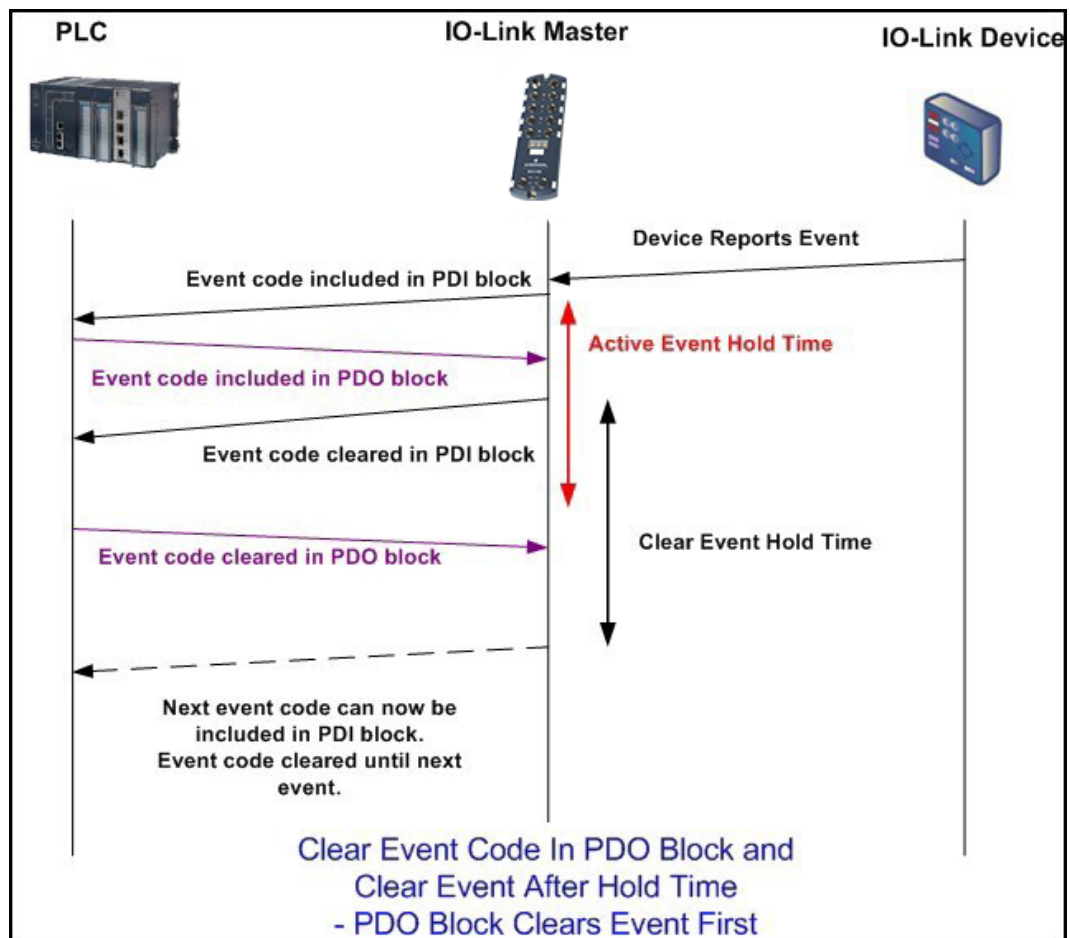

13.2.4 Clear Event Code in PDO Block and Clear Event After Hold Time Process- Hold Time Expires

Figure 97: Illustrates clearing the event code in the PDO block and clearing the event after the hold time process with the hold time expired

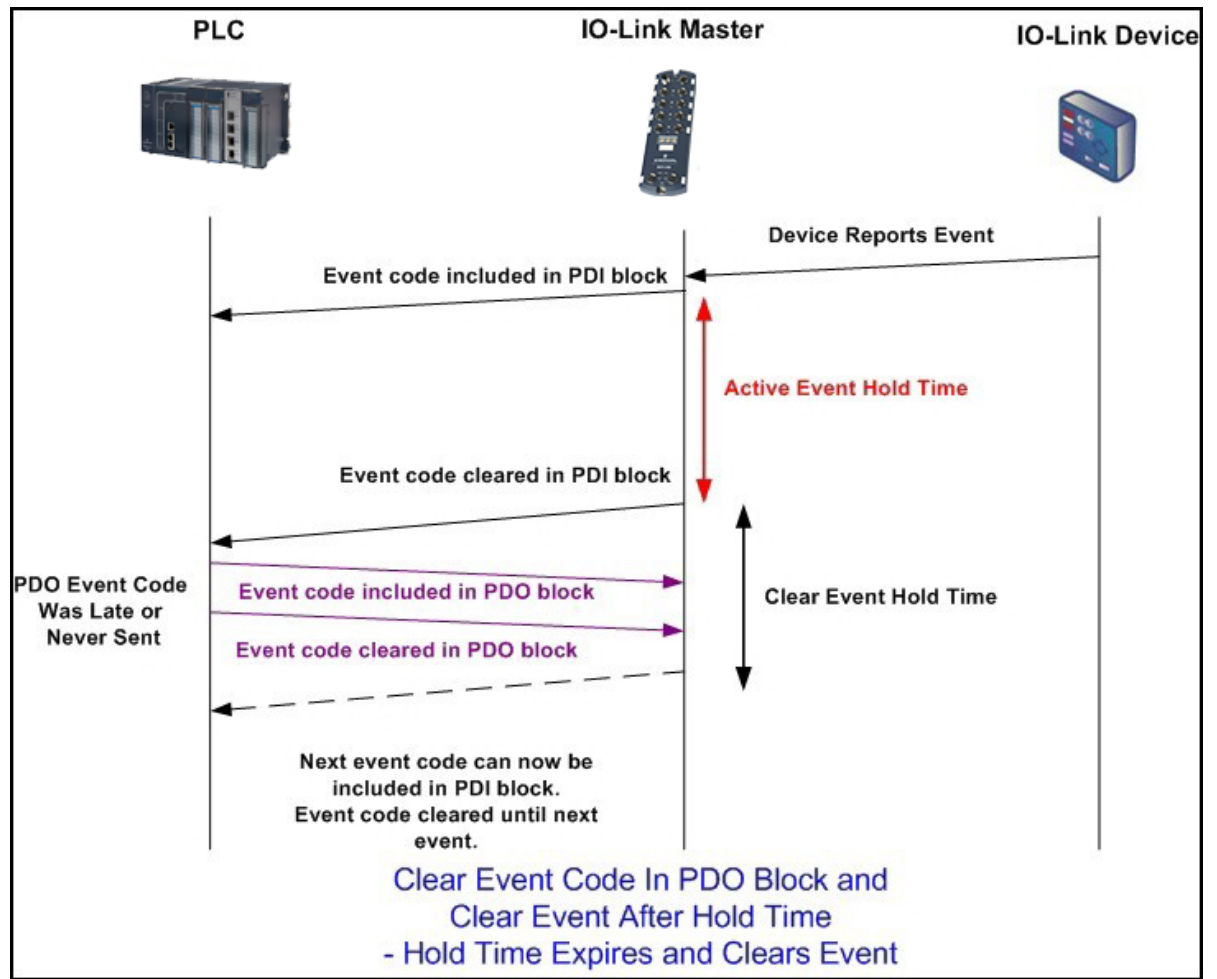

13.3 ISDU Handling

The IOLM provides a very flexible ISDU interface that is used by all supported industrial protocols. The ISDU interface contains the following:

- An ISDU *request* may contain one or multiple individual ISDU read and/or write *commands*.
- Individual ISDU command-based byte-swapping capabilities.
- Variable-sized command structures to allow access to a wide range of ISDU block sizes.
- A single ISDU request may contain as many ISDU read and/or write commands as allowed by the industrial protocol payload. For example, if an industrial protocol provides up to 500 bytes read/write payloads, then an ISDU request may contain multiple commands of various lengths that can total up to 500 bytes in length.
- For the ControlLogix family of EtherNet/IP PLCs, both blocking and non-blocking ISDU request methods are provided.
 - The IOLM implements blocking ISDU requests by not responding to an ISDU request message until all commands have been processed.
 - The IOLM implements non-blocking ISDU requests by:
 - Respond to an ISDU request message immediately after receiving and verifying the ISDU request.
 - Requiring the PLC to monitor the ISDU request status with read messages. The IOLM will not return a completed status until all of the ISDU commands have been processed.

13.3.1 ISDU Request/Response Structure

ISDU requests may contain a single command or multiple, nested commands. This subsection discusses the following:

Single ISDU Command Request

This illustrates a single ISDU command request.

Figure 98: Single Command ISDU Request/Response

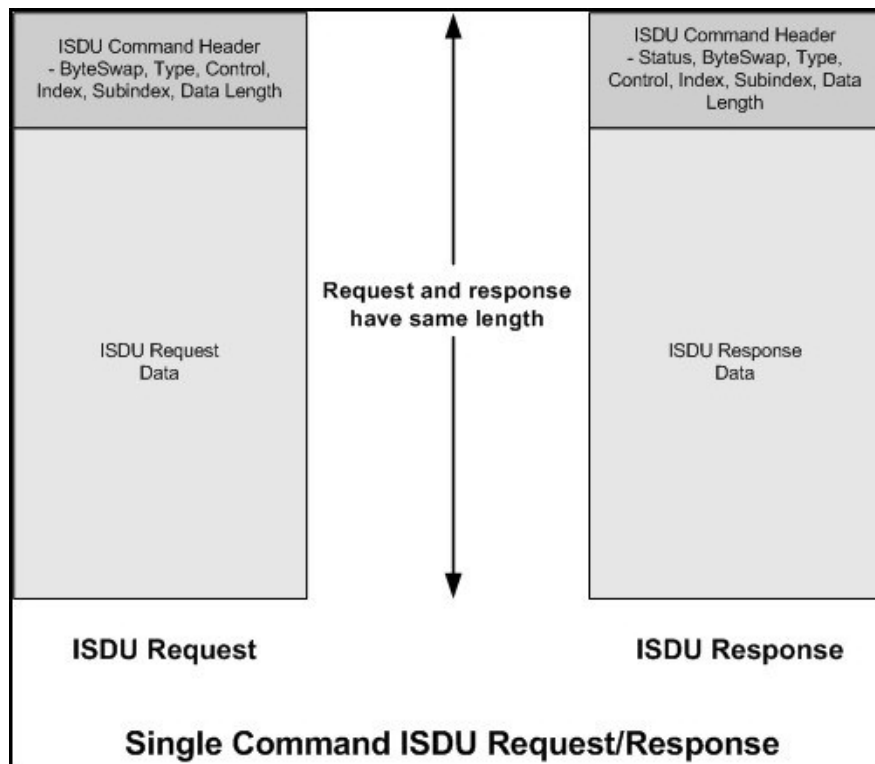

Multiple ISDU Command Structure

ISDU requests with multiple commands may consist of commands of the same data size or commands with different data sizes. The following are two examples of multiple ISDU commands.

- ISDU commands of the same data size ([Page 201](#))
- ISDU commands of different data sizes ([Page 202](#))

Multiple Command ISDU Request/Response of Same Data Area Length

Figure 99: Multiple Command ISDU Request/Response of Different Data Lengths

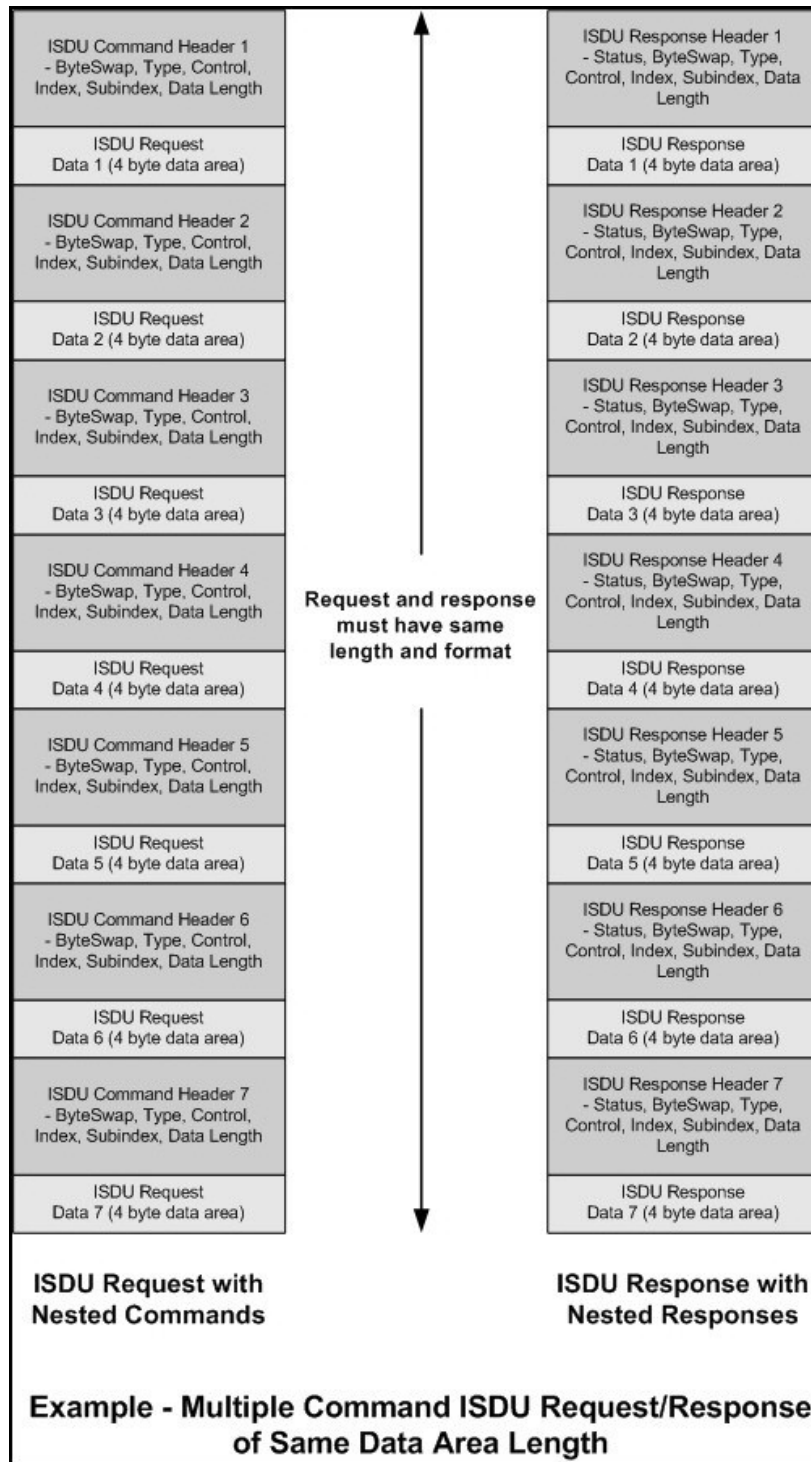
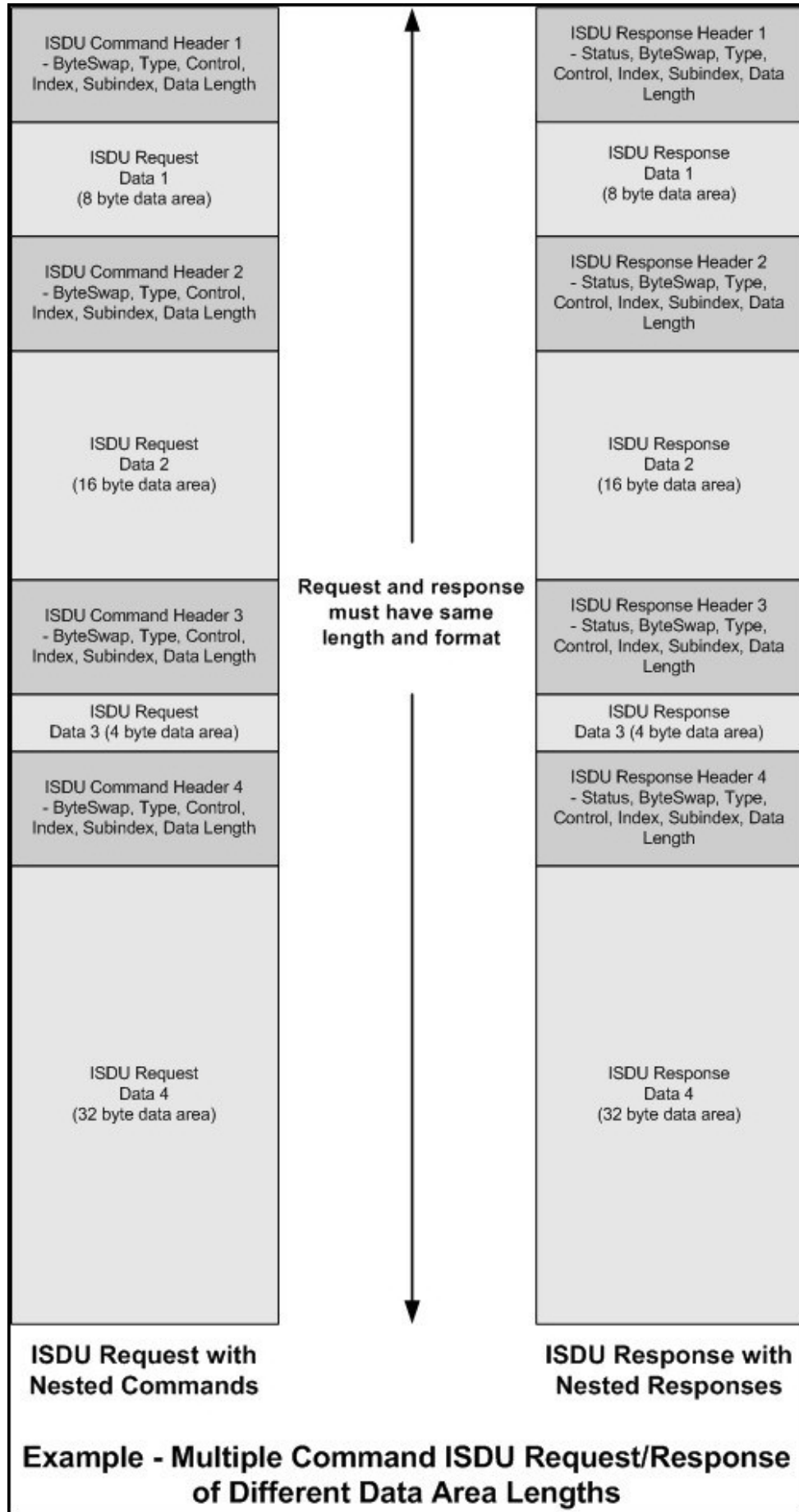

Figure 100: SDU Request Message Format-From PLC to IOLM



Write and read ISDU commands that have the same message data format. Each ISDU request message is comprised of one or more commands. The command(s) can consist of either a series of nested commands or a single read command.

Note: A list of nested ISDU commands is terminated with either a control field of 0 (single/last operation) or the end of the message data.

Standard ISDU Request Command Format

This table displays a standard ISDU request command format with ControlLogix PLCs.

Name	Data Type	Parameter Descriptions
Byte Swapping	USINT	Bits 0-3: 0= No byte swapping.
		1= 16-bit (INT) byte swapping of ISDU data. 2= 32-bit (DINT) byte swapping of ISDU data. Bits 4-7: Set to zero. Unused.
RdWrControlType	USINT	Provides the control and type of ISDU command. Bits 0-3, Type Field: 0 = NOP (No operation) 1 = Read operation 2 = Write operation 3 = Read/Write "OR" 4 = Read/Write "AND" Bits 4-7, Control Field: 0 = Single/Last Operation (length can vary from to 1 to 232) 1 = Nested batch command – fixed 4 byte data area 2 = Nested batch command – fixed 8-byte data area 3 = Nested batch command – fixed 16 byte data area 4 = Nested batch command – fixed 32 byte data area 5 = Nested batch command – fixed 64 byte data area 6 = Nested batch command – fixed 128 byte data area 7 = Nested batch command – fixed 232 byte data area
Index	UINT	The parameter address of the data objects in the IO-Link device.
Subindex	UINT	The data element address of a structured parameter of the data objects in the IO-Link device.
Datalength	UINT	Length of data to read or write. For nested batch commands, the data length can vary from 1 to the fixed data area size.
Data	An array of USINTs, UINTs, or UDINTs.	The size of an array is determined by the Control field in RdWrControlType. Note: Data is valid only for write commands.

Integer (16-Bit Word) ISDU Request Command Format

This table shows an integer (16-bit word) ISDU request command format with an SLC, MicroLogix, PLC-5, or Modbus/TCP.

Name	Data Type	Parameter Description
Byte Swapping / RdWrControlType	UINT	Provides the control, type, and byte swapping of the ISDU command Bits 0-3, Type Field: 0 = NOP (No operation) 1 = Read operation 2 = Write operation 3 = Read/Write “OR” 4 = Read/Write “AND” Bits 4-7, Control Field: 0 = Single/Last Operation (length can vary from to 1 to 232) 1 = Nested batch command – fixed 4 byte data area 2 = Nested batch command – fixed 8-byte data area 3 = Nested batch command – fixed 16-byte data area 4 = Nested batch command – fixed 32-byte data area 5 = Nested batch command – fixed 64-byte data area 6 = Nested batch command – fixed 128-byte data area 7 = Nested batch command – fixed 232-byte data area Bits 8-11: 0= No byte swapping. 1= 16-bit (INT) byte swapping of ISDU data. 2= 32-bit (DINT) byte swapping of ISDU data. Bits 12-15: Set to zero. Unused.
Index	UINT	The parameter address of the data objects in the IO-Link device.
Subindex	UINT	The data element address of a structured parameter of the data objects in the IO-Link device.
Datalength	UINT	Length of data to read or write. For nested batch commands, the data length can vary from 1 to the fixed data area size.
Data	An array of USINTs, UINTs, or UDINTs.	The size of an array is determined by the Control field in RdWrControlType. Note: Data is valid only for write commands.

ISDU Response Message Format

Standard ISDU Response Command Format

The following table shows the standard ISDU response command format with ControlLogix PLCs.

Name	Data Type	Parameter Description
Status	USINT	Indicates the byte alignment and status of the command response. Byte swapping, bits 0-3: 0= No byte swapping. 1= 16-bit (INT) byte swapping of TX/RX ISDU data. 2= 32-bit (DINT) byte swapping of TX/RX ISDU data. Status, bits 4-7: 0 = NOP (No operation) 1 = In process (Only valid for non-blocking requests) 2 = Success 3 = Failure: IO-Link device rejected the request. 4 = Timed out: IO-Link device did not respond

RdWrControlType	USINT	Provides the control and type of ISDU request Bits 0-3, Type Field: 0 = NOP (No operation) 1 = Read operation 2 = Write operation 3 = Read/Write “OR” 4 = Read/Write “AND” Bits 4-7, Control Field: 0 = Single/Last Operation (length can vary from to 1 to 232) 1 = Nested batch command – fixed 4 byte data area 2 = Nested batch command – fixed 8 byte data area 3 = Nested batch command – fixed 16 byte data area 4 = Nested batch command – fixed 32 byte data area 5 = Nested batch command – fixed 64 byte data area 6 = Nested batch command – fixed 128 byte data area 7 = Nested batch command – fixed 232 byte data area
Index	UINT	The parameter address of the data objects in the IO-Link device.
Subindex	UINT	The data element address of a structured parameter of the data objects in the IO-Link device.
Datalength	UINT	Length of data that was read or written. For nested batch commands, the data length can vary from 1 to fixed data area size.
Data	An array of USINTs, UINTs, or UDINTs.	Data required for read commands. Optionally can return the data of a write command. The size of the array is determined by the Control field in the RdWrControlType. <i>Note: Data field not required for single NOP commands.</i>

Integer (16-Bit Word) ISDU Response Command Format

The following table shows an integer (16-bit word) ISDU response command format with SLC, MicroLogix, PLC-5, or Modbus/TCP.

Name	Data Type	Parameter Descriptions
Status, Byte-Swapping, RdWrControlType	UINT	Indicates the control, type, byte-swapping, and status of the ISDU command. Bits 0-3, Type Field: 0 = NOP (No operation) 1 = Read operation 2 = Write operation 3 = Read/Write “OR” 4 = Read/Write “AND” Bits 4-7, Control Field: 0 = Single/Last Operation (length can vary from to 1 to 232) 1 = Nested batch command – fixed 4 byte data area 2 = Nested batch command – fixed 8-byte data area 3 = Nested batch command – fixed 16-byte data area 4 = Nested batch command – fixed 32-byte data area 5 = Nested batch command – fixed 64-byte data area 6 = Nested batch command – fixed 128-byte data area 7 = Nested batch command – fixed 232-byte data area Byte swapping, bits 8-11: 0= No byte swapping. 1= 16-bit (INT) byte swapping of TX/RX ISDU data. 2= 32-bit (DINT) byte swapping of TX/RX ISDU data. Status, bits 12-15: 0 = NOP (No operation) 1 = In process (Only valid for non-blocking requests) 2 = Success 3 = Failure: IO-Link device rejected the request. 4 = Timed out: IO-Link device did not respond

Index	UINT	The parameter address of the data object in the IO-Link device
Subindex	UINT	The data element address of a structured parameter of the data objects in the IO-Link device.
Datalength	UINT	Length of data that was read or written. For nested batch commands, the data length can vary from 1 to fixed data area size.
Data	An array of USINTs, UINTs, or UDINTs	Data returned for read commands. Contains the data of a write command. The size of the array is determined by the Control field in RdWrControlType. <i>Note: Data field not required for single NOP commands.</i>

13.3.2 ISDU Blocking and Non-Blocking Methods

The IOLM supports both blocking and non-blocking ISDU requests. The following diagrams demonstrate how each mode works.

Single Command Blocking

Figure 101: Illustrates the Single Command Blocking Method

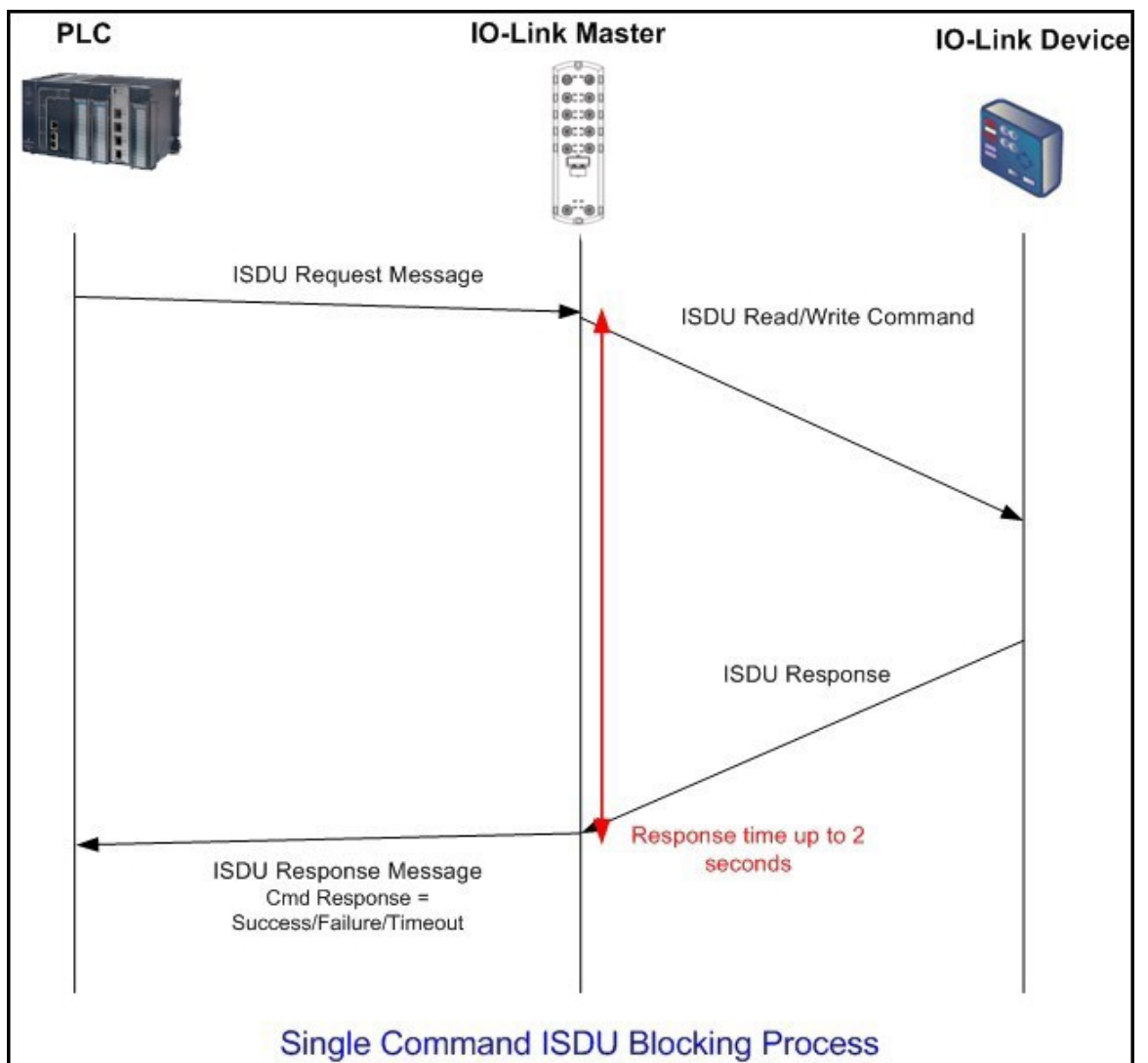

Multiple Command Blocking

Figure 102: Illustrates the Multiple Command Blocking Method

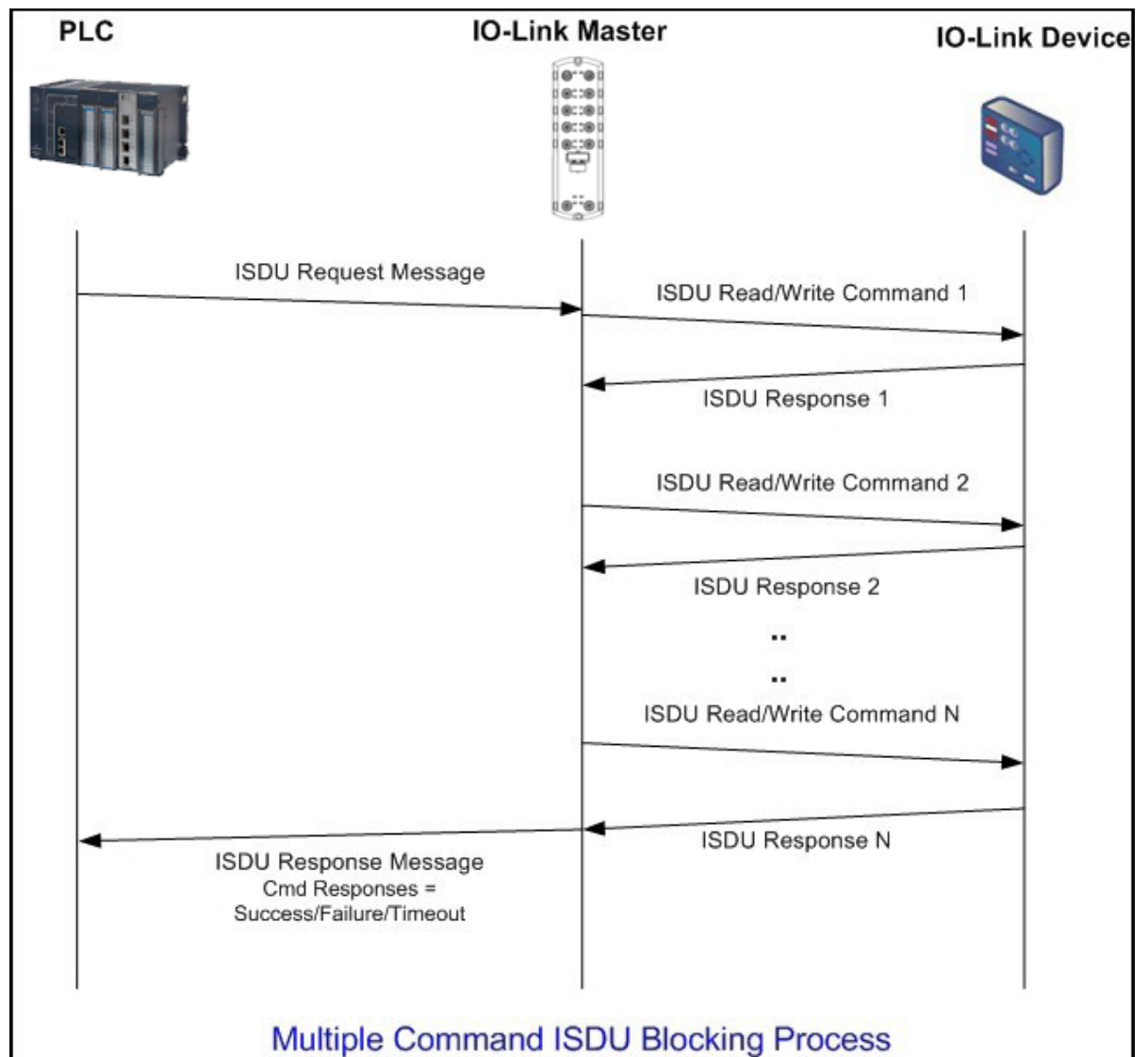

Single Command Non-Blocking

Figure 103: Illustrates the Single Command Non-Blocking Method

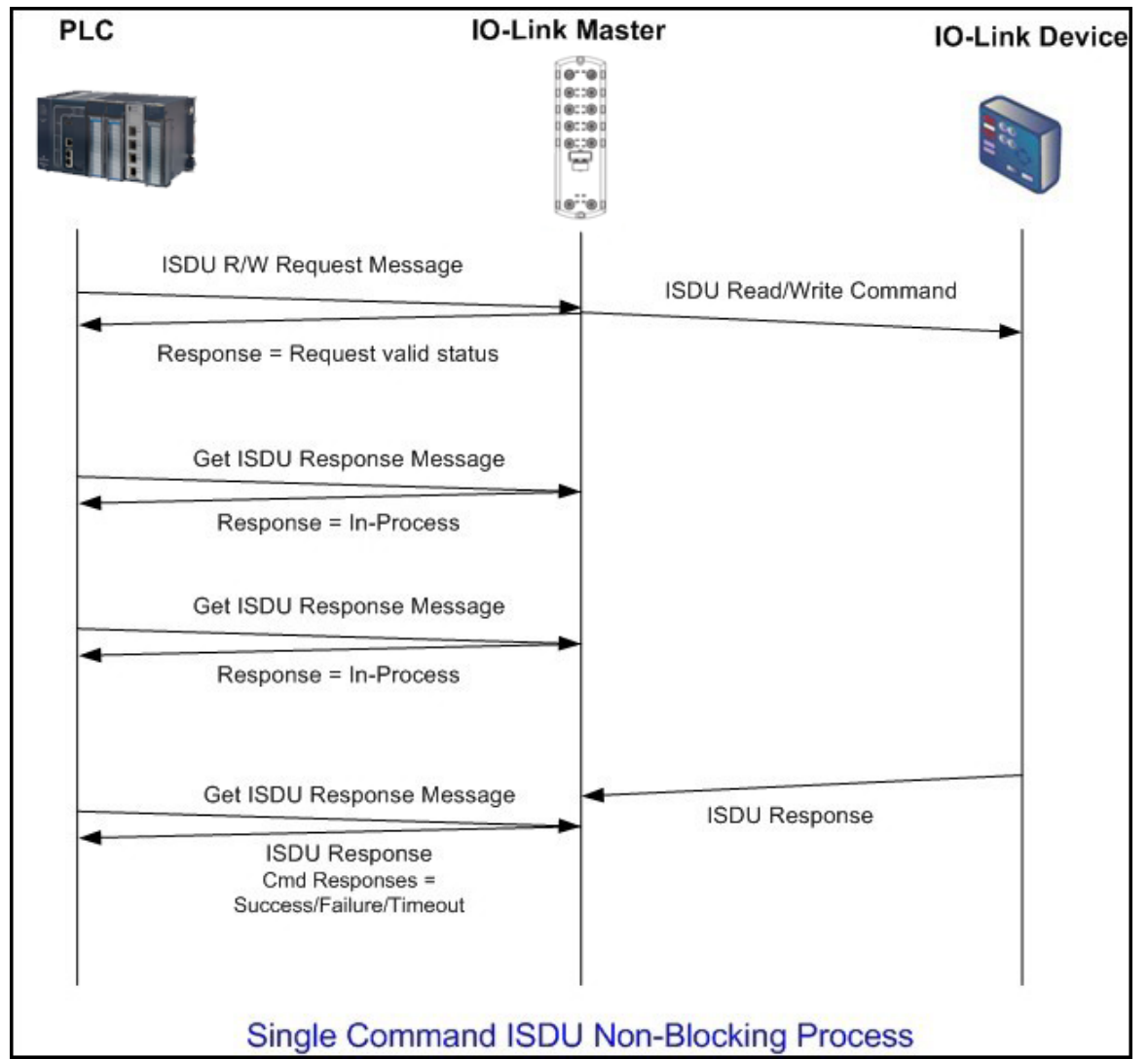

Multiple Command Non-Blocking

Figure 104: Illustrates the Multiple Command Non-Blocking Method

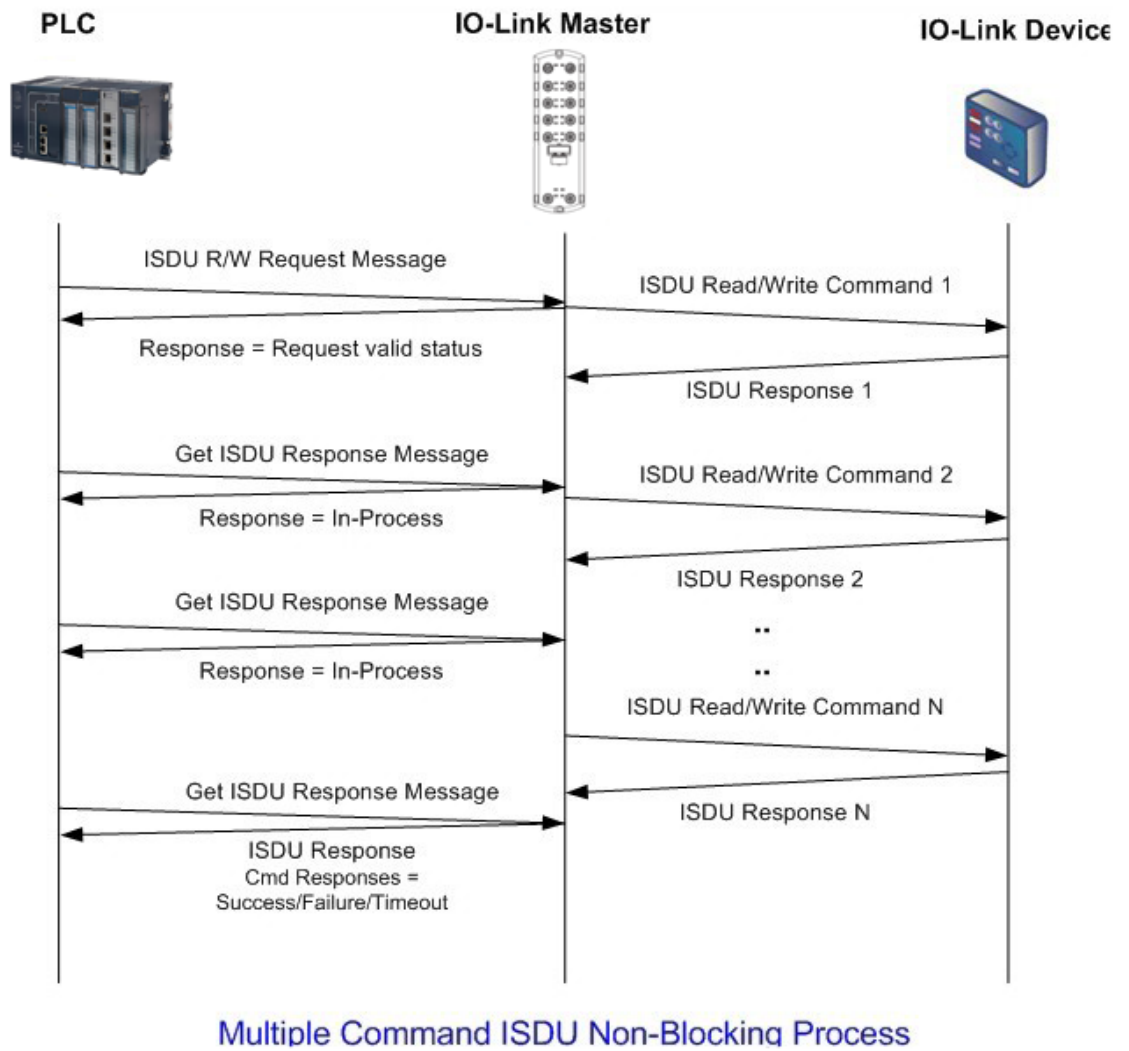

Section 14: Troubleshooting

This section provides the following information:

- Troubleshooting
- IOLM LEDs
- Using Log Files

14.1 Troubleshooting

Before contacting Technical Support, you may want to try the following:

- Check to make sure LEDs are not reporting an issue using [IOLM LEDs](#) on Page 212.
- Verify that the network IP address, subnet mask, and gateway are correct and appropriate for the network. Make sure that the IP address programmed into the IO-Link Master matches the unique reserved IP configured address assigned by the system administrator.
- If using DHCP, the host system needs to provide the subnet mask. The gateway is optional and is not required for a purely local network.
- Remember that if the rotary switches on the IOLM 4-PNIO are set to anon-default position, the rotary switches override the lower 3 digits (8 bits) of the static IP address configured in the **Network** page.
- Verify that the Ethernet hub and any other network devices between the system and the IO-Link Master are powered up and operating.
- Verify that you are using the correct types of cables on the correct connectors and that all cables are connected securely.
- Disconnect and re-connect the IO-Link device, or optionally, use the **Configuration | IO-Link** page to **Reset** the port, and then set the **Port Mode** back to **IO-Link**.
- Reboot or power cycle the IOLM. Use the **Advanced | Software** page to reboot the IOLM.
- Verify that the **Port Mode** matches the device, for example: IO-Link, Digital In, Digital Out, or Reset (port is disabled).
- If you are receiving an error that indicates a hardware fault, check the **Configuration | IO-Link** page for the port experiencing the fault.
- Check the settings for the **Automatic Upload Enable** and **Automatic Download Enable** options. If the Vendor ID or Device ID of the attached device does not match, a hardware fault is generated.
- Make sure if the port contains data storage that the Vendor ID and Device ID match the device attached to the port. If it does not, **CLEAR** the data storage or move the device to another port.
- Check the Device Validation and Data Validation settings. If the attached device does not meet these settings, a hardware fault is issued.
- Open the IO-Link Master web interface and review the following pages to see if you can locate a problem:
 - IO-Link Diagnostics
 - Modbus/TCP Diagnostics
 - OPC UA Diagnostics
 - PROFINET IO
 - MQTT Diagnostics
- If you have a spare IO-Link Master, try replacing the IO-Link Master.

14.2 IOLM LEDs

14.2.1 IOLM LEDs

The IOLM (8-port IP67 model with an L-coded power connector) provides these LEDs.

LED Activity During Power-On Sequence - IOLM	
The US LED lights.	
The ETH1/ETH2 LED lights on the connected port.	
The MOD and NET LEDs are lit.	
The IO-Link LEDs flash (if no IO-Link device is attached) or are lit if an IO-Link device is attached.	
If a PLC is connected, the NET LED is lit and green.	

IOLM LEDs	
US	The US LED provides the following information: Green solid = The IO-Link Master is powered. Red solid = Power input voltage below 18VDC.
UA	The UA LED provides the following information: Green solid = The IO-Link Master is powered. Red solid = Power input voltage below 18VDC.
MOD (Module Status)	The MOD LED provides the following information: Off = No errors or there is no PLC connection Green and red flashing = Self-test Green flashing = Standby – not configured Green solid = Operational Red flashing: One or more errors detected when NET is off Fatal error when NET is also flashing Red solid = Maintenance required or demanded
NET (Network)	The NET LED provides the following information: Off = No PLC connection Green and red flashing = Self-test Green flashing = An IP address is configured, but no connections are established Green solid = PLC connection established Red flashing = Fatal error when MOD is also flashing Red solid = Duplicate IP address on a network
1 - 8 	This LED provides the following information about the IO-Link port. Off = SIO mode - signal is low or disabled Yellow = SIO mode - signal is high Red flashing = Hardware fault - make sure that configured IO-Link settings on the port do not conflict with the device that is attached: Automatic Upload and/or Download is enabled and it is not the same device. Device Validation Mode is enabled and it is not the correct device. Data Validation Mode is enabled but there is an error. Solid red = PDI of the attached IO-Link device is invalid. Green solid = An IO-Link device is connected and communicating Green flashing = Searching for IO-Link devices
Port 1-4 DI	The DI LED indicates digital input on DI (Pin 2). Of = DI signal is low or disconnected Yellow = DI signal is high
ETH1/ETH2	The ETH1/ETH2 LEDs provide the following information: Green solid = Link Green flashing = Activity

14.3 Contacting Technical Support

You may want to access the **Help/SUPPORT** page when you call Technical Support, as they may request the information displayed on the **SUPPORT** page.

Figure 105: Support Page

The screenshot shows the 'Support' page in the Emerson RSTi-OM web interface. The page has a blue header with navigation links: HOME, DIAGNOSTICS, CONFIGURATION, ADVANCED, ATTACHED DEVICES, and SUPPORT. Below the header is a sub-header with links: HELP, SUPPORT, and CONTACT. The main content area is titled 'Support' and includes a 'DOWNLOAD' button. The page displays two tables of system information.

SYSTEM INFO	
Host Name	rstiom-h
Serial Number	9760-065534
Model Name	RSTi-OM IO-Link Master, 8 Ch, IP67
Catalog Number	OMIOLM001
Hardware Version	99760-3 rev AAAA
Switch Position	000
MAC Address	00:09:91:ae:9a:58
IP Address	192.168.3.2
Subnet Mask	255.255.255.0
Gateway Address	0.0.0.0
IP Type	static

APPLICATION BASE	
application-manager	1.6.0.1
configuration-manager	1.6.0.0
discovery-protocol	1.6.0.2
event-log	1.6.0.0
iolink-driver	1.6.0.6
libiolinkutils	1.6.0.12
modbus	1.6.0.7
mqtt	1.6.0.4
opcua-server	1.6.0.1
profinetio	1.6.0.6

192.168.3.2

14.4 Using Log Files

The IO-Link Master provides five different log files that you can view, export, or clear:

- **Syslog** (system log) displays line-by-line activity records.
- **dmesg** displays Linux kernel messages.
- **top** displays which programs are using most of the memory and CPU.
- **ps** displays the running programs
- **pnio** displays PROFINET IO activity
- All log files start up automatically during the startup cycle. Each log file has a size limit of 100KB. **Note:** Typically, log files are intended to be used by Technical Support in the event there is a problem. You can use the following procedures to:
 - View a Log File
 - Clear a Log File
 - Export a Log File

14.4.1 View a Log File

Use this procedure to view a log file.

1. Open your browser and enter the IP address of the IO-Link Master.
2. Click **Advanced** and then **LOG FILES**.
3. Select the log file type from the drop-list.
4. Optionally, click the **REFRESH** button to get the latest information.
5. Optionally, export the log file.

Figure 106: Log Files

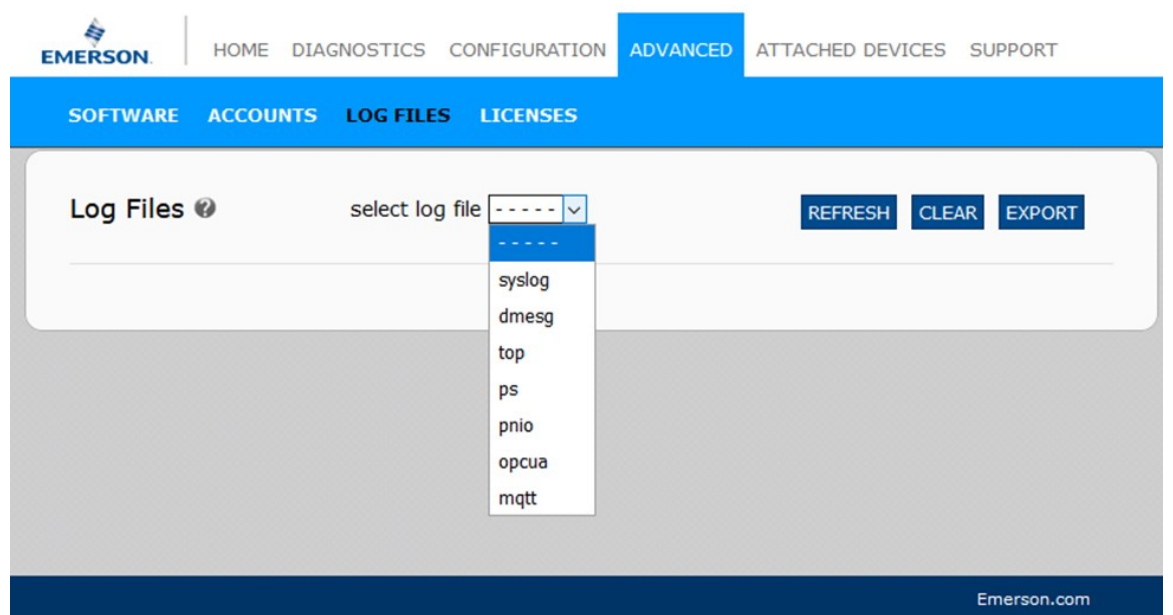

14.4.2 Export a Log File

Use the following procedure to export a log file.

1. Open your browser and enter the IP address of the IO-Link Master.
2. Click **Advanced** and then **LOG FILES**.
3. Select the log file type from the drop-list.
4. Click the **EXPORT** button.
5. Click the **Save** button drop-list and click **Save** to save it to your user folder or **Save as** to browse to or create a new folder in which to place the log file.
6. Depending on your browser, you may need to close the pop-up window.

Figure 107: Syslog

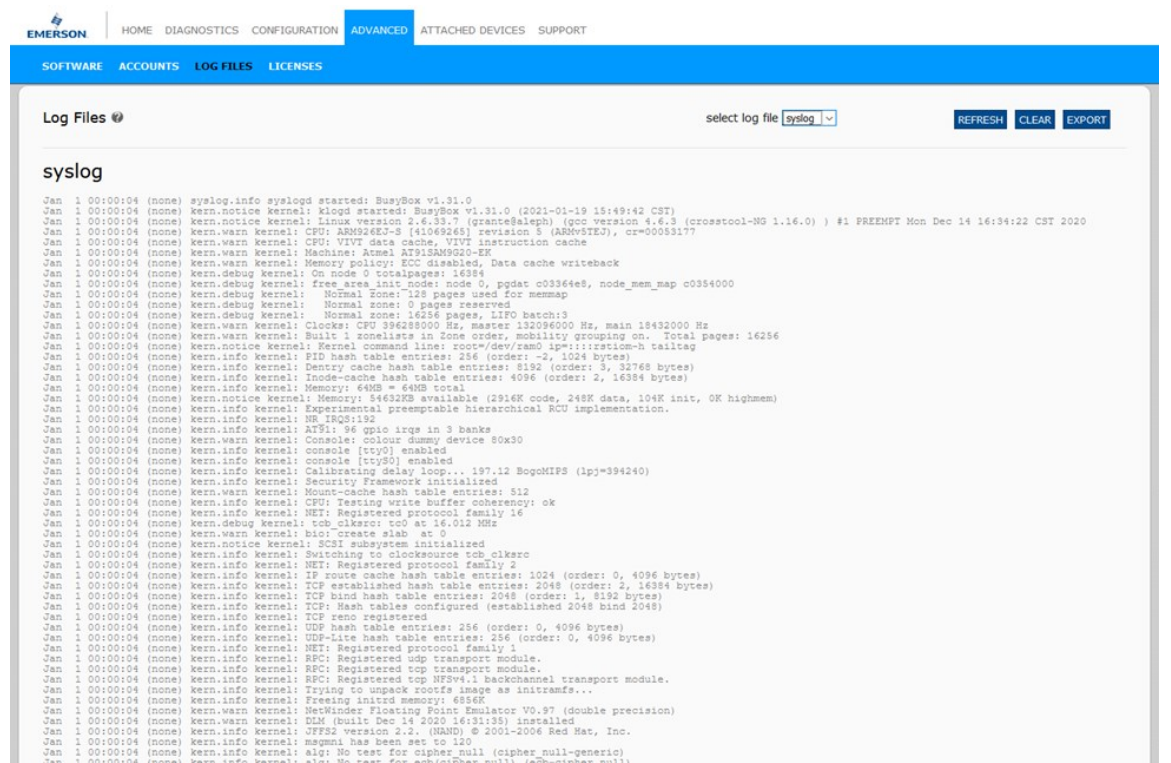

14.4.3 Clear a Log File

Use this procedure to clear a log file.

1. Open your browser and enter the IP address of the IO-Link Master.
2. Click Advanced and then LOG FILES.
3. Optionally, export the log file.
4. Select the log file type from the drop-list.
5. Click the **CLEAR** button.

Figure 108: Clear Log Files

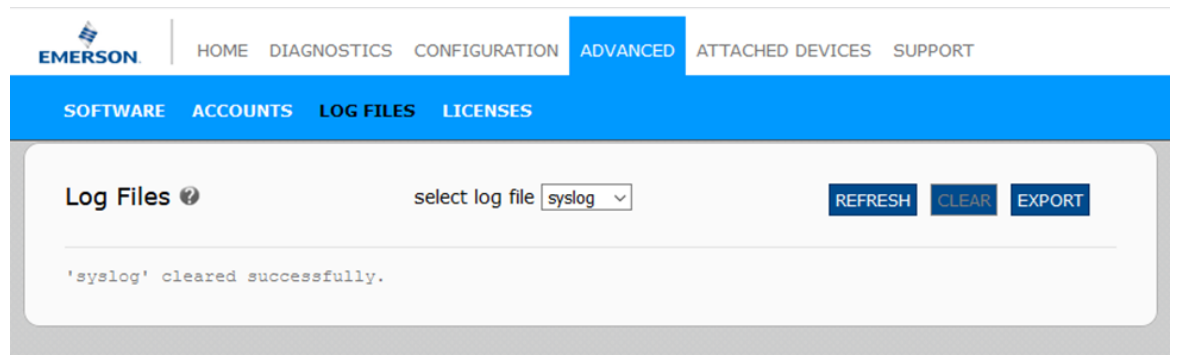

The log file automatically starts logging the latest information.

Appendix A: IO-Link Master Splitter Cables

There are two applications in which a splitter is required for use with the OMIOLM001 module:

- Injecting additional input/auxiliary input in addition to standard IO-Link signal
- Providing power to class B IO-Link devices

Connection of splitter to IO-Link devices and power supply would require A-coded cables, refer to datasheet for the available cables and ordering information.

A.1 Application #1: Injecting Additional/Auxiliary Input (Reference Part # V1S-T-V1)

IO-Link master ports support the connection of standard Class A IO-Link devices and the option to connect additional inputs to the same port. The status of the input is updated in the auxiliary memory area of the PDI. Figure 109 shows the connection of the OMIOLM001 Class A port to the IO-Link device and input device.

Figure 109: Standard IO-Link Signal with Additional Inputs

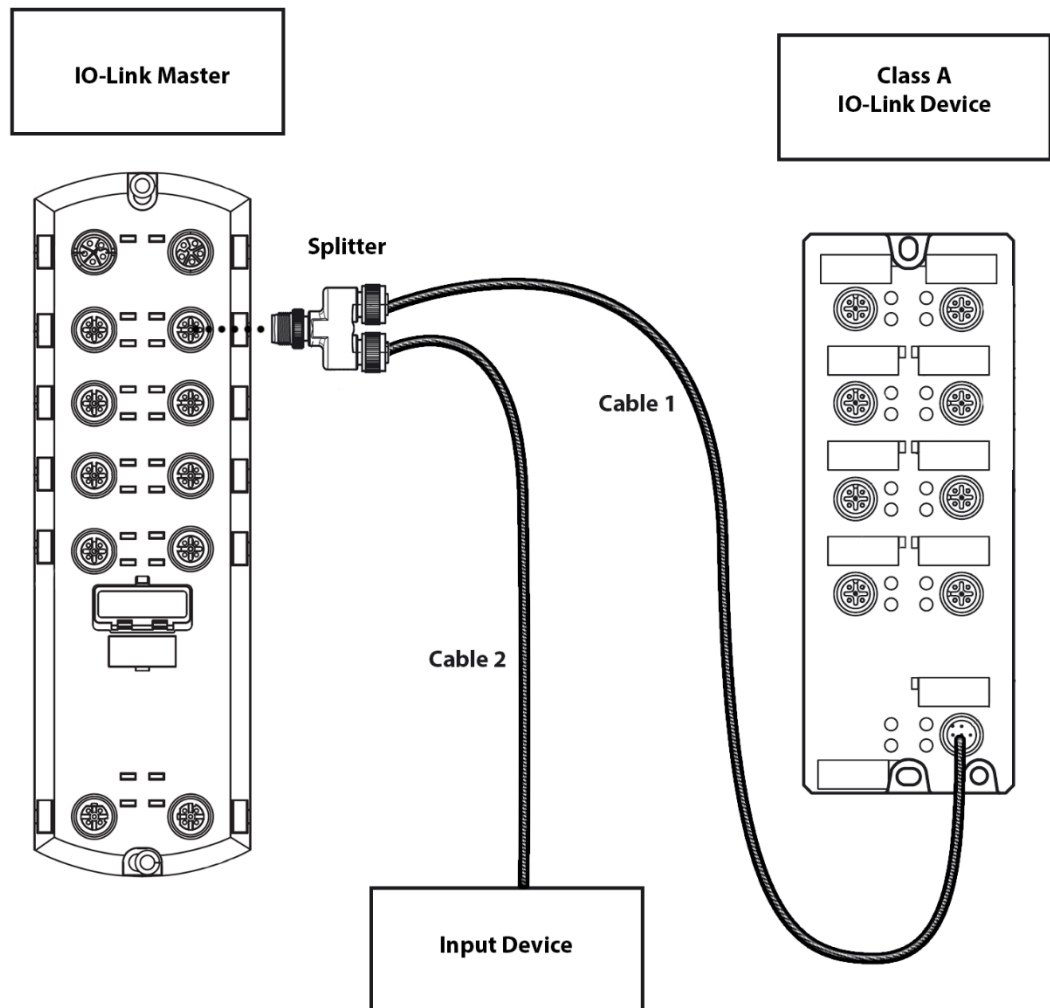

1. Connect the male end of the splitter (V1S-T-V1) to the IO-Link port on the OMIOLM001 module.
2. Connect one of the female connectors to a Class A IO-Link device.
3. Connect the other female connector to the input device.

Cable Pin Assignments

The following cable assignments are references for Figure 109.

Figure 110: Cable 1 Pin Assignment

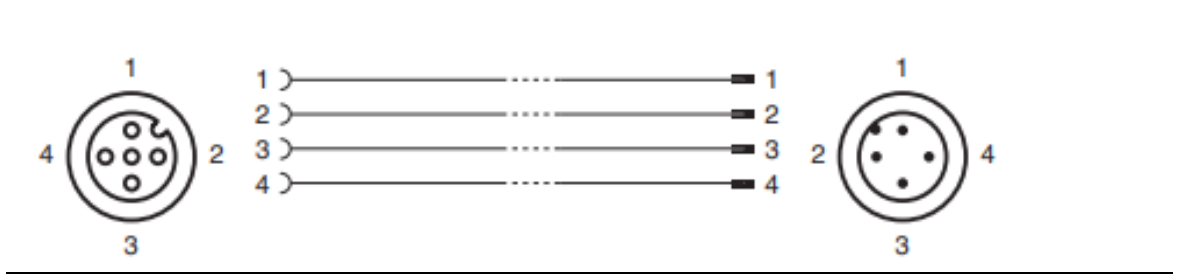
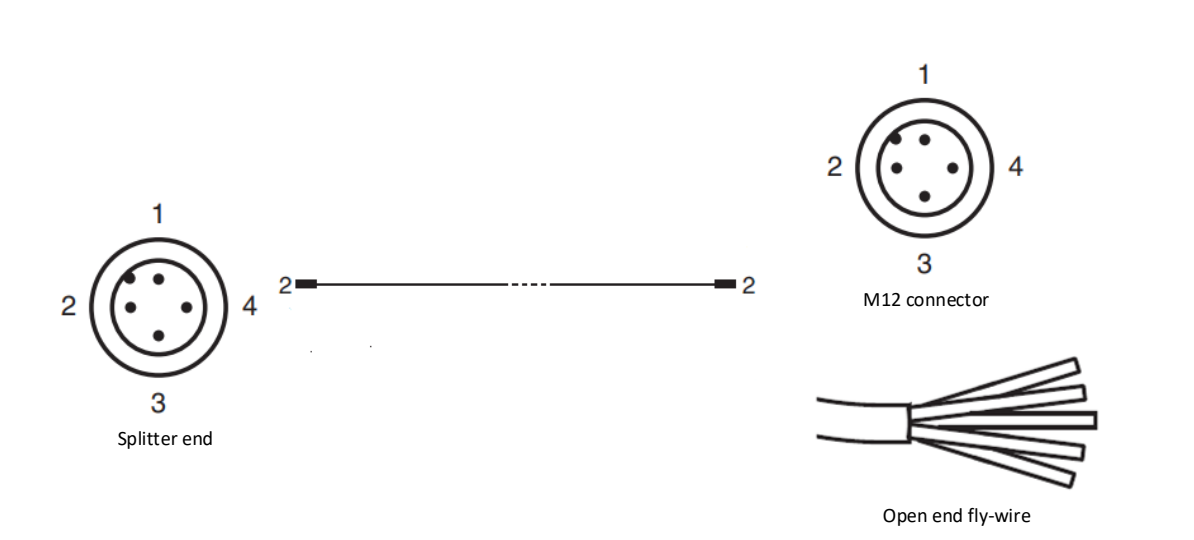

Figure 111: Cable 2 Pin Assignment



A.2 Application #2: Providing Power to a Class B IO-Link Device (Reference part # V15S-YEE-V15/V15)

When connecting a Class B IO-Link device, the device will require an actuator supply on pin 2 of the A-coded cable. Figure 112 shows how to connect the splitter and Class B device to the IO-Link master module.

Figure 112: Splitter Connection from Class B Power Device to the IOLM

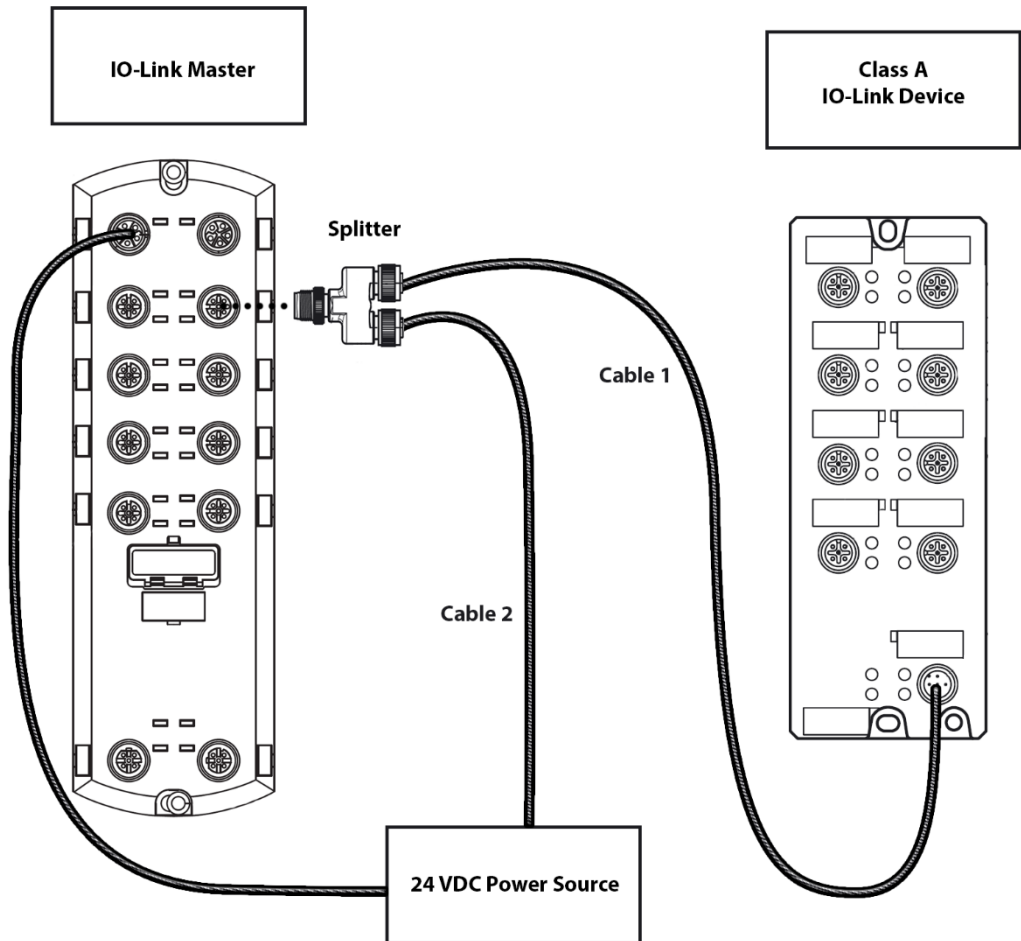

1. Connect the male end of the splitter is connected to the IO-Link port on the OMIOLM001 module.
2. Connect one of the female ends of the splitter to the IO-Link device. (For example, Pepperl+Fuchs IO-Link hub – Part # ICA-10DI6DO-G60A-IO.)
3. Connect the other female end to the power source either by using:
 - An A-code cable with an M12 connector on both ends
 - An A-code cable with an M12 connector on the splitter end and a fly-wire on the opposite end

Ensure the IP67 integrity is maintained when connecting to the power supply either using an M12 connector or fly-wire.

It is recommended to use the same power source for the OMIOLM001 and for the splitter to avoid grounding issues.

The digital input (DI) LED on the corresponding port to which the splitter is connected will be ON to indicate the AUX power is fed to the Class B IO-Link device/hub.

Note: Using the splitter to power the class-B IO-Link device/hub will eliminate the option of connecting an auxiliary input to the IO-Link master port. In other words, Applications #1 and #2 are discrete and cannot be mixed.

Cable 1 pin assignments

The following cable pin assignments are references for Figure 112.

Figure 113: Cable 1 Pin Assignments



Figure 114: Cable 2 Pin Assignments

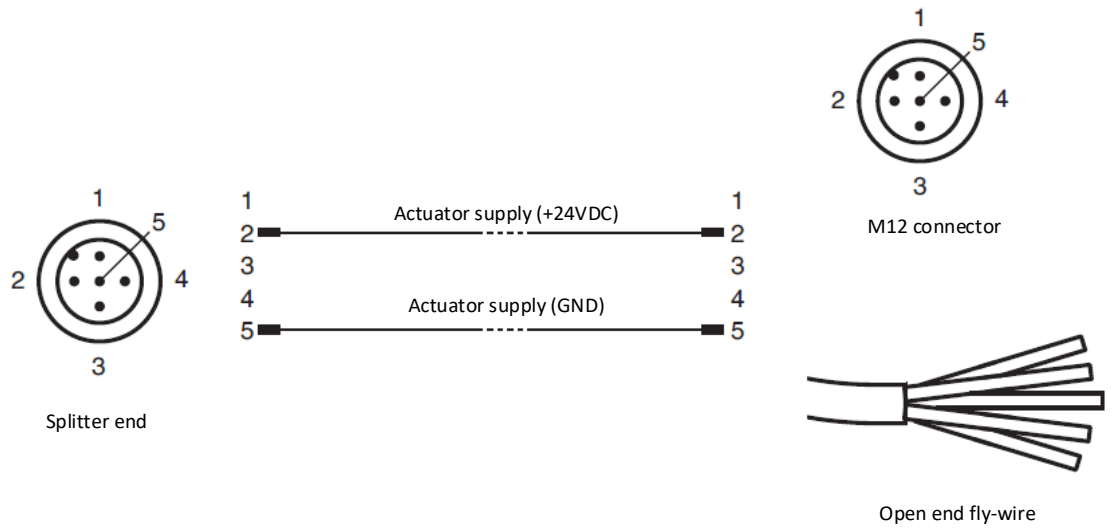

General Contact Information

Home link: <http://www.emerson.com/industrial-automation-controls>

Knowledge Base: <https://www.emerson.com/industrial-automation-controls/support>

Technical Support

Americas

Phone: 1-888-565-4155
1-434-214-8532 (If toll-free option is unavailable)
Customer Care (Quotes/Orders>Returns): customercare.mas@emerson.com
Technical Support: support.mas@emerson.com

Europe

Phone: +800-4444-8001
+420-225-379-328 (If toll-free option is unavailable)
+39-0362-228-5555 (from Italy - if toll-free 800 option is unavailable or dialing from a mobile telephone)
Customer Care (Quotes/Orders>Returns): customercare.emea.mas@emerson.com
Technical Support: support.mas.emea@emerson.com

Asia

Phone: +86-400-842-8599
+65-6955-9413 (All other Countries)
Customer Care (Quotes/Orders>Returns): customercare.cn.mas@emerson.com
Technical Support: support.mas.apac@emerson.com

Any escalation request should be sent to: mas.sfdcescalation@emerson.com

Note: If the product is purchased through an Authorized Channel Partner, please contact the seller directly for any support.

Emerson reserves the right to modify or improve the designs or specifications of the products mentioned in this manual at any time without notice. Emerson does not assume responsibility for the selection, use, or maintenance of any product. Responsibility for proper selection, use, and maintenance of any Emerson product remains solely with the purchaser.

© 2021 Emerson. All rights reserved.

Emerson Terms and Conditions of Sale are available upon request. The Emerson logo is a trademark and service mark of Emerson Electric Co. All other marks are the property of their respective owners.

