

# True Union Ball Valve Type 546 Pro



## General

- **Size:** 3/8"–4"
- **Material:** PVC, CPVC, PROGEF® Standard PP, ABS, SYGEF® Standard PVDF
- **Seat:** PTFE
- **Seals:** EPDM, FKM
- **End Connection:** Solvent cement socket, threaded, flanged, fusion spigot, fusion socket
- **Mounting:** Stainless steel threaded inserts
- **Standard Pack Quantity:** 1 valve

## Key Certifications

- **NSF 61:** PVC and CPVC
- **FDA CFR 21 177.1520:** PP and PVDF
- **FDA CFR 21 177.2600:** EPDM and FKM
- **FDA CFR 21 177.1550:** PTFE
- **USP Class VI (physiological non-toxic):** EPDM, FKM, PTFE, PP and PVDF
- **ABS:** All materials

## Sample Specification

The Type 546 Pro Ball Valve shall be true union and utilize a floating ball design. The ball shall be fully molded and full port with two way blocking capability. The stem shall be blowout proof, utilizing a double o-ring seal and a predetermined break point opposite the media side of the stem seals. The seat carrier shall be adjustable and reverse threaded. The handle shall be lockable and double as a seat carrier adjustment or removal tool. The valve nut threads shall be of buttress type. Ball seats shall have an elastomeric backing o-ring and all elastomeric seals shall be of like material. ANSI flanged versions shall meet ANSI B16.5 150lb standards. All valves shall be tested in accordance to ISO9393 and designed to ISO16135 standards. All valves shall be manufactured under ISO9001 for Quality and ISO14001 for Environmental Management. Following assembly, every valve shall be tested and certified bubble tight exceeding Class VI standards.

## Material Specification

PVC valves shall meet ASTM D1784 cell classification 12454 standards. CPVC valves shall meet ASTM D1784 cell classification 23447-B standards. PP valves shall meet ASTM D5847-14 cell classification PP0510B66851 standards. ABS valves shall meet ASTM D3965 cell classification 42222 standards. PVDF valves shall be type 1, grade 2 according to ASTM D3222 standards. Valves of all materials shall be RoHS compliant.

## Components

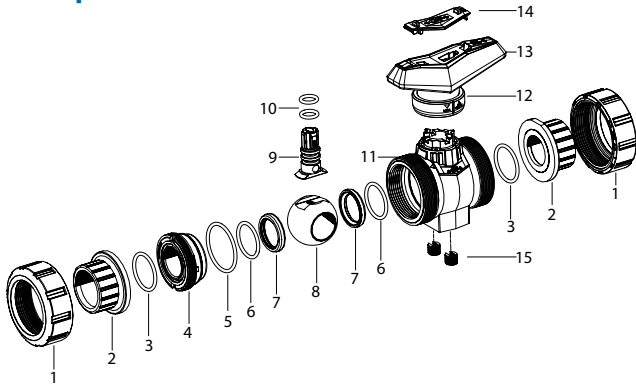

## Key Design Features

The Type 546 Pro Ball Valve comes standard with stainless steel threaded inserts for easy and secure mounting. Valves are available without inserts upon request



The Type 546 Pro Ball Valve stem utilizes a predetermined break point opposite the media side of the stem seals. This break point is a groove with an inner diameter that is less than the stem seal grooves. This ensures that if there is a stem failure, the failure will occur at that point and media will not leak to the outside of the valve.

## Optional Features

- **Actuation:** Electric, pneumatic
- **Limit Switches:** Mechanical, inductive
- **Handle:** Lockable handle, handle extension
- **Mounting pad:** Additional mounting option for valve base
- **Universal Adapter Kit:** ISO mount for actuation
- **Seals:** Alternative materials available upon request
- **Seat:** PVDF
- **End Connection:** Alternatives available upon request
- **Control Ball:** For throttling applications
- **Vented Ball:** For sodium hypochlorite use
- **Cleaned:** Silicone free/oil free

## Valve Components

Part	Description	Material
11	Valve body	PVC, CPVC, PP, ABS or PVDF
4	Seat carrier	PVC, CPVC, PP, ABS or PVDF
2	Valve end	PVC, CPVC, PP, PPn, ABS, PE or PVDF
1	Valve nut	PVC, CPVC, PP, ABS or PVDF
8	Ball	PVC, CPVC, PP, ABS or PVDF
9	Stem	PVC, CPVC, PP, ABS or PVDF
7	Seat	PTFE
6	Backing seal	EPDM or FKM
5	Body seal	EPDM or FKM
3	Face seal	EPDM or FKM
10	Stem seal	EPDM or FKM
12	Locking ring	Glass-filled PP
13	Lever (lockable)	Glass-filled PP
14	Lever clip	Glass-filled PP
15	Mounting insert	304 Stainless steel



The Type 546 Pro Ball Valve seat carrier is reverse threaded while the valve nut utilizes a standard thread. This ensures that the seat carrier is not inadvertently tightened when the valve nut is tightened and avoids possible stem failures.

The valve handle doubles as a seat carrier adjustment tool by simply inserting the handle clip into the pre-molded notches on the seat carrier, making on-site maintenance quick and easy.

# Technical Data

## Pressure Temperature Curves

The following graphs are based on a 25 year lifetime water or similar media application

### PVC

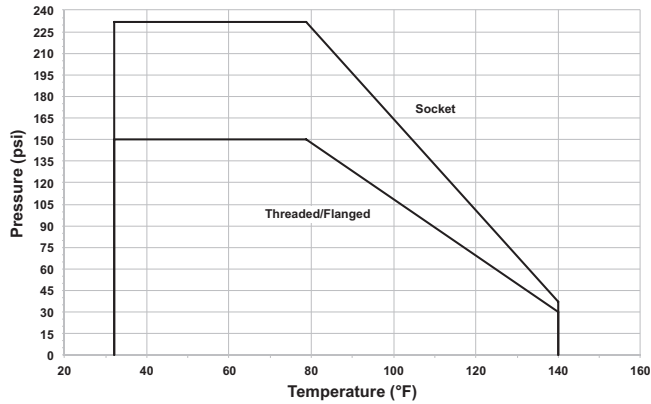

### CPVC

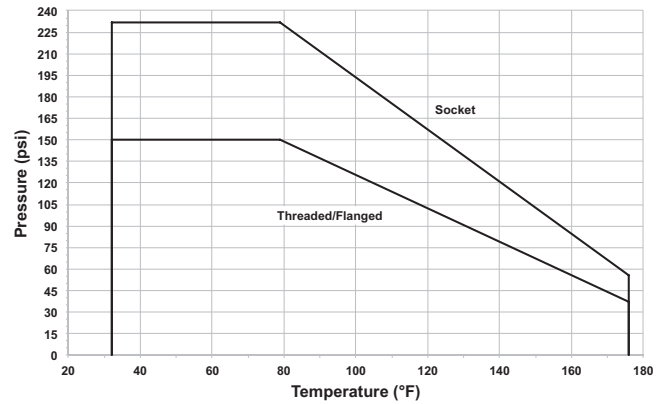

### PP

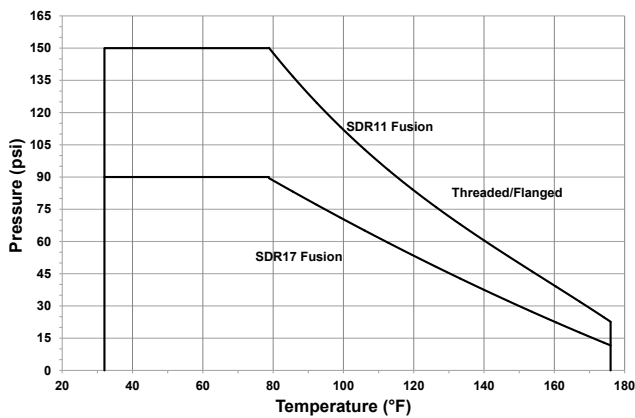

### ABS

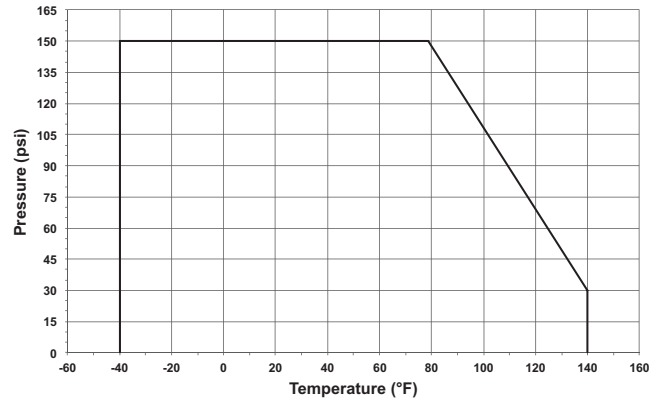

### PVDF

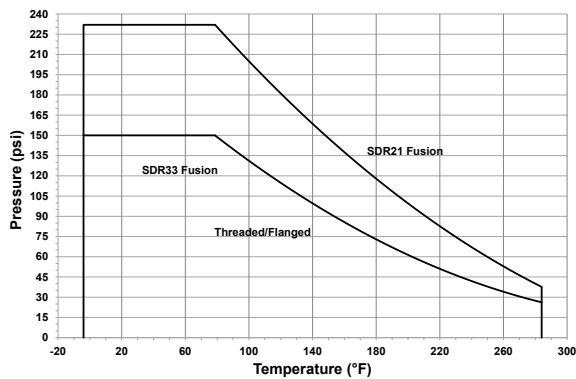

### Pressure-Temperature

Material	Temperature Range (°F)	Max Pressure (psi)
PVC	32 to 140	232*
CPVC	32 to 176	232*
PP	32 to 176	150*
ABS	-40 to 140	150
PVDF	-4 to 284	232*

\*Dependant on end connection as shown in P-T curves

### Vacuum Service

The Type 546 Pro is rated for full vacuum service. Maximum differential pressure of 15psi at 122°F.

# Flow

The following information is based on water applications at 68° F

## Flow Characteristics

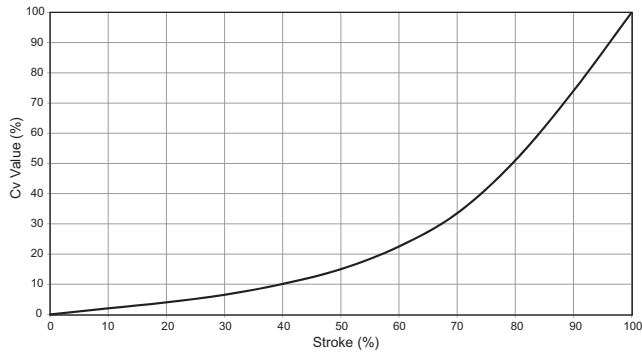

## Cv Value

Size (inch)	d (mm)	Cv (gal/min)
3/8	16	5
1/2	20	13
3/4	25	25
1	32	49
1 1/4	40	70
1 1/2	50	112
2	63	217
2 1/2	75	350
3	90	490
4	110	770

## Vented Ball: Optional Feature

A vented ball is an optional feature with all variations of the Type 546 Pro Ball Valve. This version of the valve has dedicated part numbers that utilize a special ball with a 1/8 inch hole. This ball is designed for applications in which the media requires out-gassing such as sodium hypochlorite. The hole functions as a vent for media that would normally be trapped inside a closed ball. The vent prevents potentially dangerous pressure from building up inside the valve. The vent is located opposite the seat carrier side of the ball valve and this vent is recommended to be installed upstream.



Chemical applications vary from system to system and variations such as concentration, temperature and pressure need to be considered. It is the responsibility of the individual user to verify compatibility and GF recommends that every application be verified and tested by internal experts or a third party.

## Control Ball: Optional Feature

The Type 546 Pro Control Ball is a keyed design and is available in PVC, CPVC, PP and PVDF. This ball is designed for applications requiring flow control. The keyed orifice provides a nearly linear flow characteristic curve and is superior to V-notch designs. This ball is not bidirectional. The required installation direction is to have the keyed orifice downstream. The Type 546 Pro Control Ball can be added to any Type 546 Pro Ball Valve within the available size range.

## Flow Characteristics

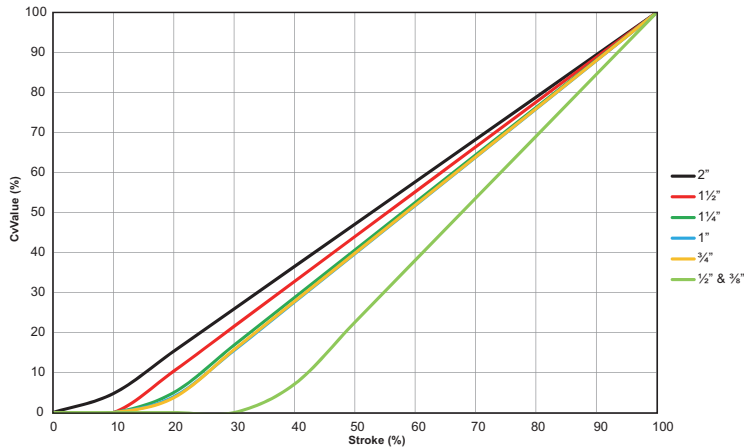

## Cv Value

Size (inch)	d (mm)	Cv (gal/min)
3/8, 1/2	16, 20	6.3
3/4	25	11.6
1	32	16.4
1 1/4	40	29.0
1 1/2	50	43.6
2	63	54.4



# Dimensions

The following tables are shown in millimeters unless otherwise specified

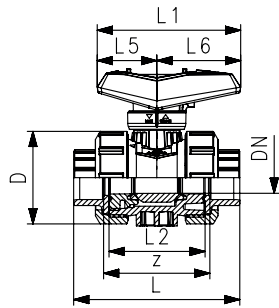

Socket/threaded

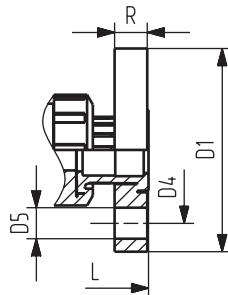

Flanged

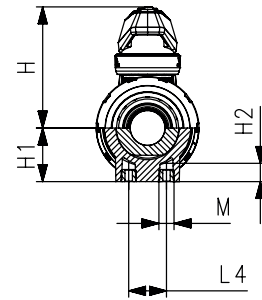

All configurations

## All Materials

Size (inch)	d (mm)	D	H	H1	H2	L4	M
3/8	16	50	61	27	12	25	M6
1/2	20	50	61	27	12	25	M6
3/4	25	58	74	30	12	25	M6
1	32	68	80	36	12	25	M6
1 1/4	40	84	95	44	15	45	M8
1 1/2	50	97	102	51	15	45	M8
2	63	124	117	64	15	45	M8
2 1/2	75	166	150	85	15	70	M8
3	90	200	161	105	15	70	M8
4	110	238	178	123	22	120	M12

## PVC/CPVC

Size (inch)	IPS Socket		Threaded NPT		ANSI Flanged				
	L	z	L	z	L	D1 (inch)	D4 (inch)	D5 (inch)	R (inch)
3/8	105	67	98	69	-	-	-	-	-
1/2	105	61	98	65	149	3.5	2.38	0.56	0.57
3/4	121	70	111	74	165	3.88	2.75	0.63	0.58
1	133	76	127	82	184	4.25	3.13	0.63	0.66
1 1/4	154	90	147	98	206	4.63	3.5	0.56	0.69
1 1/2	164	94	157	110	221	5	3.88	0.56	0.76
2	183	107	183	135	251	6	4.75	0.75	0.82
2 1/2	233	144	234	166	311	7	5.5	0.75	0.98
3	254	151	255	175	343	7.5	6	0.75	1.02
4	301	174	302	214	397	9	7.5	0.75	1.11

## ABS

d (mm)	Metric Socket	
	L	z
16	92	64
20	95	64
25	110	72
32	123	79
40	146	94
50	157	95
63	183	107
75	233	144
90	254	151
110	301	174

# Dimensions

The following tables are shown in millimeters unless otherwise specified

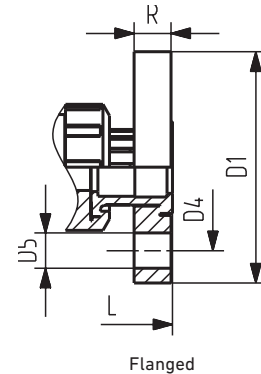
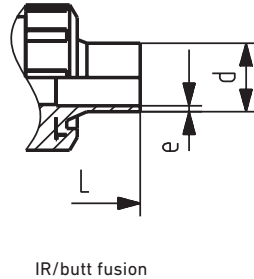
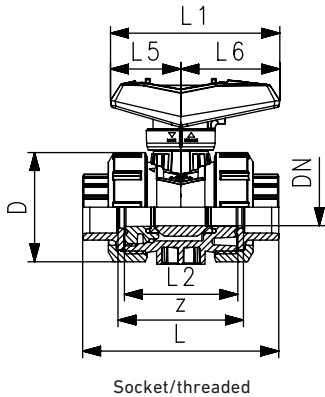

## PP

d (mm)	Metric Socket		Metric IR/Butt		Threaded NPT		ANSI Flanged				
	L	z	L	e	L	z	L	D1 (inch)	D4 (inch)	D5 (inch)	R (inch)
16	93	67	-	-	96	71	-	-	-	-	-
20	95	66	130	1.9	99	64	166	3.74	2.36	0.63	0.63
25	109	77	143	2.3	111	76	177	4.13	2.76	0.63	0.67
32	119	83	150	2.9	127	83	191	4.53	3.11	0.63	0.71
40	135	99	171	3.7	146	100	209	5.51	3.5	0.63	0.79
50	147	105	191	4.6	157	111	229	5.91	3.86	0.63	0.87
63	168	117	220	5.8	183	134	253	6.5	4.76	0.75	0.94
75	233	167	266	6.8	-	-	416	7.28	5.51	0.75	1.02
90	254	180	264	8.2	-	-	414	7.87	5.98	0.75	1.06
110	301	215	301	10.0	-	-	451	9.02	7.48	0.75	1.1

## PVDF

d (mm)	Metric Socket		Metric IR/Butt		Threaded NPT		ANSI Flanged				
	L	z	L	e	L	z	L	D1 (inch)	D4 (inch)	D5 (inch)	R (inch)
16	93	67	-	-	96	69	-	-	-	-	-
20	95	66	130	1.9	99	64	174	3.74	2.36	0.63	0.63
25	109	77	143	1.9	111	76	189	4.13	2.76	0.63	0.67
32	119	83	150	2.4	127	83	199	4.53	3.11	0.63	0.71
40	135	99	171	2.4	146	101	235	5.51	3.5	0.63	0.79
50	147	105	191	3.0	157	111	243	5.91	3.86	0.63	0.87
63	168	117	220	3.0	183	135	261	6.5	4.76	0.75	0.94
75	233	167	266	3.6	-	-	426	7.28	5.51	0.75	1.02
90	254	180	264	4.3	-	-	426	7.87	5.98	0.75	1.06
110	301	215	301	5.3	-	-	487	9.02	7.48	0.75	1.1