



Type 2280 Tuning Forks are suitable for level detection of liquids or granular, powdered solids. Mounted on tanks filling / emptying can be controlled using these devices just as well they can generate fail-safe alarms providing overflow- or dry run protection.

The operation principle is based on the electronic circuit exciting the fork probe making it vibrate. As the medium reaches and covers the fork its vibration changes. The electronics senses the change of vibration and gives output signal after a selected delay.

Features

- Maintenance free vibrating principle
- Independent of the liquid conductivity, dielectric constant, viscosity, pressure and temperature
- Selectable sensitivity
- Relay or electronic output
- Temperatures up to 130 degrees
- ATEX and WHG approvals
- IP67, 65/68 protection

CE, WHG, ATEX, RoHS

Applications

- Potable Water
- River Water
- Cooling Water
- Demineralized Water
- Water/Glycol Solutions
- Chemicals

Dimensions

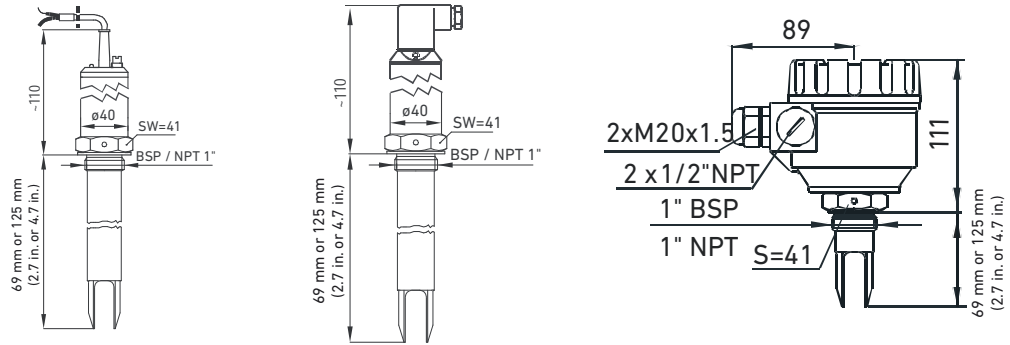

Specifications

General			
Type	2280-Y-YYC-Y	2280-Y-YYO-Y	2280-Y-YYT-Y
Probe Length	69 mm or 125 mm (2.7 in. or 4.9 in.)		
Operation mode indicator	Bi-color LED		
Environmental			
Process Temperature	-40 °C ... +130 °C (-40 °F... +266 °F)		
Ambient Temperature	-40 °C...+70 °C (-40 °F...+158 °F) / -30 °C...+70 °C (-22 °F...+158 °F)		
Process Pressure (absolute)	4 MPa (40 bar) 580 psi		
Min Medium Density	≥ 0.7 kg/dm ³		
Max Medium Viscosity	≤10'000 mm ² /s (cSt)		
Enclosure			
Sensor	Stainless Steel DIN 1.4571		
Housing	Stainless Steel DIN 1.4571	PBT	
Ingress protection	IP67		
Process Connection	1 " BSP / NPT		
Electrical			
Switching Function	2-wire AC; 3-wire PNP-NPN	1 SPDT relay	
Output Voltage / -Current	AC 9mA free, 14 mA immersed 3-wire max. 350mA, <4.5V (on)	250V AC, 8A AC1	
Power Supply	12...55 V DC or 20 ... 255 V AC, 50/60 Hz	20 ... 255 V AC and 20 ... 60 V DC	
Response Time	≤ 0.5 s		
Power Consumption	0.6 W	AC: 1.2 ... 17 VA; DC: <3 W	
Connection	Cable PVC 5x0.5mm ² , 3m	DIN Connector	Terminal
Protection	Class III		Class I
Standards and Approvals			
ATEX approval	ATEX II 1 G Ex ia IIC T6, IP68		
General Approvals	CE		

Wiring

DIN Connector 3 Wire DC Version:

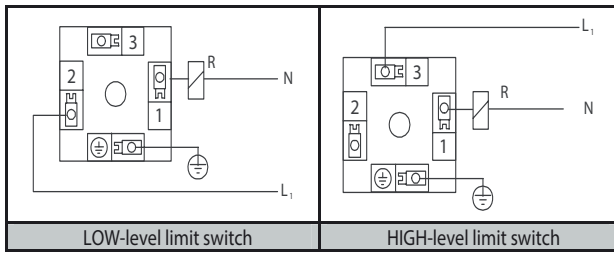

PBT Enclosure Version:

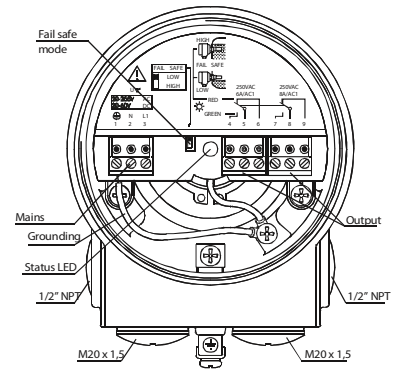

DC Cable Version 3 Wire DC:

PNP-wiring

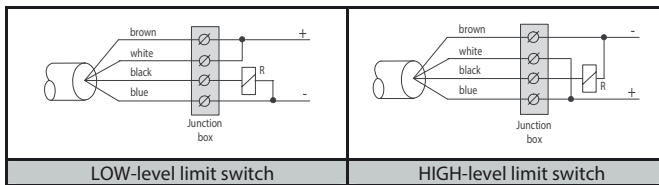

NPN-wiring

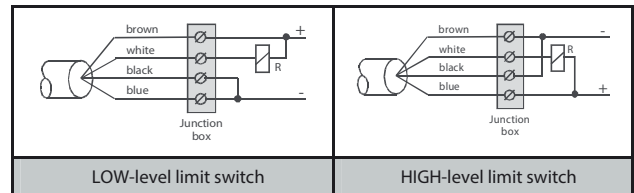

DIN Connector 2 Wire AC Version:

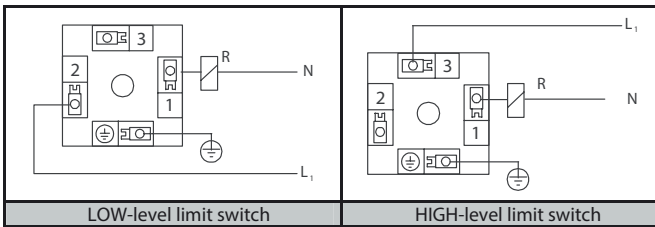

AC Cable Version 2 Wire AC:

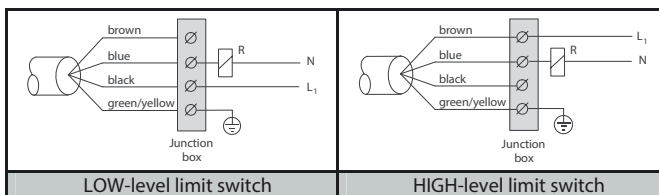

Ordering Information

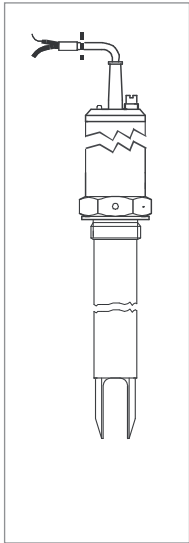

Mfr. Part No.	Code	Description
2280-S-5WBO-1	159 300 200	Length 69 mm (2.72 in.), Stainless Steel, Output 3-wire PNP-NPN, DIN connector, BSP thread
2280-S-5WBC-1	159 300 201	Length 69 mm (2.72 in.), Stainless Steel, Output 3-wire PNP-NPN, cable, BSP thread
2280-S-5WBO-2	159 300 202	Length 125 mm (4.92 in.), Stainless Steel, Output 3-wire PNP-NPN, DIN connector, BSP thread
2280-S-5WBC-2	159 300 203	Length 125 mm (4.92 in.), Stainless Steel, Output 3-wire PNP-NPN, cable, BSP thread
2280-S-5XWBO-1	159 300 210	Length 69 mm (2.72 in.), Stainless Steel, Output 2-wire AC, DIN connector, BSP thread, ATEX
2280-S-5XWBC-1	159 300 211	Length 69 mm (2.72 in.), Stainless Steel, Output 2-wire AC, cable, BSP thread, ATEX
2280-S-5XWBO-2	159 300 212	Length 125 mm (4.92 in.), Stainless Steel, Output 2-wire AC, DIN connector, BSP thread, ATEX
2280-S-5XWBC-2	159 300 213	Length 125 mm (4.92 in.), Stainless Steel, Output 2-wire AC, cable, BSP thread, ATEX
2280-S-5WNO-1	159 300 220	Length 69 mm (2.72 in.), Stainless Steel, Output 3-wire PNP-NPN, DIN connector, NPT thread
2280-S-5WNC-1	159 300 221	Length 69 mm (2.72 in.), Stainless Steel, Output 3-wire PNP-NPN, cable, NPT thread
2280-S-5WNO-2	159 300 222	Length 125 mm (4.92 in.), Stainless Steel, Output 3-wire PNP-NPN, DIN connector, NPT thread
2280-S-5WNC-2	159 300 223	Length 125 mm (4.92 in.), Stainless Steel, Output 3-wire PNP-NPN, cable, NPT thread
2280-S-5XWNO-1	159 300 230	Length 69 mm (2.72 in.), Stainless Steel, Output 2-wire AC, DIN connector, NPT thread, ATEX
2280-S-5XWNC-1	159 300 231	Length 69 mm (2.72 in.), Stainless Steel, Output 2-wire AC, cable, NPT Gewinde, ATEX
2280-S-5XWNO-2	159 300 232	Length 125 mm (4.92 in.), Stainless Steel, Output 2-wire AC, DIN connector, NPT thread, ATEX
2280-S-5XWNC-2	159 300 233	Length 125 mm (4.92 in.), Stainless Steel, Output 2-wire AC, cable, NPT thread, ATEX
2280-S-5WBT-1	159 300 240	Length 69 mm (2.72 in.), Stainless Steel, PBT enclosure, 1 SPDT relay, BSP thread
2280-S-5WBT-2	159 300 241	Length 125 mm (4.92 in.), Stainless Steel, PBT enclosure, 1 SPDT relay, BSP thread
2280-S-5WNT-1	159 300 242	Length 69 mm (2.72 in.), Stainless Steel, PBT enclosure, 1 SPDT relay, NPT thread
2280-S-5WNT-2	159 300 243	Length 125 mm (4.92 in.), Stainless Steel, PBT enclosure, 1 SPDT relay, NPT thread