



High Performance, Multifunction Inverter

FRENIC-MEGA

⚠ CAUTION

This product is designed to drive a three-phase induction motor. Read through this manual to become familiar with proper handling and correct use.

Improper handling might result in incorrect operation, short life cycle, or failure of this product as well as the motor.

Deliver this manual to the end user of this product. Keep this manual in a safe place until this product is discarded.

For instructions on how to use an optional device, refer to the instruction and installation manuals for that optional device.

Copyright © 2010-2011 Fuji Electric Corp. of America

All rights reserved.

No part of this publication may be reproduced or copied without prior written permission from Fuji Electric Corp. of America.

All products and company names mentioned in this manual are trademarks or registered trademarks of their respective holders.

The information contained herein is subject to change without prior notice for improvement.

Preface

This product is designed to drive a three-phase induction motor. Read through this manual to become familiar with proper handling and correct use.

Improper handling might result in incorrect operation, shorter life cycle, or failure of this product as well as the motor.

Have this manual delivered to the end user of this product. Keep this manual in a safe place until this product is discarded.

Listed below are the other materials related to the use of the FRENIC-MEGA. Read them in conjunction with this manual as necessary.



- FRENIC-MEGA User's Manual
- RS-485 Communication User's Manual

These materials are subject to change without notice. Be sure to obtain the latest editions for use.

■ Safety precautions

Read this manual thoroughly before proceeding with installation, connections (wiring), operation, or maintenance and inspection. Ensure you have sound knowledge of the device and familiarize yourself with all safety information and precautions before proceeding to operate the inverter.

Safety precautions are classified into the following two categories in this manual.

 WARNING	Failure to heed the information indicated by this symbol may lead to dangerous conditions, possibly resulting in death or serious bodily injuries.
 CAUTION	Failure to heed the information indicated by this symbol may lead to dangerous conditions, possibly resulting in minor or light bodily injuries and/or substantial property damage.

Failure to heed the information contained under the CAUTION title can also result in serious consequences. These safety precautions are of utmost importance and must be observed at all times.

Application

 WARNING
<ul style="list-style-type: none">• The FRENIC-MEGA is designed to drive a three-phase induction motor. Do not use it for single-phase motors or for other purposes. Fire or an accident could occur.• The FRENIC-MEGA may not be used for a life-support system or other purposes directly related to the human safety.• Though the FRENIC-MEGA is manufactured under strict quality control, install safety devices for applications where serious accidents or property damages are foreseen in relation to the failure of it. An accident could occur.

Installation

 WARNING
<ul style="list-style-type: none">• Install the inverter on a base made of metal or other non-flammable material. Otherwise, a fire could occur.• Do not place flammable object nearby. Doing so could cause fire.• Inverters with a capacity of 50 HP or above, whose protective structure is IP00, involve a possibility that a human body may touch the live conductors of the main circuit terminal block. Inverters to which an optional DC reactor is connected also involve the same. Install such inverters in an inaccessible place. Otherwise, electric shock or injuries could occur.

CAUTION

- Do not support the inverter by its front cover during transportation.
Doing so could cause a drop of the inverter and injuries.
- Prevent lint, paper fibers, sawdust, dust, metallic chips, or other foreign materials from getting into the inverter or from accumulating on the heat sink.
- When changing the positions of the top and bottom mounting bases, use only the specified screws.
Otherwise, a fire or an accident might result.
- Do not install or operate an inverter that is damaged or lacking parts.
Doing so could cause fire, an accident or injuries.

Wiring

WARNING

- If no zero-phase current (earth leakage current) detective device such as a ground-fault relay is installed in the upstream power supply line in order to avoid the entire power supply system's shutdown undesirable to factory operation, install a residual-current-operated protective device (RCD)/earth leakage circuit breaker (ELCB) individually to inverters to break the individual inverter power supply lines only.
Otherwise, a fire could occur.
- When wiring the inverter to the power source, insert a recommended molded case circuit breaker (MCCB) or residual-current-operated protective device (RCD)/earth leakage circuit breaker (ELCB) (with overcurrent protection) in the path of each pair of power lines to inverters. Use the recommended devices within the recommended current capacity.
- Use wires of the specified size.
- Tighten terminals with specified torque.
Otherwise, a fire could occur.
- When there is more than one combination of an inverter and motor, do not use a multiconductor cable for the purpose of running the leads together.
- Do not connect a surge killer to the inverter's output (secondary) circuit.
Doing so could cause a fire.
- Be sure to connect an optional DC reactor (DCR) when the capacity of the power supply transformer exceeds 500 kVA and is 10 times or more the inverter rated capacity.
Otherwise, a fire could occur.
- Ground the inverter in compliance with the national or local electric code.
- Be sure to ground the inverter's grounding terminals 
Otherwise, an electric shock or a fire could occur.
- Qualified electricians should carry out wiring.
- Be sure to perform wiring after turning the power OFF.
Otherwise, an electric shock could occur.
- Be sure to perform wiring after installing the inverter unit.
Otherwise, an electric shock or injuries could occur.
- Ensure that the number of input phases and the rated voltage of the product match the number of phases and the voltage of the AC power supply to which the product is to be connected.
Otherwise, a fire or an accident could occur.
- Do not connect the power supply wires to output terminals (U, V, and W).
- When connecting a DC braking resistor (DBR), never connect it to terminals other than terminals P(+) and DB.
Doing so could cause fire or an accident.
- In general, the insulation of the control signal wires are not specifically designed to withstand a high voltage (i.e., reinforced insulation is not applied). Therefore, if a control signal wire comes into direct contact with a live conductor of the main circuit, the insulation may break down, which would expose the signal wire to the high voltage of the main circuit. Make sure that the control signal wires will not come into contact with live conductors of the main circuit.
Doing so could cause an accident or an electric shock.

⚠ WARNING ⚠

- Before changing the switches or touching the control circuit terminal symbol plate, **turn OFF the power and wait at least five minutes for inverters of 40 HP or below, or at least ten minutes for inverters of 50 HP or above.** Make sure that the LED monitor and charging lamp are turned OFF. Further, make sure, using a multimeter or a similar instrument, that the DC link bus voltage between the terminals P(+) and N(-) has dropped to the safe level (+25 VDC or below).

Otherwise, an electric shock could occur.

⚠ CAUTION ⚠

- The inverter, motor and wiring generate electric noise. This may cause the malfunction of nearby sensors and devices. To prevent malfunctioning, implement noise control measures.

Otherwise an accident could occur.

Operation

⚠ WARNING ⚠

- Be sure to mount the front cover before turning the power ON. Do not remove the cover when the inverter power is ON.
Otherwise, an electric shock could occur.
- Do not operate switches with wet hands.
Doing so could cause electric shock.
- If the auto-reset function has been selected, the inverter may automatically restart and drive the motor depending on the cause of tripping. Design the machinery or equipment so that human safety is ensured at the time of restarting.
Otherwise, an accident could occur.
- If the stall prevention function (current limiter), automatic deceleration (anti-regenerative control), or overload prevention control has been selected, the inverter may operate with acceleration/deceleration or frequency different from the commanded ones. Design the machine so that safety is ensured even in such cases.
- If any of the protective functions have been activated, first remove the cause. Then, after checking that the all run commands are set to OFF, release the alarm. If the alarm is released while any run commands are set to ON, the inverter may supply the power to the motor, running the motor.
Otherwise, an accident could occur.
- If you enable the "Restart mode after momentary power failure" (Function code F14 = 3 to 5), then the inverter automatically restarts running the motor when the power is recovered.
Design the machinery or equipment so that human safety is ensured after restarting.
- If the user configures the function codes wrongly without completely understanding this Instruction Manual and the FRENIC-MEGA User's Manual, the motor may rotate with a torque or at a speed not permitted for the machine.
An accident or injuries could occur.
- Even if the inverter has interrupted power to the motor, if the voltage is applied to the main circuit input terminals L1/R, L2/S and L3/T, voltage may be output to inverter output terminals U, V, and W.
- Even if the run command is set to OFF, voltage is output to inverter output terminals U, V, and W if the servo-lock command is ON.
- Even if the motor is stopped due to DC braking or preliminary excitation, voltage is output to inverter output terminals U, V, and W.
An electric shock may occur.
- The inverter can easily accept high-speed operation. When changing the speed setting, carefully check the specifications of motors or equipment beforehand.
Otherwise, injuries could occur.

CAUTION

- Do not touch the heat sink and braking resistor because they become very hot.
Doing so could cause burns.
- The DC brake function of the inverter does not provide any holding mechanism.
Injuries could occur.
- Ensure safety before modifying the function code settings.
Run commands (e.g., "Run forward" *FWD*), stop commands (e.g., "Coast to a stop" *BX*), and frequency change commands can be assigned to digital input terminals. Depending upon the assignment states of those terminals, modifying the function code setting may cause a sudden motor start or an abrupt change in speed.
- When the inverter is controlled with the digital input signals, switching run or frequency command sources with the related terminal commands (e.g., *SSI*, *SS2*, *SS4*, *SS8*, *Hz2/Hz1*, *Hz/PID*, *IVS*, and *LE*) may cause a sudden motor start or an abrupt change in speed.
- Ensure safety before modifying customizable logic related function code settings (U codes and related function codes) or turning ON the "Cancel customizable logic" terminal command *CLC*. Depending upon the settings, such modification or cancellation of the customizable logic may change the operation sequence to cause a sudden motor start or an unexpected motor operation.
An accident or injuries could occur.

Maintenance and inspection, and parts replacement

WARNING

- Before proceeding to the maintenance/inspection jobs, **turn OFF the power and wait at least five minutes for inverters of 40 HP or below, or at least ten minutes for inverters of 50 HP or above.** Make sure that the LED monitor and charging lamp are turned OFF. Further, make sure, using a multimeter or a similar instrument, that the DC link bus voltage between the terminals P(+) and N(-) has dropped to the safe level (+25 VDC or below).
Otherwise, an electric shock could occur.
- Maintenance, inspection, and parts replacement should be made only by qualified persons.
- Take off the watch, rings and other metallic objects before starting work.
- Use insulated tools.
Otherwise, an electric shock or injuries could occur.
- Never modify the inverter.
Doing so could cause an electric shock or injuries.

Disposal

CAUTION

- Treat the inverter as an industrial waste when disposing of it.
Otherwise injuries could occur.

GENERAL PRECAUTIONS

Drawings in this manual may be illustrated without covers or safety shields for explanation of detail parts. Restore the covers and shields in the original state and observe the description in the manual before starting operation.

Icons

The following icons are used throughout this manual.



This icon indicates information which, if not heeded, can result in the inverter not operating to full efficiency, as well as information concerning incorrect operations and settings which can result in accidents.



This icon indicates information that can prove handy when performing certain settings or operations.



This icon indicates a reference to more detailed information.

Conformity to the Low Voltage Directive in the EU

If installed according to the guidelines given below, inverters marked with CE are considered as compliant with the Low Voltage Directive 2006/95/EC.

Compliance with European Standards

Adjustable speed electrical power drive systems (PDS).

Part 5-1: Safety requirements. Electrical, thermal and energy. EN61800-5-1: 2007

⚠ WARNING ⚠

1. The ground terminal should always be connected to the ground. Do not use only a residual-current-operated protective device (RCD)/earth leakage circuit breaker (ELCB)* as the sole method of electric shock protection. Be sure to use ground wires whose size is greater than power supply lines.

*With overcurrent protection.

2. To prevent the risk of hazardous accidents that could be caused by damage of the inverter, install the specified fuses in the supply side (primary side) according to the following tables.

- Breaking capacity: Min. 10 kA
- Rated voltage: Min. 500 V

Power supply voltage	Inverter type	Fuse rating (A)
230 V	FRNF50G1S-2U	10 (IEC60269-2)
	FRN001G1S-2U	15 (IEC60269-2)
	FRN002G1S-2U	20 (IEC60269-2)
	FRN003G1S-2U	30 (IEC60269-2)
	FRN005G1S-2U	40 (IEC60269-2)
	FRN007G1 ■-2U	125 (IEC60269-4)
	FRN010G1 ■-2U	
	FRN015G1 ■-2U	160 (IEC60269-4)
	FRN020G1 ■-2U	
	FRN025G1 ■-2U	200 (IEC60269-4)
	FRN030G1 ■-2U	250 (IEC60269-4)
	FRN040G1 ■-2U	
	FRN050G1 ■-2U	350 (IEC60269-4)
	FRN060G1 ■-2U	400 (IEC60269-4)
	FRN075G1 ■-2U	450 (IEC60269-4)
	FRN100G1 ■-2U	500 (IEC60269-4)
	FRN125G1S-2U	
FRN150G1S-2U		

Power supply voltage	Inverter type	Fuse rating (A)
460 V	FRNF50G1S-4U	3 (IEC60269-2)
	FRN001G1S-4U	6 (IEC60269-2)
	FRN002G1S-4U	10 (IEC60269-2)
	FRN003G1S-4U	15 (IEC60269-2)
	FRN005G1S-4U	20 (IEC60269-2)
	FRN007G1 ■-4U	80 (IEC60269-4)
	FRN010G1 ■-4U	
	FRN015G1 ■-4U	
	FRN020G1 ■-4U	125 (IEC60269-4)
	FRN025G1 ■-4U	
	FRN030G1 ■-4U	160 (IEC60269-4)
	FRN040G1 ■-4U	
	FRN050G1 ■-4U	250 (IEC60269-4)
	FRN060G1 ■-4U	315 (IEC60269-4)
	FRN075G1 ■-4U	
	FRN100G1 ■-4U	350 (IEC60269-4)
	FRN125G1S-4U	
	FRN150G1S-4U	
	FRN200G1S-4U	400 (IEC60269-4)
	FRN250G1S-4U	450 (IEC60269-4)
FRN300G1S-4U	500 (IEC60269-4)	
FRN350G1S-4U	550 (IEC60269-4)	
FRN450G1S-4U	630 (IEC60269-4)	
FRN500G1S-4U	900 (IEC60269-4)	
FRN600G1S-4U		
FRN700G1S-4U	1250 (IEC60269-4)	
FRN800G1S-4U		
FRN900G1S-4U	2000 (IEC60269-4)	
FRN1000G1S-4U		

Note: A box (■) in these tables replaces S or H depending on the enclosure.

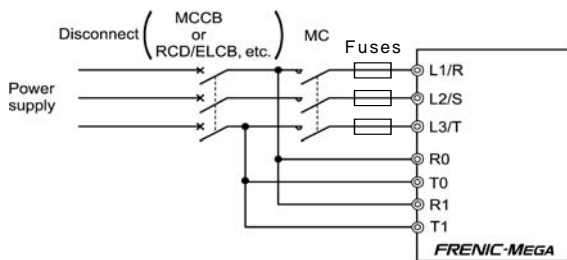

Note: When using the inverter on single-phase input power also, use fuses suitable for the inverter type as specified on this page.

Conformity to the Low Voltage Directive in the EU (Continued)

⚠ WARNING ⚠

3. When used with the inverter, a molded case circuit breaker (MCCB), residual-current-operated protective device (RCD)/earth leakage circuit breaker (ELCB) or magnetic contactor (MC) should conform to the EN or IEC standards.
4. When you use a residual-current-operated protective device (RCD)/earth leakage circuit breaker (ELCB) for protection from electric shock in direct or indirect contact power lines or nodes, be sure to install type B of RCD/ELCB on the input (primary) of the inverter if the power supply is three-phase 200/400 V.
5. The inverter should be used in an environment that does not exceed Pollution Degree 2 requirements. If the environment conforms to Pollution Degree 3 or 4, install the inverter in an enclosure of IP54 or higher.
6. Install the inverter, AC or DC reactor, input or output filter in an enclosure with minimum degree of protection of IP2X (Top surface of enclosure shall be minimum IP4X when it can be easily accessed), to prevent human body from touching directly to live parts of these equipment.
7. Do not connect any copper wire directly to grounding terminals. Use crimp terminals with tin or equivalent plating to connect them.
8. Use wires listed in IEC60364-5-52.

Power supply voltage	Nominal applied motor (HP)		Inverter type	HD / LD mode	MCCB or RCD/ELCB *1 Rated current		Recommended wire size (mm ²)								
							Main circuit				Control circuit	Aux. control power supply [R0, T0]	Aux. fan power supply [R1, T1]		
							Main power input *2 [L1/R, L2/S, L3/T] Inverter's grounding *3 [EG]		Inverter outputs [U, V, W] *2	DC reactor [P1, P(+)] *2				Braking resistor [P(+), DB] *2	
Three-phase	Single-phase	W/DCR	W/o DCR	W/DCR	W/o DCR	W/DCR	W/o DCR	Control circuit	Aux. control power supply [R0, T0]	Aux. fan power supply [R1, T1]					
230 V	0.5	0.25	FRNF50G1S-2U	HD/LD	5	5	1	1	1	1	1	0.65 to 0.82	2.5	-	
	1	0.5	FRN001G1S-2U			10									10
	2	1	FRN002G1S-2U		10	15	2.5	4	2.5	2.5					
	3	1.5	FRN003G1S-2U			20									1.5
	5	3	FRN005G1S-2U		30	30	4	6	4	4					
	7.5		FRN007G1■-2U	50		6									4
	10	5	FRN010G1■-2U	HD	40	75	6	10	6	6					
	15		FRN015G1■-2U	LD											10
	20	10	FRN020G1■-2U	HD	75	125	16	25	16	25					
	25		FRN025G1■-2U	LD											100
	30	15	FRN030G1■-2U	HD	100	175	35	50	35	35					
	40		FRN040G1■-2U	LD											150
	50	25	FRN050G1■-2U	HD	175	250	70	95	70	95					2.5
	60		FRN060G1■-2U	LD											
	75	30	FRN075G1■-2U	HD	250	350	50×2	95×2	70×2	70×2					6
	100		FRN100G1■-2U	LD											
	125	40	FRN125G1S-2U	HD	400	-	120×2	-	120×2	120×2					-
	150		FRN150G1S-2U	LD											

Note: A box (■) in the above table replaces S or H depending on the enclosure.

*1 The frame size and model of the MCCB or RCD/ELCB (with overcurrent protection) will vary, depending on the power transformer capacity. Refer to the related technical documentation for details.

*2 The recommended wire size for main circuits is for the 70°C (158°F) 600 V PVC wires used at a surrounding temperature of 40°C (104°F).

*3 Grounding terminal can accept one wire only.

Conformity to the Low Voltage Directive in the EU (Continued)



⚠ WARNING ⚠																
Power supply voltage	Nominal applied motor (HP)		Inverter type	HD/MD/LD mode	MCCB or RCD/ELCB *1 Rated current		Recommended wire size (mm ²)									
							Main circuit			Control circuit	Aux. control power supply [R0, T0]	Aux. fan power supply [R1, T1]				
	Three-phase	Single-phase			W/DCR	W/o DCR	W/DCR	W/o DCR	Inverter outputs [U, V, W] *2				DC reactor [P1, P(+)] *2	Braking resistor [P(+), DB] *2		
460 V	0.5	0.25	FRNF50G1S-4U	HD/LD	5	5	1	1	1	1	0.65 to 0.82	2.5	-			
	1	0.5	FRN001G1S-4U			10								10		
	2	1	FRN002G1S-4U		10	15		1.5	1.5					1.5		
	3	1.5	FRN003G1S-4U			20										
	5	3	FRN005G1S-4U		HD	15		30	1.5					4	2.5	2.5
	7.5		FRN007G1■-4U													
	10		FRN010G1■-4U													
	15	5	FRN015G1■-4U		LD	20		40	4					6	4	4
	20		FRN020G1■-4U		HD											
	25	10	FRN025G1■-4U		LD	40		60	6					10	6	6
	30		FRN030G1■-4U	HD												
	40		FRN040G1■-4U	LD												
	50	25	FRN050G1■-4U	HD	75	125	16	25	16	16						
	60		FRN060G1■-4U	LD												
	75	30	FRN075G1■-4U	HD	100	150	25	35	25	35				1.5		
	100		FRN100G1■-4U	LD												
	125		FRN125G1S-4U	HD												
	150	60	FRN150G1S-4U	LD	200	200	35	70	50	70				2.5		
	200		FRN200G1S-4U	MD/LD												
	250	75	FRN250G1S-4U	HD	250	250	50×2	-	70×2	150				4		
	300		FRN300G1S-4U	MD/LD												
	350		FRN350G1S-4U	HD												
	350	100	FRN450G1S-4U	MD/LD	300	300	185	-	240	300				-		
	350		FRN450G1S-4U	HD												

Note: A box (■) in the above table replaces S or H depending on the enclosure.

*1 The frame size and model of the MCCB or RCD/ELCB (with overcurrent protection) will vary, depending on the power transformer capacity. Refer to the related technical documentation for details.

*2 The recommended wire size for main circuits is for the 70°C (158°F) 600 V PVC wires used at a surrounding temperature of 40°C (104°F).

*3 Grounding terminal can accept one wire only.

Conformity to the Low Voltage Directive in the EU (Continued)



Power supply voltage	Nominal applied motor (HP)		Inverter type	HD/MD/LD mode	MCCB or RCD/ELCB *1 Rated current		Recommended wire size (mm ²)									
							Main circuit				Inverter outputs [U, V, W] *2	DC reactor [P1, P(+)] *2	Braking resistor [P(+), DB] *2	Control circuit	Aux. control power supply [R0, T0]	Aux. fan power supply [R1, T1]
							W/DCR	W/o DCR	W/DCR	W/o DCR						
460 V	350	-	FRN450G1S-4U	MD	600	-	185×2	-	185×2	185×2	-	0.65 to 0.82	2.5	2.5		
	450	125		LD					240×2	240×2						
	400	-	FRN500G1S-4U	HD	800	-	240×2	-	300×2	240×2	-	0.65 to 0.82	2.5	2.5		
	450	150		MD					300×2	300×2						
	500	-	FRN600G1S-4U	HD	1200	-	240×3	-	240×3	300×3	-	0.65 to 0.82	2.5	2.5		
	500	150	FRN500G1S-4U	LD					300×2	300×2						
	600	200	FRN600G1S-4U	LD					240×3	300×3						
	600	-	FRN700G1S-4U	MD					240×3	300×3						
	600	200	FRN800G1S-4U	HD					300×3	240×4						
	700	-	FRN700G1S-4U	LD					300×3	240×4						
	700	-	FRN800G1S-4U	MD					300×3	300×4						
	800	250	FRN900G1S-4U	LD					300×4	300×4						
	900	300	FRN1000G1S-4U	HD					1400	300×4						
	1000	400	FRN1000G1S-4U	LD					1600	300×4						

*1 The frame size and model of the MCCB or RCD/ELCB (with overcurrent protection) will vary, depending on the power transformer capacity. Refer to the related technical documentation for details.

*2 The recommended wire size for main circuits is for the 70°C (158°F) 600 V PVC wires used at a surrounding temperature of 40°C (104°F).

*3 Grounding terminal can accept one wire only.

- When you use an inverter at an altitude of more than 6600 ft (2000 m), you should apply basic insulation for the control circuits of the inverter. The inverter cannot be used at altitudes of more than 9800 ft (3000 m).
- The inverter has been tested with IEC61800-5-1 2007 5.2.3.6.3 Short-circuit Current Test under the following conditions.
Short-circuit current in the supply: 10 kA
Maximum 240 V for 200 V series with 40 HP or below
Maximum 230 V for 200 V series with 50 HP or above
Maximum 480 V for 400 V series
- Connect the inverter to a power system which has a grounded neutral-point. In case of a non-grounded system (ex. Delta-Delta), the control interface of the inverter is basic insulation, thus do not connect SELV circuit from external controller directly. See Basic connection diagram (2.3.4).

Conformity with UL standards and CSA standards (cUL-listed for Canada)

UL/cUL-listed inverters are subject to the regulations set forth by the UL standards and CSA standards (cUL-listed for Canada) by installation within precautions listed below.

⚠ CAUTION

1. Solid state motor overload protection (motor protection by electronic thermal overload relay) is provided in each model. Use function codes F10 to F12 to set the protection level.
2. Use Cu wire only.
3. Use Class 1 wire only for control circuits.
4. Short circuit rating
"Suitable For Use On A Circuit Of Delivering Not More Than 100,000 rms Symmetrical Amperes, 240 Volts Maximum for 230 V class input 40 HP or below, 230 Volts maximum for 230 V class input 50 HP or above when protected by Class J Fuses or a Circuit Breaker having an interrupting rating not less than 100,000 rms Symmetrical Amperes, 240 Volts Maximum." Models FRN; rated for 230 V class input.
"Suitable For Use On A Circuit Of Delivering Not More Than 100,000 rms Symmetrical Amperes, 480 Volts Maximum when protected by Class J Fuses or a Circuit Breaker having an interrupting rating not less than 100,000 rms Symmetrical Amperes, 480 Volts Maximum." Models FRN; rated for 460 V class input.
"Integral solid state short circuit protection does not provide branch circuit protection. Branch circuit protection must be provided in accordance with the National Electrical Code and any additional local codes."
5. Field wiring connections must be made by a UL Listed and CSA Certified closed-loop terminal connector sized for the wire gauge involved. Connector must be fixed using the crimp tool specified by the connector manufacturer.
6. All circuits with terminals L1/R, L2/S, L3/T, R0, T0, R1, T1 must have a common disconnect and be connected to the same pole of the disconnect if the terminals are connected to the power supply.

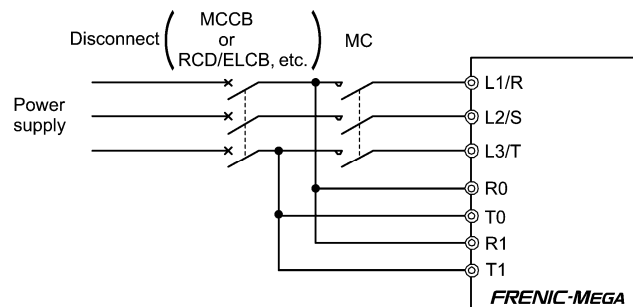

7. When using the inverter as a UL Enclosed Type (UL TYPE1), purchase Type 1 kit (option) and mount it on the inverter as instructed.

Conformity with UL standards and CSA standards (cUL-listed for Canada) (continued)



8. Install UL certified fuses or circuit breaker between the power supply and the inverter, referring to the table below.

Power supply voltage		Nominal applied motor (HP)		Inverter type	HD/LD mode	Class J fuse size (A)	Circuit breaker trip size (A)	Required torque lb-in (N·m)		Wire size AWG (mm ²)									
								Main terminal	Aux. control power supply	Aux. Fan power supply	Main terminal						Aux. control power supply	Aux. fan power supply	
											L1/R, L2/S, L3/T			U, V, W					
											60°C (140°F) Cu wire	75°C (167°F) Cu wire	Remarks	60°C (140°F) Cu wire	75°C (167°F) Cu wire	Remarks			
230 V	0.5	0.25	FRNF50G1S-2U	HD/LD	10	5	10.6 (1.2)	-	-	-	-	-	-	-	-	-	-		
	1	0.5	FRN001G1S-2U		15	10	10.6 (1.2)	-	-	-	-	-	-	-	-	-	-	-	
	2	1	FRN002G1S-2U		20	15	10.6 (1.2)	-	-	-	-	-	-	-	-	-	-	-	
	3	1.5	FRN003G1S-2U	30	20	15.9 (1.8)	-	-	-	-	-	-	-	-	-	-	-	-	
	5	3	FRN005G1S-2U	40	30	15.9 (1.8)	-	-	-	-	-	-	-	-	-	-	-	-	
	7.5		FRN007G1■-2U	60	50	15.9 (1.8)	-	-	-	-	-	-	-	-	-	-	-	-	
	10	5	FRN010G1■-2U	LD	75	75	30.9 (3.5)	-	-	-	-	-	-	-	-	-	-	-	
	15		7.5	FRN015G1■-2U	HD	100	100	30.9 (3.5)	-	-	-	-	-	-	-	-	-	-	
				FRN020G1■-2U	LD	100	100	30.9 (3.5)	-	-	-	-	-	-	-	-	-	-	-
	20	10	FRN025G1■-2U	HD	150	125	30.9 (3.5)	-	-	-	-	-	-	-	-	-	-	-	
	25		FRN030G1■-2U	LD	175	150	51.3 (5.8)	-	-	-	-	-	-	-	-	-	-	-	
	30	15	FRN040G1■-2U	HD	200	175	51.3 (5.8)	-	-	-	-	-	-	-	-	-	-	-	
	40		20	FRN050G1■-2U	LD	250	200	51.3 (5.8)	-	-	-	-	-	-	-	-	-	-	
	50	25	FRN060G1■-2U	HD	350	250	119.4 (13.5)	-	-	-	-	-	-	-	-	-	-	-	
	60		30	FRN075G1■-2U	LD	400	300	238.9 (27)	-	-	-	-	-	-	-	-	-	-	
	75	30	FRN100G1■-2U	HD	450	350	238.9 (27)	-	-	-	-	-	-	-	-	-	-	-	
	100		40	FRN125G1S-2U	LD	500	350	238.9 (27)	-	-	-	-	-	-	-	-	-	-	
	125	40	FRN150G1S-2U	HD	600	400	424.7 (48)	-	-	-	-	-	-	-	-	-	-	-	
	150		50	FRN150G1S-2U	LD	700	500	424.7 (48)	-	-	-	-	-	-	-	-	-	-	

Note 1: Control circuit terminals Tightening torque: 6.1 lb-in (0.7 N·m), Recommended wire size: AWG 19 or 18 (0.65 to 0.82 mm²)

Note 2: A box (■) in the above table replaces S or H depending on the enclosure.

*1 No terminal end treatment is required for connection.

*2 Use 75°C (167°F) Cu wire only.

*3 The wire size of UL Open Type and Enclosed Type are common. Please contact us if UL Open Type exclusive wire is necessary.

Conformity with UL standards and CSA standards (cUL-listed for Canada) (continued)



Power supply voltage		Nominal applied motor (HP)		Inverter type	HD/MD/LD mode	Class J fuse size (A)	Circuit breaker trip size (A)		Required torque lb-in (N·m)		Wire size AWG (mm ²)														
											Main terminal			Aux. control power supply			Aux. fan power supply								
											L1/R, L2/S, L3/T	U, V, W		Remarks	Remarks	Remarks	Aux. control power supply	Aux. fan power supply							
Three-phase	Single-phase	60°C (140°F) Cu wire	75°C (167°F) Cu wire	60°C (140°F) Cu wire	75°C (167°F) Cu wire	60°C (140°F) Cu wire	75°C (167°F) Cu wire	60°C (140°F) Cu wire	75°C (167°F) Cu wire	60°C (140°F) Cu wire		75°C (167°F) Cu wire													
460 V	0.5	0.25	FRNF50G1S-4U	HD/LD	3	5	10.6 (1.2)	-	-	-	-	-	-	-	-	-	-	-	-	-	-	-			
	1	0.5	FRN001G1S-4U		6		15.9 (1.8)																14 (2.1)	14 (2.1)	14 (2.1)
	2	1	FRN002G1S-4U	10	10	15.9 (1.8)	14 (2.1)	14 (2.1)	14 (2.1)	14 (2.1)	-	-	-	-	-	-	-	-	-	-	-	-	-	-	
	3	1.5	FRN003G1S-4U	15	15	15.9 (1.8)	14 (2.1)	14 (2.1)	14 (2.1)	14 (2.1)	-	-	-	-	-	-	-	-	-	-	-	-	-	-	
	5	3	FRN005G1S-4U	20	20	30.9 (3.5)	-	-	-	-	-	-	-	-	-	-	-	-	-	-	-	-	-	-	
	7.5		FRN007G1■-4U	30	30																				12 (3.3)
	10	5	FRN010G1■-4U	HD	30	30	30.9 (3.5)	-	-	-	-	-	-	-	-	-	-	-	-	-	-	-	-	-	-
	15		FRN015G1■-4U	LD	40	40																			
	20	7.5	FRN020G1■-4U	HD	40	40	30.9 (3.5)	-	-	-	-	-	-	-	-	-	-	-	-	-	-	-	-	-	-
	25		FRN025G1■-4U	LD	60	50																			
	30	10	FRN030G1■-4U	HD	60	50	51.3 (5.8)	-	-	-	-	-	-	-	-	-	-	-	-	-	-	-	-	-	-
	40		FRN040G1■-4U	LD	70	60																			
	50	15	FRN050G1■-4U	HD	90	75	51.3 (5.8)	-	-	-	-	-	-	-	-	-	-	-	-	-	-	-	-	-	-
	60		FRN060G1■-4U	LD	100	100																			
	75	20	FRN075G1■-4U	HD	100	100	51.3 (5.8)	-	-	-	-	-	-	-	-	-	-	-	-	-	-	-	-	-	-
	100		FRN080G1■-4U	LD	125	125																			
	125	25	FRN090G1■-4U	HD	125	125	51.3 (5.8)	-	-	-	-	-	-	-	-	-	-	-	-	-	-	-	-	-	-
	150		FRN100G1■-4U	LD	175	150																			
	200	30	FRN120G1■-4U	HD	200	150	119.4 (13.5)	-	-	-	-	-	-	-	-	-	-	-	-	-	-	-	-	-	-
	250		FRN150G1■-4U	LD	250	200																			
	300	40	FRN180G1■-4U	HD	250	200	119.4 (13.5)	-	-	-	-	-	-	-	-	-	-	-	-	-	-	-	-	-	-
	350		FRN200G1■-4U	LD	250	200																			
	400	50	FRN220G1■-4U	HD	300	200	238.9 (27)	-	-	-	-	-	-	-	-	-	-	-	-	-	-	-	-	-	-
	450		FRN250G1■-4U	LD	350	250																			
500	60	FRN280G1■-4U	MD/LD	350	250	238.9 (27)	-	-	-	-	-	-	-	-	-	-	-	-	-	-	-	-	-	-	
550		FRN300G1■-4U	HD	400	300																				1/0×2 (53.5×2)
600	75	FRN320G1■-4U	MD/LD	400	300	424.7 (48)	-	-	-	-	-	-	-	-	-	-	-	-	-	-	-	-	-	-	
650		FRN350G1■-4U	HD	500	350																				3/0×2 (85×2)
700	100	FRN380G1■-4U	MD/LD	500	350	424.7 (48)	-	-	-	-	-	-	-	-	-	-	-	-	-	-	-	-	-	-	
750		FRN400G1■-4U	HD	600	500																				4/0×2 (107.2×2)
800	150	FRN450G1■-4U	MD/LD	600	500	424.7 (48)	-	-	-	-	-	-	-	-	-	-	-	-	-	-	-	-	-	-	
850		FRN500G1■-4U	HD	700	500																				250×2 (127×2)

Note 1: Control circuit terminals Tightening torque: 6.1 lb-in (0.7 N·m), Recommended wire size: AWG 19 or 18 (0.65 to 0.82 mm²)

Note 2: A box (■) in the above table replaces S or H depending on the enclosure.

*1 No terminal end treatment is required for connection.

*2 Use 75°C (167°F) Cu wire only.

*3 The wire size of UL Open Type and Enclosed Type are common. Please contact us if UL Open Type exclusive wire is necessary.

Conformity with UL standards and CSA standards (cUL-listed for Canada) (continued)

CAUTION

Power supply voltage	Nominal applied motor HP		Inverter type	HD/MD/LD mode	Class J fuse size (A)	Circuit breaker trip size (A)	Required torque lb-in (N·m)			Wire size AWG (mm ²)									
							Main terminal	Aux. control power supply	Aux. Fan power supply	Main terminal						Aux. control power supply	Aux. fan power supply		
	L1/R, L2/S, L3/T									U, V, W									
	60°C (140°F) Cu wire	75°C (167°F) Cu wire								Remarks	60°C (140°F) Cu wire	75°C (167°F) Cu wire	Remarks						
460 V	350	-	FRN450G1S-4U	MD	800	424.7 (48)	10.6 (1.2)	10.6 (1.2)	-	300×2 (152×2)	*2	350×2 (177×2)	-	*2	14 (2.1)	14 (2.1)			
	450	125		LD	1000					600		400×2 (203×2)					*3	400×2 (203×2)	*3
	400		FRN500G1S-4U	HD						800		250×2 (127×2)						300×2 (152×2)	
	450	-		MD	1200					300×2 (152×2)							350×2 (177×2)		
	500	150	FRN600G1S-4U	HD	1200					800		400×2 (203×2)						400×2 (203×2)	
			FRN500G1S-4U	LD						1200		500×2 (253×2)					*2	500×2 (253×2)	*2
	600	200	FRN600G1S-4U	MD	1400					1200		500×2 (253×2)					*2	500×2 (253×2)	*2
			FRN700G1S-4U	LD						1400		600×2 (304×2)					*4	600×2 (304×2)	*4
	700	-	FRN700G1S-4U	HD	1600					1400		600×2 (304×2)						600×2 (304×2)	
			FRN800G1S-4U	MD						1600		350×3 (177×3)						400×3 (203×3)	
	800	250	FRN800G1S-4U	LD	2000					1600		500×3 (253×3)						600×3 (304×3)	
			FRN900G1S-4U	HD						2000		500×3 (253×3)						600×3 (304×3)	
	900	300	FRN1000G1S-4U	LD	2200					1400		600×3 (304×3)						500×4 (253×4)	
	1000	400		LD						2200		1600					600×3 (304×3)		500×4 (253×4)

Note: Control circuit terminals Tightening torque: 6.1 lb-in (0.7 N·m), Recommended wire size: AWG 19 or 18 (0.65 to 0.82 mm²)

*1 No terminal end treatment is required for connection.

*2 Use 75°C (167°F) Cu wire only.

*3 The wire size of UL Open Type and Enclosed Type are common. Please contact us if UL Open Type exclusive wire is necessary.

*4 It is showing the wire size for UL Open Type.

See additional material INR-S147-1365□-JE for UL Enclosed Type (Pack with TYPE1 kit).

Conformity with UL standards and CSA standards (cUL-listed for Canada) (continued)

⚠ CAUTION

When applying single-phase to a three-phase drive, the applied motor must not exceed the specifications in the table below. Specifications other than those shown below are the same as those in the "Three-phase 230 V series" and "Three-phase 460 V series."

For precautions for single-phase use, refer to Section 1.3.4.

Standard Model 1 (Basic Type)

(1) Single-phase 230 V series

LD (Low Duty)-mode inverters for light load

Item		Specifications																	
Type (FRN___G1S-2U)		F50	001	002	003	005	007	010	015	020	025	030	040	050	060	075	100	125	150
Nominal applied motor (HP) (Output rating) *1		0.25	0.5	1	1.5	3	3	5	7.5	10	10	15	20	25	30	30	40	40	50
Output ratings	Rated capacity (kVA) *2	0.8	1.3	1.9	2.6	4.4	6.8	9.2	12	13	16	18	23	30	37	38	41	52	59
	Rated current (A)	1.9	3.1	4.7	6.3	11	17	23	30	32	39	44	58	74	93	95	102	131	149
Input ratings	Voltage, frequency	Single-phase, 200 to 240 V, 50/60 Hz												Single-phase, 200 to 220 V, 50 Hz Single-phase, 200 to 230 V, 60 Hz					
	Allowable voltage/frequency	Voltage: +10 to -10% , Frequency: +5 to -5%																	
	Required capacity (with DCR) (kVA) *3	0.5	0.9	1.6	2.2	4.0	5.8	7.9	11	13	16	18	25	32	40	41	47	59	67

HD (High Duty)-mode inverters for heavy load

Item		Specifications																	
Type (FRN___G1S-2U)		F50	001	002	003	005	007	010	015	020	025	030	040	050	060	075	100	125	150
Nominal applied motor (HP) (Output rating) *1		0.25	0.5	1	1.5	3	3	3	5	7.5	10	10	15	20	25	30	30	40	40
Output ratings	Rated capacity (kVA) *2	0.8	1.3	1.9	2.6	4.4	6.8	6.8	9.2	10	13	15	18	24	30	37	38	44	52
	Rated current (A)	1.9	3.1	4.7	6.3	11	17	17	23	26	33	38	45	61	75	93	95	109	131
Input ratings	Voltage, frequency	Single-phase, 200 to 240 V, 50/60 Hz												Single-phase, 200 to 220 V, 50 Hz Single-phase, 200 to 230 V, 60 Hz					
	Allowable voltage/frequency	Voltage: +10 to -10% , Frequency: +5 to -5%																	
	Required capacity (with DCR) (kVA) *3	0.5	0.9	1.6	2.2	4.0	5.8	5.8	7.7	9.7	13	16	18	26	33	40	42	50	58

*1 US 4P-standard induction motor

*2 Rated capacity is calculated assuming the rated output voltage as 230 V for 230 V series and 460 V for 460 V series.

*3 Required when a DC reactor (DCR) is used.

Conformity with UL standards and CSA standards (cUL-listed for Canada) (continued)



(2) Single-phase 460 V series

LD (Low Duty)-mode inverters for light load

(0.25 to 40 HP)

Item		Specifications																	
Type (FRN___G1S-4U)	F50	001	002	003	005	007	010	015	020	025	030	040	050	060	075	100			
Nominal applied motor (HP) (Output rating) *1	0.25	0.5	1	1.5	3	3	5	7.5	10	10	15	20	25	30	30	40			
Output ratings	Rated capacity (kVA) *2	0.8	1.2	2.0	2.4	4.5	6.4	8.8	12	14	16	18	23	30	37	43	47		
	Rated current (A)	0.9	1.5	2.4	3.0	5.6	8.0	11	15	17	20	23	29	37	46	54	59		
Input ratings	Voltage, frequency	Single-phase, 380 to 480 V, 50/60 Hz																	
	Allowable voltage/frequency	Voltage: +10 to -10%, Frequency: +5 to -5%																	
	Required capacity (with DCR) (kVA) *3	0.5	0.9	1.7	2.2	4.0	5.4	7.3	11	13	16	18	25	32	39	46	51		

(50 to 400 HP)

Item		Specifications																
Type (FRN___G1S-4U)	125	150	200	250	300	350	450	500	600	700	800	900	1000					
Nominal applied motor (HP) (Output rating) *1	50	50	60	75	100	100	125	150	200	200	250	300	400					
Output ratings	Rated capacity (kVA) *2	55	65	78	96	116	128	160	198	229	259	305	368	461				
	Rated current (A)	70	82	99	121	146	161	202	250	288	326	384	462	579				
Input ratings	Voltage, frequency	Single-phase, 380 to 440 V, 50 Hz Single-phase, 380 to 480 V, 60 Hz																
	Allowable voltage/frequency	Voltage: +10 to -10%, Frequency: +5 to -5%																
	Required capacity (with DCR) (kVA) *3	61	73	87	105	130	143	181	227	257	291	330	404	488				

HD (High Duty)-mode inverters for heavy load

(0.25 to 30 HP)

Item		Specifications																	
Type (FRN___G1S-4U)	F50	001	002	003	005	007	010	015	020	025	030	040	050	060	075	100			
Nominal applied motor (HP) (Output rating) *1	0.25	0.5	1	1.5	3	3	3	5	7.5	10	10	15	20	25	30	30			
Output ratings	Rated capacity (kVA) *2	0.8	1.2	2.0	2.4	4.5	6.4	6.4	9.6	10	14	16	18	24	30	36	44		
	Rated current (A)	0.9	1.5	2.4	3.0	5.6	8.0	8.0	12	13	17	20	23	30	38	45	55		
Input ratings	Voltage, frequency	Single-phase, 380 to 480 V, 50/60 Hz																	
	Allowable voltage/frequency	Voltage: +10 to -10%, Frequency: +5 to -5%																	
	Required capacity (with DCR) (kVA) *3	0.5	0.9	1.7	2.2	4.0	5.4	5.4	7.8	9.9	13	16	19	26	32	39	49		

(40 to 300 HP)

Item		Specifications																
Type (FRN___G1S-4U)	125	150	200	250	300	350	450	500	600	700	800	900	1000					
Nominal applied motor (HP) (Output rating) *1	40	50	60	60	75	100	100	125	150	150	200	250	300					
Output ratings	Rated capacity (kVA) *2	48	57	68	82	97	118	133	162	184	206	236	305	373				
	Rated current (A)	61	72	86	103	122	149	167	204	231	259	297	384	469				
Input ratings	Voltage, frequency	Single-phase, 380 to 440 V, 50 Hz Single-phase, 380 to 480 V, 60 Hz																
	Allowable voltage/frequency	Voltage: +10 to -10%, Frequency: +5 to -5%																
	Required capacity (with DCR) (kVA) *3	53	63	76	89	108	132	147	182	206	236	265	325	410				

*1 US 4P-standard induction motor

*2 Rated capacity is calculated assuming the rated output voltage as 230 V for 230 V series and 460 V for 460 V series.

*3 Required when a DC reactor (DCR) is used.

Conformity with UL standards and CSA standards (cUL-listed for Canada) (continued)



Standard Model 2 (DCR Built-in Type)

(1) Single-phase 230 V series

LD (Low Duty)-mode inverters for light load

Item		Specifications													
Type (FRN_ _ _ G1H-2U)		007	010	015	020	025	030	040	050	060	075	100			
Nominal applied motor (HP) (Output rating) *1		3	5	7.5	10	10	15	20	25	30	30	30			
Output ratings	Rated capacity (kVA) *2	5.0	6.1	8.7	11	12	16	21	27	32	34	36			
	Rated current (A)	14	17	24.2	31	36	46.2	59.4	75	91	95	102			
Input ratings	Voltage, frequency	Single-phase, 200 to 240 V, 50/60 Hz							Single-phase, 200 to 220 V, 50 Hz Single-phase, 200 to 230 V, 60 Hz						
	Allowable voltage/frequency	Voltage: +10 to -10%, Frequency: +5 to -5%													
	Required capacity (kVA)	4.1	6.6	9.3	12.8	13.2	19.1	26	33	39	40	41			

HD (High Duty)-mode inverters for heavy load

Item		Specifications													
Type (FRN_ _ _ G1H-2U)		007	010	015	020	025	030	040	050	060	075	100			
Nominal applied motor (HP) (Output rating) *1		3	3	5	7.5	10	10	15	20	25	30	30			
Output ratings	Rated capacity (kVA) *2	5.0	5.0	6.8	9.3	11	14	16	21	27	32	34			
	Rated current (A)	14	14	19	26	33	39	47	59.4	75	91	95			
Input ratings	Voltage, frequency	Single-phase, 200 to 240 V, 50/60 Hz							Single-phase, 200 to 220 V, 50 Hz Single-phase, 200 to 230 V, 60 Hz						
	Allowable voltage/frequency	Voltage: +10 to -10%, Frequency: +5 to -5%													
	Required capacity (kVA)	4.1	4.1	6.8	9.6	13.2	13.4	19.3	27	33	40	40			

*1 US 4P-standard induction motor

*2 Rated capacity is calculated assuming the rated output voltage as 230 V for 230 V series and 460 V for 460 V series.

Conformity with UL standards and CSA standards (cUL-listed for Canada) (continued)



(2) Single-phase 460 V series

LD (Low Duty)-mode inverters for light load

Item		Specifications													
Type (FRN_ _ _ G1H-4U)		007	010	015	020	025	030	040	050	060	075	100			
Nominal applied motor (HP) (Output rating) ^{*1}		3	5	7.5	10	10	15	20	25	30	30	40			
Output ratings	Rated capacity (kVA) ^{*2}	6.7	8.7	11	14	17	20	25	31	36	43	47			
	Rated current (A)	8.5	11	14	18	22	25	32	39	46	54	59			
Input ratings	Voltage, frequency	Single-phase, 380 to 480 V, 50/60 Hz													
	Allowable voltage/frequency	Voltage: +10 to -10%, Frequency: +5 to -5%													
	Required capacity (kVA)	4.1	6.6	9.3	12.8	13.2	19.1	26	33	39	40	54			

HD (High Duty)-mode inverters for heavy load

Item		Specifications													
Type (FRN_ _ _ G1H-4U)		007	010	015	020	025	030	040	050	060	075	100			
Nominal applied motor (HP) (Output rating) ^{*1}		3	3	5	7.5	10	10	15	20	25	30	30			
Output ratings	Rated capacity (kVA) ^{*2}	6.7	6.7	9.5	11	14	18	20	26	33	39	47			
	Rated current (A)	8.5	8.5	12	15	18	23	26	33	42	49	59			
Input ratings	Voltage, frequency	Single-phase, 380 to 480 V, 50/60 Hz													
	Allowable voltage/frequency	Voltage: +10 to -10%, Frequency: +5 to -5%													
	Required capacity (kVA)	4.1	4.1	6.8	9.6	13.2	13.5	19.4	27	33	40	41			

*1 US 4P-standard induction motor

*2 Rated capacity is calculated assuming the rated output voltage as 230 V for 230 V series and 460 V for 460 V series.

Table of Contents

<p>Preface i</p> <p>■ Safety precautions..... i</p> <p>Conformity to the Low Voltage Directive in the EU..... v</p> <p>Conformity with UL standards and CSA standards (cUL-listed for Canada)..... ix</p> <p>Chapter 1 BEFORE USING THE INVERTER 1-1</p> <p> 1.1 Acceptance Inspection 1-1</p> <p> 1.2 External View and Terminal Blocks 1-2</p> <p> 1.3 Precautions for Using Inverters..... 1-4</p> <p> 1.3.1 Precautions in introducing inverters..... 1-4</p> <p> 1.3.2 Precautions in running inverters..... 1-9</p> <p> 1.3.3 Precautions in using special motors 1-9</p> <p> 1.3.4 Precautions for use on single-phase power 1-10</p> <p>Chapter 2 MOUNTING AND WIRING THE INVERTER 2-1</p> <p> 2.1 Operating Environment 2-1</p> <p> 2.2 Installing the Inverter 2-1</p> <p> 2.3 Wiring 2-4</p> <p> 2.3.1 Removing and mounting the front cover and the wiring guide 2-4</p> <p> 2.3.2 Screw specifications and recommended wire sizes 2-5</p> <p> 2.3.3 Wiring precautions 2-8</p> <p> 2.3.4 Wiring of main circuit terminals and grounding terminals 2-11</p> <p> 2.3.5 Wiring for control circuit terminals..... 2-18</p> <p> 2.3.6 Setting up the slide switches 2-25</p> <p> 2.4 Mounting and Connecting the Keypad 2-27</p> <p>Chapter 3 OPERATION USING THE KEYPAD 3-1</p> <p> 3.1 LED Monitor, LCD Monitor, and Keys..... 3-1</p> <p> 3.2 Overview of Operation Modes 3-3</p> <p> 3.3 Running Mode 3-4</p> <p> 3.3.1 Running or stopping the motor 3-4</p> <p> 3.3.2 Monitoring the running status on the LED monitor..... 3-5</p> <p> 3.3.3 Monitoring light alarms 3-7</p> <p> 3.4 Programming Mode 3-8</p> <p> 3.4.1 Setting up function codes quickly using Quick Setup -- Menu #0 "Quick Setup" -- 3-9</p> <p> 3.4.2 Setting up function codes -- Menu #1 "Data Setting" -- 3-9</p> <p> 3.4.3 Checking changed function codes -- Menu #2 "Data Checking" -- 3-12</p> <p> 3.4.4 Monitoring the running status -- Menu #3 "Drive Monitoring" -- 3-12</p> <p> 3.4.5 Checking I/O signal status -- Menu #4 "I/O Checking" -- 3-15</p> <p> 3.4.6 Reading maintenance information -- Menu #5 "Maintenance Information" -- 3-18</p> <p> 3.4.7 Reading alarm information -- Menu #6 "Alarm Information" -- 3-24</p> <p> 3.4.8 Viewing causes of alarm -- Menu #7 "Alarm Cause" -- 3-27</p> <p> 3.4.9 Data copying -- Menu #8 "Data Copying" -- .. 3-29</p> <p> 3.4.10 Measuring load factor -- Menu #9 "Load Factor Measurement" -- 3-36</p> <p> 3.4.11 Changing function codes covered by Quick Setup -- Menu #10 "User Setting" -- 3-39</p> <p> 3.4.12 Helping debugging for communication -- Menu #11 "Communication Debugging" -- .. 3-40</p> <p> 3.5 Alarm Mode 3-41</p> <p>Chapter 4 RUNNING THE MOTOR 4-1</p> <p> 4.1 Running the Motor for a Test 4-1</p> <p> 4.1.1 Test run procedure..... 4-1</p> <p> 4.1.2 Checking prior to powering on 4-1</p> <p> 4.1.3 Powering ON and checking 4-2</p> <p> 4.1.4 Switching between LD, MD and HD drive modes..... 4-2</p> <p> 4.1.5 Selecting a desired motor drive control..... 4-3</p> <p> 4.1.6 Function code basic settings < 1 > 4-6</p> <p> 4.1.7 Function code basic settings and tuning < 2 > .. 4-7</p>	<p> 4.1.8 Function code basic settings and tuning < 3 > .. 4-9</p> <p> 4.1.9 Function code basic settings < 4 >..... 4-13</p> <p> 4.1.10 Function code basic settings and tuning < 5 > 4-14</p> <p> 4.1.11 Running the inverter for motor operation check 4-16</p> <p> 4.1.12 Preparation for practical operation 4-18</p> <p> 4.2 Special Operations 4-19</p> <p> 4.2.1 Jogging (inching) the motor..... 4-19</p> <p> 4.2.2 Remote and local modes..... 4-19</p> <p> 4.2.3 External run/frequency command..... 4-20</p> <p>Chapter 5 FUNCTION CODES 5-1</p> <p> 5.1 Function Code Tables 5-1</p> <p> 5.2 Details of Function Codes..... 5-35</p> <p> 5.2.1 Fundamental Functions 5-35</p> <p> 5.2.2 E codes (Extension Terminal Functions) 5-80</p> <p> 5.2.3 C codes (Control functions)..... 5-108</p> <p> 5.2.4 P codes (Motor 1 Parameters)..... 5-112</p> <p> 5.2.5 H codes (High Performance Functions)..... 5-117</p> <p> 5.2.6 A codes (Motor 2 Parameters), b codes (Motor 3 Parameters), r codes (Motor 4 Parameters) 5-138</p> <p> 5.2.7 J codes (Application Functions 1) 5-141</p> <p> 5.2.8 d codes (Application Functions 2)..... 5-160</p> <p> 5.2.9 U codes (Application functions 3)..... 5-168</p> <p> 5.2.10 y codes (Link Functions) 5-177</p> <p>Chapter 6 TROUBLESHOOTING..... 6-1</p> <p> 6.1 Protective Functions 6-1</p> <p> 6.2 Before Proceeding with Troubleshooting..... 6-4</p> <p> 6.3 If Neither an Alarm Code Nor "Light Alarm" Indication ($\angle -FL$) Appears on the LED Monitor ... 6-5</p> <p> 6.3.1 Abnormal motor operation 6-5</p> <p> 6.3.2 Problems with inverter settings..... 6-11</p> <p> 6.4 If an Alarm Code Appears on the LED Monitor 6-12</p> <p> 6.5 If the "Light Alarm" Indication ($\angle -FL$) Appears on the LED Monitor..... 6-25</p> <p> 6.6 If an Abnormal Pattern Appears on the LED Monitor except Alarm Codes and "Light Alarm" Indication ($\angle -FL$) 6-26</p> <p> 6.7 If the Inverter is Running on Single-Phase Power..... 6-27</p> <p>Chapter 7 MAINTENANCE AND INSPECTION 7-1</p> <p> 7.1 Daily Inspection..... 7-1</p> <p> 7.2 Periodic Inspection 7-1</p> <p> 7.3 List of Periodic Replacement Parts..... 7-3</p> <p> 7.3.1 Judgment on service life 7-3</p> <p> 7.4 Measurement of Electrical Amounts in Main Circuit..... 7-6</p> <p> 7.5 Insulation Test..... 7-7</p> <p> 7.6 Inquiries about Product and Guarantee 7-7</p> <p> 7.6.1 When making an inquiry 7-7</p> <p> 7.6.2 Product warranty 7-8</p> <p>Chapter 8 SPECIFICATIONS 8-1</p> <p> 8.1 Standard Model 1 (Basic Type)..... 8-1</p> <p> 8.1.1 Three-phase 230 V series..... 8-1</p> <p> 8.1.2 Three-phase 460 V series..... 8-2</p> <p> 8.2 Standard Model 2 (DCR Built-in Type)..... 8-5</p> <p> 8.2.1 Three-phase 230 V series..... 8-5</p> <p> 8.2.2 Three-phase 460 V series..... 8-6</p> <p> 8.3 Common Specifications..... 8-7</p> <p> 8.4 External Dimensions..... 8-10</p> <p> 8.4.1 Standard models 8-10</p> <p> 8.4.2 Panel cutting of standard model (50 HP or above) 8-11</p> <p> 8.4.3 DC reactor (DCR) 8-12</p> <p> 8.4.4 DCR built-in type 8-15</p> <p> 8.4.5 Standard models with NAMA1 kit (option).... 8-16</p> <p> 8.4.6 Keypad (TP-G1W-J1)..... 8-17</p>
---	--

Chapter 9 CONFORMITY WITH STANDARDS	9-1
9.1 Compliance with UL Standards and Canadian Standards (cUL certification)	9-1
9.1.1 General.....	9-1
9.1.2 Considerations when using FRENIC-MEGA in systems to be certified by UL and cUL	9-1
9.2 Compliance with European Standards.....	9-1
9.3 Compliance with EMC Standards	9-1
9.3.1 General.....	9-1
9.3.2 Recommended installation procedure	9-2
9.4 Compliance with EN954-1, Category 3	9-3
9.4.1 General.....	9-3
9.4.2 Notes for compliance to En954-1 category 3	9-3
9.4.3 EN954-1.....	9-4

Chapter 1 BEFORE USING THE INVERTER

1.1 Acceptance Inspection

Unpack the package and check the following:

- (1) An inverter and instruction manual (this book) are contained in the package.

Note The FRN100G1S-2/4U and higher types come with a DC reactor (DCR). Be sure to connect the DCR.

- (2) The inverter has not been damaged during transportation—there should be no dents or parts missing.
- (3) The inverter is the type you ordered. You can check the type and specifications on the main nameplate. (Main and sub nameplates are attached to the inverter and are located as shown on the next page.)

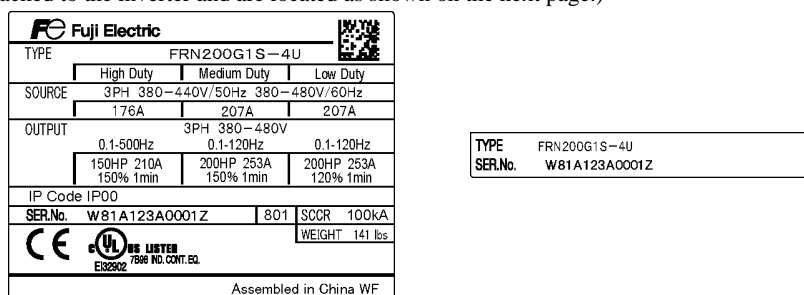

(a) Main Nameplate

(b) Sub Nameplate

Figure 1.1 Nameplates

TYPE: Type of inverter

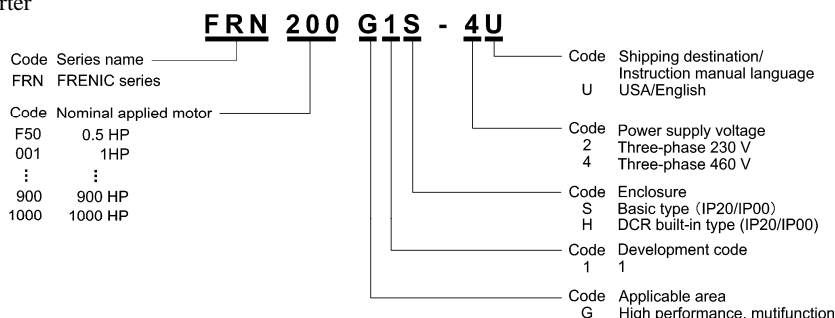

Note In tables given in this manual, inverter types are denoted as "FRN_ _G1■-2U/4U." The box ■ replaces an alphabetic letter depending on the enclosure.

The FRENIC-MEGA is available in two or three drive modes depending upon the inverter capacity: Low Duty (LD) and High Duty (HD) modes or Low Duty (LD), Medium Duty (MD) and High Duty (HD) modes. One of these modes should be selected to match the load property of your system. Specifications in each mode are printed on the main nameplate. For details, see Chapter 8 "SPECIFICATIONS."

Low Duty: LD mode designed for light duty load applications. Overload capability: 120% for 1 min. Continuous ratings = Inverter ratings

Medium Duty: MD mode designed for medium duty load applications. Overload capability: 150% for 1 min. Continuous ratings = Inverter rating or one rank lower capacity of inverters

High Duty: HD mode designed for heavy duty load applications. Overload capability: 150% for 1 min, 200% for 3 s. Continuous ratings = One rank or two ranks lower capacity of inverters

SOURCE: Number of input phases (three-phase: 3PH), input voltage, input frequency, input current (each for LD, MD and HD modes)

OUTPUT: Number of output phases, rated output voltage, output frequency range, rated output capacity, rated output current, overload capability (each for LD, MD and HD modes)

SCCR: Short-circuit capacity

WEIGHT: Mass of the inverter in lbs

SER. No.: Product number manufacturing date

W 8 1 A 1 2 3 A 0 0 0 1 Z

8 0 1

Production week
This indicates the week number that is numbered from 1st week of January. The 1st week of January is indicated as '01'.
Production year: Last digit of year

If you suspect the product is not working properly or if you have any questions about your product, contact your Fuji Electric representative.

1.2 External View and Terminal Blocks

(1) Outside and inside views

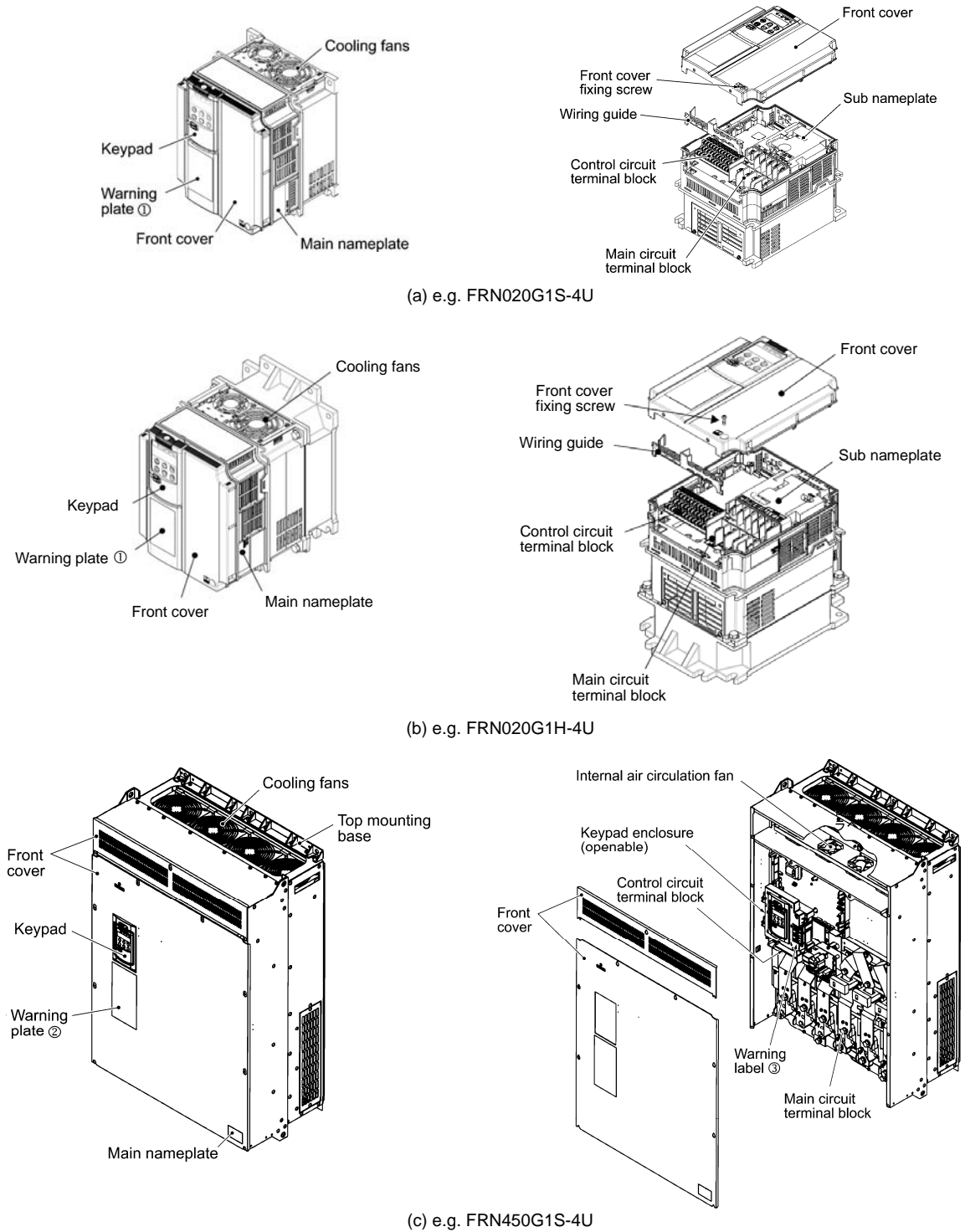
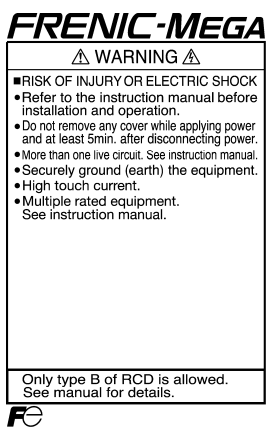
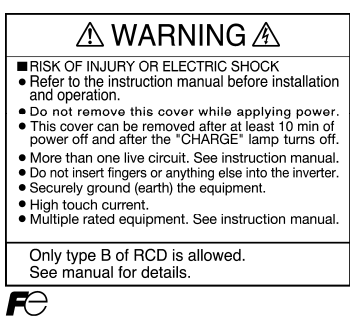

Figure 1.2 Outside and Inside Views of Inverters

(2) Warning plates and labels



Warning plate ①



Warning plate ②



Warning label ③



Warning label ④

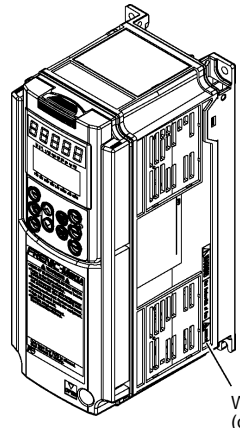

Warning label ④ (on heat sink)

Figure 1.3 Warning Plates and Labels

1.3 Precautions for Using Inverters

1.3.1 Precautions in introducing inverters

This section provides precautions in introducing inverters, e.g. precautions for installation environment, power supply lines, wiring, and connection to peripheral equipment. Be sure to observe those precautions.

■ Installation environment

Install the inverter in an environment that satisfies the requirements listed in Table 2.1 in Chapter 2.

Fuji Electric strongly recommends installing inverters in a panel for safety reasons, in particular, when installing the ones whose enclosure rating is IP00.

When installing the inverter in a place out of the specified environmental requirements, it is necessary to derate the inverter or consider the panel engineering design suitable for the special environment or the panel installation location. For details, refer to the Fuji Electric technical information "Engineering Design of Panels" or consult your Fuji Electric representative.

The special environments listed below require using the specially designed panel or considering the panel installation location.

Environments	Possible problems	Sample measures	Applications
Highly concentrated sulfidizing gas or other corrosive gases	Corrosive gases cause parts inside the inverter to corrode, resulting in an inverter malfunction.	Any of the following measures may be necessary. - Mount the inverter in a sealed panel with IP6X or air-purge mechanism. - Place the panel in a room free from influence of the gases.	Paper manufacturing, sewage disposal, sludge treatment, tire manufacturing, gypsum manufacturing, metal processing, and a particular process in textile factories.
A lot of conductive dust or foreign material (e.g., metal powders or shavings, carbon fibers, or carbon dust)	Entry of conductive dust into the inverter causes a short circuit.	Any of the following measures may be necessary. - Mount the inverter in a sealed panel. - Place the panel in a room free from influence of the conductive dust.	Wiredrawing machines, metal processing, extruding machines, printing presses, combustors, and industrial waste treatment.
A lot of fibrous or paper dust	Fibrous or paper dust accumulated on the heat sink lowers the cooling effect. Entry of dust into the inverter causes the electronic circuitry to malfunction.	Any of the following measures may be necessary. - Mount the inverter in a sealed panel that shuts out dust. - Ensure a maintenance space for periodical cleaning of the heat sink in panel engineering design. - Employ external cooling when mounting the inverter in a panel for easy maintenance and perform periodical maintenance.	Textile manufacturing and paper manufacturing.
High humidity or dew condensation	In an environment where a humidifier is used or where the air conditioner is not equipped with a dehumidifier, high humidity or dew condensation results, which causes a short-circuiting or malfunction of electronic circuitry inside the inverter.	- Put a heating module such as a space heater in the panel.	Outdoor installation. Film manufacturing line, pumps and food processing.
Vibration or shock exceeding the specified level	If a large vibration or shock exceeding the specified level is applied to the inverter, for example, due to a carrier running on seam joints of rails or blasting at a construction site, the inverter structure gets damaged.	- Insert shock-absorbing materials between the mounting base of the inverter and the panel for safe mounting.	Installation of an inverter panel on a carrier or self-propelled machine. Ventilating fan at a construction site or a press machine.
Fumigation for export packaging	Halogen compounds such as methyl bromide used in fumigation corrodes some parts inside the inverter.	- When exporting an inverter built in a panel or equipment, pack them in a previously fumigated wooden crate. - When packing an inverter alone for export, use a laminated veneer lumber (LVL).	Exporting.

■ Storage environment

The storage environment in which the inverter is stored after purchase is different from the operation environment. For details, refer to the FRENIC-MEGA User's Manual, Chapter 2.

■ Wiring precautions

- (1) Route the wiring of the control circuit terminals as far from the wiring of the main circuit as possible. Otherwise electric noise may cause malfunctions.
- (2) Fix the control circuit wires inside the inverter to keep them away from the live parts of the main circuit (such as the terminal block of the main circuit).
- (3) If more than one motor is to be connected to a single inverter, the wiring length should be the sum of the length of the wires to the motors.
- (4) Drive output terminals (U, V, W)
 - 1) Connect these terminals to a 3-phase motor in the correct phase sequence. If the direction of motor rotation is incorrect, exchange any two of the U, V, and W phases.
 - 2) Do not connect a power factor correction capacitor or surge absorber to the inverter output.
 - 3) If the cable from the inverter to the motor is very long, a high-frequency current may be generated by stray capacitance between the cables and result in an overcurrent trip of the inverter, an increase in leakage current, or a reduction in current indication precision.

When a motor is driven by a PWM-type inverter, the motor terminals may be subject to surge voltage generated by inverter element switching. If the motor cable (with 460 V series motors, in particular) is particularly long, surge voltage will deteriorate motor insulation. To prevent this, use the following guidelines:

Inverter 7.5 HP and larger			
Motor Insulation Level	1000 V	1300 V	1600 V
460 VAC Input Voltage	66 ft (20 m)	328 ft (100 m)	1312 ft (400 m)*
230 VAC Input Voltage	1312 ft (400 m)*	1312 ft (400 m)*	1312 ft (400 m)*
Inverter 5 HP and smaller			
Motor Insulation Level	1000 V	1300 V	1600 V
460 VAC Input Voltage	66 ft (20 m)	165 ft (50 m)*	165 ft (50 m)*
230 VAC Input Voltage	328 ft (100 m)*	328 ft (100 m)*	328 ft (100 m)*

* For this case the cable length is determined by secondary effects and not voltage spiking.

- Note**
- When a motor protective thermal O/L relay is inserted between the inverter and the motor, the thermal O/L relay may malfunction (particularly in the 460 V series), even when the cable length is 165 ft (50 m) or less. To correct, insert a filter or reduce the carrier frequency. (Use function code F26 "Motor sound".)
 - For the vector control mode, wiring length is 328 ft (100 m) or less.

- (5) When an output circuit filter is inserted in the secondary circuit or the wiring between the inverter and the motor is long, a voltage loss occurs due to reactance of the filter or wiring so that the insufficient voltage may cause output current oscillation or a lack of motor output torque. To avoid it, select the constant torque load by setting the function code F37 (Load Selection/Auto Torque Boost/Auto Energy Saving Operation 1) to "1" and keep the inverter output voltage at a higher level by configuring H50/H52 (Non-linear V/f Pattern, Frequency) and H51/H53 (Non-linear V/f Pattern, Voltage).

■ Precautions for connection of peripheral equipment

- (1) Phase-advancing capacitors for power factor correction

Do not mount a phase-advancing capacitor for power factor correction in the inverter's input (primary) or output (secondary) circuit. Mounting it in the input (primary) circuit takes no effect. To correct the inverter power factor, use an optional DC reactor (DCR). Mounting it in the output (secondary) circuit causes an overcurrent trip, disabling operation.

An overvoltage trip that occurs when the inverter is stopped or running with a light load is assumed to be due to surge current generated by open/close of phase-advancing capacitors in the power system. An optional DC/AC reactor (DCR/ACR) is recommended as a measure to be taken at the inverter side.

Input current to an inverter contains a harmonic component that may affect other motors and phase-advancing capacitors on the same power supply line. If the harmonic component causes any problems, connect an optional DCR/ACR to the inverter. In some cases, it is necessary to insert a reactor in series with the phase-advancing capacitors.

(2) Power supply lines (Application of a DC/AC reactor)

Use an optional DC reactor (DCR) when the capacity of the power supply transformer is 500 kVA or more and is 10 times or more the inverter rated capacity or when there are thyristor-driven loads. If no DCR is used, the percentage-reactance of the power supply decreases, and harmonic components and their peak levels increase. These factors may break rectifiers or capacitors in the converter section of the inverter, or decrease the capacitance of the capacitors.

If the input voltage unbalance rate is 2% to 3%, use an optional AC reactor (ACR).

$$\text{Voltage unbalance (\%)} = \frac{\text{Max voltage (V)} - \text{Min voltage (V)}}{\text{Three - phase average voltage (V)}} \times 67 \text{ (IEC 61800-3)}$$

(3) DC reactor (DCR) for correcting the inverter input power factor (for suppressing harmonics)

To correct the inverter input power factor (to suppress harmonics), use an optional DCR. Using a DCR increases the reactance of inverter's power source so as to decrease harmonic components on the power source lines and correct the power factor of the inverter.

DCR models	Input power factor	Remarks
DCR2/4-□□/□□A/□□B	Approx. 90% to 95%	The last letter identifies the capacitance.
DCR2/4-□□C	Approx. 86% to 90%	Exclusively designed for inverters of 50 HP or above.

Note For selecting DCR models, refer to Chapter 8 "SPECIFICATIONS."

(4) PWM converter for correcting the inverter input power factor

Using a PWM converter (High power-factor, regenerative PWM converter, RHC series) corrects the inverter power factor up to nearly 100%. When combining an inverter with a PWM converter, disable the main power down detection by setting the function code H72 to "0." If the main power loss detection is enabled (H72 = 1 by factory default), the inverter interprets the main power as being shut down, ignoring an entry of a run command.

(5) Molded case circuit breaker (MCCB) or residual-current-operated protective device (RCD)/earth leakage circuit breaker (ELCB)

Install a recommended MCCB or RCD/ELCB (with overcurrent protection) in the primary circuit of the inverter to protect the wiring. Since using an MCCB or RCD/ELCB with a larger capacity than recommended ones breaks the protective coordination of the power supply system, be sure to select recommended ones. Also select ones with short-circuit breaking capacity suitable for the power source impedance.

Molded Case Circuit Breaker (MCCB) and Residual-Current-Operated Protective Device (RCD)/Earth Leakage Circuit Breaker (ELCB)

Power supply voltage	Nominal applied motor (HP)		Inverter type	HD/MD/LD mode	Rated current of MCCB and RCD/ELCB (A)		
	Three-phase	Single-phase			w/ DCR	w/o DCR	
230 V	0.5	0.25	FRNF50G1S-2U	HD/LD	5	5	
	1	0.5	FRN001G1S-2U			10	
	2	1	FRN002G1S-2U		10	15	
	3	1.5	FRN003G1S-2U			20	
	5	3	FRN005G1S-2U		20	30	
	7.5		FRN007G1■-2U			50	
	10	5	FRN010G1■-2U		HD	40	75
			LD				
	15	7.5	FRN015G1■-2U		HD	50	100
			LD				
	20	10	FRN020G1■-2U	HD	75	125	
			LD				
	25	10	FRN025G1■-2U	HD	100	150	
			LD				
	30	15	FRN030G1■-2U	HD	150	175	
			LD				
	40	20	FRN040G1■-2U	HD	150	200	
			LD				
	50	25	FRN050G1■-2U	HD	175	250	
			LD				
60	30	FRN060G1■-2U	HD	200	300		
		LD					
75	30	FRN075G1■-2U	HD	250	350		
		LD					
100	40	FRN100G1■-2U	HD	350	--		
		LD					
125	40	FRN125G1S-2U	HD	400	--		
		LD					
150	50	FRN150G1S-2U	HD	350	--		

Power supply voltage	Nominal applied motor (HP)		Inverter type	HD/MD/LD mode	Rated current of MCCB and RCD/ELCB (A)		
	Three-phase	Single-phase			w/ DCR	w/o DCR	
460 V	0.5	0.25	FRNF50G1S-4U	HD/LD	5	5	
	1	0.5	FRN001G1S-4U			10	
	2	1	FRN002G1S-4U		10	15	
	3	1.5	FRN003G1S-4U			20	
	5	3	FRN005G1S-4U		20	30	
	7.5		FRN007G1■-4U			50	
	10	5	FRN010G1■-4U		HD	40	75
			LD				
	15	7.5	FRN015G1■-4U		HD	50	100
			LD				
	20	10	FRN020G1■-4U	HD	75	125	
			LD				
	25	10	FRN025G1■-4U	HD	100	150	
			LD				
	30	15	FRN030G1■-4U	HD	150	200	
			LD				
	40	20	FRN040G1■-4U	HD	175	250	
			LD				
	50	25	FRN050G1■-4U	HD	200	300	
			LD				
60	30	FRN060G1■-4U	HD	250	350		
		LD					
75	30	FRN075G1■-4U	HD	300	400		
		LD					
100	40	FRN100G1■-4U	HD	350	--		
		LD					
125	50	FRN125G1S-4U	HD	400	--		

Note: A box (■) in the above table replaces S or H depending on the enclosure.

Power supply voltage	Nominal applied motor (HP)		Inverter type	HD/MD/LD mode	Rated current of MCCB and RCD/ELCB (A)	
	Three-phase	Single-phase			w/ DCR	w/o DCR
460 V	125	50	FRN125G1S-4U	LD	200	--
			FRN150G1S-4U	HD		
	150	60	FRN200G1S-4U	MD/LD	250	
			FRN250G1S-4U	HD		
	200	75	FRN300G1S-4U	MD/LD	300	
			FRN350G1S-4U	HD		
	250	100	FRN450G1S-4U	MD/LD	350	
			FRN500G1S-4U	HD		
	300	125	FRN600G1S-4U	MD/LD	500	
			FRN700G1S-4U	HD		
	350	-	FRN800G1S-4U	MD/LD	600	
			FRN900G1S-4U	HD		
	450	150	FRN1000G1S-4U	MD/LD	800	
			FRN1200G1S-4U	HD		



Power supply voltage	Nominal applied motor (HP)		Inverter type	HD/MD/LD mode	Rated current of MCCB and RCD/ELCB (A)	
	Three-phase	Single-phase			w/ DCR	w/o DCR
460 V	500	150	FRN500G1S-4U	LD	800	--
		-	FRN600G1S-4U	MD		
		150	FRN700G1S-4U	HD		
	600	200	FRN600G1S-4U	LD	1200	
		-	FRN700G1S-4U	MD		
		200	FRN800G1S-4U	HD		
	700	-	FRN700G1S-4U	LD	1400	
			FRN800G1S-4U	MD		
	800	250	FRN800G1S-4U	LD	1600	
			FRN900G1S-4U	HD		
	900	300	FRN1000G1S-4U	MD	1400	
			FRN1200G1S-4U	LD		
	1000	400	FRN1000G1S-4U	HD	1600	
			FRN1200G1S-4U	LD		

⚠ WARNING

If no zero-phase current (earth leakage current) detective device such as a ground-fault relay is installed in the upstream power supply line in order to avoid the entire power supply system's shutdown undesirable to factory operation, install a residual-current-operated protective device (RCD)/earth leakage circuit breaker (ELCB) individually to inverters to break the individual inverter power supply lines only.

Otherwise, a fire could occur.

(6) Magnetic contactor (MC) in the inverter input (primary) circuit

Avoid frequent ON/OFF operation of the magnetic contactor (MC) in the input circuit; otherwise, the inverter failure may result. If frequent start/stop of the motor is required, use **FWD/REV** terminal signals or the  /  keys on the inverter's keypad.

The frequency of the MC's ON/OFF should not be more than once per 30 minutes. To assure 10-year or longer service life of the inverter, it should not be more than once per hour.



- From the system's safety point of view, it is recommended to employ such a sequence that shuts down the magnetic contactor (MC) in the inverter input circuit with an alarm output signal **ALM** issued on inverter's programmable output terminals. The sequence minimizes the secondary damage even if the inverter breaks. When the sequence is employed, connecting the MC's primary power line to the inverter's auxiliary control power input makes it possible to monitor the inverter's alarm status on the keypad.
- The breakdown of a braking unit or misconnection of an external braking resistor may trigger that of the inverter's internal parts (e.g., charging resistor). To avoid such a breakdown linkage, introduce an MC and configure a sequence that shuts down the MC if a DC link voltage establishment signal is not issued within three seconds after the MC is switched on. For the braking transistor built-in type of inverters, assign a transistor error output signal **DBAL** on inverter's programmable output terminals to switch off the MC in the input circuit.

(7) Magnetic contactor (MC) in the inverter output (secondary) circuit

If a magnetic contactor (MC) is inserted in the inverter's output (secondary) circuit for switching the motor to a commercial power or for any other purposes, it should be switched on and off when both the inverter and motor are completely stopped. This prevents the contact point from getting rough due to a switching arc of the MC. The MC should not be equipped with any main circuit surge killer.

Applying a commercial power to the inverter's output circuit breaks the inverter. To avoid it, interlock the MC on the motor's commercial power line with the one in the inverter output circuit so that they are not switched ON at the same time.

(8) Surge absorber/surge killer

Do not install any surge absorber or surge killer in the inverter's output (secondary) lines.

■ Noise reduction

If noise generated from the inverter affects other devices, or that generated from peripheral equipment causes the inverter to malfunction, follow the basic measures outlined below.

- (1) If noise generated from the inverter affects the other devices through power wires or grounding wires:
 - Isolate the grounding terminals of the inverter from those of the other devices.
 - Connect a noise filter to the inverter power wires.
 - Isolate the power system of the other devices from that of the inverter with an insulated transformer.
 - Decrease the inverter's carrier frequency (F26).
- (2) If induction or radio noise generated from the inverter affects other devices:
 - Isolate the main circuit wires from the control circuit wires and other device wires.
 - Put the main circuit wires through a metal conduit pipe, and connect the pipe to the ground near the inverter.
 - Install the inverter into the metal panel and connect the whole panel to the ground.
 - Connect a noise filter to the inverter's power wires.
 - Decrease the inverter's carrier frequency (F26).
- (3) When implementing measures against noise generated from peripheral equipment:
 - For inverter's control signal wires, use twisted or shielded-twisted wires. When using shielded-twisted wires, connect the shield of the shielded wires to the common terminals of the control circuit.
 - Connect a surge absorber in parallel with magnetic contactor's coils or other solenoids (if any).

■ Leakage current

A high frequency current component generated by insulated gate bipolar transistors (IGBTs) switching on/off inside the inverter becomes leakage current through stray capacitance of inverter input and output wires or a motor. If any of the problems listed below occurs, take an appropriate measure against them.

Problem	Measures
An earth leakage circuit breaker* that is connected to the input (primary) side has tripped. *With overcurrent protection	1) Decrease the carrier frequency. 2) Make the wires between the inverter and motor shorter. 3) Use an earth leakage circuit breaker with lower sensitivity than the one currently used. 4) Use an earth leakage circuit breaker that features measures against the high frequency current component (Fuji SG and EG series).
An external thermal relay was activated.	1) Decrease the carrier frequency. 2) Increase the current setting of the thermal relay. 3) Use the electronic thermal overload protection built in the inverter, instead of the external thermal relay.

■ Selecting inverter capacity

- (1) To drive a general-purpose motor, select an inverter according to the nominal applied motor rating listed in the standard specifications table. When high starting torque is required or quick acceleration or deceleration is required, select an inverter with one rank higher capacity than the standard.
- (2) Special motors may have larger rated current than general-purpose ones. In such a case, select an inverter that meets the following condition.

$$\text{Inverter rated current} > \text{Motor rated current}$$

1.3.2 Precautions in running inverters

Precautions for running inverters to drive motors or motor-driven machinery are described below.

■ Motor temperature

When an inverter is used to run a general-purpose motor, the motor temperature becomes higher than when it is operated with a commercial power supply. In the low-speed range, the motor cooling effect will be weakened, so decrease the output torque of the motor when running the inverter in the low-speed range.

■ Motor noise

When a general-purpose motor is driven by an inverter, the noise level is higher than that when it is driven by a commercial power supply. To reduce noise, raise carrier frequency of the inverter. Operation at 60 Hz or higher can also result in higher noise level.

■ Machine vibration

When an inverter-driven motor is mounted to a machine, resonance may be caused by the natural frequencies of the motor-driven machinery. Driving a 2-pole motor at 60 Hz or higher may cause abnormal vibration. If it happens, do any of the following:

- Consider the use of a rubber coupling or vibration-proof rubber.
- Use the inverter's jump frequency control feature to skip the resonance frequency zone(s).
- Use the vibration suppression related function codes that may be effective. For details, refer to the description of H80 in Chapter 5 "FUNCTION CODES."

1.3.3 Precautions in using special motors

When using special motors, note the followings.

■ Explosion-proof motors

When driving an explosion-proof motor with an inverter, use a combination of a motor and an inverter that has been approved in advance.

■ Submersible motors and pumps

These motors have a larger rated current than general-purpose motors. Select an inverter whose rated output current is greater than that of the motor. These motors differ from general-purpose motors in thermal characteristics. Decrease the thermal time constant of the electronic thermal overload protection to match the motor rating.

■ Brake motors

For motors equipped with parallel-connected brakes, their power supply for braking must be supplied from the inverter input (primary) circuit. If the power supply for braking is mistakenly connected to the inverter's output (secondary) circuit, the brake may not work when the inverter output is shut down. Do not use inverters for driving motors equipped with series-connected brakes.

■ Geared motors

If the power transmission mechanism uses an oil-lubricated gearbox or speed changer/reducer, then continuous operation at low speed may cause poor lubrication. Avoid such operation.

■ Synchronous motors

It is necessary to take special measures suitable for this motor type. Contact your Fuji Electric representative for details.

■ Single-phase motors

Single-phase motors are not suitable for inverter-driven variable speed operation.

■ High-speed motors

If the reference frequency is set to 120 Hz or higher to drive a high-speed motor, test-run the combination of the inverter and motor beforehand to check it for the safe operation.

1.3.4 Precautions for use on single-phase power

An inverter is a device that converts alternating current of the input line to direct current via the ac-to-dc rectifier and then converts it to alternating current via the dc-to-ac switching inverter circuit in order to output the required alternating current. The FRENIC-MEGA is designed to connect to the three-phase power and this manual stipulates the specifications for the use on the three-phase power.

If the inverter designed for connection to three-phase power runs on single-phase power, ripples (voltage fluctuation) on the DC link bus voltage rectified from the input power become larger than those in the inverter running on three-phase power. The DC-voltage ripple affects the inverter output; that is, ripples could be superimposed on the output voltage or current, making control hard.

Accordingly, the inverter may not work in full performance or function correctly. To use the FRENIC-MEGA on single-phase power, therefore, you need to take the following into account.

■ Output current

Select the inverter capacity to keep the output current within the specified level, referring to pages xx to xxiii. Output current exceeding the limit extremely increases voltage ripples on the DC link bus, impeding normal operation or resulting in an inverter breakdown.

■ Wiring

When connecting 230 V inverters of 60 HP or above or 460 V ones of 125 HP or above to single-phase power, use L1 and L3 phases since cooling fans and magnetic contactors inside the inverter are supplied with power via L1 and L3. Using L2 does not work cooling fans or magnetic contactors, causing abnormal heat, in the worst case, resulting in an inverter breakdown.

■ Connecting peripheral devices

For the specifications of circuit breakers and fuses to apply, refer to pages x to xii and for those of MCCB or RCD/ELCB, pages 1-6 and 1-7.

■ Configuring function codes

- (1) Cancel the input phase loss protection of the protection/maintenance function with function code H98 (Bit 1 = 0). This is because the inverter judges single-phase power as a phase loss.
- (2) Do not use the inverter in the MD mode. Limit the drive mode to the LD/HD mode (Function code F80 = 0 or 1).
- (3) Do not use "Vector control without speed sensor" or torque control. (Function codes F42 ≠ 5, H18 = 0)
- (4) "V/f control with slip compensation inactive" is recommended (F42 = 0).

Any other drive control calculates the motor model using the motor parameters inside the inverter. As ripples on the DC link bus voltage become larger, therefore, calculation causes some errors so that the inverter may not provide the desired performance. Consider this problem before use.

In particular, when using "Vector control with speed sensor" (F42 = 6), dancer control (J01 = 3), or brake signals (J68, J69, J70, etc.), assure the operation and safety of those speed sensors.

Chapter 2 MOUNTING AND WIRING THE INVERTER

2.1 Operating Environment

Install the inverter in an environment that satisfies the requirements listed in Table 2.1.

Item	Specifications												
Site location	Indoors												
Surrounding/ambient temperature	-10 to +50°C (14 to 122°F) (Note 1)												
Relative humidity	5 to 95% (No condensation)												
Atmosphere	The inverter must not be exposed to dust, direct sunlight, corrosive gases, flammable gases, oil mist, vapor or water drops. Pollution degree 2 (IEC60664-1) (Note 2) The atmosphere can contain a small amount of salt. (0.01 mg/cm ² or less per year) The inverter must not be subjected to sudden changes in temperature that will cause condensation to form.												
Altitude	3300 ft (1000 m) max. (Note 3)												
Atmospheric pressure	86 to 106 kPa												
Vibration	<table border="1"> <thead> <tr> <th>Inverters of 100 HP or below (230 V series) 125 HP or below (460 V series)</th> <th>Inverters of 125 HP or above (230 V series) 150 HP or above (460 V series)</th> </tr> </thead> <tbody> <tr> <td>0.12 inch (3 mm) (Max. amplitude)</td> <td>0.12 inch (3 mm) (Max. amplitude)</td> </tr> <tr> <td>2 to less than 9 Hz</td> <td>2 to less than 9 Hz</td> </tr> <tr> <td>9.8 m/s² 9 to less than 20 Hz</td> <td>2 m/s² 9 to less than 55 Hz</td> </tr> <tr> <td>2 m/s² 20 to less than 55 Hz</td> <td>1 m/s² 55 to less than 200 Hz</td> </tr> <tr> <td>1 m/s² 55 to less than 200 Hz</td> <td></td> </tr> </tbody> </table>	Inverters of 100 HP or below (230 V series) 125 HP or below (460 V series)	Inverters of 125 HP or above (230 V series) 150 HP or above (460 V series)	0.12 inch (3 mm) (Max. amplitude)	0.12 inch (3 mm) (Max. amplitude)	2 to less than 9 Hz	2 to less than 9 Hz	9.8 m/s ² 9 to less than 20 Hz	2 m/s ² 9 to less than 55 Hz	2 m/s ² 20 to less than 55 Hz	1 m/s ² 55 to less than 200 Hz	1 m/s ² 55 to less than 200 Hz	
Inverters of 100 HP or below (230 V series) 125 HP or below (460 V series)	Inverters of 125 HP or above (230 V series) 150 HP or above (460 V series)												
0.12 inch (3 mm) (Max. amplitude)	0.12 inch (3 mm) (Max. amplitude)												
2 to less than 9 Hz	2 to less than 9 Hz												
9.8 m/s ² 9 to less than 20 Hz	2 m/s ² 9 to less than 55 Hz												
2 m/s ² 20 to less than 55 Hz	1 m/s ² 55 to less than 200 Hz												
1 m/s ² 55 to less than 200 Hz													

Table 2.2 Output Current Derating Factor in Relation to Altitude

Altitude	Output current derating factor
3300 ft (1000 m) or lower	1.00
3300 to 4900 ft (1000 to 1500 m)	0.97
4900 to 6600 ft (1500 to 2000 m)	0.95
6600 to 8200 ft (2000 to 2500 m)	0.91
8200 to 9800 ft (2500 to 3000 m)	0.88

(Note 1) When inverters (40 HP or below) are mounted side-by-side without any clearance between them, the surrounding temperature should be within the range from -10 to +40°C (14 to 104°F). This specification also applies to the inverters (40 HP) equipped with a NEMA1 kit.

(Note 2) Do not install the inverter in an environment where it may be exposed to lint, cotton waste or moist dust or dirt which will clog the heat sink of the inverter. If the inverter is to be used in such an environment, install it in a dustproof panel.

(Note 3) If you use the inverter in an altitude above 3300 ft (1000 m), you should apply an output current derating factor as listed in Table 2.2.

2.2 Installing the Inverter

(1) Mounting base

Install the inverter on a base made of metal or other non-flammable material.

⚠ WARNING
Install the inverter on a base made of metal or other non-flammable material. Otherwise, a fire could occur.

(2) Clearances

Ensure that the minimum clearances indicated in Figure 2.1 and Table 2.3 are maintained at all times. When mounting the inverter in the panel of your system, take extra care with ventilation inside the panel as the surrounding temperature easily rises. Do not mount the inverter in a small panel with poor ventilation.

■ When mounting two or more inverters

When mounting two or more inverters in the same unit or panel, install them side by side. When one must be mounted above the other, be sure to separate them with a partition plate, or the like, so that any heat radiating from an inverter will not affect the one/s above.

As long as the surrounding temperature is 40°C (104°F) or lower, inverters of 40 HP or below can be mounted side by side without any clearance between them.

Inverter capacity	inch (mm)		
	A	B	C
0.5 to 2 HP	2.0 (50)	3.9 (100)	0
3 to 40 HP	0.39 (10)		3.9 (100)
50 to 450 HP	2.0 (50)	5.9 (150)	3.9 (100)
500 to 1000 HP			5.9 (150)

C: Space required in front of the inverter unit

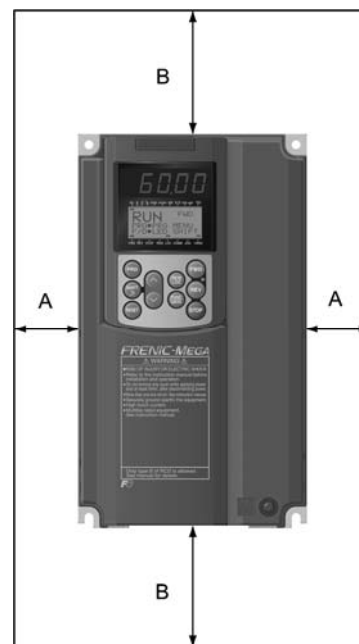

■ When employing external cooling

In external cooling, the heat sink, which dissipates about 70% of the total heat (total loss) generated into air, is situated outside the equipment or the panel. The external cooling, therefore, significantly reduces heat radiating inside the equipment or panel.

To employ external cooling for inverters (except DCR built-in type) of 40 HP or below, use the mounting adapter for external cooling (option); for those of 50 HP or above, simply change the positions of the mounting bases.

Note The DCR built-in type of 40 HP or below cannot employ external cooling.

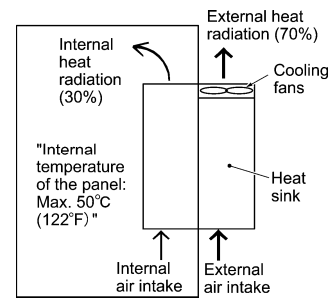

Figure 2.2 External Cooling

CAUTION

Prevent lint, paper fibers, sawdust, dust, metallic chips, or other foreign materials from getting into the inverter or from accumulating on the heat sink.

Otherwise, a fire or accident could occur.

To utilize external cooling for inverters of 50 HP or above, change the positions of the top and bottom mounting bases from the edge to the center of the inverter as shown in Figure 2.3.

Screws differ in size and count for each inverter. Refer to the table below.

Table 2.4 Screw Size, Count and Tightening Torque

Inverter type	Base fixing screw (Screw size and q'ty)	Case fixing screw (Screw size and q'ty)	Tightening torque lb-in (N.m)
FRN050G1■-2U/FRN060G1■-2U FRN050G1■-4U to FRN100G1■-4U	M6 × 20 5 pcs for upper side, 3 pcs for lower side	M6 × 20 2 pcs for upper side	51.3 (5.8)
FRN075G1■-2U/FRN100G1■-2U FRN125G1S-4U	M6 × 20 3 pcs each for upper and lower sides	M6 × 12 3 pcs for upper side	51.3 (5.8)
FRN125G1S-2U FRN150G1S-4U/FRN200G1S-4U	M5 × 12 7 pcs each for upper and lower sides	M5 × 12 7 pcs for upper side	31.0 (3.5)
FRN250G1S-4U/FRN300G1S-4U	M5 × 16 7 pcs each for upper and lower sides	M5 × 16 7 pcs for upper side	31.0 (3.5)
FRN150G1S-2U FRN350G1S-4U/FRN450G1S-4U	M5 × 16 8 pcs each for upper and lower sides	M5 × 16 8 pcs for upper side	31.0 (3.5)
FRN500G1S-4U/FRN600G1S-4U FRN700G1S-4U/FRN800G1S-4U	M5 × 16 2 pcs each for upper and lower sides M6 × 20 6 pcs each for upper and lower sides	M5 × 16 2 pcs each for upper and lower sides M6 × 20 6 pcs each for upper and lower sides	31.0 (3.5) 51.3 (5.8)
FRN900G1S-4U/FRN1000G1S-4U	M8 × 20 8 pcs each for upper and lower sides	M8 × 20 8 pcs each for upper and lower sides	119 (13.5)

Note: A box (■) in the above table replaces S or H depending on the enclosure.

- 1) Remove all of the base fixing screws and the case fixing screws from the top of the inverter.
- 2) Move the top mounting base to the center of the inverter and secure it to the case fixing screw holes with the base fixing screws. (After changing the position of the top mounting base, some screws may be left unused.)
- 3) Remove the base fixing screws from the bottom of the inverter, move the bottom mounting base to the center of the inverter, and secure it with the base fixing screws, just as in step 2). (Inverters of 450 HP or below have no case fixing screws on the bottom.)

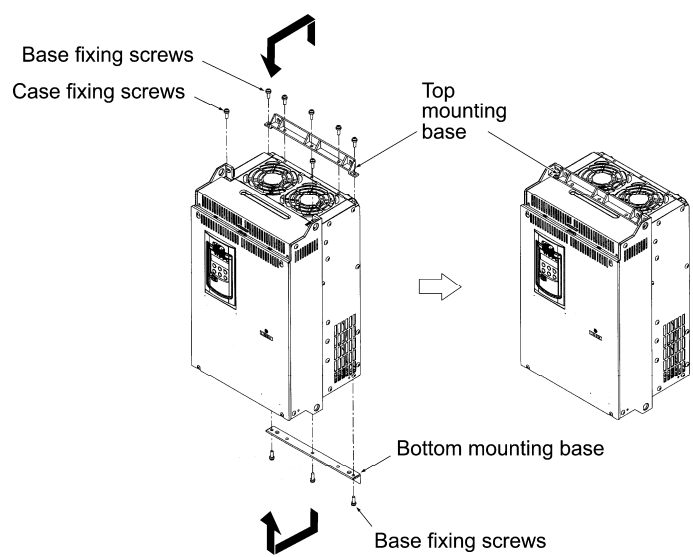

Figure 2.3 Changing the Positions of the Top and Bottom Mounting Bases

CAUTION

When changing the positions of the top and bottom mounting bases, use only the specified screws.
Otherwise, a fire or accident could occur.

(3) Mounting notes

The FRN007G1H-2/4U through FRN040G1H-2/4U should be mounted with four screws or bolts using screw holes A or B shown below. Note that, at each of the top and bottom of the inverter, the two screws or bolts should be located in a bilaterally symmetrical position.

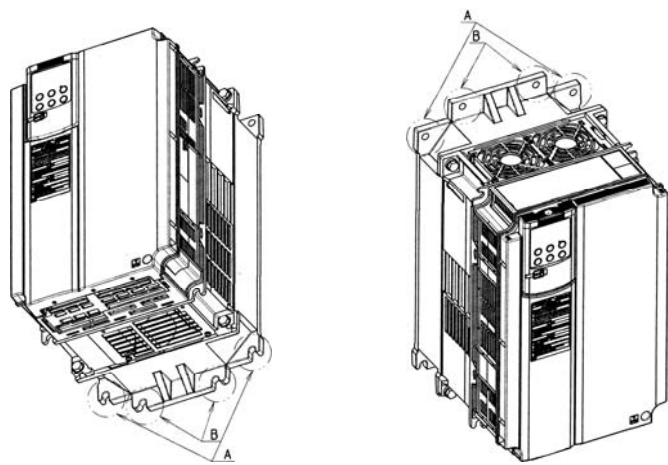

2.3 Wiring

Follow the procedure below. (In the following description, the inverter has already been installed.)

2.3.1 Removing and mounting the front cover and the wiring guide

(1) For inverters of 40 HP or below

- ① First loosen the front cover fixing screw, slide the cover downward holding both sides, tilt it toward you, and then pull it upward, as shown below.
- ② While pressing the wiring guide upward, pull it out toward you.
- ③ After carrying out wiring (see Sections 2.3.2 through 2.3.6), put the wiring guide and the front cover back into place in the reverse order of removal.

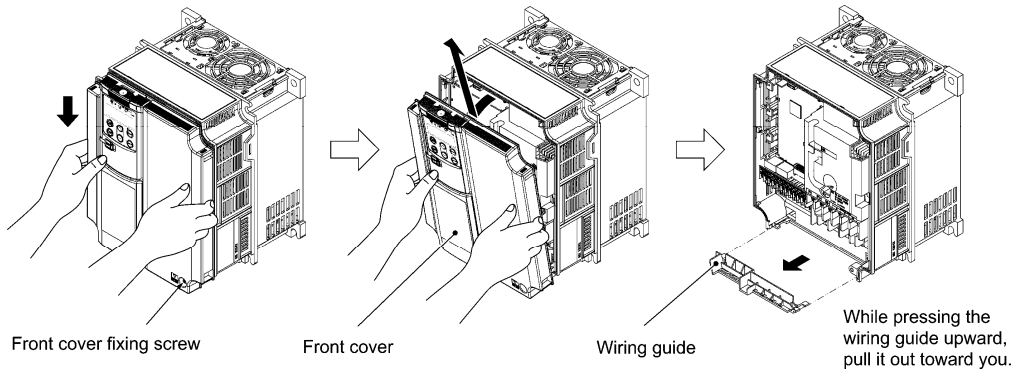

Figure 2.4 Removing the Front Cover and the Wiring Guide (e.g. FRN020G1S-4U)

(2) For inverters with of 50 to 1000 HP

- ① Loosen the four front cover fixing screws, hold the cover with both hands, slide it upward slightly, and pull it toward you, as shown below.
- ② After carrying out wiring (see Sections 2.3.2 through 2.3.6), align the screw holes provided in the front cover with the screws on the inverter case, then put the front cover back into place in the reverse order of removal.

Tip To expose the control printed circuit board (control PCB), open the keypad enclosure.

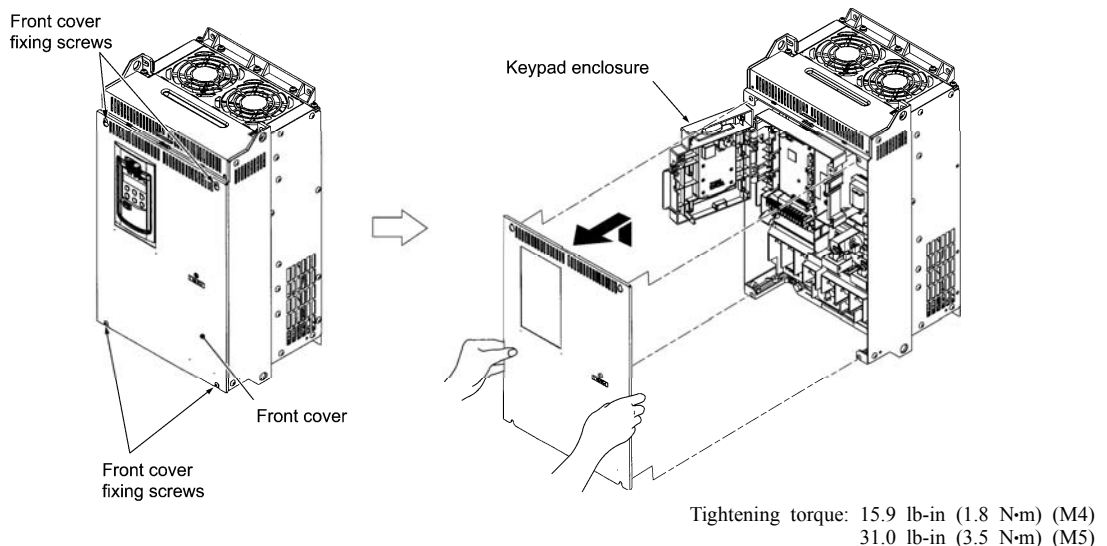

Figure 2.5 Removing the Front Cover (e.g. FRN050G1S-4U)

2.3.2 Screw specifications and recommended wire sizes

(1) Arrangement of main circuit terminals

The tables and figures given below show the screw specifications and wire sizes. Note that the terminal arrangements differ depending on the inverter types. In each of the figures, two grounding terminals (⊕G) are not exclusive to the power supply wiring (primary circuit) or motor wiring (secondary circuit).

Use crimp terminals covered with an insulation sheath or with an insulation tube.

The recommended wires for main circuit terminals are selected according to the sizes conforming to UL508C.

Table 2.5 Screw Specifications

Inverter type		Refer to:	Screw specifications							
Three-phase 230 V	Three-phase 460 V		Main circuit terminals		Grounding terminals		Auxiliary control power input terminals [R0, T0]		Auxiliary fan power input terminals [R1, T1]	
			Screw size	Tightening torque lb-in (N·m)	Screw size	Tightening torque lb-in (N·m)	Screw size	Tightening torque lb-in (N·m)	Screw size	Tightening torque lb-in (N·m)
FRNF50G1S-2U	FRNF50G1S-4U	Figure A	M3.5	10.6 (1.2)	M3.5	10.6 (1.2)	--	--		
FRN001G1S-2U	FRN001G1S-4U									
FRN002G1S-2U	FRN002G1S-4U	Figure B	M4	15.9 (1.8)	M4	15.9 (1.8)				
FRN003G1S-2U	FRN003G1S-4U									
FRN005G1S-2U	FRN005G1S-4U	Figure C	M5	31.0 (3.5)	M5	31.0 (3.5)			--	--
FRN007G1■-2U	FRN007G1■-4U									
FRN010G1■-2U	FRN010G1■-4U									
FRN015G1■-2U	FRN015G1■-4U									
FRN020G1■-2U	FRN020G1■-4U	Figure D	M6	51.3 (5.8)	M6	51.3 (5.8)				
FRN025G1■-2U	FRN025G1■-4U									
FRN030G1■-2U	FRN030G1■-4U	Figure E	M8	119 (13.5)	M8	119 (13.5)	M3.5	10.6 (1.2)		
FRN040G1■-2U	FRN040G1■-4U									
FRN050G1■-2U	FRN050G1■-4U	Figure F	M10	239 (27)	M8	119 (13.5)				
	FRN060G1■-4U									
	FRN075G1■-4U									
	FRN100G1■-4U									
FRN060G1■-2U	FRN125G1S-4U	Figure G	M10	239 (27)						
FRN075G1■-2U										
FRN100G1■-2U	FRN150G1S-4U	Figure H								
--	FRN200G1S-4U									
FRN125G1S-2U	--	Figure M	M12	425 (48)	M10	239 (27)			M3.5	10.6 (1.2)
--	FRN250G1S-4U	Figure H								
--	FRN300G1S-4U	Figure I								
FRN150G1S-2U	FRN350G1S-4U	Figure J								
--	FRN450G1S-4U	Figure K								
--	FRN500G1S-4U	Figure L								
--	FRN600G1S-4U									
--	FRN700G1S-4U									
--	FRN800G1S-4U									
--	FRN900G1S-4U									
--	FRN1000G1S-4U									

Note: A box (■) in the above table replaces S or H depending on the enclosure.

⚠ WARNING ⚠
<p>When the inverter power is ON, a high voltage is applied to the following terminals.</p> <p>Main circuit terminals: L1/R, L2/S, L3/T, P1, P(+), N(-), DB, U, V, W, R0, T0, R1, T1, AUX-contact (30A, 30B, 30C, Y5A, Y5C)</p> <p>Insulation level</p> <p>Main circuit — Enclosure : Basic insulation (Overvoltage category III, Pollution degree 2)</p> <p>Main circuit — Control circuit : Reinforced insulation (Overvoltage category III, Pollution degree 2)</p> <p>Relay output — Control circuit : Reinforced insulation (Overvoltage category II, Pollution degree 2)</p> <p>An electric shock may occur.</p>

Figure A

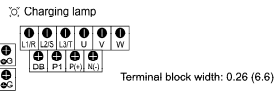

Figure B

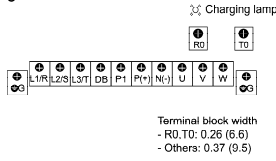

Figure C

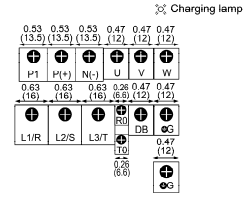

Figure D

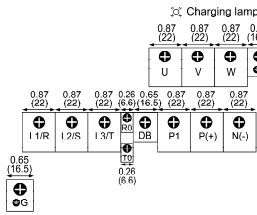

Figure E

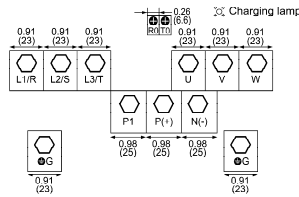

Figure F / Figure G

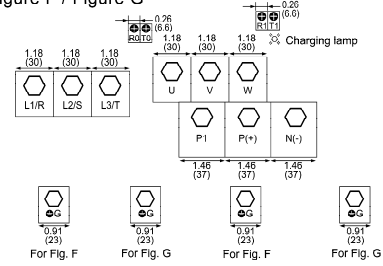

Figure H / Figure I

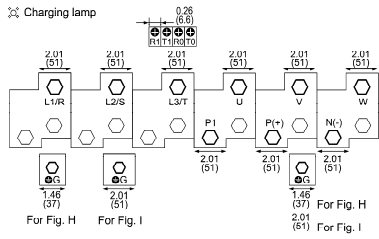

Figure J

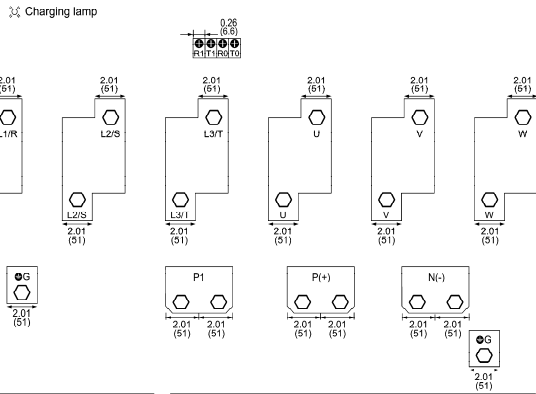

Figure K

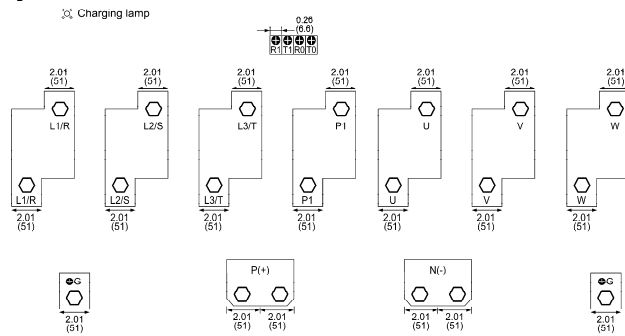

Figure M

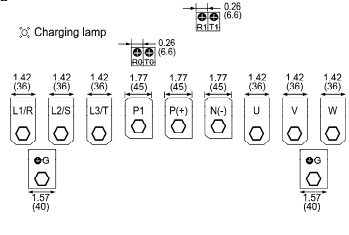

Figure L

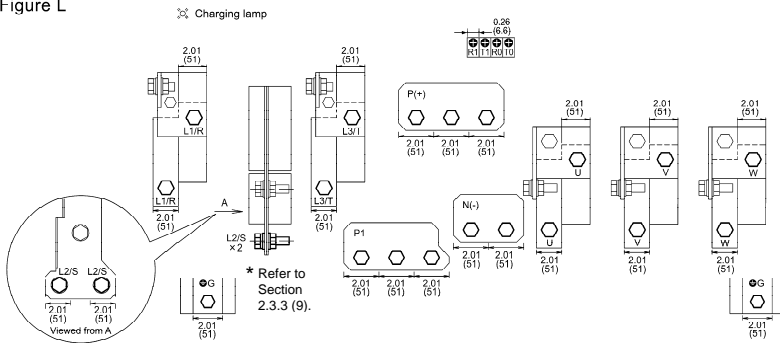

Table 2.6 Recommended Wire Sizes

Power supply voltage	Inverter type			Recommended wire size AWG (mm ²)				Braking resistor [P(+), DB]
	LD mode	MD mode	HD mode	L1/R, L2/S, L3/T	Grounding [EG]	U, V, W	DCR [P1, P(+)]	
Single-phase/Three-phase 230V	FRNF50G1S-2U	--	FRNF50G1S-2U	14 (2.1)	14 (2.1)	14 (2.1)	14 (2.1)	10 (5.3)
	FRN001G1S-2U	--	FRN001G1S-2U		12 (3.3)			
	FRN002G1S-2U	--	FRN002G1S-2U	10 (5.3)	12 (3.3)	10 (5.3)		
	FRN003G1S-2U	--	FRN003G1S-2U					
	FRN005G1S-2U	--	FRN005G1S-2U	8 (8.4)	8 (8.4)	8 (8.4)		
	FRN007G1■-2U	--	FRN007G1■-2U					
	--	--	FRN010G1■-2U	8 (8.4)	8 (8.4)	4 (21.2)		
	FRN010G1■-2U	--	--					
	--	--	FRN015G1■-2U	6 (13.3)	6 (13.3)	6 (13.3)	3 (26.7)	
	FRN015G1■-2U	--	FRN020G1■-2U	4 (21.2)				
	FRN020G1■-2U	--	FRN025G1■-2U	3 (26.7)	6 (13.3)	4 (21.2)	2 (33.6)	
	FRN025G1■-2U	--	FRN030G1■-2U	2 (33.6)				
	FRN030G1■-2U	--	FRN040G1■-2U	2 (33.6)	4 (21.2)	2 (33.6)	2/0 (67.4)	
	FRN040G1■-2U	--	--					
	--	--	FRN050G1■-2U	2/0 (67.4)	3 (26.7)	1/0 (53.5)	4/0 (107.2)	
	FRN050G1■-2U	--	--					
	--	--	FRN060G1■-2U	3/0 (85)	4/0 (107.2)	4/0 (107.2)	250 (127)	
	FRN060G1■-2U	--	FRN075G1■-2U	4/0 (107.2)				
	FRN075G1■-2U	--	FRN100G1■-2U	2/0 (67.4) × 2	2 (33.6)	3/0 (85) × 2	350 (177)	
	FRN100G1■-2U	--	FRN125G1S-2U	3/0 (85) × 2				
FRN125G1S-2U	--	FRN150G1S-2U	4/0 (107.2) × 2	1 (42.4)	4/0 (107.2) × 2	500 (253)		
FRN150G1S-2U	--	--	300 (152) × 2	1/0 (53.5)	300 (152) × 2	4/0 (107.2) × 2		
Single-phase/Three-phase 460V	FRNF05G1S-4U	--	FRNF05G1S-4U	14 (2.1)	14 (2.1)	14 (2.1)	14 (2.1)	10 (5.3)
	FRN001G1S-4U	--	FRN001G1S-4U		12 (3.3)			
	FRN002G1S-4U	--	FRN002G1S-4U	12 (3.3)	10 (5.3)	12 (3.3)		
	FRN003G1S-4U	--	FRN003G1S-4U					
	FRN005G1S-4U	--	FRN005G1S-4U	10 (5.3)	10 (5.3)	10 (5.3)		
	FRN007G1■-4U	--	FRN007G1■-4U					
	--	--	FRN010G1■-4U	8 (8.4)	8 (8.4)	8 (8.4)		
	FRN010G1■-4U	--	FRN015G1■-4U					
	FRN015G1■-4U	--	--	6 (13.3)	8 (8.4)	6 (13.3)		
	--	--	FRN020G1■-4U					
	FRN020G1■-4U	--	--	6 (13.3)	6 (13.3)	6 (13.3)		
	--	--	FRN025G1■-4U					
	FRN025G1■-4U	--	FRN030G1■-4U	4 (21.2)	6 (13.3)	4 (21.2)		
	FRN030G1■-4U	--	FRN040G1■-4U					
	FRN040G1■-4U	--	--	3 (26.7)	2 (33.6)	2 (33.6)		
	--	--	FRN050G1■-4U					
	FRN050G1■-4U	--	FRN060G1■-4U	2 (33.6)	1/0 (53.5)	1/0 (53.5)		
	FRN060G1■-4U	--	FRN075G1■-4U					
	FRN075G1■-4U	--	FRN100G1■-4U	4 (21.2)	1/0 (53.5)	1/0 (53.5)		
	FRN100G1■-4U	--	--					
	--	--	FRN125G1S-4U	2/0 (67.4)	4/0 (107.2)	3/0 (85)		
	FRN125G1S-4U	--	FRN150G1S-4U					
	FRN150G1S-4U	FRN150G1S-4U	FRN200G1S-4U	1/0 (53.5)	3 (26.7)	1/0 (53.5)	4/0 (107.2)	
	FRN200G1S-4U	FRN200G1S-4U	FRN250G1S-4U	1/0 (53.5)		2 (33.6)	250 (127)	
	FRN250G1S-4U	FRN250G1S-4U	FRN300G1S-4U	3/0 (85) × 2	2 (33.6)	3/0 (85) × 2	350 (177)	
	FRN300G1S-4U	FRN300G1S-4U	FRN350G1S-4U	4/0 (107.2) × 2	1 (42.4)	250 (127) × 2	600 (304)	
	FRN350G1S-4U	FRN350G1S-4U	FRN450G1S-4U	250 (127) × 2	1/0 (53.5)	300 (152) × 2	4/0 (107.2) × 2	
	--	FRN450G1S-4U	--	300 (152) × 2		350 (177) × 2	250 (127) × 2	
	FRN450G1S-4U	--	--	400 (203) × 2	2/0 (67.4)	400 (203) × 2	300 (152) × 2	
	--	--	FRN500G1S-4U	250 (127) × 2		300 (152) × 2	350 (177) × 2	
--	FRN500G1S-4U	FRN600G1S-4U	300 (152) × 2	3/0 (85)	350 (177) × 2	350 (177) × 2		
FRN500G1S-4U	FRN600G1S-4U	FRN700G1S-4U	400 (203) × 2		400 (203) × 2	400 (203) × 2		
FRN600G1S-4U	FRN700G1S-4U	FRN800G1S-4U	500 (253) × 2	4/0 (107.2)	500 (253) × 2	500 (253) × 2		
FRN700G1S-4U	FRN800G1S-4U	--	600 (304) × 2		600 (304) × 2	300 (152) × 3		
FRN800G1S-4U	--	FRN900G1S-4U	350 (177) × 3	250 (127)	400 (203) × 3	400 (203) × 3		
FRN900G1S-4U	--	FRN1000G1S-4U	500 (253) × 3		600 (304) × 3	600 (304) × 3		
FRN1000G1S-4U	--	--	600 (304) × 3	350 (177)	500 (253) × 4	400 (203) × 4		

Note: A box (■) in the above table replaces S or H depending on the enclosure.

The wire sizes above are specified for 75°C (167°F) Cu wire.

Terminals common to all inverters	Recommended wire size AWG (mm ²)	Remarks
Auxiliary control power input terminals [R0] and [T0]	14 (2.1)	2 HP or above
Auxiliary fan power input terminals [R1] and [T1]		230 V series with 60 HP or above and 460 V series with 125 HP or above

(2) Arrangement of control circuit terminals (common to all inverter types)

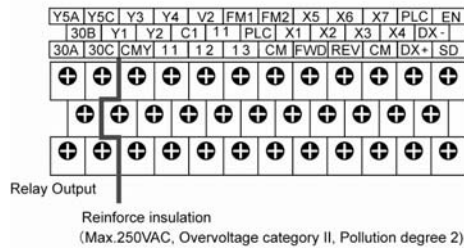

Screw size: M3, Tightening torque: 6.2 lb-in (0.7 N·m)

Recommended wire size: AWG 19 or 18 (0.7 to 0.8 mm²)*

* Using wires exceeding the recommended sizes may lift the front cover depending upon the number of wires used, impeding keypad's normal operation.

2.3.3 Wiring precautions

Follow the rules below when performing wiring for the inverter.

- (1) Make sure that the source voltage is within the rated voltage range specified on the nameplate.
- (2) Be sure to connect the three-phase power wires to the main circuit power input terminals L1/R, L2/S and L3/T of the inverter. If the power wires are connected to other terminals, the inverter will be damaged when the power is turned ON.
- (3) Always connect the grounding terminal to prevent electric shock, fire or other disasters and to reduce electric noise.
- (4) Use crimp terminals covered with insulated sleeves for the main circuit terminal wiring to ensure a reliable connection.
- (5) Keep the power supply wiring (primary circuit) and motor wiring (secondary circuit) of the main circuit, and control circuit wiring as far away as possible from each other.
- (6) After removing a screw from the main circuit terminal block, be sure to restore the screw even if no wire is connected.
- (7) Use the wiring guide to separate wiring. For inverters of 5 HP or below, the wiring guide separates the main circuit wires and the control circuit wires. For those of 7.5 to 40 HP, it separates the upper and lower main circuit wires, and control circuit wires. Be careful about the wiring order.

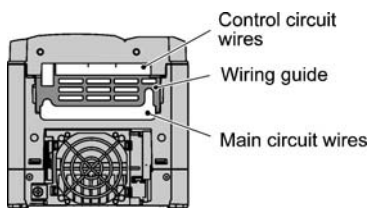

e.g. FRN005G1S-4U

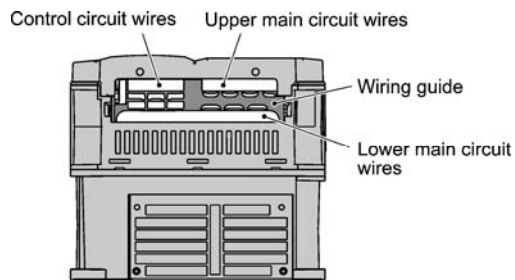

e.g. FRN020G1S-4U

■ Preparing for the wiring guide

Inverters of 20 to 40 HP (three-phase, 230 V series) are sometimes lacking in wiring space for main circuit wires depending upon the wire materials used. To assure a sufficient wiring space, remove the clip-off sections (see below) as required with a nipper. Note that the enclosure rating of IP20 may not be ensured when the wiring guide itself is removed to secure a space for thick main circuit wiring.

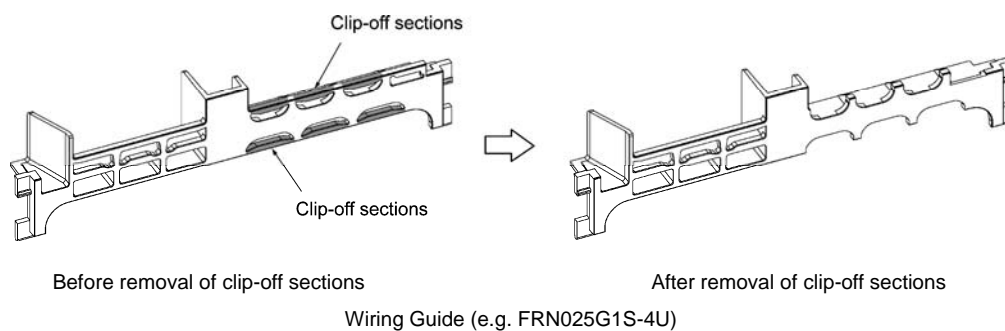

- (8) In some types of inverters, the wires from the main circuit terminal block cannot be routed straight into the terminal. Route such wires as shown below so that the front cover can be reinstalled.

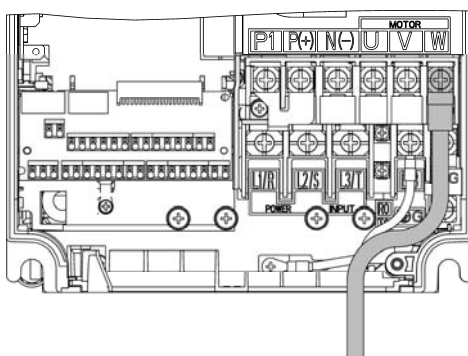

- (9) For inverters of 900 and 1000 HP, two L2/S input terminals are arranged vertically to the terminal block. When connecting wires to these terminals, use the bolts, washers and nuts that come with the inverter, as shown below.

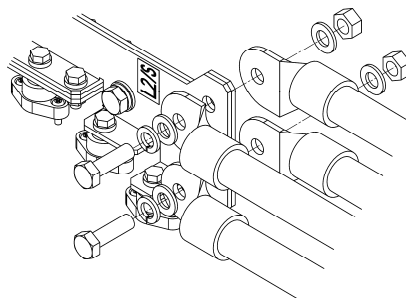

WARNING

- When wiring the inverter to the power source, insert a recommended molded case circuit breaker (MCCB) or residual-current-operated protective device (RCD)/earth leakage circuit breaker (ELCB) (with overcurrent protection) in the path of each pair of power lines to inverters. Use the recommended devices within the recommended current capacity.
- Be sure to use wires in the specified size.
- Tighten terminals with specified torque.

Otherwise, a fire could occur.

- When there is more than one combination of an inverter and motor, do not use a multiconductor cable for the purpose of running the leads together.
- Do not connect a surge killer to the inverter's output (secondary) circuit.

Doing so could cause a fire.

- Ground the inverter in compliance with the national or local electric code.
- Be sure to ground the inverter's grounding terminals .

Otherwise, an electric shock or fire could occur.

- Qualified electricians should carry out wiring.
- Be sure to perform wiring after turning the power OFF.

Otherwise, electric shock could occur.

- Be sure to perform wiring after installing the inverter unit.

Otherwise, electric shock or injuries could occur.

- Ensure that the number of input phases and the rated voltage of the product match the number of phases and the voltage of the AC power supply to which the product is to be connected.

Otherwise, a fire or an accident could occur.

- Do not connect the power source wires to inverter output terminals (U, V, and W).

Doing so could cause fire or an accident.

2.3.4 Wiring of main circuit terminals and grounding terminals

This section shows connection diagrams with the Enable input function used.

SINK mode input by factory default

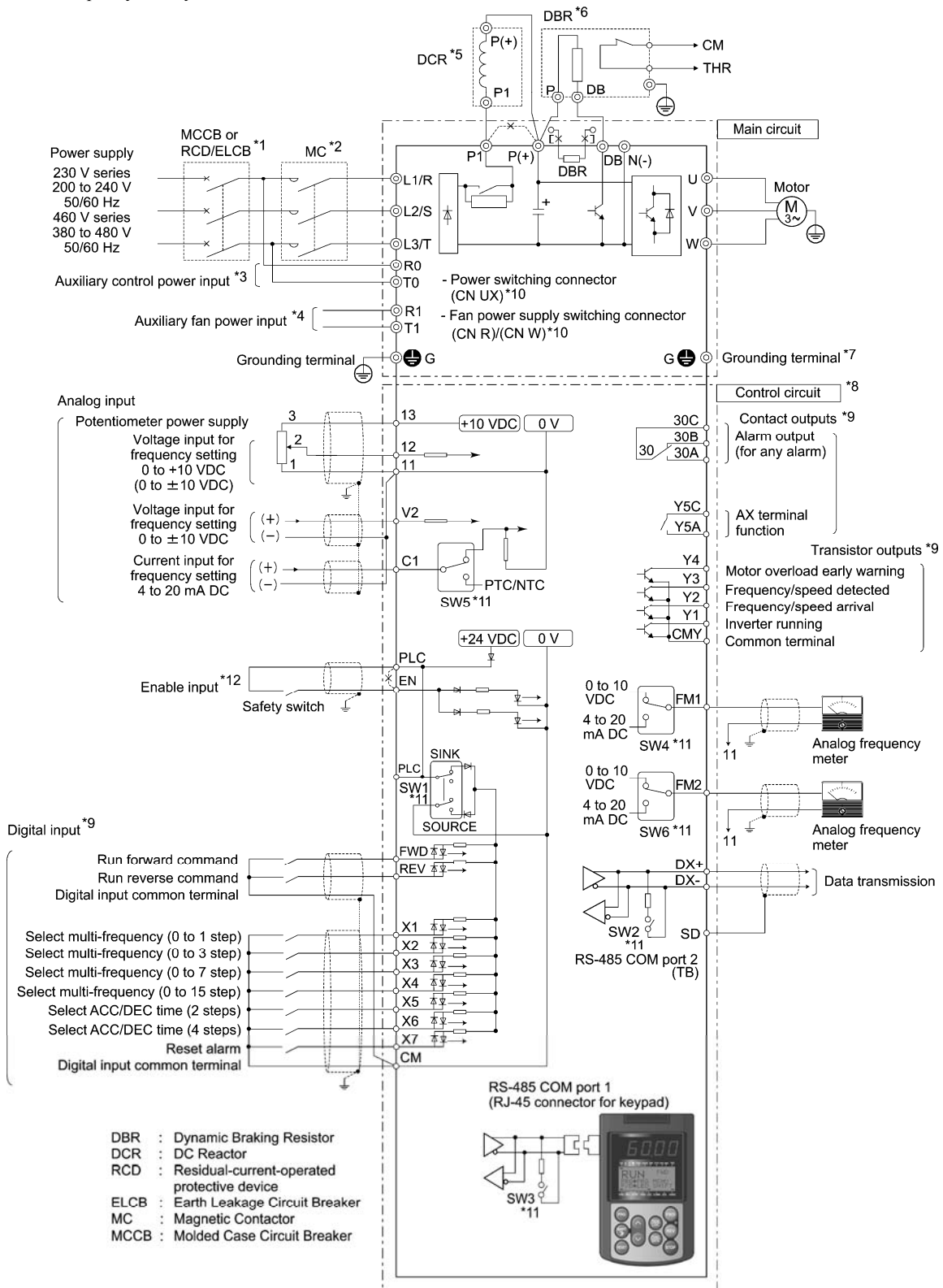

- *1 Install a recommended molded case circuit breaker (MCCB) or residual-current-operated protective device (RCD)/earth leakage circuit breaker (ELCB) (with overcurrent protection function) in the primary circuit of the inverter to protect wiring. Ensure that the circuit breaker capacity is equivalent to or lower than the recommended capacity.
- *2 Install a magnetic contactor (MC) for each inverter to separate the inverter from the power supply, apart from the MCCB or RCD/ELCB, when necessary.
Connect a surge absorber in parallel when installing a coil such as the MC or solenoid near the inverter.
- *3 The R0 and T0 terminals are provided for inverters of 2 HP or above.
To retain an alarm output signal *ALM* issued on inverter's programmable output terminals by the protective function or to keep the keypad alive even if the main power has shut down, connect these terminals to the power supply lines. Without power supply to these terminals, the inverter can run.
- *4 Normally no need to be connected. Use these terminals when the inverter is equipped with a high power-factor, regenerative PWM converter (RHC series).
- *5 When connecting an optional DC reactor (DCR), remove the jumper bar from the terminals P1 and P(+).
The FRN100G1S-2/4U and higher types come with a DCR. Be sure to connect the DCR.
Use a DCR when the capacity of the power supply transformer exceeds 500 kVA and is 10 times or more the inverter rated capacity, or when there are thyristor-driven loads in the same power supply line.
The DCR built-in type has no DCR at this location.
- *6 Inverters of 15 HP or below have a built-in braking resistor (DBR) between the terminals P(+) and DB.
When connecting an external braking resistor (DBR), be sure to disconnect the built-in one.
- *7 A grounding terminal for a motor. Use this terminal if needed.
- *8 For control signal wires, use twisted or shielded-twisted wires. When using shielded-twisted wires, connect the shield of them to the common terminals of the control circuit. To prevent malfunction due to noise, keep the control circuit wiring away from the main circuit wiring as far as possible (recommended: 3.9 inches (10 cm) or more). Never install them in the same wire duct. When crossing the control circuit wiring with the main circuit wiring, set them at right angles.
- *9 The connection diagram shows factory default functions assigned to digital input terminals [X1] to [X7], [FWD] and [REV], transistor output terminals [Y1] to [Y4], and relay contact output terminals [Y5A/C] and [30A/B/C].
- *10 Switching connectors in the main circuits. For details, refer to "⑥ Switching connectors" later in this section.
- *11 Slide switches on the control printed circuit board (control PCB). Use these switches to customize the inverter operations. For details, refer to Section 2.3.6 "Setting up the slide switches."
- *12 When using the Enable input function, be sure to remove the jumper wire from terminals [EN] and [PLC]. For opening and closing the hardware circuit between terminals [EN] and [PLC], use safety components such as safety relays and safety switches that comply with EN954-1, Category 3 or higher. Be sure to use shielded wires exclusive to terminals [EN] and [PLC]. (Do not put them together with any other control signal wire in the same shielded core.) Ground the shielding layer. For details, refer to Chapter 9, Section 9.4 "Compliance with EN954-1, Category 3."
When not using the Enable input function, keep the terminals between [EN] and [PLC] short-circuited with the jumper wire (factory default).

① Primary grounding terminal (⚡G) for inverter enclosure

Two grounding terminals (⚡G) are not exclusive to the power supply wiring (primary circuit) or motor wiring (secondary circuit). Be sure to ground either of the two grounding terminals for safety and noise reduction. The inverter is designed for use with safety grounding to avoid electric shock, fire and other disasters.

The grounding terminal for inverter enclosure should be grounded as follows:

- 1) Ground the inverter in compliance with the national or local electric code.
- 2) Use a thick grounding wire with a large surface area and keep the wiring length as short as possible.

② Inverter output terminals U, V, and W and secondary grounding terminals (⚡G) for motor

Inverter's output terminals should be connected as follows:

- 1) Connect the three wires of the 3-phase motor to terminals U, V, and W, aligning the phases each other.
- 2) Connect the secondary grounding wire to the grounding terminal (⚡G).

Note When there is more than one combination of an inverter and motor, do not use a multiconductor cable for the purpose of running the leads together.

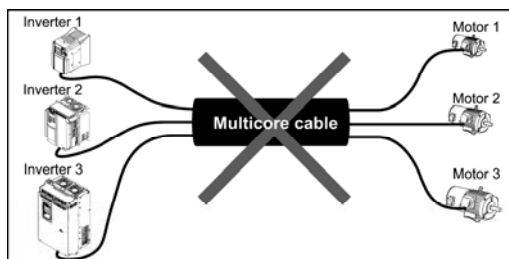

③ DC reactor terminals P1 and P(+)

Connect a DC reactor (DCR) to these terminals for power factor correction.

- 1) Remove the jumper bar from terminals P1 and P(+).
- 2) Connect an optional DCR to those terminals.

- Note**
- The wiring length should be 33 ft (10 m) or below.
 - Do not remove the jumper bar when a DCR is not used.
 - The FRN100G1S-2/4U and higher types come with a DCR. Be sure to connect the DCR.
 - If a PWM converter is connected to the inverter, no DCR is required.

⚠ WARNING
Be sure to connect an optional DC reactor (DCR) when the capacity of the power supply transformer exceeds 500 kVA and is 10 times or more the inverter rated capacity.
Otherwise, a fire could occur.

④ DC braking resistor terminals P(+) and DB (for inverters of 40 HP or below)

Capacity (HP)	Braking transistor	Built-in DC braking resistor (DBR)	Optional devices	Option mounting steps required
0.5 to 15	Built-in	Built-in	External DC braking resistor (with a larger capacity)	1), 2), 3)
20 to 40	Built-in	None	External DC braking resistor	2), 3)

For inverters of 15 HP or below, if the capacity of the built-in DC braking resistor (DBR) is insufficient since the inverter undergoes frequent start/stop or heavy inertial load, mount an optional external DC braking resistor (DBR) with a larger capacity to increase the braking capability, using the following steps. Before mounting the external DBR, remove the built-in DBR.

- 1) For inverters of 0.5 to 5 HP, disconnect the wiring of the built-in DBR from terminals P(+) and DB; for those of 7.5 to 15 HP, disconnect the wiring from terminal DB and the internal relay terminal (see the figure below). Insulate the terminals of the disconnected wires with insulating tape or other materials.

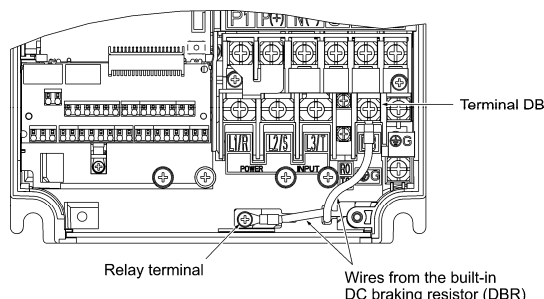

- 2) Connect an optional DBR to terminals P(+) and DB.
The internal relay terminal on inverters of 7.5 to 15 HP is left unused.
- 3) Arrange the DBR and inverter so that the wiring length comes to 16 ft (5 m) or less and twist the two DBR wires or route them together in parallel.

⚠ WARNING
When connecting a DC braking resistor (DBR), never connect it to terminals other than terminals P(+) and DB.
Otherwise, a fire could occur.

⑤ DC link bus terminals P(+) and N(-)

Capacity (HP)	Braking transistor	Built-in DC braking resistor (DBR)	Optional devices	Devices and terminals
50 to 1000	None	None	Braking unit	Inverter—Braking unit: P(+) and N(-)
			DC braking resistor (DBR)	Braking unit—DBR: P(+) and DB

1) Connecting an optional braking unit or DC braking resistor (DBR)

Inverters of 50 HP or above require both a braking unit and DBR.

Connect the terminals P(+) and N(-) of a braking unit to those on the inverter. Arrange the inverter and the braking unit so that the wiring length comes to 16 ft (5 m) or less and twist the two wires or route them together in parallel.

Next, connect the terminals P(+) and DB of a DBR to those on the braking unit. Arrange the braking unit and DBR so that the wiring length comes to 33 ft (10 m) or less and twist the two wires or route them together in parallel.

For details about the wiring, refer to the Braking Unit Instruction Manual.

2) Connecting other external devices

A DC link bus of other inverter(s) or a PWM converter is connectable to these terminals.

Note When you need to use the DC link bus terminals P(+) and N(-), consult your Fuji Electric representative.

⑥ Switching connectors

■ Power switching connectors (CN UX) (on inverters of 125 HP or above for 460 V)

Inverters of 125 HP or above for 460 V are equipped with a set of switching connectors (male) which should be configured according to the power source voltage and frequency. By factory default, a jumper (female connector) is set to U1. If the power supply to the main power inputs (L1/R, L2/S, L3/T) or the auxiliary fan power input terminals (R1, T1) matches the conditions listed below, change the jumper to U2.

For the switching instructions, see Figures 2.6 and 2.7.

(a) FRN125G1S-4U to FRN200G1S-4U

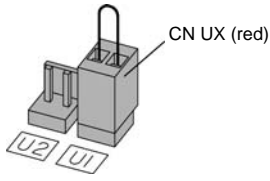
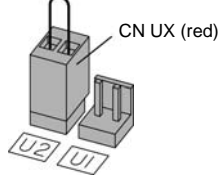
Connector configuration		
Power source voltage	398 to 440 V/50 Hz, 430 to 480 V/60 Hz (Factory default)	380 to 398 V/50 Hz 380 to 430 V/60 Hz

(b) FRN250G1S-4U to FRN1000G1S-4U

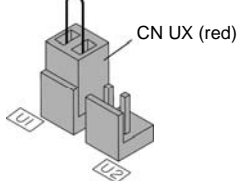
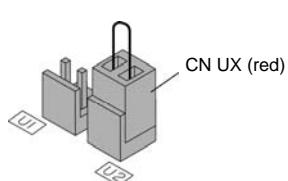
Connector configuration		
Power source voltage	398 to 440 V/50 Hz, 430 to 480 V/60 Hz (Factory default)	380 to 398 V/50 Hz, 380 to 430 V/60 Hz

Note The allowable power input voltage fluctuation is within -15% to +10% of the power source voltage.

■ Fan power supply switching connectors (CN R and CN W) (on inverters of 60 HP or above for 230 V and those of 125 HP or above for 460 V)

The standard FRENIC-MEGA series accepts DC-linked power input in combination with a PWM converter. Inverters of 60 HP or above for 230 V and those of 125 HP or above for 460 V, however, contain AC-driven components such as AC fans. To supply AC power to those components, exchange the CN R and CN W connectors as shown below and connect the AC power line to the auxiliary fan power input terminals (R1, T1).

For the switching instructions, see Figures 2.6 and 2.7.

(a) FRN060G1■-2U to FRN125G1S-2U, FRN125G1S-4U to FRN200G1S-4U

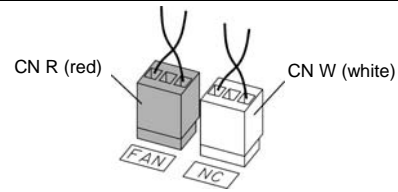
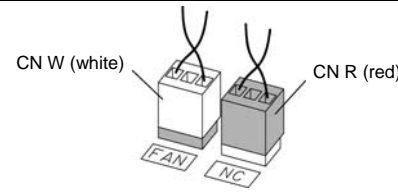
Connector configuration		
Use conditions	When not using terminal R1 or T1 (Factory default)	When using terminals R1 and T1 <ul style="list-style-type: none"> • Feeding the DC-linked power • Combined with a PWM converter

b) FRN150G1S-2U, FRN250G1S-4U to FRN1000G1S-4U

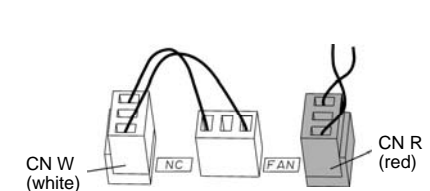
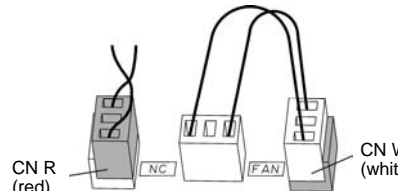
Connector configuration		
Use conditions	When not using terminal R1 or T1 (Factory default)	When using terminals R1 and T1 <ul style="list-style-type: none"> • Feeding the DC-linked power • Combined with a PWM converter

Note: A box (■) in the above figure replaces S or H depending on the enclosure.

Note By factory default, the fan power supply switching connectors CN R and CN W are set on the **FAN** and **NC** positions, respectively. Do not exchange them unless you drive the inverter with a DC-linked power supply. Wrong configuration of these switching connectors cannot drive the cooling fans, causing a heat sink overheat alarm CH or a charger circuit alarm PbF .

■ Location of the switching connectors

The switching connectors are located on the power printed circuit board (power PCB) as shown below.

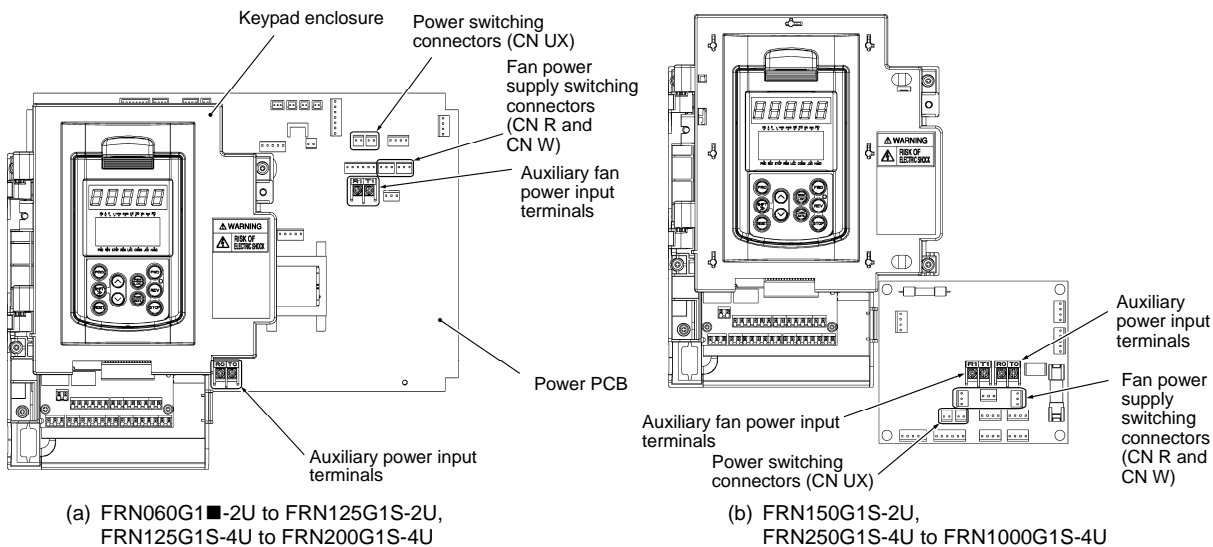

Figure 2.6 Location of Switching Connectors and Auxiliary Power Input Terminals

Note: A box (■) in the above figure replaces S or H depending on the enclosure.

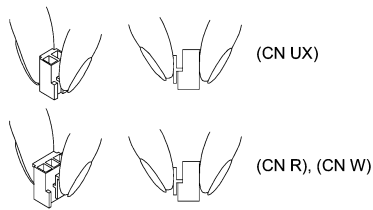

Figure 2.7 Inserting/Removing the Jumpers

Note To remove each of the jumpers, pinch its upper side between your fingers, unlock its fastener, and pull it up.
When mounting it, fit the jumper over the connector until it snaps into place.

⑦ Main circuit power input terminals L1/R, L2/S, and L3/T (three-phase input)

The three-phase input power lines are connected to these terminals.

- 1) For safety, make sure that the molded case circuit breaker (MCCB) or magnetic contactor (MC) is turned OFF before wiring the main circuit power input terminals.
- 2) Connect the main circuit power supply wires (L1/R, L2/S and L3/T) to the input terminals of the inverter via an MCCB or residual-current-operated protective device (RCD)/earth leakage circuit breaker (ELCB)*, and an MC if necessary.

It is not necessary to align phases of the power supply wires and the input terminals of the inverter with each other.

* With overcurrent protection

Tip It is recommended to insert a manually operable magnetic contactor (MC) that allows you to disconnect the inverter from the power supply in an emergency (e.g., when the protective function is activated), preventing a failure or accident from causing secondary disasters.

⑧ Auxiliary control power input terminals R0 and T0 (on inverters of 2 HP or above)

In general, the inverter runs normally without power supplied to the auxiliary control power input terminals R0 and T0. If the inverter main power is shut down, however, no power is supplied to the control circuit so that the inverter cannot issue a variety of output signals or display on the keypad.

To retain an alarm output signal *ALM* issued on inverter's programmable output terminals by the protective function or to keep the keypad alive even if the main power has shut down, connect the auxiliary control power input terminals R0 and T0 to the power supply lines. If a magnetic contactor (MC) is installed in the inverter's primary circuit, connect the primary circuit of the MC to these terminals R0 and T0.

Terminal rating:

200 to 240 VAC, 50/60 Hz, Maximum current 1.0 A (230 V series with 40 HP or below)

200 to 230 VAC, 50/60 Hz, Maximum current 1.0 A (230 V series with 50 HP or above)

380 to 480 VAC, 50/60 Hz, Maximum current 0.5 A (460 V series)

Note When introducing a residual-current-operated protective device (RCD)/earth leakage circuit breaker (ELCB), connect its output (secondary) side to terminals R0 and T0. Connecting its input (primary) side to those terminals causes the RCD/ELCB to malfunction since the input power voltage to the inverter is three-phase but the one to terminals R0 and T0 is single-phase. To avoid such problems, be sure to insert an isolation transformer or auxiliary B contacts of a magnetic contactor in the location shown in Figure 2.8.

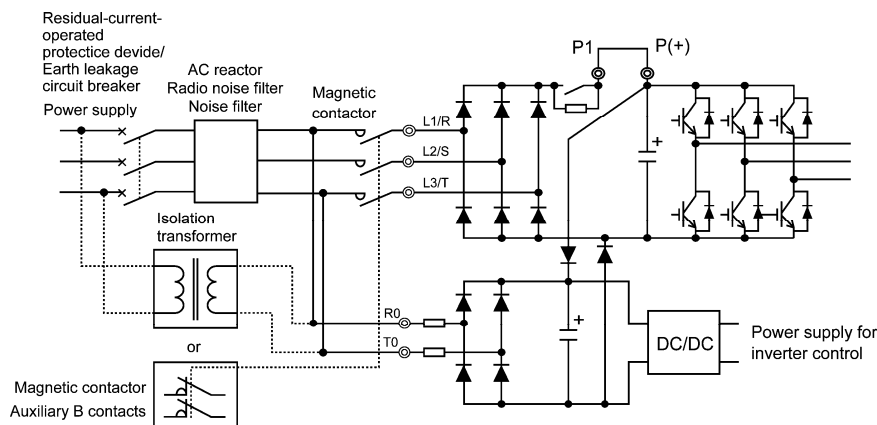

Figure 2.8 Connection Example of Residual-current-operated Protective Device (RCD)/Earth Leakage Circuit Breaker (ELCB)



When connecting a PWM converter with an inverter, do not connect the power supply line directly to terminals R0 and T0. If a PWM is to be connected, insert an isolation transformer or auxiliary B contacts of a magnetic contactor at the power supply side.

For connection examples at the PWM converter side, refer to the PWM Converter Instruction Manual.

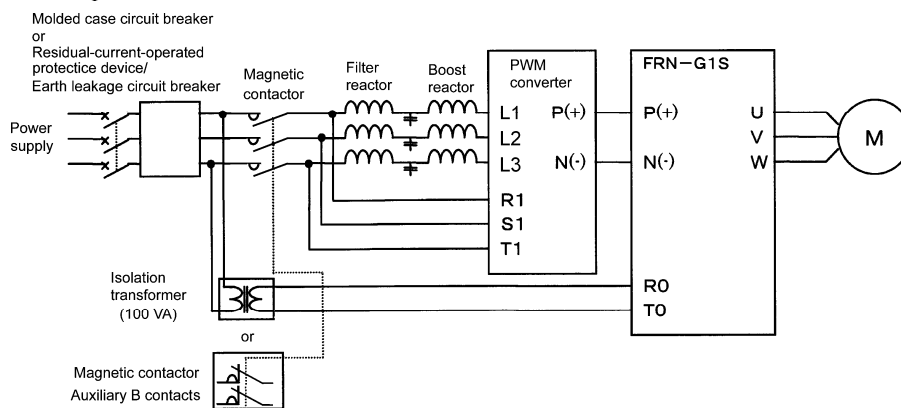

Figure 2.9 Connection Example of PWM Converter

⑨ Auxiliary fan power input terminals R1 and T1

Inverters of 60 HP or above for 230 V and those of 125 HP or above for 460 V are equipped with terminals R1 and T1. Only if the inverter works with the DC-linked power input whose source is a PWM converter, these terminals are used to feed AC power to the fans, while they are not used in any power system of ordinary configuration.

In this case, set up the fan power supply switching connectors (CN R and CN W).

Terminal rating:

200 to 220 VAC/50 Hz, 200 to 230 VAC/60 Hz, Maximum current 1.0 A (230 V series with 60 HP or above)

380 to 440 VAC/50 Hz, 380 to 480 VAC/60 Hz, Maximum current 1.0 A (460 V series with 125 to 800 HP)

380 to 440 VAC/50 Hz, 380 to 480 VAC/60 Hz, Maximum current 2.0 A (460 V series with 900 and 1000 HP)

2.3.5 Wiring for control circuit terminals

⚠ WARNING

In general, the insulation of the control signal wires are not specifically designed to withstand a high voltage (i.e., reinforced insulation is not applied). Therefore, if a control signal wire comes into direct contact with a live conductor of the main circuit, the insulation may break down, which would expose the signal wire to the high voltage of the main circuit. Make sure that the control signal wires will not come into contact with live conductors of the main circuit.

Failure to observe these precautions could cause electric shock or an accident.

⚠ CAUTION

Noise may be emitted from the inverter, motor and wires.

Take appropriate measures to prevent the nearby sensors and devices from malfunctioning due to such noise.

An accident could occur.

■ Connecting/disconnecting wires to/from a control circuit terminal

- ① Strip the wire end by 0.31 to 0.39 inch (8 to 10 mm) as shown below.

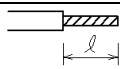
Strip length of wire end	0.31 to 0.39 inch 8 to 10 mm	
Type of screwdriver (tip shape)	Flat (0.024 × 0.14 inch (0.6 × 3.5 mm))	



For strand wires, the strip length specified above should apply after twisting of them.

If the strip length is out of the specified range, the wire may not be firmly clamped or may be short-circuited with other wires.

- ② Twist the end of the stripped wires for easy insertion and insert it firmly into the wire inlet on the control circuit terminal. If the insertion is difficult, hold down the clamp release button on the terminal with a flat screwdriver.
- ③ When disconnecting the wires from the terminal, hold down the clamp release button on the terminal with a flat screwdriver and pull out the wires.

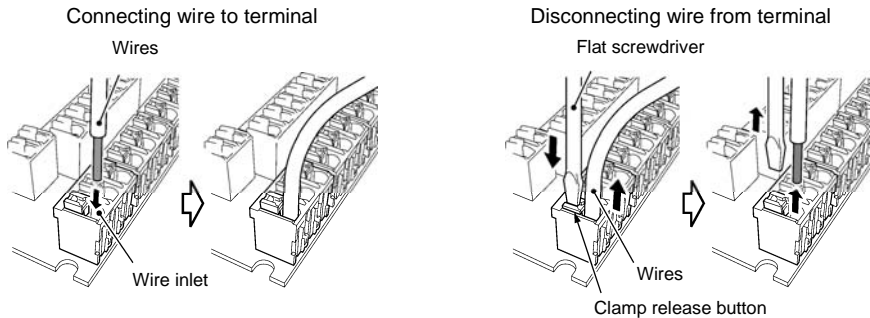

Table 2.7 lists the symbols, names and functions of the control circuit terminals. The wiring to the control circuit terminals differs depending upon the setting of the function codes, which reflects the use of the inverter. Route wires properly to reduce the influence of noise.

Table 2.7 Symbols, Names and Functions of the Control Circuit Terminals

Classification	Symbol	Name	Functions
Analog input	[13]	Power supply for the potentiometer	Power supply (+10 VDC) for an external frequency command potentiometer (Variable resistor: 1 to 5kΩ) The potentiometer of 1/2 W rating or more should be connected.
	[12]	Analog setting voltage input	(1) The frequency is commanded according to the external voltage input. <ul style="list-style-type: none"> • 0 to ±10 VDC/0 to ±100% (Normal operation) • +10 to 0 VDC/0 to 100% (Inverse operation) (2) In addition to frequency setting, PID command, PID feedback signal, auxiliary frequency command setting, ratio setting, torque limiter level setting, or analog input monitor can be assigned to this terminal. (3) Hardware specifications <ul style="list-style-type: none"> • Input impedance: 22kΩ • The maximum input is ±15 VDC, however, the voltage higher than ±10 VDC is handled as ±10 VDC. • Inputting a bipolar analog voltage (0 to ±10 VDC) to terminal [12] requires setting function code C35 to "0."
	[C1]	Analog setting current input	(1) The frequency is commanded according to the external current input. <ul style="list-style-type: none"> • 4 to 20 mA DC/0 to 100% (Normal operation) • 20 to 4 mA DC/0 to 100 % (Inverse operation) (2) In addition to frequency setting, PID command, PID feedback signal, auxiliary frequency command setting, ratio setting, torque limiter level setting, or analog input monitor can be assigned to this terminal. (3) Hardware specifications <ul style="list-style-type: none"> • Input impedance: 250Ω • The maximum input is +30 mA DC, however, the current larger than +20 mA DC is handled as +20 mA DC.
		PTC/NTC thermistor input	(1) Connects PTC (Positive Temperature Coefficient)/NTC (Negative Temperature Coefficient) thermistor for motor protection. Ensure that the slide switch SW5 on the control PCB is turned to the PTC/NTC position (see Section 2.3.6 "Setting up the slide switches"). The figure shown at the right illustrates the internal circuit diagram where SW5 (switching the input of terminal [C1] between C1 and PTC/NTC) is turned to the PTC/NTC position. For details on SW5, refer to Section 2.3.6 "Setting up the slide switches." In this case, you must change data of the function code H26.
			 <p>Figure 2.10 Internal Circuit Diagram (SW5 Selecting PTC/NTC)</p>
	[V2]	Analog setting voltage input	(1) The frequency is commanded according to the external voltage input. <ul style="list-style-type: none"> • 0 to ±10 VDC/0 to ±100 % (Normal operation) • +10 to 0 VDC/0 to 100% (Inverse operation) (2) In addition to frequency setting, PID command, PID feedback signal, auxiliary frequency command setting, ratio setting, torque limiter level setting, or analog input monitor can be assigned to this terminal. (3) Hardware specifications <ul style="list-style-type: none"> • Input impedance: 22kΩ • The maximum input is ±15 VDC, however, the voltage higher than ±10 VDC is handled as ±10 VDC. • Inputting a bipolar analog voltage (0 to ±10 VDC) to terminal [V2] requires setting function code C45 to "0."
	[11]	Analog common	Common for analog input/output signals ([13], [12], [C1], [V2], [FM1] and [FM2]). Isolated from terminals [CM] and [CMY].

Table 2.7 Symbols, Names and Functions of the Control Circuit Terminals (Continued)

Classification	Symbol	Name	Functions																														
	<p>Note</p>		<ul style="list-style-type: none"> - Since low level analog signals are handled, these signals are especially susceptible to the external noise effects. Route the wiring as short as possible (within 66 ft (20 m)) and use shielded wires. In principle, ground the shielded sheath of wires; if effects of external inductive noises are considerable, connection to terminal [11] may be effective. As shown in Figure 2.11, be sure to ground the single end of the shield to enhance the shield effect. - Use a twin-contact relay for low level signals if the relay is used in the control circuit. Do not connect the relay's contact to terminal [11]. - When the inverter is connected to an external device outputting the analog signal, the external device may malfunction due to electric noise generated by the inverter. If this happens, according to the circumstances, connect a ferrite core (a toroidal core or equivalent) to the device outputting the analog signal or connect a capacitor having the good cut-off characteristics for high frequency between control signal wires as shown in Figure 2.12. - Do not apply a voltage of +7.5 VDC or higher to terminal [C1]. Doing so could damage the internal control circuit. <div style="display: flex; justify-content: space-around;"> <div data-bbox="288 763 738 969"> </div> <div data-bbox="831 763 1350 1010"> </div> </div>																														
Digital input	[X1]	Digital input 1	<p>(1) Various signals such as "Coast to a stop," "Enable external alarm trip," and "Select multi-frequency" can be assigned to terminals [X1] to [X7], [FWD] and [REV] by setting function codes E01 to E07, E98, and E99. For details, refer to Chapter 5, Section 5.2 "Details of Function Codes."</p> <p>(2) Input mode, i.e. SINK/SOURCE, is changeable by using the slide switch SW1. (Refer to Section 2.3.6, "Setting up the slide switches.") The factory default is SINK.</p> <p>(3) Switches the logic value (1/0) for ON/OFF of the terminals [X1] to [X7], [FWD], or [REV]. If the logic value for ON of the terminal [X1] is 1 in the normal logic system, for example, OFF is 1 in the negative logic system and vice versa.</p> <p>(4) Digital input terminal [X7] can be defined as a pulse train input terminal with the function codes.</p> <p>Maximum wiring length 66 ft (20 m) Maximum input pulse 30 kHz: When connected to a pulse generator with open collector transistor output (Needs a pull-up or pull-down resistor. See notes on page 2-22.) 100 kHz: When connected to a pulse generator with complementary transistor output</p> <p>For the settings of the function codes, refer to FRENIC-MEGA User's Manual, Chapter 5 "FUNCTION CODES."</p> <p>(Digital input circuit specifications)</p> <div style="display: flex; justify-content: space-between;"> <div data-bbox="523 1653 906 2000"> </div> <div data-bbox="938 1697 1369 2000"> <table border="1"> <thead> <tr> <th>Item</th> <th></th> <th>Min.</th> <th>Max.</th> </tr> </thead> <tbody> <tr> <td rowspan="2">Operating voltage (SINK)</td> <td>ON level</td> <td>0 V</td> <td>2 V</td> </tr> <tr> <td>OFF level</td> <td>22 V</td> <td>27 V</td> </tr> <tr> <td rowspan="2">Operating voltage (SOURCE)</td> <td>ON level</td> <td>22 V</td> <td>27 V</td> </tr> <tr> <td>OFF level</td> <td>0 V</td> <td>2 V</td> </tr> <tr> <td colspan="2">Operating current at ON (Input voltage is at 0 V) (For [X7])</td> <td>2.5 mA</td> <td>5 mA</td> </tr> <tr> <td colspan="2"></td> <td>(9.7 mA)</td> <td>(16 mA)</td> </tr> <tr> <td colspan="2">Allowable leakage current at OFF</td> <td>-</td> <td>0.5 mA</td> </tr> </tbody> </table> </div> </div>	Item		Min.	Max.	Operating voltage (SINK)	ON level	0 V	2 V	OFF level	22 V	27 V	Operating voltage (SOURCE)	ON level	22 V	27 V	OFF level	0 V	2 V	Operating current at ON (Input voltage is at 0 V) (For [X7])		2.5 mA	5 mA			(9.7 mA)	(16 mA)	Allowable leakage current at OFF		-	0.5 mA
	Item			Min.	Max.																												
	Operating voltage (SINK)	ON level		0 V	2 V																												
		OFF level		22 V	27 V																												
	Operating voltage (SOURCE)	ON level		22 V	27 V																												
		OFF level		0 V	2 V																												
	Operating current at ON (Input voltage is at 0 V) (For [X7])			2.5 mA	5 mA																												
				(9.7 mA)	(16 mA)																												
Allowable leakage current at OFF		-	0.5 mA																														
[X2]	Digital input 2																																
[X3]	Digital input 3																																
[X4]	Digital input 4																																
[X5]	Digital input 5																																
[X6]	Digital input 6																																
[X7]	Digital input 7																																
[FWD]	Run forward command																																
[REV]	Run reverse command																																

Table 2.7 Symbols, Names and Functions of the Control Circuit Terminals (Continued)

Classification	Symbol	Name	Functions																			
Digital input	[EN]	Enable input	<p>(1) This terminal has the Safe Torque Off (STO) function that is compliant with EN954-1, Category 3. It allows the hardware circuit to stop the inverter's output transistors and coast the motor to a stop.</p> <p>(2) This terminal is exclusively used for the source mode input. When it is short-circuited with terminal [PLC], the Enable input is ON (ready for inverter run); when it is opened, the inverter coasts the motor to a stop. (This terminal is not interlocked with the slide switch SW1.)</p> <p>(3) By factory default, terminals [EN] and [PLC] are short-circuited with each other using a jumper wire, disabling this function. To enable it, be sure to remove the jumper wire.</p> <p>For details of connection to this terminal and precautions, refer to Chapter 9, Section 9.4 "Compliance with EN954-1, Category 3."</p> <p><Terminal [EN] circuit specification></p>  <table border="1" data-bbox="869 761 1316 963"> <thead> <tr> <th colspan="2">Item</th> <th>Min.</th> <th>Max.</th> </tr> </thead> <tbody> <tr> <td rowspan="2">Operating voltage (SOURCE)</td> <td>ON level</td> <td>22 V</td> <td>27 V</td> </tr> <tr> <td>OFF level</td> <td>0 V</td> <td>2 V</td> </tr> <tr> <td colspan="2">Operating current at ON (Input voltage is at 24 V)</td> <td>5 mA</td> <td>10 mA</td> </tr> <tr> <td colspan="2">Allowable leakage current at OFF</td> <td>–</td> <td>0.5 mA</td> </tr> </tbody> </table>	Item		Min.	Max.	Operating voltage (SOURCE)	ON level	22 V	27 V	OFF level	0 V	2 V	Operating current at ON (Input voltage is at 24 V)		5 mA	10 mA	Allowable leakage current at OFF		–	0.5 mA
	Item		Min.	Max.																		
	Operating voltage (SOURCE)	ON level	22 V	27 V																		
OFF level		0 V	2 V																			
Operating current at ON (Input voltage is at 24 V)		5 mA	10 mA																			
Allowable leakage current at OFF		–	0.5 mA																			
[PLC]	PLC signal power	<p>(1) Connects to PLC output signal power supply. Rated voltage: +24 VDC (Allowable range: +22 to +27 VDC), Maximum 100 mA DC</p> <p>(2) This terminal also supplies a power to the load connected to the transistor output terminals. Refer to "Transistor output" described later in this table for more.</p>																				
[CM]	Digital input common	Two common terminals for digital input signals These terminals are electrically isolated from the terminals [11]s and [CMY].																				
<p>Tip ■ Using a relay contact to turn [X1] to [X7], [FWD], or [REV] ON or OFF</p> <p>Figure 2.14 shows two examples of a circuit that uses a relay contact to turn control signal input [X1] to [X7], [FWD], or [REV] ON or OFF. In circuit (a), the slide switch SW1 is turned to SINK, whereas in circuit (b) it is turned to SOURCE.</p> <p>Note: To configure this kind of circuit, use a highly reliable relay.</p>			 																			
<p>Tip ■ Using a programmable logic controller (PLC) to turn [X1] to [X7], [FWD], or [REV] ON or OFF</p> <p>Figure 2.15 shows two examples of a circuit that uses a programmable logic controller (PLC) to turn control signal input [X1] to [X7], [FWD], or [REV] ON or OFF. In circuit (a), the slide switch SW1 is turned to SINK, whereas in circuit (b) it is turned to SOURCE.</p> <p>In circuit (a) below, short-circuiting or opening the transistor's open collector circuit in the PLC using an external power supply turns ON or OFF control signal [X1] to [X7], [FWD], or [REV]. When using this type of circuit, observe the following:</p> <ul style="list-style-type: none"> - Connect the + node of the external power supply (which should be isolated from the PLC's power) to terminal [PLC] of the inverter. - Do not connect terminal [CM] of the inverter to the common terminal of the PLC. 																						

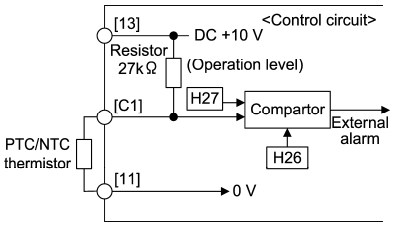
Table 2.7 Symbols, Names and Functions of the Control Circuit Terminals (Continued)

Classification	Symbol	Name	Functions																							
Digital input																										
																										
	(a) With the switch turned to SINK	(b) With the switch turned to SOURCE																								
	Figure 2.15 Circuit Configuration Using a PLC																									
	<p>For details about the slide switch setting, refer to Section 2.3.6 "Setting up the slide switches."</p> <p>Note ■ For inputting a pulse train through the digital input terminal [X7]</p> <ul style="list-style-type: none"> Inputting from a pulse generator with an open collector transistor output <p>Stray capacity on the wiring between the pulse generator and the inverter may disable transmission of the pulse train. As a countermeasure against this problem, insert a pull-up resistor between the open collector output signal (terminal [X7]) and the power source terminal (terminal [PLC]) if the switch selects the SINK mode input; insert a pull-down resistor between the output signal and the digital common terminal (terminal [CM]) if the switch selects the SOURCE mode input.</p> <p>A recommended pull-up/down resistor is 1kΩ 2 W. Check if the pulse train is correctly transmitted because stray capacity is significantly affected by the wire types and wiring conditions.</p>																									
Analog output	[FM1] [FM2]	Analog monitor	<p>Both terminals output monitor signals for analog DC voltage (0 to +10 V) or analog DC current (+4 to +20 mA). The output form (VO/IO) for each of [FM1] and [FM2] can be switched with the slide switches on the control PCB and the function codes, as listed below.</p> <table border="1" data-bbox="507 1146 1337 1335"> <thead> <tr> <th rowspan="2">Terminal</th> <th rowspan="2">Terminal function is specified by:</th> <th colspan="2">Output form</th> <th rowspan="2">Content is specified by:</th> </tr> <tr> <th>Analog DC voltage</th> <th>Analog DC current</th> </tr> </thead> <tbody> <tr> <td rowspan="2">[FM1]</td> <td>Slide switch SW4</td> <td>VO1</td> <td>IO1</td> <td rowspan="2">Function code F31</td> </tr> <tr> <td>Function code F29</td> <td>0</td> <td>1</td> </tr> <tr> <td rowspan="2">[FM2]</td> <td>Slide switch SW6</td> <td>VO2</td> <td>IO2</td> <td rowspan="2">Function code F35</td> </tr> <tr> <td>Function code F32</td> <td>0</td> <td>1</td> </tr> </tbody> </table> <p>The signal content can be selected from the following with function codes F31 and F35.</p> <ul style="list-style-type: none"> Output frequency Output torque PID feedback amount Universal AO PID command Output current Load factor Speed (PG feedback value) Motor output PID output, etc. Output voltage Input power DC link bus voltage Calibration <p>* Input impedance of the external device: Min. 5kΩ (at 0 to 10 VDC output) (While the terminal is outputting 0 to 10 VDC, it is capable of driving up to two analog voltmeters with 10 kΩ impedance.)</p> <p>* Input impedance of the external device: Max. 500Ω (at 4 to 20 mA DC output)</p> <p>* Adjustable range of the gain: 0 to 300%</p>	Terminal	Terminal function is specified by:	Output form		Content is specified by:	Analog DC voltage	Analog DC current	[FM1]	Slide switch SW4	VO1	IO1	Function code F31	Function code F29	0	1	[FM2]	Slide switch SW6	VO2	IO2	Function code F35	Function code F32	0	1
	Terminal	Terminal function is specified by:	Output form			Content is specified by:																				
Analog DC voltage			Analog DC current																							
[FM1]	Slide switch SW4	VO1	IO1	Function code F31																						
	Function code F29	0	1																							
[FM2]	Slide switch SW6	VO2	IO2	Function code F35																						
	Function code F32	0	1																							
	[11]	Analog common	<p>Two common terminals for analog input and output signals. These terminals are electrically isolated from terminals [CM] and [CMY].</p>																							

Table 2.7 Symbols, Names and Functions of the Control Circuit Terminals (Continued)

Classification	Symbol	Name	Functions														
Transistor output	[Y1]	Transistor output 1	(1) Various signals such as inverter running, speed/freq. arrival and overload early warning can be assigned to any terminals, [Y1] to [Y4] by setting function code E20 to E24. Refer to Chapter 5, Section 5.2 "Details of Function Codes" for details. (2) Switches the logic value (1/0) for ON/OFF of the terminals between [Y1] to [Y4], and [CMY]. If the logic value for ON between [Y1] to [Y4] and [CMY] is 1 in the normal logic system, for example, OFF is 1 in the negative logic system and vice versa.														
	[Y2]	Transistor output 2															
	[Y3]	Transistor output 3	(Transistor output circuit specification)  <table border="1" data-bbox="981 593 1348 772"> <thead> <tr> <th colspan="2">Item</th> <th>Max.</th> </tr> </thead> <tbody> <tr> <td rowspan="2">Operation voltage</td> <td>ON level</td> <td>2 V</td> </tr> <tr> <td>OFF level</td> <td>27 V</td> </tr> <tr> <td colspan="2">Maximum current at ON</td> <td>50 mA</td> </tr> <tr> <td colspan="2">Leakage current at OFF</td> <td>0.1 mA</td> </tr> </tbody> </table>	Item		Max.	Operation voltage	ON level	2 V	OFF level	27 V	Maximum current at ON		50 mA	Leakage current at OFF		0.1 mA
	Item		Max.														
	Operation voltage	ON level	2 V														
OFF level		27 V															
Maximum current at ON		50 mA															
Leakage current at OFF		0.1 mA															
[Y4]	Transistor output 4	<p>Note</p> <ul style="list-style-type: none"> - When a transistor output drives a control relay, connect a surge-absorbing diode across relay's coil terminals. - When any equipment or device connected to the transistor output needs to be supplied with DC power, feed the power (+24 VDC; allowable range: +22 to +27 VDC, 100 mA max.) through the [PLC] terminal. Short-circuit between the terminals [CMY] and [CM] in this case. 															
[CMY]	Transistor output common	Common terminal for transistor output signals This terminal is electrically isolated from terminals [CM] and [11]s.															
	<p>Tip</p> <p>■ Connecting programmable logic controller (PLC) to terminal [Y1], [Y2], [Y3] or [Y4]</p> <p>Figure 2.17 shows two examples of circuit connection between the transistor output of the inverter's control circuit and a PLC. In example (a), the input circuit of the PLC serves as a SINK for the control circuit output, whereas in example (b), it serves as a SOURCE for the output.</p>	 <p>(a) PLC serving as SINK</p> <p>(b) PLC serving as SOURCE</p>															
Relay output	[Y5A/C]	General purpose relay output	<p>(1) A general-purpose relay contact output usable as well as the function of the transistor output terminal [Y1], [Y2], [Y3] or [Y4]. Contact rating: 250 VAC 0.3 A, $\cos \phi = 0.3$, 48 VDC, 0.5 A</p> <p>(2) Switching of the normal/negative logic output is applicable to the following two contact output modes: "Active ON" (Terminals [Y5A] and [Y5C] are closed (excited) if the signal is active.) and "Active OFF" (Terminals [Y5A] and [Y5C] are opened (non-excited) if the signal is active while they are normally closed.).</p>														

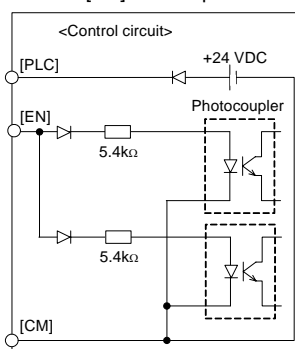
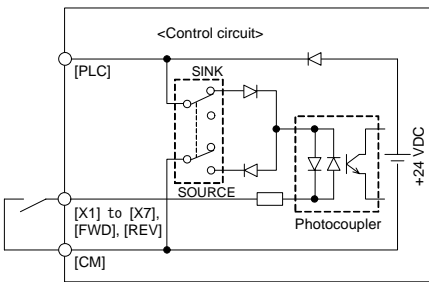
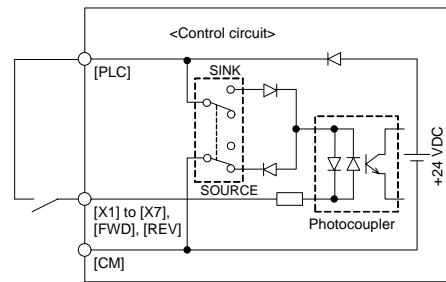
Table 2.7 Symbols, Names and Functions of the Control Circuit Terminals (Continued)

Classification	Symbol	Name	Functions
Relay output	[30A/B/C]	Alarm relay output (for any error)	<p>(1) Outputs a contact signal (SPDT) when a protective function has been activated to stop the motor. Contact rating: 250 VAC, 0.3A, cos φ = 0.3, 48 VDC, 0.5A</p> <p>(2) Any one of output signals assigned to terminals [Y1] to [Y4] can also be assigned to this relay contact to use it for signal output.</p> <p>(3) Switching of the normal/negative logic output is applicable to the following two contact output modes: "Active ON" (Terminals [30A] and [30C] are closed (excited) if the signal is active.) and "Active OFF" (Terminals [30A] and [30C] are opened (non-excited) if the signal is active while they are normally closed.).</p>
Communication	[DX+]/ [DX-]/ [SD]	RS-485 communications port 2 (Terminals on control PCB)	<p>A communications port transmits data through the RS-485 multipoint protocol between the inverter and a computer or other equipment such as a PLC. (For setting of the terminating resistor, refer to Section 2.3.6 "Setting up the slide switches.")</p>
	RJ-45 connector for the keypad	RS-485 communications port 1 (Standard RJ-45 connector)	<p>(1) Used to connect the inverter with the keypad. The inverter supplies the power to the keypad through the pins specified below. The extension cable for remote operation also uses wires connected to these pins for supplying the keypad power.</p> <p>(2) Remove the keypad from the standard RJ-45 connector and connect the RS-485 communications cable to control the inverter through the PC or PLC (Programmable Logic Controller). For setting of the terminating resistor, refer to Section 2.3.6 "Setting up the slide switches."</p> <div style="text-align: center;"> <p>Figure 2.18 RJ-45 Connector and its Pin Assignment*</p> </div> <p>* Pins 1, 2, 7, and 8 are exclusively assigned to power lines for the keypad, so do not use those pins for any other equipment.</p>
	USB connector	USB port (On the optional remote keypad TP-E1U)	<p>A USB port connector (mini B) that connects an inverter to a computer. FRENIC Loader (software) running on the computer supports editing the function codes, transferring them to the inverter, verifying them, test-running an inverter and monitoring the inverter running status. Note: The standard keypad has no USB port.</p>

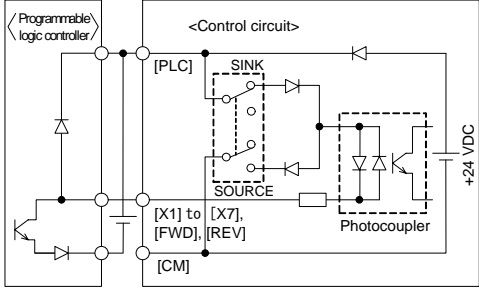
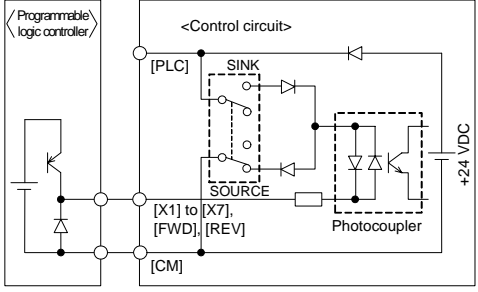
Wiring for control circuit terminals

For FRN125G1S-2U, FRN150G1S-2U and FRN250G1S-4U to FRN1000G1S-4U

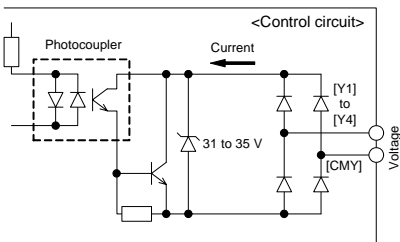
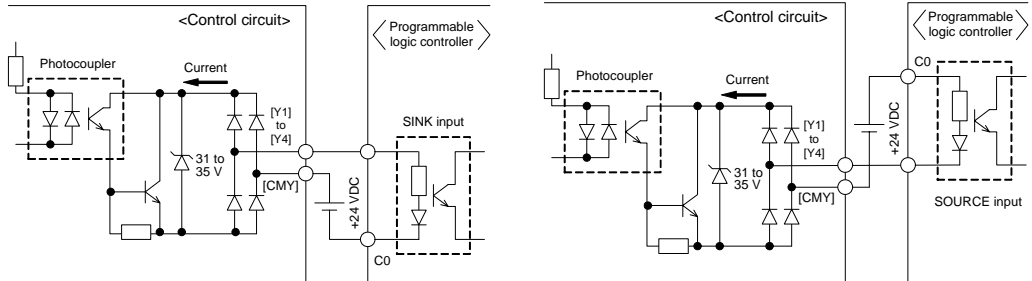
- (1) As shown in Figure 2.19, route the control circuit wires along the left side panel to the outside of the inverter.
- (2) Secure those wires to the wiring support, using a cable tie (e.g., Insulok) with 0.15 inch (3.8 mm) or less in width and 0.059 inch (1.5 mm) or less in thickness.

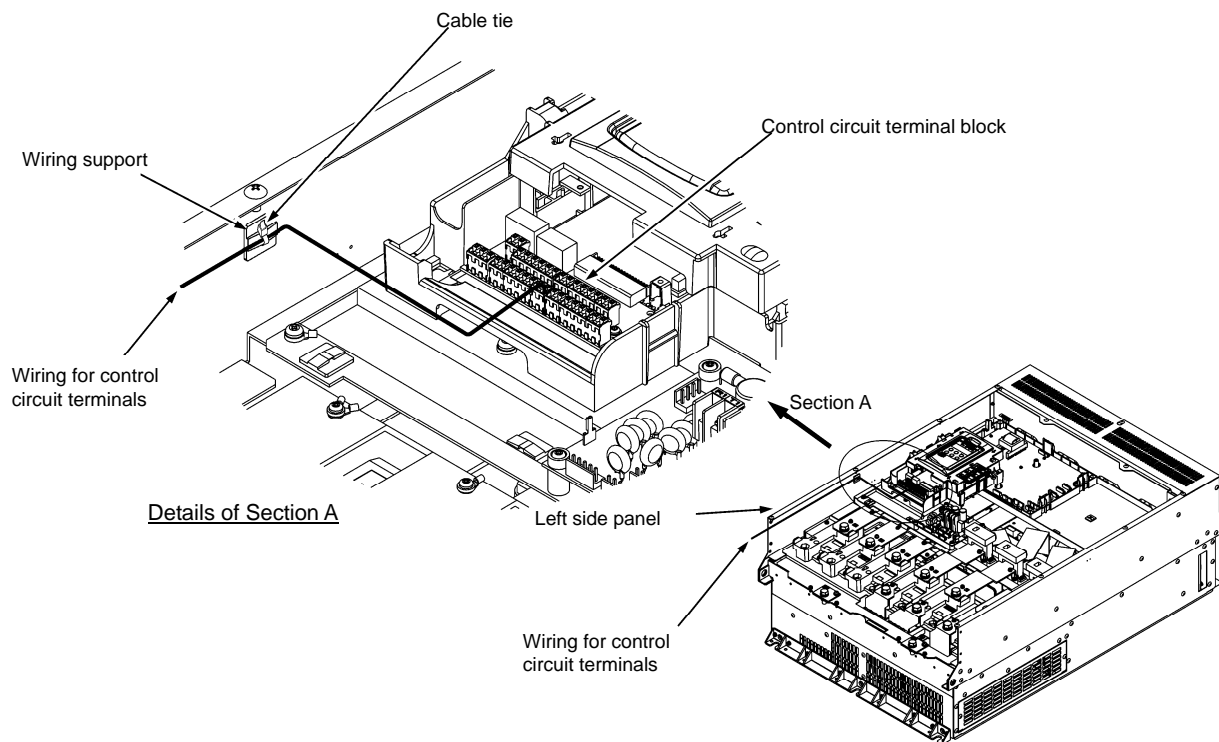

Figure 2.19 Wiring Route and Fixing Position for the Control Circuit Wires

- Note**
- Route the wiring of the control circuit terminals as far from the wiring of the main circuit as possible. Otherwise electric noise may cause malfunctions.
 - Fix the control circuit wires with a cable tie inside the inverter to keep them away from the live parts of the main circuit (such as the terminal block of the main circuit).

2.3.6 Setting up the slide switches

⚠ WARNING ⚠

Before changing the switches or touching the control circuit terminal symbol plate, **turn OFF the power and wait at least five minutes for inverters of 40 HP or below, or at least ten minutes for those of 50 HP or above.** Make sure that the LED monitor and charging lamp are turned OFF. Further, make sure, using a multimeter or a similar instrument, that the DC link bus voltage between the terminals P(+) and N(-) has dropped to the safe level (+25 VDC or below).

An electric shock may result if this warning is not heeded as there may be some residual electric charge in the DC bus capacitor even after the power has been turned OFF.

Switching the slide switches located on the control PCB allows you to customize the operation mode of the analog output terminals, digital I/O terminals, and communications ports. The locations of those switches are shown in Figure 2.20.

To access the slide switches, remove the front cover so that you can see the control PCB. For inverters of 50 HP or above, open also the keypad enclosure.

- For details on how to remove the front cover and how to open and close the keypad enclosure, refer to Section 2.3.1 "Removing and mounting the front cover and the wiring guide."

Table 2.8 lists function of each slide switch.

Table 2.8 Function of Each Slide Switch

Switch	Function																			
SW1	Switches the service mode of the digital input terminals between SINK and SOURCE. <ul style="list-style-type: none"> This switches the input mode of digital input terminals [X1] to [X7], [FWD] and [REV] to be used as the SINK or SOURCE mode. The factory default is SINK. 																			
SW2	Switches the terminating resistor of RS-485 communications port on the inverter ON and OFF. (RS-485 communications port 2, on the control PCB) <ul style="list-style-type: none"> If the inverter is connected to the RS-485 communications network as a terminating device, turn SW2 to ON. 																			
SW3	Switches the terminating resistor of RS-485 communications port on the inverter ON and OFF. (RS-485 communications port 1, for connecting the keypad) <ul style="list-style-type: none"> To connect a keypad to the inverter, turn SW3 to OFF. (Factory default) If the inverter is connected to the RS-485 communications network as a terminating device, turn SW3 to ON. 																			
SW4/SW6	Switches the output form of analog output terminals [FM1] and [FM2] between voltage and current. When changing the setting of SW4 and SW6, also change the data of function codes F29 and F32, respectively. <table border="1" style="width: 100%; border-collapse: collapse;"> <thead> <tr> <th rowspan="2">Output form</th> <th colspan="2">[FM1]</th> <th colspan="2">[FM2]</th> </tr> <tr> <th>SW4</th> <th>F29 data</th> <th>SW6</th> <th>F32 data</th> </tr> </thead> <tbody> <tr> <td>Voltage output (Factory default)</td> <td>VO1</td> <td>0</td> <td>VO2</td> <td>0</td> </tr> <tr> <td>Current output</td> <td>IO1</td> <td>1</td> <td>IO2</td> <td>1</td> </tr> </tbody> </table>	Output form	[FM1]		[FM2]		SW4	F29 data	SW6	F32 data	Voltage output (Factory default)	VO1	0	VO2	0	Current output	IO1	1	IO2	1
Output form	[FM1]		[FM2]																	
	SW4	F29 data	SW6	F32 data																
Voltage output (Factory default)	VO1	0	VO2	0																
Current output	IO1	1	IO2	1																
SW5	Switches the property of the analog input terminal [C1] between analog setting current input, PTC thermistor input, and NTC thermistor input. When changing this switch setting, also change the data of function code H26. <table border="1" style="width: 100%; border-collapse: collapse;"> <thead> <tr> <th>Function</th> <th>SW5</th> <th>H26 data</th> </tr> </thead> <tbody> <tr> <td>Analog setting current input (Factory default)</td> <td>C1</td> <td>0</td> </tr> <tr> <td>PTC thermistor input</td> <td>PTC/NTC</td> <td>1 (alarm) or 2 (warning)</td> </tr> <tr> <td>NTC thermistor input</td> <td>PTC/NTC</td> <td>3</td> </tr> </tbody> </table>	Function	SW5	H26 data	Analog setting current input (Factory default)	C1	0	PTC thermistor input	PTC/NTC	1 (alarm) or 2 (warning)	NTC thermistor input	PTC/NTC	3							
Function	SW5	H26 data																		
Analog setting current input (Factory default)	C1	0																		
PTC thermistor input	PTC/NTC	1 (alarm) or 2 (warning)																		
NTC thermistor input	PTC/NTC	3																		

Figure 2.20 shows the location of slide switches on the control PCB for the input/output terminal configuration.

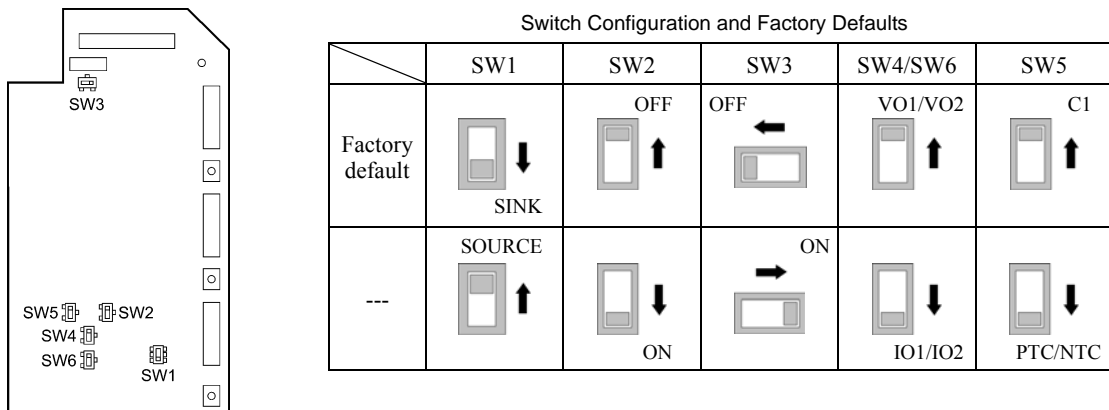

Figure 2.20 Location of the Slide Switches on the Control PCB

Note To move a switch slider, use a tool with a narrow tip (e.g., a tip of tweezers). Be careful not to touch other electronic parts, etc. If the slider is in an ambiguous position, the circuit is unclear whether it is turned ON or OFF and the digital input remains in an undefined state. Be sure to place the slider so that it contacts either side of the switch.

2.4 Mounting and Connecting the Keypad

The standard keypad TP-G1W-J1 meets UL Type 4 (NEMA4) by itself.

■ On the panel or at a remote site

The keypad can be mounted on the panel wall as shown below or installed at a remote site for operation on hand.

Mount the keypad with four M3 x 12 screws provided--two fine thread screws and two coarse thread tapping screws. The recommended tightening torque is 6.2 lb-in (0.7 N•m).

For panel cutting dimensions, refer to Chapter 8, Section 8.4.5.

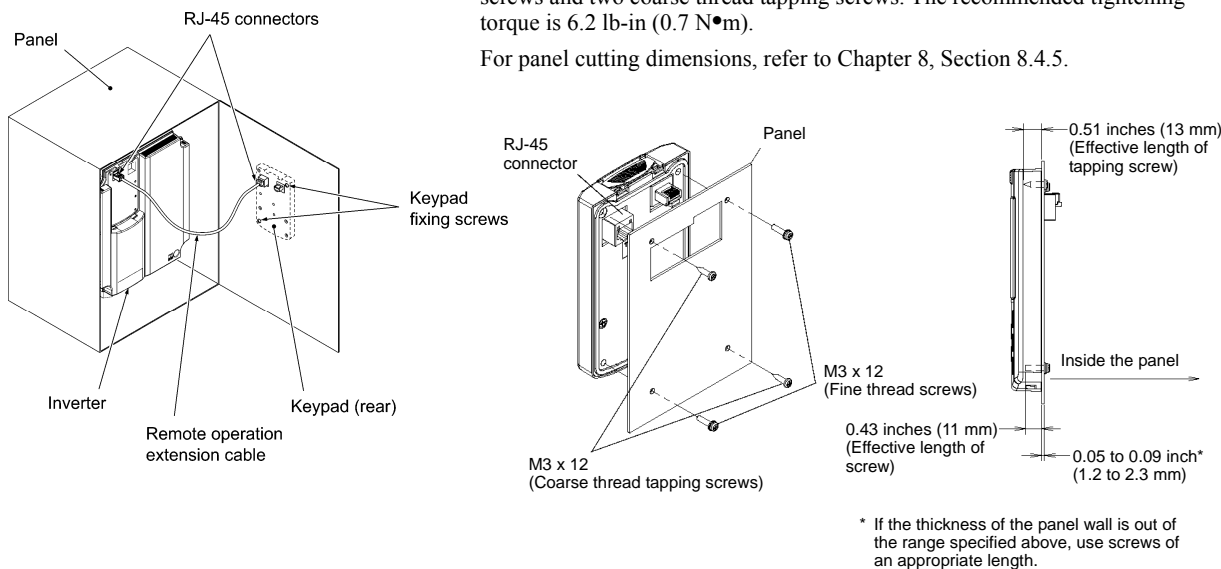

Figure 2.21 Mounting the Keypad on the Panel Wall

To mount the keypad on a place other than an inverter, the parts listed below are needed.

Parts name	Type	Remarks
Extension cable	LAN cable	0BASE-T/100BASE-TX straight type cable compliant with US ANSI/TIA/EIA-568A Category 5. (Less than 66 ft (20 m))

■ On the inverter

To remove the keypad from the inverter, pull it toward you while holding down the hook (pointed by the arrow in Figure 2.22). When mounting it, put the keypad back into place in the reverse order of removal.

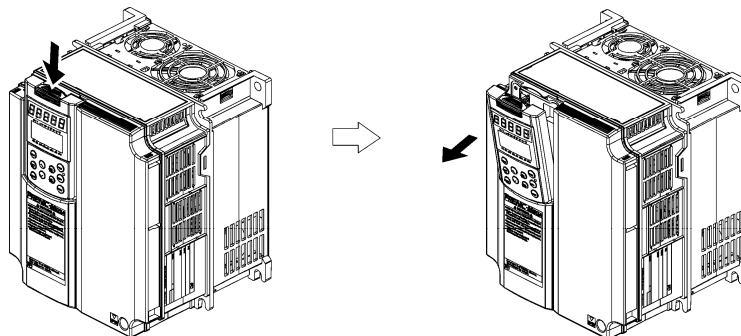

Figure 2.22 Removing the Keypad

Chapter 3 OPERATION USING THE KEYPAD

3.1 LED Monitor, LCD Monitor, and Keys

The keypad allows you to start and stop the motor, view various data including maintenance information and alarm information, configure function codes, monitor I/O signal status, copy data, and calculate the load factor.

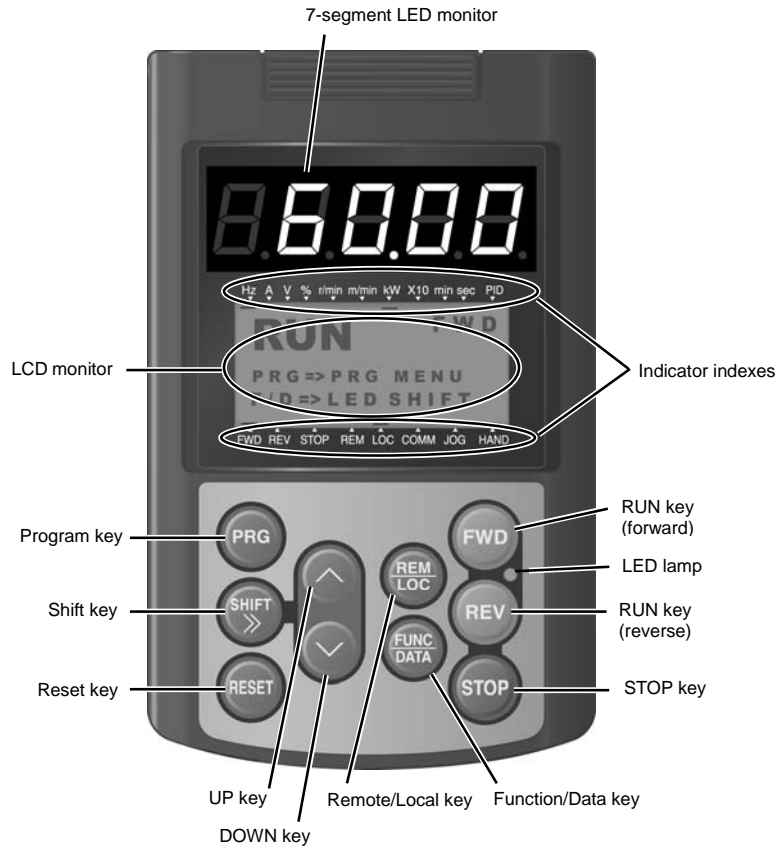

Table 3.1 Overview of Keypad Functions



Item	Monitors and Keys	Functions
Monitors		Five-digit, 7-segment LED monitor which displays the following according to the operation modes: <ul style="list-style-type: none"> ■ In Running mode: Running status information (e.g., output frequency, current, and voltage) ■ In Programming mode: Same as above. ■ In Alarm mode: Alarm code, which identifies the alarm when the protective function is activated.
		LCD monitor which displays the following according to the operation modes: <ul style="list-style-type: none"> ■ In Running mode: Running status information ■ In Programming mode: Menus, function codes and their data ■ In Alarm mode: Alarm code, which identifies the alarm when the protective function is activated.
	Indicator indexes	In Running mode, these indexes show the unit of the number displayed on the 7-segment LED monitor and the running status information on the LCD monitor. For details, see the next page.

Table 3.1 Overview of Keypad Functions (Continued)

Item	Monitors and Keys	Functions
Program- ming keys		Switches the operation modes of the inverter.
		Shifts the cursor to the right for entry of a numerical value.
		Pressing this key after removing the cause of an alarm switches the inverter to Running mode. This key is used to reset settings or screen transition.
		UP and DOWN keys, which are used to select the setting items or change the function code data.
		Function/Data key, which switches the operation mode as follows: <ul style="list-style-type: none"> ■ In Running mode: Pressing this key switches the information to be displayed concerning the status of the inverter (output frequency (Hz), output current (A), output voltage (V), etc.). ■ In Programming mode: Pressing this key displays the function code and establishes the newly entered data. ■ In Alarm mode: Pressing this key displays the details of the problem indicated by the alarm code that has come up on the LED monitor.
Operation keys		Starts running the motor in the forward rotation.
		Starts running the motor in the reverse rotation.
		Stops the motor.
		Holding down this key for more than 1 second toggles between local and remote modes.
LED lamp		Lights while a run command is supplied to the inverter.

Details of Indicator Indexes

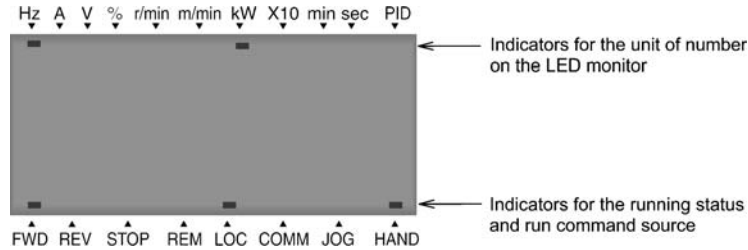

Type	Item	Description (information, condition, and status)
Unit of number on LED monitor	Hz	Output frequency and reference frequency
	A	Output current
	V	Output voltage
	%	Calculated torque, load factor, and speed
	r/min	Preset and actual motor speeds and preset and actual load shaft speeds
	m/min	Preset and actual line speeds
	kW	Input power and motor output
	X10	Data exceeding 99,999
	min	Preset and actual constant feeding rate times
	sec	Timer
	PID	PID process value

Type	Item	Description (information, condition, and status)
Running status	FWD	Running in the forward rotation
	REV	Running in the reverse rotation
	STOP	No output frequency
Run command source	REM	Remote mode
	LOC	Local mode
	COMM	Via communications link (RS-485 (standard, optional), fieldbus option)
	JOG	Jogging mode
	HAND	Via keypad (This item lights also in local mode.)

3.2 Overview of Operation Modes

The FRENIC-MEGA features the following three operation modes.

Table 3.2 Operation Modes

Mode	Description
Running Mode	This mode allows you to specify run/stop commands in regular operation. It is also possible to monitor the running status in real time. If a light alarm occurs, the $\underline{L} - \underline{FL}$ * appears on the LED monitor.
Programming Mode	This mode allows you to configure function code data and check a variety of information relating to the inverter status and maintenance.
Alarm Mode	If an alarm condition arises, the inverter automatically enters the Alarm mode in which you can view the corresponding alarm code* and its related information on the LED and LCD monitors. * Alarm code that represents the cause(s) of the alarm(s) that has been triggered by the protective function. For details, refer to the "Protective Functions" in Chapter 6, Section 6.1.

Figure 3.1 shows the status transition of the inverter between these three operation modes.

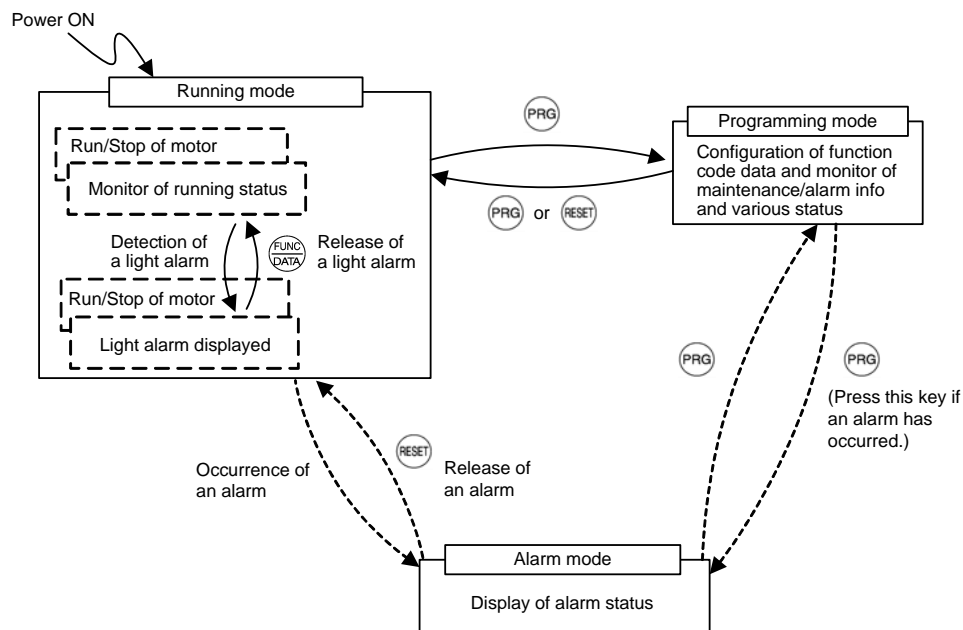

Figure 3.1 Status Transition between Operation Modes

3.3 Running Mode

3.3.1 Running or stopping the motor

By factory default, pressing the **FWD** key starts running the motor in the forward direction and pressing the **STOP** key decelerates the motor to a stop. The **REV** key is disabled. Running or stopping the motor with the keypad is enabled only in Running and Programming modes.

To run the motor in reverse direction or run the motor in reversible mode, change the setting of function code F02.

For details of function code F02, refer to Chapter 5 "FUNCTION CODES."

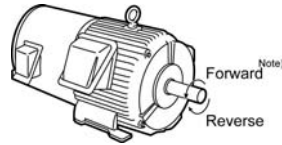

Figure 3.2 Rotational Direction of Motor

Note) The rotational direction of an IEC-compliant motor is opposite to the one shown above.

■ Displaying the running status on the LCD monitor

(1) When function code E45 (LCD monitor item selection) is set at "0"

The LCD monitor displays the running status, the rotational direction, and the operation guide.

(The upper indicators show the unit of values displayed on the LED monitor as detailed in Section 3.3.2. The lower ones show the running status and run command source.)

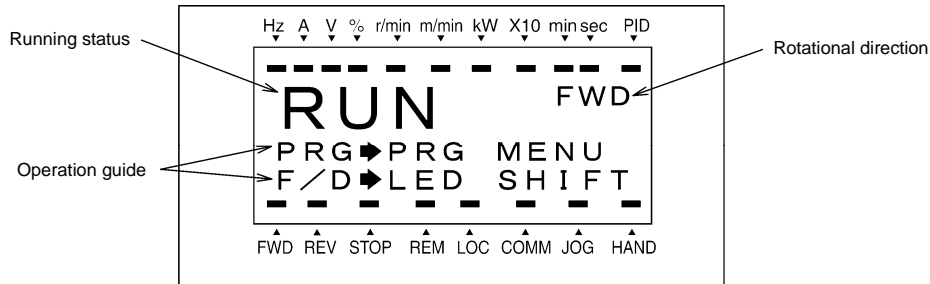

Figure 3.3 Display of Running Status

The running status and the rotational direction are displayed as shown in Table 3.3.

Table 3.3 Running Status and Rotational Direction

Status/Direction	Display	Meaning
Running status	RUN	A run command is given or the inverter is running the motor.
	STOP	A run command is not given and the inverter is stopped.
Rotational direction	FWD	Running in the forward rotation
	REV	Running in the reverse rotation
	Blank	Stopped

(2) When function code E45 (LCD monitor item selection) is set at "1"

The LCD monitor displays the output frequency, output current, and calculated torque in a bar chart.

(The upper indicators show the unit of values displayed on the LED monitor as detailed in Section 3.3.2. The lower ones show the running status and run command source.)

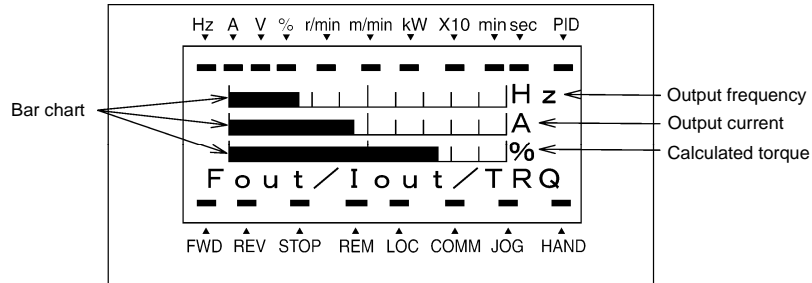

The full scale (maximum value) for each parameter is as follows:

- Output frequency: Maximum frequency
- Output current: 200% of inverter's rated current
- Calculated torque: 200% of rated torque generated by motor

Figure 3.4 Bar Chart

3.3.2 Monitoring the running status on the LED monitor

The items listed below can be monitored on the 7-segment LED monitor. Immediately after the power is turned ON, the monitor item specified by function code E43 is displayed.



Pressing the  key in Running mode switches between monitor items in the sequence shown in Table 3.4. The "Monitor page #" column shows the monitor page of the items supported.

Table 3.4 Items Monitored

Monitored Items on the LED Monitor	Example	Unit	Meaning of Displayed Value	Function code E43	Monitor page #
Speed Monitor	Function code E48 specifies what to be displayed.			0	0
Output frequency 1 (before slip compensation)	50.00	Hz	Frequency actually being output (Hz)	(E48 = 0)	
Output frequency 2 (after slip compensation)	50.00	Hz	Frequency actually being output (Hz)	(E48 = 1)	
Reference frequency	50.00	Hz	Frequency actually being specified (Hz)	(E48 = 2)	
Motor speed	1500	r/min	Output frequency (Hz) × $\frac{120}{P01}$	(E48 = 3)	
Load shaft speed	300.0	r/min	Output frequency (Hz) × E50	(E48 = 4)	
Line speed	300.0	m/min	Output frequency (Hz) × E50	(E48 = 5)	
Display speed (%)	50.0	%	$\frac{\text{Output frequency (Hz)}}{\text{Maximum frequency (Hz)}} \times 100$	(E48 = 7)	
Output current	12.34	A	Current output from the inverter in RMS	3	8
Input power	10.25	kW	Input power to the inverter	9	9
Calculated torque	50	%	Motor output torque in % (Calculated value)	8	10
Output voltage	200	V	Voltage output from the inverter in RMS	4	11
Motor output	9.85	kW	Motor output in kW	16	12
Load factor	50	%	Load factor of the motor in % as the rated output being at 100%	15	13

Table 3.4 Items Monitored (Continued)

Monitored Items on the LED Monitor	Example	Unit	Meaning of Displayed Value	Function code E43	Monitor page #
PID command (Note 1)	10.00	—	PID command/feedback amount transformed to that of physical value of the object to be controlled (e.g., temperature) Refer to function codes E40 and E41 for details.	10	14
PID feedback amount (Note 1)	9.00	—		12	15
PID output (Note 1)	100.0	%	PID output in % as the maximum frequency being at 100%	14	16
Analog input (Note 2)	82.00	—	Analog input to the inverter in a format suitable for a desired scale Refer to function codes E40 and E41 for details.	17	18
Torque current (Note 3)	48	%	Torque current command value or calculated torque current	23	21
Magnetic flux command (Note 3)	50	%	Magnetic flux command value (Available only under vector control)	24	22
Input watt-hour	100.0	kWh	Input watt - hour (kWh) 100	25	23

The LCD monitor (given below) shows information related to the item shown on the LED monitor. The monitor items on the LED monitor can be switched by pressing the  key.

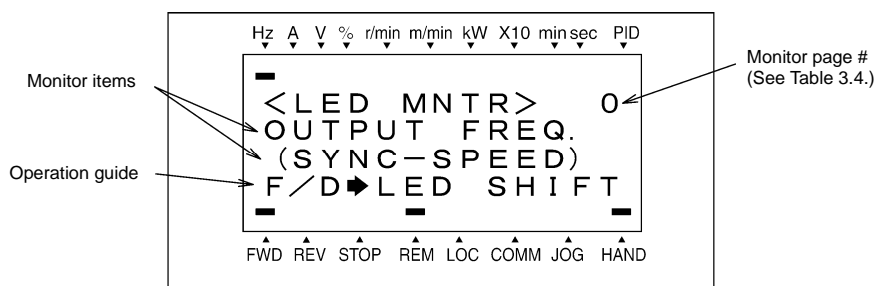

Figure 3.5 LCD Monitor Sample Detailed for the LED Monitor Item

- (Note 1) These PID related items appear only under PID control specified by function code J01 (= 1, 2 or 3). When a PID command or PID output is displayed, the dot at the lowest digit on the LED monitor blinks; when a PID feedback amount is displayed, it is lit.
- (Note 2) The analog input monitor appears only when the analog input monitor is enabled by any of function codes E61 to E63 (Select terminal function).
- (Note 3) Under V/f control, a zero (0) is displayed.

3.3.3 Monitoring light alarms

The FRENIC-MEGA identifies abnormal states in two categories--Alarm and Light alarm. If the former occurs, the inverter immediately trips; if the latter occurs, the $\angle -FL$ appears on the LED monitor and the "L-ALARM" appears blinking in the operation guide area on the LCD monitor, but the inverter continues to run without tripping.

Which abnormal states are categorized as a light alarm ("Light alarm" object) should be defined with function codes H81 and H82 beforehand.

Assigning the **LALM** signal to any one of the digital output terminals with any of function codes E20 to E24 and E27 (data = 98) enables the inverter to output the **LALM** signal on that terminal upon occurrence of a light alarm.

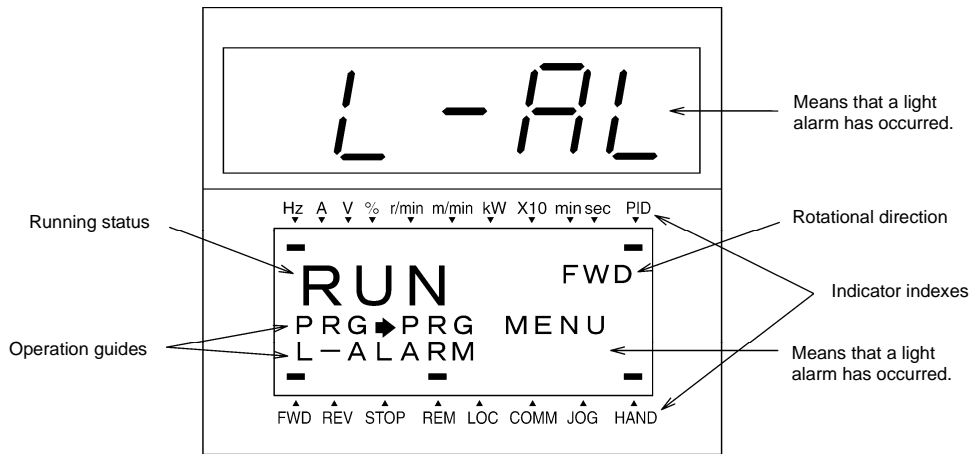

Figure 3.6 Display of Light Alarm

For details of the light alarms, refer to Chapter 6 "TROUBLESHOOTING."

■ How to check a light alarm

If a light alarm occurs, the $\angle -FL$ appears on the LED monitor. To check the current light alarm, enter Programming mode by pressing the PRG key and select LALM1 on Menu #5 "Maintenance Information."

It is also possible to check the last three light alarms by selecting LALM2 (last) to LALM4 (3rd last).

For details of the menu transition of the maintenance information, refer to Section 3.4.6 "Reading maintenance information."

■ How to remove the current light alarm

After checking the current light alarm, to switch the LED monitor from the $\angle -FL$ indication back to the running status display (e.g., output frequency), press the FWD key in Running mode.

If the light alarm has been removed, the "L-ALARM" disappears and the **LALM** output signal turns OFF. If not (e.g. DC fan lock), the $\angle -FL$ on the LED monitor disappears so that normal monitoring becomes available, but the "L-ALARM" remains displayed on the LCD monitor (as shown below) and the **LALM** output signal remains ON.

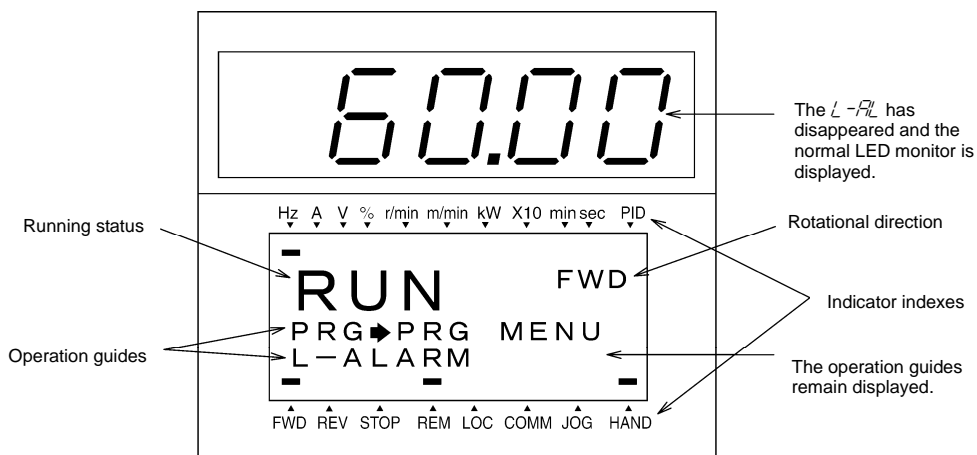

3.4 Programming Mode

Programming mode provides you with these functions--setting and checking function code data, monitoring maintenance information and checking input/output (I/O) signal status. These functions can be easily selected with a menu-driven system. Table 3.5 lists menus available in Programming mode.

When the inverter enters Programming mode from the second time on, the menu selected last in Programming mode will be displayed.

Table 3.5 Menus Available in Programming Mode

Menu #	Menu	Used to:	Refer to Section:
0	Quick Setup	Display only basic function codes previously selected.	3.4.1
1	Data Setting	Display and change the data of the function code selected. (Note)	3.4.2
2	Data Checking	Display the function code selected and its data on the same screen. Also this menu is used to change the function code data or check whether the data has been changed from the factory default.	3.4.3
3	Drive Monitoring	Display the running information required for maintenance or test running.	3.4.4
4	I/O Checking	Display external interface information.	3.4.5
5	Maintenance Information	Display maintenance information including cumulative run time.	3.4.6
6	Alarm Information	Display the recent four alarm codes. Also this menu is used to view the information on the running status at the time the alarm occurred.	3.4.7
7	Alarm Cause	Display the cause of the alarm.	3.4.8
8	Data Copying	Read or write function code data, as well as verifying it.	3.4.9
9	Load Factor Measurement	Measure the maximum output current, average output current, and average braking power.	3.4.10
10	User Setting	Add or delete function codes covered by Quick Setup.	3.4.11
11	Communication Debugging	Confirm the data of function codes exclusively designed for communication (S, M, W, X, and Z codes).	3.4.12

(Note) The o codes are displayed only when the corresponding option is mounted on the inverter. For details, refer to the instruction manual of the corresponding option.

Figure 3.7 shows the transitions between menus in Programming mode.

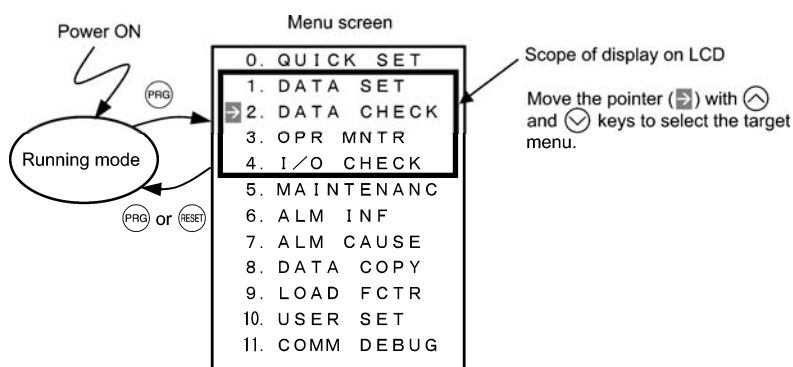

Figure 3.7 Menu Transition in Programming Mode

If no key is pressed for approx. 5 minutes, the inverter automatically goes back to Running mode and turns the backlight OFF.

3.4.1 Setting up function codes quickly using Quick Setup -- Menu #0 "Quick Setup" --

Menu #0 "Quick Setup" in Programming mode quickly displays and sets up a basic set of function codes specified beforehand.

Using Menu #10 "User Setting" adds or deletes function codes to/from the set of function codes registered for Quick Setup by default. The set of function codes registered for Quick Setup is held in the inverter memory (not the keypad). If the keypad on a particular inverter is mounted on any other inverter, therefore, the set of function codes held in the latter inverter is subject to Quick Setup.

The set of function codes subject to Quick Setup can be copied with the copy function (Menu #8 "Data Copying").

Performing data initialization (function code H03) resets the set of function codes subject to Quick Setup to the factory default.

 For the list of function codes subject to Quick Setup by factory default, refer to Chapter 5 "FUNCTION CODES."

The menu transition in Menu #0 is just like that in Menu #1 "Data Setting" given in the next section.

Basic key operation

Same as the basic key operation for Menu #1 "Data Setting."

3.4.2 Setting up function codes -- Menu #1 "Data Setting" --





Menu #1 "Data Setting" in Programming mode allows you to set up all function codes for making the inverter functions match your needs.

Table 3.6 Function Code List

Function Code Group	Function	Description
F codes	Fundamental functions	Functions concerning basic motor running
E codes	Extension terminal functions	Functions concerning the assignment of control circuit terminals Functions concerning the display of the LED monitor
C codes	Control functions	Functions associated with frequency settings
P codes	Motor 1 parameters	Functions for setting up characteristics parameters (such as capacity) of the 1st motor
H codes	High performance functions	Highly added-value functions Functions for sophisticated control
A codes	Motor 2 parameters	Functions for setting up characteristics parameters (such as capacity) of the 2nd motor
b codes	Motor 3 parameters	Functions for setting up characteristics parameters (such as capacity) of the 3rd motor
r codes	Motor 4 parameters	Functions for setting up characteristics parameters (such as capacity) of the 4th motor
J codes	Application functions 1	Functions for applications such as PID control
d codes	Application functions 2	Functions for applications such as speed control
U codes	Application functions 3	Functions for applications such as customizable logic
y codes	Link functions	Functions for controlling communication
o codes	Option functions	Functions for options (Note)

(Note) The o codes are displayed only when the corresponding option is mounted on the inverter. For details, refer to the instruction manual of the corresponding option.

■ Function codes requiring simultaneous keying

To modify the data of function code F00 (data protection), H03 (data initialization), or H97 (clear alarm data), simultaneous keying of " +  keys" or " +  keys" is required.

■ Changing, validating, and saving function code data when the invert is running

Some function codes can be modified when the inverter is running. The modification may or may not take effect immediately. For details, refer to the "Change when running" column in Chapter 5, Section 5.1 "Function Code Tables."

Basic configuration of screens

Figure 3.8 shows the LCD screen transition for Menu #1 "Data Setting."

A hierarchy exists among those screens that are shifted in the order of "menu screen," "list of function codes," and "function code data modification screens."

On the modification screen of the target function code, you can modify or check its data.

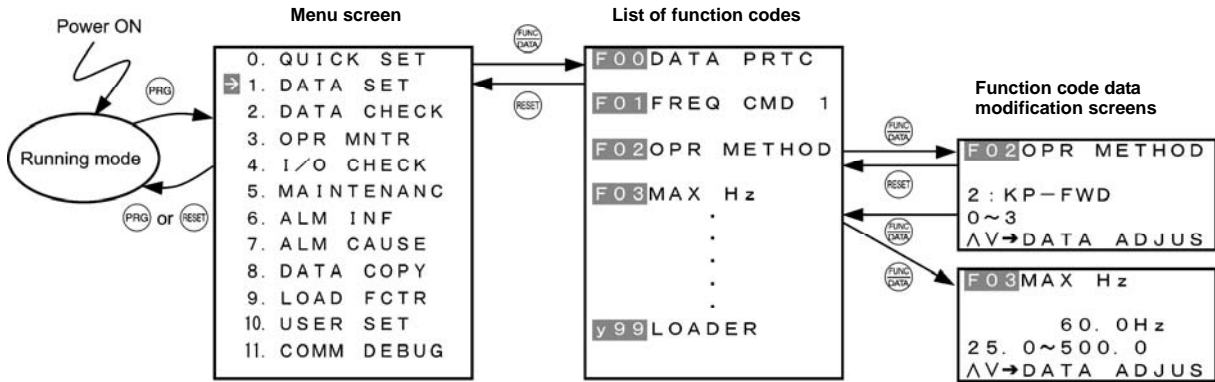
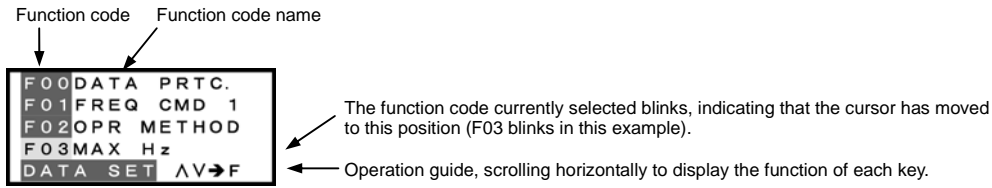

Figure 3.8 Configuration of Screens for "DATA SET"

Screen samples for changing function code data

The "list of function codes" shows function codes, their names, and operation guides.



The "function code data modification screen" shows the function code, its name, its data (before and after change), allowable entry range, and operation guides.

<Before change>

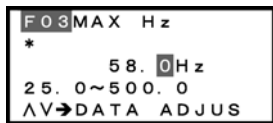

Function code #, name
 *: Function code that has been changed from factory default
 Data
 Allowable entry range
 Operation guide

<Changing data>

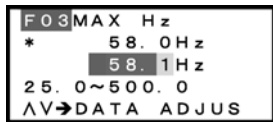

Data before change
 Data being changed

Figure 3.9 Screen Samples for Changing Function Code Data

Basic key operation

This section gives a description of the basic key operation, following the example of the data changing flow shown below. This example shows how to change F03 data (maximum frequency) from 58.0 Hz to 58.1 Hz.

- (1) Turn the inverter ON. It automatically enters Running mode. In that mode, press the **(PRG)** key to switch to Programming mode and display the menu screen.
- (2) Move the pointer **→** to "1. DATA SET" with the **(↑)** and **(↓)** keys, then press the **(FUNC DATA)** key to proceed to a list of function codes.
- (3) Select the desired function code (F03 in this example) with the **(↑)** and **(↓)** keys, then press the **(FUNC DATA)** key to display the corresponding function code data screen.
- (4) Change the function code data with the **(↑)** and **(↓)** keys.

Pressing the **(SHIFT)** key causes the blinking digit place to shift (cursor shifting) (The blinking digit can be changed).

- (5) Press the **(FUNC DATA)** key to establish the function code data.

The data will be saved in the inverter's memory. The display returns to a list of function codes and the cursor moves to the next function code (F04 in this example).

Pressing the **(RESET)** key instead of the **(FUNC DATA)** key cancels the new function code data, reverts to the previous data, returns to a list of function codes, and returns the cursor to the previous function code (F03 in this example).

- (6) Press the **(RESET)** key to go back to the menu screen.

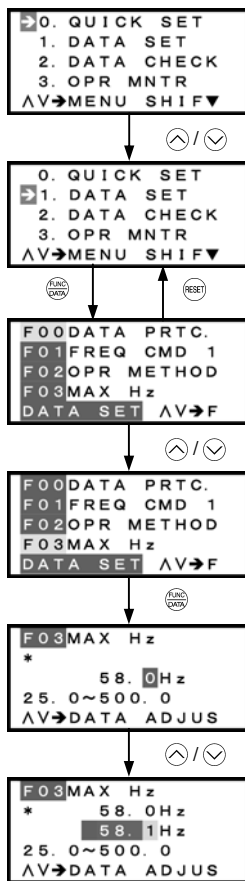

- (1) To display this menu screen, press **(PRG)** key in Running mode to switch to Programming mode.

- (2) Move the pointer **→** to "1. DATA SET" with **(↑)** and **(↓)** keys.

Press **(FUNC DATA)** key to establish the selected menu and proceed to a list of function codes.

- (6) To go back to the menu screen, press **(RESET)** key.)

- (3) Move the cursor with **(↑)** and **(↓)** keys to select the desired function code.

Press **(FUNC DATA)** key to establish the selected function code and display its data screen.

- (4) Change the function code data with **(↑)** and **(↓)** keys.

- (5) Press **(FUNC DATA)** key to establish the function code data.
To cancel change of data, press **(RESET)** key.

Figure 3.10 Screen Transition for "Data Checking"

3.4.3 Checking changed function codes -- Menu #2 "Data Checking" --

Menu #2 "Data Checking" in Programming mode allows you to check function codes and their data that has been changed. The function codes whose data has been changed from the factory defaults are marked with an asterisk (*). Select a function code and press the  key to view or change its data.

The LCD screen transition from Menu #2 is the same as that from Menu #1 "Data Setting," except a list of function codes as shown below.

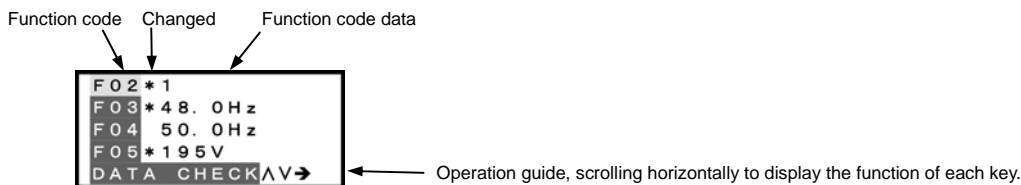

Figure 3.11 List of Function Codes

Basic key operation

Same as the basic key operation for Menu #1 "Data Setting."

3.4.4 Monitoring the running status -- Menu #3 "Drive Monitoring" --

Menu #3 "Drive Monitoring" in Programming mode allows you to monitor the running status during maintenance and test running.

Table 3.7 Drive Monitoring Items

Page # in operation guide	Item	Symbol	Description
1	Output frequency	Fot1	Output frequency (before slip compensation)
	Output frequency	Fot2	Output frequency (after slip compensation)
	Output current	Iout	Output current
	Output voltage	Vout	Output voltage
2	Calculated torque	TRQ	Calculated output torque generated by motor
	Reference frequency	Fref	Frequency specified by a frequency command
	Running direction	FWD REV (Blank)	Forward Reverse Stopped
	Current limit	IL	Current limiting
	Undervoltage	LU	Undervoltage detected
	Voltage limit	VL	Voltage limiting
	Torque limit	TL	Torque limiting
	Speed limit	SL	Speed limiting
Motor selected	M1-M4	Motor 1 to 4	
Drive control	VF DTV VF-SC VF-PG VC-SL VC-PG	V/f control without slip compensation Dynamic torque vector control V/f control with slip compensation Dynamic torque vector control with speed sensor Vector control without speed sensor Vector control with speed sensor	
3	Motor speed	SYN	$(\text{Output frequency Hz}) \times \frac{120}{P01}$
	Load shaft speed	LOD	Output frequency (Hz) \times Function code E50
	Line speed	LIN	Output frequency (Hz) \times Function code E50
	Constant peripheral speed control monitor	LSC	Actual peripheral speed under constant peripheral speed control

Table 3.7 Drive Monitoring Items (Continued)

Page # in operation guide	Item	Symbol	Description
4	PID command value	SV	The PID command value and PID feedback amount are displayed after conversion to the virtual physical values (e.g., temperature or pressure) of the object to be controlled using function code E40 and E41 data (PID display coefficients A and B). Display value = (PID command value or feedback amount) × (Coefficient A - B) + B
	PID feedback amount	PV	
	PID output value	MV	PID output value, displayed in % (assuming the maximum frequency (F03) as 100%).
5	Torque limit value A	TLA	Driving torque limit value A (based on motor rated torque)
	Torque limit value B	TLB	Driving torque limit value B (based on motor rated torque)
	Reference torque bias	TRQB	Reserved.
6	Current position pulse	P	Current position pulse for positioning control
	Stop position target pulse	E	Stop position target pulse for positioning control
	Position deviation pulse	dP	Position deviation pulse for positioning control
	Positioning control status	MODE	Positioning control status
7	Motor temperature	NTC	Temperature detected by the NTC thermistor built in the motor
	Ratio setting	Rati	When this setting is 100%, the LED monitor shows 1.00 time of the value to be displayed.
	Magnetic flux command value	FLUX	Flux command value in %.
	Deviation in SY synchronous operation	SY-d	Deviation in SY synchronous operation
8	Current position pulse, 4-multiplied	P4	Current position pulse for positioning control
	Stop position target pulse, 4-multiplied	E4	Stop position target pulse for positioning control
	Position deviation pulse, 4-multiplied	dP4	Position deviation pulse for positioning control
	Positioning control status	MODE	Reserved.

Basic key operation

- (1) Turn the inverter ON. It automatically enters Running mode. In that mode, press the **PRO** key to switch to Programming mode and display the menu screen.
- (2) Move the pointer → to "3. OPR MNTR" with the **▲** and **▼** keys.
- (3) Press the **FUNC DATA** key to establish the selected menu and proceed to a list of monitoring items (consisting of several pages).
- (4) Use the **▲** and **▼** keys to select the page on which the desired monitoring item is shown, then check the running status information of that item.
- (5) Press the **RESET** key to go back to the menu screen.

Figure 3.12 shows an example of the LCD screen transition starting from Menu #3 "Drive Monitoring."

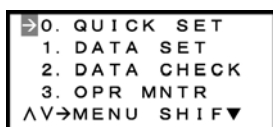

(1) To display this menu screen, press **PRO** key in Running mode to switch to Programming mode.



(2) Move the pointer → to "3. OPR MNTR" with **▲** and **▼** keys.

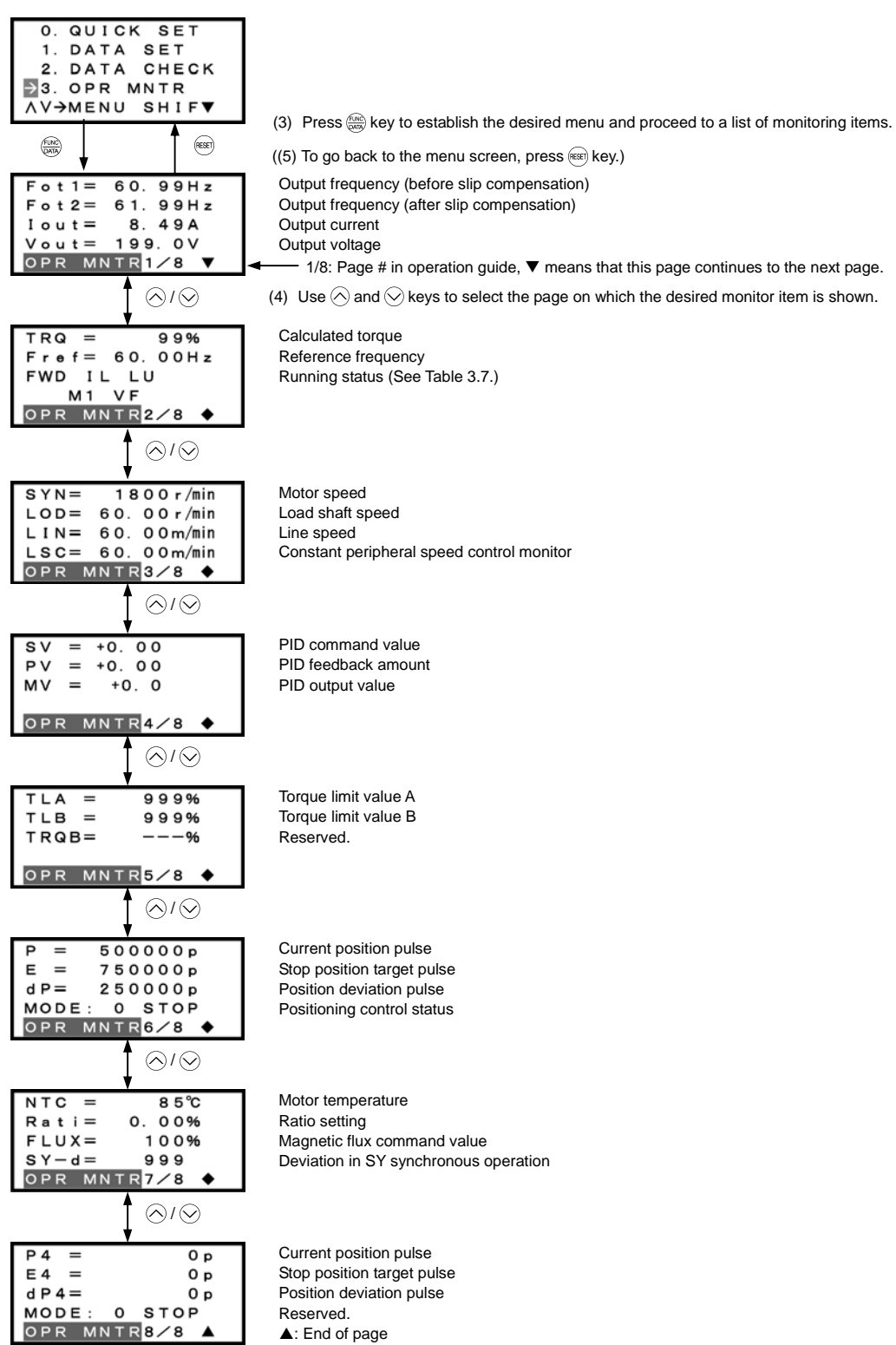

Common operation items

- To access the target data, switch to the desired page using the **←** and **→** keys.
- ▼: This page continues to the next page.
- ◆: This page is continued from the previous page and continues to the next page.
- ▲: This page is continued from the previous page.

Figure 3.12 Screen Transition for "Drive Monitoring"

3.4.5 Checking I/O signal status -- Menu #4 "I/O Checking" --

Menu #4 "I/O Checking" in Programming mode allows you to check the I/O states of digital and analog signals. It is used to check the running status during maintenance or test running.

Table 3.8 I/O Check Items

Page # in operation guide	Item	Symbol	Description
1	Input signals on the control circuit terminals	FWD, REV, X1 - X7, EN	ON/OFF state of input signals on the control circuit terminal block. (Highlighted when short-circuited; normal when open)
2	Input signals via communications link	FWD, REV, X1 - X7, XF, XR, RST	Input information for function code S06 (communication) (Highlighted when 1; normal when 0)
3	Output signals	Y1 - Y4, Y5, 30ABC	Output signal information
4	I/O signals (hexadecimal)	Di	Input signals on the control circuit terminal block (in hexadecimal)
		Do	Output signals (in hexadecimal)
		LNK	Input signal entered via communications link (in hexadecimal)
5	Analog input signals	I2	Input voltage on terminal [I2]
		C1	Input current on terminal [C1]
		V2	Input voltage on terminal [V2]
6	Analog output signals	FM1 FM1 FM2 FM2	Output voltage on terminal [FM1] * Output current on terminal [FM1] Output voltage on terminal [FM2] Output current on terminal [FM2]
7	Input signals on the digital input interface card (option)	Di-o	Input signals on the option card in hexadecimal
	Output signals on the digital output interface card (option)	Do-o	Output signals on the option card in hexadecimal
	Pulse train input	X7	Pulse count signals of pulse train input on terminal [X7]
8	PG pulse rate	P1	Pulse rate (p/s) of the A/B phase signal fed back from the reference PG
		Z1	Pulse rate (p/s) of the Z phase signal fed back from the reference PG
		P2	Pulse rate (p/s) of the A/B phase signal fed back from the slave PG
		Z2	Pulse rate (p/s) of the Z phase signal fed back from the slave PG
9	I/O signals of analog input/output interface card (option)	32	Input voltage on terminal [32] (option)
		C2	Input current on terminal [C2] (option)
		A0	Output voltage on terminal [A0] (option)
		CS	Output current on terminal [CS] (option)

* Some screens differ depending upon the specifications even on the same inverter models.

Basic key operation

- (1) Turn the inverter ON. It automatically enters Running mode. In that mode, press the **PRG** key to switch to Programming mode and display the menu screen.
- (2) Move the pointer \rightarrow to "4. I/O CHECK" with the \uparrow and \downarrow keys.
- (3) Press the **FUNC/DATA** key to establish the selected menu and proceed to a list of I/O check items (consisting of several pages).
- (4) Use the \uparrow and \downarrow keys to select the page on which the desired item is shown, then check the running status information of that item.
- (5) Press the **RESET** key to go back to the menu screen.

Figure 3.13 shows an example of the LCD screen transition starting from Menu #4 "I/O Checking."

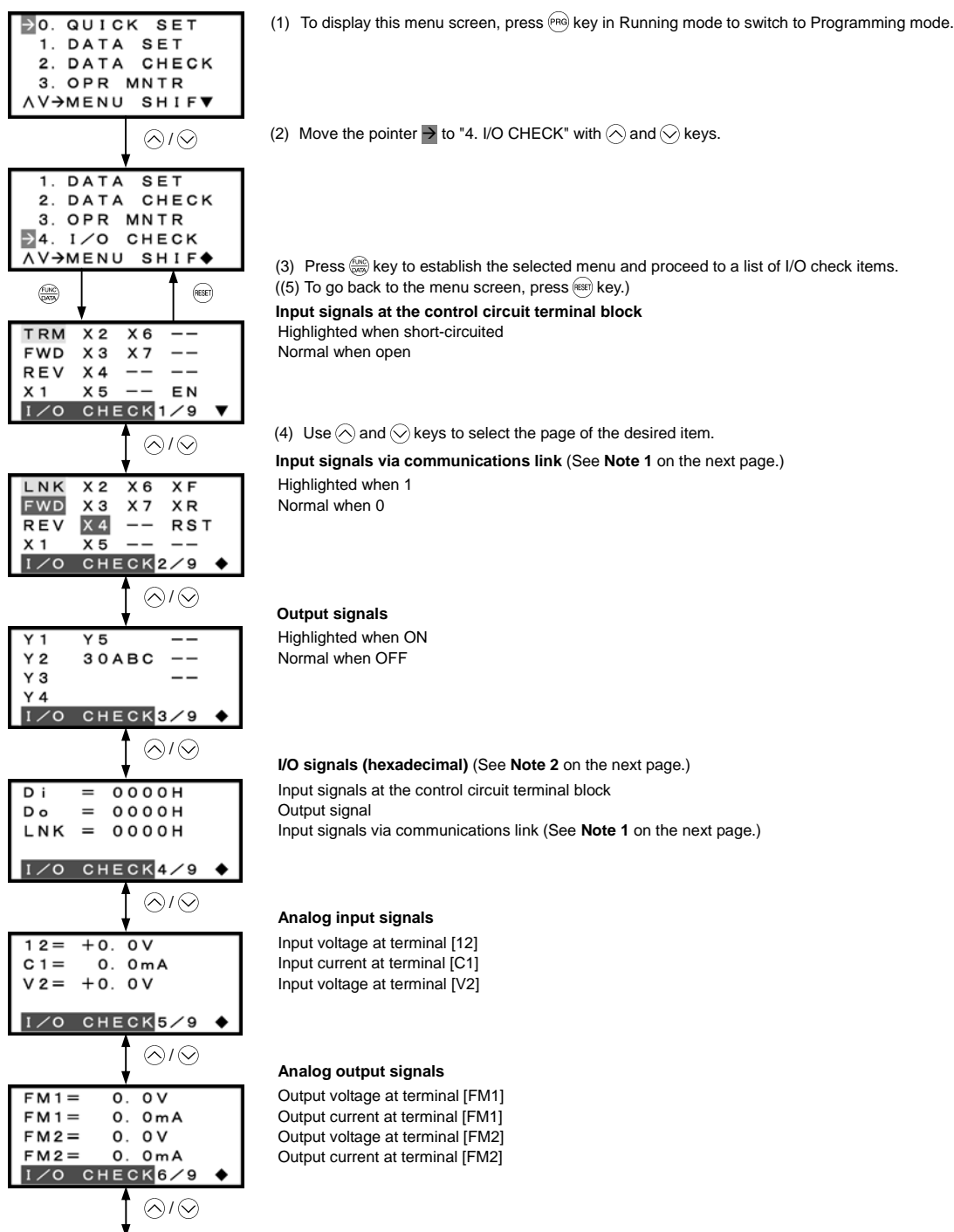

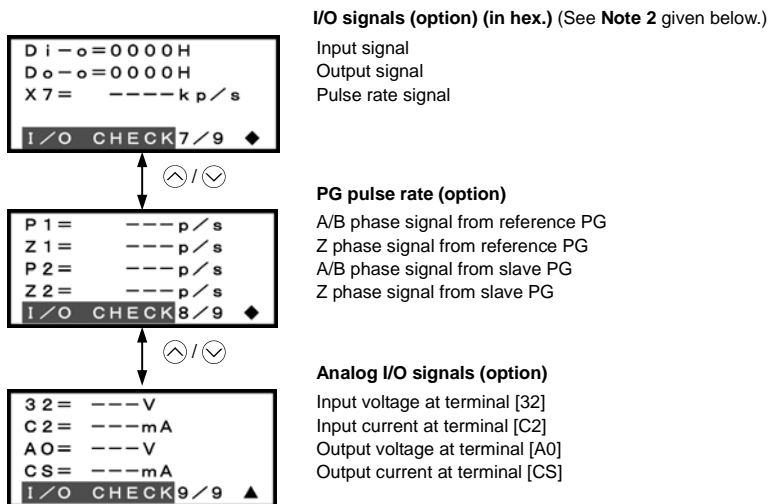

Common operation items

To access the target data, switch to the desired page using the \triangle and ∇ keys.

- ∇ : This page continues to the next page.
- \blacklozenge : This page is continued from the previous page and continues to the next page.
- \blacktriangle : This page is continued from the previous page.

Figure 3.13 Screen Transition for "I/O Checking"

Note 1 Input signal status on terminals via communications link

Input commands sent via the RS-485 communications link or other communications options can be displayed in two ways depending on setting of the function code S06: "Display with ON/OFF of the LED segment" or "In hexadecimal format." The content to be displayed is basically the same as that for the control I/O signal terminal status display; however, (XF), (XR), and (RST) are added as inputs. Note that under communications control, I/O display is in normal logic (Active-ON) (using the original signals that are not inverted).

Note 2 I/O signal status in hexadecimal

Each I/O terminal is assigned to one of the 16 binary bits (bit 0 through bit 15). An unassigned bit is interpreted as "0." The I/O status is thus collectively expressed as a four-digit, hexadecimal number (0 through F) as shown in Table 3.9.

Digital input terminals [FWD] and [[REV] are assigned to bits 0 and 1, [X1] through [X7] to bits 2 through 10, and [EN] to bit 11, respectively. Each bit assumes a value of "1" when the corresponding signal is ON and a value of "0" when it is OFF. For example, when signals [FWD] and [X1] are ON while all the other signals are OFF, the status is expressed as "0005H."

Digital output terminals [Y1] through [Y4] are assigned to bits 0 through 3. Each is given a value of "1" when it is short-circuited to [CMY], or a value of "0" when its circuit to [CMY] is open. The status of relay output terminal [Y5A/C] is assigned to bit 4, which assumes a value of "1" when the contact between [Y5A] and [Y5C] is closed. The status of relay output terminal [30A/B/C] is assigned to bit 8, which assumes a value of "1" when the contact between [30A] and [30C] is closed or "0" when the contact between [30B] and [30C] is closed. For example, when terminal [Y1] is ON, terminals [Y2] through [Y4] are OFF, the contact between [Y5A] and [Y5C] is opened, and the link between 30A and 30C is closed, the status is expressed as "0101H."

As in the control I/O signal terminal status display, the ON/OFF status of each input/output terminal signal of a digital input and output interface cards (option) is expressed in hexadecimal notation.

Digital input terminals [I1] through [I16] on a digital input interface card (option) are assigned to 16 binary bits (bit 0 through bit 15). Each bit assumes a value of "1" when the corresponding signal is ON and a value of "0" when it is OFF. Digital output terminals [O1] through [O8] on a digital output interface card (option) are assigned to eight binary bits (bit 0 through bit 7).

Table 3.9 Hexadecimal Notation

Data Displayed		Highest digit								Lowest digit							
Bit		15	14	13	12	11	10	9	8	7	6	5	4	3	2	1	0
Input signal		(RST)*	(XR)*	(XF)*	-	[EN]	-	-	[X7]	[X6]	[X5]	[X4]	[X3]	[X2]	[X1]	[REV]	[FWD]
Output signal		-	-	-	-	-	-	-	[30A/B/C]	-	-	-	[Y5A/C]	[Y4]	[Y3]	[Y2]	[Y1]
Option	DI	[I16]	[I15]	[I14]	[I13]	[I12]	[I11]	[I10]	[I9]	[I8]	[I7]	[I6]	[I5]	[I4]	[I3]	[I2]	[I1]
	DO	-	-	-	-	-	-	-	-	[O8]	[O7]	[O6]	[O5]	[O4]	[O3]	[O2]	[O1]
Example (input)	Binary	0	0	0	0	0	0	0	0	0	0	0	0	0	1	0	1
	Hex.	0005H															

-.: Not assigned

* (XF), (XR), (RST) are for communications.

Refer to "Note 1 Input status on terminals via communications link" given on the previous page.

3.4.6 Reading maintenance information -- Menu #5 "Maintenance Information" --

Menu #5 "Maintenance Information" in Programming mode shows information necessary for performing maintenance on the inverter.

Table 3.10 Maintenance Information Items

Page # in operation guide	Item	Symbol	Description
1	Cumulative run time	TIME	Shows the content of the cumulative power-ON time counter of the inverter. When the count exceeds 65,535 hours, the counter will be reset to "0" and start over again.
	DC link bus voltage	EDC	Shows the DC link bus voltage of the inverter main circuit.
	Max. temperature inside the inverter	TMPI	Shows the maximum temperature inside the inverter for every hour.
	Max. temperature of heat sink	TMPF	Shows the maximum temperature of the heat sink for every hour.
2	Max. effective current	Imax	Shows the maximum current in RMS for every hour.
	Capacitance of the DC link bus capacitor	CAP	Shows the current capacitance of the DC link bus capacitor in %, based on the capacitance when shipping as 100%. Refer to Chapter 7 "MAINTENANCE AND INSPECTION" for details.
	Cumulative motor run time	MTIM	Shows the cumulative run time of the motor. When the count exceeds 99,990 hours, the counter will be reset to "0" and start over again.
	Remaining time before the next maintenance for motor 1 Note 1)	REMT1	Shows the time remaining before the next maintenance, which is estimated by subtracting the cumulative run time of motor 1 from the maintenance interval specified by H78.

Table 3.10 Maintenance Information Items (Continued)

Page # in operation guide	Item	Symbol	Description
3	Cumulative run time of electrolytic capacitors on the printed circuit boards	TCAP	Shows the content of the cumulative time counter of the voltage application to the electrolytic capacitors on the printed circuit boards, which is calculated by multiplying the cumulative time count by the coefficient based on the surrounding temperature condition. The value in parentheses () denotes the service life of the capacitors, which should be used as a guide for replacement timing. Refer to Chapter 7 "MAINTENANCE AND INSPECTION" for details.
	Cumulative run time of the cooling fan	TFAN	Shows the content of the cumulative run time counter of the cooling fan. This counter does not work when the cooling fan ON/OFF control (function code H06) is enabled and the fan stops. The value in parentheses () denotes the service life of the fan, which should be used as a guide for replacement timing. Refer to Chapter 7 "MAINTENANCE AND INSPECTION" for details.
4	Number of startups Note 1)	NST	Shows the content of the motor 1 startup counter (i.e., the number of run commands issued). When the count exceeds 65,530 hours, the counter will be reset to "0" and start over again.
	Input watt-hour Note 2)	Wh	Shows the input watt-hours of the inverter. When the count exceeds 999,900 kWh, the counter will be reset to "0."
	Input watt-hour data Note 2)	PD	Shows the value expressed by "input watt-hour data (kWh) x function code E51." (The display range is from 0.001 to 9,999. Values exceeding 9,999 are expressed as 9,999.)
	Remaining startup times before the next maintenance for motor 1 Note 1)	REMN1	Shows the startup times remaining before the next maintenance, which is estimated by subtracting the number of startups from the preset startup count for maintenance specified by H79.
5	Number of RS-485 communications errors (COM port 1) Note 3)	NRR1	Shows the total number of errors that have occurred in RS-485 communication (COM port 1) after the power was turned ON.
	Error code of RS-485 communications error (COM port 1) Note 3), Note 4)		Shows the content of the latest error that has occurred in RS-485 communication (COM port 1) as an error code.
	Number of RS-485 communications errors (COM port 2) Note 3)	NRR2	Shows the total number of errors that have occurred in RS-485 communication (COM port 2) after the power was turned ON.
	Error code of RS-485 communications error (COM port 2) Note 3), Note 4)		Shows the content of the latest error that has occurred in RS-485 communication (COM port 2) as an error code.
	Count of option errors	NRO	Reserved.
	Option error code		Reserved.
6	ROM version of the inverter	MAIN	Shows the ROM version of the inverter as a 4-digit code.
	ROM version of the keypad	KP	Shows the ROM version of the keypad as a 4-digit code.

Table 3.10 Maintenance Information Items (Continued)

Page # in operation guide	Item	Symbol	Description
7	ROM version of option 1	OP1	Shows the ROM version of the option connected to the A-port as a 4-digit code.
	ROM version of option 2	OP2	Shows the ROM version of the option connected to the B-port as a 4-digit code.
	ROM version of option 3	OP3	Shows the ROM version of the option connected to the C-port as a 4-digit code.
8	Temperature inside the inverter (real-time value)	TMPIM	Shows the current temperature inside the inverter.
	Temperature of heat sink (real-time value)	TMPFM	Shows the current temperature of the heat sink inside the inverter.
	Lifetime of DC link bus capacitor (elapsed hours)	CAPEH	Shows the cumulative time during which a voltage is applied to the DC link bus capacitor. When the main power is shut down, the inverter automatically measures the discharging time of the DC link bus capacitor and corrects the elapsed time. The display method is the same as that for TCAP above.
	Lifetime of DC link bus capacitor (remaining hours)	CAPRH	Shows the remaining lifetime of the DC link bus capacitor, which is estimated by subtracting the elapsed time from the lifetime (10 years). The display method is the same as that for TCAP above.
9	Cumulative run time of motor 1	MTIM1	Shows the content of the cumulative power-ON time counter of the 1st motor. When the count exceeds 99,990, the counter will be reset to "0" and start over again.
	Cumulative run time of motor 2	MTIM2	Shows the content of the cumulative power-ON time counter of the 2nd motor. The display method is the same as that for MTIM1 above.
	Cumulative run time of motor 3	MTIM3	Shows the content of the cumulative power-ON time counter of the 3rd motor. The display method is the same as that for MTIM1 above.
	Cumulative run time of motor 4	MTIM4	Shows the content of the cumulative power-ON time counter of the 4th motor. The display method is the same as that for MTIM1 above.
10	Number of startups	NST1	Shows the content of the 1st motor startup counter (i.e., the number of run commands issued). Counter range: 0 to 65,530 times When the count exceeds 65,530, the counter will be reset to "0" and start over again.
	Number of startups 2	NST2	Shows the content of the 2nd motor startup counter (i.e., the number of run commands issued). The display method is the same as for NST1 above.
	Number of startups 3	NST3	Shows the content of the 3rd motor startup counter (i.e., the number of run commands issued). The display method is the same as for NST1 above.
	Number of startups 4	NST4	Shows the content of the 4th motor startup counter (i.e., the number of run commands issued). The display method is the same as for NST1 above.

Table 3.10 Maintenance Information Items (Continued)

Page # in operation guide	Item	Symbol	Description
11	Light alarm (Latest)	LALM1	Shows the factor of the latest light alarm as an alarm code. For details, refer to Chapter 6, Section 6.1 "Protective Functions."
	Light alarm (Last)	LALM2	Shows the factor of the last light alarm as an alarm code. For details, refer to Chapter 6, Section 6.1 "Protective Functions."
	Light alarm (2nd last)	LALM3	Shows the factor of the 2nd last light alarm as an alarm code. For details, refer to Chapter 6, Section 6.1 "Protective Functions."
	Light alarm (3rd last)	LALM4	Shows the factor of the 3rd last light alarm as an alarm code. For details, refer to Chapter 6, Section 6.1 "Protective Functions."
12	Number of option errors 1	NROA	Shows the total number of errors that have occurred in the option connected to the A-port.
	Option error factor 1		Shows the factor of the error that has occurred in the option connected to the A-port.
	Number of option errors 2	NROB	Shows the total number of errors that have occurred in the option connected to the B-port.
	Option error factor 2		Shows the factor of the error that has occurred in the option connected to the B-port.
	Number of option errors 3	NROC	Shows the total number of errors that have occurred in the option connected to the C-port.
	Option error factor 3		Shows the factor of the error that has occurred in the option connected to the C-port.

Note 1) Available for the 1st motor only even if the inverter has the motor switching function.

Note 2) To reset the input watt-hour and input watt-hour data to 0, set function code E51 to "0.000."

Note 3) "COM port 1" refers to the RJ-45 connector on the inverter; "COM port 2" is on the terminal block.

Note 4) For details of error codes, refer to the RS-485 Communication User's Manual.

Basic key operation

- (1) Turn the inverter ON. It automatically enters Running mode. In that mode, press the **PRG** key to switch to Programming mode and display the menu screen.
- (2) Move the pointer **→** to "5. MAINTENANC" with the **△** and **▽** keys.
- (3) Press the **FUNC DATA** key to establish the selected menu and proceed to a list of maintenance items (consisting of several pages).
- (4) Use the **△** and **▽** keys to select the page on which the desired item is shown, then check the maintenance data of that item.
- (5) Press the **RESET** key to go back to the menu screen.

Figure 3.14 shows an example of the LCD screen transition starting from Menu #5 "Maintenance Information."

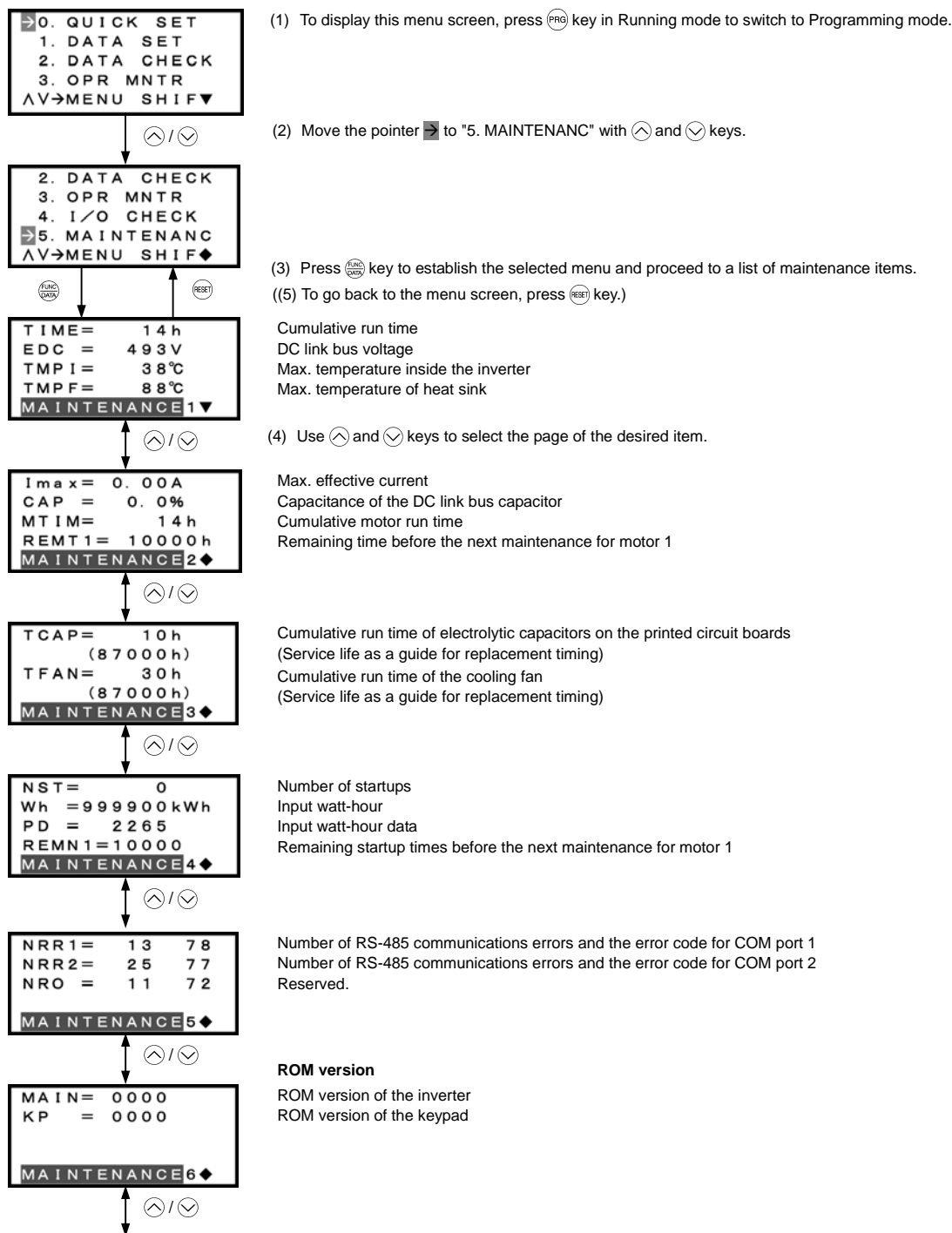

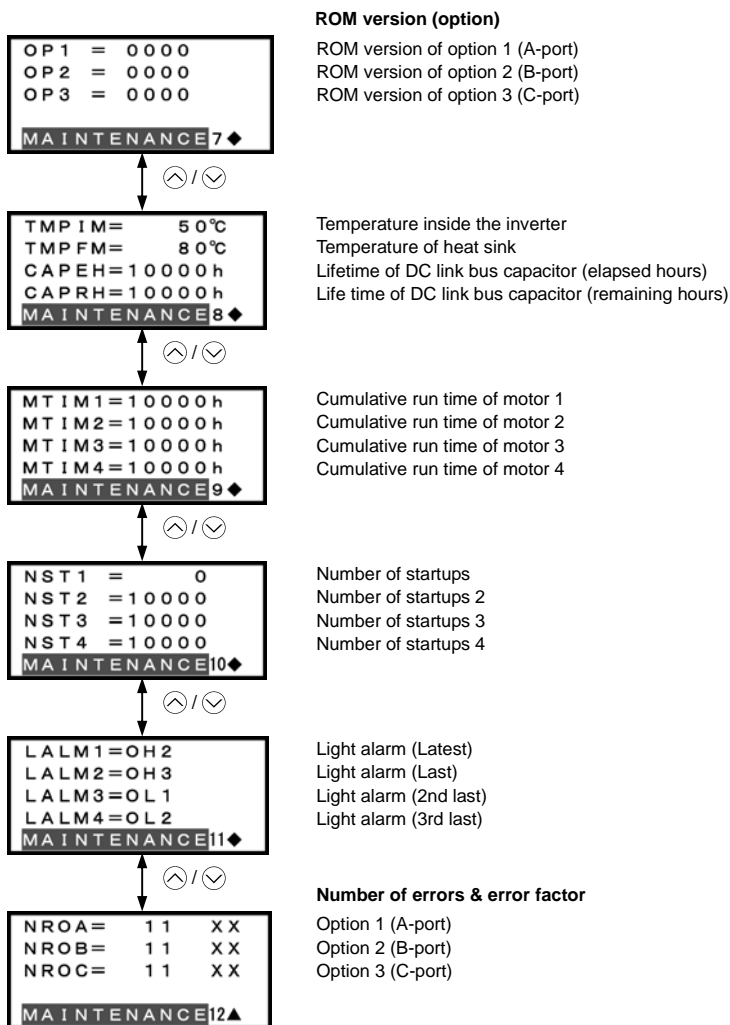

Common operation items

To access the target data, switch to the desired page using the ◀ and ▶ keys.

- ▼: This page continues to the next page.
- ◆: This page is continued from the previous page and continues to the next page.
- ▲: This page is continued from the previous page.

Figure 3.14 Screen Transition for "Maintenance Information"

3.4.7 Reading alarm information -- Menu #6 "Alarm Information" --

Menu #6 "Alarm Information" in Programming mode shows the causes of the past four alarms that triggered protective functions, as an alarm code. It is also possible to display the related alarm information on the current inverter conditions detected when the alarm occurred.

Basic configuration of screens

Figure 3.15 shows the LCD screen transition for Menu #6 "Alarm Information."

A hierarchy exists among those screens that are shifted in the order of "menu screen," "list of alarms," and "detailed alarm info screens."

On the "list of alarms," you can view the current alarm and alarm history, and on the "detailed alarm info screens," the information on the inverter running status at the time the alarm occurred.

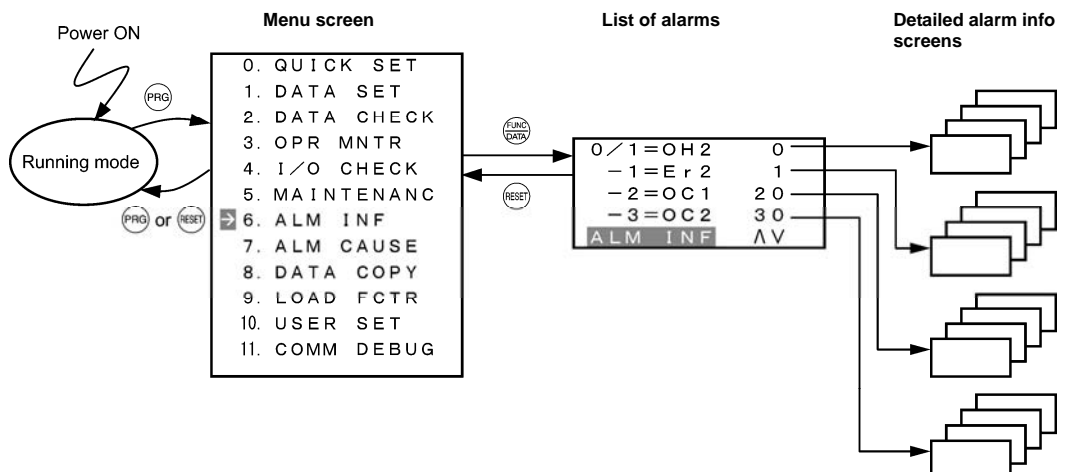
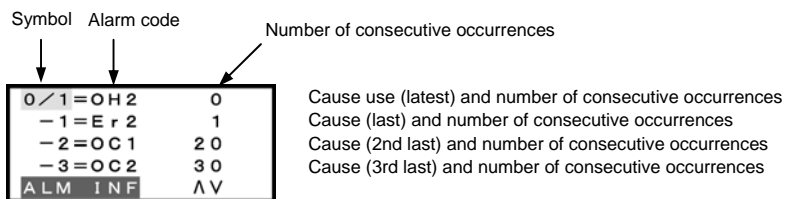

Figure 3.15 Configuration of Screens for "Alarm Information"

Screen samples for viewing alarm info

The list of alarms shows the current alarm and alarm history.



Page # in operation guide	Item	Symbol	Description
—	Alarm history (latest)	0/1	Alarm code and the number of consecutive occurrences
	Alarm history (last)	-1	Alarm code and the number of consecutive occurrences
	Alarm history (2nd last)	-2	Alarm code and the number of consecutive occurrences
	Alarm history (3rd last)	-3	Alarm code and the number of consecutive occurrences

On the "detailed alarm info screens," you can view the information on the inverter running status at the time an alarm occurred. Table 3.11 lists the alarm information displayed on the LCD monitor.

Table 3.11 Alarm Information Items

Page # in operation guide	Item	Symbol	Description
1	Output frequency	Fot1	Output frequency (before slip compensation)
	Output current	Iout	Output current
	Output voltage	Vout	Output voltage
	Calculated torque	TRQ	Calculated motor output torque
2	Reference frequency	Fref	Frequency specified by frequency command
	Rotational direction	FWD REV (Blank)	Forward Reverse Stopped
	Current limit	IL	Current limiting
	Undervoltage Voltage limit	LU VL	Undervoltage detected Voltage limiting
	Torque limit	TL	Torque limiting
	Cumulative run time	TIME	Shows the content of the cumulative power-ON time counter of the inverter. When the count exceeds 65,535 hours, the counter will be reset to "0" and start over again.
	Speed limit	SL	Speed limiting
	Motor being selected	M1-M4	Motor 1 to 4
3	Drive control	VF DTV VF-SC VF-PG VF-SL VC-PG	V/f control without slip compensation Dynamic torque vector control V/f control with slip compensation Dynamic torque vector control with speed sensor Vector control without speed sensor Vector control with speed sensor
	Number of startups	NST	Shows the content of the motor startup counter (i.e., the number of run commands issued). When the count exceeds 65,530, the counter will be reset to "0" and start over again.
	DC link bus voltage	EDC	Shows the DC link bus voltage of the inverter main circuit.
	Temperature inside the inverter	TMPI	Shows the temperature inside the inverter.
4	Max. temperature of heat sink	TMPF	Shows the temperature of the heat sink.
	Input signals on the control circuit terminal block	TRM	Shows the ON/OFF state of input signals on terminals [FWD], [REV], [X1] to [X7], and [EN] (Highlighted when short-circuited; normal when open)
	Input signals via communications link	LNK	Shows the input signal state of function code S06 (Communication). [FWD], [REV], [X1] to [X7], (XF), (XR), (RST) (Highlighted when 1; normal when 0)
	Output signals	-	Shows the output signal state on terminals [Y1] to [Y4], [Y5A/C], [30A/B/C].
7	Multiple alarm 1	3	Simultaneously occurring alarm codes (1) ("----" is displayed if no alarm has occurred.)
	Multiple alarm 2	2	Simultaneously occurring alarm codes (2) ("----" is displayed if no alarm has occurred.)
	Error sub-code	SUB	Secondary error code for alarms.
	Detected speed	SPEED	Detected speed value

 The information of the first alarm is saved as "Alarm history (last)" (Symbol: -1), and that of the latest alarm is retained as "Alarm history (latest)" (Symbol: 0/1).

Basic key operation

- (1) Turn the inverter ON. It automatically enters Running mode. In that mode, press the **(PRG)** key to switch to Programming mode and display the menu screen.
- (2) Move the pointer **→** to "6. ALM INF" with the **(↑)** and **(↓)** keys.
- (3) Press the **(FUNC DATA)** key to establish the selected menu and proceed to a list of alarms that displays alarm history on the past four alarms (alarm code and the number of occurrences for each alarm).
- (4) Use the **(↑)** and **(↓)** keys to select the desired alarm and display its detailed information.
- (5) Press the **(FUNC DATA)** key to display the alarm code on the LED monitor and the detailed alarm information (consisting of several pages) on the current inverter conditions detected when the alarm occurred on the LCD monitor.
- (6) Use the **(↑)** and **(↓)** keys to select the page on which the desired item is shown, then check the detailed data of that item.
- (7) Press the **(RESET)** key to go back to a list of alarms.
- (8) Press the **(RESET)** key again to go back to the menu screen.

Figure 3.16 shows an example of the LCD screen transition starting from Menu #6 "Alarm Information."

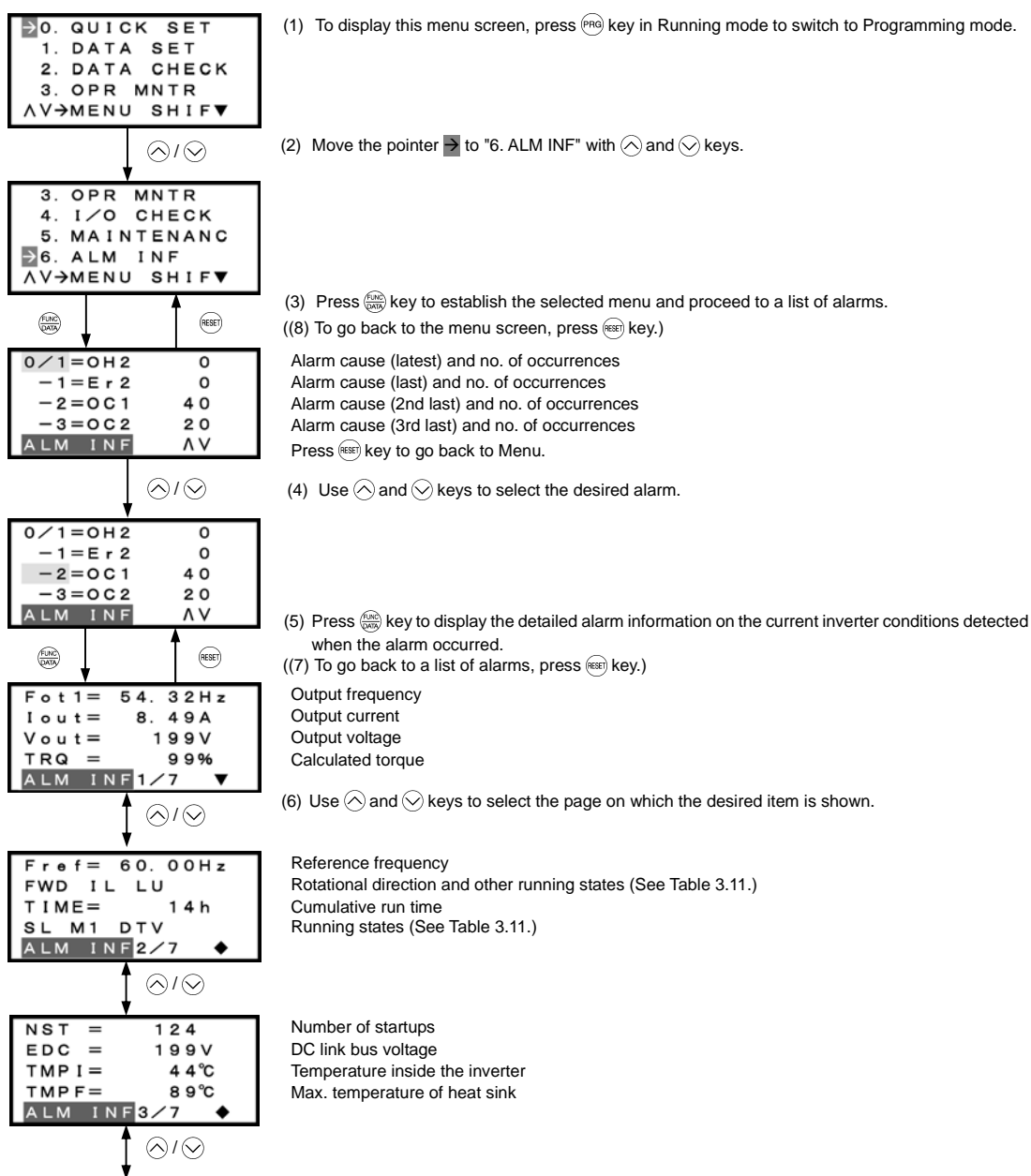

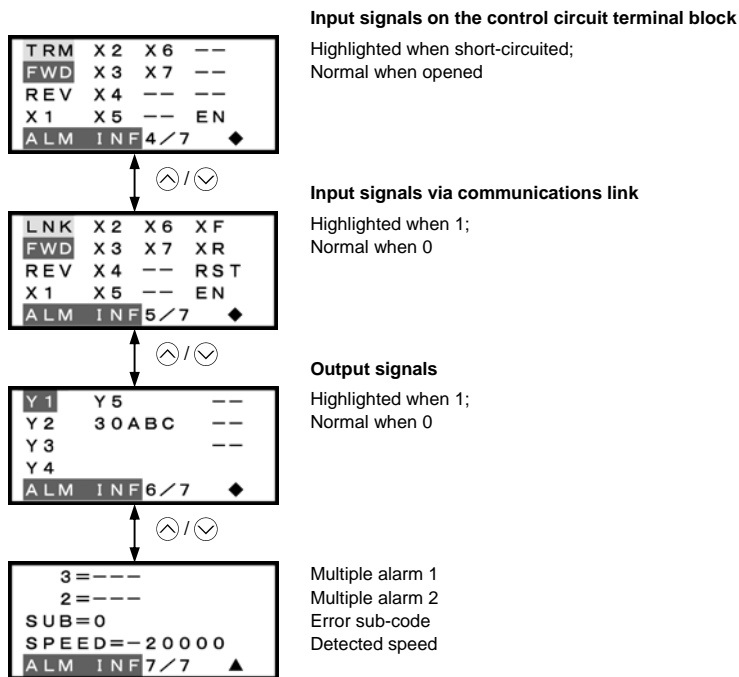

Common operation items

To access the target data, switch to the desired page using the ⬆️ and ⬇️ keys.

▼: This page continues to the next page.

◆: This page is continued from the previous page and continues to the next page.

▲: This page is continued from the previous page.

Figure 3.16 Screen Transition for "Alarm Information"

3.4.8 Viewing causes of alarm -- Menu #7 "Alarm Cause" --

Menu #7 "Alarm Cause" in Programming mode shows the causes of the past four alarms that triggered protective functions, as an alarm code. It also shows the cause of each alarm.

Basic configuration of screens

Figure 3.17 shows the LCD screen transition for Menu #7 "Alarm Cause."

A hierarchy exists among those screens that are shifted in the order of "menu screen," "list of alarms," and "alarm cause screens."

On the "alarm cause screen" of the desired alarm code, you can view the cause of the alarm.

The list of alarms is the same as that for Menu #6 "Alarm Information."

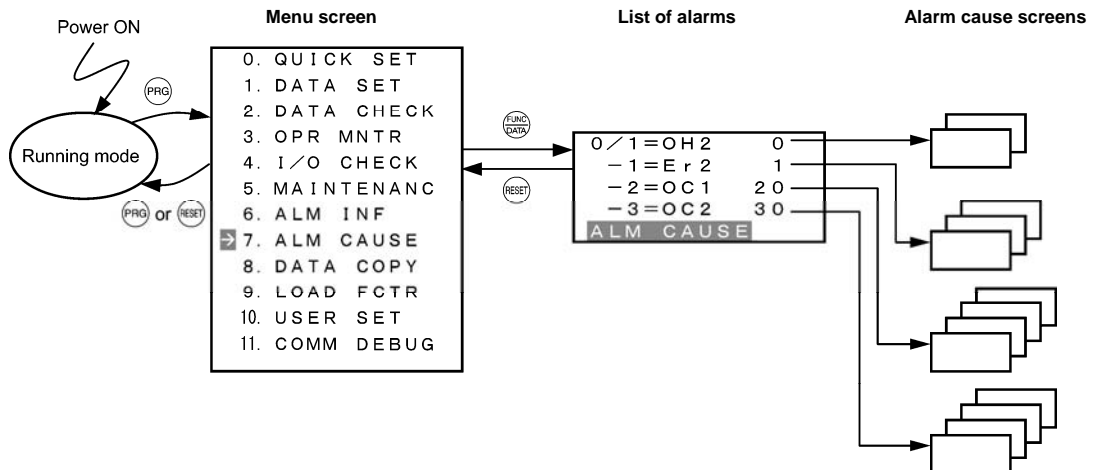
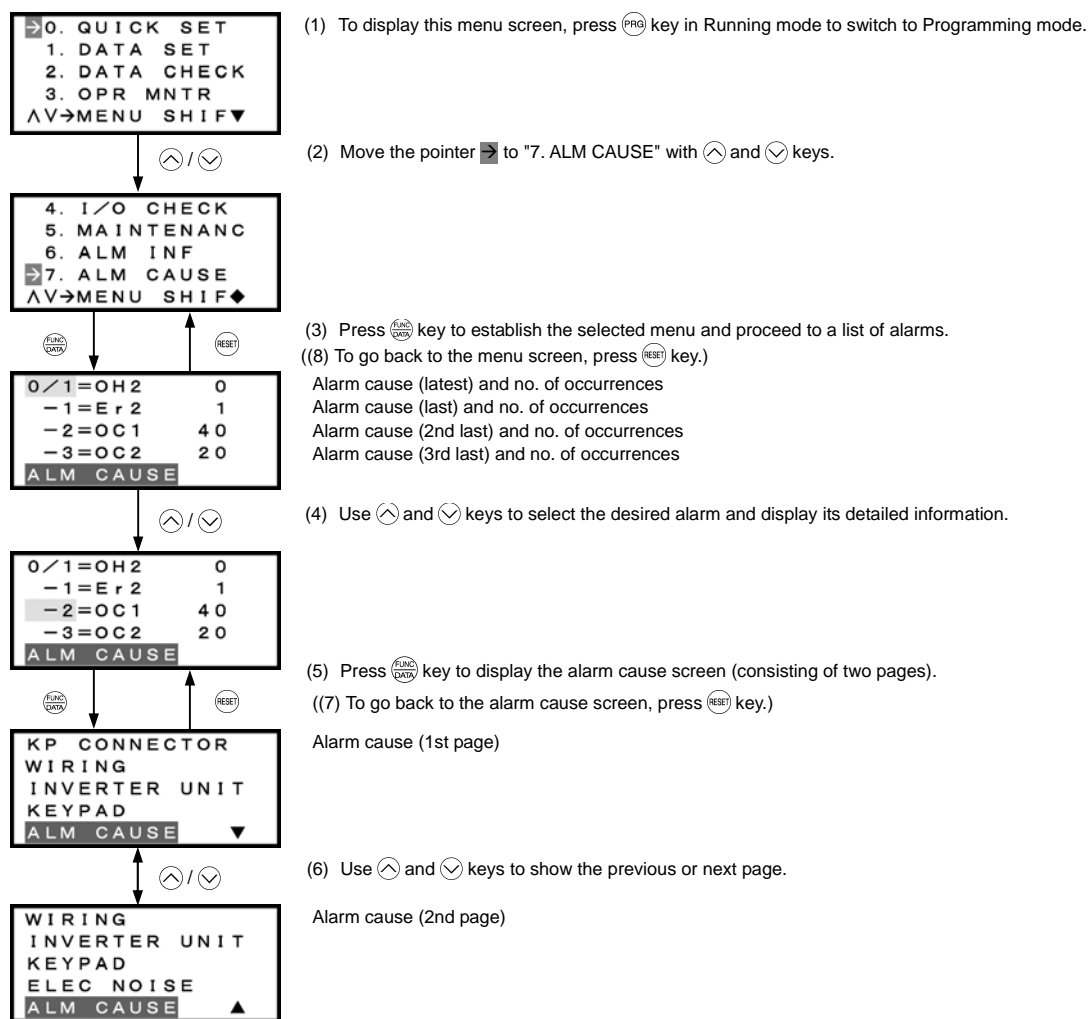

Figure 3.17 Configuration of Screens for "Alarm Cause"

Basic key operation

- (1) Turn the inverter ON. It automatically enters Running mode. In that mode, press the **PRG** key to switch to Programming mode and display the menu screen.
- (2) Move the pointer **→** to "7. ALM CAUSE" with the **△** and **▽** keys.
- (3) Press the **FUNC DATA** key to establish the selected menu and proceed to a list of alarms that displays alarm history on the past four alarms (alarm code and the number of occurrences for each alarm).
- (4) Use the **△** and **▽** keys to select the desired alarm and display its detailed information.
- (5) Press the **FUNC DATA** key to display the alarm code on the LED monitor and the alarm cause screen (consisting of two pages) on the LCD monitor.
- (6) Use the **△** and **▽** keys to show the previous or next page.
- (7) Press the **RESET** key to go back to a list of alarms.
- (8) Press the **RESET** key again to go back to the menu screen.

Figure 3.18 shows an example of the LCD screen transition starting from Menu #7 "Alarm Cause."



Common operation items

To access the target data, switch to the desired page using the **△** and **▽** keys.

▼: This page continues to the next page.

◆: This page is continued from the previous page and continues to the next page.

▲: This page is continued from the previous page.

Figure 3.18 Screen Transition for "Alarm Cause"

3.4.9 Data copying -- Menu #8 "Data Copying" --

Menu #8 "Data Copying" in Programming mode provides "Read," "Write," and "Verify," "Check," and "Protect" functions, enabling the following applications. The keypad can hold three sets of function code data in its internal memory to use for three different inverters.

- (a) Reading function code data already configured in an inverter and then writing that function code data altogether into another inverter.
- (b) Copying the function code data saved in the inverter memory into the keypad memory for backup.
- (c) Saving function code data in the keypad as master data for data management; that is, saving more than one set of function code data in the keypad and writing a set of data suited to the machinery into the target inverter.

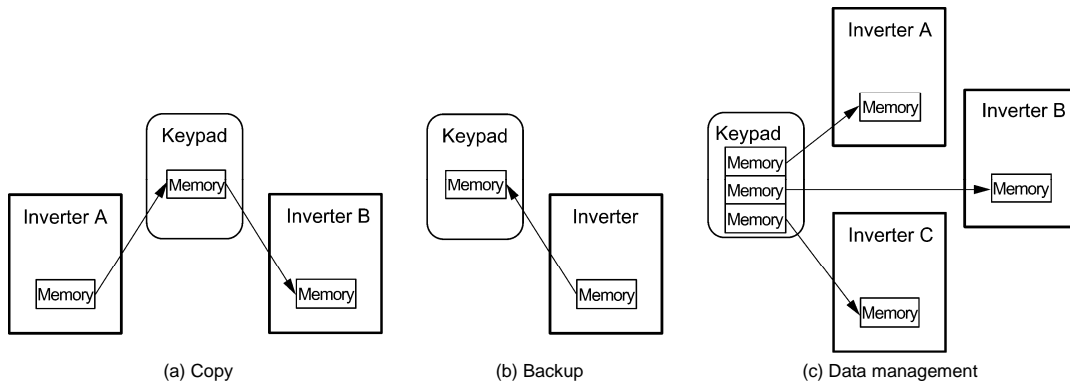

Table 3.12 details the data copying functions.

Table 3.12 List of Data Copying Functions

Functions	Description
Read	Reads out function code data from the inverter memory and stores it into the keypad memory.
Write	Writes the data held in the selected area of the keypad memory into the target inverter memory.
Verify	Verifies the data held in the keypad memory against that in the inverter memory.
Check	Displays the inverter type and its function code data held in each of the three areas of the keypad memory.
Protect	Protects the function code data held in the keypad memory from being overwritten with the data held in the inverter memory.

Target items that can be copied by this function are:

- Function code data
- Function code items subject to Quick Setup, and
- Digital frequency commands and PID commands.

Basic configuration of screens

Figure 3.19 shows the LCD screen transition for Menu #8 "Data Copying."

A hierarchy exists among those screens that are shifted in the order of "menu screen," "list of copy functions," and "memory area selection screen."

On the "memory area selection screen," you can select the target area (1, 2, or 3) of the keypad memory and proceed to the subsequent screens.

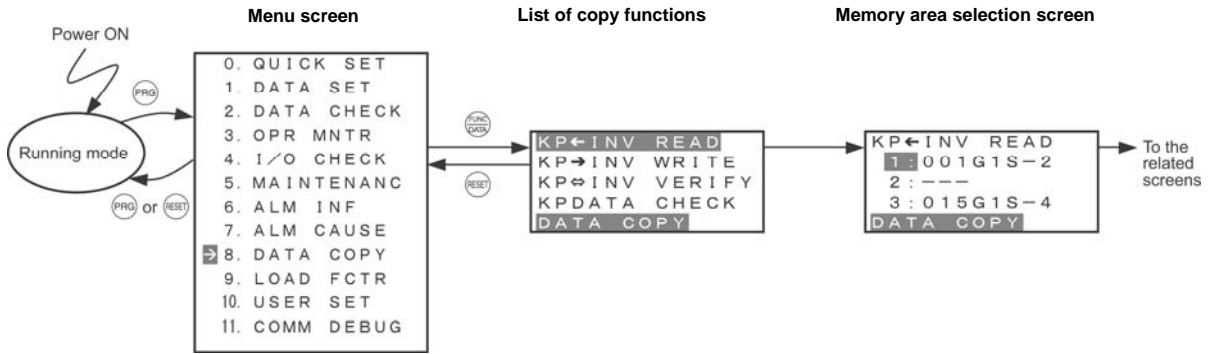

Figure 3.19 Configuration of Screens for "Data Copying"

(1) Read



To display this menu screen, press **PRG** key in Running mode to switch to Programming mode.



Move the pointer **→** to the "8. DATA COPY" with **↑** and **↓** keys.

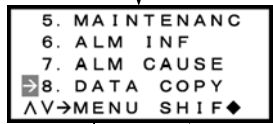

Press **PRG** key to establish the selected menu and proceed to a list of copy functions.

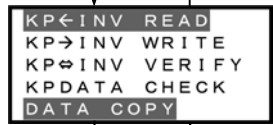

List of copy functions

Use **↑** and **↓** keys to select READ.



Press **PRG** key to establish the selected function.

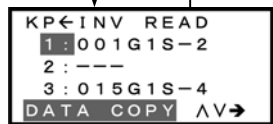

Memory area selection screen

Use **↑** and **↓** keys to select the target area (1, 2, or 3) of the keypad memory to save data read out from the inverter memory into that area.

To go back to a list of copy functions, press **RESET** key.

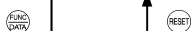

Press **PRG** key to establish the target area.

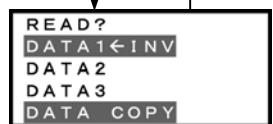

Confirmation screen

This screen is to confirm whether to overwrite the data currently held in this area of the keypad memory with data read out from the inverter memory.

To go back to the data selection screen, press **RESET** key.



If OK, press **PRG** key to start reading data from the inverter memory.

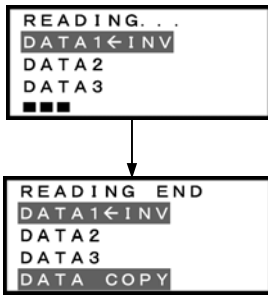

"In progress" screen

A bar indicating progress appears in the bottom.

Upon completion of reading, the completion screen automatically appears.

Completion screen

This screen shows that reading has completed successfully.

To go back to a list of copy functions, press (RESET) key.

Figure 3.20 Screen Transition for "Reading"

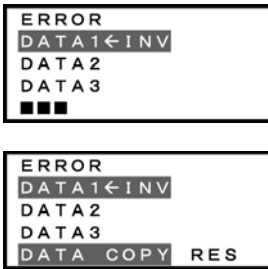

Pressing (PRG) or (RESET) key when reading is in progress cancels the operation and shows this ERROR screen. (See Note below.) It deletes all data held in the keypad memory.

If a communications error occurs between the keypad and the inverter when reading is in progress, this ERROR screen appears.

Figure 3.21 Error Screens for "Reading"

Note If an ERROR screen or an ERROR Ver. screen appears, press the (RESET) key to reset the error condition. The screen returns to a list of copy functions.

(2) Write

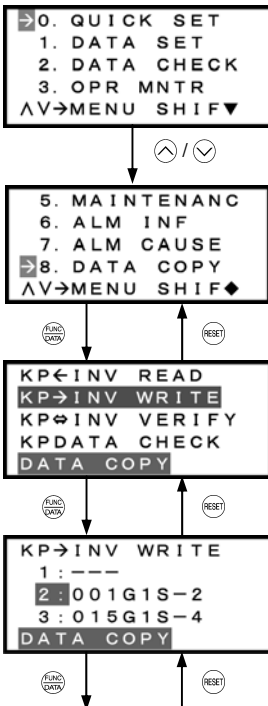

To display this menu screen, press (PRG) key in Running mode to switch to Programming mode.

Move the pointer → to "8. DATA COPY" with (▲) and (▼) keys.

Press (FUNC/DATA) key to establish the selected menu and proceed to a list of copy functions.

List of copy functions

Use (▲) and (▼) keys to select WRITE.

Press (FUNC/DATA) key to establish the selected function.

Memory area selection screen

Use (▲) and (▼) keys to select the target area (1, 2, or 3) of the keypad memory to write data held in that area into the inverter memory.

To go back to a list of copy functions, press (RESET) key.

Press (FUNC/DATA) key to establish the target area.

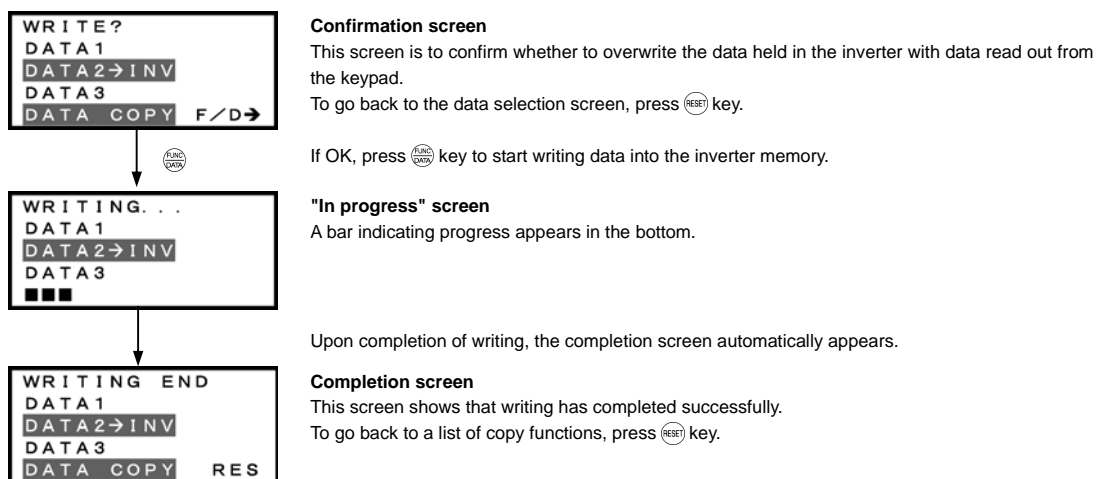

Figure 3.22 Screen Transition for "Writing"

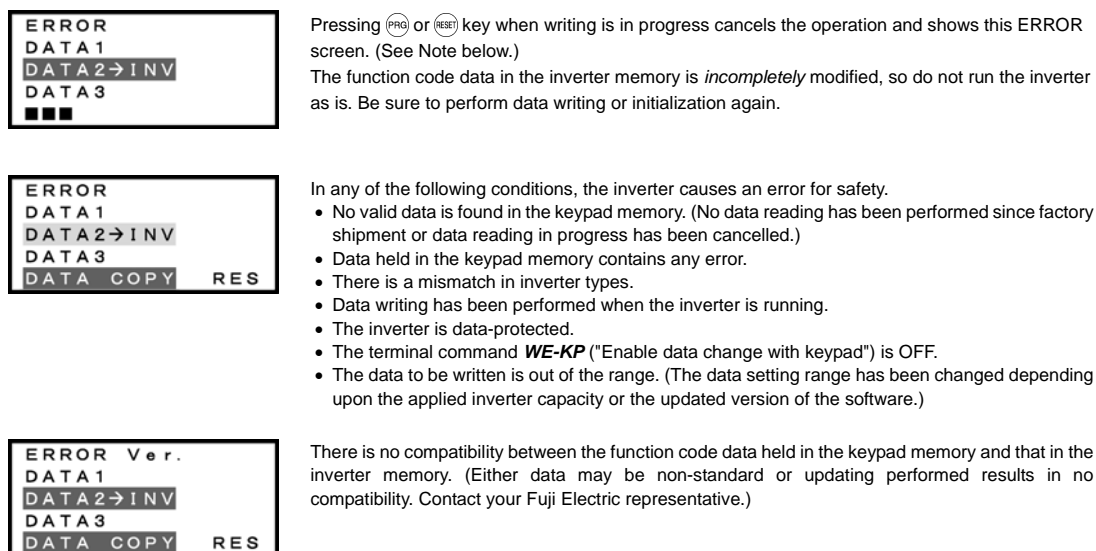
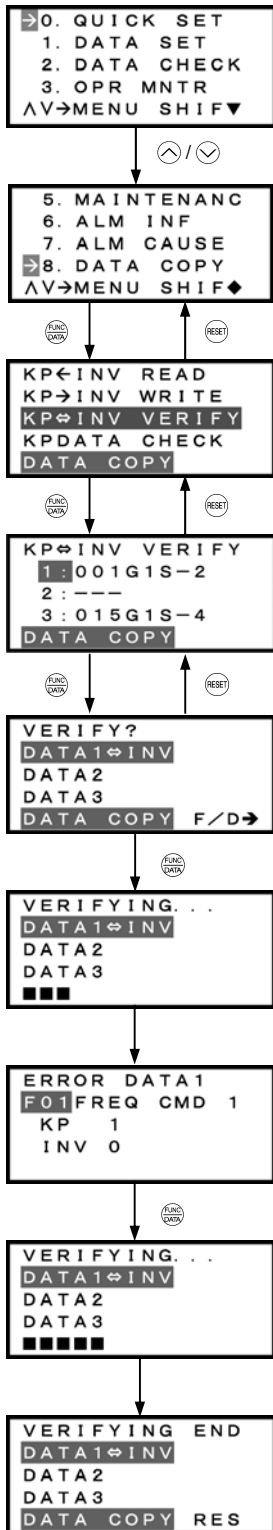

Figure 3.23 Error Screens for "Writing"

Note If an ERROR screen or an ERROR Ver. screen appears, press the key to reset the error condition. The screen returns to a list of copy functions.

(3) Verify



To display this menu screen, press PRG key in Running mode to switch to Programming mode.

Move the pointer \rightarrow to "8. DATA COPY" with \uparrow and \downarrow keys.

Press FUNC DATA key to establish the selected menu and proceed to a list of copy functions.

List of copy functions
Use \uparrow and \downarrow keys to select VERIFY.

Press FUNC DATA key to establish the selected function.

Memory area selection screen
Use \uparrow and \downarrow keys to select the target area (1, 2, or 3) of the keypad memory for verification.
To go back to a list of copy functions, press RESET key.

Press FUNC DATA key to establish the target area.

Confirmation screen
This screen is to confirm whether to proceed to verification.
To go back to the data selection screen, press RESET key.

If OK, press FUNC DATA key to start verification.

"In progress" screen
A bar indicating progress appears in the bottom.

When a mismatch is found, verification is halted with the function code and its data displayed on the LCD monitor. To resume verification from the next function code, press FUNC DATA key again.

To resume verification, press FUNC DATA key.

"In progress" screen
A bar indicating progress appears in the bottom.

Upon completion of verification, the completion screen automatically appears.

Completion screen
This screen shows that verification has completed successfully.
To go back to a list of copy functions, press RESET key.

Figure 3.24 Screen Transition for "Verify"

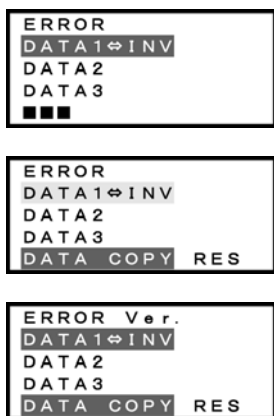

Pressing (PRG) or (RESET) key when verification is in progress cancels the operation and shows this ERROR screen. (See Note below.) The verification is forcibly terminated.

If no valid data is stored in the keypad memory, this ERROR screen appears. (See Note below.)

There is no compatibility between the function code data held in the keypad memory and that in the inverter memory. (Either data may be non-standard or updating performed results in no compatibility. Contact your Fuji Electric representative.)

Figure 3.25 Error Screen for "Verify"

Note If an ERROR screen or an ERROR Ver. screen appears, press the (RESET) key to reset the error condition. The screen returns to a list of copy functions.

(4) Check

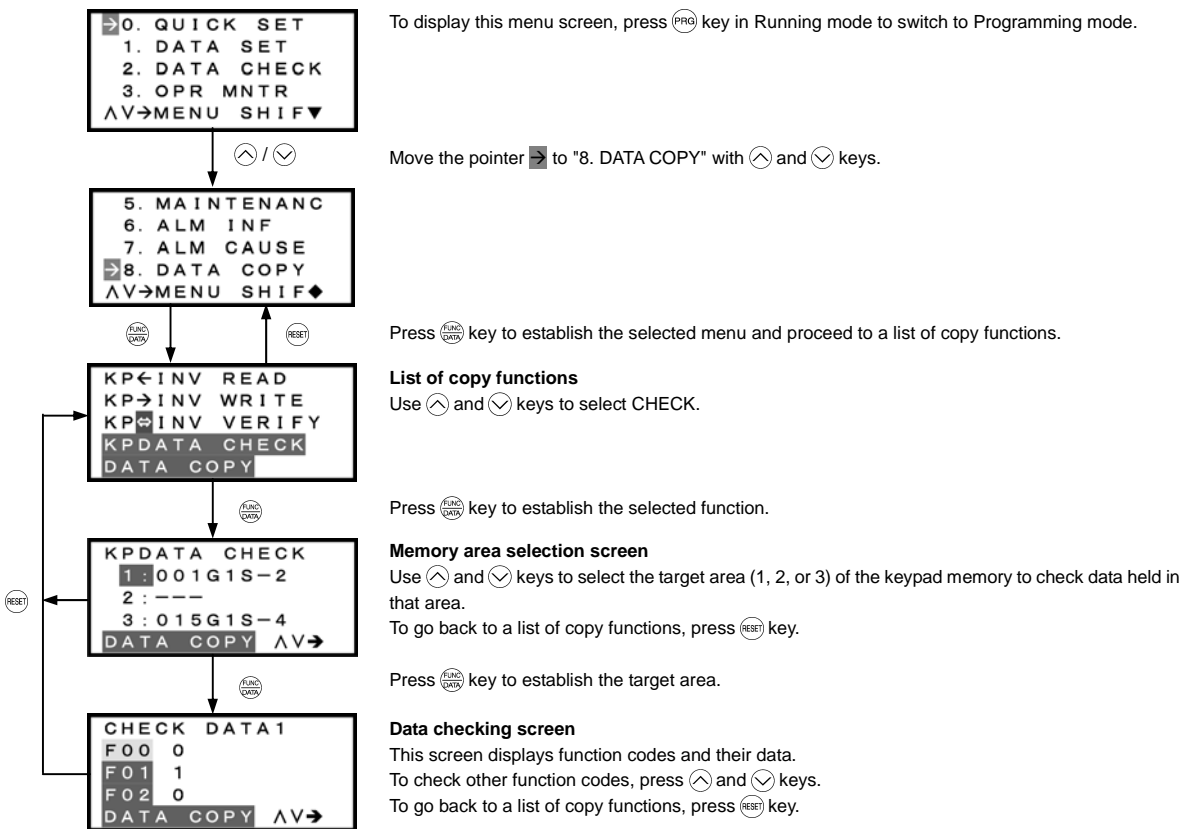
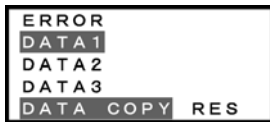

Figure 3.26 Screen Transition for "Data Checking"



If no valid data is stored in the keypad memory, this ERROR screen appears. (See Note below.)

Figure 3.27 Error Screen for "Data Checking"

Note If an ERROR screen appears, press the **RESET** key to reset the error condition. The screen returns to a list of copy functions.

(5) Protect

Function code data can be protected from unexpected modifications. Enable the data protection on the "Reading" screen.

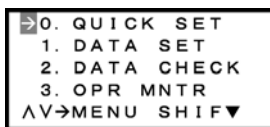

To display this menu screen, press **PRG** key in Running mode to switch to Programming mode.



Move the pointer **➔** to "8. DATA COPY" with **▲** and **▼** keys.

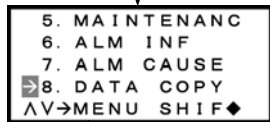

Press **FUNC/DATA** key to establish the selected menu and proceed to a list of copy functions.

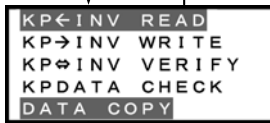

List of copy functions
Use **▲** and **▼** keys to select READ.



Press **FUNC/DATA** key to establish the selected function.

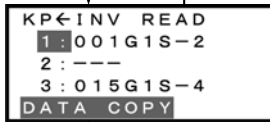

Memory area selection screen
Use **▲** and **▼** keys to select the target area (1, 2, or 3) of the keypad memory to protect data held in that area.

To go back to a list of copy functions, press **RESET** key.



Hold down **SHIFT** key for at least five seconds.

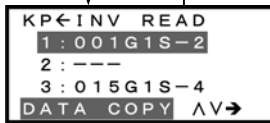

Completion screen
The memory area number and the inverter type are highlighted, indicating that the corresponding data is protected.

To go back to a list of copy functions, press **RESET** key.

Note To disable the data protection, press the **SHIFT** key for at least five seconds in the same procedure shown above. The screen returns to the normal state (not highlighted), indicating that the selected data is not protected.

Figure 3.28 Screen Transition for "Data Protection"

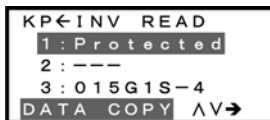

In the process of reading, selecting protected data and pressing the **FUNC/DATA** key displays the "Protected" (indicating that the data cannot be copied) as shown at left and returns to the normal display.

Figure 3.29 Warning Against Selecting Protected Data

3.4.10 Measuring load factor -- Menu #9 "Load Factor Measurement" --

Menu #9 "Load Factor Management" in Programming mode is used to measure the maximum output current, the average output current, and the average braking power. Two types of measurement modes are available as listed below.

Table 3.13 Measurement Modes

Measurement Mode	Description
Limited duration measurement mode	Measuring load factors for a limited duration (hours).
Start-to-stop measurement mode*	Measuring load factors from the start to stop of running.

* Once the inverter enters the start-to-stop measurement mode when it is running, measurement continues until the stop of the inverter. Once it enters the mode when it is stopped, measurement starts at the next start of the inverter and continues until the stop of the inverter.

(1) Limited duration measurement mode

Basic key operation

- (1) Turn the inverter ON. It automatically enters Running mode. In that mode, press the **PRG** key to switch to Programming mode and display the menu screen.
- (2) Move the pointer \rightarrow to "9. LOAD FCTR" with the \uparrow and \downarrow keys.
- (3) Press the **FUNC DATA** key to establish the selected menu and proceed to the measurement mode selection screen.
- (4) Select HOURS SET (Limited duration measurement mode) with the \uparrow and \downarrow keys.
- (5) Press the **FUNC DATA** key to establish the selected measurement mode.
- (6) Specify the measurement duration (default: 1 hour) with the \uparrow , \downarrow , and **SHIFT** keys. For details, refer to the screen transition in Figure 3.30.
- (7) Press the **FUNC DATA** key to establish the specified duration and start measurement.
- (8) Press the **RESET** key to go back to the mode selection screen.
- (9) Press the **RESET** key again to go back to the menu screen.

Figure 3.30 shows an example of the LCD screen transition starting from Menu #9 "Load Factor Measurement."

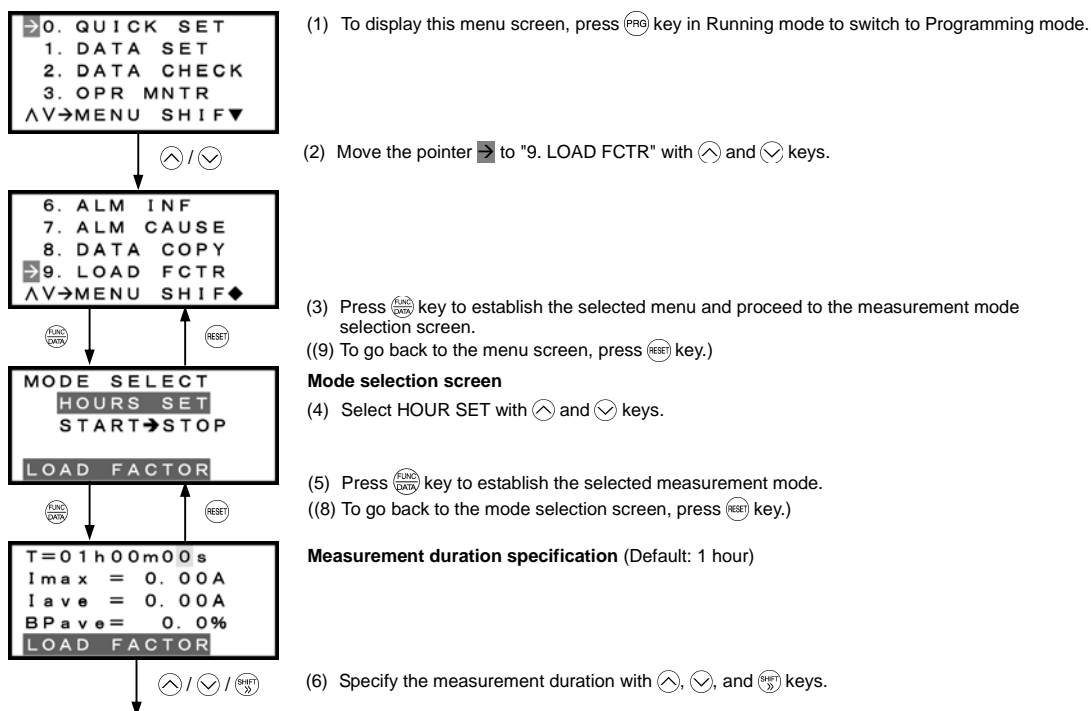

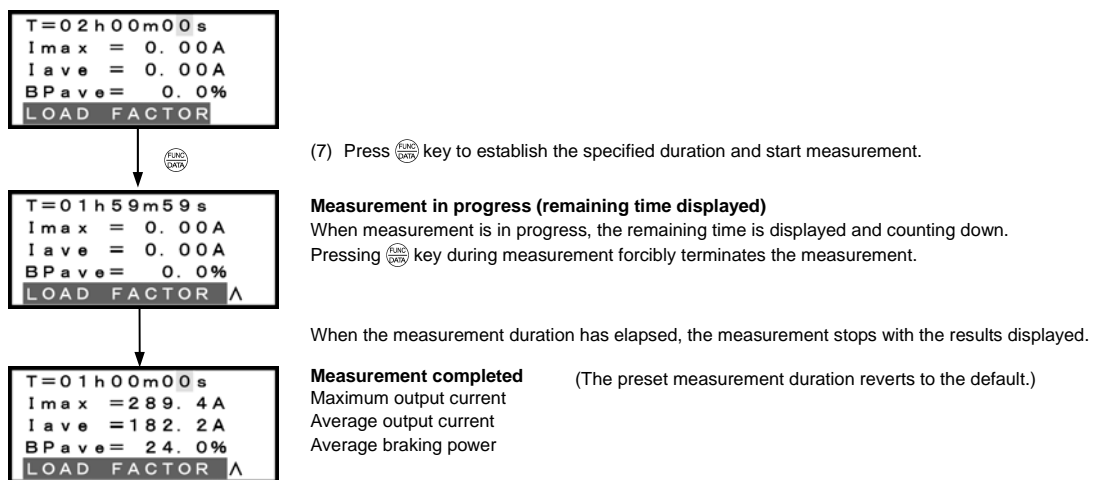

Figure 3.30 Screen Transition for "Load Factor Measurement" (Limited duration measurement mode)

(2) Start-to-stop measurement mode

Basic key operation

- (1) Turn the inverter ON. It automatically enters Running mode. In that mode, press the **PRG** key to switch to Programming mode and display the menu screen.
- (2) Move the pointer \rightarrow to "9. LOAD FCTR" with the \wedge and \vee keys.
- (3) Press the **FUNC DATA** key to establish the selected menu and proceed to the measurement mode selection screen.
- (4) Select START \rightarrow STOP (Start-to-stop measurement mode) with the \wedge and \vee keys.
- (5) Press the **FUNC DATA** key to establish the selected measurement mode.
- (6) On the confirmation screen, press the **FUNC DATA** key to switch to standby for measurement.
- (7) Wait for a run command to enter. For details, refer to the screen transition in Figure 3.31. Upon receipt of a run command, measurement starts.
- (8) Press the **RESET** key to go back to the mode selection screen.
- (9) Press the **RESET** key again to go back to the menu screen.

Figure 3.31 shows an example of the LCD screen transition starting from Menu #9 "Load Factor Measurement."

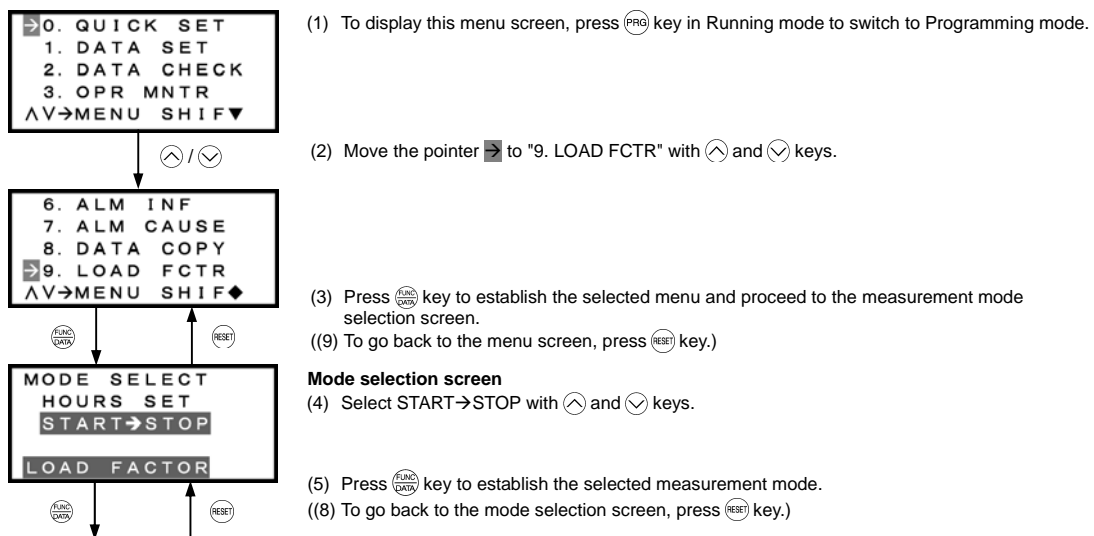

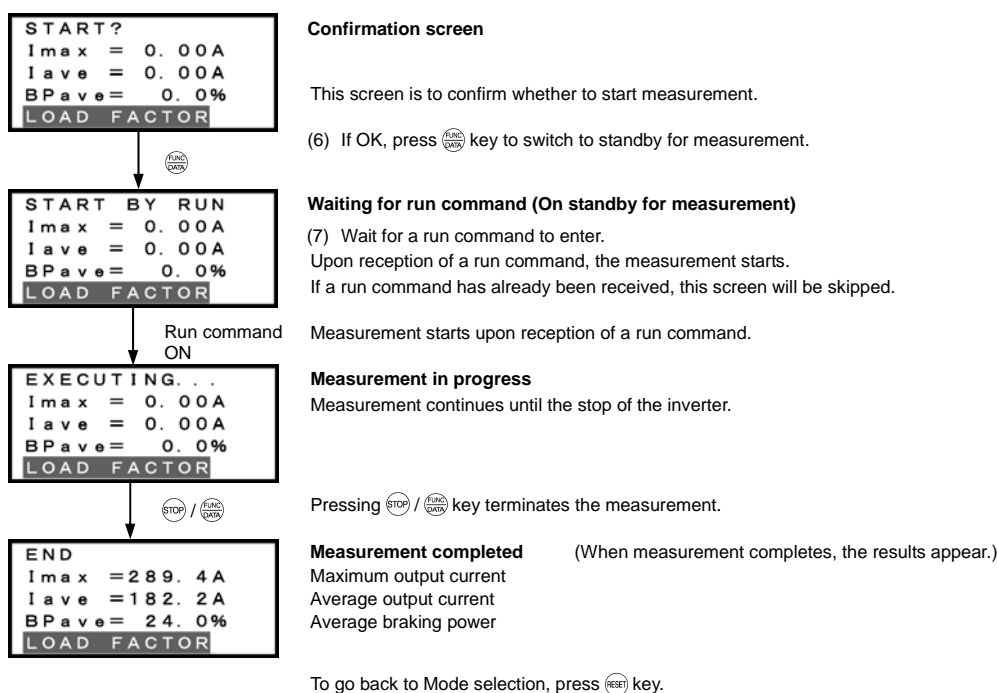

Figure 3.31 Screen Transition for "Load Factor Measurement" (Start-to-stop measurement mode)



Going back to Running mode

When measurement of the load factor is in progress, pressing the **PRG** key switches the inverter to Running mode, and pressing the **RESET** key, to the mode selection screen. This switching does not interrupt measurement.

Selecting the "9: LOAD FCTR" menu on the menu screen again allows you to confirm whether or not measurement is in progress.

After measurement has completed, pressing the **FUNC (START)** key on the mode selection screen displays the measurement results.

Screen when measurement is in progress



Note Turning the inverter OFF clears the measurement result.

3.4.11 Changing function codes covered by Quick Setup -- Menu #10 "User Setting" --

Menu #10 "User Setting" in Programming mode is used to add or delete function code to/from the set of function codes registered for Quick Setup.

Basic key operation

- (1) Turn the inverter ON. It automatically enters Running mode. In that mode, press the **PRG** key to switch to Programming mode and display the menu screen.
- (2) Move the pointer \rightarrow to "10. USER SET" with the \uparrow and \downarrow keys.
- (3) Press the **FUNC DATA** key to establish the selected menu and proceed to a list of function codes.
- (4) Select a function code to be added, using the \uparrow and \downarrow keys.
Function codes whose names are not highlighted are not registered for Quick Setup. For addition, select a function code whose name is not highlighted.
- (5) Press the **FUNC DATA** key to add the selected function code.
- (6) Select a function code to be deleted, using the \uparrow and \downarrow keys.
Function codes whose names are highlighted are registered for Quick Setup. For deletion, select a function code whose name is highlighted.
- (7) Press the **FUNC DATA** key to delete the selected function code.
- (8) Press the **RESET** key to go back to the menu screen.

Figure 3.32 shows the LCD screen transition starting from Menu #10 "User Setting".

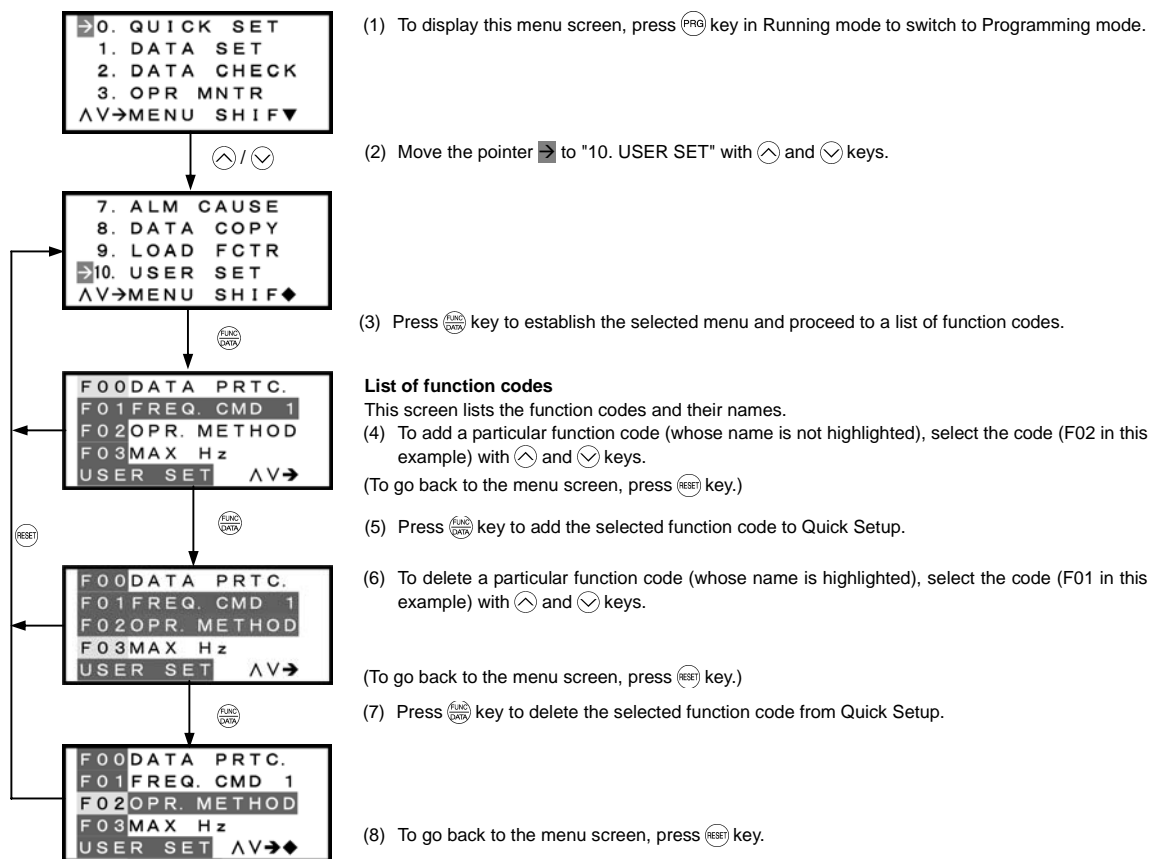

Figure 3.32 Screen Transition for Changing Function Codes Covered by Quick Setup

3.4.12 Helping debugging for communication -- Menu #11 "Communication Debugging" --

Menu #11 "Communication Debugging" in Programming mode is used to monitor the data of communication-related function codes (S, M, W, X, and Z codes) to help debug programs for communication with host equipment.

Basic key operation

- (1) Turn the inverter ON. It automatically enters Running mode. In that mode, press the **PRG** key to switch to Programming mode and display the menu screen.
- (2) Move the pointer → to "11. COMM DEBUG" with the **▲** and **▼** keys.
- (3) Press the **FUNC DATA** key to establish the selected menu and proceed to a list of communication-related function codes.
- (4) Select the desired function code with the **▲** and **▼** keys.
- (5) Press the **FUNC DATA** key to display the data of the selected function code.
- (6) Change the data of the S codes if necessary, using the **▲** and **▼** keys. Other communication-related function codes cannot be changed.
- (7) Press the **RESET** key to go back to the menu screen.

Figure 3.33 shows the LCD screen transition starting from Menu #11 "Communication Debugging."

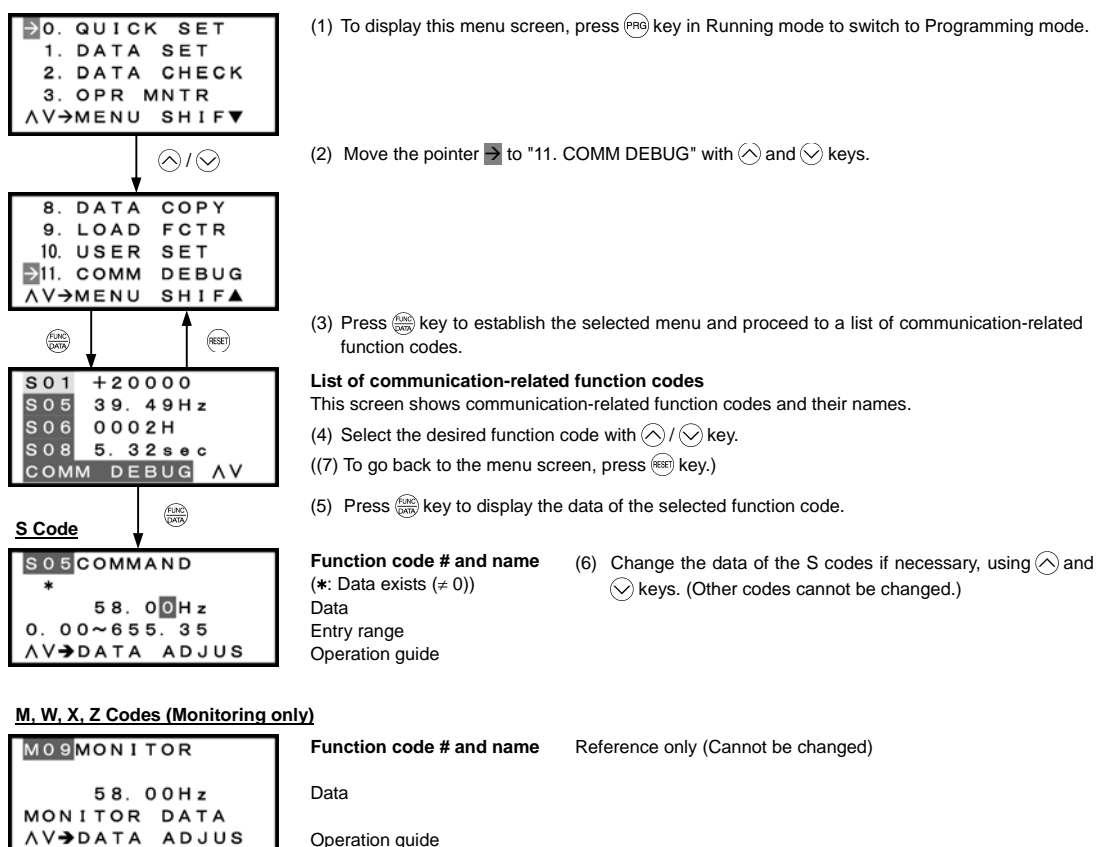

Figure 3.33 Screen Transition for "Communication Debugging"

3.5 Alarm Mode

If an abnormal condition arises so that the protective function is invoked and issues an alarm, then the inverter automatically switches to Alarm mode, displaying the alarm code on the LED monitor and the alarm information on the LCD monitor as shown below.

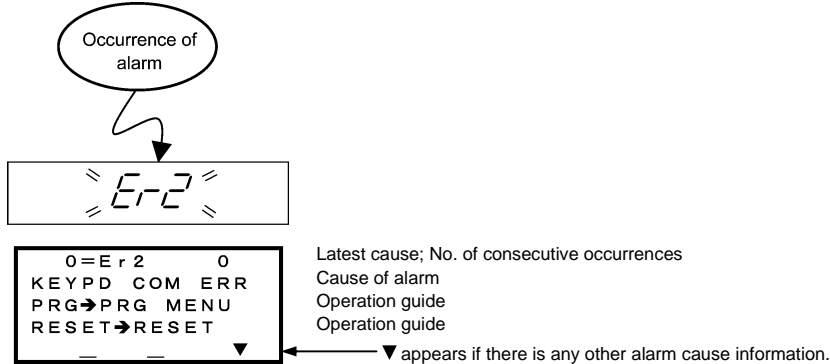
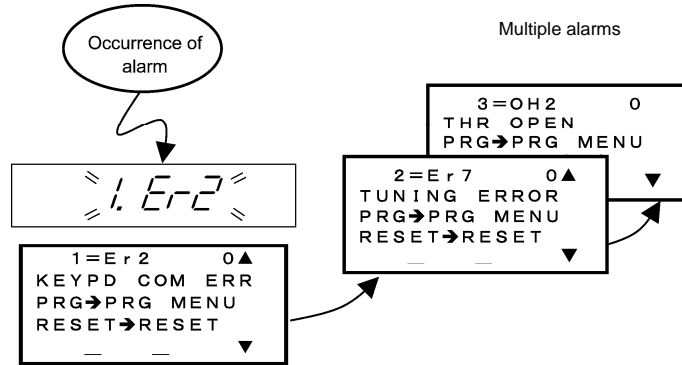

Figure 3.34 Without Multiple Alarms

If more than one alarm (multiple alarms) occurs, the display appears as shown below, allowing you to check the multiple alarms.



If multiple alarms occur, the latest cause appears as "1 = alarm code," not as "0 = alarm code."

Figure 3.35 With Multiple Alarms

It is also possible to view the alarm history.

In addition to the latest (current) alarm, you can view past three alarms and multiple alarms (if any) using the ⏪ and ⏩ keys when the latest (current) one is displayed.

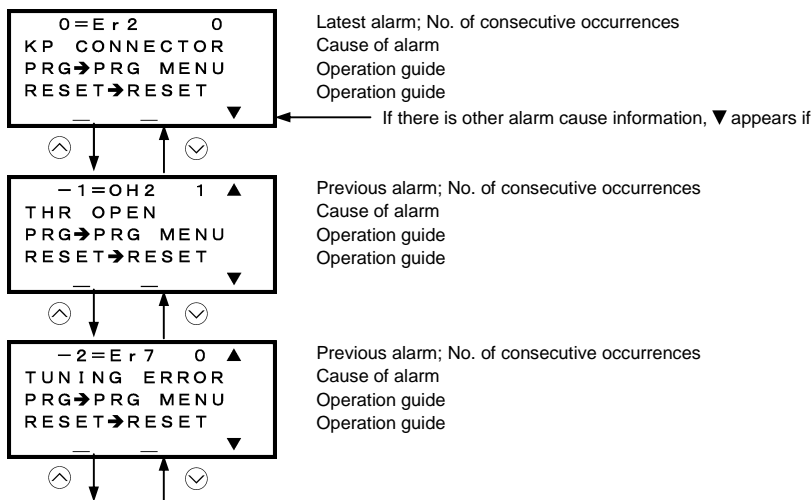

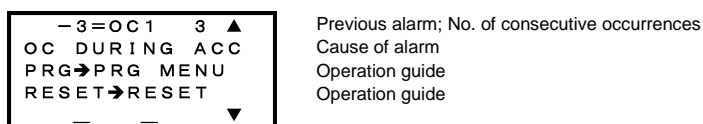







Figure 3.36 Switching of Display of Overlapping Alarm History

■ **Display of running status information at the time of alarm (Note 1 in Figure 3.37)**

By pressing the  key while an alarm code is displayed, you can view the output frequency, output current, and other data concerning the running status. The data you can view is the same as with "6. ALM INF." Use the  and  keys for scrolling pages within the menu.

Also, while a past alarm code is displayed, you can view the inverter running status at the occurrence of the displayed alarm.

Pressing the  key or  key with the running status information being displayed will switch back to the display of the alarm code.

■ **Transition to Programming mode (Note 2 in Figure 3.37)**

To change function code data for investigating or removing alarm causes, press the  key while alarm information is displayed. Then the inverter enters the Programming mode, in which you can use a variety of features including function code data change.

■ **Resetting alarm (Note 3 in Figure 3.37)**

When you remove the cause of the alarm and press the  key, the alarm condition will be reset, and the inverter will go back to the Running mode.

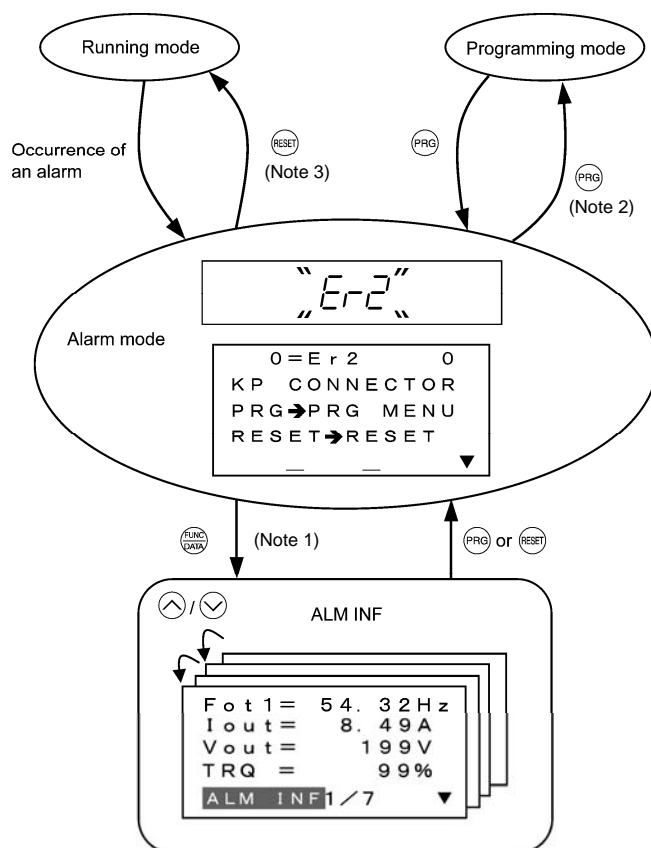

Figure 3.37 Screen Transition in/from Alarm Mode

Chapter 4 RUNNING THE MOTOR

4.1 Running the Motor for a Test

4.1.1 Test run procedure

Make a test run of the motor using the flowchart given below.

This chapter describes the test run procedure with motor 1 dedicated function codes that are marked with an asterisk (*). For motors 2 to 4, replace those asterisked function codes with respective motor dedicated ones. (Refer to Chapter 5, Table 5.5.)

 For the function codes dedicated to motors 2 to 4, see Chapter 5 "FUNCTION CODES."

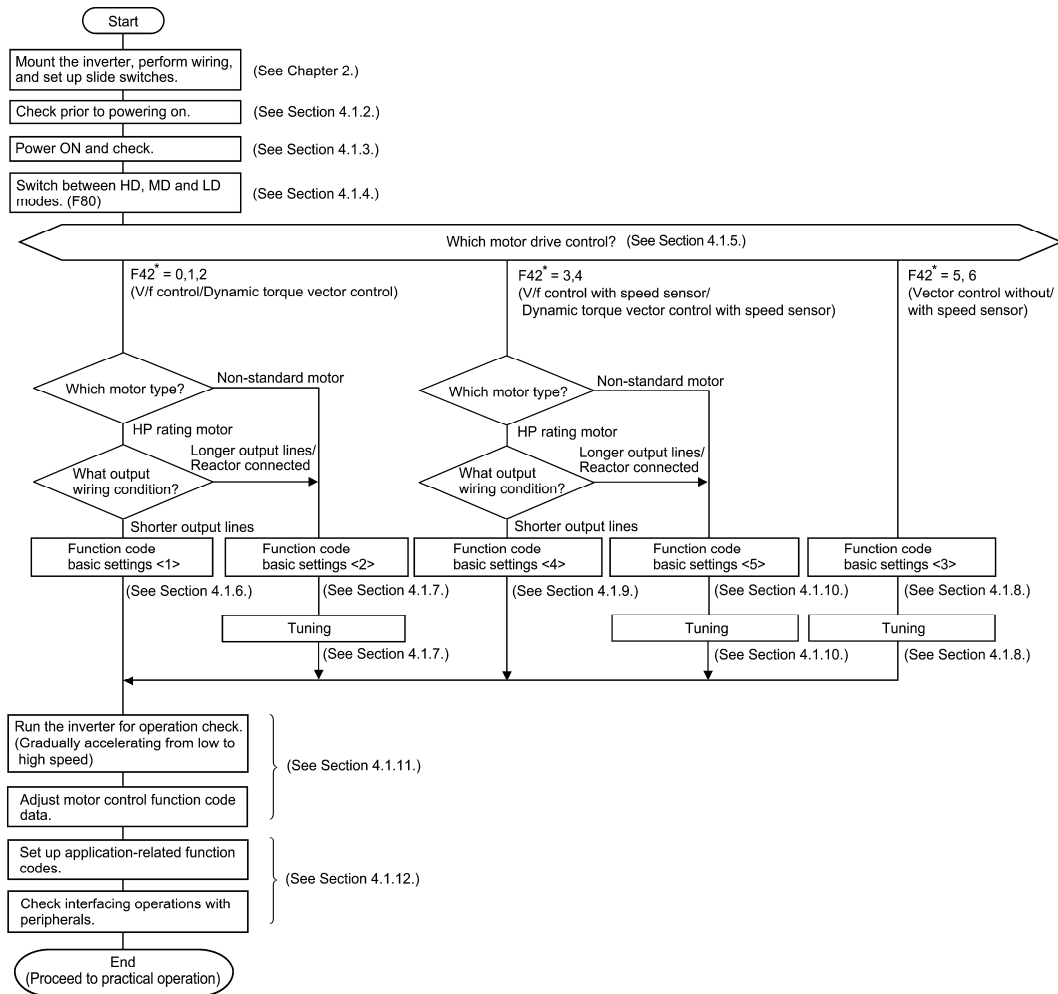



Figure 4.1 Test Run Procedure

4.1.2 Checking prior to powering on

Check the following before powering on the inverter.

(1) Check that the wiring is correct.

Especially check the wiring to the inverter input terminals L1/R, L2/S and L3/T and output terminals U, V, and W. Also check that the grounding wires are connected to the grounding terminals (⚡G) correctly. See Figure 4.2.

 WARNING
<ul style="list-style-type: none"> • Never connect power supply wires to the inverter output terminals U, V, and W. Doing so and turning the power ON breaks the inverter. • Be sure to connect the grounding wires of the inverter and the motor to the ground electrodes. <p style="margin-top: 5px;">Otherwise, an electric shock could occur.</p>

(2) Check the control circuit terminals and main circuit terminals for short circuits or ground faults.

- (3) Check for loose terminals, connectors and screws.
- (4) Check that the motor is separated from mechanical equipment.
- (5) Make sure that all switches of devices connected to the inverter are turned OFF. Powering on the inverter with any of those switches being ON may cause an unexpected motor operation.
- (6) Check that safety measures are taken against runaway of the equipment. Also ensure that all safety guards are in place to prevent human injury.

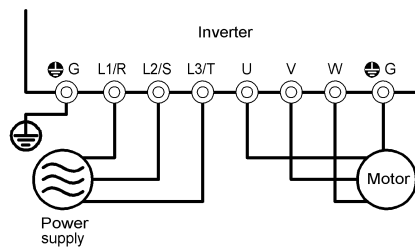

Figure 4.2 Connection of Main Circuit Terminals

4.1.3 Powering ON and checking

⚠ WARNING

- Be sure to mount the front cover before turning the power ON. Do not remove the cover when the inverter power is ON.
- Do not operate switches with wet hands.

Otherwise, an electric shock could occur.

Turn the power ON and check the following points. The following is a case when no function code data is changed from the factory defaults.

- (1) Check that the LED monitor displays (indicating that the reference frequency is 0 Hz) that is blinking. (See Figure 4.3.)
If the LED monitor displays any number except , press / key to set .
- (2) Check that the built-in cooling fans are rotating.
(Inverters of 2 HP or below are not equipped with a cooling fan.)



Figure 4.3 Indication on LED Monitor and LCD monitor after Power-on

4.1.4 Switching between LD, MD and HD drive modes

The FRENIC-MEGA series of inverters is applicable to three ratings—low duty (LD) for light load applications, medium duty (MD) for medium load ones, and high duty (HD) for heavy load ones. (The MD mode is available for inverters of 150 HP to 800 HP with three-phase 460 V input.)

Note: For 7.5 HP and smaller, when LD mode is selected, the HD mode specification applies.

F80 data	Drive mode	Application	Continuous rated current level	Overload capability	Maximum frequency
1	LD (Low Duty) mode	Light load	Drives a motor whose capacity is the <u>same</u> as the inverter's one.	120% for 1 min.	120 Hz
2	MD (Medium Duty) mode	Medium load	Drives a motor whose capacity is the <u>same</u> as the inverter's one or derates a motor <u>one rank lower</u> than the inverter's capacity.	150% for 1 min.	120 Hz
0	HD (High Duty) mode	Heavy load	Derates a motor <u>one rank or two ranks lower</u> than the inverter's capacity.	150% for 1 min. 200% for 3 s	500 Hz

Switching to the MD/HD mode increases the overload capability (%) against the continuous current level up to 150%, but it requires derating the motor one or two ranks lower than the inverter's capacity.

For the rated current level, see Chapter 8 "SPECIFICATIONS."

The LD/MD-mode inverter is subject to restrictions on the function code data setting range and internal processing as listed below.

Function codes	Name	LD mode	MD mode	HD mode	Remarks
F21*	DC braking (Braking level)	Setting range: 0 to 80%		Setting range: 0 to 100%	In the LD/MD mode, a value out of the range, if specified, automatically changes to the maximum value allowable in the LD mode.
F26	Motor sound (Carrier frequency)	Setting range: 0.75 to 16 kHz (0.5 to 30 HP) 0.75 to 10 kHz (40 to 100 HP) 0.75 to 6 kHz (125 to 900 HP) 0.75 to 4 kHz (1000 HP)	Setting range: 0.75 to 2 kHz (150 to 800 HP)	Setting range: 0.75 to 16 kHz (0.5 to 100 HP) 0.75 to 10 kHz (125 to 800 HP) 0.75 to 6 kHz (900 and 1000 HP)	
F44	Current limiter (Level)	Initial value: 130%	Initial value: 145%	Initial value: 160%	Switching the drive mode between LD, MD and HD with function code F80 automatically initializes the F44 data to the value specified at left.
F03*	Maximum frequency	Setting range: 25 to 500 Hz Upper limit: 120 Hz		Setting range: 25 to 500 Hz Upper limit: 500 Hz	In the LD/MD mode, if the maximum frequency exceeds 120 Hz, the actual output frequency is internally limited to 120 Hz.
—	Current indication and output	Based on the rated current level for LD mode	Based on the rated current level for MD mode	Based on the rated current level for HD mode	—

Even switching to the MD/HD mode cannot automatically change the motor rated capacity (P02*), so configure the P02* data to match the applied motor rating as required.

Note: For 7.5 HP and smaller, when LD mode is selected, the HD mode specification applies.

4.1.5 Selecting a desired motor drive control

The FRENIC-MEGA supports the following motor drive control.

F42* data	Drive control	Basic control	Speed feedback	Drive control class	Speed control	Other restrictions
0	V/f control with slip compensation inactive	V/f control	Disable	V/f	Frequency control	—
1	Dynamic torque vector control				Frequency control with slip compensation	—
2	V/f control with slip compensation active		Enable	PG V/f	Frequency control with automatic speed regulator (ASR)	Maximum frequency: 200 Hz
3	V/f control with speed sensor					
4	Dynamic torque vector control with speed sensor					
5	Vector control without speed sensor	Vector control	Estimated speed	w/o PG	Speed control with automatic speed regulator (ASR)	Maximum frequency: 120 Hz Not available for MD-mode inverters.
6	Vector control with speed sensor		Enable	w/ PG		Maximum frequency: 200 Hz

■ V/f control with slip compensation inactive

Under this control, the inverter controls a motor with the voltage and frequency according to the V/f pattern specified by function codes. This control disables all automatically controlled features such as the slip compensation, so no unpredictable output fluctuation results, enabling stable operation with constant output frequency.

■ V/f control with slip compensation active

Applying any load to an induction motor causes a rotational slip due to the motor characteristics, decreasing the motor rotation. The inverter's slip compensation function first presumes the slip value of the motor based on the motor torque generated and raises the output frequency to compensate for the decrease in motor rotation. This prevents the motor from decreasing the rotation due to the slip.

That is, this function is effective for improving the motor speed control accuracy.

The compensation value is specified by combination of function codes P12* (Rated slip frequency), P09* (Slip compensation gain for driving) and P11* (Slip compensation gain for braking).

H68* enables or disables the slip compensation function according to the motor driving conditions.

H68* data	Motor driving conditions		Motor driving frequency zone	
	Accl/Decel	Constant speed	Base frequency or below	Above the base frequency
0	Enable	Enable	Enable	Enable
1	Disable	Enable	Enable	Enable
2	Enable	Enable	Enable	Disable
3	Disable	Enable	Enable	Disable

■ Dynamic torque vector control

To get the maximal torque out of a motor, this control calculates the motor torque for the load applied and uses it to optimize the voltage and current vector output.

Selecting this control automatically enables the auto torque boost and slip compensation function.

This control is effective for improving the system response to external disturbances such as load fluctuations, and the motor speed control accuracy.

Note that the inverter may not respond to a rapid load fluctuation since this control is an open-loop V/f control that does not perform the current control, unlike the vector control. The advantages of this control include larger maximum torque per output current than that the vector control.

■ V/f control with speed sensor

Applying any load to an induction motor causes a rotational slip due to the motor characteristics, decreasing the motor rotation. Under V/f control with speed sensor, the inverter detects the motor rotation using the encoder mounted on the motor shaft and compensates for the decrease in slip frequency by the PI control to match the motor rotation with the commanded speed. This improves the motor speed control accuracy.

■ Dynamic torque vector control with speed sensor

The difference from the "V/f control with speed sensor" stated above is to calculate the motor torque for the load applied and use it to optimize the voltage and current vector output for getting the maximal torque out of a motor.

This control is effective for improving the system response to external disturbances such as load fluctuations, and the motor speed control accuracy.

■ Vector control without speed sensor

This control estimates the motor speed based on the inverter's output voltage and current to use the estimated speed for speed control. It also decomposes the motor drive current into the exciting and torque current components, and controls each of those components in vector. No PG (pulse generator) interface card is required. It is possible to obtain the desired response by adjusting the control constants (PI constants) using the speed regulator (PI controller).

The control regulating the motor current requires some voltage margin between the voltage that the inverter can output and the induced voltage of the motor. Usually a general-purpose motor is so designed that the voltage matches the commercial power. Under the control, therefore, it is necessary to suppress the motor terminal voltage to the lower level in order to secure the voltage margin required.

However, driving the motor with the motor terminal voltage suppressed to the lower level cannot generate the rated torque even if the rated current originally specified for the motor is applied. To ensure the rated torque, it is necessary to increase the rated current. (This also applies to vector control with speed sensor.)

This control is not available for MD-mode inverters, so do not set F42 data to "5" for those inverters.

■ Vector control with speed sensor

This control requires an optional PG (pulse generator) and an optional PG interface card to be mounted on a motor shaft and an inverter, respectively. The inverter detects the motor's rotational position and speed from PG feedback signals and uses them for speed control. In addition, it decomposes the motor drive current into the exciting and torque current components, and controls each of components in vector.

The desired response can be obtained by adjusting the control constants (PI constants) and using the speed regulator (PI controller). This control enables the speed control with higher accuracy and quicker response than the vector control without speed sensor.

Note Since slip compensation, dynamic torque vector control, and vector control with/without speed sensor use motor parameters, the following conditions should be satisfied; otherwise, full control performance may not be obtained.

- A single motor should be controlled per inverter.
- Motor parameters P02*, P03*, P06* to P23*, P55* and P56* should be properly configured or auto-tuning (P04*) should be performed.
- The capacity of the motor to be controlled should be two or more ranks lower than that of the inverter under the dynamic torque vector control; it should be the same as that of the inverter under the vector control with/without speed sensor. Otherwise, the inverter may not control the motor due to decrease of the current detection resolution.
- The wiring distance between the inverter and motor should be 164 ft (50 m) or less. If it is longer, the inverter may not control the motor due to leakage current flowing through stray capacitance to the ground or between wires. Especially, small capacity inverters whose rated current is also small may be unable to control the motor correctly even when the wiring is less than 164 ft (50 m). In that case, make the wiring length as short as possible or use a wire with small stray capacitance (e.g., loosely-bundled cable) to minimize the stray capacitance.

■ Performance comparison for drive controls (summary)

Each drive control has advantages and disadvantages. The table below compares the drive controls, showing their relative performance in each characteristic.

Select the one that shows high performance in the characteristics that are important in your machinery. In rare cases, the performance shown below may not be obtained due to various conditions including motor characteristics or mechanical rigidity. The final performance should be determined by adjusting the speed control system or other elements with the inverter being connected to the machinery (load). If you have any questions, contact your Fuji Electric representative.

F42* data	Drive control	Output frequency stability	Speed control accuracy	Speed control response	Maximum torque	Load disturbance	Current control	Torque accuracy
0	V/f control with slip compensation inactive	◎	—	—	◎	—	—	△
1	Dynamic torque vector control	△	△	△	◎	△	—	○
2	V/f control with slip compensation active	△	▲	▲	◎	△	—	△
3	V/f control with speed sensor	△	◎	○	◎	△	—	△
4	Dynamic torque vector control with speed sensor	△	◎	○	◎	△	—	○
5	Vector control without speed sensor	△	○	○	△	○	◎	○
6	Vector control with speed sensor	△	◎	◎	△	◎	◎	◎

Relative performance symbols ◎: Excellent, ○: Good, △: Effective, ▲: Less effective, —: Not effective

4.1.6 Function code basic settings < 1 >

Driving a HP rating motor under the V/f control (F42* = 0 or 2) or dynamic torque vector control (F42* = 1) requires configuring the following basic function codes. (Refer to Figure 4.1 on page 4-1.)

Configure the function codes listed below according to the motor ratings and your machinery design values. For the motor ratings, check the ratings printed on the motor's nameplate. For your machinery design values, ask system designers about them.

 For details on how to modify the function code data, see Chapter 3, Section 3.4.2 "Setting up function codes -- Menu #1 "Data Setting" --."

Function code	Name	Function code data	Factory default
F04*	Base frequency 1	Motor ratings (printed on the nameplate of the motor)	60 Hz
F05*	Rated voltage at base frequency 1		230/460 V
P99*	Motor 1 selection	1: Motor characteristics 1 (HP rating motors)	1: Motor characteristics 1 (HP rating motors)
P02*	Motor 1 (Rated capacity)	Capacity of motor connected	Nominal applied motor capacity
F03*	Maximum frequency 1	Machinery design values (Note) For a test-driving of the motor, increase values so that they are longer than your machinery design values. If the specified time is short, the inverter may not run the motor properly.	60 Hz
F07	Acceleration time 1 (Note)		40 HP or below: 6.00 (s) 50 HP or above: 20.00 (s)
F08	Deceleration time 1 (Note)		40 HP or below: 6.00 (s) 50 HP or above: 20.00 (s)

After the above configuration, initialize motor 1 with the function code (H03 = 2). It automatically updates the motor parameters P01*, P03*, P06* to P23*, P53* to P56*, and H46.

 When configuring the function code P02*, take into account that changing the P02* data automatically updates the data of the function codes P03*, P06* to P23*, P53* to P56*, and H46.

The motor rating should be specified properly when performing auto-torque boost, torque calculation monitoring, auto energy saving, torque limiting, automatic deceleration (anti-regenerative control), auto search for idling motor speed, slip compensation, torque vector control, droop control, or overload stop.

In any of the following cases, the full control performance may not be obtained from the inverter because the motor parameters differ from the factory defaults, so perform auto-tuning. (Refer to Section 4.1.7.)

- The motor to be driven is a non-standard product.
- The wiring distance between the inverter and the motor is too long (generally 66 ft (20 m) or more).
- A reactor is inserted between the inverter and the motor.

4.1.7 Function code basic settings and tuning < 2 >

Under the V/f control (F42* = 0 or 2) or dynamic torque vector control (F42* = 1), any of the following cases requires configuring the basic function codes given below and auto-tuning. (Refer to Figure 4.1 on page 4-1.)

- Driving a non-standard motor
- Driving a HP rating motor, provided that the wiring distance between the inverter and motor is long or a reactor is connected

Configure the function codes listed below according to the motor ratings and your machinery design values. For the motor ratings, check the ratings printed on the motor's nameplate. For your machinery design values, ask system designers about them.

 For details on how to modify the function code data, see Chapter 3, Section 3.4.2 "Setting up function codes -- Menu #1 "Data Setting" --."

Function code	Name	Function code data	Factory default
F04*	Base frequency 1	Motor ratings (printed on the nameplate of the motor)	60 Hz
F05*	Rated voltage at base frequency 1		230/460 V
P02*	Motor 1 (Rated capacity)		Nominal applied motor capacity
P03*	Motor 1 (Rated current)		Rated current of nominal applied motor
F03*	Maximum frequency 1	Machinery design values (Note) For a test-driving of the motor, increase values so that they are longer than your machinery design values. If the specified time is short, the inverter may not run the motor properly.	60 Hz
F07	Acceleration time 1 (Note)		40 HP or below: 6.00 (s) 50 HP or above: 20.00 (s)
F08	Deceleration time 1 (Note)		40 HP or below: 6.00 (s) 50 HP or above: 20.00 (s)

 When accessing the function code P02*, take into account that changing the P02* data automatically updates the data of the function codes P03*, P06* to P23*, P53* to P56*, and H46.

■ Tuning procedure

(1) Selection of tuning type

Check the situation of the machinery and select "Tuning with the motor stopped (P04* = 1)" or "Tuning with the motor running (P04* = 2)." For the latter tuning, adjust the acceleration and deceleration times (F07 and F08) and specify the rotation direction that matches the actual rotation direction of the machinery.

P04* data	Tuning type	Motor parameters subjected to tuning	Tuning	Select under the following conditions
1	Tune while the motor stops	Primary resistance (%R1) (P07*) Leakage reactance (%X) (P08*) Rated slip frequency (P12*) %X correction factor 1 and 2 (P53* and P54*)	Tuning <u>with the motor stopped</u> .	Cannot rotate the motor.
2	Tune while the motor is rotating under V/f control	No-load current (P06*) Primary resistance (%R1) (P07*) Leakage reactance (%X) (P08*) Rated slip frequency (P12*) Magnetic saturation factors 1 to 5 Magnetic saturation extension factors "a" to "c" (P16* to P23*) %X correction factor 1 and 2 (P53* and P54*)	Tuning the %R1 and %X, <u>with the motor stopped</u> . Tuning the no-load current and magnetic saturation factor, <u>with the motor running</u> at 50% of the base frequency. Tuning the rated slip frequency, <u>with the motor stopped</u> .	Can rotate the motor, provided that it is safe. Note that little load should be applied during tuning. Tuning with load applied decreases the tuning accuracy.

The tuning results of motor parameters will be automatically saved into their respective function codes. If P04* tuning is performed, for instance, the tuning results will be saved into P* codes (Motor 1* parameters).

(2) Preparation of machinery

Perform appropriate preparations on the motor and its load, such as disengaging the coupling from the motor and deactivating the safety devices.

(3) Tuning

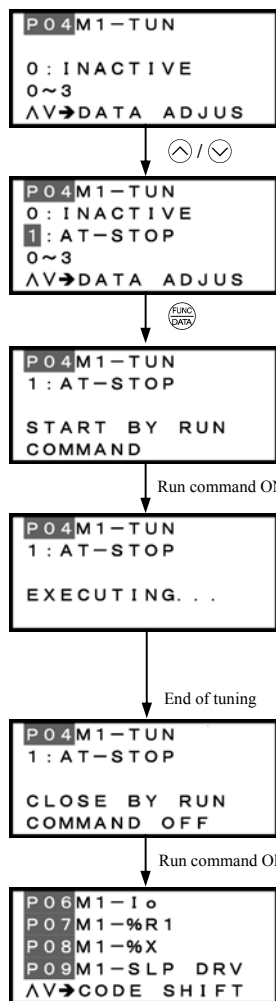

Set function code P04* to "1" or "2" and then press the  key as shown below.



① Use the  key to set function code P04 to "1" or "2."

② Press the  key to select the tuning mode.

The inverter waits for a run command.

③ Enter a run command. (The factory default of a run command source is "Keypad" (F02 = 0), so press the  or  key for forward or reverse rotation, respectively. To use the terminal command **FWD** or **REV** as a run command, change the data of function code F02.)

Tuning starts with the motor stopped. (Maximum tuning time: Approx. 40 to 80 s.)

④ If P04* = 2, after the tuning in ③ above, the motor is accelerated to approximately 50% of the base frequency and then tuning starts. Upon completion of measurements, the motor decelerates to a stop. (Estimated tuning time: Acceleration time + 20 to 75 s + Deceleration time)

⑤ If P04* = 2, after the motor decelerates to a stop in ④ above, tuning continues with the motor stopped. (Maximum tuning time: Approx. 40 to 80 s.)

⑥ Turn the run command OFF to complete tuning. (If the run command has been given through the keypad or the communications link, it automatically turns OFF.)

Upon completion of tuning, the subsequent function code appears.

■ Tuning errors

Improper tuning would negatively affect the operation performance and, in the worst case, could even cause hunting or deteriorate precision. Therefore, if the inverter finds any abnormality in the tuning results or any error in the tuning process, it displays E_r 7 and discards the tuning data.

Listed below are possible causes that trigger tuning errors.

Possible tuning error causes	Details
Error in tuning results	- An interphase voltage unbalance or output phase loss has been detected. - Tuning has resulted in an abnormally high or low value of a parameter due to the output circuit opened.
Output current error	An abnormally high current has flown during tuning.
Sequence error	During tuning, a run command has been turned OFF, or STOP (Force to stop), BX (Coast to a stop), DWP (Protect from dew condensation), or other similar terminal command has been received.
Error due to limitation	- During tuning, any of the operation limiters has been activated. - The maximum frequency or the frequency limiter (high) has limited tuning operation.
Other errors	An undervoltage or any other alarm has occurred.

If any of these errors occurs, remove the error cause and perform tuning again, or consult your Fuji Electric representative.

 Do not execute motor tuning with output filter unless the filter is a reactor type only. A tuning error may result if any other type filter is in use.

Vibration that may occur when the motor's coupling is elastic can be regarded as normal vibration due to the output voltage pattern applied in tuning. The tuning does not always result in an error; however, run the motor and check its running state.

4.1.8 Function code basic settings and tuning < 3 >

Driving a motor under vector control without speed sensor (F42*= 5) or with speed sensor (F42*=6) requires auto-tuning. (Refer to Figure 4.1 on page 4-1.)

Configure the function codes listed below according to the motor ratings and your machinery design values. For the motor ratings, check the ratings printed on the motor's nameplate. For your machinery design values, ask system designers about them.

For details on how to modify the function code data, see Chapter 3, Section 3.4.2 "Setting up function codes -- Menu #1 "Data Setting" --."

Function code	Name	Function code data	Factory default
F04*	Base frequency 1	Motor ratings (printed on the nameplate of the motor)	60 Hz
F05*	Rated voltage at base frequency 1		230/460 V
P02*	Motor 1 (Rated capacity)		Nominal applied motor capacity
P03*	Motor 1 (Rated current)		Rated current of nominal applied motor
F03*	Maximum frequency 1	Machinery design values (Note) For a test-driving of the motor, increase values so that they are longer than your machinery design values. If the specified time is short, the inverter may not run the motor properly.	60 Hz
F07	Acceleration time 1 (Note)		40 HP or below: 6.00 (s) 50 HP or above: 20.00 (s)
F08	Deceleration time 1 (Note)		40 HP or below: 6.00 (s) 50 HP or above: 20.00 (s)

- When accessing the function code P02*, take into account that changing the P02* data automatically updates the data of the function codes P03*, P06* to P23*, P53* to P56*, and H46.
- Specify the rated voltage at base frequency (F05) at the normal value, although the inverter controls the motor keeping the rated voltage (rated voltage at base frequency) low under vector control without speed sensor. After the auto-tuning, the inverter automatically reduces the rated voltage at base frequency.

■ Tuning procedure

(1) Selection of tuning type

Check the machinery conditions and perform the "tuning while the motor is rotating under vector control" (P04*=3). Adjust the acceleration and deceleration times (F07 and F08) in view of the motor rotation. And specify the rotation direction that matches the actual rotation direction of the machinery.

If the "tuning while the motor is rotating under vector control (P04*=3)" cannot be selected due to restrictions on the machinery, refer to "■ If tuning while the motor is rotating cannot be selected" on page 4-11.

Drive control abbreviation: "V/f" (V/f control), "w/o PG" (vector control without speed sensor), and "w/ PG" (vector control with speed sensor)

P04* data	Tuning type	Motor parameters subjected to tuning	Tuning	Select under the following conditions	Drive control		
					V/f	w/o PG	w/ PG
1	Tune while the motor stops	Primary resistance (%R1) (P07*) Leakage reactance (%X) (P08*) Rated slip frequency (P12*) %X correction factor 1 and 2 (P53* and P54*)	Tuning <u>with the motor stopped</u> .	Cannot rotate the motor.	Y	Y*	Y*
2	Tune while the motor is rotating under V/f control	No-load current (P06*) Primary resistance (%R1) (P07*) Leakage reactance (%X) (P08*) Rated slip frequency (P12*) Magnetic saturation factors 1 to 5 Magnetic saturation extension factors "a" to "c" (P16* to P23*) %X correction factor 1 and 2 (P53* and P54*)	Tuning the %R1 and %X, <u>with the motor stopped</u> . Tuning the no-load current and magnetic saturation factor, <u>with the motor running</u> at 50% of the base frequency. Tuning the rated slip frequency again, <u>with the motor stopped</u> .	Can rotate the motor, provided that it is safe. Note that little load should be applied during tuning. Tuning with load applied decreases the tuning accuracy.	Y	N	N

Y: Tuning available unconditionally Y*: Tuning available conditionally N: Tuning not available

P04* data	Tuning type	Motor parameters subjected to tuning	Tuning	Select under the following conditions	Drive control		
					V/f	w/o PG	w/ PG
3	Tune while the motor is rotating under vector control	No-load current (P06*) Primary resistance (%R1) (P07*) Leakage reactance (%X) (P08*) Rated slip frequency (P12*) Magnetic saturation factors 1 to 5 Magnetic saturation extension factors "a" to "c" (P16* to P23*) %X correction factor 1 and 2 (P53* and P54*)	Tuning the %R1, %X and rated slip frequency, <u>with the motor stopped</u> . Tuning the no-load current and magnetic saturation factor, <u>with the motor running</u> at 50% of the base frequency twice.	Can rotate the motor, provided that it is safe. Note that little load should be applied during tuning. Tuning with load applied decreases the tuning accuracy.	N	Y	Y

Y: Tuning available unconditionally Y*: Tuning available conditionally N: Tuning not available

The tuning results of motor parameters will be automatically saved into their respective function codes. If P04* tuning is performed, for instance, the tuning results will be saved into P* codes (Motor 1* parameters).

(2) Preparation of machinery

Perform appropriate preparations on the motor and its load, such as disengaging the coupling from the motor and deactivating the safety devices.

(3) Tuning (Tune while the motor is rotating under vector control)

Set function code P04* to "3" and then press the  key as shown below.

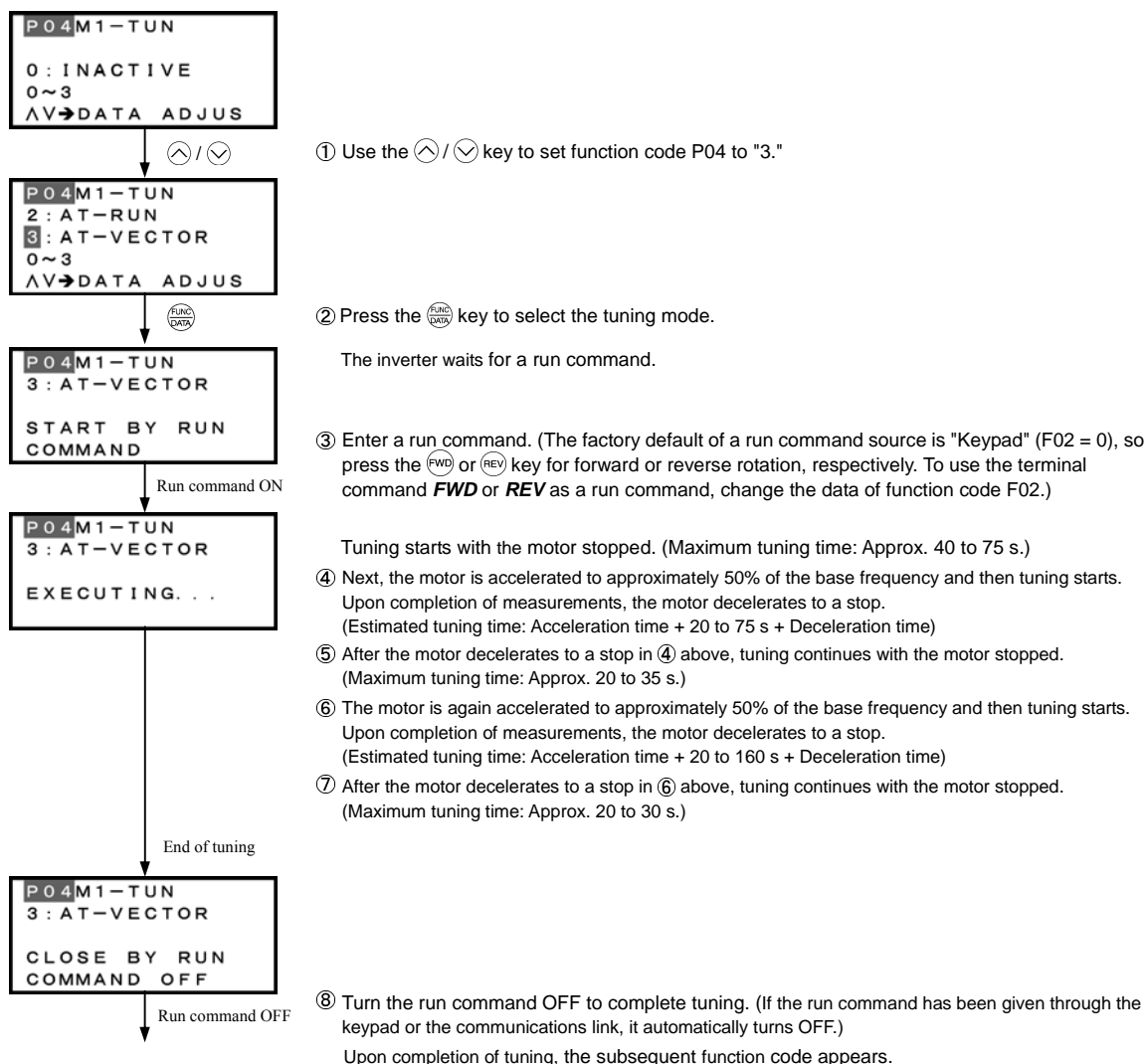

P06	M1-I	o
P07	M1-%R	1
P08	M1-%X	
P09	M1-SLP	DRV
▲V→CODE SHIFT		

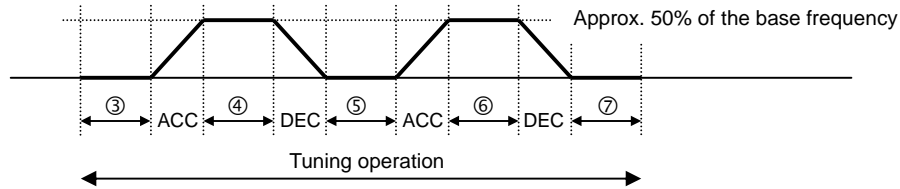

Note The default value of the speed regulator is set low to prevent your system from oscillation (hunting). However, hunting may occur during tuning due to machinery-related conditions, causing a tuning error ($\mathcal{E}_r - \bar{r}$) or a speed mismatch error ($\mathcal{E}_r - \mathcal{E}$). If a tuning error ($\mathcal{E}_r - \bar{r}$) occurs, reduce the gain for the speed regulator; if a speed mismatch error ($\mathcal{E}_r - \mathcal{E}$) occurs, cancel the speed mismatch detection function (d23=0). After that, perform tuning again.



■ If tuning while the motor is rotating cannot be selected

If the "tuning while the motor is rotating under vector control (P04*=3)" cannot be selected due to restrictions on the machinery, perform the "tuning with the motor stops (P04*=1)" by following the procedure below. Compared to the former tuning, the latter may show rather inferior performance in the speed control accuracy or stability, perform sufficient tests beforehand by connecting the motor with the machinery.

(1) Data setting

- ① Specify the F04*, F05*, P02*, and P03* data according to the motor rated values printed on the motor's nameplate.
- ② Specify motor parameters (the data of P06*, P16* to P23*) by obtaining the appropriate values on the datasheet issued from the motor manufacturer.
For details of conversion from data on the datasheet into ones to be entered as function code data, contact your Fuji Electric representative.
- ③ Perform the "tuning with the motor stops (P04*=1)."

(2) Tuning (Tune while the motor stops)

- ① Set function code P04* to "1" and press the  key.
- ② Enter a run command. The factory default of a run command source is "Keypad" (F02 = 0), so press the  or  key for forward or reverse rotation, respectively. To use the terminal command **FWD** or **REV** as a run command, change the data of function code F02.
- ③ The moment a run command is entered, tuning starts with the motor stopped.
(Maximum tuning time: Approx. 40 s.)
- ④ Turn the run command OFF to complete tuning. (If the run command has been given through the keypad or the communications link, it automatically turns OFF.)
Upon completion of tuning, the subsequent function code appears on the keypad.

■ Tuning errors

Improper tuning would negatively affect the operation performance and, in the worst case, could even cause hunting or deteriorate precision. Therefore, if the inverter finds any abnormality in the tuning results or any error in the tuning process, it displays $\mathcal{E}r-7$ and discards the tuning data.

Listed below are possible causes that trigger tuning errors.

Possible tuning error causes	Details
Error in tuning results	- An interphase voltage unbalance or output phase loss has been detected. - Tuning has resulted in an abnormally high or low value of a parameter due to the output circuit opened.
Output current error	An abnormally high current has flown during tuning.
Sequence error	During tuning, a run command has been turned OFF, or STOP (Force to stop), BX (Coast to a stop), DWP (Protect from dew condensation), or other similar terminal command has been received.
Error due to limitation	- During tuning, any of the operation limiters has been activated. - The maximum frequency or the frequency limiter (high) has limited tuning operation.
Other errors	An undervoltage or any other alarm has occurred.

If any of these errors occurs, remove the error cause and perform tuning again, or consult your Fuji Electric representative.

Note Do not execute motor tuning with output filter unless the filter is a reactor type only. A tuning error may result if any other type filter is in use.

Vibration that may occur when the motor's coupling is elastic can be regarded as normal vibration due to the output voltage pattern applied in tuning. The tuning does not always result in an error; however, run the motor and check its running state.

4.1.9 Function code basic settings < 4 >

Driving a HP rating motor under V/f control with speed sensor (F42* = 3) or dynamic torque vector control with speed sensor (F42* = 4) requires configuring the following basic function codes. (Refer to Figure 4.1 on page 4-1.)

Configure the function codes listed below according to the motor ratings and your machinery design values. For the motor ratings, check the ratings printed on the motor's nameplate. For your machinery design values, ask system designers about them.

 For details on how to modify the function code data, see Chapter 3, Section 3.4.2 "Setting up function codes -- Menu #1 "Data Setting" --."

Function code	Name	Function code data	Factory default
F 04 *	Base frequency 1	Motor ratings (printed on the nameplate of the motor)	60 Hz
F 05 *	Rated voltage at base frequency 1		230/460 V
P 99 *	Motor 1 selection	1: Motor characteristics 1 (HP rating motors)	1: Motor characteristics 1 (HP rating motors)
P 02 *	Motor 1 (Rated capacity)	Capacity of motor connected	Nominal applied motor capacity
F 03 *	Maximum frequency 1	Machinery design values (Note) For a test-driving of the motor, increase values so that they are longer than your machinery design values. If the specified time is short, the inverter may not run the motor properly.	60 Hz
F 07	Acceleration time 1 (Note)		40 HP or below: 6.00 (s) 50 HP or above: 20.00 (s)
F 08	Deceleration time 1 (Note)		40 HP or below: 6.00 (s) 50 HP or above: 20.00 (s)
d 15	Feedback input (Encoder pulse resolution)	Pulse count of the target motor encoder 0400 hex. / 1024 P/R	0400 (hex.)
d 16	Feedback input (Pulse count factor 1)	Reduction ratio between the motor and the encoder	1
d 17	Feedback input (Pulse count factor 2)	Motor speed = Encoder speed × (d17) / (d16)	1

After the above configuration, initialize motor 1 with the function code (H03 = 2). It automatically updates the motor parameters P01*, P03*, P06* to P23*, P53* to P56*, and H46.

 When accessing the function code P02*, take into account that changing the P02* data automatically updates the data of the function codes P03*, P06* to P23*, P53* to P56*, and H46.

The motor rating should be specified properly when performing auto-torque boost, torque calculation monitoring, auto energy saving, torque limiting, automatic deceleration (anti-regenerative control), auto search for idling motor speed, slip compensation, torque vector control, droop control, or overload stop.

In any of the following cases, the full control performance may not be obtained from the inverter because the motor parameters differ from the factory defaults, so perform auto-tuning. (Refer to Section 4.1.7.)

- The motor to be driven is a non-standard product.
- The wiring distance between the inverter and the motor is too long (generally 66 ft (20 m) or more).
- A reactor is inserted between the inverter and the motor.

4.1.10 Function code basic settings and tuning < 5 >

Under V/f control with speed sensor (F42* = 3) or dynamic torque vector control with speed sensor (F42* = 4), any of the following cases requires configuring the basic function codes given below and auto-tuning. (Refer to Figure 4.1 on page 4-1.)

- Driving a non-standard motor
- Driving a HP rating motor, provided that the wiring distance between the inverter and motor is long or a reactor is connected

Configure the function codes listed below according to the motor ratings and your machinery design values. For the motor ratings, check the ratings printed on the motor's nameplate. For your machinery design values, ask system designers about them.

 For details on how to modify the function code data, see Chapter 3, Section 3.4.2 "Setting up function codes -- Menu #1 "Data Setting" --."

Function code	Name	Function code data	Factory default
F04*	Base frequency 1	Motor ratings (printed on the nameplate of the motor)	60 Hz
F05*	Rated voltage at base frequency 1		230/460 V
P02*	Motor 1 (Rated capacity)		Nominal applied motor capacity
P03*	Motor 1 (Rated current)		Rated current of nominal applied motor
F03*	Maximum frequency 1	Machinery design values (Note) For a test-driving of the motor, increase values so that they are longer than your machinery design values. If the specified time is short, the inverter may not run the motor properly.	60 Hz
F07	Acceleration time 1 (Note)		40 HP or below: 6.00 (s) 50 HP or above: 20.00 (s)
F08	Deceleration time 1 (Note)		40 HP or below: 6.00 (s) 50 HP or above: 20.00 (s)
d15	Feedback input (Encoder pulse resolution)	Pulse count of the target motor encoder 0400 hex. / 1024 P/R	0400 (hex.)
d16	Feedback input (Pulse count factor 1)	Reduction ratio between the motor and the encoder	1
d17	Feedback input (Pulse count factor 2)	Motor speed = Encoder speed × (d17) / (d16)	1

 When accessing the function code P02*, take into account that changing the P02* data automatically updates the data of the function codes P03*, P06* to P23*, P53* to P56*, and H46.

■ Tuning procedure

(1) Selection of tuning type

Check the situation of the machinery and select "Tuning with the motor stopped (P04* = 1)" or "Tuning with the motor running (P04* = 2)." For the latter tuning, adjust the acceleration and deceleration times (F07 and F08) and specify the rotation direction that matches the actual rotation direction of the machinery.

P04* data	Tuning type	Motor parameters subjected to tuning	Tuning	Select under the following conditions
1	Tune while the motor stops	Primary resistance (%R1) (P07*) Leakage reactance (%X) (P08*) Rated slip frequency (P12*) %X correction factor 1 and 2 (P53* and P54*)	Tuning <u>with the motor stopped</u> .	Cannot rotate the motor.
2	Tune while the motor is rotating under V/f control	No-load current (P06*) Primary resistance (%R1) (P07*) Leakage reactance (%X) (P08*) Rated slip frequency (P12*) Magnetic saturation factors 1 to 5 Magnetic saturation extension factors "a" to "c" (P16* to P23*) %X correction factor 1 and 2 (P53* and P54*)	Tuning the %R1 and %X, <u>with the motor stopped</u> . Tuning the no-load current and magnetic saturation factor, <u>with the motor running</u> at 50% of the base frequency. Tuning the rated slip frequency, <u>with the motor stopped</u> .	Can rotate the motor, provided that it is safe. Note that little load should be applied during tuning. Tuning with load applied decreases the tuning accuracy.

The tuning results of motor parameters will be automatically saved into their respective function codes. If P04* tuning is performed, for instance, the tuning results will be saved into P* codes (Motor 1* parameters).

(2) Preparation of machinery

Perform appropriate preparations on the motor and its load, such as disengaging the coupling from the motor and deactivating the safety devices.

(3) Tuning

Set function code P04* to "1" or "2" and then press the  key as shown below.

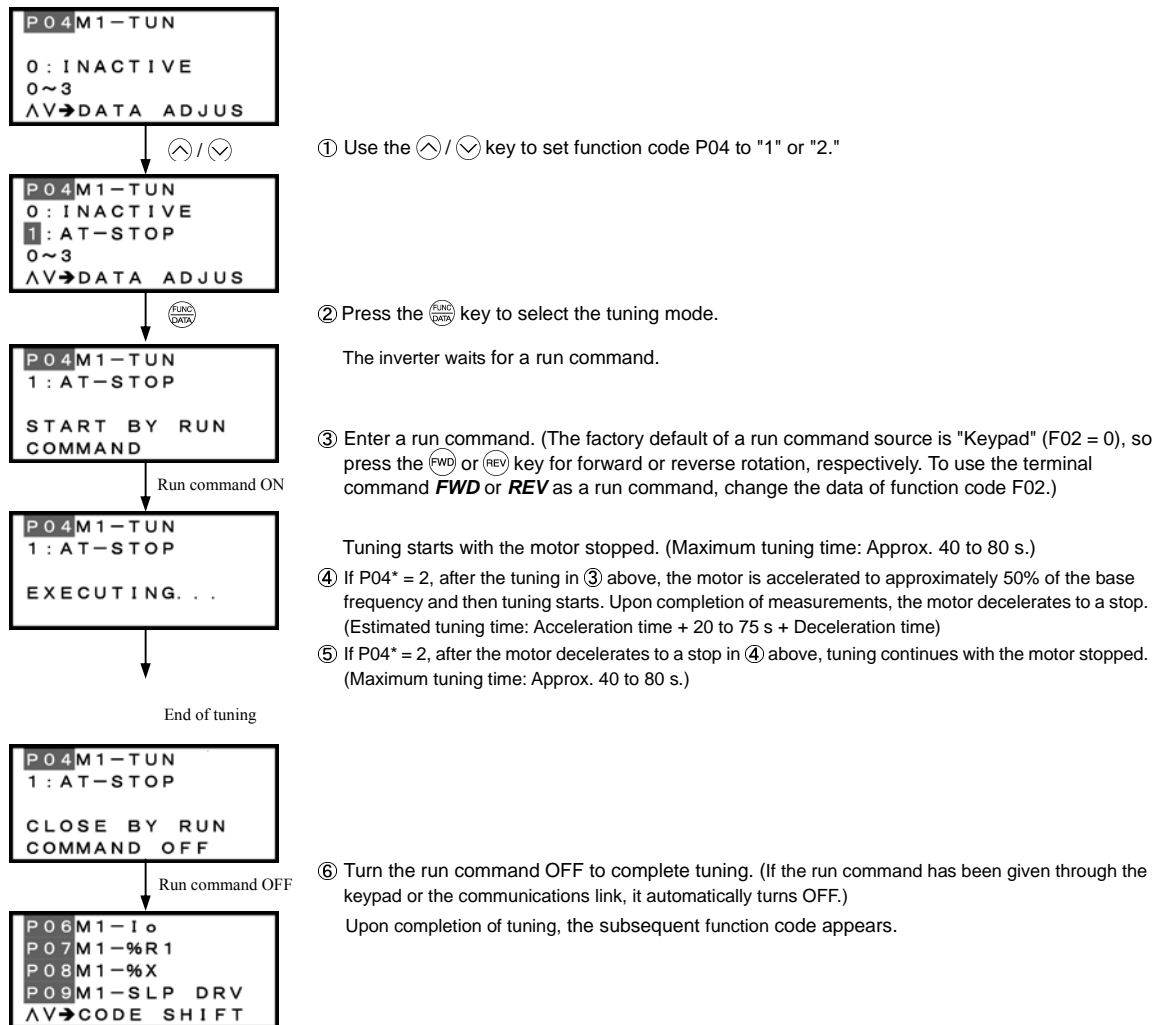

■ Tuning errors

Improper tuning would negatively affect the operation performance and, in the worst case, could even cause hunting or deteriorate precision. Therefore, if the inverter finds any abnormality in the tuning results or any error in the tuning process, it displays E_r-7 and discards the tuning data.

Listed below are possible causes that trigger tuning errors.

Possible tuning error causes	Details
Error in tuning results	- An interphase voltage unbalance or output phase loss has been detected. - Tuning has resulted in an abnormally high or low value of a parameter due to the output circuit opened.
Output current error	An abnormally high current has flown during tuning.
Sequence error	During tuning, a run command has been turned OFF, or STOP (Force to stop), BX (Coast to a stop), DWP (Protect from dew condensation), or other similar terminal command has been received.
Error due to limitation	- During tuning, any of the operation limiters has been activated. - The maximum frequency or the frequency limiter (high) has limited tuning operation.
Other errors	An undervoltage or any other alarm has occurred.

If any of these errors occurs, remove the error cause and perform tuning again, or consult your Fuji Electric representative.

Note Do not execute motor tuning with output filter unless the filter is a reactor type only. A tuning error may result if any other type filter is in use.

Vibration that may occur when the motor's coupling is elastic can be regarded as normal vibration due to the output voltage pattern applied in tuning. The tuning does not always result in an error; however, run the motor and check its running state.

4.1.11 Running the inverter for motor operation check

⚠ WARNING
If the user configures the function codes wrongly without completely understanding this Instruction Manual and the FRENIC-MEGA User's Manual, the motor may rotate with a torque or at a speed not permitted for the machine.
Accident or injury may result.

After completion of preparations for a test run as described above, start running the inverter for motor operation check using the following procedure.

⚠ CAUTION
If any abnormality is found in the inverter or motor, immediately stop operation and investigate the cause referring to Chapter 6, "TROUBLESHOOTING."

----- Test Run Procedure -----

- (1) Turn the power ON and check that the reference frequency Hz is blinking on the LED monitor.
- (2) Set a low reference frequency such as 5 Hz, using / keys. (Check that the frequency is blinking on the LED monitor.)
- (3) Press the key to start running the motor in the forward direction. (Check that the reference frequency is displayed on the LED monitor.)
- (4) To stop the motor, press the key.

< Check points during a test run >

- Check that the motor is running in the forward direction.
- Check for smooth rotation without motor humming or excessive vibration.
- Check for smooth acceleration and deceleration.

When no abnormality is found, press the key again to start driving the motor, then increase the reference frequency using / keys. Check the above points again.

If any problem is found, modify the function code data again as described below.

Tip Depending on the settings of function codes, the motor speed may rise to an unexpectedly high and dangerous level, particularly, under vector control with/without speed sensor. To avoid such an event, the speed limiting function is provided.

If the user is unfamiliar with the function code settings (e.g., when the user starts up the inverter for the first time), it is recommended that the frequency limiter (high) (F15) and the torque control (speed limit 1/2) (d32/d33) be used. At the startup of the inverter, to ensure safer operation, specify small values to those function codes at first and gradually increase them while checking the actual operation.

The speed limiting function serves as an overspeed level barrier, or as a speed limiter under torque control. For details of the speed limiting function, refer to the FRENIC-MEGA User's Manual.

< **Modification of motor control function code data** >

Modifying the current function code data sometimes can solve an insufficient torque or overcurrent incident. The table below lists the major function codes to be accessed. For details, see Chapter 5 "FUNCTION CODES" and Chapter 6 "TROUBLESHOOTING."

Function code	Name	Modification key points	Drive control			
			V/f	PG V/f	w/o PG	w/ PG
F 07	Acceleration time 1	If the current limiter is activated due to a short acceleration time and large drive current, prolong the acceleration time.	Y	Y	Y	Y
F 08	Deceleration time 1	If an overvoltage trip occurs due to a short deceleration time, prolong the deceleration time.	Y	Y	Y	Y
F 09 *	Torque boost 1	If the starting motor torque is deficient, increase the torque boost. If the motor with no load is overexcited, decrease the torque boost.	Y	Y	N	N
F 44	Current limiter (Mode selection)	If the stall prevention function is activated by the current limiter during acceleration or deceleration, increase the operation level.	Y	Y	N	N
P 09 *	Motor 1 (Slip compensation gain for driving)	For excessive slip compensation during driving, decrease the gain; for insufficient one, increase the gain.	Y	N	Y	N
P 11 *	Motor 1 (Slip compensation gain for braking)	For excessive slip compensation during braking, decrease the gain; for insufficient one, increase the gain.	Y	N	Y	N
H 80 *	Output current fluctuation damping gain 1 (For motor 1)	If the motor vibrates due to current fluctuation, increase the suppression gain.	Y	Y	N	N

Y: Modification effective N: Modification ineffective

If any problem persists under "V/f control with speed sensor," "dynamic torque vector control with speed sensor," or "vector control with/without speed sensor," then modify the following function code data.

The drive controls mentioned above use a PI controller for speed control. The PI constants are sometimes required to be modified because of the load inertia. The table below lists the main modification items. For details, see Chapter 5 "FUNCTION CODES" and Chapter 6 "TROUBLESHOOTING."

Function code	Name	Modification key points
d 01 *	Speed control 1 (Speed command filter)	If an excessive overshoot occurs for a speed command change, increase the filter constant.
d 02 *	Speed control 1 (Speed detection filter)	If ripples are superimposed on the speed detection signal so that the speed control gain cannot be increased, increase the filter constant to obtain a larger gain.
d 03 *	Speed control 1 P (Gain)	If hunting is caused in the motor speed control, decrease the gain. If the motor response is slow, increase the gain.
d 04 *	Speed control 1 I (Integral time)	If the motor response is slow, decrease the integral time.

4.1.12 Preparation for practical operation

After verifying normal motor running with the inverter in a test run, connect the motor with the machinery and perform wiring for practical operation.

- (1) Configure the application related function codes that operate the machinery.
- (2) Check interfacing with the peripheral circuits.
 - 1) Mock alarm
Generate a mock alarm by pressing the "STOP + FUNC DATA" keys" on the keypad for 5 seconds or more and check the alarm sequence. The inverter should stop and issue an alarm output signal (for any fault).
 - 2) Judgment on the life of the DC link bus capacitor
When the multi-function keypad is used, it is necessary to set up the judgment reference level to be applied for the judgment on the life of the DC link bus capacitor.
When the remote keypad is used, the same setting-up is also necessary in order to judge the life of the DC link bus capacitor under the practical operating conditions.
For details, refer to Chapter 7 "MAINTENANCE AND INSPECTION."
 - 3) I/O checking
Check interfacing with peripherals using Menu #4 "I/O Checking" on the keypad in Programming mode. For details, refer to Chapter 3 "OPERATION USING THE KEYPAD."
 - 4) Analog input adjustment
Adjust the analog inputs on terminals [I2], [C1] and [V2] using the function codes related to the offset, filter and gain that minimize analog input errors. For details, refer to Chapter 5 "FUNCTION CODES."
 - 5) Calibrating the [FM] output
Calibrate the full scale of the analog meter connected to the terminals [FM1] and [FM2], using the reference voltage equivalent to +10 VDC. To output the reference voltage, it is necessary to select the analog output test with the function code (F31/F35 = 14).
 - 6) Clearing the alarm history
Clear the alarm history saved during the system setup with the function code (H97 = 1).

 **Note** Depending upon the situation of the practical operation, it may become necessary to modify the settings of the torque boost (F09*), acceleration/deceleration times (F07/F08), and the PI controller for speed control under the vector control. Confirm the function code data and modify them properly.

4.2 Special Operations

4.2.1 Jogging (inching) the motor

To start jogging operation, perform the following procedure.

(1) Making the inverter ready for jogging

- 1) Switch the inverter to Running mode (see Section 3.2).
- 2) Press the "STOP + ⏪" keys" simultaneously (when the run command source is "Keypad" (F02 = 0, 1, or 3)). The lower indicator above the "JOG" index comes ON on the LCD monitor.



- Function code C20 specifies the jogging frequency. H54 and H55 specify the acceleration and deceleration times for jogging, respectively. These three function codes are exclusive to jogging operation. Specify each function code data, if needed.
- Using the input terminal command **JOG** ("Ready for jogging") switches between the normal operation state and ready-to-jog state.
- Switching between the normal operation state and ready-to-jog state is possible only when the inverter is stopped.

(2) Starting jogging

Hold down the ⏩ or ⏪ key to continue jogging the motor. Release the key to decelerate the motor to a stop.

(3) Exiting the inverter from the ready-to-jog state and returning to the normal operation state.

Press the "STOP + ⏪" keys" simultaneously. The lower indicator above the "JOG" index goes OFF on the LCD monitor.

4.2.2 Remote and local modes

The inverter is switchable between remote and local modes. In remote mode that applies to ordinary operation, the inverter is driven under the control of the data settings held in it, whereas in local mode that applies to maintenance operation, it is separated from the control system and is driven manually under the control of the keypad.

- Remote mode: The run and speed command sources are determined by source switching signals including function codes, run command 2/1 switching signal, and communications link operation signal. The keypad cannot be used as a command source.
- Local mode: The keypad is enabled as a run and speed command source, regardless of the settings specified by function codes. The keypad takes precedence over run command 2/1 switching signal, communications link operation signal or other command sources.

The table below lists the run command sources using the keypad in local mode.

Data for F02	Run command source	Description
0	Keypad	Enables the ⏩, ⏪, and STOP keys to run the motor in the forward and reverse directions, and stop the motor.
1	Terminal command FWD or REV	
2	Keypad (Forward direction)	Enables the ⏩ and STOP keys to run the motor in the forward direction and stop it. Running the motor in the reverse direction is not possible.
3	Keypad (Reverse direction)	Enables the ⏪ and STOP keys to run the motor in the reverse direction and stop it. Running the motor in the forward direction is not possible.

Holding down the REM/LOC key for at least one second switches between the remote and local modes.

The mode can be switched also by an external digital input signal. To enable the switching, you need to assign **LOC** to one of the digital input terminals, which means that the commands from the keypad are given precedence (one of function codes E01 to E09, E98, or E99 must be set to "35").

You can confirm the current mode on the indicators (REM: Remote mode; LOC: Local mode).

When the mode is switched from remote to local, the frequency settings in the remote mode are automatically inherited. Further, if the inverter is in Running mode at the time of the switching from remote to local, the run command is automatically turned ON so that all the necessary data settings will be carried over. If, however, there is a discrepancy between the settings on the keypad and those in the inverter itself (e.g., switching from reverse rotation in the remote mode to forward rotation in the local mode using the keypad that is for forward rotation only), the inverter automatically stops.

The paths of transition between remote and local modes depend on the current mode and the value (ON/OFF) of **LOC**, the signal giving precedence to the commands from the keypad, as shown in the state transition diagram shown in Figure 4.4.

For further details on how to set run commands and frequency commands in remote and local modes, refer to the drive command related section in the User's Manual, "BLOCK DIAGRAMS FOR CONTROL LOGIC."

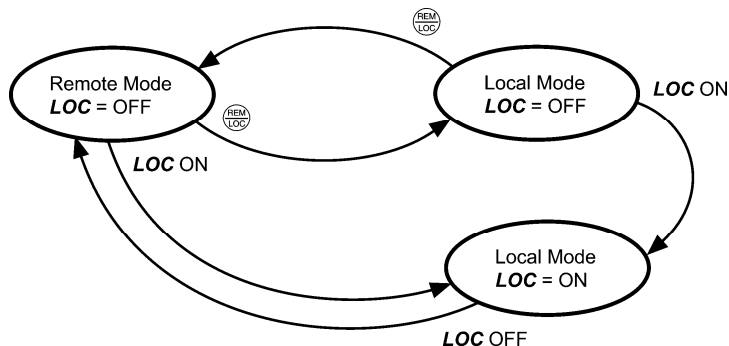

Figure 4.4 Transition between Remote and Local Modes

4.2.3 External run/frequency command

By factory default, run and frequency commands are sourced from the keypad. This section provides other external command source samples--an external frequency command potentiometer (variable resistor) as a frequency command source and external run switches as run forward/reverse command sources.

Set up those external sources using the following procedure.

- (1) Configure the function codes as listed below.

Function code	Name	Data	Factory default
<i>F 01</i>	Frequency command 1	1: Analog voltage input to terminal [12]	0
<i>F 02</i>	Operation method	1: External digital input signal	0
<i>E 98</i>	Terminal [FWD] function	98: Run forward command FWD	98
<i>E 99</i>	Terminal [REV] function	99: Run reverse command REV	99

Note If terminal [FWD] and [REV] are ON, the F02 data cannot be changed. First turn those terminals OFF and then change the F02 data.

- (2) Wire the external frequency command potentiometer to terminals across [13], [12], and [11].
- (3) Connect the run forward switch between terminals [FWD] and [CM] and the run reverse switch between [REV] and [CM].
- (4) To start running the inverter, rotate the potentiometer to give a voltage to terminal [12] and then turn the run forward or reverse switch ON (short-circuit).

For precautions in wiring, refer to Chapter 2 "MOUNTING AND WIRING THE INVERTER."

Chapter 5 FUNCTION CODES

5.1 Function Code Tables

Function codes enable the FRENIC-MEGA series of inverters to be set up to match your system requirements.

Each function code consists of a 3-letter alphanumeric string. The first letter is an alphabet that identifies its group and the following two letters are numerals that identify each individual code in the group. The function codes are classified into 13 groups: Fundamental Functions (F codes), Extension Terminal Functions (E codes), Control Functions (C codes), Motor 1 Parameters (P codes), High Performance Functions (H codes), Motor 2, 3 and 4 Parameters (A, b and r codes), Application Functions 1, 2, and 3 (J, d, and U codes), Link Functions (y codes) and Option Functions (o codes). To determine the property of each function code, set data to the function code.

This manual does not contain the descriptions of Option Function (o codes). For Option Function (o codes), refer to the instruction manual for each option.

The following descriptions supplement those given in the function code tables on the following pages.

■ Changing, validating, and saving function code data when the inverter is running

Function codes are indicated by the following based on whether they can be changed or not when the inverter is running:

Notation	Change when running	Validating and saving function code data
Y*	Possible	If the data of the codes marked with Y* is changed with \wedge and \vee keys, the change will immediately take effect; however, the change is not saved into the inverter's memory. To save the change, press the FUNC DATA key. If you press the RESET key without pressing the FUNC DATA key to exit the current state, then the changed data will be discarded and the previous data will take effect for the inverter operation.
Y	Possible	Even if the data of the codes marked with Y is changed with \wedge and \vee keys, the change will not take effect. Pressing the FUNC DATA key will make the change take effect and save it into the inverter's memory.
N	Impossible	—

■ Copying data

The keypad is capable of copying of the function code data stored in the inverter's memory into the keypad's memory (refer to Menu #7 "Data copying" in Programming mode). With this feature, you can easily transfer the data saved in a source inverter to other destination inverters.

If the specifications of the source and destination inverters differ, some code data may not be copied to ensure safe operation of your power system. Whether data will be copied or not is detailed with the following symbols in the "Data copying" column of the function code tables given on the following pages.

Y: Will be copied unconditionally.

Y1: Will not be copied if the rated capacity differs from the source inverter.

Y2: Will not be copied if the rated input voltage differs from the source inverter.

N: Will not be copied. (The function code marked with "N" is not subject to the Verify operation, either.)

For details of copying operation, refer to Chapter 3, Section 3.4.9.

■ Using negative logic for programmable I/O terminals

The negative logic signaling system can be used for the programmable, digital input and output terminals by setting the function code data specifying the properties for those terminals. Negative logic refers to the inverted ON/OFF (logical value 1 (true)/0 (false)) state of input or output signal. An active-ON signal (the function takes effect if the terminal is short-circuited.) in the normal logic system is functionally equivalent to active-OFF signal (the function takes effect if the terminal is opened.) in the negative logic system. Active-ON signals can be switched to active-OFF signals, and vice versa, with the function code data setting, except some signals.

To set the negative logic system for an input or output terminal, enter data of 1000s (by adding 1000 to the data for the normal logic) in the corresponding function code.

Example: "Coast to a stop" command **BX** assigned to any of digital input terminals [X1] to [X7] using any of function codes E01 through E07

Function code data	Description
7	Turning BX ON causes the motor to coast to a stop. (Active-ON)
1007	Turning BX OFF causes the motor to coast to a stop. (Active-OFF)

■ **Drive control**

The FRENIC-MEGA runs under any of the following drive controls. Some function codes apply exclusively to the specific drive control, which is indicated by letters Y (Applicable) and N (Not applicable) in the "Drive control" column in the function code tables given on the following pages.

Abbreviation in "Drive control" column in function code tables	Control target (H18)	Drive control (F42)
V/f	Speed (Frequency for V/f and PG V/f)	V/f control Dynamic torque vector control
PG V/f		V/f control with speed sensor Dynamic torque vector control with speed sensor
w/o PG		Vector control without speed sensor
w/ PG		Vector control with speed sensor
Torque control	Torque	Vector control with/without speed sensor

For details about the drive control, refer to "Function code F42 (Drive Control Selection 1)."

Note The FRENIC-MEGA is a general-purpose inverter whose operation is customized by frequency-basis function codes, like conventional inverters. Under the speed-basis drive control, however, the control target is a motor speed, not a frequency, so convert the frequency to the motor speed according to the following expression.
 Motor speed (r/min) = 120 × Frequency (Hz) ÷ Number of poles

Note: Difference of notation between standard keypad and remote keypad

Descriptions in this manual are based on the standard keypad having an LCD monitor and a *five*-digit, 7-segment LED monitor (as shown in Chapter 3). The FRENIC-MEGA also provides a remote keypad as an option, which has no LCD monitor and has a *four*-digit, 7-segment LED and a USB port.

If the standard keypad is replaced with an optional remote keypad, the display notation differs as shown below.

Function code	Name	Standard keypad (TP-G1W-J1)	Remote keypad (TP-E1U)
H42	Capacitance of DC Link Bus Capacitor	Decimal notation	Hexadecimal notation
H44	Startup Counter for Motor 1		
H47	Initial Capacitance of DC Link Bus Capacitor		
H79	Preset Startup Count for Maintenance (M1)		
A52	Startup Counter for Motor 2		
b52	Startup Counter for Motor 3		
r52	Startup Counter for Motor 4		
d15	Feedback Input (Encoder pulse resolution)		
d60	Command (Pulse Rate Input) (Encoder pulse resolution)	By hours	On a 10-hour basis (with the x10 LED ON)
H43	Cumulative Run Time of Cooling Fan		
H48	Cumulative Run Time of Capacitors on Printed Circuit Boards		
H77	Service Life of DC Link Bus Capacitor (Remaining time)		
H78	Maintenance Interval (M1)		
H94	Cumulative Motor Run Time 1		
A51	Cumulative Motor Run Time 2		
b51	Cumulative Motor Run Time 3	On a 10-pulse basis	For less than 10000 pulses: On a 10-pulse basis For 10000 pulses or more: On a 100-pulse basis (with the x10 LED ON)
r51	Cumulative Motor Run Time 4		
d78	Synchronous Operation (Excessive deviation detection range)		

The following tables list the function codes available for the FRENIC-MEGA series of inverters.

F codes: Fundamental Functions

Code	Name	Data setting range	Change when running	Data copying	Default setting	Drive control					Refer to page:
						V/f	PG V/f	w/o PG	w/ PG	Torque control	
F00	Data Protection	0: Disable both data protection and digital reference protection 1: Enable data protection and disable digital reference protection 2: Disable data protection and enable digital reference protection 3: Enable both data protection and digital reference protection	Y	Y	0	Y	Y	Y	Y	Y	5-34
F01	Frequency Command 1	0: ⏪ / ⏩ keys on keypad 1: Voltage input to terminal [12] (-10 to +10 VDC) 2: Current input to terminal [C1] (4 to 20 mA DC) 3: Sum of voltage and current inputs to terminals [12] and [C1] 5: Voltage input to terminal [V2] (-10 to +10 VDC) 7: Terminal command UP/DOWN control 8: ⏪ / ⏩ keys on keypad (balanceless-bumpless switching available) 11: Digital input interface card (option) 12: Pulse train input	N	Y	0	Y	Y	Y	Y	N	
F02	Operation Method	0: Keypad 1: Terminal command FWD or REV 2: Keypad (Forward direction) 3: Keypad (Reverse direction)	N	Y	0	Y	Y	Y	Y	Y	5-42
F03	Maximum Frequency 1	25.0 to 500.0 Hz	N	Y	60.0	Y	Y	Y	Y	Y	5-43
F04	Base Frequency 1	25.0 to 500.0 Hz	N	Y	60.0	Y	Y	Y	Y	Y	
F05	Rated Voltage at Base Frequency 1	0: Output a voltage in proportion to input voltage 80 to 240 V: Output an AVR-controlled voltage (for 230 V series) 160 to 500 V: Output an AVR-controlled voltage (for 460 V series)	N	Y2		Y	Y	Y	Y	Y	
F06	Maximum Output Voltage 1	80 to 240 V: Output an AVR-controlled voltage (for 230 V series) 160 to 500 V: Output an AVR-controlled voltage (for 460 V series)	N	Y2	230 460	Y	Y	N	N	Y	
F07	Acceleration Time 1	0.00 to 6000 s	Y	Y	*1	Y	Y	Y	Y	N	5-45
F08	Deceleration Time 1	Note: Entering 0.00 cancels the acceleration time, requiring external soft-start.	Y	Y	*1	Y	Y	Y	Y	N	
F09	Torque Boost 1	0.0% to 20.0% (percentage with respect to "Rated Voltage at Base Frequency 1")	Y	Y	0.0	Y	Y	N	N	N	5-48 5-64
F10	Electronic Thermal Overload Protection for Motor 1 (Select motor characteristics)	1: For a general-purpose motor with shaft-driven cooling fan 2: For an inverter-driven motor, non-ventilated motor, or motor with separately powered cooling fan	Y	Y	1	Y	Y	Y	Y	Y	5-49
F11	(Overload detection level)	0.00: Disable 1% to 135% of the rated current (allowable continuous drive current) of the motor	Y	Y1 Y2	*2	Y	Y	Y	Y	Y	
F12	(Thermal time constant)	0.5 to 75.0 min	Y	Y	*3	Y	Y	Y	Y	Y	
F14	Restart Mode after Momentary Power Failure (Mode selection)	0: Trip immediately 1: Trip after a recovery from power failure 2: Trip after decelerate-to-stop 3: Continue to run, for heavy inertia or general loads 4: Restart at the frequency at which the power failure occurred, for general loads 5: Restart at the starting frequency	Y	Y	0	Y	Y	Y	Y	N	5-51
F15	Frequency Limiter (High)	0.0 to 500.0 Hz	Y	Y	70.0	Y	Y	Y	Y	N	5-57
F16	(Low)	0.0 to 500.0 Hz	Y	Y	0.0	Y	Y	Y	Y	N	
F18	Bias (Frequency command 1)	-100.00% to 100.00%	Y*	Y	0.00	Y	Y	Y	Y	N	5-34 5-58
F20	DC Braking 1 (Braking starting frequency)	0.0 to 60.0 Hz	Y	Y	0.0	Y	Y	Y	Y	N	5-58
F21	(Braking level)	0% to 80% (LD/MD mode)*4, 0% to 100% (HD mode)	Y	Y	0	Y	Y	Y	Y	N	
F22	(Braking time)	0.00 (Disable); 0.01 to 30.00 s	Y	Y	0.00	Y	Y	Y	Y	N	

The shaded function codes () are applicable to the quick setup.

- *1 6.00 s for inverters of 40 HP or below; 20.00 s for those of 50 HP or above
- *2 The motor rated current is automatically set. See Table B (P03/A17/b17/r17).
- *3 5.0 min for inverters of 40 HP or below; 10.0 min for those of 50 HP or above
- *4 0% to 100% for inverters of 7.5 HP or below

Code	Name	Data setting range	Change when running	Data copying	Default setting	Drive control					Refer to page:
						V/f	PG V/f	w/o PG	w/ PG	Torque control	
F23	Starting Frequency 1	0.0 to 60.0 Hz	Y	Y	0.5	Y	Y	Y	Y	N	5-59
F24	(Holding time)	0.00 to 10.00 s	Y	Y	0.00	Y	Y	Y	Y	N	
F25	Stop Frequency	0.0 to 60.0 Hz	Y	Y	0.2	Y	Y	Y	Y	N	
F26	Motor Sound (Carrier frequency)	0.75 to 16 kHz (LD-mode inverters of 0.5 to 30 HP and HD-mode ones of 0.5 to 100 HP) 0.75 to 10 kHz (LD-mode inverters of 40 to 100 HP and HD-mode ones of 125 to 800 HP) 0.75 to 6 kHz (LD-mode inverters of 125 to 900 HP and HD-mode ones of 900 and 1000 HP) 0.75 to 4 kHz (LD-mode inverters of 1000 HP) 0.75 to 2 kHz (MD-mode inverters of 150 to 800 HP)	Y	Y	2	Y	Y	Y	Y	Y	5-62
F27	(Tone)	0: Level 0 (Inactive) 1: Level 1 2: Level 2 3: Level 3	Y	Y	0	Y	Y	N	N	Y	
F29	Analog Output [FM1] (Mode selection)	0: Output in voltage (0 to 10 VDC) 1: Output in current (4 to 20 mA DC)	Y	Y	0	Y	Y	Y	Y	Y	5-63
F30	(Voltage adjustment)	0% to 300%	Y*	Y	100	Y	Y	Y	Y	Y	
F31	(Function)	Select a function to be monitored from the followings. 0: Output frequency 1 (before slip compensation) 1: Output frequency 2 (after slip compensation) 2: Output current 3: Output voltage 4: Output torque 5: Load factor 6: Input power 7: PID feedback amount (PV) 8: PG feedback value 9: DC link bus voltage 10: Universal AO 13: Motor output 14: Calibration (+) 15: PID command (SV) 16: PID output (MV) 17: Positional deviation in synchronous running	Y	Y	0	Y	Y	Y	Y	Y	
F32	Analog Output [FM2] (Mode selection)	0: Output in voltage (0 to 10 VDC) 1: Output in current (4 to 20 mA DC)	Y	Y	0	Y	Y	Y	Y	Y	
F34	(Voltage adjustment)	0% to 300%	Y*	Y	100	Y	Y	Y	Y	Y	
F35	(Function)	Select a function to be monitored from the followings. 0: Output frequency 1 (before slip compensation) 1: Output frequency 2 (after slip compensation) 2: Output current 3: Output voltage 4: Output torque 5: Load factor 6: Input power 7: PID feedback amount (PV) 8: PG feedback value 9: DC link bus voltage 10: Universal AO 13: Motor output 14: Calibration (+) 15: PID command (SV) 16: PID output (MV) 17: Positional deviation in synchronous running	Y	Y	0	Y	Y	Y	Y	Y	
F37	Load Selection/ Auto Torque Boost/ Auto Energy Saving Operation 1	0: Variable torque load 1: Constant torque load 2: Auto torque boost 3: Auto energy saving (Variable torque load during ACC/DEC) 4: Auto energy saving (Constant torque load during ACC/DEC) 5: Auto energy saving (Auto torque boost during ACC/DEC)	N	Y	1	Y	Y	N	Y	N	5-64
F38	Stop Frequency (Detection mode)	0: Detected speed 1: Reference speed	N	Y	0	N	N	N	Y	N	5-59
F39	(Holding Time)	0.00 to 10.00 s	Y	Y	0.00	Y	Y	Y	Y	N	5-66
F40	Torque Limiter 1-1	-300% to 300%; 999 (Disable)	Y	Y	999	Y	Y	Y	Y	Y	5-66
F41	1-2	-300% to 300%; 999 (Disable)	Y	Y	999	Y	Y	Y	Y	Y	
F42	Drive Control Selection 1	0: V/f control with slip compensation inactive 1: Dynamic torque vector control 2: V/f control with slip compensation active 3: V/f control with speed sensor 4: Dynamic torque vector control with speed sensor 5: Vector control without speed sensor 6: Vector control with speed sensor	N	Y	0	Y	Y	Y	Y	Y	5-73

The shaded function codes () are applicable to the quick setup.

F codes
E codes
C codes
P codes
H codes
A codes
b codes
r codes
J codes
d codes
U codes
y codes

Code	Name	Data setting range	Change when running	Data copying	Default setting	Drive control					Refer to page:
						V/f	PG V/f	w/o PG	w/ PG	Torque control	
F43	Current Limiter (Mode selection)	0: Disable (No current limiter works.) 1: Enable at constant speed (Disable during ACC/DEC) 2: Enable during ACC/constant speed operation	Y	Y	2	Y	Y	N	N	N	5-75
F44	(Level)	20% to 200% (The data is interpreted as the rated output current of the inverter for 100%.)	Y	Y	*5	Y	Y	N	N	N	
F50	Electronic Thermal Overload Protection for Braking Resistor (Discharging capability)	0 (Braking resistor built-in type), 1 to 9000 kW, OFF (Disable)	Y	Y1 Y2	*6	Y	Y	Y	Y	Y	5-76
F51	(Allowable average loss)	0.001 to 99.99 kW	Y	Y1 Y2	0.001	Y	Y	Y	Y	Y	
F52	(Resistance)	0.01 to 999Ω	Y	Y1 Y2	0.01	Y	Y	Y	Y	Y	
F80	Switching between LD, MD and HD drive modes	0: HD (High Duty) mode 1: LD (Low Duty) mode 2: MD (Medium Duty) mode	N	Y	1	Y	Y	Y	Y	Y	5-77

*5 160% for inverters of 7.5 HP or below; 130% for those of 10 HP or above

*6 0 for inverters of 15 HP or below; OFF for those of 20 HP or above

E codes: Extension Terminal Functions

Code	Name	Data setting range	Change when running	Data copying	Default setting	Drive control					Refer to page:
						V/f	PG V/f	w/o PG	w/ PG	Torque control	
		Selecting function code data assigns the corresponding function to terminals [X1] to [X7] as listed below.									5-79
E01	Terminal [X1] Function	0 (1000): Select multi-frequency (0 to 1 steps) (SS1)	N	Y	0	Y	Y	Y	Y	N	
E02	Terminal [X2] Function	1 (1001): Select multi-frequency (0 to 3 steps) (SS2)	N	Y	1	Y	Y	Y	Y	N	
E03	Terminal [X3] Function	2 (1002): Select multi-frequency (0 to 7 steps) (SS4)	N	Y	2	Y	Y	Y	Y	N	
E04	Terminal [X4] Function	3 (1003): Select multi-frequency (0 to 15 steps) (SS8)	N	Y	3	Y	Y	Y	Y	N	
E05	Terminal [X5] Function	4 (1004): Select ACC/DEC time (2 steps) (RT1)	N	Y	4	Y	Y	Y	Y	N	
E06	Terminal [X6] Function	5 (1005): Select ACC/DEC time (4 steps) (RT2)	N	Y	5	Y	Y	Y	Y	N	
E07	Terminal [X7] Function	6 (1006): Enable 3-wire operation (HLD)	N	Y	8	Y	Y	Y	Y	Y	
		7 (1007): Coast to a stop (BX)				Y	Y	Y	Y	Y	
		8 (1008): Reset alarm (RST)				Y	Y	Y	Y	Y	
		9 (1009): Enable external alarm trip (9 = Active OFF, 1009 = Active ON) (THR)				Y	Y	Y	Y	Y	
		10 (1010): Ready for jogging (JOG)				Y	Y	Y	Y	N	
		11 (1011): Select frequency command 2/1 (Hz2/Hz1)				Y	Y	Y	Y	N	
		12 (1012): Select motor 2 (M2)				Y	Y	Y	Y	Y	
		13: Enable DC braking (DCBRK)				Y	Y	Y	Y	N	
		14 (1014): Select torque limiter level 2/1 (TL2/TL1)				Y	Y	Y	Y	Y	
		15: Switch to commercial power (50 Hz) (SW50)				Y	Y	N	N	N	
		16: Switch to commercial power (60 Hz) (SW60)				Y	Y	N	N	N	
		17 (1017): UP (Increase output frequency) (UP)				Y	Y	Y	Y	N	
		18 (1018): DOWN (Decrease output frequency) (DOWN)				Y	Y	Y	Y	N	
		19 (1019): Enable data change with keypad (WE-KP)				Y	Y	Y	Y	Y	
		20 (1020): Cancel PID control (Hz/PID)				Y	Y	Y	Y	N	
		21 (1021): Switch normal/inverse operation (IVS)				Y	Y	Y	Y	N	
		22 (1022): Interlock (IL)				Y	Y	Y	Y	Y	
		23 (1023): Cancel torque control (Hz/TRQ)				N	N	N	N	Y	
		24 (1024): Enable communications link via RS-485 or fieldbus (option) (LE)				Y	Y	Y	Y	Y	
		25 (1025): Universal DI (U-DI)				Y	Y	Y	Y	Y	
		26 (1026): Enable auto search for idling motor speed at starting (STM)				Y	Y	Y	N	Y	
		30 (1030): Force to stop (STOP) (30 = Active OFF, 1030 = Active ON)				Y	Y	Y	Y	Y	
		32 (1032): Pre-excitation (EXITE)				N	N	Y	Y	N	
		33 (1033): Reset PID integral and differential components (PID-RST)				Y	Y	Y	Y	N	
		34 (1034): Hold PID integral component (PID-HLD)				Y	Y	Y	Y	N	
		35 (1035): Select local (keypad) operation (LOC)				Y	Y	Y	Y	Y	
		36 (1036): Select motor 3 (M3)				Y	Y	Y	Y	Y	
		37 (1037): Select motor 4 (M4)				Y	Y	Y	Y	Y	
		39: Protect motor from dew condensation (DWP)				Y	Y	Y	Y	Y	
		40: Enable integrated sequence to switch to commercial power (50 Hz) (ISW50)				Y	Y	N	N	N	
		41: Enable integrated sequence to switch to commercial power (60 Hz) (ISW60)				Y	Y	N	N	N	
		47 (1047): Servo-lock command (LOCK)				N	N	N	Y	N	
		48: Pulse train input (available only on terminal [X7] (E07)) (PIN)				Y	Y	Y	Y	Y	
		49 (1049): Pulse train sign (available on terminals except [X7] (E01 to E06)) (SIGN)				Y	Y	Y	Y	Y	
		70 (1070): Cancel constant peripheral speed control (Hz/LSC)				Y	Y	Y	Y	N	
		71 (1071): Hold the constant peripheral speed control frequency in the memory (LSC-HLD)				Y	Y	Y	Y	N	
		72 (1072): Count the run time of commercial power-driven motor 1 (CRUN-M1)				Y	Y	N	N	Y	
		73 (1073): Count the run time of commercial power-driven motor 2 (CRUN-M2)				Y	Y	N	N	Y	
		74 (1074): Count the run time of commercial power-driven motor 3 (CRUN-M3)				Y	Y	N	N	Y	
		75 (1075): Count the run time of commercial power-driven motor 4 (CRUN-M4)				Y	Y	N	N	Y	
		76 (1076): Select droop control (DROOP)				Y	Y	Y	Y	N	
		77 (1077): Cancel PG alarm (PG-CCL)				N	Y	N	Y	Y	
		80 (1080): Cancel customizable logic (CLC)				Y	Y	Y	Y	Y	
		81 (1081): Clear all customizable logic timers (CLTC)				Y	Y	Y	Y	Y	
		100: No function assigned (NONE)				Y	Y	Y	Y	Y	
		Setting the value in parentheses () shown above assigns a negative logic input to a terminal.									

F codes
E codes
C codes
P codes
H codes
A codes
b codes
r codes
J codes
d codes
U codes
y codes

Code	Name	Data setting range	Change when running	Data copying	Default setting	Drive control					Refer to page:
						V/f	PG V/f	w/o PG	w/ PG	Torque control	
E10	Acceleration Time 2	0.00 to 6000 s	Y	Y	*1	Y	Y	Y	Y	N	5-45
E11	Deceleration Time 2	Note: Entering 0.00 cancels the acceleration time, requiring external soft-start and -stop.	Y	Y	*1	Y	Y	Y	Y	N	5-90
E12	Acceleration Time 3		Y	Y	*1	Y	Y	Y	Y	N	
E13	Deceleration Time 3		Y	Y	*1	Y	Y	Y	Y	N	
E14	Acceleration Time 4		Y	Y	*1	Y	Y	Y	Y	N	
E15	Deceleration Time 4		Y	Y	*1	Y	Y	Y	Y	N	
E16	Torque Limiter 2-1	-300% to 300%; 999 (Disable)	Y	Y	999	Y	Y	Y	Y	Y	5-66
E17	Torque Limiter 2-2	-300% to 300%; 999 (Disable)	Y	Y	999	Y	Y	Y	Y	Y	5-90
		Selecting function code data assigns the corresponding function to terminals [Y1] to [Y5A/C] and [30A/B/C] as listed below.									5-91
E20	Terminal [Y1] Function	0 (1000): Inverter running (RUN)	N	Y	0	Y	Y	Y	Y	Y	
E21	Terminal [Y2] Function	1 (1001): Frequency (speed) arrival signal (FAR)	N	Y	1	Y	Y	Y	Y	N	
E22	Terminal [Y3] Function	2 (1002): Frequency (speed) detected (FDT)	N	Y	2	Y	Y	Y	Y	Y	
E23	Terminal [Y4] Function	3 (1003): Undervoltage detected (Inverter stopped) (LU)	N	Y	7	Y	Y	Y	Y	Y	
E24	Terminal [Y5A/C] Function	4 (1004): Torque polarity detected (B/D)	N	Y	15	Y	Y	Y	Y	Y	
E27	Terminal [30A/B/C] Function (Relay output)	5 (1005): Inverter output limiting (IOL)	N	Y	99	Y	Y	Y	Y	Y	
		6 (1006): Auto-restarting after momentary power failure (IPF)				Y	Y	Y	Y	Y	
		7 (1007): Motor overload early warning (OL)				Y	Y	Y	Y	Y	
		8 (1008): Keypad operation enabled (KP)				Y	Y	Y	Y	Y	
		10 (1010): Inverter ready to run (RDY)				Y	Y	Y	Y	Y	
		11: Switch motor drive source between commercial power and inverter output (For MC on commercial line) (SW88)				Y	Y	N	N	N	
		12: Switch motor drive source between commercial power and inverter output (For secondary side) (SW52-2)				Y	Y	N	N	N	
		13: Switch motor drive source between commercial power and inverter output (For primary side) (SW52-1)				Y	Y	N	N	N	
		15 (1015): Select AX terminal function (For MC on primary side) (AX)				Y	Y	Y	Y	Y	
		22 (1022): Inverter output limiting with delay (IOL2)				Y	Y	Y	Y	Y	
		25 (1025): Cooling fan in operation (FAN)				Y	Y	Y	Y	Y	
		26 (1026): Auto-resetting (TRY)				Y	Y	Y	Y	Y	
		27 (1027): Universal DO (U-DO)				Y	Y	Y	Y	Y	
		28 (1028): Heat sink overheat early warning (OH)				Y	Y	Y	Y	Y	
		29 (1029): Synchronization completed (SY)				N	Y	N	Y	N	
		30 (1030): Lifetime alarm (LIFE)				Y	Y	Y	Y	Y	
		31 (1031): Frequency (speed) detected 2 (FDT2)				Y	Y	Y	Y	Y	
		33 (1033): Reference loss detected (REF OFF)				Y	Y	Y	Y	Y	
		35 (1035): Inverter output on (RUN2)				Y	Y	Y	Y	Y	
		36 (1036): Overload prevention control (OLP)				Y	Y	Y	Y	N	
		37 (1037): Current detected (ID)				Y	Y	Y	Y	Y	
		38 (1038): Current detected 2 (ID2)				Y	Y	Y	Y	Y	
		39 (1039): Current detected 3 (ID3)				Y	Y	Y	Y	Y	
		41 (1041): Low current detected (IDL)				Y	Y	Y	Y	Y	
		42 (1042): PID alarm (PID-ALM)				Y	Y	Y	Y	N	
		43 (1043): Under PID control (PID-CTL)				Y	Y	Y	Y	N	
		44 (1044): Motor stopped due to slow flowrate under PID control (PID-STP)				Y	Y	Y	Y	N	
		45 (1045): Low output torque detected (U-TL)				Y	Y	Y	Y	Y	
		46 (1046): Torque detected 1 (TD1)				Y	Y	Y	Y	Y	
		47 (1047): Torque detected 2 (TD2)				Y	Y	Y	Y	Y	
		48 (1048): Motor 1 selected (SWM1)				Y	Y	Y	Y	Y	
		49 (1049): Motor 2 selected (SWM2)				Y	Y	Y	Y	Y	
		50 (1050): Motor 3 selected (SWM3)				Y	Y	Y	Y	Y	
		51 (1051): Motor 4 selected (SWM4)				Y	Y	Y	Y	Y	
		52 (1052): Running forward (FRUN)				Y	Y	Y	Y	Y	
		53 (1053): Running reverse (RRUN)				Y	Y	Y	Y	Y	
		54 (1054): In remote operation (RMT)				Y	Y	Y	Y	Y	
		56 (1056): Motor overheat detected by thermistor (THM)				Y	Y	Y	Y	Y	
		57 (1057): Brake signal (BRKS)				Y	Y	Y	Y	N	
		58 (1058): Frequency (speed) detected 3 (FDT3)				Y	Y	Y	Y	Y	
		59 (1059): Terminal [C1] wire break (C1OFF)				Y	Y	Y	Y	Y	

*1 6.00 s for inverters of 40 HP or below; 20.00 s for those of 50 HP or above

Code	Name	Data setting range	Change when running	Data copying	Default setting	Drive control					Refer to page:
						V/f	PG V/f	w/o PG	w/ PG	Torque control	
		70 (1070): Speed valid (DNZS) 71 (1071): Speed agreement (DSAG) 72 (1072): Frequency (speed) arrival signal 3 (FAR3) 76 (1076): PG error detected (PG-ERR) 82 (1082): Positioning completion signal (PSET) 84 (1084): Maintenance timer (MNT) 98 (1098): Light alarm (L-ALM) 99 (1099): Alarm output (for any alarm) (ALM) 101 (1101): Enable circuit failure detected (DECF) 102 (1102): Enable input OFF (EN OFF) 105 (1105): Braking transistor broken (DBAL) 111 (1111): Customizable logic output signal 1 (CLO1) 112 (1112): Customizable logic output signal 2 (CLO2) 113 (1113): Customizable logic output signal 3 (CLO3) 114 (1114): Customizable logic output signal 4 (CLO4) 115 (1115): Customizable logic output signal 5 (CLO5) Setting the value in parentheses () shown above assigns a negative logic output to a terminal.				N	Y	Y	Y	Y	5-91
E30	Frequency Arrival (Hysteresis width)	0.0 to 10.0 Hz	Y	Y	2.5	Y	Y	Y	Y	N	5-96
E31	Frequency Detection 1 (Level)	0.0 to 500.0 Hz	Y	Y	60.0	Y	Y	Y	Y	Y	
E32	(Hysteresis width)	0.0 to 500.0 Hz	Y	Y	1.0	Y	Y	Y	Y	Y	
E34	Overload Early Warning/Current Detection (Level)	0.00 (Disable); Current value of 1% to 200% of the inverter rated current	Y	Y1 Y2	*2	Y	Y	Y	Y	Y	5-97
E35	(Timer)	0.01 to 600.00s	Y	Y	10.00	Y	Y	Y	Y	Y	
E36	Frequency Detection 2 (Level)	0.0 to 500.0 Hz	Y	Y	60.0	Y	Y	Y	Y	Y	5-96 5-98
E37	Current Detection 2/ Low Current Detection (Level)	0.00 (Disable); Current value of 1% to 200% of the inverter rated current	Y	Y1 Y2	*2	Y	Y	Y	Y	Y	5-97 5-98
E38	(Timer)	0.01 to 600.00 s	Y	Y	10.00	Y	Y	Y	Y	Y	
E40	PID Display Coefficient A	-999 to 0.00 to 9990	Y	Y	100	Y	Y	Y	Y	N	5-98
E41	PID Display Coefficient B	-999 to 0.00 to 9990	Y	Y	0.00	Y	Y	Y	Y	N	
E42	LED Display Filter	0.0 to 5.0 s	Y	Y	0.5	Y	Y	Y	Y	Y	5-99
E43	LED Monitor (Item selection)	0: Speed monitor (select by E48) 3: Output current 4: Output voltage 8: Calculated torque 9: Input power 10: PID command 12: PID feedback amount 14: PID output 15: Load factor 16: Motor output 17: Analog input 23: Torque current (%) 24: Magnetic flux command (%) 25: Input watt-hour	Y	Y	0	Y	Y	Y	Y	Y	5-100
E44	(Display when stopped)	0: Specified value 1: Output value	Y	Y	0	Y	Y	Y	Y	Y	5-101
E45	LCD Monitor (Item selection)	0: Running status, rotational direction and operation guide 1: Bar charts for output frequency, current and calculated torque	Y	Y	0	Y	Y	Y	Y	Y	
E46	(Language selection)	Type: TP-G1W-J1 0: Japanese 1: English 2: German 3: French 4: Spanish 5: Italian	Y	Y	1	Y	Y	Y	Y	Y	5-102
E47	(Contrast control)	0 (Low) to 10 (High)	Y	Y	5	Y	Y	Y	Y	Y	
E48	LED Monitor (Speed monitor item)	0: Output frequency 1 (Before slip compensation) 1: Output frequency 2 (After slip compensation) 2: Reference frequency 3: Motor speed in r/min 4: Load shaft speed in r/min 5: Line speed in m/min 7: Display speed in %	Y	Y	0	Y	Y	Y	Y	Y	5-100 5-102

*2 The motor rated current is automatically set. See Table B (P03/A17/b17/r17).

F codes
E codes
C codes
P codes
H codes
A codes
b codes
r codes
J codes
d codes
U codes
y codes

Code	Name	Data setting range	Change when running	Data copying	Default setting	Drive control					Refer to page:
						V/f	PG V/f	w/o PG	w/ PG	Torque control	
E50	Coefficient for Speed Indication	0.01 to 200.00	Y	Y	30.00	Y	Y	Y	Y	Y	5-102
E51	Display Coefficient for Input Watt-hour Data	0.000 (Cancel/reset), 0.001 to 9999	Y	Y	0.010	Y	Y	Y	Y	Y	
E52	Keypad (Menu display mode)	0: Function code data editing mode (Menus #0, #1, and #7) 1: Function code data check mode (Menus #2 and #7) 2: Full-menu mode	Y	Y	0	Y	Y	Y	Y	Y	
E54	Frequency Detection 3 (Level)	0.0 to 500.0 Hz	Y	Y	60.0	Y	Y	Y	Y	Y	5-96 5-103
E55	Current Detection 3 (Level)	0.00 (Disable); Current value of 1% to 200% of the inverter rated current	Y	Y1 Y2	*2	Y	Y	Y	Y	Y	5-97 5-103
E56	(Timer)	0.01 to 600.00 s	Y	Y	10.00	Y	Y	Y	Y	Y	
E61	Terminal [I2] Extended Function	0: None	N	Y	0	Y	Y	Y	Y	Y	5-104
E62	Terminal [C1] Extended Function	1: Auxiliary frequency command 1 2: Auxiliary frequency command 2	N	Y	0	Y	Y	Y	Y	Y	
E63	Terminal [V2] Extended Function	3: PID command 1 5: PID feedback amount 6: Ratio setting 7: Analog torque limit value A 8: Analog torque limit value B 10: Torque command 11: Torque current command 20: Analog input monitor	N	Y	0	Y	Y	Y	Y	Y	
E64	Saving of Digital Reference Frequency	0: Automatic saving (when main power is turned OFF) 1: Saving by pressing  key	Y	Y	1	Y	Y	Y	Y	Y	
E65	Reference Loss Detection (Continuous running frequency)	0: Decelerate to stop, 20% to 120%, 999: Disable	Y	Y	999	Y	Y	Y	Y	Y	5-105
E78	Torque Detection 1 (Level)	0% to 300%	Y	Y	100	Y	Y	Y	Y	Y	
E79	(Timer)	0.01 to 600.00 s	Y	Y	10.00	Y	Y	Y	Y	Y	
E80	Torque Detection 2/ Low Torque Detection (Level)	0% to 300%	Y	Y	20	Y	Y	Y	Y	Y	
E81	(Timer)	0.01 to 600.00 s	Y	Y	20.00	Y	Y	Y	Y	Y	
E98	Terminal [FWD] Function	Selecting function code data assigns the corresponding function to terminals [FWD] and [REV] as listed below.									5-79 5-106
E99	Terminal [REV] Function	0 (1000): Select multi-frequency (0 to 1 steps) (SS1)	N	Y	98	Y	Y	Y	Y	N	
		1 (1001): Select multi-frequency (0 to 3 steps) (SS2)	N	Y	99	Y	Y	Y	Y	N	
		2 (1002): Select multi-frequency (0 to 7 steps) (SS4)				Y	Y	Y	Y	N	
		3 (1003): Select multi-frequency (0 to 15 steps) (SS8)				Y	Y	Y	Y	N	
		4 (1004): Select ACC/DEC time (2 steps) (RT1)				Y	Y	Y	Y	N	
		5 (1005): Select ACC/DEC time (4 steps) (RT2)				Y	Y	Y	Y	N	
		6 (1006): Enable 3-wire operation (HLD)				Y	Y	Y	Y	Y	
		7 (1007): Coast to a stop (BX)				Y	Y	Y	Y	Y	
		8 (1008): Reset alarm (RST)				Y	Y	Y	Y	Y	
		9 (1009): Enable external alarm trip (9 = Active OFF, 1009 = Active ON) (THR)				Y	Y	Y	Y	Y	
		10 (1010): Ready for jogging (JOG)				Y	Y	Y	Y	N	
		11 (1011): Select frequency command 2/1 (Hz2/Hz1)				Y	Y	Y	Y	N	
		12 (1012): Select motor 2 (M2)				Y	Y	Y	Y	Y	
		13: Enable DC braking (DCBRK)				Y	Y	Y	Y	N	
		14 (1014): Select torque limiter level 2/1 (TL2/TL1)				Y	Y	Y	Y	Y	
		15: Switch to commercial power (50 Hz) (SW50)				Y	Y	N	N	N	
		16: Switch to commercial power (60 Hz) (SW60)				Y	Y	N	N	N	
		17 (1017): UP (increase output frequency) (UP)				Y	Y	Y	Y	N	
		18 (1018): DOWN (Decrease output frequency) (DOWN)				Y	Y	Y	Y	N	
		19 (1019): Enable data change with keypad (WE-KP)				Y	Y	Y	Y	Y	
		20 (1020): Cancel PID control (Hz/PID)				Y	Y	Y	Y	N	
		21 (1021): Switch normal/inverse operation (IVS)				Y	Y	Y	Y	N	
		22 (1022): Interlock (IL)				Y	Y	Y	Y	Y	
		23 (1023): Cancel torque control (Hz/TRQ)				N	N	N	N	Y	
		24 (1024): Enable communications link via RS-485 or fieldbus (LE)				Y	Y	Y	Y	Y	
		25 (1025): Universal DI (U-DI)				Y	Y	Y	Y	Y	
		26 (1026): Enable auto search for idling motor speed at starting (STM)				Y	Y	Y	N	Y	

The shaded function codes () are applicable to the quick setup.

*2 The motor rated current is automatically set. See Table B (P03/A17/b17/r17).

Code	Name	Data setting range	Change when running	Data copying	Default setting	Drive control					Refer to page:
						V/f	PG V/f	w/o PG	w/ PG	Torque control	
		30 (1030): Force to stop (STOP) (30 = Active OFF, 1030 = Active ON)				Y	Y	Y	Y	Y	5-79
		32 (1032): Pre-excitation (EXITE)				N	N	Y	Y	N	5-106
		33 (1033): Reset PID integral and differential components (PID-RST)				Y	Y	Y	Y	N	
		34 (1034): Hold PID integral component (PID-HLD)				Y	Y	Y	Y	N	
		35 (1035): Select local (keypad) operation (LOC)				Y	Y	Y	Y	Y	
		36 (1036): Select motor 3 (M3)				Y	Y	Y	Y	Y	
		37 (1037): Select motor 4 (M4)				Y	Y	Y	Y	Y	
		39: Protect motor from dew condensation (DWP)				Y	Y	Y	Y	Y	
		40: Enable integrated sequence to switch to commercial power (50 Hz) (ISW50)				Y	Y	N	N	N	
		41: Enable integrated sequence to switch to commercial power (60 Hz) (ISW60)				Y	Y	N	N	N	
		47 (1047): Servo-lock command (LOCK)				N	N	N	Y	N	
		49 (1049): Pulse train sign (SIGN)				Y	Y	Y	Y	Y	
		70 (1070): Cancel constant peripheral speed control (Hz/LSC)				Y	Y	Y	Y	N	
		71 (1071): Hold the constant peripheral speed control frequency in the memory (LSC-HLD)				Y	Y	Y	Y	N	
		72 (1072): Count the run time of commercial power-driven motor 1 (CRUN-M1)				Y	Y	N	N	Y	
		73 (1073): Count the run time of commercial power-driven motor 2 (CRUN-M2)				Y	Y	N	N	Y	
		74 (1074): Count the run time of commercial power-driven motor 3 (CRUN-M3)				Y	Y	N	N	Y	
		75 (1075): Count the run time of commercial power-driven motor 4 (CRUN-M4)				Y	Y	N	N	Y	
		76 (1076): Select droop control (DROOP)				Y	Y	Y	Y	N	
		77 (1077): Cancel PG alarm (PG-CCL)				N	Y	N	Y	Y	
		80 (1080): Cancel customizable logic (CLC)				Y	Y	Y	Y	Y	
		81 (1081): Clear all customizable logic timers (CLTC)				Y	Y	Y	Y	Y	
		98: Run forward (FWD)				Y	Y	Y	Y	Y	
		99: Run reverse (REV)				Y	Y	Y	Y	Y	
		100: No function assigned (NONE)				Y	Y	Y	Y	Y	
		Setting the value in parentheses () shown above assigns a negative logic input to a terminal.									

F codes
E codes
C codes
P codes
H codes
A codes
b codes
r codes
J codes
d codes
U codes
y codes

C codes: Control Functions of Frequency

Code	Name	Data setting range	Change when running	Data copying	Default setting	Drive control					Refer to page:
						V/f	PG V/f	w/o PG	w/ PG	Torque control	
C01	Jump Frequency 1 2 3 (Hysteresis width)	0.0 to 500.0 Hz	Y	Y	0.0	Y	Y	Y	Y	N	5-107
C02			Y	Y	0.0	Y	Y	Y	Y	N	
C03			Y	Y	0.0	Y	Y	Y	Y	N	
C04			Y	Y	3.0	Y	Y	Y	Y	N	
C05	Multi-frequency 1 2 3 4 5 6 7 8 9 10 11 12 13 14 15	0.00 to 500.00 Hz	Y	Y	0.00	Y	Y	Y	Y	N	
C06			Y	Y	0.00	Y	Y	Y	Y	N	
C07			Y	Y	0.00	Y	Y	Y	Y	N	
C08			Y	Y	0.00	Y	Y	Y	Y	N	
C09			Y	Y	0.00	Y	Y	Y	Y	N	
C10			Y	Y	0.00	Y	Y	Y	Y	N	
C11			Y	Y	0.00	Y	Y	Y	Y	N	
C12			Y	Y	0.00	Y	Y	Y	Y	N	
C13			Y	Y	0.00	Y	Y	Y	Y	N	
C14			Y	Y	0.00	Y	Y	Y	Y	N	
C15			Y	Y	0.00	Y	Y	Y	Y	N	
C16			Y	Y	0.00	Y	Y	Y	Y	N	
C17			Y	Y	0.00	Y	Y	Y	Y	N	
C18			Y	Y	0.00	Y	Y	Y	Y	N	
C19			Y	Y	0.00	Y	Y	Y	Y	N	
C20	Jogging Frequency	0.00 to 500.00 Hz	Y	Y	0.00	Y	Y	Y	N	5-109	
C30	Frequency Command 2	0: Enable \odot / \ominus keys on the keypad 1: Voltage input to terminal [12] (-10 to +10 VDC) 2: Current input to terminal [C1] (4 to 20 mA DC) 3: Sum of voltage and current inputs to terminals [12] and [C1] 5: Voltage input to terminal [V2] (-10 to +10 VDC) 7: Terminal command UP/DOWN control 8: Enable \odot / \ominus keys on the keypad (balanceless-bumpless switching available) 11: Digital input interface card (option) 12: Pulse train input	N	Y	2	Y	Y	Y	N	5-34 5-109	
C31	Analog Input Adjustment for [12] (Offset)	-5.0% to 5.0%	Y*	Y	0.0	Y	Y	Y	Y	Y	5-109
C32	(Gain)	0.00% to 400.00%	Y*	Y	100.00	Y	Y	Y	Y	Y	
C33	(Filter time constant)	0.00 to 5.00 s	Y	Y	0.05	Y	Y	Y	Y	Y	
C34	(Gain base point)	0.00% to 100.00%	Y*	Y	100.00	Y	Y	Y	Y	Y	
C35	(Polarity)	0: Bipolar 1: Unipolar	N	Y	1	Y	Y	Y	Y	Y	
C36	Analog Input Adjustment for [C1] (Offset)	-5.0% to 5.0%	Y*	Y	0.0	Y	Y	Y	Y	Y	
C37	(Gain)	0.00% to 400.00%	Y*	Y	100.00	Y	Y	Y	Y	Y	
C38	(Filter time constant)	0.00 to 5.00s	Y	Y	0.05	Y	Y	Y	Y	Y	
C39	(Gain base point)	0.00% to 100.00%	Y*	Y	100.00	Y	Y	Y	Y	Y	
C41	Analog Input Adjustment for [V2] (Offset)	-5.0% to 5.0%	Y*	Y	0.0	Y	Y	Y	Y	Y	
C42	(Gain)	0.00% to 400.00%	Y*	Y	100.00	Y	Y	Y	Y	Y	
C43	(Filter time constant)	0.00 to 5.00 s	Y	Y	0.05	Y	Y	Y	Y	Y	
C44	(Gain base point)	0.00% to 100.00%	Y*	Y	100.00	Y	Y	Y	Y	Y	
C45	(Polarity)	0: Bipolar 1: Unipolar	N	Y	1	Y	Y	Y	Y	Y	
C50	Bias (Frequency command 1) (Bias base point)	0.00% to 100.00%	Y*	Y	0.00	Y	Y	Y	Y	Y	5-34 5-110
C51	Bias (PID command 1) (Bias value)	-100.00% to 100.00%	Y*	Y	0.00	Y	Y	Y	Y	Y	5-110
C52	(Bias base point)	0.00% to 100.00%	Y*	Y	0.00	Y	Y	Y	Y	Y	
C53	Selection of Normal/Inverse Operation (Frequency command 1)	0: Normal operation 1: Inverse operation	Y	Y	0	Y	Y	Y	Y	Y	5-79 5-110

P codes: Motor 1 Parameters

Code	Name	Data setting range	Change when running	Data copying	Default setting	Drive control					Refer to page:
						V/f	PG V/f	w/o PG	w/ PG	Torque control	
P01	Motor 1 (No. of poles)	2 to 22 poles	N	Y1 Y2	4	Y	Y	Y	Y	Y	5-111
P02	(Rated capacity)	0.01 to 1000 kW (when P99 = 0, 2, 3 or 4) 0.01 to 1000 HP (when P99 = 1)	N	Y1 Y2	*7	Y	Y	Y	Y	Y	
P03	(Rated current)	0.00 to 2000 A	N	Y1 Y2	*7	Y	Y	Y	Y	Y	
P04	(Auto-tuning)	0: Disable 1: Tune while the motor stops. (%R1, %X and rated slip frequency) 2: Tune while the motor is rotating under V/f control (%R1, %X, rated slip frequency, no-load current, magnetic saturation factors 1 to 5, and magnetic saturation extension factors "a" to "c") 3: Tune while the motor is rotating under vector control (%R1, %X, rated slip frequency, no-load current, magnetic saturation factors 1 to 5, and magnetic saturation extension factors "a" to "c." Available when the vector control is enabled.)	N	N	0	Y	Y	Y	Y	Y	5-112
P05	(Online tuning)	0: Disable 1: Enable	Y	Y	0	Y	N	N	N	N	5-113
P06	(No-load current)	0.00 to 2000 A	N	Y1 Y2	*7	Y	Y	Y	Y	Y	
P07	(%R1)	0.00% to 50.00%	Y	Y1 Y2	*7	Y	Y	Y	Y	Y	
P08	(%X)	0.00% to 50.00%	Y	Y1 Y2	*7	Y	Y	Y	Y	Y	
P09	(Slip compensation gain for driving)	0.0% to 200.0%	Y*	Y	100.0	Y	Y	Y	Y	N	5-114
P10	(Slip compensation response time)	0.01 to 10.00 s	Y	Y1 Y2	0.12	Y	Y	N	N	N	
P11	(Slip compensation gain for braking)	0.0% to 200.0%	Y*	Y	100.0	Y	Y	Y	Y	N	
P12	(Rated slip frequency)	0.00 to 15.00 Hz	N	Y1 Y2	*7	Y	Y	Y	Y	N	
P13	(Iron loss factor 1)	0.00% to 20.00%	Y	Y1 Y2	*7	Y	Y	Y	Y	Y	
P14	(Iron loss factor 2)	0.00% to 20.00%	Y	Y1 Y2	0.00	Y	Y	Y	Y	Y	
P15	(Iron loss factor 3)	0.00% to 20.00%	Y	Y1 Y2	0.00	Y	Y	Y	Y	Y	
P16	(Magnetic saturation factor 1)	0.0% to 300.0%	Y	Y1 Y2	*7	Y	Y	Y	Y	Y	
P17	(Magnetic saturation factor 2)	0.0% to 300.0%	Y	Y1 Y2	*7	Y	Y	Y	Y	Y	
P18	(Magnetic saturation factor 3)	0.0% to 300.0%	Y	Y1 Y2	*7	Y	Y	Y	Y	Y	
P19	(Magnetic saturation factor 4)	0.0% to 300.0%	Y	Y1 Y2	*7	Y	Y	Y	Y	Y	
P20	(Magnetic saturation factor 5)	0.0% to 300.0%	Y	Y1 Y2	*7	Y	Y	Y	Y	Y	
P21	(Magnetic saturation extension factor "a")	0.0% to 300.0%	Y	Y1 Y2	*7	Y	Y	Y	Y	Y	
P22	(Magnetic saturation extension factor "b")	0.0% to 300.0%	Y	Y1 Y2	*7	Y	Y	Y	Y	Y	
P23	(Magnetic saturation extension factor "c")	0.0% to 300.0%	Y	Y1 Y2	*7	Y	Y	Y	Y	Y	
P53	(%X correction factor 1)	0% to 300%	Y	Y1 Y2	100	Y	Y	Y	Y	Y	5-115
P54	(%X correction factor 2)	0% to 300%	Y	Y1 Y2	100	Y	Y	Y	Y	Y	
P55	(Torque current under vector control)	0.00 to 2000 A	N	Y1 Y2	*7	N	N	Y	Y	Y	
P56	(Induced voltage factor under vector control)	50% to 100%	N	Y1 Y2	85 (90) *8	N	N	Y	Y	Y	
P57	Reserved *9	—	-	-	-	-	-	-	-	-	—
P99	Motor 1 Selection	0: Motor characteristics 0 (Fuji standard motors, 8-series) 1: Motor characteristics 1 (HP rating motors) 2: Motor characteristics 2 (Fuji motors exclusively designed for vector control) 3: Motor characteristics 3 (Fuji standard motors, 6-series) 4: Other motors	N	Y1 Y2	1	Y	Y	Y	Y	Y	5-115

The shaded function codes () are applicable to the quick setup.

*7 The motor parameters are automatically set, depending upon the inverter's capacity. See Table B.

*8 85% for inverters of 150 HP or less; 90% for those of 175 HP or above.

*9 Factory use. Do not access these function codes.

F codes
E codes
C codes
P codes
H codes
A codes
b codes
r codes
J codes
d codes
U codes
y codes

H codes: High Performance Functions

Code	Name	Data setting range	Change when running	Data copying	Default setting	Drive control					Refer to page:
						V/f	PG V/f	w/o PG	w/ PG	Torque control	
H03	Data Initialization	0: Disable initialization 1: Initialize all function code data to the factory defaults 2: Initialize motor 1 parameters 3: Initialize motor 2 parameters 4: Initialize motor 3 parameters 5: Initialize motor 4 parameters	N	N	0	Y	Y	Y	Y	Y	5-116
H04	Auto-reset (Times)	0: Disable; 1 to 10	Y	Y	0	Y	Y	Y	Y	Y	5-117
H05	(Reset interval)	0.5 to 20.0 s	Y	Y	5.0	Y	Y	Y	Y	Y	
H06	Cooling Fan ON/OFF Control	0: Disable (Always in operation) 1: Enable (ON/OFF controllable)	Y	Y	0	Y	Y	Y	Y	Y	5-118
H07	Acceleration/Deceleration Pattern	0: Linear 1: S-curve (Weak) 2: S-curve (Arbitrary, according to H57 to H60 data) 3: Curvilinear	Y	Y	0	Y	Y	Y	Y	N	5-45 5-118
H08	Rotational Direction Limitation	0: Disable 1: Enable (Reverse rotation inhibited) 2: Enable (Forward rotation inhibited)	N	Y	0	Y	Y	Y	Y	N	5-118
H09	Starting Mode (Auto search)	0: Disable 1: Enable (At restart after momentary power failure) 2: Enable (At restart after momentary power failure and at normal start)	N	Y	0	Y	Y	N	N	N	5-119
H11	Deceleration Mode	0: Normal deceleration 1: Coast-to-stop	Y	Y	0	Y	Y	Y	Y	N	5-120
H12	Instantaneous Overcurrent Limiting (Mode selection)	0: Disable 1: Enable	Y	Y	1	Y	Y	N	N	N	5-75 5-120
H13	Restart Mode after Momentary Power Failure (Restart time)	0.1 to 20.0 s	Y	Y1 Y2	*10	Y	Y	Y	Y	N	5-51 5-120
H14	(Frequency fall rate)	0.00: Deceleration time selected by F08, 0.01 to 100.00 Hz/s, 999: Follow the current limit command	Y	Y	999	Y	Y	Y	N	N	
H15	(Continuous running level)	200 to 300 V for 230 V series 400 to 600 V for 460 V series	Y	Y2	235 470	Y	Y	N	N	N	
H16	(Allowable momentary power failure time)	0.0 to 30.0 s 999: Automatically determined by inverter	Y	Y	999	Y	Y	Y	Y	N	
H18	Torque Control (Mode selection)	0: Disable (Speed control) 2: Enable (Torque current command) 3: Enable (Torque command)	N	Y	0	N	N	Y	Y	Y	5-121
H26	Thermistor (for motor) (Mode selection)	0: Disable 1: PTC (The inverter immediately trips with \overline{TH} displayed.) 2: PTC (The inverter issues output signal THM and continues to run.) 3: NTC (When connected)	Y	Y	0	Y	Y	Y	Y	Y	5-122
H27	(Level)	0.00 to 5.00 V	Y	Y	0.35	Y	Y	Y	Y	Y	5-123
H28	Droop Control	-60.0 to 0.0 Hz	Y	Y	0.0	Y	Y	Y	Y	N	5-124
H30	Communications Link Function (Mode selection)	Frequency command Run command 0: F01/C30 F02 1: RS-485 (Port 1) F02 2: F01/C30 RS-485 (Port 1) 3: RS-485 (Port 1) RS-485 (Port 1) 4: RS-485 (Port 2) F02 5: RS-485 (Port 2) RS-485 (Port 1) 6: F01/C30 RS-485 (Port 2) 7: RS-485 (Port 1) RS-485 (Port 2) 8: RS-485 (Port 2) RS-485 (Port 2)	Y	Y	0	Y	Y	Y	Y	Y	
H42	Capacitance of DC Link Bus Capacitor	Indication for replacement of DC link bus capacitor 0 to 65535	Y	N	-	Y	Y	Y	Y	Y	5-125
H43	Cumulative Run Time of Cooling Fan	Indication for replacement of cooling fan 0 to 99990 hours	Y	N	-	Y	Y	Y	Y	Y	
H44	Startup Counter for Motor 1	Indication of cumulative startup count 0 to 65535 times	Y	N	-	Y	Y	Y	Y	Y	5-126
H45	Mock Alarm	0: Disable 1: Enable (Once a mock alarm occurs, the data automatically returns to 0.)	Y	N	0	Y	Y	Y	Y	Y	5-127
H46	Starting Mode (Auto search delay time 2)	0.1 to 20.0 s	Y	Y1 Y2	*7	Y	Y	Y	N	Y	5-119 5-127
H47	Initial Capacitance of DC Link Bus Capacitor	Indication for replacement of DC link bus capacitor 0 to 65535	Y	N	-	Y	Y	Y	Y	Y	5-125 5-127
H48	Cumulative Run Time of Capacitors on Printed Circuit Boards	Indication for replacement of capacitors 0 to 99990 hours (The cumulative run time can be modified or reset.)	Y	N	-	Y	Y	Y	Y	Y	

*7 The motor parameters are automatically set, depending upon the inverter's capacity. See Table B

*10 The factory default differs depending upon the inverter's capacity. See Table A.

Code	Name	Data setting range	Change when running	Data copying	Default setting	Drive control					Refer to page:
						V/f	PG V/f	w/o PG	w/ PG	Torque control	
H49	Starting Mode (Auto search delay time 1)	0.0 to 10.0 s	Y	Y	0.0	Y	Y	Y	Y	Y	5-119 5-127
H50	Non-linear V/f Pattern 1 (Frequency)	0.0: Cancel, 0.1 to 500.0 Hz	N	Y	0.0	Y	Y	N	N	N	5-43 5-127
H51	(Voltage)	0 to 240: Output an AVR-controlled voltage (for 230 V series) 0 to 500: Output an AVR-controlled voltage (for 460 V series)	N	Y2	0	Y	Y	N	N	N	
H52	Non-linear V/f Pattern 2 (Frequency)	0.0: Cancel, 0.1 to 500.0 Hz	N	Y	0.0	Y	Y	N	N	N	5-43 5-127
H53	(Voltage)	0 to 240: Output an AVR-controlled voltage (for 230 V series) 0 to 500: Output an AVR-controlled voltage (for 460 V series)	N	Y2	0	Y	Y	N	N	N	
H54	Acceleration Time (Jogging)	0.00 to 6000 s	Y	Y	*1	Y	Y	Y	Y	N	5-45
H55	Deceleration Time (Jogging)	0.00 to 6000 s	Y	Y	*1	Y	Y	Y	Y	N	5-127
H56	Deceleration Time for Forced Stop	0.00 to 6000 s	Y	Y	*1	Y	Y	Y	Y	N	
H57	1st S-curve acceleration range (Leading edge)	0% to 100%	Y	Y	10	Y	Y	Y	Y	N	5-127
H58	2nd S-curve acceleration range (Trailing edge)	0% to 100%	Y	Y	10	Y	Y	Y	Y	N	
H59	1st S-curve deceleration range (Leading edge)	0% to 100%	Y	Y	10	Y	Y	Y	Y	N	5-127
H60	2nd S-curve deceleration range (Trailing edge)	0% to 100%	Y	Y	10	Y	Y	Y	Y	N	
H61	UP/DOWN Control (Initial frequency setting)	0: 0.00 Hz 1: Last UP/DOWN command value on releasing the run command	N	Y	1	Y	Y	Y	Y	N	5-34 5-127
H63	Low Limiter (Mode selection)	0: Limit by F16 (Frequency limiter: Low) and continue to run 1: If the output frequency lowers below the one limited by F16 (Frequency limiter: Low), decelerate to stop the motor.	Y	Y	0	Y	Y	Y	Y	N	5-57 5-127
H64	(Lower limiting frequency)	0.0: Depends on F16 (Frequency limiter, Low) 0.1 to 60.0 Hz	Y	Y	1.6	Y	Y	N	N	N	5-127
H65	Non-linear V/f Pattern 3 (Frequency)	0.0: Cancel, 0.1 to 500.0 Hz	N	Y	0.0	Y	Y	N	N	N	5-43
H66	(Voltage)	0 to 240: Output an AVR-controlled voltage (for 230 V series) 0 to 500: Output an AVR-controlled voltage (for 460 V series)	N	Y2	0	Y	Y	N	N	N	5-127
H67	Auto Energy Saving Operation (Mode selection)	0: Enable during running at constant speed 1: Enable in all modes	Y	Y	0	Y	Y	N	Y	N	5-64 5-127
H68	Slip Compensation 1 (Operating conditions)	0: Enable during ACC/DEC and at base frequency or above 1: Disable during ACC/DEC and enable at base frequency or above 2: Enable during ACC/DEC and disable at base frequency or above 3: Disable during ACC/DEC and at base frequency or above	N	Y	0	Y	Y	N	N	N	5-73 5-127
H69	Automatic Deceleration (Mode selection)	0: Disable 2: Torque limit control with Force-to-stop if actual deceleration time exceeds three times the specified one 3: DC link bus voltage control with Force-to-stop if actual deceleration time exceeds three times the specified one 4: Torque limit control with Force-to-stop disabled 5: DC link bus voltage control with Force-to-stop disabled	Y	Y	0	Y	Y	Y	Y	N	5-128
H70	Overload Prevention Control	0.00: Follow the deceleration time selected 0.01 to 100.0 Hz/s 999: Cancel	Y	Y	999	Y	Y	Y	Y	N	5-129
H71	Deceleration Characteristics	0: Disable 1: Enable	Y	Y	0	Y	Y	N	N	N	
H72	Main Power Down Detection (Mode selection)	0: Disable 1: Enable	Y	Y	1	Y	Y	Y	Y	Y	

*1 6.00 s for inverters of 40 HP or below; 20.00 s for those of 50 HP or above

F codes
E codes
C codes
P codes
H codes
A codes
b codes
r codes
J codes
d codes
U codes
y codes

Code	Name	Data setting range	Change when running	Data copying	Default setting	Drive control					Refer to page:
						V/f	PG V/f	w/o PG	w/ PG	Torque control	
H73	Torque Limiter (Operating conditions)	0: Enable during ACC/DEC and running at constant speed 1: Disable during ACC/DEC and enable during running at constant speed 2: Enable during ACC/DEC and disable during running at constant speed	N	Y	0	Y	Y	Y	Y	Y	5-66 5-129
H74	(Control target)	0: Motor-generating torque limit 1: Torque current limit 2: Output power limit	N	Y	1	N	N	Y	Y	Y	
H75	(Target quadrants)	0: Drive/brake 1: Same for all four quadrants 2: Upper/lower limits	N	Y	0	N	N	Y	Y	Y	
H76	(Frequency increment limit for braking)	0.0 to 500.0 Hz	Y	Y	5.0	Y	Y	N	N	N	5-128 5-129
H77	Service Life of DC Link Bus Capacitor (Remaining time)	0 to 87600 hours	Y	N	-	Y	Y	Y	Y	Y	5-130
H78	Maintenance Interval (M1)	0: Disable; 1 to 99990 hours	Y	N	87600	Y	Y	Y	Y	Y	5-126
H79	Preset Startup Count for Maintenance (M1)	0: Disable; 1 to 65535 times	Y	N	0	Y	Y	Y	Y	Y	5-130
H80	Output Current Fluctuation Damping Gain for Motor 1	0.00 to 1.00	Y	Y	0.20	Y	Y	N	N	Y	5-130
H81	Light Alarm Selection 1	0000 to FFFF (hex.)	Y	Y	0000	Y	Y	Y	Y	Y	
H82	Light Alarm Selection 2	0000 to FFFF (hex.)	Y	Y	0000	Y	Y	Y	Y	Y	
H84	Pre-excitation (Initial level)	100% to 400%	Y	Y	100	N	N	Y	Y	Y	5-133
H85	(Time)	0.00: Disable; 0.01 to 30.00 s	Y	Y	0.00	N	N	Y	Y	Y	
H86	Reserved *9	—	-	-	-	-	-	-	-	-	5-134
H87	Reserved *9	—	-	-	-	-	-	-	-	-	
H88	Reserved *9	—	-	-	-	-	-	-	-	-	
H89	Reserved *9	—	-	-	-	-	-	-	-	-	
H90	Reserved *9	—	-	-	-	-	-	-	-	-	
H91	PID Feedback Wire Break Detection	0.0: Disable alarm detection 0.1 to 60.0 s	Y	Y	0.0	Y	Y	Y	Y	N	5-134
H92	Continuity of Running (P)	0.000 to 10.000 times; 999	Y	Y1Y2	999	Y	Y	N	N	N	5-51
H93	(I)	0.010 to 10.000 s; 999	Y	Y1Y2	999	Y	Y	N	N	N	5-134
H94	Cumulative Motor Run Time 1	0 to 99990 hours (The cumulative run time can be modified or reset.)	N	N	-	Y	Y	Y	Y	Y	5-126 5-134
H95	DC Braking (Braking response mode)	0: Slow 1: Quick	Y	Y	1	Y	Y	N	N	N	5-58 5-134
H96	STOP Key Priority/ Start Check Function	Data STOP key priority Start check function 0: Disable Disable 1: Enable Disable 2: Disable Enable 3: Enable Enable	Y	Y	3	Y	Y	Y	Y	Y	5-134
H97	Clear Alarm Data	0: Disable 1: Enable (Setting "1" clears alarm data and then returns to "0.")	Y	N	0	Y	Y	Y	Y	Y	
H98	Protection/Maintenance Function (Mode selection)	0 to 255: Display data in decimal format Bit 0: Lower the carrier frequency automatically (0: Disabled; 1: Enabled) Bit 1: Detect input phase loss (0: Disabled; 1: Enabled) Bit 2: Detect output phase loss (0: Disabled; 1: Enabled) Bit 3: Select life judgment threshold of DC link bus capacitor (0: Factory default level; 1: User setup level) Bit 4: Judge the life of DC link bus capacitor (0: Disabled; 1: Enabled) Bit 5: Detect DC fan lock (0: Enabled; 1: Disabled) Bit 6: Detect braking transistor error (for 40 HP or below) (0: Disabled; 1: Enabled) Bit 7: Switch IP20/IP40 enclosure (0: IP20; 1: IP40)	Y	Y	83	Y	Y	Y	Y	Y	5-135

*9 Factory use. Do not access these function codes.

A codes: Motor 2 Parameters

Code	Name	Data setting range	Change when running	Data copying	Default setting	Drive control					Refer to page:
						V/f	PG V/f	w/o PG	w/PG	Torque control	
A01	Maximum Frequency 2	25.0 to 500.0 Hz	N	Y	60.0	Y	Y	Y	Y	Y	—
A02	Base Frequency 2	25.0 to 500.0 Hz	N	Y	60.0	Y	Y	Y	Y	Y	
A03	Rated Voltage at Base Frequency 2	0: Output a voltage in proportion to input voltage 80 to 240: Output an AVR-controlled voltage (for 230 V series) 160 to 500: Output an AVR-controlled voltage (for 460 V series)	N	Y2	230 460	Y	Y	Y	Y	Y	
A04	Maximum Output Voltage 2	80 to 240: Output an AVR-controlled voltage (for 230 V series) 160 to 500: Output an AVR-controlled voltage (for 460 V series)	N	Y2	230 460	Y	Y	N	N	Y	
A05	Torque Boost 2	0.0% to 20.0% (percentage with respect to "A03: Rated Voltage at Base Frequency 2")	Y	Y	0.0	Y	Y	N	N	N	
A06	Electronic Thermal Overload Protection for Motor 2 (Select motor characteristics)	1: For a general-purpose motor with shaft-driven cooling fan 2: For an inverter-driven motor, non-ventilated motor, or motor with separately powered cooling fan	Y	Y	1	Y	Y	Y	Y	Y	
A07	(Overload detection level)	0.00: Disable 1% to 135% of the rated current (allowable continuous drive current) of the motor	Y	Y1 Y2	*2	Y	Y	Y	Y	Y	
A08	(Thermal time constant)	0.5 to 75.0 min	Y	Y	*3	Y	Y	Y	Y	Y	
A09	DC Braking 2 (Braking starting frequency)	0.0 to 60.0 Hz	Y	Y	0.0	Y	Y	Y	Y	N	
A10	(Braking level)	0% to 80% (LD/MD mode)*4, 0% to 100% (HD mode)	Y	Y	0	Y	Y	Y	Y	N	
A11	(Braking time)	0.00: Disable; 0.01 to 30.00 s	Y	Y	0.00	Y	Y	Y	Y	N	
A12	Starting Frequency 2	0.0 to 60.0 Hz	Y	Y	0.5	Y	Y	Y	Y	N	
A13	Load Selection/ Auto Torque Boost Auto Energy Saving Operation 2	0: Variable torque load 1: Constant torque load 2: Auto-torque boost 3: Auto-energy saving operation (Variable torque load during ACC/DEC) 4: Auto-energy saving operation (Constant torque load during ACC/DEC) 5: Auto-energy saving operation (Auto-torque boost during ACC/DEC)	N	Y	1	Y	Y	N	Y	N	
A14	Drive Control Selection 2	0: V/f control with slip compensation inactive 1: Dynamic torque vector control 2: V/f control with slip compensation active 3: V/f control with speed sensor 4: Dynamic torque vector control with speed sensor 5: Vector control without speed sensor 6: Vector control with speed sensor	N	Y	0	Y	Y	Y	Y	Y	
A15	Motor 2 (No. of poles)	2 to 22 poles	N	Y1 Y2	4	Y	Y	Y	Y	Y	
A16	(Rated capacity)	0.01 to 1000 kW (when A39 = 0, 2, 3 or 4) 0.01 to 1000 HP (when A39 = 1)	N	Y1 Y2	*7	Y	Y	Y	Y	Y	
A17	(Rated current)	0.00 to 2000 A	N	Y1 Y2	*7	Y	Y	Y	Y	Y	

*2 The motor rated current is automatically set. See Table B (P03/A17/b17/r17).

*3 5.0 min for inverters of 40 HP or below; 10.0 min for those of 50 HP or above

*4 0% to 100% for inverters of 7.5 HP or below

*7 The motor parameters are automatically set, depending upon the inverter's capacity. See Table B.

F codes
E codes
C codes
P codes
H codes
A codes
b codes
r codes
J codes
d codes
U codes
y codes

Code	Name	Data setting range	Change when running	Data copying	Default setting	Drive control					Refer to page:
						V/f	PG V/f	w/o PG	w/ PG	Torque control	
A18	Motor 2 (Auto-tuning)	0: Disable 1: Tune while the motor stops. (%R1, %X and rated slip frequency) 2: Tune while the motor is rotating under V/f control (%R1, %X, rated slip frequency, no-load current, magnetic saturation factors 1 to 5, and magnetic saturation extension factors "a" to "c") 3: Tune while the motor is rotating under vector control (%R1, %X, rated slip frequency, no-load current, magnetic saturation factors 1 to 5, and magnetic saturation extension factors "a" to "c." Available when the vector control is enabled.	N	N	0	Y	Y	Y	Y	Y	—
A19	(Online tuning)	0: Disable 1: Enable	Y	Y	0	Y	N	N	N	N	
A20	(No-load current)	0.00 to 2000 A	N	Y1 Y2	*7	Y	Y	Y	Y	Y	
A21	(%R1)	0.00% to 50.00%	Y	Y1 Y2	*7	Y	Y	Y	Y	Y	
A22	(%X)	0.00% to 50.00%	Y	Y1 Y2	*7	Y	Y	Y	Y	Y	
A23	(Slip compensation gain for driving)	0.0% to 200.0%	Y*	Y	100.0	Y	Y	Y	Y	N	
A24	(Slip compensation response time)	0.01 to 10.00s	Y	Y1 Y2	0.12	Y	Y	N	N	N	
A25	(Slip compensation gain for braking)	0.0% to 200.0%	Y*	Y	100.0	Y	Y	Y	Y	N	
A26	(Rated slip frequency)	0.00 to 15.00 Hz	N	Y1 Y2	*7	Y	Y	Y	Y	N	
A27	(Iron loss factor 1)	0.00% to 20.00%	Y	Y1 Y2	*7	Y	Y	Y	Y	Y	
A28	(Iron loss factor 2)	0.00% to 20.00%	Y	Y1 Y2	0.00	Y	Y	Y	Y	Y	
A29	(Iron loss factor 3)	0.00% to 20.00%	Y	Y1 Y2	0.00	Y	Y	Y	Y	Y	
A30	(Magnetic saturation factor 1)	0.0% to 300.0%	Y	Y1 Y2	*7	Y	Y	Y	Y	Y	
A31	(Magnetic saturation factor 2)	0.0% to 300.0%	Y	Y1 Y2	*7	Y	Y	Y	Y	Y	
A32	(Magnetic saturation factor 3)	0.0% to 300.0%	Y	Y1 Y2	*7	Y	Y	Y	Y	Y	
A33	(Magnetic saturation factor 4)	0.0% to 300.0%	Y	Y1 Y2	*7	Y	Y	Y	Y	Y	
A34	(Magnetic saturation factor 5)	0.0% to 300.0%	Y	Y1 Y2	*7	Y	Y	Y	Y	Y	
A35	(Magnetic saturation extension factor "a")	0.0% to 300.0%	Y	Y1 Y2	*7	Y	Y	Y	Y	Y	
A36	(Magnetic saturation extension factor "b")	0.0% to 300.0%	Y	Y1 Y2	*7	Y	Y	Y	Y	Y	
A37	(Magnetic saturation extension factor "c")	0.0% to 300.0%	Y	Y1 Y2	*7	Y	Y	Y	Y	Y	
A39	Motor 2 Selection	0: Motor characteristics 0 (Fuji standard motors, 8-series) 1: Motor characteristics 1 (HP rating motors) 2: Motor characteristics 2 (Fuji motors exclusively designed for vector control) 3: Motor characteristics 3 (Fuji standard motors, 6-series) 4: Other motors	N	Y1 Y2	1	Y	Y	Y	Y	Y	
A40	Slip Compensation 2 (Operating conditions)	0: Enable during ACC/DEC and at base frequency or above 1: Disable during ACC/DEC and enable at base frequency or above 2: Enable during ACC/DEC and disable at base frequency or above 3: Disable during ACC/DEC and at base frequency or above	N	Y	0	Y	Y	N	N	N	
A41	Output Current Fluctuation Damping Gain for Motor 2	0.00 to 1.00	Y	Y	0.20	Y	Y	N	N	N	
A42	Motor/Parameter Switching 2 (Mode selection)	0: Motor (Switch to the 2nd motor) 1: Parameter (Switch to particular A codes)	N	Y	0	Y	Y	Y	Y	Y	5-137
A43	Speed Control 2 (Speed command filter)	0.000 to 5.000 s	Y	Y	0.020	N	Y	Y	Y	N	—
A44	(Speed detection filter)	0.000 to 0.100 s	Y*	Y	0.005	N	Y	Y	Y	N	
A45	P (Gain)	0.1 to 200.0 times	Y*	Y	10.0	N	Y	Y	Y	N	
A46	I (Integral time)	0.001 to 9.999 s	Y*	Y	0.100	N	Y	Y	Y	N	
A48	(Output filter)	0.000 to 0.100 s	Y	Y	0.002	N	Y	Y	Y	N	
A49	(Notch filter resonance frequency)	1 to 200 Hz	Y	Y	200	N	N	N	Y	N	
A50	(Notch filter attenuation level)	0 to 20 dB	Y	Y	0	N	N	N	Y	N	
A51	Cumulative Motor Run Time 2	0 to 99990 hours (The cumulative run time can be modified or reset.)	N	N	-	Y	Y	Y	Y	Y	
A52	Startup Counter for Motor 2	Indication of cumulative startup count 0 to 65535 times	Y	N	-	Y	Y	Y	Y	Y	
A53	Motor 2 (%X correction factor 1)	0% to 300%	Y	Y1 Y2	100	Y	Y	Y	Y	Y	
A54	(%X correction factor 2)	0% to 300%	Y	Y1 Y2	100	Y	Y	Y	Y	Y	
A55	(Torque current under vector control)	0.00 to 2000 A	N	Y1 Y2	*7	N	N	Y	Y	Y	
A56	(Induced voltage factor under vector control)	50 to 100	N	Y1 Y2	85 (90) *8	N	N	Y	Y	Y	
A57	Reserved *9	—	-	-	-	-	-	-	-	-	

*7 The motor parameters are automatically set, depending upon the inverter's capacity. See Table B.

*8 85% for inverters of 150 HP or less; 90% for those of 175 HP or above.

*9 Factory use. Do not access these function codes.

b codes: Motor 3 Parameters

Code	Name	Data setting range	Change when running	Data copying	Default setting	Drive control					Refer to page:
						V/f	PG V/f	w/o PG	w/ PG	Torque control	
b01	Maximum Frequency 3	25.0 to 500.0 Hz	N	Y	60.0	Y	Y	Y	Y	Y	—
b02	Base Frequency 3	25.0 to 500.0 Hz	N	Y	60.0	Y	Y	Y	Y	Y	
b03	Rated Voltage at Base Frequency 3	0: Output a voltage in proportion to input voltage 80 to 240: Output an AVR-controlled voltage (for 230 V series) 160 to 500: Output an AVR-controlled voltage (for 460 V series)	N	Y2	230 460	Y	Y	Y	Y	Y	
b04	Maximum Output Voltage 3	80 to 240: Output an AVR-controlled voltage (for 230 V series) 160 to 500: Output an AVR-controlled voltage (for 460 V series)	N	Y2	230 460	Y	Y	N	N	Y	
b05	Torque Boost 3	0.0% to 20.0% (percentage with respect to "b03: Rated Voltage at Base Frequency 3")	Y	Y	0.0	Y	Y	N	N	N	
b06	Electronic Thermal Overload Protection for Motor 3 (Select motor characteristics)	1: For a general-purpose motor with shaft-driven cooling fan 2: For an inverter-driven motor, non-ventilated motor, or motor with separately powered cooling fan	Y	Y	1	Y	Y	Y	Y	Y	
b07	(Overload detection level)	0.00: Disable 1% to 135% of the rated current (allowable continuous drive current) of the motor	Y	Y1 Y2	*2	Y	Y	Y	Y	Y	
b08	(Thermal time constant)	0.5 to 75.0 min	Y	Y	*3	Y	Y	Y	Y	Y	
b09	DC Braking 3 (Braking starting frequency)	0.0 to 60.0 Hz	Y	Y	0.0	Y	Y	Y	Y	N	
b10	(Braking level)	0% to 80% (LD/MD mode)*4, 0% to 100% (HD mode)	Y	Y	0	Y	Y	Y	Y	N	
b11	(Braking time)	0.00: Disable; 0.01 to 30.00 s	Y	Y	0.00	Y	Y	Y	Y	N	
b12	Starting Frequency 3	0.0 to 60.0 Hz	Y	Y	0.5	Y	Y	Y	Y	N	
b13	Load Selection/ Auto Torque Boost/ Auto Energy Saving Operation 3	0: Variable torque load 1: Constant torque load 2: Auto-torque boost 3: Auto-energy saving operation (Variable torque load during ACC/DEC) 4: Auto-energy saving operation (Constant torque load during ACC/DEC) 5: Auto-energy saving operation (Auto-torque boost during ACC/DEC)	N	Y	1	Y	Y	N	Y	N	
b14	Drive Control Selection 3	0: V/f control with slip compensation inactive 1: Dynamic torque vector control 2: V/f control with slip compensation active 3: V/f control with speed sensor 4: Dynamic torque vector control with speed sensor 5: Vector control without speed sensor 6: Vector control with speed sensor	N	Y	0	Y	Y	Y	Y	Y	
b15	Motor 3 (No. of poles)	2 to 22 poles	N	Y1 Y2	4	Y	Y	Y	Y	Y	
b16	(Rated capacity)	0.01 to 1000 kW (when b39 = 0, 2, 3 or 4) 0.01 to 1000 HP (when b39 = 1)	N	Y1 Y2	*7	Y	Y	Y	Y	Y	
b17	(Rated current)	0.00 to 2000 A	N	Y1 Y2	*7	Y	Y	Y	Y	Y	
b18	(Auto-tuning)	0: Disable 1: Tune while the motor stops. (%R1, %X and rated slip frequency) 2: Tune while the motor is rotating under V/f control (%R1, %X, rated slip frequency, no-load current, magnetic saturation factors 1 to 5, and magnetic saturation extension factors "a" to "c") 3: Tune while the motor is rotating under vector control (%R1, %X, rated slip frequency, no-load current, magnetic saturation factors 1 to 5, and magnetic saturation extension factors "a" to "c." Available when the vector control is enabled.)	N	N	0	Y	Y	Y	Y	Y	
b19	(Online tuning)	0: Disable 1: Enable	Y	Y	0	Y	N	N	N	N	
b20	(No-load current)	0.00 to 2000 A	N	Y1 Y2	*7	Y	Y	Y	Y	Y	
b21	(%R1)	0.00% to 50.00%	Y	Y1 Y2	*7	Y	Y	Y	Y	Y	
b22	(%X)	0.00% to 50.00%	Y	Y1 Y2	*7	Y	Y	Y	Y	Y	
b23	(Slip compensation gain for driving)	0.0% to 200.0%	Y*	Y	100.0	Y	Y	Y	Y	N	
b24	(Slip compensation response time)	0.01 to 10.00 s	Y	Y1 Y2	0.12	Y	Y	N	N	N	
b25	(Slip compensation gain for braking)	0.0% to 200.0%	Y*	Y	100.0	Y	Y	Y	Y	N	
b26	(Rated slip frequency)	0.00 to 15.00 Hz	N	Y1 Y2	*7	Y	Y	Y	Y	N	
b27	(Iron loss factor 1)	0.00% to 20.00%	Y	Y1 Y2	*7	Y	Y	Y	Y	Y	

*2 The motor rated current is automatically set. See Table B (P03/A17/b17/r17).

*3 5.0 min for inverters of 40 HP or below; 10.0 min for those of 50 HP or above

*4 0% to 100% for inverters of 7.5 HP or below

*7 The motor parameters are automatically set, depending upon the inverter's capacity. See Table B.

F codes
E codes
C codes
P codes
H codes
A codes
b codes
r codes
J codes
d codes
U codes
y codes

Code	Name	Data setting range	Change when running	Data copying	Default setting	Drive control					Refer to page:
						V/f	PG V/f	w/o PG	w/ PG	Torque control	
b28	(Iron loss factor 2)	0.00% to 20.00%	Y	Y1 Y2	0.00	Y	Y	Y	Y	Y	—
b29	(Iron loss factor 3)	0.00% to 20.00%	Y	Y1 Y2	0.00	Y	Y	Y	Y	Y	
b30	(Magnetic saturation factor 1)	0.0% to 300.0%	Y	Y1 Y2	*7	Y	Y	Y	Y	Y	
b31	(Magnetic saturation factor 2)	0.0% to 300.0%	Y	Y1 Y2	*7	Y	Y	Y	Y	Y	
b32	(Magnetic saturation factor 3)	0.0% to 300.0%	Y	Y1 Y2	*7	Y	Y	Y	Y	Y	
b33	(Magnetic saturation factor 4)	0.0% to 300.0%	Y	Y1 Y2	*7	Y	Y	Y	Y	Y	
b34	(Magnetic saturation factor 5)	0.0% to 300.0%	Y	Y1 Y2	*7	Y	Y	Y	Y	Y	
b35	Motor 3 (Magnetic saturation extension factor "a")	0.0% to 300.0%	Y	Y1 Y2	*7	Y	Y	Y	Y	Y	
b36	(Magnetic saturation extension factor "b")	0.0% to 300.0%	Y	Y1 Y2	*7	Y	Y	Y	Y	Y	
b37	(Magnetic saturation extension factor "c")	0.0% to 300.0%	Y	Y1 Y2	*7	Y	Y	Y	Y	Y	
b39	Motor 3 Selection	0: Motor characteristics 0 (Fuji standard motors, 8-series) 1: Motor characteristics 1 (HP rating motors) 2: Motor characteristics 2 (Fuji motors exclusively designed for vector control) 3: Motor characteristics 3 (Fuji standard motors, 6-series) 4: Other motors	N	Y1 Y2	1	Y	Y	Y	Y	Y	
b40	Slip Compensation 3 (Operating conditions)	0: Enable during ACC/DEC and at base frequency or above 1: Disable during ACC/DEC and enable at base frequency or above 2: Enable during ACC/DEC and disable at base frequency or above 3: Disable during ACC/DEC and at base frequency or above	N	Y	0	Y	Y	N	N	N	
b41	Output Current Fluctuation Damping Gain for Motor 3	0.00 to 1.00	Y	Y	0.20	Y	Y	N	N	N	
b42	Motor/Parameter Switching 3 (Mode selection)	0: Motor (Switch to the 3rd motor) 1: Parameter (Switch to particular b codes)	N	Y	0	Y	Y	Y	Y	Y	5-137
b43	Speed Control 3 (Speed command filter)	0.000 to 5.000 s	Y	Y	0.020	N	Y	Y	Y	N	—
b44	(Speed detection filter)	0.000 to 0.100 s	Y*	Y	0.005	N	Y	Y	Y	N	
b45	P (Gain)	0.1 to 200.0 times	Y*	Y	10.0	N	Y	Y	Y	N	
b46	I (Integral time)	0.001 to 9.999 s	Y*	Y	0.100	N	Y	Y	Y	N	
b48	(Output filter)	0.000 to 0.100 s	Y	Y	0.002	N	Y	Y	Y	N	
b49	(Notch filter resonance frequency)	1 to 200 Hz	Y	Y	200	N	N	N	Y	N	
b50	(Notch filter attenuation level)	0 to 20 dB	Y	Y	0	N	N	N	Y	N	
b51	Cumulative Motor Run Time 3	0 to 99990 hours (The cumulative run time can be modified or reset.)	N	N	-	Y	Y	Y	Y	Y	
b52	Startup Counter for Motor 3	Indication of cumulative startup count 0 to 65535 times	Y	N	-	Y	Y	Y	Y	Y	
b53	Motor 3 (%X correction factor 1)	0% to 300%	Y	Y1 Y2	100	Y	Y	Y	Y	Y	
b54	(%X correction factor 2)	0% to 300%	Y	Y1 Y2	100	Y	Y	Y	Y	Y	
b55	(Torque current under vector control)	0.00 to 2000 A	N	Y1 Y2	*7	N	N	Y	Y	Y	
b56	(Induced voltage factor under vector control)	50 to 100	N	Y1 Y2	85 (90) *8	N	N	Y	Y	Y	
b57	Reserved *9	—	-	-	-	-	-	-	-	-	

*7 The motor parameters are automatically set, depending upon the inverter's capacity. See Table B.

*8 85% for inverters of 150 HP or less; 90% for those of 175 HP or above.

*9 Factory use. Do not access these function codes.

r codes: Motor 4 Parameters

Code	Name	Data setting range	Change when running	Data copying	Default setting	Drive control					Refer to page:
						V/f	PG V/f	w/o PG	w/ PG	Torque control	
r01	Maximum Frequency 4	25.0 to 500.0 Hz	N	Y	60.0	Y	Y	Y	Y	Y	—
r02	Base Frequency 4	25.0 to 500.0 Hz	N	Y	60.0	Y	Y	Y	Y	Y	
r03	Rated Voltage at Base Frequency 4	0: Output a voltage in proportion to input voltage 80 to 240: Output an AVR-controlled voltage (for 230 V series) 160 to 500: Output an AVR-controlled voltage (for 460 V series)	N	Y2	230 460	Y	Y	Y	Y	Y	
r04	Maximum Output Voltage 4	80 to 240: Output an AVR-controlled voltage (for 230 V series) 160 to 500: Output an AVR-controlled voltage (for 460 V series)	N	Y2	230 460	Y	Y	N	N	Y	
r05	Torque Boost 4	0.0% to 20.0% (percentage with respect to "r03: Rated Voltage at Base Frequency 4")	Y	Y	0.0	Y	Y	N	N	N	
r06	Electronic Thermal Overload Protection for Motor 4 (Select motor characteristics)	1: For a general-purpose motor with shaft-driven cooling fan 2: For an inverter-driven motor, non-ventilated motor, or motor with separately powered cooling fan	Y	Y	1	Y	Y	Y	Y	Y	
r07	(Overload detection level)	0.00: Disable 1% to 135% of the rated current (allowable continuous drive current) of the motor	Y	Y1 Y2	*2	Y	Y	Y	Y	Y	
r08	(Thermal time constant)	0.5 to 75.0 min	Y	Y	*3	Y	Y	Y	Y	Y	
r09	DC Braking 4 (Braking starting frequency)	0.0 to 60.0 Hz	Y	Y	0.0	Y	Y	Y	Y	N	
r10	(Braking level)	0% to 80% (LD/MD mode)*4, 0% to 100% (HD mode)	Y	Y	0	Y	Y	Y	Y	N	
r11	(Braking time)	0.00: Disable; 0.01 to 30.00 s	Y	Y	0.00	Y	Y	Y	Y	N	
r12	Starting Frequency 4	0.0 to 60.0 Hz	Y	Y	0.5	Y	Y	Y	Y	N	
r13	Load Selection/ Auto Torque Boost/ Auto Energy Saving Operation 4	0: Variable torque load 1: Constant torque load 2: Auto-torque boost 3: Auto-energy saving operation (Variable torque load during ACC/DEC) 4: Auto-energy saving operation (Constant torque load during ACC/DEC) 5: Auto-energy saving operation (Auto-torque boost during ACC/DEC)	N	Y	1	Y	Y	N	Y	N	
r14	Drive Control Selection 4	0: V/f control with slip compensation inactive 1: Dynamic torque vector control 2: V/f control with slip compensation active 3: V/f control with speed sensor 4: Dynamic torque vector control with speed sensor 5: Vector control without speed sensor 6: Vector control with speed sensor	N	Y	0	Y	Y	Y	Y	Y	
r15	Motor 4 (No. of poles)	2 to 22 poles	N	Y1 Y2	4	Y	Y	Y	Y	Y	
r16	(Rated capacity)	0.01 to 1000 kW (when r39 = 0, 2, 3 or 4) 0.01 to 1000 HP (when r39 = 1)	N	Y1 Y2	*7	Y	Y	Y	Y	Y	
r17	(Rated current)	0.00 to 2000 A	N	Y1 Y2	*7	Y	Y	Y	Y	Y	
r18	(Auto-tuning)	0: Disable 1: Tune while the motor stops. (%R1, %X and rated slip frequency) 2: Tune while the motor is rotating under V/f control (%R1, %X, rated slip frequency, no-load current, magnetic saturation factors 1 to 5, and magnetic saturation extension factors "a" to "c") 3: Tune while the motor is rotating under vector control (%R1, %X, rated slip frequency, no-load current, magnetic saturation factors 1 to 5, and magnetic saturation extension factors "a" to "c." Available when the vector control is enabled.)	N	N	0	Y	Y	Y	Y	Y	
r19	(Online tuning)	0: Disable 1: Enable	Y	Y	0	Y	N	N	N	N	
r20	(No-load current)	0.00 to 2000 A	N	Y1 Y2	*7	Y	Y	Y	Y	Y	
r21	(%R1)	0.00% to 50.00%	Y	Y1 Y2	*7	Y	Y	Y	Y	Y	
r22	(%X)	0.00% to 50.00%	Y	Y1 Y2	*7	Y	Y	Y	Y	Y	
r23	(Slip compensation gain for driving)	0.0% to 200.0%	Y*	Y	100.0	Y	Y	Y	Y	N	
r24	(Slip compensation response time)	0.01 to 10.00 s	Y	Y1 Y2	0.12	Y	Y	N	N	N	
r25	(Slip compensation gain for braking)	0.0% to 200.0%	Y*	Y	100.0	Y	Y	Y	Y	N	
r26	(Rated slip frequency)	0.00 to 15.00 Hz	N	Y1 Y2	*7	Y	Y	Y	Y	N	
r27	(Iron loss factor 1)	0.00% to 20.00%	Y	Y1 Y2	*7	Y	Y	Y	Y	Y	

*2 The motor rated current is automatically set. See Table B (P03/A17/b17/r17).
 *3 5.0 min for inverters of 40 HP or below; 10.0 min for those of 50 HP or above
 *4 0% to 100% for inverters of 7.5 HP or below
 *7 The motor parameters are automatically set, depending upon the inverter's capacity. See Table B.

F codes
E codes
C codes
P codes
H codes
A codes
b codes
r codes
J codes
d codes
U codes
y codes

Code	Name	Data setting range	Change when running	Data copying	Default setting	Drive control					Refer to page:
						V/f	PG V/f	w/o PG	w/ PG	Torque control	
r28	(Iron loss factor 2)	0.00% to 20.00%	Y	Y1 Y2	0.00	Y	Y	Y	Y	Y	—
r29	(Iron loss factor 3)	0.00% to 20.00%	Y	Y1 Y2	0.00	Y	Y	Y	Y	Y	
r30	(Magnetic saturation factor 1)	0.0% to 300.0%	Y	Y1 Y2	*7	Y	Y	Y	Y	Y	
r31	(Magnetic saturation factor 2)	0.0% to 300.0%	Y	Y1 Y2	*7	Y	Y	Y	Y	Y	
r32	(Magnetic saturation factor 3)	0.0% to 300.0%	Y	Y1 Y2	*7	Y	Y	Y	Y	Y	
r33	(Magnetic saturation factor 4)	0.0% to 300.0%	Y	Y1 Y2	*7	Y	Y	Y	Y	Y	
r34	(Magnetic saturation factor 5)	0.0% to 300.0%	Y	Y1 Y2	*7	Y	Y	Y	Y	Y	
r35	(Magnetic saturation extension factor "a")	0.0% to 300.0%	Y	Y1 Y2	*7	Y	Y	Y	Y	Y	
r36	(Magnetic saturation extension factor "b")	0.0% to 300.0%	Y	Y1 Y2	*7	Y	Y	Y	Y	Y	
r37	(Magnetic saturation extension factor "c")	0.0% to 300.0%	Y	Y1 Y2	*7	Y	Y	Y	Y	Y	
r39	Motor 4 Selection	0: Motor characteristics 0 (Fuji standard motors, 8-series) 1: Motor characteristics 1 (HP rating motors) 2: Motor characteristics 2 (Fuji motors exclusively designed for vector control) 3: Motor characteristics 3 (Fuji standard motors, 6-series) 4: Other motors	N	Y1 Y2	1	Y	Y	Y	Y	Y	5-137
r40	Slip Compensation 4 (Operating conditions)	0: Enable during ACC/DEC and at base frequency or above 1: Disable during ACC/DEC and enable at base frequency or above 2: Enable during ACC/DEC and disable at base frequency or above 3: Disable during ACC/DEC and at base frequency or above	N	Y	0	Y	Y	N	N	N	
r41	Output Current Fluctuation Damping Gain for Motor 4	0.00 to 1.00	Y	Y	0.20	Y	Y	N	N	N	
r42	Motor/Parameter Switching 4 (Mode selection)	0: Motor (Switch to the 4th motor) 1: Parameter (Switch to particular r codes)	N	Y	0	Y	Y	Y	Y	Y	
r43	Speed Control 4 (Speed command filter)	0.000 to 5.000 s	Y	Y	0.020	N	Y	Y	Y	N	
r44	(Speed detection filter)	0.000 to 0.100 s	Y*	Y	0.005	N	Y	Y	Y	N	
r45	P (Gain)	0.1 to 200.0 times	Y*	Y	10.0	N	Y	Y	Y	N	
r46	I (Integral time)	0.001 to 9.999 s	Y*	Y	0.100	N	Y	Y	Y	N	
r48	(Output filter)	0.000 to 0.100 s	Y	Y	0.002	N	Y	Y	Y	N	
r49	(Notch filter resonance frequency)	1 to 200 Hz	Y	Y	200	N	N	N	Y	N	
r50	(Notch filter attenuation level)	0 to 20 dB	Y	Y	0	N	N	N	Y	N	
r51	Cumulative Motor Run Time 4	0 to 99990 hours (The cumulative run time can be modified or reset.)	N	N	-	Y	Y	Y	Y	Y	
r52	Startup Counter for Motor 4	Indication of cumulative startup count 0 to 65535 times	Y	N	-	Y	Y	Y	Y	Y	
r53	Motor 4 (%X correction factor 1)	0% to 300%	Y	Y1 Y2	100	Y	Y	Y	Y	Y	
r54	(%X correction factor 2)	0% to 300%	Y	Y1 Y2	100	Y	Y	Y	Y	Y	
r55	(Torque current under vector control)	0.00 to 2000 A	N	Y1 Y2	*7	N	N	Y	Y	Y	
r56	(Induced voltage factor under vector control)	50 to 100	N	Y1 Y2	85 (90) *8	N	N	Y	Y	Y	
r57	Reserved *9	—	-	-	-	-	-	-	-	-	

*7 The motor parameters are automatically set, depending upon the inverter's capacity. See Table B.

*8 85% for inverters of 150 HP or less; 90% for those of 175 HP or above.

*9 Factory use. Do not access these function codes.

J codes: Application Functions 1

Code	Name	Data setting range	Change when running	Data copying	Default setting	Drive control					Refer to page:
						V/f	PG V/f	w/o PG	w/ PG	Torque control	
J01	PID Control (Mode selection)	0: Disable 1: Enable (Process control, normal operation) 2: Enable (Process control, inverse operation) 3: Enable (Dancer control)	N	Y	0	Y	Y	Y	Y	N	5-140
J02	(Remote command SV)	0: ☺ / ☻ keys on keypad 1: PID command 1 (Analog input terminals [12], [C1], and [V2]) 3: UP/DOWN 4: Command via communications link	N	Y	0	Y	Y	Y	Y	N	5-141
J03	P (Gain)	0.000 to 30.000 times	Y	Y	0.100	Y	Y	Y	Y	N	5-146
J04	I (Integral time)	0.0 to 3600.0 s	Y	Y	0.0	Y	Y	Y	Y	N	
J05	D (Differential time)	0.00 to 600.00 s	Y	Y	0.00	Y	Y	Y	Y	N	
J06	(Feedback filter)	0.0 to 900.0 s	Y	Y	0.5	Y	Y	Y	Y	N	
J08	(Pressurization starting frequency)	0.0 to 500.0 Hz	Y	Y	0.0	Y	Y	Y	Y	N	5-149
J09	(Pressurizing time)	0 to 60 s	Y	Y	0	Y	Y	Y	Y	N	
J10	(Anti reset windup)	0% to 200%	Y	Y	200	Y	Y	Y	Y	N	5-150
J11	(Select alarm output)	0: Absolute-value alarm 1: Absolute-value alarm (with Hold) 2: Absolute-value alarm (with Latch) 3: Absolute-value alarm (with Hold and Latch) 4: Deviation alarm 5: Deviation alarm (with Hold) 6: Deviation alarm (with Latch) 7: Deviation alarm (with Hold and Latch)	Y	Y	0	Y	Y	Y	Y	N	5-151
J12	(Upper level alarm (AH))	-100% to 100%	Y	Y	100	Y	Y	Y	Y	N	5-149
J13	(Lower level alarm (AL))	-100% to 100%	Y	Y	0	Y	Y	Y	Y	N	
J15	(Stop frequency for slow flowrate)	0.0: Disable; 1.0 to 500.0 Hz	Y	Y	0.0	Y	Y	Y	Y	N	
J16	(Slow flowrate level stop latency)	0 to 60 s	Y	Y	30	Y	Y	Y	Y	N	5-152
J17	(Starting frequency)	0.0 to 500.0 Hz	Y	Y	0.0	Y	Y	Y	Y	N	5-152
J18	(Upper limit of PID process output)	-150% to 150%; 999: Depends on setting of F15	Y	Y	999	Y	Y	Y	Y	N	
J19	(Lower limit of PID process output)	-150% to 150%; 999: Depends on setting of F16	Y	Y	999	Y	Y	Y	Y	N	
J21	Dew Condensation Prevention (Duty)	1% to 50%	Y	Y	1	Y	Y	Y	Y	Y	5-79 5-153
J22	Commercial Power Switching Sequence	0: Keep inverter operation (Stop due to alarm) 1: Automatically switch to commercial-power operation	N	Y	0	Y	Y	N	N	Y	
J56	PID Control (Speed command filter)	0.00 to 5.00 s	Y	Y	0.10	Y	Y	Y	Y	N	
J57	(Dancer reference position)	-100% to 0% to 100%	Y	Y	0	Y	Y	Y	Y	N	5-153
J58	(Detection width of dancer position deviation)	0: Disable switching PID constant 1% to 100% (Manually set value)	Y	Y	0	Y	Y	Y	Y	N	
J59	P (Gain) 2	0.000 to 30.000 times	Y	Y	0.100	Y	Y	Y	Y	N	
J60	I (Integral time) 2	0.0 to 3600.0 s	Y	Y	0.0	Y	Y	Y	Y	N	5-154
J61	D (Differential time) 2	0.00 to 600.00 s	Y	Y	0.00	Y	Y	Y	Y	N	
J62	(PID control block selection)	0 to 3 bit 0: PID output polarity 0: Plus (add), 1: Minus (subtract) bit 1: Select compensation factor for PID output 0 = Ratio (relative to the main setting) 1 = Speed command (relative to maximum frequency)	N	Y	0	Y	Y	Y	Y	N	
J68	Brake Signal (Brake-OFF current)	0% to 300%	Y	Y	100	Y	Y	Y	Y	N	5-154
J69	(Brake-OFF frequency/speed)	0.0 to 25.0 Hz	Y	Y	1.0	Y	Y	N	N	N	
J70	(Brake-OFF timer)	0.0 to 5.0 s	Y	Y	1.0	Y	Y	Y	Y	N	
J71	(Brake-ON frequency/speed)	0.0 to 25.0 Hz	Y	Y	1.0	Y	Y	N	N	N	
J72	(Brake-ON timer)	0.0 to 5.0 s	Y	Y	1.0	Y	Y	Y	Y	N	
J95	(Brake-OFF torque)	0% to 300%	Y	Y	100	N	N	Y	Y	N	
J96	(Speed condition selection (Braking conditions))	0 to 31 Bit 0: Criterion speed for brake-ON (0: Detected speed, 1: Reference speed) Bit 1: Reserved. Bit 2: Response for brake-OFF current (0: Slow response, 1: Quick response) Bit 3: Criterion frequency for brake-ON (0: Stop frequency (F25), 1: Brake-ON frequency (J71)) Bit 4: Output condition of brake signal (0: Independent of a run command ON/OFF 1: Only when a run command is OFF)	N	Y	0						
J97	Servo-lock (Gain)	0.00 to 10.00 times	Y*	Y	0.10	N	N	N	Y	N	
J98	(Completion timer)	0.000 to 1.000 s	Y	Y	0.100	N	N	N	Y	N	
J99	(Completion range)	0 to 9999 pulses	Y	Y	10	N	N	N	Y	N	

F codes
E codes
C codes
P codes
H codes
A codes
b codes
r codes
J codes
d codes
U codes
y codes

d codes: Application Functions 2

Code	Name	Data setting range	Change when running	Data copying	Default setting	Drive control					Refer to page:
						V/f	PG V/f	w/o PG	w/ PG	Torque control	
d01	Speed Control 1 (Speed command filter)	0.000 to 5.000 s	Y	Y	0.020	N	Y	Y	Y	N	5-159
d02	(Speed detection filter)	0.000 to 0.100 s	Y*	Y	0.005	N	Y	Y	Y	N	
d03	P (Gain)	0.1 to 200.0 times	Y*	Y	10.0	N	Y	Y	Y	N	
d04	I (Integral time)	0.001 to 9.999 s	Y*	Y	0.100	N	Y	Y	Y	N	
d06	(Output filter)	0.000 to 0.100 s	Y	Y	0.002	N	Y	Y	Y	N	
d07	(Notch filter resonance frequency)	1 to 200 Hz	Y	Y	200	N	N	N	Y	N	
d08	(Notch filter attenuation level)	0 to 20 dB	Y	Y	0	N	N	N	Y	N	
d09	Speed Control (Jogging) (Speed command filter)	0.000 to 5.000 s	Y	Y	0.020	N	Y	Y	Y	N	
d10	(Speed detection filter)	0.000 to 0.100 s	Y*	Y	0.005	N	Y	Y	Y	N	
d11	P (Gain)	0.1 to 200.0 times	Y*	Y	10.0	N	Y	Y	Y	N	
d12	I (Integral time)	0.001 to 9.999 s	Y*	Y	0.100	N	Y	Y	Y	N	
d13	(Output filter)	0.000 to 0.100 s	Y	Y	0.002	N	Y	Y	Y	N	
d14	Feedback Input (Pulse input format)	0: Pulse train sign/Pulse train input 1: Forward rotation pulse/Reverse rotation pulse 2: A/B phase with 90 degree phase shift	N	Y	2	N	Y	N	Y	Y	5-161
d15	(Encoder pulse resolution)	20 to 60000 pulses	N	Y	1024	N	Y	N	Y	Y	
d16	(Pulse count factor 1)	1 to 9999	N	Y	1	N	Y	N	Y	Y	
d17	(Pulse count factor 2)	1 to 9999	N	Y	1	N	Y	N	Y	Y	
d21	Speed Agreement/PG Error (Hysteresis width)	0.0% to 50.0%	Y	Y	10.0	N	Y	Y	Y	N	5-162
d22	(Detection timer)	0.00 to 10.00 s	Y	Y	0.50	N	Y	Y	Y	N	
d23	PG Error Processing	0: Continue to run 1 1: Stop running with alarm 1 2: Stop running with alarm 2 3: Continue to run 2 4: Stop running with alarm 3 5: Stop running with alarm 4	N	Y	2	N	Y	Y	Y	Y	
d24	Zero Speed Control	0: Not permit at startup 1: Permit at startup	N	Y	0	N	N	Y	Y	N	5-59 5-163
d25	ASR Switching Time	0.000 to 1.000 s	Y	Y	0.000	N	Y	Y	Y	Y	5-137 5-163
d32	Torque Control (Speed limit 1)	0 to 110 %	Y	Y	100	N	N	Y	Y	Y	5-121
d33	(Speed limit 2)	0 to 110 %	Y	Y	100	N	N	Y	Y	Y	5-163
d41	Application-defined Control	0: Disable (Ordinary control) 1: Enable (Constant peripheral speed control) 2: Enable (Simultaneous synchronization, without Z phase) 3: Enable (Standby synchronization) 4: Enable (Simultaneous synchronization, with Z phase)	N	Y	0	Y	Y	Y	Y	Y	5-163
						N	N	N	N	N	
						N	Y	N	Y	N	
						N	Y	N	Y	N	
d51	Reserved *9	—	-	-	-	-	-	-	-	-	5-165
d52	Reserved *9	—	-	-	-	-	-	-	-	-	
d53	Reserved *9	—	-	-	-	-	-	-	-	-	
d54	Reserved *9	—	-	-	-	-	-	-	-	-	
d55	Reserved *9	—	-	-	-	-	-	-	-	-	
d59	Command (Pulse Rate Input) (Pulse input format)	0: Pulse train sign/Pulse train input 1: Forward rotation pulse/Reverse rotation pulse 2: A/B phase with 90 degree phase shift	N	Y	0	Y	Y	Y	Y	Y	5-34 5-165
d60	(Encoder pulse resolution)	20 to 3600 pulses	N	Y	1024	N	Y	N	Y	N	5-166
d61	(Filter time constant)	0.000 to 5.000 s	Y	Y	0.005	Y	Y	Y	Y	Y	5-165
d62	(Pulse count factor 1)	1 to 9999	N	Y	1	Y	Y	Y	Y	Y	
d63	(Pulse count factor 2)	1 to 9999	N	Y	1	Y	Y	Y	Y	Y	
d67	Starting Mode (Auto search)	0: Disable 1: Enable (At restart after momentary power failure) 2: Enable (At restart after momentary power failure and at normal start)	N	Y	2	N	N	Y	N	Y	5-119
d68	Reserved *9	—	-	-	-	-	-	-	-	-	5-165
d69	Reserved *9	—	-	-	-	-	-	-	-	-	
d70	Speed Control Limiter	0.00 to 100.00%	Y	Y	100.00	N	Y	N	Y	N	5-166

*9 Factory use. Do not access these function codes.

Code	Name	Data setting range	Change when running	Data copying	Default setting	Drive control					Refer to page:
						V/f	PG V/f	w/o PG	w/ PG	Torque control	
d71	Synchronous Operation (Main speed regulator gain)	0.00 to 1.50 times	Y	Y	1.00	N	Y	N	Y	N	5-166
d72	(APR P gain)	0.00 to 200.00 times	Y	Y	1500	N	Y	N	Y	N	
d73	(APR positive output limiter)	20 to 200%, 999: No limiter	Y	Y	999	N	Y	N	Y	N	
d74	(APR negative output limiter)	20 to 200%, 999: No limiter	Y	Y	999	N	Y	N	Y	N	
d75	(Z phase alignment gain)	0.00 to 10.00 times	Y	Y	1.00	N	Y	N	Y	N	
d76	(Synchronous offset angle)	0 to 359 degrees	Y	Y	0	N	Y	N	Y	N	
d77	(Synchronization completion detection angle)	0 to 100 degrees	Y	Y	15	N	Y	N	Y	N	
d78	(Excessive deviation detection range)	0 to 65535 (in units of 10 pulses)	Y	Y	65535	N	Y	N	Y	N	
d98	Reserved *9	—	-	-	-	-	-	-	-	-	5-165
d99	Reserved *9	—	-	-	-	-	-	-	-	-	

*9 Factory use. Do not access these function codes.

F codes
E codes
C codes
P codes
H codes
A codes
b codes
r codes
J codes
d codes
U codes
y codes

U codes: Application Functions 3

Code	Name	Data setting range	Change when running	Data copying	Default setting	Drive control					Refer to page:
						V/f	PG V/f	w/o PG	w/ PG	Torque control	
U00	Customizable Logic (Mode selection)	0: Disable 1: Enable (Customizable logic operation)	N	Y	0	Y	Y	Y	Y	Y	5-167
U01	Customizable Logic: (Input 1)	0 (1000): Inverter running (RUN)	N	Y	0	Y	Y	Y	Y	Y	
U02	Step 1 (Input 2)	1 (1001): Frequency (speed) arrival signal (FAR)	N	Y	0	Y	Y	Y	Y	N	
		2 (1002): Frequency (speed) detected (FDT)				Y	Y	Y	Y	Y	
		3 (1003): Undervoltage detected (Inverter stopped) (LU)				Y	Y	Y	Y	Y	
		4 (1004): Torque polarity detected (B/D)				Y	Y	Y	Y	Y	
		5 (1005): Inverter output limiting (IOL)				Y	Y	Y	Y	Y	
		6 (1006): Auto-restarting after momentary power failure (IPF)				Y	Y	Y	Y	Y	
		7 (1007): Motor overload early warning (OL)				Y	Y	Y	Y	Y	
		8 (1008): Keypad operation enabled (KP)				Y	Y	Y	Y	Y	
		10 (1010): Inverter ready to run (RDY)				Y	Y	Y	Y	Y	
		11: Switch motor drive source between commercial power and inverter output (For MC on commercial line) (SW88)				Y	Y	N	N	N	
		12: Switch motor drive source between commercial power and inverter output (For secondary side) (SW52-2)				Y	Y	N	N	N	
		13: Switch motor drive source between commercial power and inverter output (For primary side) (SW52-1)				Y	Y	N	N	N	
		15 (1015): Select AX terminal function (For MC on primary side) (AX)				Y	Y	Y	Y	Y	
		22 (1022): Inverter output limiting with delay (IOL2)				Y	Y	Y	Y	Y	
		25 (1025): Cooling fan in operation (FAN)				Y	Y	Y	Y	Y	
		26 (1026): Auto-resetting (TRY)				Y	Y	Y	Y	Y	
		28 (1028): Heat sink overheat early warning (OH)				Y	Y	Y	Y	Y	
		29 (1029): Synchronization completed (SY)				N	Y	N	Y	N	
		30 (1030): Lifetime alarm (LIFE)				Y	Y	Y	Y	Y	
		31 (1031): Frequency (speed) detected 2 (FDT2)				Y	Y	Y	Y	Y	
		33 (1033): Reference loss detected (REF OFF)				Y	Y	Y	Y	Y	
		35 (1035): Inverter output on (RUN2)				Y	Y	Y	Y	Y	
		36 (1036): Overload prevention control (OLP)				Y	Y	Y	Y	N	
		37 (1037): Current detected (ID)				Y	Y	Y	Y	Y	
		38 (1038): Current detected 2 (ID2)				Y	Y	Y	Y	Y	
		39 (1039): Current detected 3 (ID3)				Y	Y	Y	Y	Y	
		41 (1041): Low current detected (IDL)				Y	Y	Y	Y	Y	
		42 (1042): PID alarm (PID-ALM)				Y	Y	Y	Y	N	
		43 (1043): Under PID control (PID-CTL)				Y	Y	Y	Y	N	
		44 (1044): Motor stopped due to slow flowrate under PID control (PID-STP)				Y	Y	Y	Y	N	
		45 (1045): Low output torque detected (U-TL)				Y	Y	Y	Y	Y	
		46 (1046): Torque detected 1 (TD1)				Y	Y	Y	Y	Y	
		47 (1047): Torque detected 2 (TD2)				Y	Y	Y	Y	Y	
		48 (1048): Motor 1 selected (SWM1)				Y	Y	Y	Y	Y	
		49 (1049): Motor 2 selected (SWM2)				Y	Y	Y	Y	Y	
		50 (1050): Motor 3 selected (SWM3)				Y	Y	Y	Y	Y	
		51 (1051): Motor 4 selected (SWM4)				Y	Y	Y	Y	Y	
		52 (1052): Running forward (FRUN)				Y	Y	Y	Y	Y	
		53 (1053): Running reverse (RRUN)				Y	Y	Y	Y	Y	
		54 (1054): In remote operation (RMT)				Y	Y	Y	Y	Y	
		56 (1056): Motor overheat detected by thermistor (THM)				Y	Y	Y	Y	Y	
		57 (1057): Brake signal (BRKS)				Y	Y	Y	Y	N	
		58 (1058): Frequency (speed) detected 3 (FDT3)				Y	Y	Y	Y	Y	
		59 (1059): Terminal [C1] wire break (C1OFF)				Y	Y	Y	Y	Y	
		70 (1070): Speed valid (DNZS)				N	Y	Y	Y	Y	
		71 (1071): Speed agreement (DSAG)				N	Y	Y	Y	N	
		72 (1072): Frequency (speed) arrival signal 3 (FAR3)				Y	Y	Y	Y	N	
		76 (1076): PG error detected (PG-ERR)				N	Y	Y	Y	N	
		82 (1082): Positioning completion signal (PSET)				N	N	N	Y	N	

Code	Name	Data setting range	Change when running	Data copying	Default setting	Drive control					Refer to page:
						V/f	PG V/f	w/o PG	w/PG	Torque control	
		84 (1084): Maintenance timer (MNT) 98 (1098): Light alarm (L-ALM) 99 (1099): Alarm output (for any alarm) (ALM) 101 (1101): Enable circuit failure detected (DECF) 102 (1102): Enable input OFF (EN OFF) 105 (1105): Braking transistor broken (DBAL) 2001 (3001): Output of step 1 (SO01) 2002 (3002): Output of step 2 (SO02) 2003 (3003): Output of step 3 (SO03) 2004 (3004): Output of step 4 (SO04) 2005 (3005): Output of step 5 (SO05) 2006 (3006): Output of step 6 (SO06) 2007 (3007): Output of step 7 (SO07) 2008 (3008): Output of step 8 (SO08) 2009 (3009): Output of step 9 (SO09) 2010 (3010): Output of step 10 (SO10) 4001 (5001): Terminal [X1] input signal (X1) 4002 (5002): Terminal [X2] input signal (X2) 4003 (5003): Terminal [X3] input signal (X3) 4004 (5004): Terminal [X4] input signal (X4) 4005 (5005): Terminal [X5] input signal (X5) 4006 (5006): Terminal [X6] input signal (X6) 4007 (5007): Terminal [X7] input signal (X7) 4010 (5010): Terminal [FWD] input signal (FWD) 4011 (5011): Terminal [REV] input signal (REV) 6000 (7000): Final run command (FL_RUN) 6001 (7001): Final FWD run command (FL_FWD) 6002 (7002): Final REV run command (FL_REV) 6003 (7003): During acceleration (DACC) 6004 (7004): During deceleration (DDEC) 6005 (7005): Under anti-regenerative control (REGA) 6006 (7006): Within dancer reference position (DR_REF) 6007 (7007): Alarm factor presence (ALM_ACT) Setting the value in parentheses () shown above assigns a negative logic output to a terminal. (True if OFF.)				Y	Y	Y	Y	Y	5-167
U03	(Logic circuit)	0: No function assigned 1: Through output + General-purpose timer 2: ANDing + General-purpose timer 3: ORing + General-purpose timer 4: XORing + General-purpose timer 5: Set priority flip-flop + General-purpose timer 6: Reset priority flip-flop + General-purpose timer 7: Rising edge detector + General-purpose timer 8: Falling edge detector + General-purpose timer 9: Rising and falling edge detector + General-purpose timer 10: Input hold + General-purpose timer 11: Increment counter 12: Decrement counter 13: Timer with reset input	N	Y	0	Y	Y	Y	Y	Y	
U04	(Type of timer)	0: No timer 1: On-delay timer 2: Off-delay timer 3: Pulse 4: Retriggerable timer 5: Pulse train output	N	Y	0	Y	Y	Y	Y	Y	
U05	(Timer)	0.00 to 600.00	N	Y	0.00	Y	Y	Y	Y	Y	
U06	Customizable Logic: (Input 1)	See U01.	N	Y	0	See U01.					
U07	Step 2 (Input 2)	See U02.	N	Y	0	See U02.					
U08	(Logic circuit)	See U03.	N	Y	0	Y	Y	Y	Y	Y	
U09	(Type of timer)	See U04.	N	Y	0	Y	Y	Y	Y	Y	
U10	(Timer)	See U05.	N	Y	0.00	Y	Y	Y	Y	Y	

F codes
E codes
C codes
P codes
H codes
A codes
b codes
r codes
J codes
d codes
U codes
y codes

Code	Name	Data setting range	Change when running	Data copying	Default setting	Drive control					Refer to page:
						V/f	PG V/f	w/o PG	w/ PG	Torque control	
U11	Customizable Logic: (Input 1)	See U01.	N	Y	0	See U01.					5-167
U12	Step 3 (Input 2)	See U02.	N	Y	0	See U02.					
U13	(Logic circuit)	See U03.	N	Y	0	Y	Y	Y	Y	Y	
U14	(Type of timer)	See U04.	N	Y	0	Y	Y	Y	Y	Y	
U15	(Timer)	See U05.	N	Y	0.00	Y	Y	Y	Y	Y	
U16	Customizable Logic: (Input 1)	See U01.	N	Y	0	See U01.					
U17	Step 4 (Input 2)	See U02.	N	Y	0	See U02.					
U18	(Logic circuit)	See U03.	N	Y	0	Y	Y	Y	Y	Y	
U19	(Type of timer)	See U04.	N	Y	0	Y	Y	Y	Y	Y	
U20	(Timer)	See U05.	N	Y	0.00	Y	Y	Y	Y	Y	
U21	Customizable Logic: (Input 1)	See U01.	N	Y	0	See U01.					
U22	Step 5 (Input 2)	See U02.	N	Y	0	See U02.					
U23	(Logic circuit)	See U03.	N	Y	0	Y	Y	Y	Y	Y	
U24	(Type of timer)	See U04.	N	Y	0	Y	Y	Y	Y	Y	
U25	(Timer)	See U05.	N	Y	0.00	Y	Y	Y	Y	Y	
U26	Customizable Logic: (Input 1)	See U01.	N	Y	0	See U01.					
U27	Step 6 (Input 2)	See U02.	N	Y	0	See U02.					
U28	(Logic circuit)	See U03.	N	Y	0	Y	Y	Y	Y	Y	
U29	(Type of timer)	See U04.	N	Y	0	Y	Y	Y	Y	Y	
U30	(Timer)	See U05.	N	Y	0.00	Y	Y	Y	Y	Y	
U31	Customizable Logic: (Input 1)	See U01.	N	Y	0	See U01.					
U32	Step 7 (Input 2)	See U02.	N	Y	0	See U02.					
U33	(Logic circuit)	See U03.	N	Y	0	Y	Y	Y	Y	Y	
U34	(Type of timer)	See U04.	N	Y	0	Y	Y	Y	Y	Y	
U35	(Timer)	See U05.	N	Y	0.00	Y	Y	Y	Y	Y	
U36	Customizable Logic: (Input 1)	See U01.	N	Y	0	See U01.					
U37	Step 8 (Input 2)	See U02.	N	Y	0	See U02.					
U38	(Logic circuit)	See U03.	N	Y	0	Y	Y	Y	Y	Y	
U39	(Type of timer)	See U04.	N	Y	0	Y	Y	Y	Y	Y	
U40	(Timer)	See U05.	N	Y	0.00	Y	Y	Y	Y	Y	
U41	Customizable Logic: (Input 1)	See U01.	N	Y	0	See U01.					
U42	Step 9 (Input 2)	See U02.	N	Y	0	See U02.					
U43	(Logic circuit)	See U03.	N	Y	0	Y	Y	Y	Y	Y	
U44	(Type of timer)	See U04.	N	Y	0	Y	Y	Y	Y	Y	
U45	(Timer)	See U05.	N	Y	0.00	Y	Y	Y	Y	Y	
U46	Customizable Logic: (Input 1)	See U01.	N	Y	0	See U01.					
U47	Step 10 (Input 2)	See U02.	N	Y	0	See U02.					
U48	(Logic circuit)	See U03.	N	Y	0	Y	Y	Y	Y	Y	
U49	(Type of timer)	See U04.	N	Y	0	Y	Y	Y	Y	Y	
U50	(Timer)	See U05.	N	Y	0.00	Y	Y	Y	Y	Y	
U71	Customizable Logic Output Signal 1 (Output selection)	0: Disable	N	Y	0	Y	Y	Y	Y	Y	
		1: Step 1 output									
U72	Customizable Logic Output Signal 2	2: Step 2 output				Y	Y	Y	Y	Y	
U73	Customizable Logic Output Signal 3	3: Step 3 output				Y	Y	Y	Y	Y	
U74	Customizable Logic Output Signal 4	4: Step 4 output				Y	Y	Y	Y	Y	
U75	Customizable Logic Output Signal 5	5: Step 5 output				Y	Y	Y	Y	Y	
		6: Step 6 output									
		7: Step 7 output									
		8: Step 8 output									
		9: Step 9 output									
		10: Step 10 output									

Code	Name	Data setting range	Change when running	Data copying	Default setting	Drive control					Refer to page:	
						V/f	PG V/f	w/o PG	w/ PG	Torque control		
U81	Customizable Logic Output Signal 1 (Function selection)	0 (1000): Select multi-frequency (0 to 1 step) (SS1)	N	Y	100	Y	Y	Y	Y	N	5-167	
		1 (1001): Select multi-frequency (0 to 3 steps) (SS2)				Y	Y	Y	Y	N		
U82	Customizable Logic Output Signal 2	2 (1002): Select multi-frequency (0 to 7 steps) (SS4)	N	Y	100	Y	Y	Y	Y	N		
U83	Customizable Logic Output Signal 3	3 (1003): Select multi-frequency (0 to 15 steps) (SS8)	N	Y	100	Y	Y	Y	Y	N		
U84	Customizable Logic Output Signal 4	4 (1004): Select ACC/DEC time (2 steps) (RT1)	N	Y	100	Y	Y	Y	Y	N		
U85	Customizable Logic Output Signal 5	5 (1005): Select ACC/DEC time (4 steps) (RT2)	N	Y	100	Y	Y	Y	Y	N		
		6 (1006): Enable 3-wire operation (HLD)				Y	Y	Y	Y	Y		
		7 (1007): Coast to a stop (BX)				Y	Y	Y	Y	Y		
		8 (1008): Reset alarm (RST)				Y	Y	Y	Y	Y		
		9 (1009): Enable external alarm trip (THR) (9 = Active OFF, 1009 = Active ON)				Y	Y	Y	Y	Y		
		10 (1010): Ready for jogging (JOG)				Y	Y	Y	Y	N		
		11 (1011): Select frequency command 2/1 (Hz2/Hz1)				Y	Y	Y	Y	N		
		12 (1012): Select motor 2 (M2)				Y	Y	Y	Y	Y		
		13: Enable DC braking (DCBRK)				Y	Y	Y	Y	N		
		14 (1014): Select torque limiter level 2/1 (TL2/TL1)				Y	Y	Y	Y	Y		
		15: Switch to commercial power (50 Hz) (SW50)				Y	Y	N	N	N		
		16: Switch to commercial power (60 Hz) (SW60)				Y	Y	N	N	N		
		17 (1017): UP (Increase output frequency) (UP)				Y	Y	Y	Y	N		
		18 (1018): DOWN (Decrease output frequency) (DOWN)				Y	Y	Y	Y	N		
		20 (1020): Cancel PID control (Hz/PID)				Y	Y	Y	Y	N		
		21 (1021): Switch normal/inverse operation (IVS)				Y	Y	Y	Y	N		
		22 (1022): Interlock (IL)				Y	Y	Y	Y	Y		
		23 (1023): Cancel torque control (Hz/TRQ)				N	N	N	N	Y		
		24 (1024): Enable communications link via RS-485 or fieldbus (LE)				Y	Y	Y	Y	Y		
		25 (1025): Universal DI (U-DI)				Y	Y	Y	Y	Y		
		26 (1026): Enable auto search for idling motor speed at starting (STM)				Y	Y	Y	N	Y		
		30 (1030): Force to stop (STOP) (30 = Active OFF, 1030 = Active ON)				Y	Y	Y	Y	Y		
		32 (1032): Pre-excitation (EXITE)				N	N	Y	Y	N		
		33 (1033): Reset PID integral and differential components (PID-RST)				Y	Y	Y	Y	N		
		34 (1034): Hold PID integral component (PID-HLD)				Y	Y	Y	Y	N		
		35 (1035): Select local (keypad) operation (LOC)				Y	Y	Y	Y	Y		
		36 (1036): Select motor 3 (M3)				Y	Y	Y	Y	Y		
		37 (1037): Select motor 4 (M4)				Y	Y	Y	Y	Y		
		39: Protect motor from dew condensation (DWP)				Y	Y	Y	Y	Y		
		40: Enable integrated sequence to switch to commercial power (50 Hz) (ISW50)				Y	Y	N	N	N		
		41: Enable integrated sequence to switch to commercial power (60 Hz) (ISW60)				Y	Y	N	N	N		
		47 (1047): Servo-lock command (LOCK)				N	N	N	Y	N		
		49 (1049): Pulse train sign (SIGN)				Y	Y	Y	Y	Y		
		70 (1070): Cancel constant peripheral speed control (Hz/LSC)				Y	Y	Y	Y	N		
		71 (1071): Hold the constant peripheral speed control frequency in the memory (LSC-HLD)				Y	Y	Y	Y	N		
		72 (1072): Count the run time of commercial power-driven motor 1 (CRUN-M1)				Y	Y	N	N	Y		
		73 (1073): Count the run time of commercial power-driven motor 2 (CRUN-M2)				Y	Y	N	N	Y		
		74 (1074): Count the run time of commercial power-driven motor 3 (CRUN-M3)				Y	Y	N	N	Y		
		75 (1075): Count the run time of commercial power-driven motor 4 (CRUN-M4)				Y	Y	N	N	Y		
		76 (1076): Select droop control (DROOP)				Y	Y	Y	Y	N		
		77 (1077): Cancel PG alarm (PG-CCL)				N	Y	N	Y	Y		
		81 (1081): Clear all customizable logic timers (CLTC)				Y	Y	Y	Y	Y		
		98: Run forward (FWD)				Y	Y	Y	Y	Y		
		99: Run reverse (REV)				Y	Y	Y	Y	Y		
		100: No function assigned (NONE)				Y	Y	Y	Y	Y		
		Setting the value of 1000s in parentheses () shown above assigns a negative logic input to a terminal.										

F codes
E codes
C codes
P codes
H codes
A codes
b codes
r codes
J codes
d codes
U codes
y codes

Code	Name	Data setting range	Change when running	Data copying	Default setting	Drive control					Refer to page:
						V/f	PG V/f	w/o PG	w/ PG	Torque	
U91	Customizable Logic Timer Monitor (Step selection)	1: Step 1 2: Step 2 3: Step 3 4: Step 4 5: Step 5 6: Step 6 7: Step 7 8: Step 8 9: Step 9 10: Step 10	N	Y	1	Y	Y	Y	Y	Y	5-167

y codes: LINK Functions

Code	Name	Data setting range	Change when running	Data copying	Default setting	Drive control					Refer to page:
						V/f	PG V/f	w/o PG	w/ PG	Torque control	
y01	RS-485 Communication 1 (Station address)	1 to 255	N	Y	1	Y	Y	Y	Y	Y	5-176
y02	(Communications error processing)	0: Immediately trip with alarm $E-rB$ 1: Trip with alarm $E-rB$ after running for the period specified by timer y03 2: Retry during the period specified by timer y03. If the retry fails, trip with alarm $E-rB$. If it succeeds, continue to run. 3: Continue to run	Y	Y	0	Y	Y	Y	Y	Y	
y03	(Timer)	0.0 to 60.0 s	Y	Y	2.0	Y	Y	Y	Y	Y	
y04	(Baud rate)	0: 2400 bps 1: 4800 bps 2: 9600 bps 3: 19200 bps 4: 38400 bps	Y	Y	3	Y	Y	Y	Y	Y	
y05	(Data length)	0: 8 bits 1: 7 bits	Y	Y	0	Y	Y	Y	Y	Y	
y06	(Parity check)	0: None (2 stop bits) 1: Even parity (1 stop bit) 2: Odd parity (1 stop bit) 3: None (1 stop bit)	Y	Y	0	Y	Y	Y	Y	Y	
y07	(Stop bits)	0: 2 bits 1: 1 bit	Y	Y	0	Y	Y	Y	Y	Y	
y08	RS-485 Communication 1 (No-response error detection time)	0: No detection; 1 to 60 s	Y	Y	0	Y	Y	Y	Y	Y	
y09	(Response interval)	0.00 to 1.00 s	Y	Y	0.01	Y	Y	Y	Y	Y	
y10	(Protocol selection)	0: Modbus RTU protocol 1: FRENIC Loader protocol (SX protocol) 2: Fuji general-purpose inverter protocol	Y	Y	1	Y	Y	Y	Y	Y	
y11	RS-485 Communication 2 (Station address)	1 to 255	N	Y	1	Y	Y	Y	Y	Y	
y12	(Communications error processing)	0: Immediately trip with alarm $E-rP$ 1: Trip with alarm $E-rP$ after running for the period specified by timer y13 2: Retry during the period specified by timer y13. If the retry fails, trip with alarm $E-rP$. If it succeeds, continue to run. 3: Continue to run	Y	Y	0	Y	Y	Y	Y	Y	
y13	(Timer)	0.0 to 60.0 s	Y	Y	2.0	Y	Y	Y	Y	Y	
y14	(Baud rate)	0: 2400 bps 1: 4800 bps 2: 9600 bps 3: 19200 bps 4: 38400 bps	Y	Y	3	Y	Y	Y	Y	Y	
y15	(Data length)	0: 8 bits 1: 7 bits	Y	Y	0	Y	Y	Y	Y	Y	
y16	(Parity check)	0: None (2 stop bits) 1: Even parity (1 stop bit) 2: Odd parity (1 stop bit) 3: None (1 stop bit)	Y	Y	0	Y	Y	Y	Y	Y	
y17	(Stop bits)	0: 2 bits 1: 1 bit	Y	Y	0	Y	Y	Y	Y	Y	
y18	(No-response error detection time)	0: No detection; 1 to 60 s	Y	Y	0	Y	Y	Y	Y	Y	
y19	(Response interval)	0.00 to 1.00 s	Y	Y	0.01	Y	Y	Y	Y	Y	
y20	(Protocol selection)	0: Modbus RTU protocol 2: Fuji general-purpose inverter protocol	Y	Y	0	Y	Y	Y	Y	Y	
y97	Communication Data Storage Selection	0: Save into nonvolatile storage (Rewritable times limited) 1: Write into temporary storage (Rewritable times unlimited) 2: Save all data from temporary storage to nonvolatile one (After saving data, the y97 data automatically returns to "1.")	Y	Y	0	Y	Y	Y	Y	Y	5-179
y98	Bus Link Function (Mode selection)	Frequency command Run command 0: Follow H30 data Follow H30 data 1: Via fieldbus option Follow H30 data 2: Follow H30 data Via fieldbus option 3: Via fieldbus option Via fieldbus option	Y	Y	0	Y	Y	Y	Y	Y	5-124 5-179
y99	Loader Link Function (Mode selection)	Frequency command Run command 0: Follow H30 and y98 data Follow H30 and y98 data 1: Via RS-485 link (FRENIC Loader) Follow H30 and y98 data 2: Follow H30 and y98 data Via RS-485 link (FRENIC Loader) 3: Via RS-485 link (FRENIC Loader) Via RS-485 link (FRENIC Loader)	Y	N	0	Y	Y	Y	Y	Y	5-179

F codes
E codes
C codes
P codes
H codes
A codes
b codes
r codes
J codes
d codes
U codes
y codes

Table A Factory Defaults Depending upon Inverter Capacity

Inverter capacity HP	Auto-restart after momentary power failure H13	Inverter capacity HP	Auto-restart after momentary power failure H13	
0.5	0.5	100	1.5	
1		125		
2		150		
3		200	2.0	
5		250		
7		300		
10		350		
15		450	2.5	
20		1.0	500	4.0
25			600	
30	700			
40	800		5.0	
50	900			
60	1000			
75	1.5			

Table B Motor Parameters

When the "HP rating motors" is selected with P99/A39/b39/r39 (data = 1)

Three-phase 230 V series (FRN_ _G1-2U)

Motor capacity (HP)	Nominal applied motor (HP)	Rated current (A)	No-load current (A)	%R1	%X	Rated slip frequency (Hz)	Iron loss factor 1 (%)	Magnetic saturation factor 1 (%)	Magnetic saturation factor 2 (%)	Magnetic saturation factor 3 (%)	Magnetic saturation factor 4 (%)	Magnetic saturation factor 5 (%)	Magnetic saturation extension factor P1 (%)	Magnetic saturation extension factor P2 (%)	Magnetic saturation extension factor P3 (%)	Torque current under vector control (A)	Starting mode (Auto search delay time Z)
	P02	P03	P06	P07	P08	P12	P13	P16	P17	P18	P19	P20	P21	P22	P23	P55	H46
0.01 to 0.11	0.1	0.44	0.40	13.79	11.75	2.50	14.00	93.8	87.5	75.0	62.5	50.0	106.3	112.5	118.8	0.21	
0.12 to 0.24	0.12	0.68	0.55	12.96	12.67	2.50	14.00	93.3	86.1	74.4	63.6	50.7	108.8	118.7	129.6	0.27	
0.25 to 0.49	0.25	1.12	1.12	11.02	13.84	2.50	12.60	89.7	81.9	66.9	54.5	43.3	111.0	129.3	148.4	0.53	0.5
0.50 to 0.99	0.5	2.00	1.22	6.15	8.80	2.50	9.88	88.7	81.3	67.0	55.2	43.8	112.1	126.5	144.3	1.09	
1.00 to 1.99	1	3.00	1.54	3.96	8.86	2.50	7.40	88.3	77.7	62.6	51.8	41.1	112.4	129.2	148.4	2.21	
2.00 to 2.99	2	5.80	2.80	4.29	7.74	2.50	5.66	92.1	82.8	71.1	56.1	46.2	111.4	126.1	143.9	4.43	
3.00 to 4.99	3	7.90	3.57	3.15	20.81	1.17	5.91	85.1	74.6	61.7	50.3	39.8	115.7	133.5	150.6	6.64	0.6
5.00 to 7.49	5	12.6	4.78	3.34	23.57	1.50	5.24	86.0	76.9	61.3	49.5	39.1	115.6	133.2	154.1	11.07	0.8
7.50 to 9.99	7.5	18.6	6.23	2.65	28.91	1.17	4.75	88.6	79.2	64.9	52.7	41.8	114.3	133.1	155.6	16.60	1.0
10.00 to 14.99	10	25.3	8.75	2.43	30.78	1.17	4.03	87.7	80.0	67.1	56.1	45.6	111.7	128.4	149.2	22.15	1.2
15.00 to 19.99	15	37.3	12.7	2.07	29.13	1.00	3.92	91.3	83.3	69.9	58.0	47.0	114.1	130.2	147.9	33.22	1.3
20.00 to 24.99	20	49.1	9.20	2.09	29.53	1.00	3.32	90.5	83.5	72.1	60.7	49.5	109.0	121.3	137.8	44.30	
25.00 to 29.99	25	60.0	16.70	1.75	31.49	1.00	3.34	90.7	83.0	70.7	59.9	48.7	112.1	127.9	147.5	55.37	2.0
30.00 to 39.99	30	72.4	19.80	1.90	32.55	1.00	3.28	89.7	81.3	68.9	59.1	48.4	114.1	130.2	151.8	66.45	
40.00 to 49.99	40	91.0	13.60	1.82	25.32	0.47	3.10	90.2	81.6	68.7	57.2	45.8	114.8	132.3	153.9	88.60	2.3
50.00 to 59.99	50	115.0	18.70	1.92	24.87	0.58	2.30	88.7	78.9	65.4	54.2	43.4	112.2	126.4	143.6	110.7	2.5
60.00 to 69.99	60	137.0	20.80	1.29	26.99	0.35	2.18	89.0	79.7	66.8	55.4	44.4	112.3	126.0	141.8	132.9	
75.00 to 99.99	75	174.0	28.60	1.37	27.09	0.35	2.45	89.2	79.3	64.7	53.6	43.1	117.2	136.2	157.8	166.1	2.6
100.0 to 124.9	100	226.0	37.40	1.08	23.80	0.23	2.33	88.1	78.0	64.3	54.2	42.9	114.9	129.8	144.6	221.5	2.8
125.0 to 149.9	125	268.0	29.80	1.05	22.90	0.35	2.31	88.8	79.0	65.0	54.0	44.0	115.0	130.0	145.0	276.9	3.2
150.0 or above	150	337.0	90.40	0.96	21.61	0.39	1.73	90.5	82.6	70.7	56.7	47.8	112.2	126.1	142.4	332.2	3.5

Note: A box (■) replaces S or H depending on the enclosure.

Table B Motor Parameters (Continued)

Three-phase 460 V series (FRN_ _ _G1■-4U)

Motor capacity (HP)	Nominal applied factor (HP)	Rated current (A)	No-load current (A)	%R1	%X	Rated slip frequency (Hz)	Iron loss factor 1 (%)	Magnetic saturation factor 1 (%)	Magnetic saturation factor 2 (%)	Magnetic saturation factor 3 (%)	Magnetic saturation factor 4 (%)	Magnetic saturation factor 5 (%)	Magnetic saturation extension factor "a" (%)	Magnetic saturation extension factor "b" (%)	Magnetic saturation extension factor "c" (%)	Torque current under vector control (A)	Starting mode (Auto search delay time 2)
	P02	P03	P06	P07	P08	P12	P13	P16	P17	P18	P19	P20	P21	P22	P23	P55	H48
0.01 to 0.11	0.1	0.22	0.20	13.79	11.75	2.50	14.00	93.8	87.5	75.0	62.5	50.0	106.3	112.5	118.8	0.10	
0.12 to 0.24	0.12	0.34	0.27	12.96	12.67	2.50	14.00	93.8	86.1	74.4	63.6	50.7	108.8	118.7	129.6	0.13	
0.25 to 0.49	0.25	0.70	0.56	11.02	13.84	2.50	12.60	89.7	81.9	66.9	54.5	43.3	111.0	129.3	148.4	0.27	0.5
0.50 to 0.99	0.5	1.00	0.61	6.15	8.80	2.50	9.88	88.7	81.3	67.0	55.2	43.8	112.1	126.5	144.3	0.55	
1.00 to 1.99	1	1.50	0.77	3.96	8.86	2.50	7.40	88.3	77.7	62.6	51.8	41.1	112.4	129.2	148.4	1.11	
2.00 to 2.99	2	2.90	1.40	4.29	7.74	2.50	5.85	92.1	82.8	71.1	58.1	46.2	111.4	126.1	143.9	2.21	
3.00 to 4.99	3	4.00	1.79	3.15	20.81	1.17	5.91	85.1	74.6	61.7	50.3	39.8	115.7	133.5	150.6	3.32	0.6
5.00 to 7.49	5	6.30	2.39	3.34	23.57	1.50	5.24	86.0	78.9	61.3	49.5	39.1	115.6	133.2	154.1	5.54	0.8
7.50 to 9.99	7.5	9.30	3.12	2.65	28.91	1.17	4.75	88.6	79.2	64.9	52.7	41.8	114.3	133.1	155.6	8.30	1.0
10.00 to 14.99	10	12.7	4.37	2.43	30.78	1.17	4.03	87.7	80.0	67.1	56.1	45.6	111.7	128.4	149.2	11.07	1.2
15.00 to 19.99	15	18.7	6.36	2.07	29.13	1.00	3.92	91.3	83.3	69.9	58.0	47.0	114.1	130.2	147.9	16.61	1.3
20.00 to 24.99	20	24.6	4.60	2.09	29.53	1.00	3.32	90.5	83.5	72.1	60.7	49.5	109.0	121.3	137.8	22.15	
25.00 to 29.99	25	30.0	8.33	1.75	31.49	1.00	3.34	90.7	83.0	70.7	59.9	48.7	112.1	127.9	147.5	27.69	2.0
30.00 to 39.99	30	36.2	9.88	1.90	32.55	1.00	3.28	89.7	81.3	68.9	59.1	48.4	114.1	130.2	151.8	33.22	
40.00 to 49.99	40	45.5	6.80	1.82	25.32	0.47	3.10	90.2	81.6	68.7	57.2	45.8	114.8	132.3	153.9	44.30	2.3
50.00 to 59.99	50	57.5	9.33	1.92	24.87	0.58	2.30	88.7	78.9	65.4	54.2	43.4	112.2	126.4	143.6	55.37	2.5
60.00 to 74.99	60	68.7	10.4	1.29	26.99	0.35	2.18	89.0	79.7	66.8	55.4	44.4	112.3	126.0	141.8	66.45	
75.00 to 99.99	75	86.9	14.3	1.37	27.09	0.35	2.45	89.2	79.3	64.7	53.6	43.1	117.2	136.2	157.8	83.06	2.6
100.0 to 124.9	100	113.0	18.7	1.08	23.80	0.23	2.33	88.1	78.0	64.3	54.2	42.9	114.9	129.8	144.6	110.7	2.8
125.0 to 149.9	125	134.0	14.9	1.05	22.90	0.35	2.31	88.8	79.0	65.0	54.0	44.0	115.0	130.0	145.0	138.4	3.2
150.0 to 174.9	150	169.0	45.2	0.96	21.61	0.39	1.73	90.5	82.6	70.7	58.7	47.8	112.2	126.1	142.4	166.1	3.5
175.0 to 199.9	175	169.0	45.2	0.96	21.61	0.39	1.80	90.3	81.9	69.8	57.8	46.6	112.9	127.6	144.8	183.0	4.1
200.0 to 249.9	200	231.0	81.8	0.72	20.84	0.23	1.50	92.2	84.8	71.1	58.6	46.9	114.6	130.5	148.0	209.2	4.5
250.0 to 299.9	250	272.0	41.1	0.71	18.72	0.35	1.36	91.9	85.5	72.3	60.0	47.6	109.8	122.7	136.4	281.5	4.7
300.0 to 324.9	300	323.0	45.1	0.53	18.44	0.23	1.25	93.1	86.1	72.9	60.8	48.6	108.7	118.8	130.9	313.8	
325.0 to 349.9	325	323.0	45.1	0.53	18.44	0.23	1.33	92.2	84.9	72.7	60.5		109.9	122.2	137.8	339.9	5.0
350.0 to 399.9	350	375.0	68.3	0.99	19.24	0.46	1.27									366.1	5.5
400.0 to 449.9	400	429.0	80.7	1.11	18.92	0.46	1.81									418.4	5.6
450.0 to 499.9	450	481.0	85.5	0.95	19.01	0.48	1.77									470.7	5.6
500.0 to 599.9	500	534.0	99.2	1.05	18.39	0.45	1.58									523.0	7.5
600.0 to 699.9	600	638.0	140.0	0.85	18.38	0.39	1.84									627.6	9.8
700.0 to 749.9	700	756.0	164.0	1.02	21.92	0.70	1.80									732.1	
750.0 to 799.9	750	866.0	144.0	1.15	24.53	0.53	1.61									784.4	
800.0 to 849.9	800	870.0	209.0	1.17	21.69	0.45	1.29									836.7	
850.0 to 899.9	850	923.0	172.0	1.34	25.44	0.60	0.97									889.0	
900.0 or above	900	984.0	239.0	1.40	23.79	0.55										941.3	

Note: A box (■) replaces S or H depending on the enclosure.

5.2 Details of Function Codes

This section provides the details of the function codes. The descriptions are, in principle, arranged in the order of function code groups and in numerical order. However, highly relevant function codes are collectively described where one of them first appears.

5.2.1 Fundamental Functions

F00 Data Protection

F00 specifies whether to protect function code data (except F00) and digital reference data (such as frequency command and PID command) from accidentally getting changed by pressing the \odot / \ominus keys on the keypad.

Data for F00	Changing function code data		Changing digital reference data with the \odot / \ominus keys
	From the keypad	Via communications link	
0	Allowed	Allowed	Allowed
1	Not allowed *	Allowed	Allowed
2	Allowed	Allowed	Not allowed
3	Not allowed *	Allowed	Not allowed

*Only F00 data can be modified with the keypad, while all other function codes cannot.

To change F00 data, simultaneous keying of " $\text{STOP} + \odot$ " (from 0 to 1) or " $\text{STOP} + \ominus$ " (from 1 to 0) keys is required.

For similar purposes, **WE-KP**, a signal enabling editing of function code data from the keypad is provided as a terminal command for digital input terminals. (Refer to the descriptions of E01 through E07, data = 19)

The relationship between the terminal command **WE-KP** and F00 data are as shown below.

WE-KP	Changing function code data	
	From the keypad	Via communications link
OFF	Not allowed	Allowed
ON	Follow the F00 setting	

- Note**
- If you mistakenly assign the terminal command **WE-KP**, you no longer edit or modify function code data. In such a case, temporarily turn this **WE-KP**-assigned terminal ON and reassign the **WE-KP** to a correct command.
 - **WE-KP** is only a signal that allows you to change function code data, so it does not protect the frequency settings or PID command specified by the \odot and \ominus keys.

Tip Even when F00 = 1 or 3, function code data can be changed via the communications link.

F01 Frequency Command 1

F18 (Bias, Frequency command 1)	C30 (Frequency Command 2)
C31 to C35 (Analog Input Adjustment for [12])	C36 to C39 (Analog Input Adjustment for [C1])
C41 to C45 (Analog Input Adjustment for [V2])	C50 (Bias (Frequency command 1), Bias base point)
H61 (UP/DOWN Control, Initial frequency setting)	d59, d61 to d63 (Command (Pulse Rate Input))

F01 or C30 sets a command source that specifies reference frequency 1 or reference frequency 2.

Data for F01, C30	Function	Refer to:
0	Enable \odot / \ominus keys on the keypad.	[1]
1	Enable the voltage input to terminal [12] (0 to ± 10 VDC, maximum frequency obtained at ± 10 VDC).	[2]
2	Enable the current input to terminal [C1] (+4 to +20 mA DC, maximum frequency obtained at +20 mA DC). (SW5 on the control PCB should be turned to the C1 side (factory default).)	
3	Enable the sum of voltage (0 to ± 10 VDC) and current inputs (+4 to +20 mA DC) given to terminals [12] and [C1], respectively. See the two items listed above for the setting range and the value required for maximum frequencies. (SW5 on the control PCB should be turned to the C1 side (factory default).) Note: If the sum exceeds the maximum frequency (F03), the maximum frequency will apply.	
5	Enable the voltage input to terminal [V2] (-10 to ± 10 VDC, maximum frequency obtained at ± 10 VDC). (SW5 on the control circuit board should be turned to the V2 position (factory default).)	[3]
7	Enable UP and DOWN commands assigned to the digital input terminals. The UP command (any of E01 to E07 = 17) and DOWN command (any of E01 to E07 = 18) should be assigned to any of digital input terminals [X1] to [X7]. For details, refer to the descriptions of E01 through E07.	
8	Enable \odot / \ominus keys on the keypad (balanceless-bumpless switching available).	[1]
11	Enable a digital input interface card (option). (For details, refer to the Digital Input Interface Card Instruction Manual.)	—
12	Enable the "Pulse train input" PIN command assigned to digital input terminal [X7] (E07 = 48), or a PG interface card (option).	[4]

F codes

Configuring a reference frequency

[1] Using \odot and \ominus keys (F01 = 0 (factory default) or 8)

- (1) Set function code F01 at "0" or "8" (\odot / \ominus keys on keypad). This cannot be done when the keypad is in Programming or Alarm mode. To enable frequency setting using the \odot and \ominus keys, first place the keypad in Running mode.
- (2) Press the \odot or \ominus key. The 7-segment LED monitor displays the reference frequency and the LCD monitor displays the related information including the operation guide, as shown below.

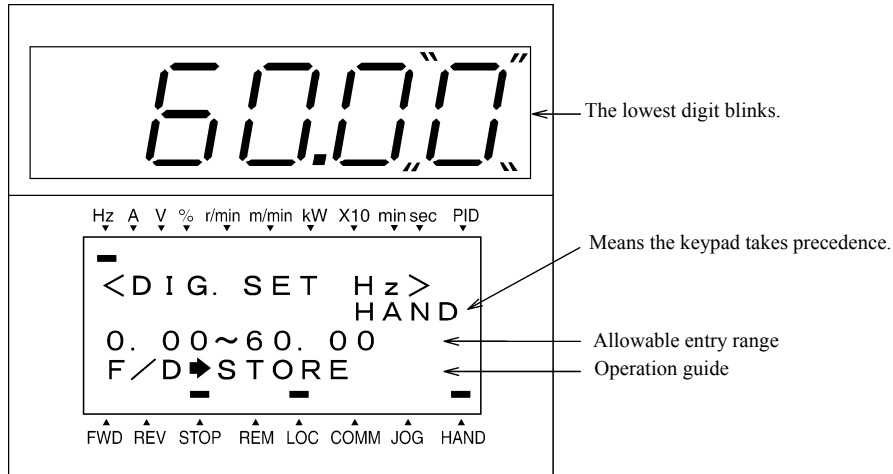

Example of Reference Frequency Configuration Screen

- (3) To change the reference frequency, press the \odot or \ominus key again. To save the new setting into the inverter's memory, press the FUNC DATA key (when E64 = 1 (factory default)). When the power is turned ON next time, the new setting will be used as an initial reference frequency.

In addition to saving with the FUNC DATA key described above, "Automatic saving when the main power is turned OFF" is also possible (when E64 = 0).



- When you start accessing the reference frequency or any other parameter with the \odot and \ominus keys, the least significant digit on the display blinks and starts changing. As you are holding down the key, blinking gradually moves to the upper digit places and the upper digits becomes changeable.
- Pressing the SHIFT key moves the changeable digit place (blinking), making it easy to change upper digits.
- Setting function code C30 at "0" (Enable \odot / \ominus keys on the keypad) and selecting frequency command 2 as a frequency command source makes it possible to access the reference frequency in the same manner using the \odot and \ominus keys.
- If you have set function code F01 at "0" (\odot / \ominus keys on keypad) but have selected a frequency command source other than frequency 1 (i.e., frequency 2, via communications link, or as a multi-frequency), then using the \odot or \ominus key cannot change the frequency command even if the keypad is in Running mode. Pressing either of these keys just displays the currently selected frequency command.
- Setting function code F01 at "8" (\odot / \ominus keys on keypad) enables the balanceless-bumpless switching. When the frequency command source is switched to the keypad from any other source, the inverter inherits the current frequency that has applied before switching, providing smooth switching and shockless running.
- When the frequency command source is other than the digital reference setting, the LCD monitor displays the following.

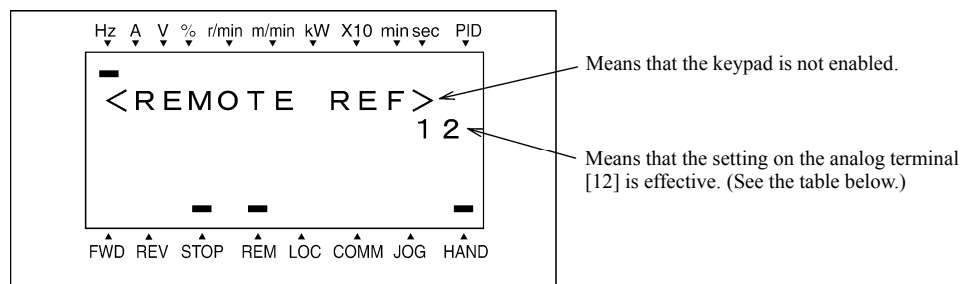

The table below lists the available command sources and their symbols.

Available Command Sources

Symbol	Command source	Symbol	Command source	Symbol	Command source
HAND	Keypad	MULTI	Multi-frequency	PID-HAND	PID keypad command
12	Terminal [12]			PID-P1	PID command 1 (Analog command)
C1	Terminal [C1]	RS485-1	RS-485 (Port 1) *1	PID-P2	PID command 2 (Analog command)
12 + C1	Terminal [12] + Terminal [C1]	RS485-2	RS-485 (Port 2) *2	PID-U/D	PID UP/DOWN command
V2	Terminal [V2]	BUS	Bus option	PID_LINK	PID communications command
U/D	UP/DOWN control	LOADER	Inverter support software "FRENIC Loader"	PID+MULTI	PID multi-frequency command

*1 COM port 1 which refers to the RJ-45 connector on the inverter.

*2 COM port 2 which is on the inverter's terminal block.

[2] Using analog input (F01 = 1 to 3, or 5)

When any analog input (voltage input to terminals [12] and [V2], or current input to terminal [C1]) is selected by F01, it is possible to arbitrarily specify the reference frequency by multiplying the gain and adding the bias. The polarity can be selected and the filter time constant and offset can be adjusted.

Adjustable elements of frequency command 1

Data for F01	Input terminal	Input range	Bias		Gain		Polarity	Filter time constant	Offset
			Bias	Base point	Gain	Base point			
1	[12]	0 to +10 V, -10 to +10V	F18	C50	C32	C34	C35	C33	C31
2	[C1]	4 to 20 mA	F18	C50	C37	C39	-	C38	C36
3	[12] + [C1] (Sum of the two values)	0 to +10 V, -10 to +10 V	F18	C50	C32	C34	C35	C33	C31
		4 to 20 mA	F18	C50	C37	C39	-	C38	C36
5	[V2]	0 to +10 V, -10 to +10 V	F18	C50	C42	C44	C45	C43	C41

■ **Offset (C31, C36, C41)**

C31, C36 or C41 specifies an offset for analog input voltage or current. The offset also applies to signals sent from the external equipment.

■ **Filter time constant (C33, C38, C43)**

C33, C38, or C43 specifies a filter time constant for analog input voltage or current. Choose an appropriate value for the time constant taking into account the response speed of the machinery system since a large time constant slows down the response. When the input voltage fluctuates due to noise, specify a larger time constant.

■ **Polarity (C35, C45)**

C35 or C45 specifies the input range for analog input voltage.

Data for C35/C45	Terminal input specifications
0	-10 to +10 VDC
1	0 to +10 VDC (negative value of voltage is regarded as 0 V)

F codes

■ Gain and bias

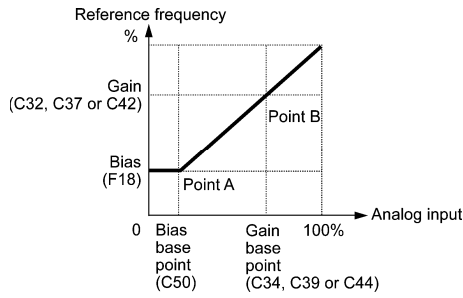

Note If F01 = 3 (the sum of [12] + [C1] is enabled), the bias and gain are independently applied to each of the voltage and current inputs given to terminals [12] and [C1], and the sum of the two values is applied as the reference frequency.

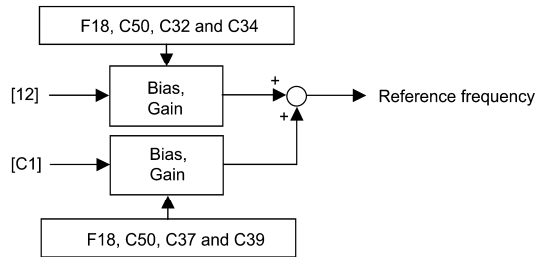

In the case of unipolar input (terminal [12] with C35 = 1, terminal [C1], terminal [V2] with C45 = 1)

As shown in the graph above, the relationship between the analog input and the reference frequency specified by frequency command 1 can arbitrarily be determined by points "A" and "B." Point "A" is defined by the combination of the bias (F18) and its base point (C50); Point "B," by the combination of the gain (C32, C37 or C42) and its base point (C34, C39 or C44).

The combination of C32 and C34 applies to terminal [12], that of C37 and C39, to [C1] (C1 function), and that of C42 and C44, to [C1] (V2 function).

Configure the bias (F18) and gain (C32, C37 or C42), assuming the maximum frequency as 100%, and the bias base point (C50) and gain base point (C34, C39 or C44), assuming the full scale (10 VDC or 20 mA DC) of analog input as 100%.

- The analog input less than the bias base point (C50) is limited by the bias value (F18).
- Specifying that the data of the bias base point (C50) is equal to or greater than that of each gain base point (C34, C39 or C44) will be interpreted as invalid, so the inverter will reset the reference frequency to 0 Hz.

Example: Setting the bias, gain and their base points when the reference frequency 0 to 60 Hz follows the analog input of 1 to 5 VDC to terminal [12] (in frequency command 1).

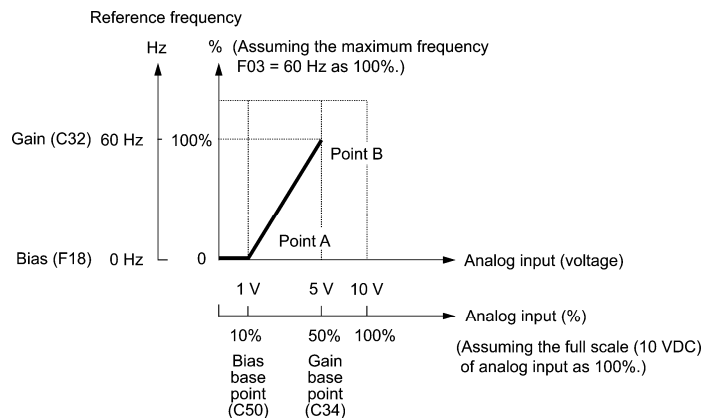

(Point A)

To set the reference frequency to 0 Hz for an analog input being at 1 V, set the bias to 0% (F18 = 0). Since 1 V is the bias base point and it is equal to 10% of 10 V (full scale of terminal [12]), set the bias base point to 10% (C50 = 10).

(Point B)

To make the maximum frequency equal to the reference frequency for an analog input being at 5 V, set the gain to 100% (C32 = 100). Since 5 V is the gain base point and it is equal to 50% of 10 V (full scale of terminal [12]), set the gain base point to 50% (C34 = 50).

Note The setting procedure for specifying a gain or bias alone without changing any base points is the same as that of Fuji conventional inverters of FRENIC5000G11S/P11S series, FVR-E11S series, etc.

In the case of bipolar input (terminal [12] with C35 = 0, terminal [V2] with C45 = 0)

Setting C35 and C45 data to "0" enables terminal [12] and [V2] to be used for bipolar input (-10 V to +10 V) respectively.

When both F18 (Bias) and C50 (Bias base point) are set to "0," the negative and positive voltage inputs produce reference frequencies symmetric about the origin point as shown below.

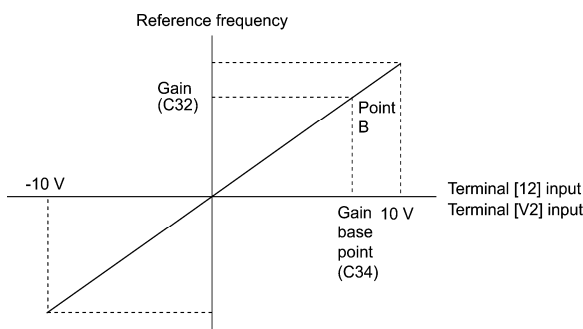

Note Configuring F18 (Bias) and C50 (Bias base point) to specify an arbitrary value (Points A1, A2, and A3) gives the bias as shown below.

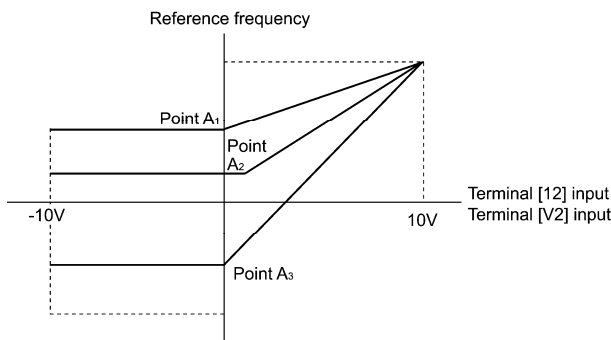

Note A reference frequency can be specified not only with the frequency (Hz) but also with other menu items, depending on the setting of function code E48 (= 3 to 5, or 7).

F codes

[3] Using digital input signals UP/DOWN (F01 = 7)

When the **UP/DOWN** control is selected for frequency setting with a run command ON, turning the terminal command **UP** or **DOWN** ON causes the output frequency to increase or decrease, respectively, within the range from 0 Hz to the maximum frequency as listed below.

To enable the **UP/DOWN** control for frequency setting, it is necessary to set F01 data to "7" and assign the **UP** and **DOWN** commands to any of digital input terminals [X1] to [X7], [FWD] and [REV] with any of E01 to E07 (data = 17 or 18).

UP	DOWN	Function
Data = 17	Data = 18	
OFF	OFF	Keep the current output frequency.
ON	OFF	Increase the output frequency with the acceleration time currently specified.
OFF	ON	Decrease the output frequency with the deceleration time currently specified.
ON	ON	Keep the current output frequency.

■ Specifying the initial value for the **UP/DOWN** control

Specify the initial value to start the **UP/DOWN** control.

Data for H61	Initial value to start the UP/DOWN control
0	Mode fixing the value at "0": The inverter automatically clears the value to "0" when restarted (including powered ON). Speed up by the UP command.
1	Mode holding the final output frequency in the previous UP/DOWN control: The inverter internally holds the last output frequency set by the UP/DOWN control and applies the held frequency at the next restart (including powering ON).

Note At the time of restart, if an **UP** or **DOWN** terminal command is entered before the internal frequency reaches the output frequency saved in the memory, the inverter saves the current output frequency into the memory and starts the **UP/DOWN** control with the new frequency.
Pressing one of these keys overwrites the frequency held in the inverter.

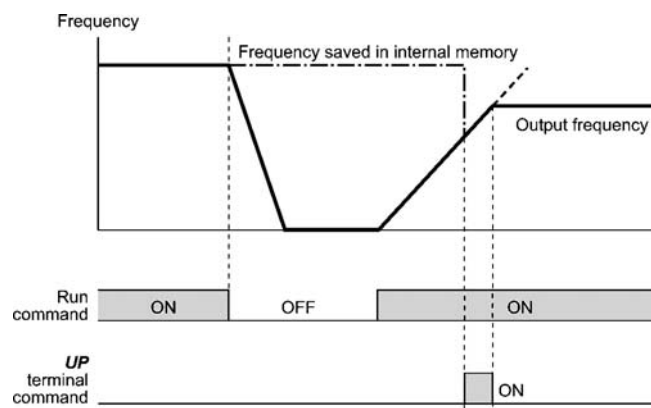

Initial frequency for the **UP/DOWN** control when the frequency command source is switched

When the frequency command source is switched to the **UP/DOWN** control from other sources, the initial frequency for the **UP/DOWN** control is as listed below:

Frequency command source	Switching command	Initial frequency for UP/DOWN control	
		H61 = 0	H61 = 1
Other than UP/DOWN (F01, C30)	Select frequency command 2/1 (Hz2/Hz1)	Reference frequency given by the frequency command source used just before switching	
PID control	Cancel PID control (Hz/PID)	Reference frequency given by PID control (PID controller output)	
Multi-frequency	Select multi-frequency (SS1, SS2, SS4 and SS8)	Reference frequency given by the frequency command source used just before switching	Reference frequency at the time of previous UP/DOWN control
Communications link	Enable communications link via RS-485 or fieldbus (LE)		

[4] Using pulse train input (F01 = 12)

■ Selecting the pulse train input format (d59)

A pulse train in the format selected by the function code d59 can give a frequency command to the inverter. Three types of formats are available; the pulse train sign/pulse train input, the forward rotation pulse/reverse rotation pulse, and the A and B phases with 90 degree phase difference. If no optional PG interface card is mounted, the inverter ignores the setting of the function code d59 and accepts only the pulse train sign/pulse train input.

The table below lists pulse train formats and their operations.

Pulse train input format selected by d59	Operation overview
0: Pulse train sign/ Pulse train input	Frequency/speed command according to the pulse train rate is given to the inverter. The pulse train sign specifies the polarity of the frequency/speed command. <ul style="list-style-type: none"> For the inverter without an optional PG interface card Pulse train input: <i>PIN</i> assigned to the digital terminal [X7] (data = 48) Pulse train sign: <i>SIGN</i> assigned to a digital terminal other than [X7] (data = 49) If no <i>SIGN</i> is assigned, polarity of any pulse train input is positive.
1: Forward rotation pulse/Reverse rotation pulse	Frequency/speed command according to the pulse train rate is given to the inverter. The forward rotation pulse gives a frequency/speed command with positive polarity, and a reverse rotation pulse, with negative polarity.
2: A and B phases with 90 degree phase difference	Pulse trains generated by A and B phases with 90 degree phase difference give a frequency/speed command based on their pulse rate and the phase difference to an inverter.

For details of operations using the optional PG interface card, refer to the Instruction Manual for it.

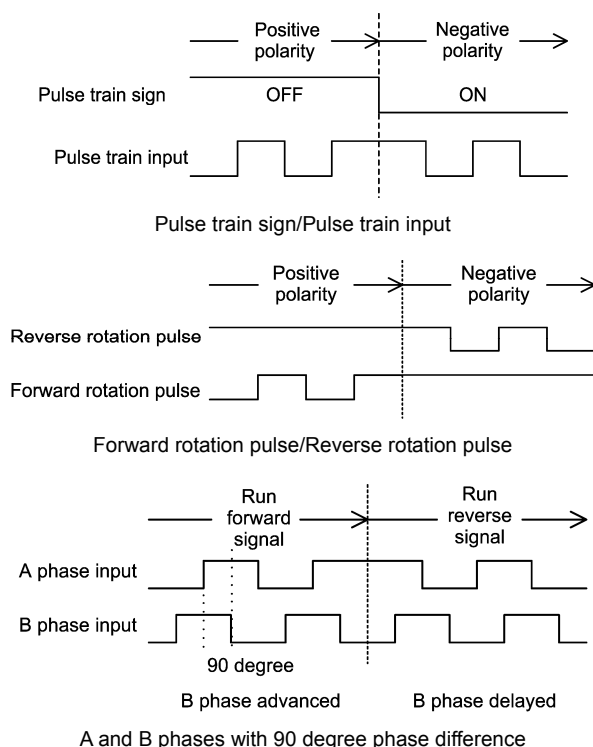

■ Pulse count factor 1 (d62), Pulse count factor 2 (d63)

For the pulse train input, function codes d62 (Command (Pulse rate input), (Pulse count factor 1)) and d63 (Command (Pulse rate input), (Pulse count factor 2)) define the relationship between the input pulse rate and the frequency command (reference).

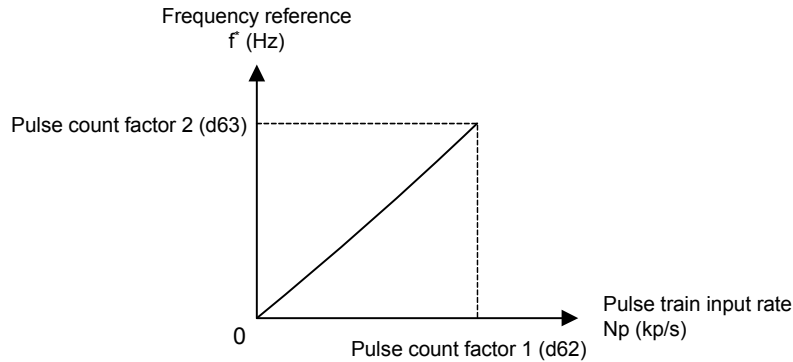

Relationship between the Pulse Train Input Rate and Frequency Command (Reference)

As shown in the figure above, enter the pulse train input rate into function code d62 (Command (Pulse rate input), (Pulse count factor 1)), and enter the frequency reference defined by d62 into d63 (Command (Pulse rate input), (Pulse count factor 2)). The relationship between the pulse train input rate (kp/s) inputted to the *PIN* terminal and the frequency reference f^* (Hz) (or speed command) is given by the expression below.

$$f^* \text{ (Hz)} = N_p \text{ (kp/s)} \times \frac{\text{Pulse count factor 2 (d63)}}{\text{Pulse count factor 1 (d62)}}$$

f^* (Hz) : Frequency reference

N_p (kp/s) : Input pulse rate

In the case of A and B phases with 90 degree phase difference, note that the pulse train rate is not the one 4-multiplied.

The pulse train sign, forward/reverse rotation pulse, and A/B phase difference define the polarity of the pulse train input. Combination of the polarity of the pulse train input and the *FWD/REV* command determines the rotational direction of the motor. The table below shows the relationship between the polarity of the pulse train input and the motor rotational direction.

Pulse Train Polarity	Run command	Motor rotational direction
Positive (+)	<i>FWD</i> (Run forward command)	Forward
Positive (+)	<i>REV</i> (Run reverse command)	Reverse
Negative (-)	<i>FWD</i> (Run forward command)	Reverse
Negative (-)	<i>REV</i> (Run reverse command)	Forward

Note Mounting an optional PG interface card automatically switches the pulse train input source to the card and disables the input from the terminal [X7].

■ Filter time constant (d61)

d61 specifies a filter time constant for pulse train input. Choose an appropriate value for the time constant taking into account the response speed of the machinery system since a large time constant slows down the response. When the reference frequency fluctuates due to small number of pulses, specify a larger time constant.

Switching frequency command

Using the terminal command *H_{z2}/H_{z1}* assigned to one of the digital input terminals switches between frequency command 1 (F01) and frequency command 2 (C30).

For details about *H_{z2}/H_{z1}*, refer to E01 to E07 (data = 11).

Terminal command <i>H_{z2}/H_{z1}</i>	Frequency command source
OFF	Follow F01 (Frequency command 1)
ON	Follow C30 (Frequency command 2)

F02 Operation Method

F02 selects the source that specifies a run command.

Data for F02	Run Command	Description
0	Keypad	Enables the FWD , REV , and STOP keys to run the motor in the forward and reverse directions, and stop the motor.
1	Terminal command <i>FWD</i> or <i>REV</i>	Enables input terminal commands <i>FWD</i> and <i>REV</i> to run the motor in the forward and reverse directions, and stop the motor.
2	Keypad (Forward rotation)	Enables the FWD and STOP keys to run the motor in the forward direction and stop it. Running the motor in the reverse direction is not possible.
3	Keypad (Reverse rotation)	Enables the REV and STOP keys to run the motor in the reverse direction and stop it. Running the motor in the forward direction is not possible.

- Note**
- When F02 = 1, the "Run forward" *FWD* and "Run reverse" *REV* terminal commands must be assigned to terminals [FWD] and [REV], respectively.
 - When the FWD or REV is ON, the F02 data cannot be changed.
 - When changing terminal command assignments to terminals [FWD] and [REV] from commands other than the *FWD* and *REV* to the *FWD* or *REV* with F02 being set to "1," be sure to turn the target terminal OFF beforehand; otherwise, the motor may unintentionally rotate.

■ 3-wire operation with external input signals (digital input terminal commands)

The default setting of the *FWD* and *REV* are 2-wire. Assigning the terminal command *HLD* self-holds the forward *FWD* or reverse *REV* run command, to enable 3-wire inverter operation. Short-circuiting the *HLD*-assigned terminal and [CM] (i.e., when *HLD* is ON) self-holds the first *FWD* or *REV* at its rising edge. Turning the *HLD* OFF releases the self-holding. When no *HLD* is assigned, 2-wire operation involving only *FWD* and *REV* takes effect.

For details about *HLD*, refer to E01 to E07 (data = 6).

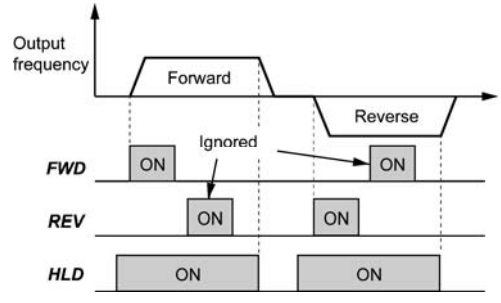

In addition to the run command sources described above, higher priority command sources including remote and local mode (see Section 7.3.6) and communications link are provided. For details, refer to the block diagrams in Chapter 6 in FRENIC-MEGA User's Manual.

F03 Maximum Frequency 1

F03 specifies the maximum frequency to limit the output frequency. Specifying the maximum frequency exceeding the rating of the equipment driven by the inverter may cause damage or a dangerous situation. Make sure that the maximum frequency setting matches the equipment rating.

- Data setting range: 25.0 to 500.0 (Hz)

- Note**
- For LD/MD-mode inverters, set the maximum frequency at 120 Hz or below.
 - Under vector control with speed sensor, set the maximum frequency at 200 Hz or below, and under vector control without speed sensor, at 120 Hz or below.
 - If a setting exceeding the maximum setting value (e.g., 500 Hz) is made, the reference speed and analog output (FMA) will be based on the full scale/reference value (10V/500 Hz). However, the frequency is internally limited. Even if 10 V is inputted, the frequency 500 Hz will be internally limited to 200 Hz.

⚠ WARNING

The inverter can easily accept high-speed operation. When changing the speed setting, carefully check the specifications of motors or equipment beforehand.

Otherwise injuries could occur.

- Note** Modifying F03 data to allow a higher reference frequency requires also changing F15 data specifying a frequency limiter (high).

F04 to F05 Base Frequency 1, Rated Voltage at Base Frequency 1
F06 Maximum Output Voltage 1

H50, H51 (Non-linear V/f Pattern 1 (Frequency and Voltage))
H52, H53 (Non-linear V/f Pattern 2 (Frequency and Voltage))
H65, H66 (Non-linear V/f Pattern 3 (Frequency and Voltage))

These function codes specify the base frequency and the voltage at the base frequency essentially required for running the motor properly. If combined with the related function codes H50 through H53, H65 and H66, these function codes may profile the non-linear V/f pattern by specifying increase or decrease in voltage at any point on the V/f pattern.

The following description includes setups required for the non-linear V/f pattern.

At high frequencies, the motor impedance may increase, resulting in an insufficient output voltage and a decrease in output torque. To prevent this problem, use F06 (Maximum Output Voltage 1) to increase the voltage. Note, however, that the inverter cannot output voltage exceeding its input power voltage.

V/f point	Function code		Remarks
	Frequency	Voltage	
Maximum frequency	F03	F06	The setting of the maximum output voltage is disabled when the auto torque boost, torque vector control, vector control without speed sensor, or vector control with speed sensor is selected.
Base frequency	F04	F05	
Non-linear V/f pattern 3	H65	H66	Disabled when the auto torque boost, torque vector control, vector control without speed sensor, or vector control with speed sensor is selected.
Non-linear V/f pattern 2	H52	H53	
Non-linear V/f pattern 1	H50	H51	

Examples:

■ Normal (linear) V/f pattern

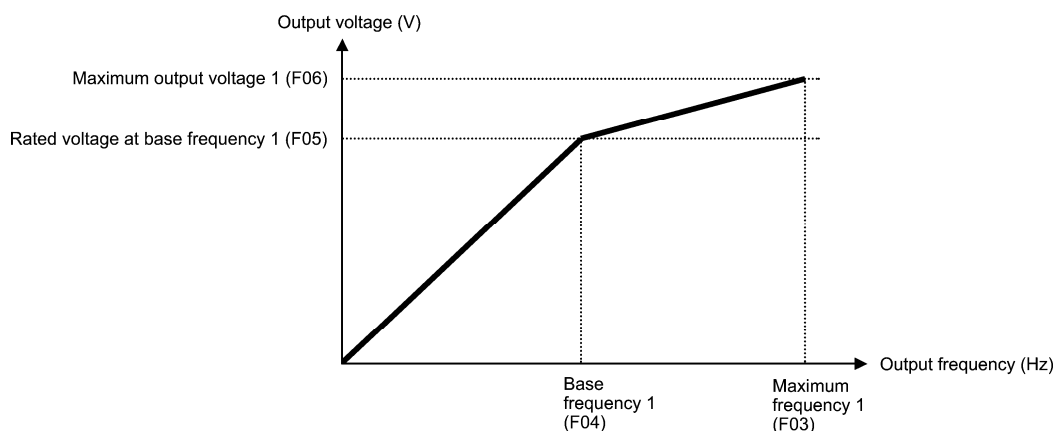

■ V/f pattern with three non-linear points

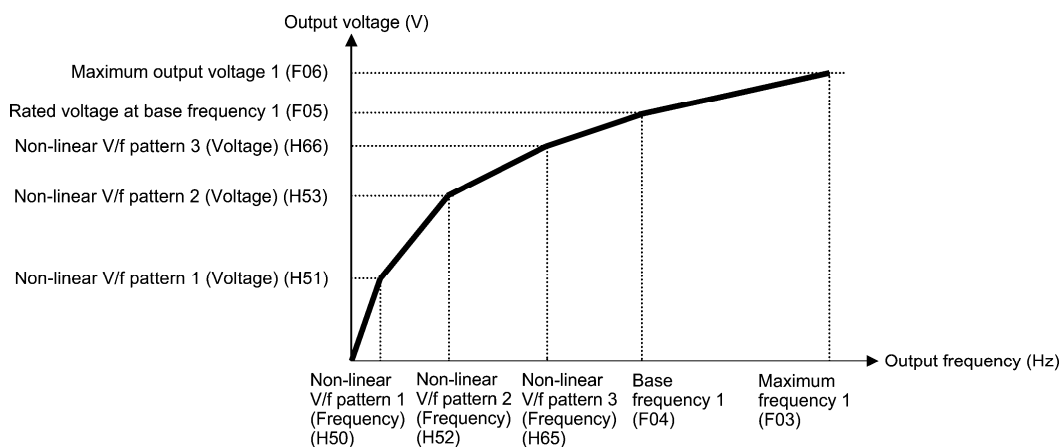

■ Base Frequency 1 (F04) Data setting range: 25.0 to 500.0 (Hz)

Set the rated frequency printed on the nameplate labeled on the motor.

■ Rated Voltage at Base Frequency 1 (F05)

Data setting range: 0: Output a voltage in proportion to input voltage
 (The Automatic Voltage Regulator (AVR) is disabled.)
 80 to 240 (V): Output an AVR-controlled voltage for 230 V series
 160 to 500 (V): Output an AVR-controlled voltage for 460 V series

Set "0" or the rated voltage printed on the nameplate labeled on the motor.

- If F05 = 0, the rated voltage at base frequency is determined by the power source of the inverter. The output voltage will fluctuate in line with the input voltage fluctuation.

- If F05 = an arbitrary value other than 0, the inverter automatically keeps the output voltage constant in line with the setting. When any of the auto torque boost, auto energy saving, etc. is enabled, the F05 data should be equal to the rated voltage of the motor.



In vector control, current feedback control is performed. In the current feedback control, the current is controlled with the difference between the motor induced voltage and the inverter output voltage. For a proper control, the inverter output voltage should be sufficiently higher than the motor induced voltage. Generally, the voltage difference is about 20 V for 230 V series, about 40 V for 460 V series.

The voltage the inverter can output is at the same level as the inverter input voltage. Configure these voltages correctly in accordance with the motor specifications.

When enabling the vector control without speed sensor using a general-purpose motor, set the F05 (Rated Voltage at Base Frequency 1) data at the rated voltage of the motor. The voltage difference described above is specified by function code P56 (Induced voltage factor under vector control). Generally, there is no need to modify the initial setting.

■ Non-linear V/f Patterns 1, 2 and 3 for Frequency (H50, H52 and H65)

Data setting range: 0.0 (cancel); 0.1 to 500.0 (Hz)

Set the frequency component at an arbitrary point in the non-linear V/f pattern.



Setting "0.0" to H50, H52 or H65 disables the non-linear V/f pattern operation.

■ Non-linear V/f Patterns 1, 2 and 3 for Voltage (H51, H53 and H66)

Data setting range: 0 to 240 (V): Output an AVR-controlled voltage for 230 V series
0 to 500 (V): Output an AVR-controlled voltage for 460 V series

Sets the voltage component at an arbitrary point in the non-linear V/f pattern.

■ Maximum Output Voltage 1 (F06)

Data setting range: 80 to 240 (V): Output an AVR-controlled voltage for 230 V series
160 to 500 (V): Output an AVR-controlled voltage for 460 V series

Set the voltage for the maximum frequency 1 (F03).



If F05 (Rated Voltage at Base Frequency 1) is set to "0," settings of H50 through H53, H65, H66 and F06 do not take effect. (When the non-linear point is below the base frequency, the linear V/f pattern applies; when it is above, the output voltage is kept constant.)

F07, F08 Acceleration Time 1, Deceleration Time 1

- E10, E12, E14 (Acceleration Time 2, 3 and 4)
- E11, E13, E15 (Deceleration Time 2, 3 and 4)
- H07 (Acceleration/Deceleration Pattern)
- H56 (Deceleration Time for Forced Stop)
- H54, H55 (Acceleration Time/Deceleration Time, Jogging)
- H57 to H60 (1st and 2nd S-curve Acceleration/Deceleration Range)

F07 specifies the acceleration time, the length of time the frequency increases from 0 Hz to the maximum frequency. F08 specifies the deceleration time, the length of time the frequency decreases from the maximum frequency down to 0 Hz.

- Data setting range: 0.00 to 6000 (s)

Under V/f control

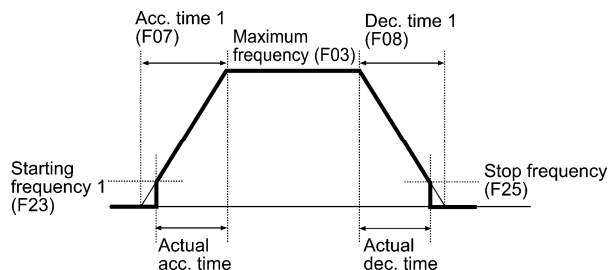

Under vector control without speed sensor

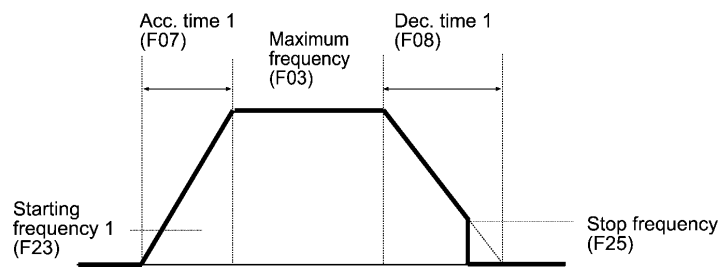

Under vector control with speed sensor

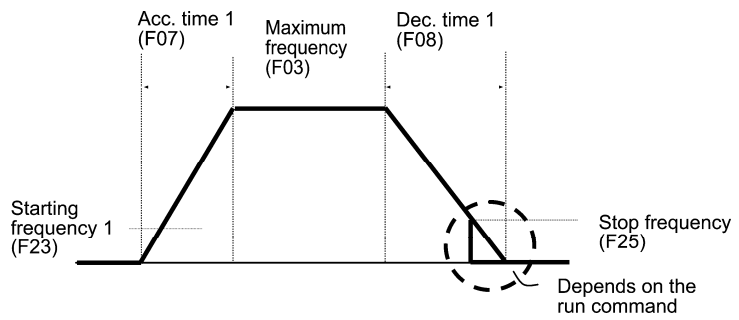

■ Acceleration/deceleration time

Acceleration/ deceleration time	Function code		Switching factor of acceleration/deceleration time (Refer to the descriptions of E01 to E07.)		The combinations of ON/OFF states of the two terminal commands RT2 and RT1 offer four choices of acceleration/deceleration time 1 to 4. (Data = 4, 5) If no terminal command is assigned, only the acceleration/deceleration time 1 (F07/F08) is effective.
	ACC time	DEC time	RT1	RT2	
Acceleration/ deceleration time 1	F07	F08	OFF	OFF	
Acceleration/ deceleration time 2	E10	E11	OFF	ON	
Acceleration/ deceleration time 3	E12	E13	ON	OFF	
Acceleration/ deceleration time 4	E14	E15	ON	ON	
At jogging operation	H54	H55	When the terminal command JOG is ON, jogging operation is possible. (Data = 10) (Refer to the description of C20.)		
At forced stop	—	H56	When the terminal command STOP is OFF, the motor decelerates to a stop in accordance with the deceleration time for forced stop (H56). After the motor stops, the inverter enters the alarm state with the alarm $\overline{E}r\overline{E}$ displayed. (Data = 30)		

F codes

■ Acceleration/Deceleration pattern (H07)

H07 specifies the acceleration and deceleration patterns (patterns to control output frequency).

Data for H07	Acceleration/deceleration pattern	Motion		Function code
0	Linear	The inverter runs the motor with the constant acceleration and deceleration.		—
1	S-curve (Weak)	To reduce an impact that acceleration/deceleration would make on the machine, the inverter gradually accelerates or decelerates the motor in both the starting and ending zones of acceleration or deceleration.	Weak: The acceleration/deceleration rate to be applied to all of the four inflection zones is fixed at 5% of the maximum frequency.	—
2	S-curve (Arbitrary)		Arbitrary: The acceleration/deceleration rate can be arbitrarily specified for each of the four inflection zones.	H57 H58 H59 H60
3	Curvilinear	Acceleration/deceleration is linear below the base frequency (constant torque) but it slows down above the base frequency to maintain a certain level of load factor (constant output). This acceleration/deceleration pattern allows the motor to accelerate or decelerate with the maximum performance of the motor.		—

S-curve acceleration/deceleration

To reduce an impact that acceleration/deceleration would make on the machine, the inverter gradually accelerates or decelerates the motor in both the starting and ending zones of acceleration or deceleration. Two types of S-curve acceleration/deceleration rates are available; applying 5% (weak) of the maximum frequency to all of the four inflection zones, and specifying arbitrary rate for each of the four zones with function codes H57 to H60. The reference acceleration/deceleration time determines the duration of acceleration/deceleration in the linear period; hence, the actual acceleration/deceleration time is longer than the reference acceleration/deceleration time.

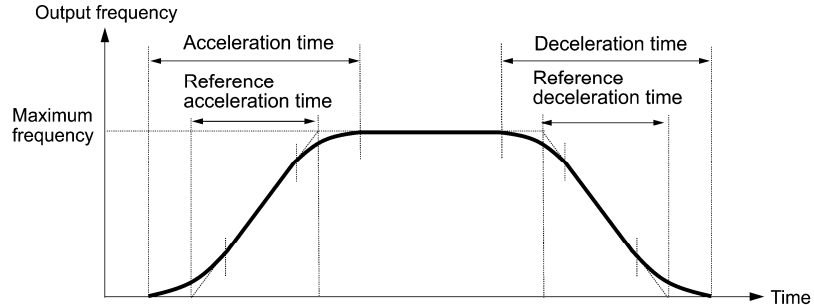

	Acceleration		Deceleration	
	Starting zone	Ending zone	Starting zone	Ending zone
S-curve (Weak)	5%	5%	5%	5%
S-curve (Arbitrary) Setting range: 0 to 100%	H57 Acceleration rate for the 1st S-curve (Leading edge)	H58 Acceleration rate for the 2nd S-curve (Trailing edge)	H59 Deceleration rate for the 1st S-curve (Leading edge)	H60 Deceleration rate for the 2nd S-curve (Trailing edge)

<S-curve acceleration/deceleration (weak): when the frequency change is 10% or more of the maximum frequency>

$$\begin{aligned} \text{Acceleration or deceleration time (s)} &= (2 \times 5/100 + 90/100 + 2 \times 5/100) \times (\text{reference acceleration or deceleration time}) \\ &= 1.1 \times (\text{reference acceleration or deceleration time}) \end{aligned}$$

<S-curve acceleration/deceleration (arbitrary): when the frequency change is 30% or more of the maximum frequency--10% at the leading edge and 20% at the trailing edge>

$$\begin{aligned} \text{Acceleration or deceleration time (s)} &= (2 \times 10/100 + 70/100 + 2 \times 20/100) \times (\text{reference acceleration or deceleration time}) \\ &= 1.3 \times (\text{reference acceleration or deceleration time}) \end{aligned}$$

Curvilinear acceleration/deceleration

Acceleration/deceleration is linear below the base frequency (constant torque) but it slows down above the base frequency to maintain a certain level of load factor (constant output).

This acceleration/deceleration pattern allows the motor to accelerate or decelerate with its maximum performance.

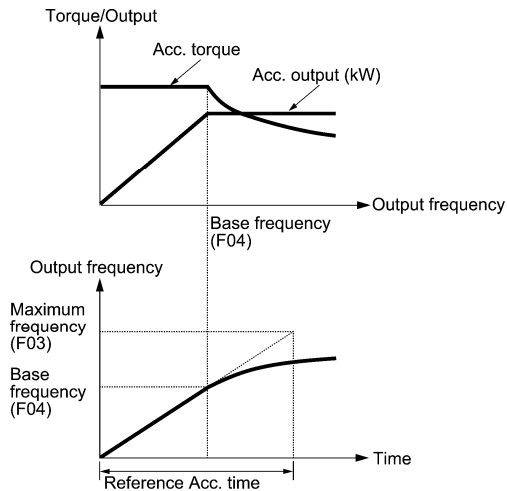

The figures at left show the acceleration characteristics. Similar characteristics apply to the deceleration.



- If you choose S-curve acceleration/deceleration or curvilinear acceleration/deceleration in Acceleration/Deceleration Pattern (H07), the actual acceleration/deceleration times are longer than the specified times.
- Specifying an improperly short acceleration/deceleration time may activate the current limiter, torque limiter, or anti-regenerative control, resulting in a longer acceleration/deceleration time than the specified one.

F09 Torque Boost 1

(Refer to F37.)

F codes

F10 to F12 Electronic Thermal Overload Protection for Motor 1
(Select motor characteristics, Overload detection level, and Thermal time constant)

F10 through F12 specify the thermal characteristics of the motor for its electronic thermal overload protection that is used to detect overload conditions of the motor.

Upon detection of overload conditions of the motor, the inverter shuts down its output and issues a motor overload alarm $\overline{OL} 1$ to protect motor 1.

- Note**
- Thermal characteristics of the motor specified by F10 and F12 are also used for the overload early warning. Even if you need only the overload early warning, set these characteristics data to these function codes. (Refer to the description of E34.)
 - For motors with PTC thermistor, connecting the PTC thermistor to the terminal [V2] enables the motor overheat protective function. For details, refer to the description of H26.

■ Select motor characteristics (F10)

F10 selects the cooling mechanism of the motor--shaft-driven or separately powered cooling fan.

Data for F10	Function
1	For a general-purpose motor with shaft-driven cooling fan (The cooling effect will decrease in low frequency operation.)
2	For an inverter-driven motor, non-ventilated motor, or motor with separately powered cooling fan (The cooling effect will be kept constant regardless of the output frequency.)

The figure below shows operating characteristics of the electronic thermal overload protection when F10 = 1. The characteristic factors $\alpha 1$ through $\alpha 3$ as well as their corresponding switching frequencies f_2 and f_3 vary with the characteristics of the motor. The tables below list the factors of the motor selected by P99 (Motor 1 Selection).

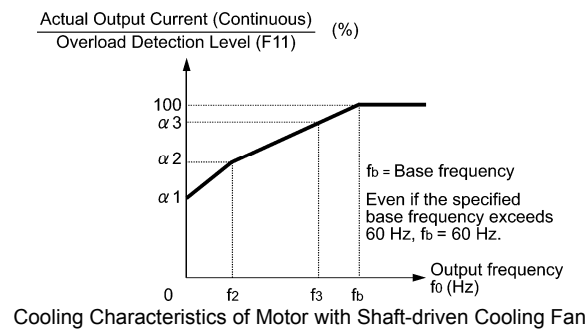

Nominal Applied Motor and Characteristic Factors when P99 (Motor 1 selection) = 0 or 4

Nominal applied motor HP	Thermal time constant τ (Factory default)	Reference current for setting the thermal time constant (I_{max})	Output frequency for motor characteristic factor		Characteristic factor (%)		
			f_2	f_3	$\alpha 1$	$\alpha 2$	$\alpha 3$
0.5, 1	5 min	Allowable continuous current $\times 150\%$	5 Hz	7 Hz	75	85	100
2 to 5					85	85	100
7.5 to 15				6 Hz	90	95	100
20				7 Hz	85	85	100
25, 30				5 Hz	92	100	100
40 to 60	10 min		Base frequency $\times 33\%$	Base frequency $\times 83\%$	54	85	95
75 to 125					51	95	95
150 or above					53	85	90

Nominal Applied Motor and Characteristic Factors when P99 (Motor 1 Selection) = 1 or 3

Nominal applied motor HP	Thermal time constant τ (Factory default)	Reference current for setting the thermal time constant (I_{max})	Output frequency for motor characteristic factor		Characteristic factor (%)		
			f_2	f_3	α_1	α_2	α_3
0.25 to 30	5 min	Allowable continuous current $\times 150\%$	Base frequency $\times 33\%$	Base frequency $\times 33\%$	69	90	90
40 to 60	10 min			Base frequency $\times 83\%$	54	85	95
75 to 125					51	95	95
150 or above					53	85	90

If F10 is set to "2," changes of the output frequency do not affect the cooling effect. Therefore, the overload detection level (F11) remains constant.

■ Overload detection level (F11)

Data setting range: 1 to 135% of the rated current (allowable continuous drive current) of the inverter

In general, set the F11 data to the allowable continuous current of motor when driven at the base frequency (i.e. 1.0 to 1.1 times of the rated current of the motor.)

To disable the electronic thermal overload protection, set the F11 data to "0.00."

■ Thermal time constant (F12)

Data setting range: 0.5 to 75.0 (minutes)

F12 specifies the thermal time constant of the motor. If the current of 150% of the overload detection level specified by F11 flows for the time specified by F12, the electronic thermal overload protection becomes activated to detect the motor overload. The thermal time constant for general-purpose motors is approx. 5 minutes for motors of 30 HP or below and 10 minutes for motors of 40 HP or above by factory default.

(Example) When the F12 data is set at 5 minutes

As shown below, the electronic thermal overload protection is activated to detect an alarm condition (alarm code $\overline{L} / \overline{I}$) when the output current of 150% of the overload detection level (specified by F11) flows for 5 minutes, and 120% for approx. 12.5 minutes.

The actual time required for issuing a motor overload alarm tends to be shorter than the specified value, taking into account the time period from when the output current exceeds the rated current (100%) until it reaches 150% of the overload detection level.

Example of Operating Characteristics

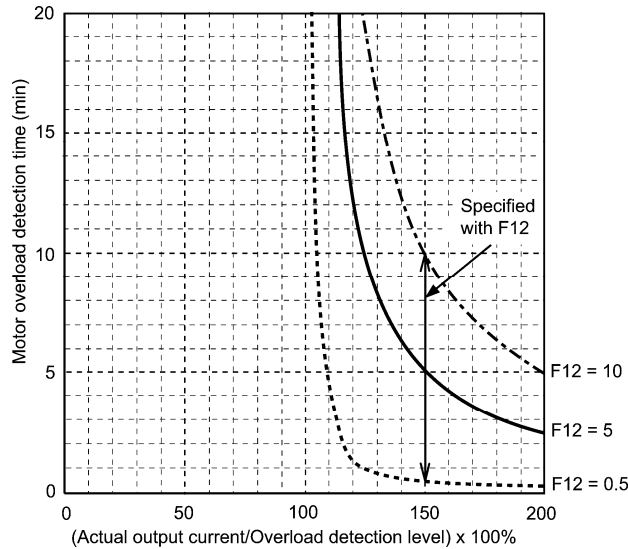

F14	Restart Mode after Momentary Power Failure (Mode selection)
	H13 (Restart Mode after Momentary Power Failure (Restart time))
	H14 (Restart Mode after Momentary Power Failure (Frequency fall rate))
	H15 (Restart Mode after Momentary Power Failure (Continuous running level))
	H16 (Restart Mode after Momentary Power Failure (Allowable momentary power failure time))
	H92 (Continuity of running (P)) H93 (Continuity of running (I))

F14 specifies the action to be taken by the inverter such as trip and restart in the event of a momentary power failure.

■ Restart mode after momentary power failure (Mode selection) (F14)

• Under V/f control

Data for F14	Description	
	Auto search disabled	Auto search enabled
0: Trip immediately	As soon as the DC link bus voltage drops below the undervoltage detection level due to a momentary power failure, the inverter issues undervoltage alarm $\underline{\underline{U}}$ and shuts down its output so that the motor enters a coast-to-stop state.	
1: Trip after recovery from power failure	As soon as the DC link bus voltage drops below the undervoltage detection level due to a momentary power failure, the inverter shuts down its output so that the motor enters a coast-to-stop state, but it does not enter the undervoltage state or issue undervoltage alarm $\underline{\underline{U}}$. The moment the power is restored, an undervoltage alarm $\underline{\underline{U}}$ is issued, while the motor remains in a coast-to-stop state.	
2: Trip after decelerate-to-stop	As soon as the DC link bus voltage drops below the continuous running level due to a momentary power failure, decelerate-to-stop control is invoked. Decelerate-to-stop control regenerates kinetic energy from the load's moment of inertia, slowing down the motor and continuing the deceleration operation. After decelerate-to-stop operation, an undervoltage alarm $\underline{\underline{U}}$ is issued.	
3: Continue to run (for heavy inertia or general loads)	As soon as the DC link bus voltage drops below the continuous running level due to a momentary power failure, continuous running control is invoked. Continuous running control regenerates kinetic energy from the load's moment of inertia, continues running, and waits the recovery of power. When an undervoltage condition is detected due to a lack of energy to be regenerated, the output frequency at that time is saved, the output of the inverter is shut down, and the motor enters a coast-to-stop state.	
	If a run command has been input, restoring power restarts the inverter at the output frequency saved when undervoltage was detected.	If a run command has been input, restoring power performs auto search for idling motor speed and restarts running the motor at the frequency calculated based on the searched speed.
	This setting is ideal for fan applications with a large moment of inertia.	
4: Restart at the frequency at which the power failure occurred (for general loads)	As soon as the DC link bus voltage drops below the undervoltage detection level due to a momentary power failure, the inverter shuts down the output so that the motor enters a coast-to-stop state.	
	If a run command has been input, restoring power restarts the inverter at the output frequency saved when undervoltage was detected.	If a run command has been input, restoring power performs auto search for idling motor speed and restarts running the motor at the frequency calculated based on the searched speed.
	This setting is ideal for applications with a moment of inertia large enough not to slow down the motor quickly, such as fans, even after the motor enters a coast-to-stop state upon occurrence of a momentary power failure.	
5: Restart at the starting frequency	As soon as the DC link bus voltage drops below the undervoltage detection level due to a momentary power failure, the inverter shuts down the output so that the motor enters a coast-to-stop state.	
	If a run command has been input, restoring power restarts the inverter at the starting frequency specified by function code F23.	If a run command has been input, restoring power performs auto search for idling motor speed and restarts running the motor at the frequency calculated based on the searched speed.
	This setting is ideal for heavy load applications such as pumps, having a small moment of inertia, in which the motor speed quickly goes down to zero as soon as it enters a coast-to-stop state upon occurrence of a momentary power failure.	
Auto search is enabled by turning ON the digital terminal command <i>STM</i> ("Enable auto search for idling motor speed at starting") or setting the H09 data to "1" or "2."		
For details about the digital terminal command <i>STM</i> and auto search, refer to the description of H09 (Starting Mode, Auto search).		

• Under vector control without speed sensor

Data for F14	Description	
	Auto search disabled	Auto search enabled
0: Trip immediately	As soon as the DC link bus voltage drops below the undervoltage detection level due to a momentary power failure, the inverter issues undervoltage alarm $\underline{\underline{U}}$ and shuts down its output so that the motor enters a coast-to-stop state.	
1: Trip after recovery from power failure	As soon as the DC link bus voltage drops below the undervoltage detection level due to a momentary power failure, the inverter shuts down its output so that the motor enters a coast-to-stop state, but it does not enter the undervoltage state or issue undervoltage alarm $\underline{\underline{U}}$. The moment the power is restored, an undervoltage alarm $\underline{\underline{U}}$ is issued, while the motor remains in a coast-to-stop state.	
2: Trip after decelerate-to-stop	As soon as the DC link bus voltage drops below the continuous running level due to a momentary power failure, decelerate-to-stop control is invoked. Decelerate-to-stop control regenerates kinetic energy from the load's moment of inertia, slowing down the motor and continuing the deceleration operation. After decelerate-to-stop operation, an undervoltage alarm $\underline{\underline{U}}$ is issued.	
3: Continue to run (for heavy inertia or general loads)	As soon as the DC link bus voltage drops below the undervoltage detection level due to a momentary power failure, the inverter shuts down the output so that the motor enters a coast-to-stop state.	
4: Restart at the frequency at which the power failure occurred (for general loads)	Even if the F14 data is set to "3," the "Continue to run" function is disabled.	
	If a run command has been input, restoring power restarts the inverter at the output frequency saved when undervoltage was detected.	If a run command has been input, restoring power performs auto search for idling motor speed and restarts running the motor at the frequency calculated based on the searched speed.
5: Restart at the starting frequency	As soon as the DC link bus voltage drops below the undervoltage detection level due to a momentary power failure, the inverter shuts down the output so that the motor enters a coast-to-stop state.	
	If a run command has been input, restoring power restarts the inverter at the starting frequency specified by function code F23.	If a run command has been input, restoring power performs auto search for idling motor speed and restarts running the motor at the frequency calculated based on the searched speed.
	This setting is ideal for heavy load applications such as pumps, having a small moment of inertia, in which the motor speed quickly goes down to zero as soon as it enters a coast-to-stop state upon occurrence of a momentary power failure.	
Auto search is enabled by turning ON the digital terminal command <i>STM</i> ("Enable auto search for idling motor speed at starting") or setting the d67 data to "1" or "2."		
For details about the digital terminal command <i>STM</i> and auto search, refer to the description of d67 (Starting Mode, Auto search).		

• Under vector control with speed sensor

Data for F14	Description
0: Trip immediately	As soon as the DC link bus voltage drops below the undervoltage detection level due to a momentary power failure, the inverter issues undervoltage alarm $\underline{\underline{U}}$ and shuts down its output so that the motor enters a coast-to-stop state.
1: Trip after recovery from power failure	As soon as the DC link bus voltage drops below the undervoltage detection level due to a momentary power failure, the inverter shuts down its output so that the motor enters a coast-to-stop state, but it does not enter the undervoltage state or issue undervoltage alarm $\underline{\underline{U}}$. The moment the power is restored, an undervoltage alarm $\underline{\underline{U}}$ is issued, while the motor remains in a coast-to-stop state.
2: Trip after decelerate-to-stop	As soon as the DC link bus voltage drops below the continuous running level due to a momentary power failure, decelerate-to-stop control is invoked. Decelerate-to-stop control regenerates kinetic energy from the load's moment of inertia, slowing down the motor and continuing the deceleration operation. After decelerate-to-stop operation, an undervoltage alarm $\underline{\underline{U}}$ is issued.
3: Continue to run (for heavy inertia or general loads)	As soon as the DC link bus voltage drops below the undervoltage detection level due to a momentary power failure, the inverter shuts down the output so that the motor enters a coast-to-stop state.
4: Restart at the frequency at which the power failure occurred (for general loads)	Even if the F14 data is set to "3," the "Continue to run" function is disabled.
	If a run command has been input, restoring power restarts the inverter at the motor speed detected by the speed sensor.
5: Restart at the starting frequency	

⚠ WARNING

If you enable the "Restart mode after momentary power failure" (Function code F14 = 3, 4, or 5), the inverter automatically restarts the motor running when the power is recovered. Design the machinery or equipment so that human safety is ensured after restarting.

Otherwise an accident could occur.

■ Restart mode after momentary power failure (Basic operation with auto search disabled)

The inverter recognizes a momentary power failure upon detecting the condition that DC link bus voltage goes below the undervoltage detection level, while the inverter is running. If the load of the motor is light and the duration of the momentary power failure is extremely short, the voltage drop may not be great enough for a momentary power failure to be recognized, and the motor may continue to run uninterrupted.

Upon recognizing a momentary power failure, the inverter enters the restart mode (after a recovery from momentary power failure) and prepares for restart. When power is restored, the inverter goes through an initial charging stage and enters the ready-to-run state. When a momentary power failure occurs, the power supply voltage for external circuits such as relay sequence circuits may also drop so as to turn the run command OFF. In consideration of such a situation, the inverter waits 2 seconds for a run command input after the inverter enters a ready-to-run state. If a run command is received within 2 seconds, the inverter begins the restart processing in accordance with the F14 data (Mode selection). If no run command has been received within 2-second wait period, the inverter cancels the restart mode (after a recovery from momentary power failure) and needs to be started again from the ordinary starting frequency. Therefore, ensure that a run command is entered within 2 seconds after a recovery of power, or install a mechanical latch relay.

When run commands are entered via the keypad, the above operation is also necessary for the mode (F02 = 0) in which the rotational direction is determined by the terminal command, **FWD** or **REV**. In the modes where the rotational direction is fixed (F02 = 2 or 3), it is retained inside the inverter so that the restart will begin as soon as the inverter enters the ready-to-run state.

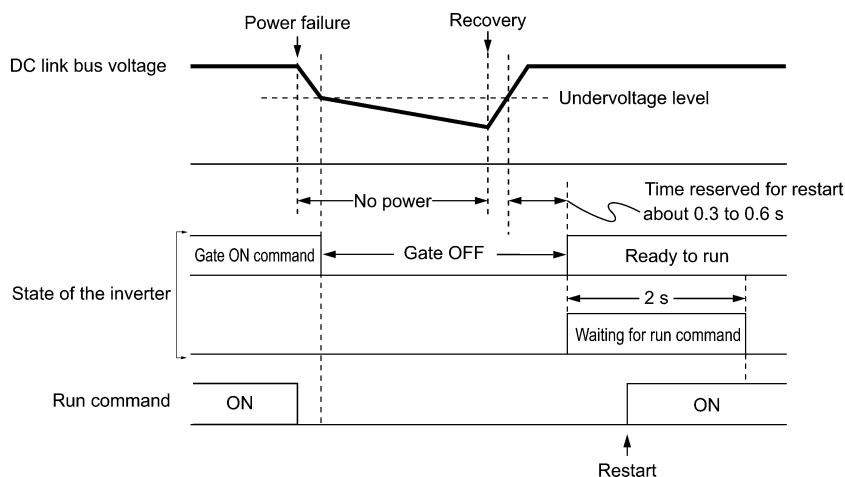

- When the power is restored, the inverter will wait 2 seconds for input of a run command. However, if the allowable momentary power failure time (H16) elapses after the power failure was recognized, even within the 2 seconds, the restart time for a run command is canceled. The inverter will start operation in the normal starting sequence.
- If the "Coast to a stop" terminal command **BX** is entered during the power failure, the inverter gets out of the restart mode and enters the normal running mode. If a run command is entered with power supply applied, the inverter will start from the normal starting frequency.
- The inverter recognizes a momentary power failure by detecting an undervoltage condition whereby the voltage of the DC link bus goes below the lower limit. In a configuration where a magnetic contactor is installed on the output side of the inverter, the inverter may fail to recognize a momentary power failure because the momentary power failure shuts down the operating power of the magnetic contactor, causing the contactor circuit to open. When the contactor circuit is open, the inverter is cut off from the motor and load, and the voltage drop in the DC link bus is not great enough to be recognized as a power failure. In such an event, restart after a recovery from momentary power failure does not work properly as designed. To solve this, connect the interlock command **IL** line to the auxiliary contact of the magnetic contactor, so that a momentary power failure can sure be detected. For details, refer to the descriptions of E01 through E07.

Function code E01 to E07, data = 22

<i>IL</i>	Description
OFF	No momentary power failure has occurred.
ON	A momentary power failure has occurred. (Restart after a momentary power failure enabled)

During a momentary power failure, the motor slows down. After power is restored, the inverter restarts at the frequency just before the momentary power failure. Then, the current limiting function works and the output frequency of the inverter automatically decreases. When the output frequency matches the motor speed, the motor accelerates up to the original output frequency. See the figure below. In this case, the instantaneous overcurrent limiting must be enabled (H12 = 1).

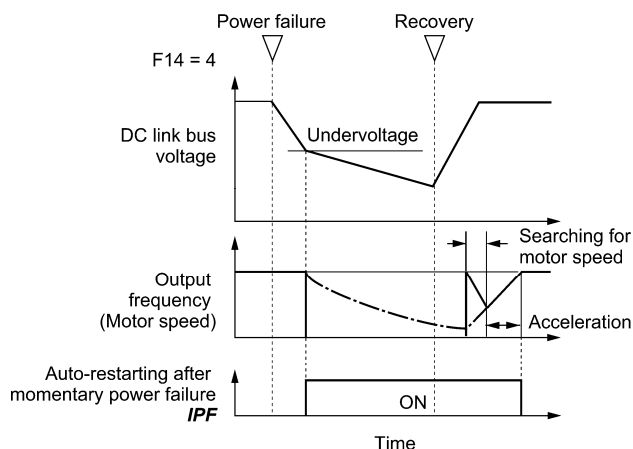

• **Auto-restarting after momentary power failure *IPF***

This output signal is ON during the period after the occurrence of momentary power failure until the completion of restart (the output has reached the reference frequency). When the *IPF* is ON, the motor slows down, so perform necessary operations. (📖 For details about *IPF*, refer to E20 through E24 and E27 (data = 6).)

■ **Restart mode after momentary power failure (Basic operation with auto search enabled)**

Auto search for idling motor speed will become unsuccessful if it is done while the motor retains residual voltage. It is, therefore, necessary to leave the motor for the time (auto search delay time) enough to discharge the residual voltage. The delay time is specified by H46 (Starting Mode (Auto search delay time 2)).

The inverter will not start unless the time specified by H46 has elapsed, even if the starting conditions are satisfied. (📖 For details, refer to H09 and d67.)

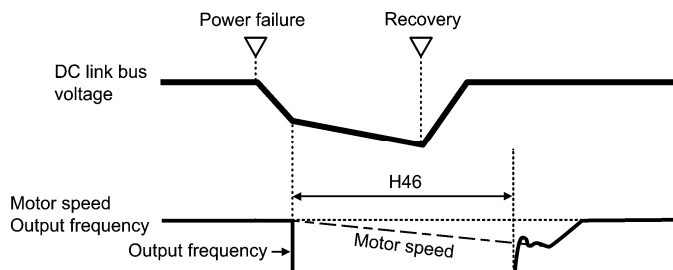

- To use auto search for idling motor speed, it is necessary to tune the inverter beforehand.
- When the estimated speed exceeds the maximum frequency or the upper limit frequency, the inverter disables auto search and starts running the motor with the maximum frequency or the upper limit frequency, whichever is lower.
- During auto search, if an overcurrent or overvoltage trip occurs, the inverter restarts the suspended auto search.
- Perform auto search at 60 Hz or below.
- Note that auto search may not fully provide the performance depending on load conditions, motor parameters, wiring length, and other external factors.
- Do not execute motor tuning with output filter unless the filter is a reactor type only. A tuning error may result if any other type filter is in use.

■ Restart mode after momentary power failure (Allowable momentary power failure time) (H16)

H16 specifies the maximum allowable duration (0.0 to 30.0 seconds) from an occurrence of a momentary power failure (undervoltage) until the inverter is to be restarted. Specify the coast-to-stop time which the machine system and facility can tolerate.

If the power is restored within the specified duration, the inverter restarts in the restart mode specified by F14. If not, the inverter recognizes that the power has been shut down so that the inverter does not apply the restart mode and starts normal running.

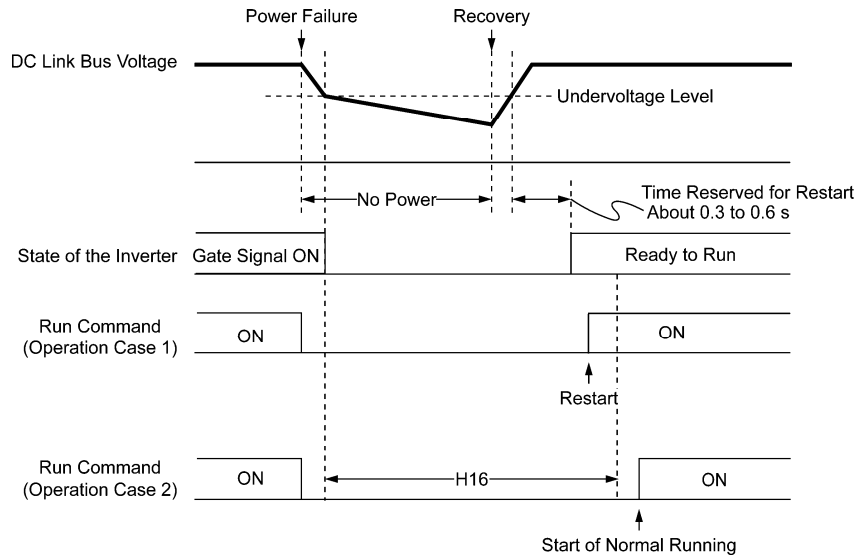

If H16 (Allowable momentary power failure time) is set to "999," restart will take place until the DC link bus voltage drops down to the allowable voltage for restart after a momentary power failure (50 V for 230 V series and 100 V for 460 V series). If the DC link bus voltage drops below the allowable voltage, the inverter recognizes that the power has been shut down so that it does not restart but starts (normal starting).

Power supply voltage	Allowable voltage for restart after momentary power failure
230 V series	50 V
460 V series	100 V

Note The time required from when the DC link bus voltage drops from the threshold of undervoltage until it reaches the allowable voltage for restart after a momentary power failure, greatly varies depending on the inverter capacity, the presence of options, and other factors.

■ Restart mode after momentary power failure (Restart time) (H13)

H13 specifies the time period from momentary power failure occurrence until the inverter reacts for restarting process.

If the inverter starts the motor while motor's residual voltage is still in a high level, a large inrush current may flow or an overvoltage alarm may occur due to an occurrence of temporary regeneration. For safety, therefore, it is advisable to set H13 to a certain level so that the restart will take place only after the residual voltage has dropped to a low level. Note that even when power is restored, restart will not take place until the restart time (H13) has elapsed.

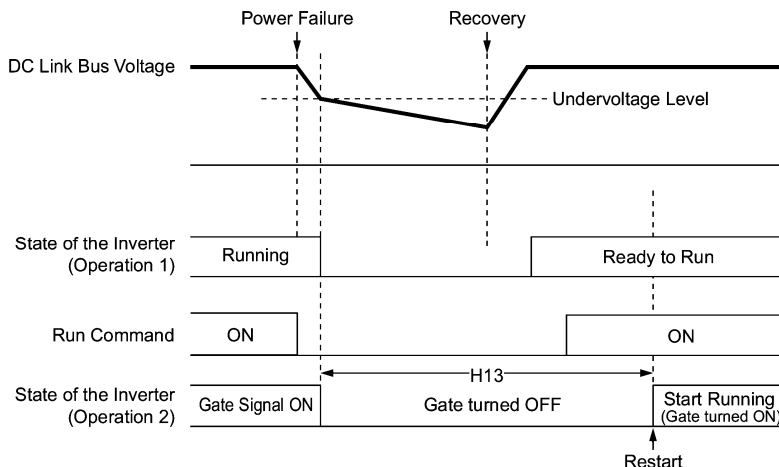

Factory default: By factory default, H13 is set to the value suitable for the standard motor (see Table A in Section 5.1 "Function Code Tables"). Basically, it is not necessary to change H13 data. However, if the long restart time causes the flow rate of the pump to overly decrease or causes any other problem, you might as well reduce the setting to about a half of the default value. In such a case, make sure that no alarm occurs.

Note Function code H13 (Restart mode after momentary power failure -- Restart time) also applies to the switching operation between line and inverter (refer to the descriptions of E01 through E07).

■ Restart mode after momentary power failure (Frequency fall rate) (H14)

During restart after a momentary power failure, if the inverter output frequency and the idling motor speed cannot be harmonized with each other, an overcurrent will flow, activating the overcurrent limiter. If it happens, the inverter automatically reduces the output frequency to match the idling motor speed according to the reduction rate (Frequency fall rate: Hz/s) specified by H14.

Data for H14	Inverter's action for the output frequency fall
0.00	Follow the deceleration time specified
0.01 to 100.00 (Hz/s)	Follow data specified by H14
999	Follow the setting of the PI controller in the current limiter. (The PI constant is prefixed inside the inverter.)

Note If the frequency fall rate is too high, regeneration may take place at the moment the motor rotation matches the inverter output frequency, causing an overvoltage trip. On the contrary, if the frequency fall rate is too low, the time required for the output frequency to match the motor speed (duration of current limiting action) may be prolonged, triggering the inverter overload prevention control.

■ Restart after momentary power failure (Continuous running level) (H15)
Continuity of running (P and I) (H92, H93)

• Trip after decelerate-to-stop

If a momentary power failure occurs when F14 is set to "2" (Trip after decelerate-to-stop), the inverter enters the control sequence of the decelerate-to-stop when the DC link bus voltage drops below the continuous running level specified by H15.

Under the decelerate-to-stop control, the inverter decelerates its output frequency keeping the DC link bus voltage constant using the PI processor. P (proportional) and I (integral) components of the PI processor are specified by H92 and H93, respectively.

For normal inverter operation, it is not necessary to modify data of H15, H92 or H93.

• Continue to run

If a momentary power failure occurs when F14 is set to "3" (Continue to run), the inverter enters the control sequence of the continuous running when the DC link bus voltage drops below the continuous running level specified by H15.

Under the continuous running control, the inverter continues to run keeping the DC link bus voltage constant using the PI processor.

P (proportional) and I (integral) components of the PI processor are specified by H92 and H93, respectively.

For normal inverter operation, it is not necessary to modify data of H15, H92 or H93.

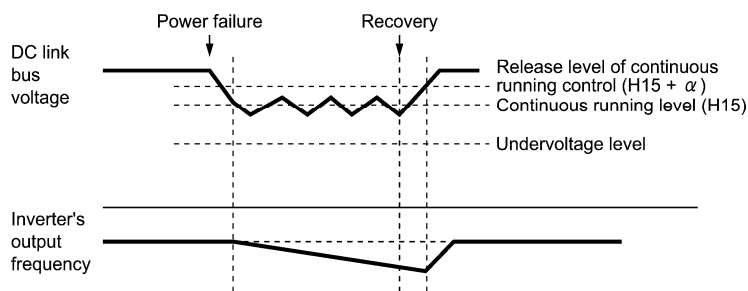

Power supply voltage	α	
	40 HP or below	50 HP or above
230 V series	5 V	10 V
460 V series	10 V	20 V

Note Even if you select "Trip after decelerate-to-stop" or "Continue to run," the inverter may not be able to do so when the load's inertia is small or the load is heavy, due to undervoltage caused by a control delay. In such a case, when "Trip after decelerate-to-stop" is selected, the inverter allows the motor to coast to a stop; when "Continue to run" is selected, the inverter saves the output frequency being applied when the undervoltage alarm occurred and restarts at the saved frequency after a recovery from the momentary power failure.

When the input power voltage for the inverter is high, setting the continuous running level high makes the control more stable even if the load's inertia is relatively small. Raising the continuous running level too high, however, might cause the continuous running control activated even during normal operation.

When the input power voltage for the inverter is extremely low, continuous running control might be activated even during normal operation, at the beginning of acceleration or at an abrupt change in load. To avoid this, lower the continuous running level. Lowering it too low, however, might cause undervoltage that results from voltage drop due to a control delay.

Before you change the continuous running level, make sure that the continuous running control will be performed properly, by considering the fluctuations of the load and the input voltage.

F15, F16 Frequency Limiter (High), Frequency Limiter (Low) H63 Low Limiter (Mode selection)

■ Frequency Limiter (High and Low) (F15, F16) Data setting range: 0.0 to 500.0 (Hz)

F15 and F16 specify the upper and lower limits of the output frequency or reference frequency, respectively. The object to which the limit is applied differs depending on the control system.

Frequency Limiter		Object to which the limit is applied	
		V/f control	Vector control without/with speed sensor
Frequency Limiter (High)	F15	Output frequency	Reference speed (reference frequency)
Frequency Limiter (Low)	F16	Reference frequency	Reference speed (reference frequency)

Note When the limit is applied to the reference frequency or reference speed, delayed responses of control may cause an overshoot or undershoot, and the frequency may temporarily go beyond the limit level.

■ Low Limiter (Mode selection) (H63)

H63 specifies the operation to be carried out when the reference frequency drops below the low level specified by F16, as follows:

Data for H63	Operation
0	The output frequency will be held at the low level specified by F16.
1	The inverter decelerates to stop the motor.

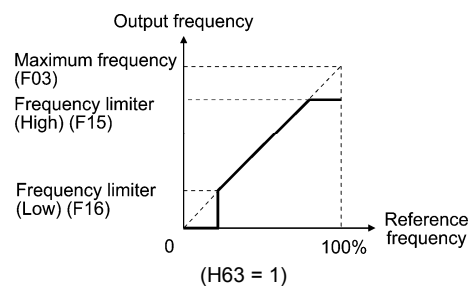
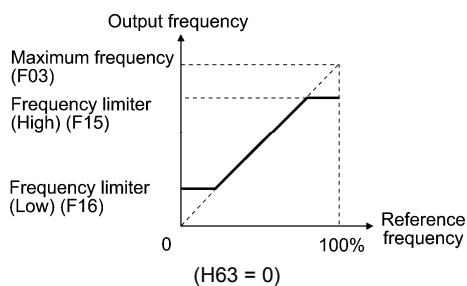

- Note**
- When you change the frequency limiter (High) (F15) in order to raise the reference frequency, be sure to change the maximum frequency (F03) accordingly.
 - Maintain the following relationship among the data for frequency control:
 $F15 > F16$, $F15 > F23$, and $F15 > F25$
 $F03 > F16$
 where, F23 and F25 specify the starting and stop frequencies, respectively.
 If you specify any wrong data for these function codes, the inverter may not run the motor at the desired speed, or cannot start it normally.

F18 Bias (Frequency command 1) (Refer to F01.)

F20 to F22 DC Braking 1 (Braking starting frequency, Braking level, and Braking time)
H95 DC Braking (Braking response mode)

F20 through F22 specify the DC braking that prevents motor 1 from running by inertia during decelerate-to-stop operation. If the motor enters a decelerate-to-stop operation by turning OFF the run command or by decreasing the reference frequency below the stop frequency, the inverter activates the DC braking by flowing a current at the braking level (F21) during the braking time (F22) when the output frequency goes down to the DC braking starting frequency (F20). Setting the braking time to "0.0" (F22 = 0) disables the DC braking.

■ **Braking starting frequency (F20)** Data setting range: 0.0 to 60.0 (Hz)
 F20 specifies the frequency at which the DC braking starts its operation during motor decelerate-to-stop state.

■ **Braking level (F21)** Data setting range: 0 to 80 (%) LD/MD-mode inverters
 0 to 100 (%) HD-mode inverters

F21 specifies the output current level to be applied when the DC braking is activated. The function code data should be set, assuming the rated output current of the inverter as 100%, in increments of 1%.

Note The inverter rated output current differs between the LD/MD and HD modes. 0% to 100% for inverters of 7.5 HP or below.

■ **Braking time (F22)** Data setting range: 0.01 to 30.00 (s), 0.00 (Disable)
 F22 specifies the braking period that activates DC braking.

■ **Braking response mode (H95)**
 H95 specifies the DC braking response mode. When vector control without/with speed sensor is selected, the response is constant.

Data for H95	Characteristics	Note
0	Slow response. Slows the rising edge of the current, thereby preventing reverse rotation at the start of DC braking.	Insufficient braking torque may result at the start of DC braking.
1	Quick response. Quickens the rising edge of the current, thereby accelerating the build-up of the braking torque.	Reverse rotation may result depending on the moment of inertia of the mechanical load and the coupling mechanism.

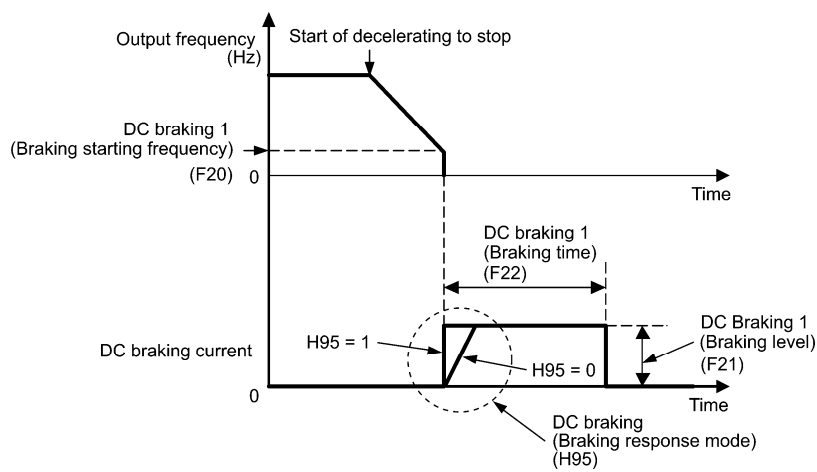

F codes



It is also possible to use an external digital input signal as an "Enable DC braking" terminal command **DCBRK**. As long as the **DCBRK** command is ON, the inverter performs DC braking, regardless of the braking time specified by F22.

(📖 Refer to E01 through E07, data =13.)

Turning the **DCBRK** command ON even when the inverter is in a stopped state activates the DC braking. This feature allows the motor to be excited before starting, resulting in smoother acceleration (quicker build-up of acceleration torque) (under V/f control).

When vector control without/with speed sensor is selected, use the pre-exciting feature for establishing the magnetic flux. (📖 For details, refer to H84.)

In general, DC braking is used to prevent the motor from running by inertia during the stopping process. Under vector control with speed sensor, however, zero speed control will be more effective for applications where load is applied to the motor even in a stopped state.

If the zero speed control continues for a long time, the motor may slightly rotate due to a control error. To fix the motor shaft, use the servo-lock function. (📖 For details, refer to J97.)



In general, specify data of function code F20 at a value close to the rated slip frequency of motor. If you set it at an extremely high value, control may become unstable and an overvoltage alarm may result in some cases.

⚠ WARNING
Even if the motor is stopped by DC braking, voltage is output to inverter output terminals U, V, and W. An electric shock may occur.

⚠ CAUTION
The DC brake function of the inverter does not provide any holding mechanism. Injuries could occur.

F23 to F25 Starting Frequency 1, Starting Frequency 1 (Holding time), Stop Frequency	F38 (Stop Frequency (Detection mode))	F39 (Stop Frequency (Holding time))
	H92 (Continuity of Running (P))	H93 (Continuity of Running (I))
	d24 (Zero Speed Control)	

Under V/f control

At the startup of an inverter, the initial output frequency is equal to the starting frequency. The inverter stops its output when the output frequency reaches the stop frequency.

Set the starting frequency to a level at which the motor can generate enough torque for startup. Generally, set the motor's rated slip frequency as the starting frequency.

Specifying the holding time for the starting frequency compensates for the delay time for the establishment of a magnetic flux in the motor; specifying that for the stop frequency stabilizes the motor speed at the stop of the inverter.

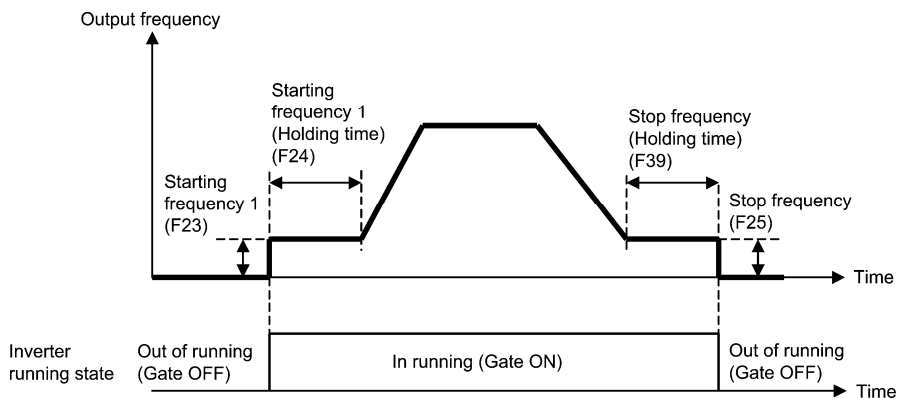

■ **Starting frequency 1 (F23)** Data setting range: 0.0 to 60.0 (Hz)

F23 specifies the starting frequency at the startup of an inverter. Under V/f control, even if the starting frequency is set at 0.0 Hz, the inverter starts at 0.1 Hz.

■ **Starting frequency 1 (Holding time) (F24)** Data setting range: 0.00 to 10.00 (s)
F24 specifies the holding time for the starting frequency 1.

■ **Stop frequency (F25)** Data setting range: 0.0 to 60.0 (Hz)
F25 specifies the stop frequency at the stop of the inverter. Under V/f control, even if the stop frequency is set at 0.0 Hz, the inverter stops at 0.1 Hz.

■ **Stop frequency (Holding time) (F39)** Data setting range: 0.00 to 10.00 (s)
F39 specifies the holding time for the stop frequency.

Note If the starting frequency is lower than the stop frequency, the inverter will not output any power as long as the reference frequency does not exceed the stop frequency.

Under vector control with/without speed sensor

At the startup, the inverter first starts at the "0" speed and accelerates to the starting frequency according to the specified acceleration time. After holding the starting frequency for the specified period, the inverter again accelerates to the reference speed according to the specified acceleration time.

The inverter stops its output when the reference speed or detected one (specified by F38) reaches the stop frequency specified by F25.

Specifying the holding time for the starting frequency compensates for the delay time for the establishment of a magnetic flux in the motor; specifying that for the stop frequency stabilizes the motor speed at the stop of the inverter.

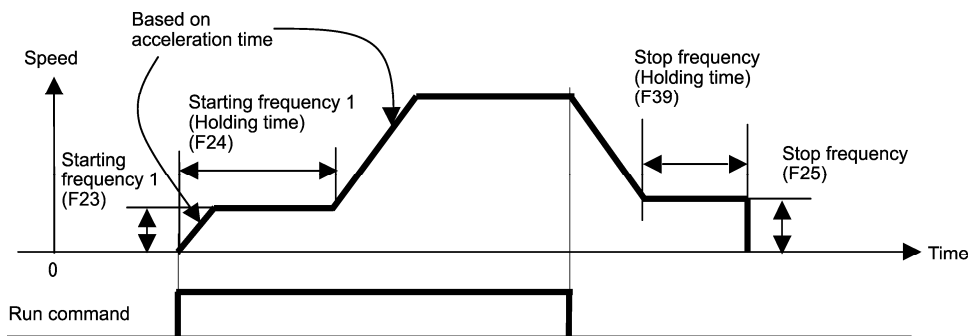

■ **Starting Frequency 1 (F23)** Data setting range: 0.0 to 60.0 (Hz)
F23 specifies the starting frequency at the startup of an inverter.

■ **Starting Frequency 1 (Holding time) (F24)** Data setting range: 0.00 to 10.00 (s)
F24 specifies the holding time for the starting frequency 1.

■ **Stop Frequency (F25)** Data setting range: 0.0 to 60.0 (Hz)
F25 specifies the stop frequency at the stop of the inverter.

■ **Stop Frequency (Holding time) (F39)** Data setting range: 0.00 to 10.00 (s)
F39 specifies the holding time for the stop frequency.

■ **Zero Speed Control (d24)**

To enable zero speed control under vector control with speed sensor, it is necessary to set the speed command (frequency command) at below the starting and stop frequencies. If the starting and stop frequencies are 0.0 Hz, however, the zero speed control is enabled only when the speed command is 0.00 Hz. d24 specifies the operation for the zero speed control at the startup of the inverter.

Data for d24	Zero speed control	Descriptions
0	Not allowed at startup	Even setting the speed command at below the starting and stop frequencies and turning a run command ON does not enable the zero speed control. To enable the zero speed control, set the speed command at above the starting frequency and then start up the inverter again.
1	Allowed at startup	Setting the speed command at below the starting and stop frequencies and turning a run command ON enables the zero speed control.

The table below shows the conditions for zero speed control to be enabled or disabled.

	Speed command	Run command	Data for d24	Operation
At startup	Below the starting and stop frequencies	OFF	—	Stop (Gate OFF)
		ON	0	Stop (Gate OFF)
			1	Zero speed control
At stop	Below the stop frequency	ON	—	Zero speed control
		OFF	—	Stop (Gate OFF)

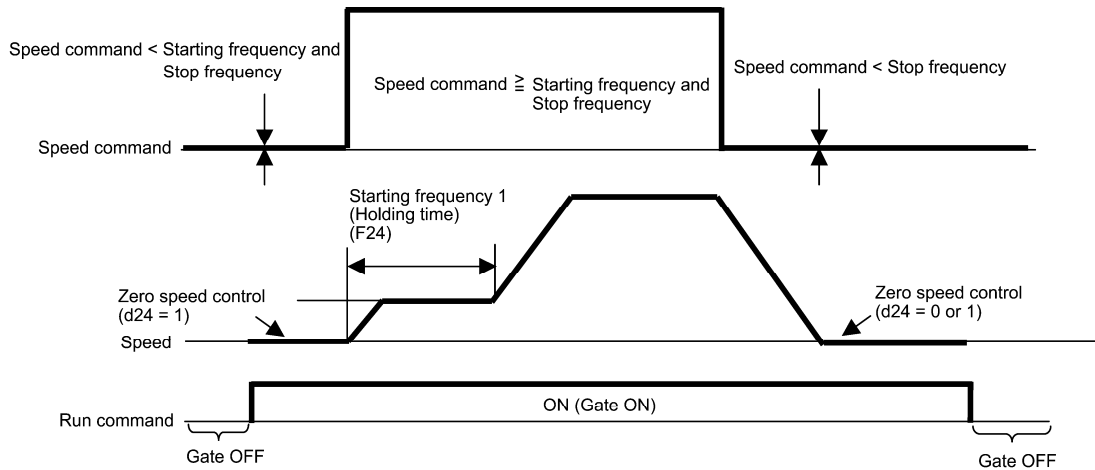

■ Stop Frequency (Detection mode) (F38) (Under vector control with speed sensor)

F38 specifies whether to use the detected speed or reference one as a decision criterion to shut down the inverter output. Usually the inverter uses the detected speed. However, if the inverter undergoes a load exceeding its capability, e.g., an external excessive load, it cannot stop because the motor cannot stop so that the detected speed may not reach the stop frequency level. When such a situation could arise, select the reference speed that can reach the stop frequency level even if the detected speed does not, in order to stop the inverter without fail for general fail-safe operation.

- Data setting range: 0 (Detected speed)
- 1 (Reference speed)

■ Motor Sound (Carrier frequency) (F26)

F26 controls the carrier frequency so as to reduce an audible noise generated by the motor or electromagnetic noise from the inverter itself, and to decrease a leakage current from the main output (secondary) wirings.

Item	Characteristics	Remarks
Carrier frequency	0.75 to 16 kHz	0.5 to 30 HP (LD mode) 0.5 to 100 HP (HD mode)
	0.75 to 10 kHz	40 to 100 HP (LD mode) 125 to 800 HP (HD mode)
	0.75 to 6 kHz	125 to 900 HP (LD mode) 900 and 1000 HP (HD mode)
	0.75 to 4 kHz	1000 HP (LD mode)
	0.75 to 2 kHz	150 to 800 HP (MD mode)
Motor sound noise emission	High ↔ Low	
Motor temperature (due to harmonics components)	High ↔ Low	
Ripples in output current waveform	Large ↔ Small	
Leakage current	Low ↔ High	
Electromagnetic noise emission	Low ↔ High	
Inverter loss	Low ↔ High	

Note Specifying a too low carrier frequency will cause the output current waveform to have a large amount of ripples. As a result, the motor loss increases, causing the motor temperature to rise. Furthermore, the large amount of ripples tends to cause a current limiting alarm. When the carrier frequency is set to 1 kHz or below, therefore, reduce the load so that the inverter output current comes to be 80% or less of the rated current.

When a high carrier frequency is specified, the temperature of the inverter may rise due to a surrounding temperature rise or an increase of the load. If it happens, the inverter automatically decreases the carrier frequency to prevent the inverter overload alarm \overline{LL} . With consideration for motor noise, the automatic reduction of carrier frequency can be disabled. Refer to the description of H98.

It is recommended to set the carrier frequency at 5 kHz or above under vector control without/with speed sensor. DO NOT set it at 1 kHz or below.

■ Motor Sound (Tone) (F27)

F27 changes the motor running sound tone (only for motors under V/f control). This setting is effective when the carrier frequency specified by function code F26 is 7 kHz or lower. Changing the tone level may reduce the high and harsh running noise from the motor.

Note If the tone level is set too high, the output current may become unstable, or mechanical vibration and noise may increase.

Also, this function code may not be very effective for certain types of motor.

Data for F27	Function
0	Disable (Tone level 0)
1	Enable (Tone level 1)
2	Enable (Tone level 2)
3	Enable (Tone level 3)

F29 to F31 Analog Output [FM1] and [FM2] (Mode selection, Voltage adjustment, Function)
F32, F34,
F35

These function codes allow terminals [FM1] and [FM2] to output monitored data such as the output frequency and the output current in an analog DC voltage or current. The magnitude of such analog voltage or current is adjustable.

■ **Mode selection (F29 and F32)**

F29 and F32 specify the property of the output to terminals [FM1] and [FM2], respectively. You need to set the slide switches on the control printed circuit board (control PCB). Refer to Chapter 2 "Mounting and Wiring of the Inverter."

Output form	Terminal [FM1]		Terminal [FM2]	
	Data for F29	Position of slide switch SW4 on the control PCB	Data for F32	Position of slide switch SW6 on the control PCB
Voltage (0 to +10 VDC)	0	VO1	0	VO2
Current (4 to +20 mA DC)	1	IO1	1	IO2

Note The output current is not isolated from analog input, and does not have an isolated power supply. Therefore, if an electrical potential relationship between the inverter and peripheral equipment has been established, e.g., by connecting an analog, cascade connection of a current output device is not available.

Keep the connection wire length as short as possible.

■ **Voltage adjustment (F30 and F34)**

F30 allows you to adjust the output voltage within the range of 0 to 300%.

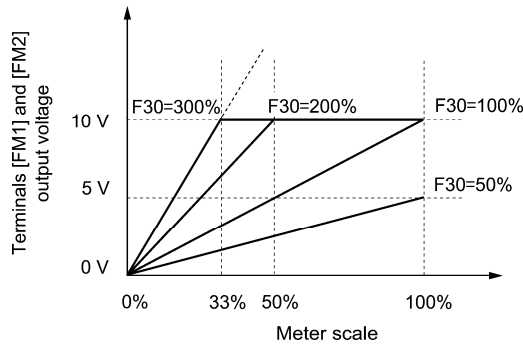

■ **Function (F31 and F35)**

F31 and F35 specify what is output to analog output terminals [FM1] and [FM2], respectively.

Data for F31/F35	[FM1]/[FM2] output	Function (Monitor the following)	Meter scale (Full scale at 100%)
0	Output frequency 1 (before slip compensation)	Output frequency of the inverter (Equivalent to the motor synchronous speed)	Maximum frequency (F03)
1	Output frequency 2 (after slip compensation)	Output frequency of the inverter	Maximum frequency (F03)
2	Output current	Output current (RMS) of the inverter	Twice the inverter rated current
3	Output voltage	Output voltage (RMS) of the inverter	250 V for 230 V series, 500 V for 460 V series
4	Output torque	Motor shaft torque	Twice the rated motor torque
5	Load factor	Load factor (Equivalent to the indication of the load meter)	Twice the rated motor load
6	Input power	Input power of the inverter	Twice the rated output of the inverter
7	PID feedback amount (PV)	Feedback amount under PID control	100% of the feedback amount
8	PG feedback value (speed)	Speed detected through the PG interface, or estimated speed under vector control without speed sensor	Maximum speed as 100%
9	DC link bus voltage	DC link bus voltage of the inverter	500 V for 230 V series, 1000 V for 460 V series

Data for F31/F35	[FM1]/[FM2] output	Function (Monitor the following)	Meter scale (Full scale at 100%)
10	Universal AO	Command via communications link (Refer to the RS-485 Communication User's Manual.)	20000 as 100%
13	Motor output	Motor output (kW)	Twice the rated motor output
14	Calibration (+)	Full scale output of the meter calibration	This always outputs the full-scale (100%).
15	PID command (SV)	Command value under PID control	100% of the feedback amount
16	PID output (MV)	Output level of the PID controller under PID control (Frequency command)	Maximum frequency (F03)
17	Positional deviation in synchronous running	Deviation in angle	0% to 50% to 100%, representing -180° to 0° to +180° of the deviation

Note If F31/F35 = 16 (PID output), J01 = 3 (Dancer control), and J62 = 2 or 3 (Ratio compensation enabled), the PID output is equivalent to the ratio against the primary reference frequency and may vary within $\pm 300\%$ of the frequency. The monitor displays the PID output in a converted absolute value. To indicate the value up to the full-scale of 300%, set F30/F34 data to "33" (%).

F37 Load Selection/ Auto Torque Boost/ Auto Energy Saving Operation 1

F09 (Torque Boost 1)

H67 (Auto Energy Saving Operation (Mode selection))

F37 specifies V/f pattern, torque boost type, and auto energy saving operation in accordance with the characteristics of the load.

Specify the torque boost level with F09 in order to assure sufficient starting torque.

Data for F37	V/f pattern	Torque boost	Auto energy saving	Applicable load
0	Variable torque V/f pattern	Torque boost specified by F09	Disable	Variable torque load (General-purpose fans and pumps)
1	Linear V/f pattern			Constant torque load
2		Auto torque boost	Constant torque load (To be selected if a motor may be over-excited at no load.)	
3	Variable torque V/f pattern	Torque boost specified by F09	Enable	Variable torque load (General-purpose fans and pumps)
4	Linear V/f pattern			Constant torque load
5		Auto torque boost	Constant torque load (To be selected if a motor may be over-excited at no load.)	

Note If a required "load torque + acceleration torque" is more than 50% of the constant torque, it is recommended to select the linear V/f pattern (factory default).

Tip Under the vector control with speed sensor, F37 is used to specify whether the auto energy saving operation is enabled or disabled. (V/f pattern and torque boost are disabled.)

Data for F37	Operation
0 to 2	Auto energy saving operation OFF
3 to 5	Auto energy saving operation ON

Under the vector control without speed sensor, both F37 and F09 are disabled. The auto energy saving operation is also disabled.

F codes

■ V/f characteristics

The FRENIC-MEGA series of inverters offers a variety of V/f patterns and torque boosts, which include V/f patterns suitable for variable torque load such as general fans and pumps and for constant torque load (including special pumps requiring high starting torque). Two types of torque boosts are available: manual and automatic.

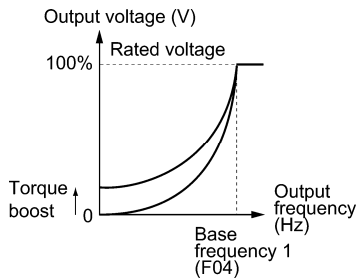

Variable torque V/f pattern (F37 = 0)

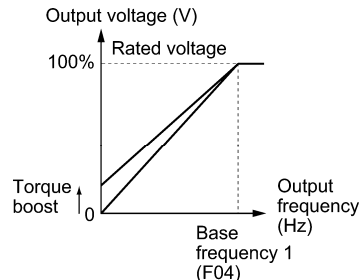

Linear V/f pattern (F37 = 1)



When the variable torque V/f pattern is selected (F37 = 0 or 3), the output voltage may be low at a low frequency zone, resulting in insufficient output torque, depending on the characteristics of the motor and load. In such a case, it is recommended to increase the output voltage at the low frequency zone using the non-linear V/f pattern.

Recommended value: H50 = 1/10 of the base frequency
H51 = 1/10 of the voltage at base frequency

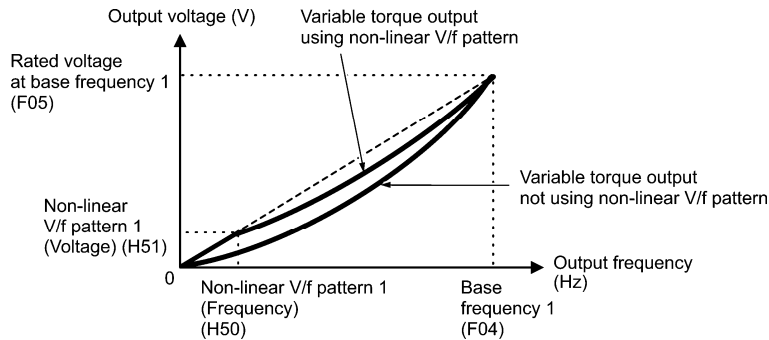

■ Torque boost Data setting range: 0.0 to 20.0 (%) (100%/Rated voltage at base frequency)

• Manual torque boost (F09)

In torque boost using F09, constant voltage is added to the basic V/f pattern, regardless of the load. To secure a sufficient starting torque, manually adjust the output voltage to optimally match the motor and its load by using F09. Specify an appropriate level that guarantees smooth start-up and yet does not cause over-excitation at no or light load.

Torque boost per F09 ensures high driving stability since the output voltage remains constant regardless of the load fluctuation.

Specify the F09 data in percentage to the rated voltage at base frequency 1 (F05).



- Specifying a high torque boost level will generate a high torque, but may cause overcurrent due to over-excitation at no load. If you continue to drive the motor, it may overheat. To avoid such a situation, adjust torque boost to an appropriate level.
- When the non-linear V/f pattern and the torque boost are used together, the torque boost takes effect below the frequency on the non-linear V/f pattern's point.

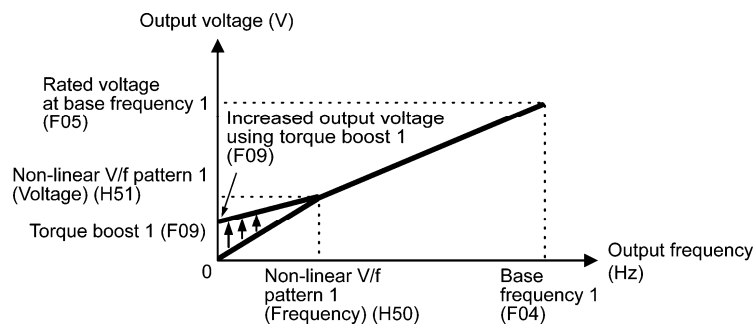

• **Auto torque boost**

If the auto torque boost is selected, the inverter automatically optimizes the output voltage to fit the motor with its load. Under light load, the inverter decreases the output voltage to prevent the motor from over-excitation. Under heavy load, it increases the output voltage to increase the output torque of the motor.

- Note**
- Since this function relies also on the characteristics of the motor, set the base frequency 1 (F04), the rated voltage at base frequency 1 (F05), and other pertinent motor parameters (P01 through P03 and P06 through P99) in line with the motor capacity and characteristics, or else perform auto-tuning (P04).
 - When a special motor is driven or the load does not have sufficient rigidity, the maximum torque might decrease or the motor operation might become unstable. In such cases, do not use auto torque boost but choose manual torque boost per F09 (F37 = 0 or 1).

■ **Auto energy saving operation (H67)**

If the auto energy saving operation is enabled, the inverter automatically controls the supply voltage to the motor to minimize the total power loss of motor and inverter. (Note that this feature may not be effective depending upon the motor or load characteristics. Check the advantage of energy saving before you actually apply this feature to your machinery.)

You can select whether applying this feature to constant speed operation only or applying to constant speed operation and accelerating/decelerating operation.

Data for H67	Auto energy saving operation
0	Enable only during running at constant speed
1	Enable during running at constant speed or accelerating/decelerating (Note: For accelerating/decelerating, enable only when the load is light.)

If auto energy saving operation is enabled, the response to a motor speed change from constant speed operation may be slow. Do not use this feature for such machinery that requires quick acceleration/deceleration.

- Note**
- Use auto energy saving only where the base frequency is 60 Hz or lower. If the base frequency is set at 60 Hz or higher, you may get a little or no energy saving advantage. The auto energy saving operation is designed for use with the frequency lower than the base frequency. If the frequency becomes higher than the base frequency, the auto energy saving operation will be invalid.
 - Since this function relies also on the characteristics of the motor, set the base frequency 1 (F04), the rated voltage at base frequency 1 (F05), and other pertinent motor parameters (P01 through P03 and P06 through P99) in line with the motor capacity and characteristics, or else perform auto-tuning (P04).
 - Under the vector control without speed sensor, the auto energy saving operation is disabled.

F38, F39	Stop frequency (Detection mode, Holding time)	(Refer to F23.)
F40, F41	Torque Limiter 1-1, Torque Limiter 1-2	E16, E17 Torque Limiter 2-1, Torque Limiter 2-2 H73 Torque Limiter (Operating conditions) H76 Torque Limiter (Frequency increment limit for braking)

Under V/f control

If the inverter's output torque exceeds the specified levels of the torque limiters (F40, F41, E16, E17, and E61 to E63), the inverter controls the output frequency and limits the output torque for preventing a stall.

To use the torque limiters, it is necessary to configure the function codes listed in the table below.

- Note**
- In braking, the inverter increases the output frequency to limit the output torque. Depending on the conditions during operation, the output frequency could dangerously increase. H76 (Frequency increment limit for braking) is provided to limit the increasing frequency component.

Related function codes

Function code	Name	V/f control	Vector control	Remarks
F40	Torque Limiter 1-1	Y	Y	
F41	Torque Limiter 1-2	Y	Y	
E16	Torque Limiter 2-1	Y	Y	
E17	Torque Limiter 2-2	Y	Y	
H73	Torque Limiter (Operating conditions)	Y	Y	
H74	Torque Limiter (Control target)	N	Y	
H75	Torque Limiter (Target quadrants)	N	Y	
H76	Torque Limiter (Frequency increment limit for braking)	Y	N	
E61 to E63	Terminal [12] Extended Function Terminal [C1] Extended Function Terminal [V2] Extended Function	Y	Y	7: Analog torque limit value A 8: Analog torque limit value B

■ Torque limit control mode

Torque limit is performed by limiting torque current flowing across the motor.

The graph below shows the relationship between the torque and the output frequency at the constant torque current limit.

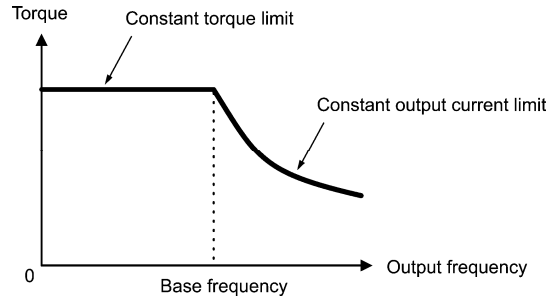

■ Torque limiters 1-1, 1-2, 2-1 and 2-2 (F40, F41, E16 and E17)

Data setting range: -300 to 300 (%), 999 (Disable)

These function codes specify the operation level at which the torque limiters become activated, as the percentage of the motor rated torque.

Function code	Name	Torque limit feature
F40	Torque limiter 1-1	Driving torque current limiter 1
F41	Torque limiter 1-2	Braking torque current limiter 1
E16	Torque limiter 2-1	Driving torque current limiter 2
E17	Torque limiter 2-2	Braking torque current limiter 2



Although the data setting range for F40, F41, E16, and E17 is from positive to negative values (-300% to +300%), specify positive values in practice. Specifying a negative value causes the inverter to interpret it as an absolute value.

The torque limiter determined depending on the overload current actually limits the torque current output. Therefore, the torque current output is automatically limited at a value lower than 300%, the maximum setting value.

■ Analog torque limit values (E61 to E63)

The torque limit values can be specified by analog inputs through terminals [12], [C1], and [V2] (voltage or current). Set E61, E62, and E63 (Terminal [12] Extended Function, Terminal [C1] Extended Function, and Terminal [V2] Extended Function) as listed below.

Data for E61, E62, or E63	Function	Description
7	Analog torque limit value A	Use the analog input as the torque limit value specified by function code data (= 7 or 8). Input specifications: 200% / 10 V or 20 mA
8	Analog torque limit value B	

If the same setting is made for different terminals, the priority order is E61>E62>E63.

■ Torque limiter levels specified via communications link (S10, S11)

The torque limiter levels can be changed via the communications link. Function codes S10 and S11 exclusively reserved for the communications link respond to function codes F40 and F41.

■ Switching torque limiters

The torque limiters can be switched by the function code setting and the terminal command **TL2/TL1** ("Select torque limiter level 2/1") assigned to any of the digital input terminals.

To assign the **TL2/TL1** as the terminal function, set any of E01 through E07 to "14." If no **TL2/TL1** is assigned, torque limiter levels 1-1 and 1-2 (F40 and F41) take effect by default.

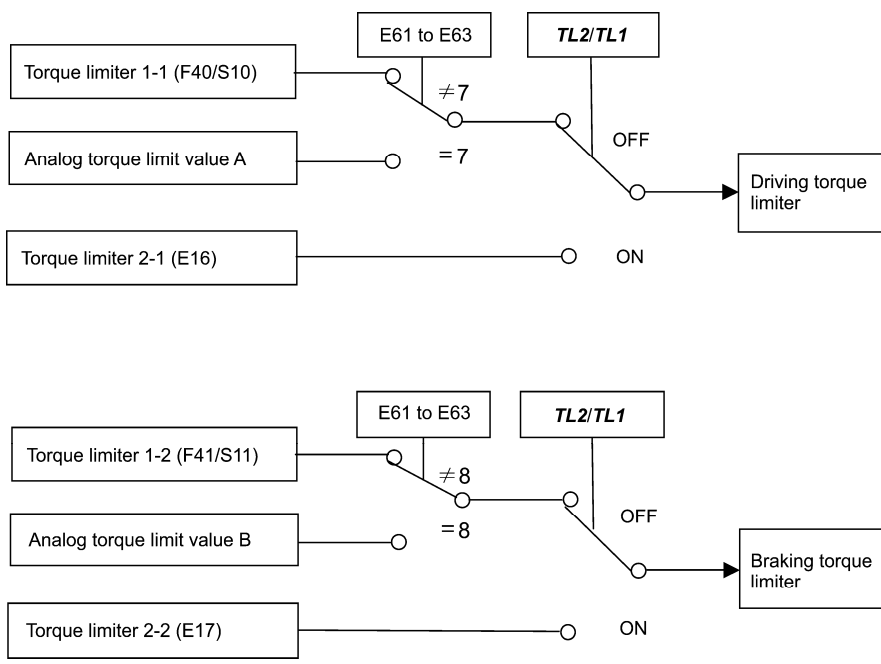

■ Torque limiter (Operating conditions) (H73)

H73 specifies whether the torque limiter is enabled or disabled during acceleration/deceleration and running at constant speed.

Data for H73	During accelerating/decelerating	During running at constant speed
0	Enable	Enable
1	Disable	Enable
2	Enable	Disable

F codes

■ Torque limiter (Frequency increment limit for braking) (H76) Data setting range: 0.0 to 500.0 (Hz)

H76 specifies the increment limit of the frequency in limiting torque for braking. The factory default is 5.0 Hz. If the increasing frequency during braking reaches the limit value, the torque limiters no longer function, resulting in an overvoltage trip. Such a problem may be avoided by increasing the setting value of H76.

Note The torque limiter and current limiter are very similar in function. If both are activated concurrently, they may conflict with each other and cause hunting (undesirable oscillation of the system). Avoid concurrent activation of these limiters.

Under vector control without/with speed sensor

If the inverter's output torque exceeds the specified levels of the torque limiters (F40, F41, E16, E17, and E61 to E63), the inverter controls the speed regulator's output (torque command) in speed control or a torque command in torque control in order to limit the motor-generating torque.

To use the torque limiters, it is necessary to configure the function codes listed in the table below.

Related function codes

Function code	Name	V/f control	Vector control	Remarks
F40	Torque Limiter 1-1	Y	Y	
F41	Torque Limiter 1-2	Y	Y	
E16	Torque Limiter 2-1	Y	Y	
E17	Torque Limiter 2-2	Y	Y	
H73	Torque Limiter (Operating conditions)	Y	Y	
H74	Torque Limiter (Control target)	N	Y	
H75	Torque Limiter (Target quadrants)	N	Y	
H76	Torque Limiter (Frequency increment limit for braking)	Y	N	
E61 to E63	Terminal [12] Extended Function Terminal [C1] Extended Function Terminal [V2] Extended Function	Y	Y	7: Analog torque limit value A 8: Analog torque limit value B

■ Torque Limiter (Control target) (H74)

Under vector control, the inverter can limit motor-generating torque or output power, as well as a torque current (default).

Data for H74	Control target
0	Motor-generating torque limit
1	Torque current limit
2	Output power limit

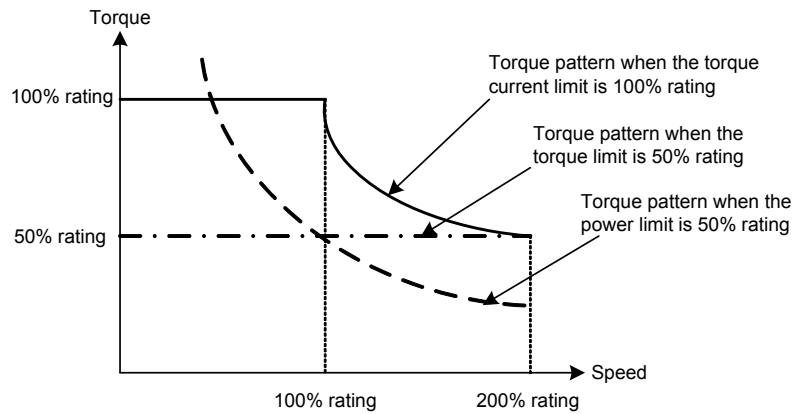

■ Torque Limiter (Target quadrants) (H75)

H75 selects the configuration of target quadrants (Drive/brake, Forward/reverse rotation) in which the specified torque limiter(s) is activated, from "Drive/brake torque limit," "Same torque limit for all four quadrants," and "Upper/lower torque limits" shown in the table below.

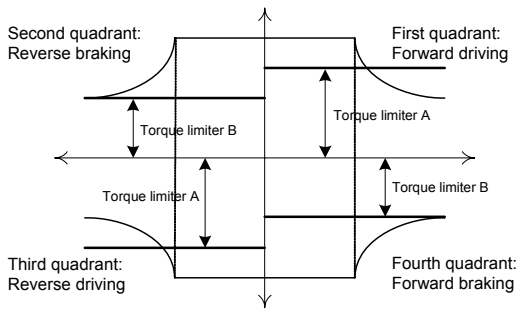
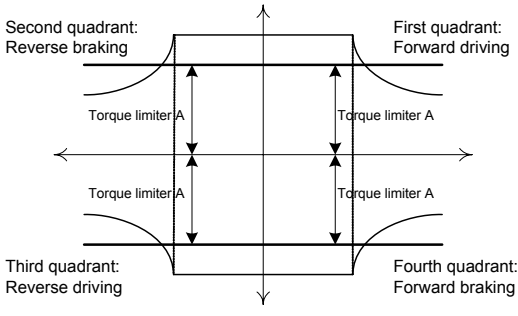
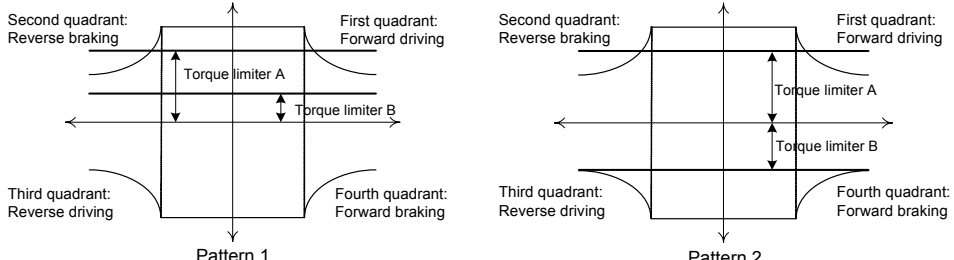
Data for H75	Target quadrants												
0: Drive/brake	<p>Torque limiter A applies to driving (both of forward and reverse), and torque limiter B to braking (both of forward and reverse).</p> 												
1: Same for all four quadrants	<p>Torque limiter A applies to all four quadrants; that is, the same torque limit applies to both driving and braking in the forward and reverse rotations.</p> 												
2: Upper/lower limits	<p>Torque limiter A applies to the upper limit, and torque limiter B to the lower limit. Depending upon the polarity of torque limiters A and B, the following patterns are available.</p> <table border="1" data-bbox="430 1294 1013 1406"> <thead> <tr> <th></th> <th>Torque limiter A</th> <th>Torque limiter B</th> </tr> </thead> <tbody> <tr> <td>Pattern 1</td> <td>Positive</td> <td>Positive</td> </tr> <tr> <td>Pattern 2</td> <td>Positive</td> <td>Negative</td> </tr> <tr> <td>Pattern 3</td> <td>Negative</td> <td>Negative</td> </tr> </tbody> </table> 		Torque limiter A	Torque limiter B	Pattern 1	Positive	Positive	Pattern 2	Positive	Negative	Pattern 3	Negative	Negative
	Torque limiter A	Torque limiter B											
Pattern 1	Positive	Positive											
Pattern 2	Positive	Negative											
Pattern 3	Negative	Negative											

Data for H75	Target quadrants
	<p>Second quadrant: Reverse braking</p> <p>First quadrant: Forward driving</p> <p>Torque limiter A</p> <p>Torque limiter B</p> <p>Third quadrant: Reverse driving</p> <p>Fourth quadrant: Forward braking</p> <p>Pattern 3</p> <p>Note</p> <ul style="list-style-type: none"> • If the value of torque limiter A is less than that of torque limiter B, torque limiter A applies to both the upper and lower limits. • Selecting the "Upper/lower torque limits" may cause reciprocating oscillation between the upper and lower limit values, depending upon a small difference between the upper and lower limits, a slow response from the speed control sequence, and other conditions.

■ Torque limiters 1-1, 1-2, 2-1 and 2-2 (F40, F41, E16 and E17)

Data setting range: -300 to 300 (%), 999 (Disable)

These function codes specify the operation level at which the torque limiters become activated, as the percentage of the motor rated torque.

Function code	Name
F40	Torque limiter 1-1
F41	Torque limiter 1-2
E16	Torque limiter 2-1
E17	Torque limiter 2-2

Note Although the data setting range for F40, F41, E16, and E17 is from positive to negative values (-300% to +300%), specify positive values in practice except when the "Upper/lower torque limits" (H75 = 2) is selected. Specifying a negative value causes the inverter to interpret it as an absolute value.

The torque limiter determined depending on the overload current actually limits the torque current output. Therefore, the torque current output is automatically limited at a value lower than 300%, the maximum setting value.

■ Analog torque limit values (E61 to E63)

The torque limit values can be specified by analog inputs through terminals [12], [C1], and [V2] (voltage or current). Set E61, E62, and E63 (Terminal [12] Extended Function, Terminal [C1] Extended Function, and Terminal [V2] Extended Function) as listed below.

Data for E61, E62, or E63	Function	Description
7	Analog torque limit value A	Use the analog input as the torque limit value specified by function code data (= 7 or 8). Input specifications: 200% / 10 V or 20 mA
8	Analog torque limit value B	

If the same setting is made for different terminals, the priority order is E61>E62>E63.

■ Torque limiter levels specified via communications link (S10, S11)

The torque limiter levels can be changed via the communications link. Function codes S10 and S11 exclusively reserved for the communications link respond to function codes F40 and F41.

■ Switching torque limiters

The torque limiters can be switched by the function code setting and the terminal command **TL2/TL1** ("Select torque limiter level 2/1") assigned to any of the digital input terminals.

To assign the **TL2/TL1** as the terminal function, set any of E01 through E07 to "14." If no **TL2/TL1** is assigned, torque limiter levels 1-1 and 1-2 (F40 and F41) take effect by default.

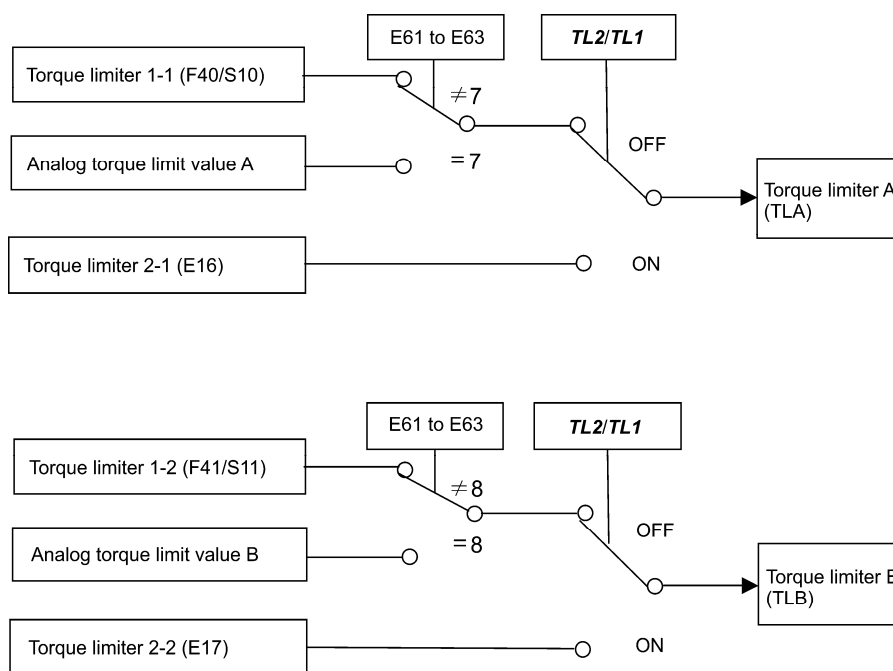

■ Torque limiter (Operating conditions) (H73)

H73 specifies whether the torque limiter is enabled or disabled during acceleration/deceleration and running at constant speed.

Data for H73	During accelerating/decelerating	During running at constant speed
0	Enable	Enable
1	Disable	Enable
2	Enable	Disable

Note The torque limiter and current limiter are very similar in function. If both are activated concurrently, they may conflict with each other and cause hunting (undesirable oscillation of the system). Avoid concurrent activation of these limiters.

F42 specifies the motor drive control.

Data for F42	Drive control	Basic control	Speed feedback	Speed control
0	V/f control with slip compensation inactive	V/f control	Disable	Frequency control
1	Dynamic torque vector control (with slip compensation and auto torque boost)			Frequency control with slip compensation
2	V/f control with slip compensation active		Enable	Frequency control with automatic speed regulator (ASR)
3	V/f control with speed sensor			Speed control with automatic speed regulator (ASR)
4	Dynamic torque vector control with speed sensor	Vector control	Estimated speed	Speed control with automatic speed regulator (ASR)
5	Vector control without speed sensor			
6	Vector control with speed sensor		Enable	

■ V/f control with slip compensation inactive

Under this control, the inverter controls a motor with the voltage and frequency according to the V/f pattern specified by function codes. This control disables all automatically controlled features such as the slip compensation, so no unpredictable output fluctuation occurs, enabling stable operation with constant output frequency.

■ V/f control with slip compensation active

Applying any load to an induction motor causes a rotational slip due to the motor characteristics, decreasing the motor rotation. The inverter’s slip compensation function first presumes the slip value of the motor based on the motor torque generated and raises the output frequency to compensate for the decrease in motor rotation. This prevents the motor from decreasing the rotation due to the slip.

That is, this function is effective for improving the motor speed control accuracy.

Function code	Operation
P12	Rated slip frequency Specify the rated slip frequency.
P09	Slip compensation gain for driving Adjust the slip compensation amount for driving. Slip compensation amount for driving = Rated slip x Slip compensation gain for driving
P11	Slip compensation gain for braking Adjust the slip compensation amount for braking. Slip compensation amount for braking = Rated slip x Slip compensation gain for braking
P10	Slip compensation response time Specify the slip compensation response time. Basically, there is no need to modify the default setting.

To improve the accuracy of slip compensation, perform auto-tuning.

H68 enables or disables the slip compensation function according to the motor driving conditions.

Data for H68	Motor driving conditions		Motor driving frequency zone	
	Accel/Decel	Constant speed	Base frequency or below	Above the base frequency
0	Enable	Enable	Enable	Enable
1	Disable	Enable	Enable	Enable
2	Enable	Enable	Enable	Disable
3	Disable	Enable	Enable	Disable

■ Dynamic torque vector control

To get the maximal torque out of a motor, this control calculates the motor torque matched to the load applied and uses it to optimize the voltage and current vector output.

Selecting this control automatically enables the auto torque boost and slip compensation function so that it is effective for improving the system response to external disturbances such as load fluctuation, and the motor speed control accuracy.

Note that the inverter may not respond to a rapid load fluctuation since this control is an open-loop V/f control that does not perform current control, unlike vector control. Other advantage of this control is that the maximum torque per output current is larger than that of vector control.

■ V/f control with speed sensor

Applying any load to an induction motor causes a rotational slip due to the motor characteristics, decreasing the motor rotation. Under V/f control with speed sensor, the inverter detects the motor rotation using the encoder mounted on the motor shaft and compensates for the decrease in slip frequency by the PI control to match the motor rotation with the reference speed. This improves the motor speed control accuracy.

■ Dynamic torque vector control with speed sensor

The difference from "V/f control with speed sensor" stated above is to calculate the motor torque matched to the load applied and use it to optimize the voltage and current vector output for getting the maximal torque out of a motor.

This control is effective for improving the system response to external disturbances such as load fluctuations, and the motor speed control accuracy.

■ Vector control without speed sensor

This control estimates the motor speed based on the inverter's output voltage and current to use the estimated speed for speed control. It also decomposes the motor drive current into the exciting and torque current components, and controls each of those components in vector. No PG (pulse generator) interface card is required. It is possible to obtain the desired response by adjusting the control constants (PI constants) using the speed regulator (PI controller).

The control regulating the motor current requires some voltage margin between the voltage that the inverter can output and the induced voltage of the motor. Usually a general-purpose motor is so designed that the voltage matches the commercial power. Under the control, therefore, it is necessary to suppress the motor terminal voltage to the lower level in order to secure the voltage margin required.

However, driving the motor with the motor terminal voltage suppressed to the lower level cannot generate the rated torque even if the rated current originally specified for the motor is applied. To ensure the rated torque, it is necessary to increase the rated current. (This also applies to vector control with speed sensor.)

This control is not available in MD-mode inverters, so do not set F42 data to "5" for those inverters.

■ Vector control with speed sensor

This control requires an optional PG (pulse generator) and an optional PG interface card to be mounted on a motor shaft and an inverter, respectively. The inverter detects the motor's rotational position and speed according to PG feedback signals and uses them for speed control. It also decomposes the motor drive current into the exciting and torque current components, and controls each of components in vector.

It is possible to obtain the desired response by adjusting the control constants (PI constants) using the speed regulator (PI controller).

The control enables speed control with higher accuracy and quicker response than vector control without speed sensor.

Note Since slip compensation, dynamic torque vector control, and vector control with/without speed sensor use motor parameters, the following conditions should be satisfied to obtain full control performance.

- A single motor should be controlled per inverter.
- Motor parameters P02, P03, P06 to P23, P55 and P56 are properly configured. Or, auto-tuning (P04) is performed.
- Under dynamic torque vector control, the capacity of the motor to be controlled is two or more ranks lower than that of the inverter; under vector control with/without speed sensor, it is the same as that of the inverter. Otherwise, the inverter may not control the motor due to decrease of the current detection resolution.
- The wiring distance between the inverter and motor is 164 ft (50 m) or less. If it is longer, the inverter may not control the motor due to leakage current flowing through stray capacitance to the ground or between wires. Especially, small capacity inverters whose rated current is also small may be unable to control the motor correctly even when the wiring is less than 164 ft (50 m). In that case, make the wiring length as short as possible or use a wire with small stray capacitance (e.g., loosely-bundled cable) to minimize the stray capacitance.

When the output current of the inverter exceeds the level specified by the current limiter (F44), the inverter automatically manages its output frequency to prevent a stall and limits the output current. The default setting of the current limiter is 130%, 145% and 160% for LD-, MD- and HD-mode inverters, respectively. (Once the LD, MD, or HD mode is selected by F80, the current limit for each mode is automatically specified.)

Note that for LD- and HD-mode inverters of 7.5 HP or below, the current limiter is initialized to 160% with F80.

If overload current, 160% (145% or 130%) or more of the current limit level, flows instantaneously so that an output frequency decrease problem arises due to the current limiter, consider increasing the current limit level.

The current limiter mode should be also selected with F43. If F43 = 1, the current limiter is enabled only during constant speed operation. If F43 = 2, it is enabled during both of acceleration and constant speed operation. Choose F43 = 1 if you need to run the inverter at full capability during acceleration and to limit the output current during constant speed operation.

■ **Mode selection (F43)**

F43 selects the motor running state in which the current limiter becomes active.

Data for F43	Running states that enable the current limiter		
	During acceleration	During constant speed	During deceleration
0	Disable	Disable	Disable
1	Disable	Enable	Disable
2	Enable	Enable	Disable

■ **Level (F44)** Data setting range: 20 to 200 (%) (in ratio to the inverter rating)

F44 specifies the operation level at which the output current limiter becomes activated, in ratio to the inverter rating.

 **Note** The inverter's rated current differs depending upon the LD, MD, or HD mode selected.

■ **Instantaneous Overcurrent Limiting (Mode selection) (H12)**

H12 specifies whether the inverter invokes the current limit processing or enters the overcurrent trip when its output current exceeds the instantaneous overcurrent limiting level. Under the current limit processing, the inverter immediately turns OFF its output gate to suppress the further current increase and continues to control the output frequency.

Data for H12	Function
0	Disable An overcurrent trip occurs at the instantaneous overcurrent limiting level.
1	Enable

If any problem occurs in use of the equipment or machine is expected when the motor torque temporarily drops during current limiting processing, it is necessary to cause an overcurrent trip (H12 = 0) and actuate a mechanical brake at the same time.

-  **Note**
- Since the current limit operation with F43 and F44 is performed by software, it may cause a delay in control. If you need a quick response current limiting, also enable the instantaneous overcurrent limiting with H12.
 - If an excessive load is applied when the current limiter operation level is set extremely low, the inverter will rapidly lower its output frequency. This may cause an overvoltage trip or dangerous turnover of the motor rotation due to undershooting. Depending on the load, extremely short acceleration time may activate the current limiting to suppress the increase of the inverter output frequency, causing the system oscillation (hunting) or activating the inverter overvoltage trip (alarm \overline{LL}). When specifying the acceleration time, therefore, you need to take into account machinery characteristics and moment of inertia of the load.
 - The torque limiter and current limiter are very similar function each other. If both are activated concurrently, they may conflict each other and cause hunting in the system. Avoid concurrent activation of these limiters.
 - The vector control itself contains the current control system, so it disables the current limiter specified by F43 and F44, as well as automatically disabling the instantaneous overcurrent limiting (specified by H12). Accordingly, the inverter causes an overcurrent trip when its output current exceeds the instantaneous overcurrent limiting level.

**F50 to F52 Electronic Thermal Overload Protection for Braking Resistor
(Discharging capability, Allowable average loss and Resistance)**

These function codes specify the electronic thermal overload protection feature for the braking resistor.
Set the discharging capability, allowable average loss and resistance to F50, F51 and F52, respectively. These values are determined by the inverter and braking resistor models. For the discharging capability, allowable average loss and resistance, refer to FRENIC-MEGA User's Manual, Chapter 4, Section 4.4.1.1 "Braking resistors (DBRs) and braking units." The values listed in the manual are for standard models and 10% ED models of the braking resistors which Fuji Electric provides. When using a braking resistor of any other manufacturer, confirm the corresponding values with the manufacturer, and set the function codes accordingly.

- Note** Depending on the thermal marginal characteristics of the braking resistor, the electronic thermal overload protection feature may act so that the inverter issues the overheat protection alarm \overline{OH} even if the actual temperature rise is not large enough. If it happens, review the relationship between the performance index of the braking resistor and settings of related function codes.
- Tip** The standard models of braking resistor can output temperature detection signal for overheat. Assign an "Enable external alarm trip" terminal command **THR** to any of digital input terminals [X1] to [X7], [FWD] and [REV] and connect that terminal and its common terminal to braking resistor's terminals 2 and 1.

Calculating the discharging capability and allowable average loss of the braking resistor and configuring the function code data

When using any non-Fuji braking resistor, inquire of the resistor manufacturer about the resistor rating and then configure the related function codes.

The calculation procedures for the discharging capability and allowable average loss of the braking resistor differ depending on the application of the braking load as shown below.

- Applying braking load during deceleration

In usual deceleration, the braking load decreases as the speed slows down. In the deceleration with constant torque, the braking load decreases in proportion to the speed. Use Expressions (1) and (3) given below.

- Applying braking load during running at a constant speed

Different from during deceleration, in applications where the braking load is externally applied during running at a constant speed, the braking load is constant. Use Expressions (2) and (4) given below.

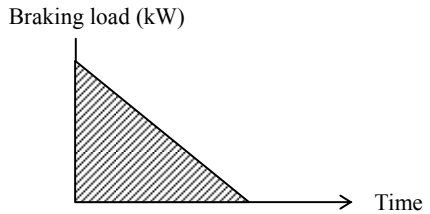

Applying braking load during deceleration

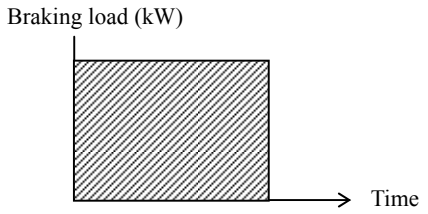

Applying braking load during running at a constant speed

■ Discharging capability (F50)

The discharging capability refers to kW's allowable for a single braking cycle, which is obtained based on the braking time and the motor rated capacity.

Data for F50	Function
0	To be applied to the braking resistor built-in type
1 to 9000	1 to 9000 (kW's)
OFF	Disable the electronic thermal overload protection

During deceleration:

$$\text{Discharging capability (kW's)} = \frac{\text{Braking time (s)} \times \text{Motor rated capacity (HP)} \times 0.75}{2} \quad \text{Expression (1)}$$

During running at a constant speed:

$$\text{Discharging capability (kW's)} = \text{Braking time (s)} \times \text{Motor rated capacity (HP)} \times 0.75 \quad \text{Expression (2)}$$

- Tip** When the F50 data is set to "0" (To be applied to the braking resistor built-in type), no specification of the discharging capability is required.

■ Allowable average loss (F51)

The allowable average loss refers to a tolerance for motor continuous operation, which is obtained based on the %ED (%) and motor rated capacity (HP).

Data for F51	Function
0.001 to 99.99	0.001 to 99.99 (kW)

During deceleration:

$$\text{Allowable average loss (kW)} = \frac{\frac{\%ED(\%)}{100} \times \text{Motor rated capacity (HP)} \times 0.75}{2} \quad \text{Expression (3)}$$

During constant speed operation:

$$\text{Allowable average loss (kW)} = \frac{\%ED(\%)}{100} \times \text{Motor rated capacity (HP)} \times 0.75 \quad \text{Expression (4)}$$

■ Resistance (F52)

F52 specifies the resistance of the braking resistor.

F80 Switching between LD, MD and HD drive modes

F80 specifies whether to drive the inverter in the low duty (LD), medium duty (MD), or high duty (HD) mode.

To change the F80 data, it is necessary to press the "STOP + ⤴" keys or "STOP + ⤵" keys" (simultaneous keying).

F80 data	Drive mode	Application	Continuous rated current level	Overload capability	Maximum frequency
1	LD (Low Duty) mode	Light load	Drive a motor whose capacity is the <u>same</u> as the inverter's one.	120% for 1 min.	120 Hz
2	MD (Medium Duty) mode	Medium load	Drives a motor whose capacity is the <u>same</u> as the inverter's one or derates a motor <u>one rank lower</u> than the inverter's capacity.	150% for 1 min.	120 Hz
0	HD (High Duty) mode	Heavy load	Derates a motor <u>one or two ranks lower</u> than the inverter's capacity.	150% for 1 min. 200% for 3 s	500 Hz

Switching to the MD/HD mode increases the overload capability (%) against the continuous current level up to 150%, but it requires derating the motor one or two ranks lower than the inverter's capacity.

Note: For 7.5 HP or smaller, when LD mode is selected, the HD mode specification applies.

For the rated current level, see Chapter 8 "SPECIFICATIONS."

The LD/MD-mode inverter is subject to restrictions on the function code data setting range and internal processing as listed below.

Function codes	Name	LD mode	MD mode	HD mode	Remarks
F21*	DC braking (Braking level)	Setting range: 0 to 80%		Setting range: 0 to 100%	In the LD/MD mode, a value out of the range, if specified, automatically changes to the maximum value allowable in the LD mode.
F26	Motor sound (Carrier frequency)	Setting range: 0.75 to 16 kHz (0.5 to 30 HP) 0.75 to 10 kHz (40 to 100 HP) 0.75 to 6 kHz (125 to 900 HP) 0.75 to 4 kHz (1000 HP)	Setting range: 0.75 to 2 kHz (150 to 800 HP)	Setting range: 0.75 to 16 kHz (0.5 to 100 HP) 0.75 to 10 kHz (125 to 800 HP) 0.75 to 6 kHz (900 and 1000 HP)	
F44	Current limiter (Level)	Initial value: 130%	Initial value: 145%	Initial value: 160%	Switching the drive mode between LD, MD and HD with function code F80 automatically initializes the F44 data to the value specified at left.
F03*	Maximum frequency	Setting range: 25 to 500 Hz Upper limit: 120 Hz		Setting range: 25 to 500 Hz Upper limit: 500 Hz	In the LD/MD mode, if the maximum frequency exceeds 120 Hz, the actual output frequency is internally limited to 120 Hz.
—	Current indication and output	Based on the rated current level for LD mode	Based on the rated current level for MD mode	Based on the rated current level for HD mode	—

Even switching to the MD/HD mode cannot automatically change the motor rated capacity (P02*), so configure the P02* data to match the applied motor rating as required.

5.2.2 E codes (Extension Terminal Functions)

E01 to E07 Terminal [X1] to [X7] Function

E98 (Terminal [FWD] Function)
E99 (Terminal [REV] Function)

E01 to E07, E98 and E99 assign commands (listed below) to general-purpose, programming, digital input terminals, [X1] to [X7], [FWD], and [REV].

These function codes can also switch the logic system between normal and negative to define how the inverter logic interprets the ON or OFF state of each terminal. The factory default setting is normal logic system "Active ON." So, descriptions that follow are given in normal logic system. They are, in principle, arranged in the numerical order of assigned data. However, highly relevant signals are collectively described where one of them first appears. Refer to the function codes in the "Related function codes" column, if any.

The FRENIC-MEGA runs under "V/f control," "dynamic torque vector control," "V/f control with speed sensor," "dynamic torque vector control with speed sensor," "vector control without speed sensor," or "vector control with speed sensor." Some terminal commands assigned apply exclusively to the specific drive control, which is indicated by letters Y (Applicable) and N (Not applicable) in the "Drive control" column in the table given below. (Refer to page 5-2.)

⚠ CAUTION

- Ensure safety before modifying the function code settings.
Run commands (e.g., "Run forward" **FWD**), stop commands (e.g., "Coast to a stop" **BX**), and frequency change commands can be assigned to digital input terminals. Depending upon the assignment states of those terminals, modifying the function code setting may cause a sudden motor start or an abrupt change in speed.
 - When the inverter is controlled with the digital input signals, switching run or frequency command sources with the related terminal commands (e.g., **SS1**, **SS2**, **SS4**, **SS8**, **H_z2/H_z1**, **H_z/PID**, **IVS**, and **LE**) may cause a sudden motor start or an abrupt change in speed.
- An accident or physical injury may result.**

Function code data		Terminal commands assigned	Symbol	Drive control					Related function codes
Active ON	Active OFF			V/f	PG V/f	w/o PG	w/ PG	Torque control	
0	1000	Select multi-frequency (0 to 15 steps)	SS1	Y	Y	Y	Y	N	C05 to C19
1	1001		SS2	Y	Y	Y	Y	N	
2	1002		SS4	Y	Y	Y	Y	N	
3	1003		SS8	Y	Y	Y	Y	N	
4	1004	Select ACC/DEC time (2 steps)	RT1	Y	Y	Y	Y	N	F07, F08, E10 to E15
5	1005	Select ACC/DEC time (4 steps)	RT2	Y	Y	Y	Y	N	
6	1006	Enable 3-wire operation	HLD	Y	Y	Y	Y	Y	F02
7	1007	Coast to a stop	BX	Y	Y	Y	Y	Y	—
8	1008	Reset alarm	RST	Y	Y	Y	Y	Y	—
1009	9	Enable external alarm trip	THR	Y	Y	Y	Y	Y	—
10	1010	Ready for jogging	JOG	Y	Y	Y	Y	N	C20, H54, H55, d09 to d13
11	1011	Select frequency command 2/1	H_z2/H_z1	Y	Y	Y	Y	N	F01, C30
12	1012	Select motor 2	M2	Y	Y	Y	Y	Y	A42
13	—	Enable DC braking	DCBRK	Y	Y	Y	Y	N	F20 to F22
14	1014	Select torque limiter level 2/1	TL2/TL1	Y	Y	Y	Y	Y	F40, F41, E16, E17
15	—	Switch to commercial power (50 Hz)	SW50	Y	Y	N	N	N	—
16	—	Switch to commercial power (60 Hz)	SW60	Y	Y	N	N	N	—
17	1017	UP (Increase output frequency)	UP	Y	Y	Y	Y	N	Frequency command: F01, C30 PID command: J02
18	1018	DOWN (Decrease output frequency)	DOWN	Y	Y	Y	Y	N	
19	1019	Enable data change with keypad	WE-KP	Y	Y	Y	Y	Y	F00
20	1020	Cancel PID control	H_z/PID	Y	Y	Y	Y	N	J01 to J19, J56 to J62
21	1021	Switch normal/inverse operation	IVS	Y	Y	Y	Y	N	C53, J01
22	1022	Interlock	IL	Y	Y	Y	Y	Y	F14
23	1023	Cancel torque control	H_z/TRQ	N	N	N	N	Y	H18
24	1024	Enable communications link via RS-485 or fieldbus (option)	LE	Y	Y	Y	Y	Y	H30, y98
25	1025	Universal DI	U-DI	Y	Y	Y	Y	Y	—

Function code data		Terminal commands assigned	Symbol	Drive control					Related function codes
Active ON	Active OFF			V/f	PG V/f	w/o PG	w/ PG	Torque control	
26	1026	Enable auto search for idling motor speed at starting	<i>STM</i>	Y	Y	Y	N	Y	H09, <u>d67</u>
1030	30	Force to stop	<i>STOP</i>	Y	Y	Y	Y	Y	F07, H56
32	1032	Pre-excitation	<i>EXITE</i>	N	N	Y	Y	N	H84, H85
33	1033	Reset PID integral and differential components	<i>PID-RST</i>	Y	Y	Y	Y	N	J01 to J19, J56 to J62
34	1034	Hold PID integral component	<i>PID-HLD</i>	Y	Y	Y	Y	N	
35	1035	Select local (keypad) operation	<i>LOC</i>	Y	Y	Y	Y	Y	(See Section 4.2.2.)
36	1036	Select motor 3	<i>M3</i>	Y	Y	Y	Y	Y	A42, b42
37	1037	Select motor 4	<i>M4</i>	Y	Y	Y	Y	Y	A42, r42
39	—	Protect motor from dew condensation	<i>DWP</i>	Y	Y	Y	Y	Y	J21
40	—	Enable integrated sequence to switch to commercial power (50 Hz)	<i>ISW50</i>	Y	Y	N	N	N	J22
41	—	Enable integrated sequence to switch to commercial power (60 Hz)	<i>ISW60</i>	Y	Y	N	N	N	
47	1047	Servo-lock command	<i>LOCK</i>	N	N	N	Y	N	J97 to <u>J99</u>
48	—	Pulse train input (available only on terminal [X7])	<i>PIN</i>	Y	Y	Y	Y	Y	F01, C30, d62, d63
49	1049	Pulse train sign (available on terminals except [X7])	<i>SIGN</i>	Y	Y	Y	Y	Y	
70	1070	Cancel constant peripheral speed control	<i>H_z/LSC</i>	Y	Y	Y	Y	N	d41
71	1071	Hold the constant peripheral speed control frequency in the memory	<i>LSC-HLD</i>	Y	Y	Y	Y	N	
72	1072	Count the run time of commercial power-driven motor 1	<i>CRUN-M1</i>	Y	Y	N	N	Y	H44, H94
73	1073	Count the run time of commercial power-driven motor 2	<i>CRUN-M2</i>	Y	Y	N	N	Y	
74	1074	Count the run time of commercial power-driven motor 3	<i>CRUN-M3</i>	Y	Y	N	N	Y	
75	1075	Count the run time of commercial power-driven motor 4	<i>CRUN-M4</i>	Y	Y	N	N	Y	
76	1076	Select droop control	<i>DROOP</i>	Y	Y	Y	Y	N	H28
77	1077	Cancel PG alarm	<i>PG-CCL</i>	N	Y	N	Y	Y	—
80	1080	Cancel customizable logic	<i>CLC</i>	Y	Y	Y	Y	Y	E01 to E07, U81 to U85
81	1081	Clear all customizable logic timers	<i>CLTC</i>	Y	Y	Y	Y	Y	
98	—	Run forward (Exclusively assigned to [FWD] and [REV] terminals by E98 and E99)	<i>FWD</i>	Y	Y	Y	Y	Y	<u>F02</u>
99	—	Run reverse (Exclusively assigned to [FWD] and [REV] terminals by E98 and E99)	<i>REV</i>	Y	Y	Y	Y	Y	
100	—	No function assigned	<i>NONE</i>	Y	Y	Y	Y	Y	U81 to U85

Note Some negative logic (Active OFF) commands cannot be assigned to the functions marked with "—" in the "Active OFF" column.

The "Enable external alarm trip" (data = 1009) and "Force to stop" (data = 1030) are fail-safe terminal commands. In the case of "Enable external alarm trip," when data = 1009, "Active ON" (alarm is triggered when ON); when data = 9, "Active OFF" (alarm is triggered when OFF).

E codes

Terminal function assignment and data setting

■ Coast to a stop -- **BX** (Function code data = 7)

Turning this terminal command ON immediately shuts down the inverter output so that the motor coasts to a stop without issuing any alarms.

■ Reset alarm -- **RST** (Function code data = 8)

Turning this terminal command ON clears the **ALM** state--alarm output (for any fault). Turning it OFF erases the alarm display and clears the alarm hold state.

When you turn the **RST** command ON, keep it ON for 10 ms or more. This command should be kept OFF for the normal inverter operation.

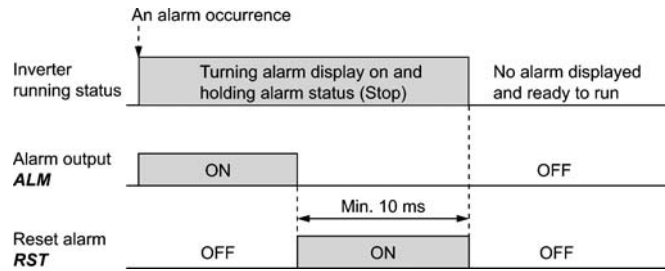

■ Enable external alarm trip -- **THR** (Function code data = 9)

Turning this terminal command OFF immediately shuts down the inverter output (so that the motor coasts to a stop), displays the alarm \square , and outputs the alarm relay (for any fault) **ALM**. The **THR** command is self-held, and is reset when an alarm reset takes place.



Use this alarm trip command from external equipment when you have to immediately shut down the inverter output in the event of an abnormal situation in peripheral equipment.

■ Switch to commercial power for 50 Hz or 60 Hz -- **SW50** and **SW60** (Function code data = 15 and 16)

When an external sequence switches the motor drive power from the commercial line to the inverter, inputting the terminal command **SW50** or **SW60** at the specified timing enables the inverter to start running the motor with the current commercial power frequency, regardless of settings of the reference/output frequency in the inverter. A running motor driven by commercial power is carried on into inverter operation. This command helps you smoothly switch the motor drive power source, when the motor is being driven by commercial power, from the commercial power to the inverter power.

For details, refer to the following table, the operation schemes, and an example of external circuit and its operation time scheme on the following pages.

Assignment	The inverter:	Description
SW50	Starts at 50 Hz.	Do not concurrently assign both SW50 and SW60 .
SW60	Starts at 60 Hz.	

Operation Schemes

- When the motor speed remains almost the same during coast-to-stop:

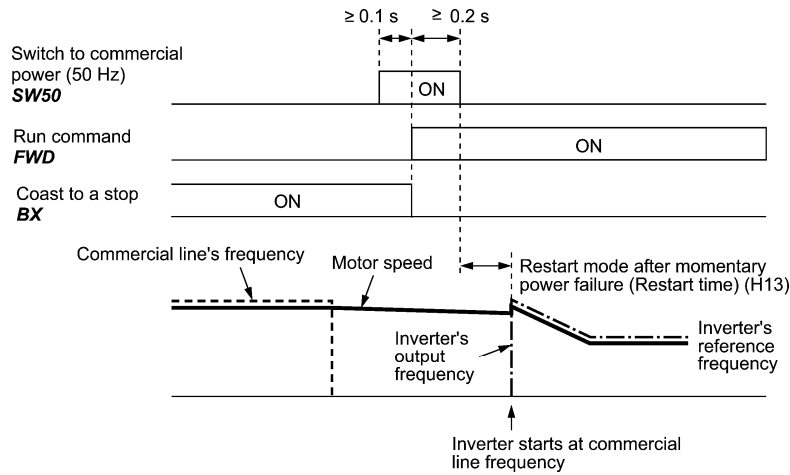

- When the motor speed decreases significantly during coast-to-stop (with the current limiter activated):

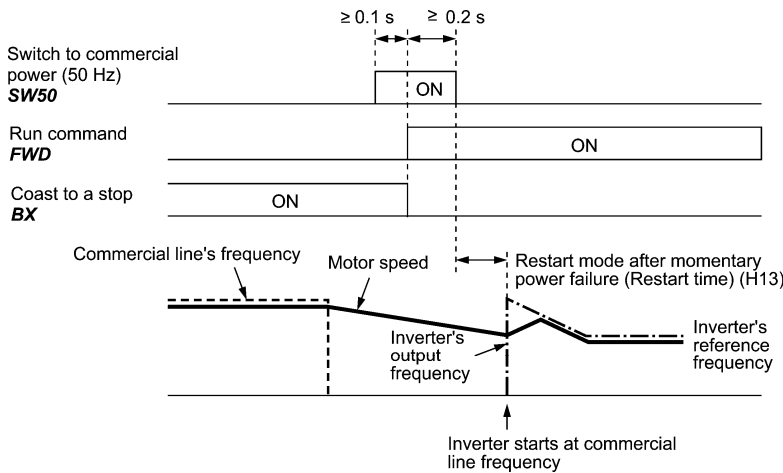

Note

- Secure more than 0.1 second after turning ON the "Switch to commercial power" signal before turning ON a run command.
- Secure more than 0.2 second of an overlapping period with both the "Switch to commercial power" signal and run command being ON.
- If an alarm has been issued or **BX** has been ON when the motor drive source is switched from the commercial power to the inverter, the inverter will not be started at the commercial power frequency and will remain OFF. After the alarm has been reset or **BX** turned OFF, operation at the frequency of the commercial power will not be continued, and the inverter will be started at the ordinary starting frequency.
If you wish to switch the motor drive source from the commercial line to the inverter, be sure to turn **BX** OFF before the "Switch to commercial power" signal is turned OFF.
- When switching the motor drive source from the inverter to commercial power, adjust the inverter's reference frequency at or slightly higher than that of the commercial power frequency beforehand, taking into consideration the motor speed down during the coast-to-stop period produced by switching.
- Note that when the motor drive source is switched from the inverter to the commercial power, a high inrush current will be generated, because the phase of the commercial power usually does not match the motor speed at the switching. Make sure that the power supply and all the peripheral equipment are capable of withstanding this inrush current.
- If you have enabled "Restart after momentary power failure" (F14 = 3, 4, or 5), keep **BX** ON during commercial power driven operation to prevent the inverter from restarting after a momentary power failure.

E codes

Example of Sequence Circuit

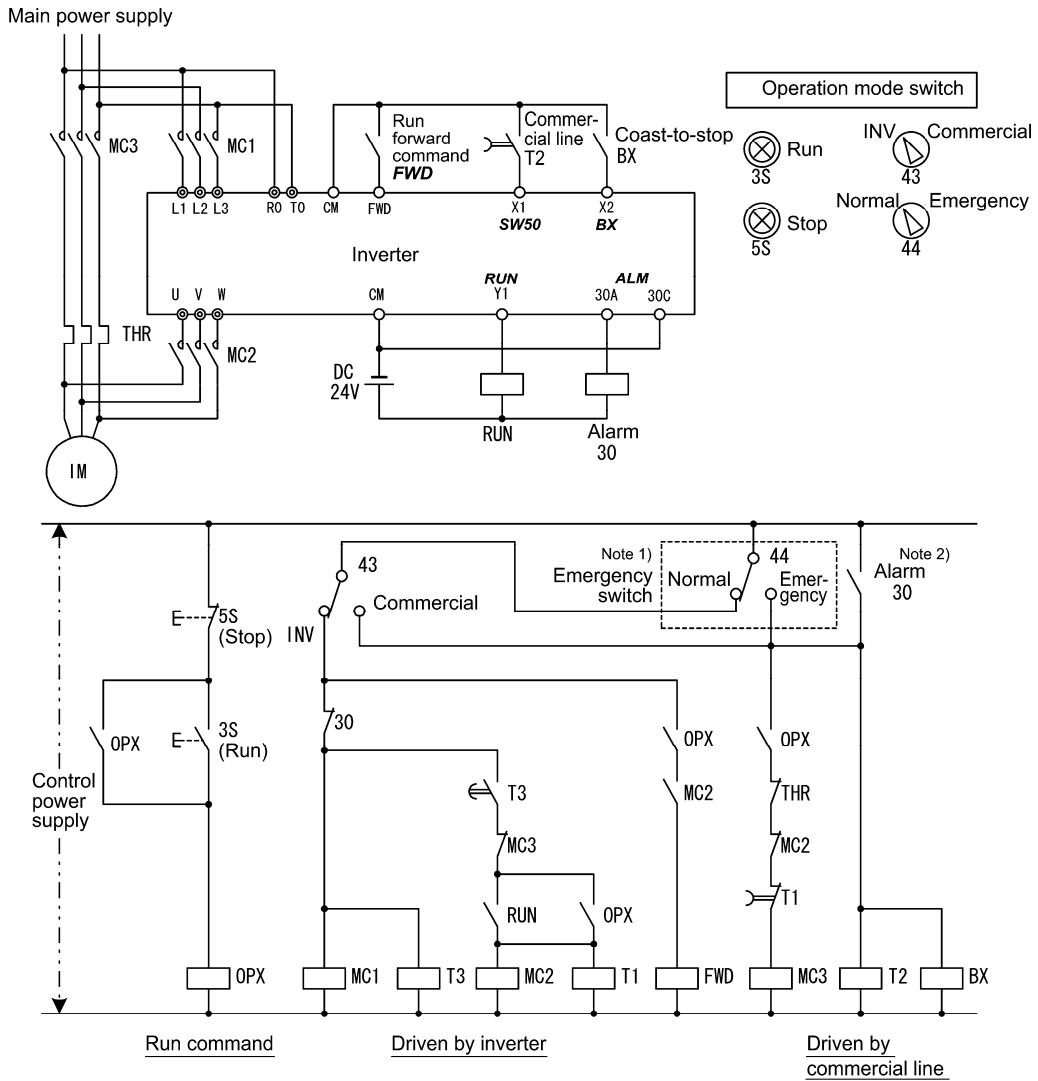

Note 1) Emergency switch

Manual switch provided for the event that the motor drive source cannot be switched normally to the commercial power due to a serious problem of the inverter

Note 2) When any alarm has occurred inside the inverter, the motor drive source will automatically be switched to the commercial power.

Example of Operation Time Scheme

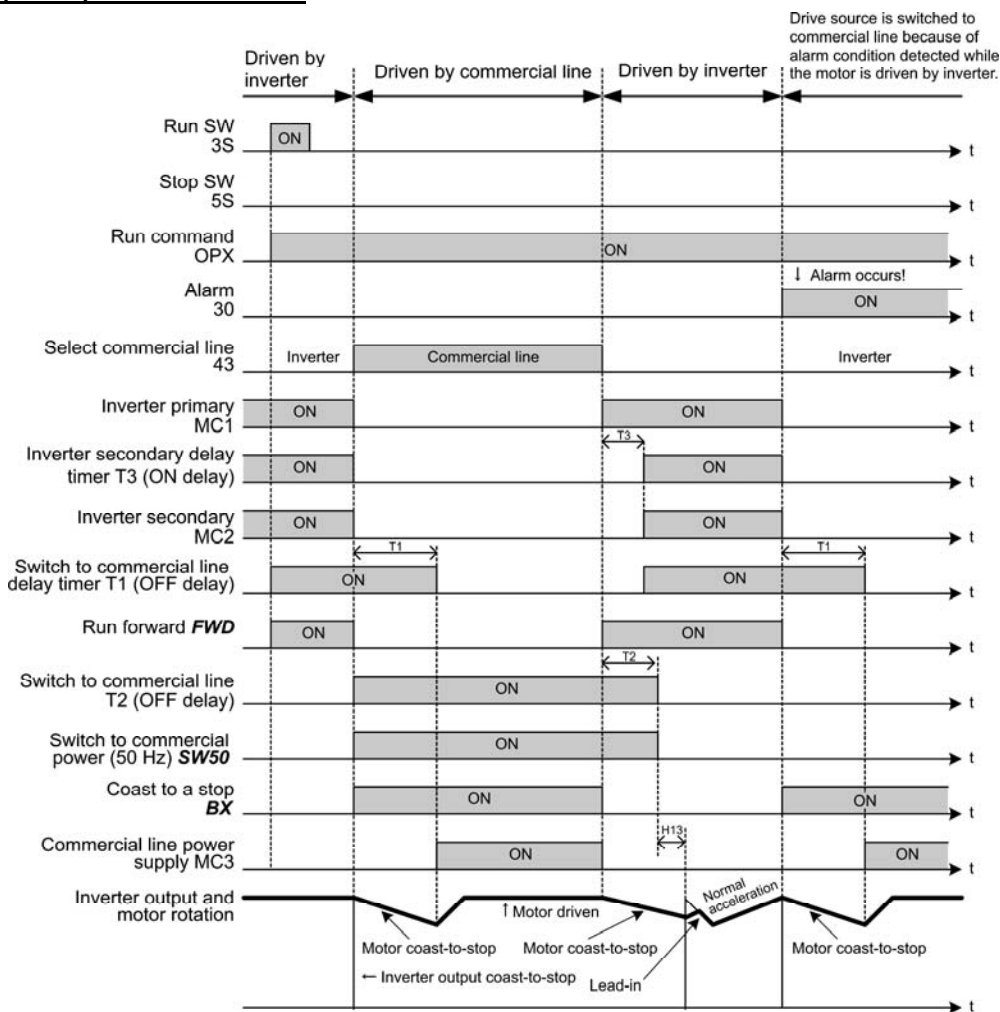

Tip Alternatively, you may use the integrated sequence by which some of the actions above are automatically performed by the inverter itself. For details, refer to the description of *ISW50* and *ISW60*.

■ **Cancel PID control -- Hz/PID** (Function code data = 20)

Turning this terminal command ON disables the PID control.

If the PID control is disabled with this command, the inverter runs the motor with the reference frequency manually set by any of the multi-frequency, keypad, analog input, etc.

E codes

Terminal command <i>Hz/PID</i>	Function
OFF	Enable PID control
ON	Disable PID control/Enable manual frequency settings

(Refer to the descriptions of J01 through J19 and J56 through J62.)

■ Switch normal/inverse operation -- **IVS** (Function code data = 21)

This terminal command switches the output frequency control between normal (proportional to the input value) and inverse in analog frequency setting or under PID process control. To select the inverse operation, turn the **IVS** ON.

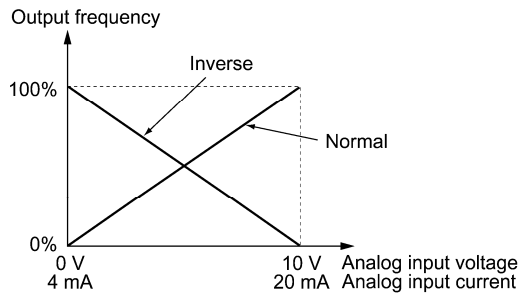

Tip The normal/inverse switching operation is useful for air-conditioners that require switching between cooling and heating. In cooling, the speed of the fan motor (output frequency of the inverter) is increased to lower the temperature. In heating, it is reduced to lower the temperature. This switching is realized by this **IVS** terminal command.

• **When the inverter is driven by an external analog frequency command sources (terminals [12], [C1] and [V2]):**

Switching normal/inverse operation can apply only to the analog frequency command sources (terminals [12], [C1] and [V2]) in frequency command 1 (F01) and does not affect frequency command 2 (C30) or UP/DOWN control.

As listed below, the combination of the "Selection of normal/inverse operation for frequency command 1" (C53) and the **IVS** terminal command determines the final operation.

Combination of C53 and **IVS**

Data for C53	IVS	Final operation
0: Normal operation	OFF	Normal
	ON	Inverse
1: Inverse operation	OFF	Inverse
	ON	Normal

• **When the process control is performed by the PID processor integrated in the inverter:**

The terminal command **Hz/PID** ("Cancel PID control") can switch the PID control between enabled (process is to be controlled by the PID processor) and disabled (process is to be controlled by the manual frequency setting). In either case, the combination of the "PID control" (J01) or "Selection of normal/inverse operation for frequency command 1" (C53) and the terminal command **IVS** determines the final operation as listed below.

When the PID control is enabled:

The normal/inverse operation selection for the PID processor output (reference frequency) is as follows.

PID control (Mode selection) (J01)	IVS	Final operation
1: Enable (normal operation)	OFF	Normal
	ON	Inverse
2: Enable (inverse operation)	OFF	Inverse
	ON	Normal

When the PID control is disabled:

The normal/inverse operation selection for the manual reference frequency is as follows.

Selection of normal/inverse operation for frequency command 1 (C53)	IVS	Final operation
0: Normal operation	—	Normal
1: Inverse operation	—	Inverse

Note When the process control is performed by the PID control facility integrated in the inverter, the **IVS** is used to switch the PID processor output (reference frequency) between normal and inverse, and has no effect on any normal/inverse operation selection of the manual frequency setting.

Refer to the descriptions of J01 through J19 and J56 through J62.

■ Universal DI -- **U-DI** (Function code data = 25)

Using **U-DI** enables the inverter to monitor digital signals sent from the peripheral equipment via an RS-485 communications link or a fieldbus option by feeding those signals to the digital input terminals. Signals assigned to the universal DI are simply monitored and do not operate the inverter.

 For an access to universal DI via the RS-485 or fieldbus communications link, refer to their respective Instruction Manuals.

■ Force to stop -- **STOP** (Function code data = 30)

Turning this terminal command OFF causes the motor to decelerate to a stop in accordance with the H56 data (Deceleration time for forced stop). After the motor stops, the inverter enters the alarm state with the alarm $\bar{E}-\bar{E}$ displayed. ( Refer to the description of F07.)

■ Reset PID integral and differential components -- **PID-RST** (Function code data = 33)

Turning this terminal command ON resets the integral and differential components of the PID processor. ( Refer to the descriptions of J01 through J19 and J56 through J62.)

■ Hold PID integral component -- **PID-HLD** (Function code data = 34)

Turning this terminal command ON holds the integral components of the PID processor. ( Refer to the descriptions of J01 through J19 and J56 through J62.)

■ Enable integrated sequence to switch to commercial power (50 Hz) and (60 Hz) -- **ISW50** and **ISW60** (Function code data = 40 and 41)

With the terminal command **ISW50** or **ISW60** assigned, the inverter controls the magnetic contactor that switches the motor drive source between the commercial power and the inverter output according to the integrated sequence.

This control is effective when not only **ISW50** or **ISW60*** has been assigned to the input terminal but also the **SW88** and **SW52-2** signals have been assigned to the output terminals. (It is not essential to assign the **SW52-1** signal.)

* The **ISW50** or **ISW60** should be selected depending upon the frequency of the commercial power; the former for 50 Hz and the latter for 60 Hz.

For details of these commands, refer to the circuit diagrams and timing schemes given below.

Terminal command assigned	Operation (Switching from commercial power to inverter)
ISW50 Enable integrated sequence to switch to commercial power (50 Hz)	Start at 50 Hz.
ISW60 Enable integrated sequence to switch to commercial power (60 Hz)	Start at 60 Hz.

 **Note** Do not assign both **ISW50** and **ISW60** at the same time. Doing so cannot guarantee the result.

Circuit Diagram and Configuration

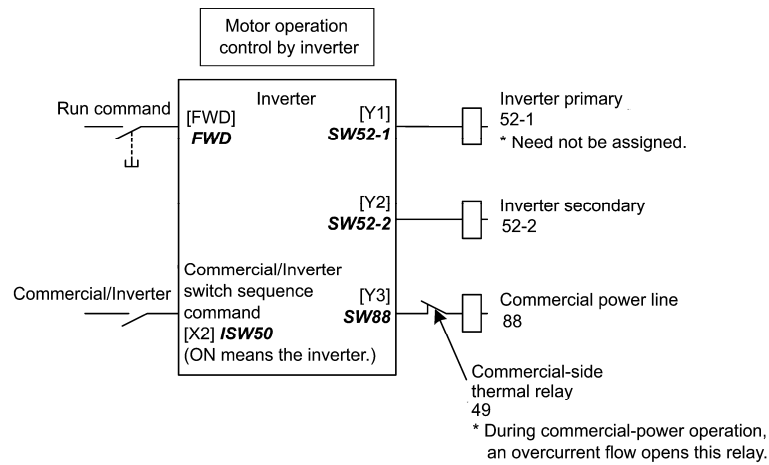
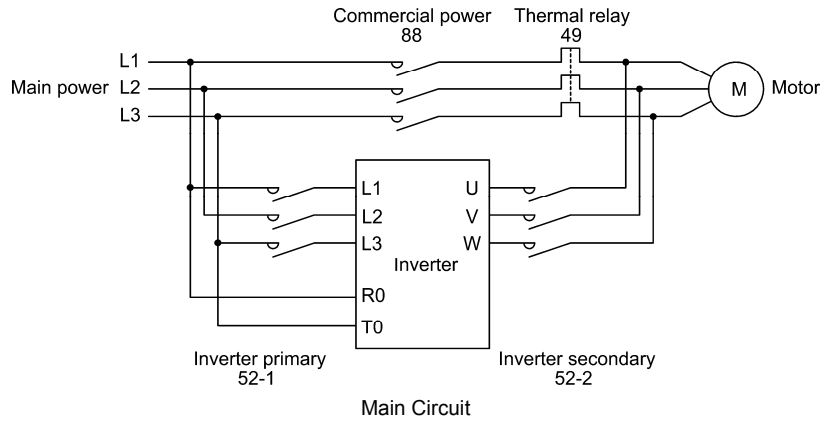

Configuration of Control Circuit

Summary of Operation

Input		Output (Status signal and magnetic contactor)			Inverter operation
<i>ISW50</i> or <i>ISW60</i>	Run command	<i>SW52-1</i> 52-1	<i>SW52-2</i> 52-2	<i>SW88</i> 88	
OFF (Commercial power)	ON	OFF	OFF	ON	OFF
	OFF	OFF	OFF	OFF	
ON (Inverter)	ON	ON	ON	OFF	ON
	OFF	ON	ON	OFF	OFF

Timing Scheme

Switching from inverter operation to commercial-power operation *ISW50/ISW60*: ON → OFF

- (1) The inverter output is shut OFF immediately (Power gate IGBT OFF)
- (2) The inverter primary circuit *SW52-1* and the inverter secondary side *SW52-2* are turned OFF immediately.
- (3) If a run command is present after an elapse of t1 (0.2 sec + time specified by H13), the commercial power circuit *SW88* is turned ON.

Switching from commercial-power operation to inverter operation *ISW50/ISW60*: OFF → ON

- (1) The inverter primary circuit *SW52-1* is turned ON immediately.
- (2) The commercial power circuit *SW88* is turned OFF immediately.
- (3) After an elapse of t_2 (0.2 sec + time required for the main circuit to get ready) from when *SW52-1* is turned ON, the inverter secondary circuit *SW52-2* is turned ON.
- (4) After an elapse of t_3 (0.2 sec + time specified by H13) from when *SW52-2* is turned ON, the inverter harmonizes once the motor that has been freed from the commercial power to the commercial power frequency. Then the motor returns to the operation driven by the inverter.

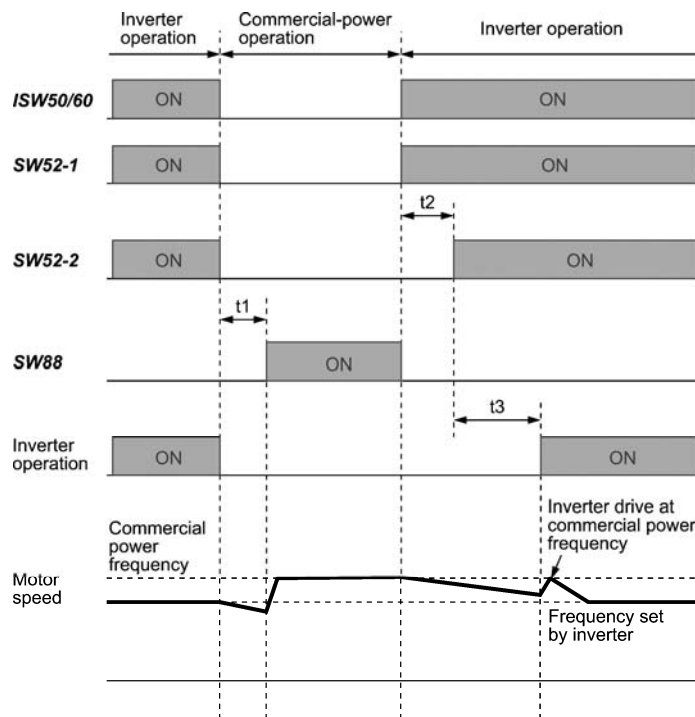

- t_1 : 0.2 sec + Time specified by H13 (Restart mode after momentary power failure)
- t_2 : 0.2 sec + Time required for the main circuit to get ready
- t_3 : 0.2 sec + Time specified by H13 (Restart mode after momentary power failure)

Selection of Commercial Power Switching Sequence

J22 specifies whether or not to automatically switch to commercial-power operation when an inverter alarm occurs.

Data for J22	Sequence (upon occurrence of an alarm)
0	Keep inverter-operation (Stop due to alarm.)
1	Automatically switch to commercial-power operation

- Note**
- The sequence operates normally also even when *SW52-1* is not used and the main power of the inverter is supplied at all times.
 - Using *SW52-1* requires connecting the input terminals [R0] and [T0] for an auxiliary control power. Without the connection, turning *SW52-1* OFF loses also the control power.
 - The sequence operates normally even if an alarm occurs in the inverter except when the inverter itself is broken. Therefore, for a critical facility, be sure to install an emergency switching circuit outside the inverter.
 - Turning ON both the magnetic contactor MC (88) at the commercial-power side and the MC (52-2) at the inverter output side at the same time supplies main power mistakenly from the output (secondary) side of the inverter, which may damage the inverter. To prevent it, be sure to set up an interlocking logic outside the inverter.

Examples of Sequence Circuits

1) Standard sequence

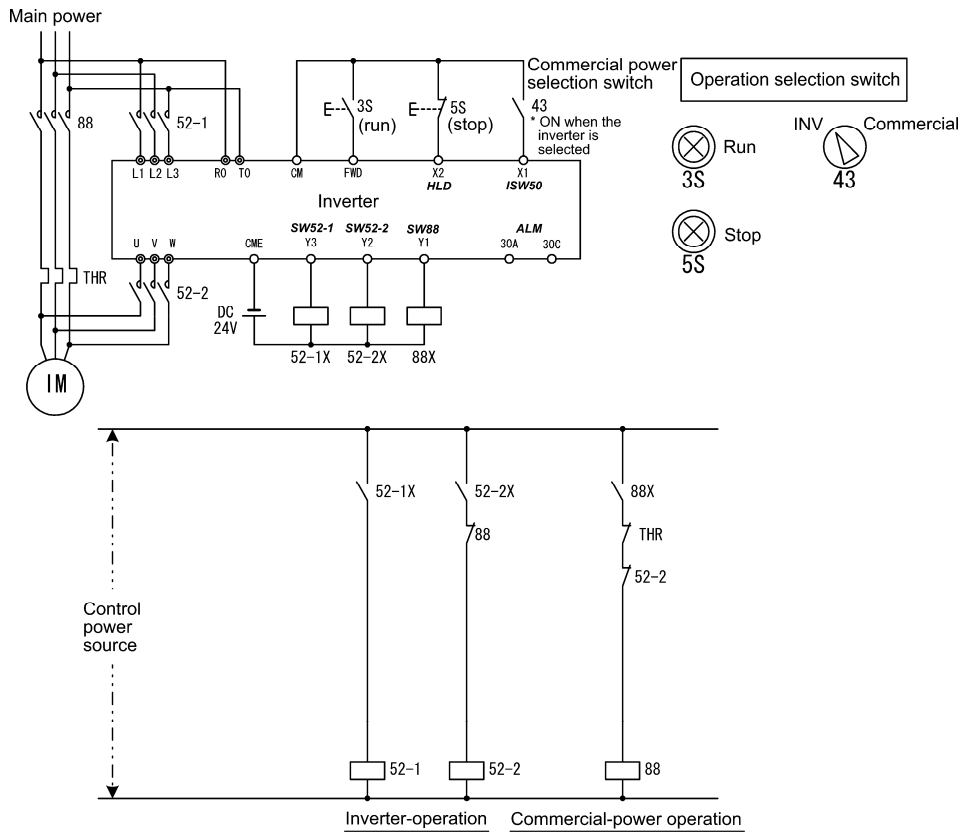

2) Sequence with an emergency switching function

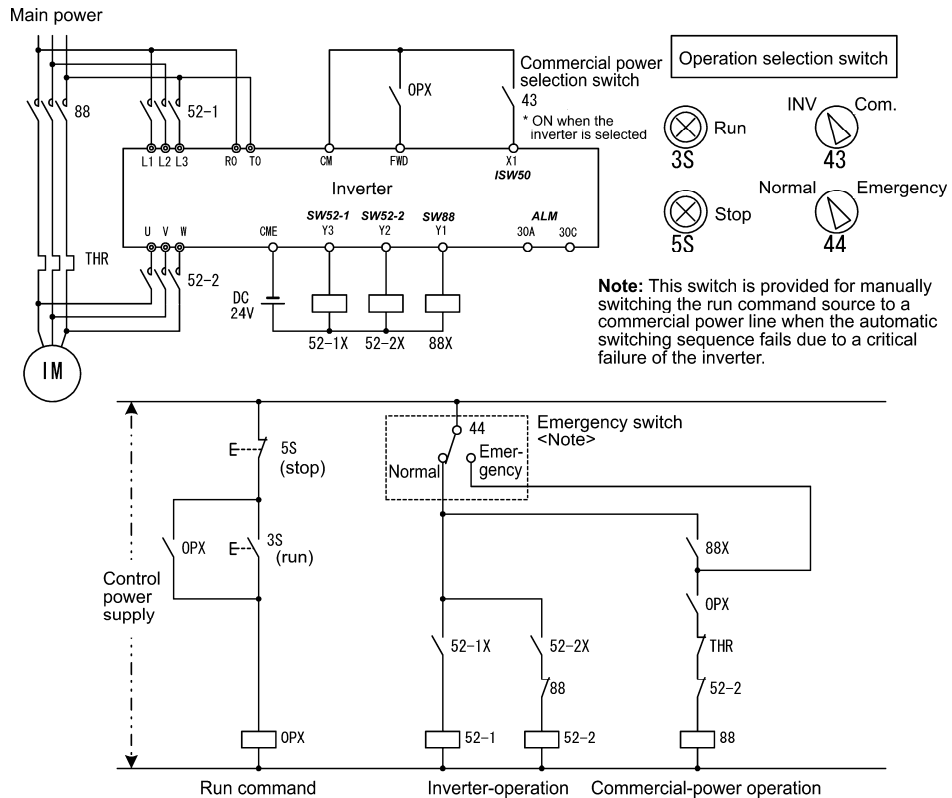

3) Sequence with an emergency switching function --Part 2 (Automatic switching by the alarm output issued by the inverter)

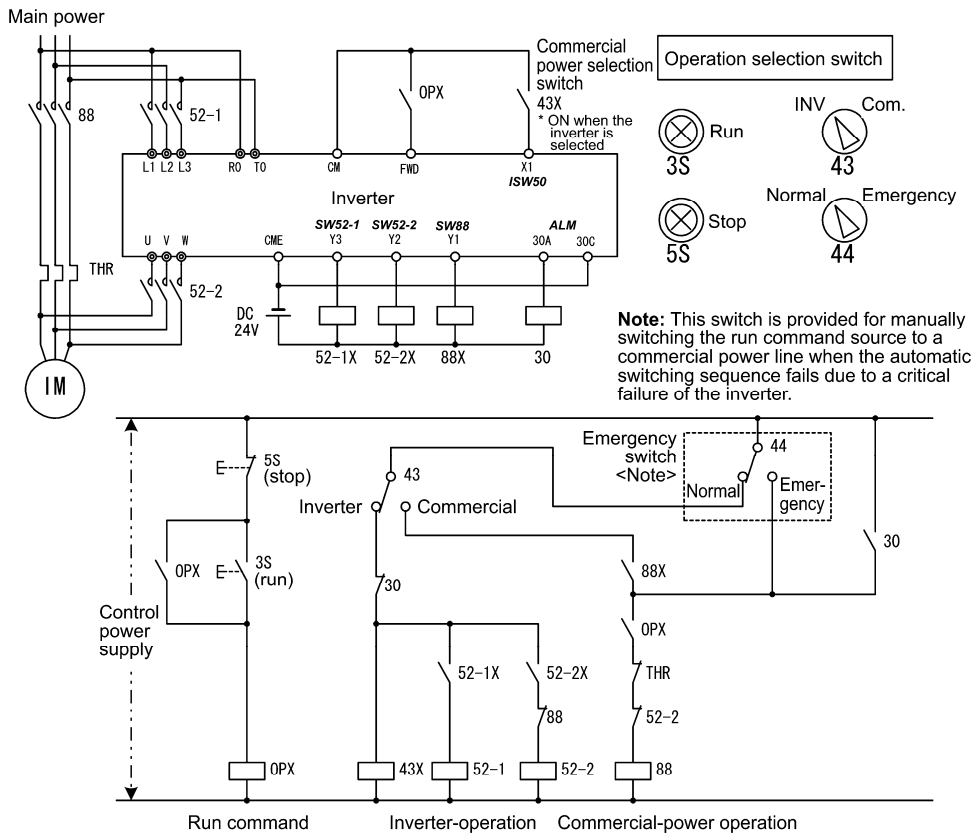

■ Cancel PG alarm-- **PG-CCL** (Function code data = 77)

When this terminal command is ON, the PG wire break alarm is ignored. Use this terminal command when switching PG wires for switching motors, for example, to prevent it from being detected as PG wire break.

■ Run forward -- **FWD** (Function code data = 98)

Turning this terminal command ON runs the motor in the forward direction; turning it OFF decelerates it to stop.

Tip This terminal command can be assigned only by E98 or E99.

■ Run reverse -- **REV** (Function code data = 99)

Turning this terminal command ON runs the motor in the reverse direction; turning it OFF decelerates it to stop.

Tip This terminal command can be assigned only by E98 or E99

E10 to E15 Acceleration Time 2 to 4, Deceleration Time 2 to 4 (Refer to F07.)

E16, E17 Torque Limiter 2-1, 2-2 (Refer to F40.)

E20 to E23 Terminal [Y1] to [Y4] Function
E24, E27 Terminal [Y5A/C] and [30A/B/C] Function (Relay output)

E20 through E24 and E27 assign output signals (listed on the next page) to general-purpose, programmable output terminals [Y1], [Y2], [Y3], [Y4], [Y5A/C] and [30A/B/C].

These function codes can also switch the logic system between normal and negative to define how the inverter interprets the ON or OFF state of each terminal. The factory default setting is normal logic system "Active ON."

Terminals [Y1], [Y2], [Y3] and [Y4] are transistor outputs and terminals [Y5A/C] and [30A/B/C] are relay contact outputs. In normal logic, if an alarm occurs, the relay will be energized so that [30A] and [30C] will be closed, and [30B] and [30C] opened. In negative logic, the relay will be deenergized so that [30A] and [30C] will be opened, and [30B] and [30C] closed. This may be useful for the implementation of failsafe power systems.

Note • When a negative logic is employed, all output signals are active (e.g. an alarm would be recognized) while the inverter is powered OFF. To avoid causing system malfunctions by this, interlock these signals to keep them ON using an external power supply. Furthermore, the validity of these output signals is not guaranteed for approximately 1.5 seconds (for 40 HP or below) or 3 seconds (for 50 HP or above) after power-ON, so introduce such a mechanism that masks them during the transient period.

Note • Terminals [Y5A/C] and [30A/B/C] use mechanical contacts that cannot stand frequent ON/OFF switching. Where frequent ON/OFF switching is anticipated (for example, limiting a current by using signals subjected to inverter output limit control such as switching to commercial power line or direct-on-line starting), use transistor outputs [Y1], [Y2], [Y3] and [Y4] instead.

The service life of a relay is approximately 200,000 times if it is switched ON and OFF at one-second intervals.

The table below lists functions that can be assigned to terminals [Y1], [Y2], [Y3], [Y4], [Y5A/C], and [30A/B/C]. The descriptions are, in principle, arranged in the numerical order of assigned data. However, highly relevant signals are collectively described where one of them first appears. Refer to the function codes or signals in the "Related function codes/signals (data)" column, if any.

The FRENIC-MEGA runs under "V/f control," "dynamic torque vector control," "V/f control with speed sensor," "dynamic torque vector control with speed sensor," "vector control without speed sensor," or "vector control with speed sensor." Some output signals assigned apply exclusively to the specific drive control, which is indicated by letters Y (Applicable) and N (Not applicable) in the "Drive control" column of the table given below. (Refer to page 5-2.)

Explanations of each function are given in normal logic system "Active ON."

Function code data		Functions assigned	Symbol	Drive control					Related function codes/signals (data)
Active ON	Active OFF			V/f	PG V/f	w/o PG	w/ PG	Torque control	
0	1000	Inverter running	<i>RUN</i>	Y	Y	Y	Y	Y	—
1	1001	Frequency (speed) arrival signal	<i>FAR</i>	Y	Y	Y	Y	N	<u>E30</u>
2	1002	Frequency (speed) detected	<i>FDT</i>	Y	Y	Y	Y	Y	<u>E31, E32</u>
3	1003	Undervoltage detected (Inverter stopped)	<i>LU</i>	Y	Y	Y	Y	Y	—
4	1004	Torque polarity detected	<i>B/D</i>	Y	Y	Y	Y	Y	—
5	1005	Inverter output limiting	<i>IOL</i>	Y	Y	Y	Y	Y	—
6	1006	Auto-restarting after momentary power failure	<i>IPF</i>	Y	Y	Y	Y	Y	<u>F14</u>
7	1007	Motor overload early warning	<i>OL</i>	Y	Y	Y	Y	Y	<u>E34, F10, F12</u>
8	1008	Keypad operation enabled	<i>KP</i>	Y	Y	Y	Y	Y	—
10	1010	Inverter ready to run	<i>RDY</i>	Y	Y	Y	Y	Y	—
11	—	Switch motor drive source between commercial power and inverter output (For MC on commercial line)	<i>SW88</i>	Y	Y	N	N	N	<u>E01 to E07</u> <i>ISW50</i> (40) <i>ISW60</i> (41) J22
12	—	Switch motor drive source between commercial power and inverter output (For secondary side)	<i>SW52-2</i>	Y	Y	N	N	N	
13	—	Switch motor drive source between commercial power and inverter output (For primary side)	<i>SW52-1</i>	Y	Y	N	N	N	
15	1015	Select AX terminal function (For MC on primary side)	<i>AX</i>	Y	Y	Y	Y	Y	—
22	1022	Inverter output limiting with delay	<i>IOL2</i>	Y	Y	Y	Y	Y	<u>IOL</u> (5)
25	1025	Cooling fan in operation	<i>FAN</i>	Y	Y	Y	Y	Y	<u>H06</u>
26	1026	Auto-resetting	<i>TRY</i>	Y	Y	Y	Y	Y	<u>H04, H05</u>
27	1027	Universal DO	<i>U-DO</i>	Y	Y	Y	Y	Y	—

Function code data		Functions assigned	Symbol	Drive control					Related function codes/signals (data)
Active ON	Active OFF			V/f	PG V/f	w/o PG	w/ PG	Torque control	
28	1028	Heat sink overheat early warning	<i>OH</i>	Y	Y	Y	Y	Y	—
29	1029	Synchronization completed	<i>SY</i>	N	Y	N	Y	N	(See the PG Interface Card instruction manual.)
30	1030	Lifetime alarm	<i>LIFE</i>	Y	Y	Y	Y	Y	(See Section 7.3.)
31	1031	Frequency (speed) detected 2	<i>FDT2</i>	Y	Y	Y	Y	Y	<u>E32</u> , E36
33	1033	Reference loss detected	<i>REF OFF</i>	Y	Y	Y	Y	Y	<u>E65</u>
35	1035	Inverter output on	<i>RUN2</i>	Y	Y	Y	Y	Y	<i>RUN</i> (0)
36	1036	Overload prevention control	<i>OLP</i>	Y	Y	Y	Y	N	<u>H70</u>
37	1037	Current detected	<i>ID</i>	Y	Y	Y	Y	Y	<u>E34</u> , <u>E35</u> , <u>E37</u> , <u>E38</u> , <u>E55</u> , <u>E56</u>
38	1038	Current detected 2	<i>ID2</i>	Y	Y	Y	Y	Y	
39	1039	Current detected 3	<i>ID3</i>	Y	Y	Y	Y	Y	
41	1041	Low current detected	<i>IDL</i>	Y	Y	Y	Y	Y	<u>J11 to J13</u>
42	1042	PID alarm	<i>PID-ALM</i>	Y	Y	Y	Y	N	
43	1043	Under PID control	<i>PID-CTL</i>	Y	Y	Y	Y	N	J01
44	1044	Motor stopped due to slow flowrate under PID control	<i>PID-STP</i>	Y	Y	Y	Y	N	<u>J08</u> , <u>J09</u>
45	1045	Low output torque detected	<i>U-TL</i>	Y	Y	Y	Y	Y	<u>E78 to E81</u>
46	1046	Torque detected 1	<i>TD1</i>	Y	Y	Y	Y	Y	
47	1047	Torque detected 2	<i>TD2</i>	Y	Y	Y	Y	Y	
48	1048	Motor 1 selected	<i>SWM1</i>	Y	Y	Y	Y	Y	<u>A42</u> , <u>b42</u> , <u>r42</u>
49	1049	Motor 2 selected	<i>SWM2</i>	Y	Y	Y	Y	Y	
50	1050	Motor 3 selected	<i>SWM3</i>	Y	Y	Y	Y	Y	
51	1051	Motor 4 selected	<i>SWM4</i>	Y	Y	Y	Y	Y	
52	1052	Running forward	<i>FRUN</i>	Y	Y	Y	Y	Y	—
53	1053	Running reverse	<i>RRUN</i>	Y	Y	Y	Y	Y	—
54	1054	In remote operation	<i>RMT</i>	Y	Y	Y	Y	Y	(See Section 4.2.2.)
56	1056	Motor overheat detected by thermistor	<i>THM</i>	Y	Y	Y	Y	Y	<u>H26</u> , <u>H27</u>
57	1057	Brake signal	<i>BRKS</i>	Y	Y	Y	Y	N	<u>J68 to J72</u>
58	1058	Frequency (speed) detected 3	<i>FDT3</i>	Y	Y	Y	Y	Y	<u>E32</u> , <u>E54</u>
59	1059	Terminal [C1] wire break	<i>CIOFF</i>	Y	Y	Y	Y	Y	—
70	1070	Speed valid	<i>DNZS</i>	N	Y	Y	Y	Y	F25, F38
71	1071	Speed agreement	<i>DSAG</i>	N	Y	Y	Y	N	<u>d21</u> , <u>d22</u>
72	1072	Frequency (speed) arrival signal 3	<i>FAR3</i>	Y	Y	Y	Y	N	<u>E30</u>
76	1076	PG error detected	<i>PG-ERR</i>	N	Y	Y	Y	N	<u>d21 to d23</u>
82	1082	Positioning completion signal	<i>PSET</i>	N	N	N	Y	N	<u>J97 to J99</u>
84	1084	Maintenance timer	<i>MNT</i>	Y	Y	Y	Y	Y	<u>H44</u> , <u>H78</u> , <u>H79</u>
98	1098	Light alarm	<i>L-ALM</i>	Y	Y	Y	Y	Y	<u>H81</u> , <u>H82</u>
99	1099	Alarm output (for any alarm)	<i>ALM</i>	Y	Y	Y	Y	Y	—
101	1101	Enable circuit failure detected	<i>DECF</i>	Y	Y	Y	Y	Y	—
102	1102	Enable input OFF	<i>EN OFF</i>	Y	Y	Y	Y	Y	—
105	1105	Braking transistor broken	<i>DBAL</i>	Y	Y	Y	Y	Y	H98
111	1111	Customizable logic output signal 1	<i>CLO1</i>	Y	Y	Y	Y	Y	<u>U71 to U75</u> , <u>U81 to U85</u>
112	1112	Customizable logic output signal 2	<i>CLO2</i>	Y	Y	Y	Y	Y	
113	1113	Customizable logic output signal 3	<i>CLO3</i>	Y	Y	Y	Y	Y	
114	1114	Customizable logic output signal 4	<i>CLO4</i>	Y	Y	Y	Y	Y	
115	1115	Customizable logic output signal 5	<i>CLO5</i>	Y	Y	Y	Y	Y	

 Any negative logic (Active OFF) command cannot be assigned to the functions marked with "—" in the "Active OFF" column.

E codes

- Inverter running -- **RUN** (Function code data = 0)
Inverter output on -- **RUN2** (Function code data = 35)

These output signals tell the external equipment that the inverter is running at a starting frequency or higher. If assigned in negative logic (Active OFF), these signals can be used to tell the "Inverter being stopped" state.

Output signal	Basic function	Remarks
RUN	These signals come ON when the inverter is running. Under V/f control:	Goes OFF even during DC braking or dew condensation prevention.
RUN2	These signals come ON if the inverter output frequency exceeds the starting frequency, and go OFF if it drops below the stop frequency. The RUN signal can also be used as a "Speed valid" signal DNZS .	Comes ON even during DC braking, pre-exciting, zero speed control, or dew condensation prevention.

Under vector control, both **RUN** and **RUN2** come ON when zero speed control or servo-lock function is enabled.

- Undervoltage detected (Inverter stopped) -- **LU** (Function code data = 3)

This output signal comes ON when the DC link bus voltage of the inverter drops below the specified undervoltage level, and it goes OFF when the voltage exceeds the level.

This signal is ON also when the undervoltage protective function is activated so that the motor is in an abnormal stop state (e.g., tripped).

When this signal is ON, a run command is disabled if given.

- Torque polarity detected -- **B/D** (Function code data = 4)

The inverter issues the driving or braking polarity signal to this digital output judging from the internally calculated torque or torque command. This signal goes OFF when the detected torque is a driving one, and it goes ON when it is a braking one.

- Inverter output limiting -- **IOL** (Function code data = 5)
Inverter output limiting with delay -- **IOL2** (Function code data = 22)

The output signal **IOL** comes ON when the inverter is limiting the output frequency by activating any of the following actions (minimum width of the output signal: 100 ms). The output signal **IOL2** comes ON when any of the following output limiting operation continues for 20 ms or more.

- Torque limiting (F40, F41, E16 and E17, Maximum internal value)
- Current limiting by software (F43 and F44)
- Instantaneous overcurrent limiting by hardware (H12 = 1)
- Automatic deceleration (Anti-regenerative control) (H69)

Note When the **IOL** signal is ON, it may mean that the output frequency may have deviated from the frequency specified by the frequency command because of this limiting function.

- Keypad operation enabled -- **KP** (Function code data = 8)

This output signal comes ON when the keypad is specified as a run command source.

- Inverter ready to run -- **RDY** (Function code data = 10)

This output signal comes ON when the inverter becomes ready to run by completing hardware preparation (such as initial charging of DC link bus capacitors and initialization of the control circuit) and no protective functions are activated.

- Select **AX** terminal function -- **AX** (Function code data = 15)

In response to a run command **FWD**, this output signal controls the magnetic contactor on the commercial-power supply side. It comes ON when the inverter receives a run command and it goes OFF after the motor decelerates to stop with a stop command received.

This signal immediately goes OFF upon receipt of a coast-to-stop command or when an alarm occurs.

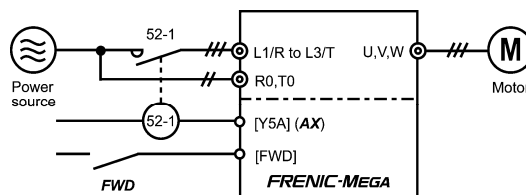

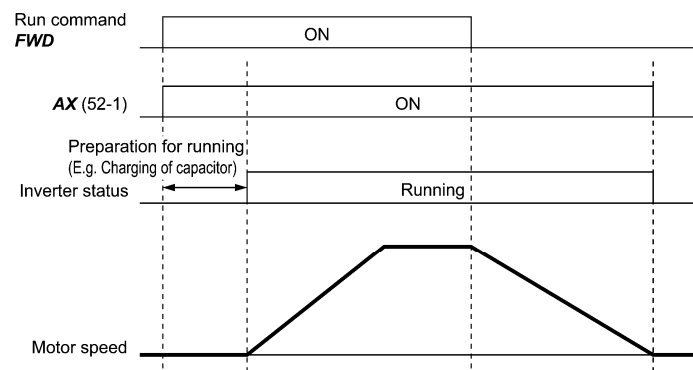

■ **Universal DO -- U-DO (Function code data = 27)**

Assigning this output signal to an inverter's output terminal and connecting the terminal to a digital input terminal of peripheral equipment via the RS-485 communications link or the fieldbus, allows the inverter to send commands to the peripheral equipment.

The universal DO can also be used as an output signal independent of the inverter operation.

For the procedure for access to Universal DO via the RS-485 communications link or fieldbus, refer to the respective instruction manual.

■ **Heat sink overheat early warning -- OH (Function code data = 28)**

This output signal is used to issue a heat sink overheat early warning that enables you to take a corrective action before an overheat trip actually happens.

This signal comes ON when the temperature of the heat sink exceeds the "overheat trip temperature minus 5°C (41°F)," and it goes OFF when it drops down to the "overheat trip temperature minus 8°C (46°F)."

This signal comes ON also when the internal air circulation DC fan (75 HP or above for 230 V series or 125 HP or above for 460 V series) has locked.

■ **Synchronization completed -- SY (Function code data = 29)**

This output signal comes ON when the control target comes inside the synchronization completion detection angle in synchronous running.

For details about synchronous operation, refer to the PG Interface Card instruction manual.

■ **Lifetime alarm -- LIFE (Function code data = 30)**

This output signal comes ON when it is judged that the service life of any one of capacitors (DC link bus capacitors and electrolytic capacitors on the printed circuit boards) and cooling fan has expired.

This signal should be used as a guide for replacement of the capacitors and cooling fan. If this signal comes ON, use the specified maintenance procedure to check the service life of these parts and determine whether the parts should be replaced or not. (Refer to Chapter 7, Section 7.3 "List of Periodic Replacement Parts.")

This signal comes ON also when the internal air circulation DC fan (75 HP or above for 230 V series or 125 HP or above for 460 V series) has locked.

■ **Under PID control -- PID-CTL (Function code data = 43)**

This output signal comes ON when PID control is enabled ("Cancel PID control" (H_z/PID) = OFF) and a run command is ON. (Refer to the description of J01.)

Note When PID control is enabled, the inverter may stop due to the slow flowrate stopping function or other reasons, with the **PID-CTL** signal being ON. As long as the **PID-CTL** signal is ON, PID control is effective, so the inverter may abruptly resume its operation, depending on the feedback value in PID control.

WARNING
<p>When PID control is enabled, even if the inverter stops its output during operation because of sensor signals or other reasons, operation will resume automatically. Design your machinery so that safety is ensured even in such cases.</p> <p>Otherwise, an accident could occur.</p>

- Running forward -- **FRUN** (Function code data = 52)
Running reverse -- **RRUN** (Function code data = 53)

Output signal	Assigned data	Running forward	Running reverse	Inverter stopped
FRUN	52	ON	OFF	OFF
RRUN	53	OFF	ON	OFF

- In remote operation -- **RMT** (Function code data = 54)

This output signal comes ON when the inverter switches from local to remote mode.

For details of switching between remote and local modes, refer to Chapter 4, Section 4.2.2 "Remote and local modes."

- Terminal [C1] wire break -- **C1OFF** (Function code data = 59)

This output signal comes ON when the inverter detects that the input current to terminal [C1] drops below 2 mA interpreting it as the terminal [C1] wire broken.

- Speed valid -- **DNZS** (Function code data = 70)

This output signal comes ON when the reference speed or detected one exceeds the stop frequency specified by function code F25. It goes OFF when the speed is below the stop frequency for 100 ms or longer.

Under vector control with speed sensor, F38 switches the decision criterion between the reference speed and detected one. Under vector control without speed sensor, the reference speed is used as a decision criterion. (Refer to the descriptions of F25 and F38.)

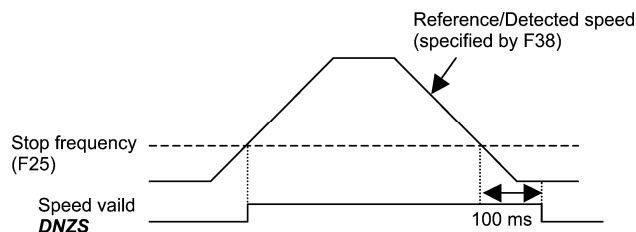

- Alarm output (for any alarm) -- **ALM** (Function code data = 99)

This output signal comes ON if any of the protective functions is activated and the inverter enters Alarm mode.

- Enable circuit failure detected -- **DECF** (Function code data = 101)

This output signal comes ON when the inverter detects a failure of the Enable circuit.

(Refer to Chapter 6 "TROUBLESHOOTING.")

- Enable input OFF -- **EN OFF** (Function code data = 102)

This output signal comes ON when the terminal [EN] input is turned OFF.

- Braking transistor broken -- **DBAL** (Function code data = 105)

If the inverter detects a breakdown of the braking transistor, it issues the braking transistor alarm (*dbt*) and also the output signal **DBAL**. Detection of braking transistor broken can be cancelled by H98. (40 HP or below)

(Refer to the description of H98.)

Note Breakdown of the braking transistor could lead to the secondary breakdown of the braking resistor and inverter's internal units. Use this output signal **DBAL** to detect abnormal operation of the built-in braking transistor and to cut off power to the magnetic contactor in inverter primary circuits, for preventing spread of the damage.

E30 Frequency Arrival (Hysteresis width)

E30 specifies the detection level (hysteresis width) for the "Frequency (speed) arrival signal" **FAR** and the "Frequency (speed) arrival signal 3" **FAR3**.

Output signal	Data assigned to output terminal	Operating condition 1	Operating condition 2
Frequency (speed) arrival signal FAR	1	Both signals come ON when the difference between the output frequency (estimated/detected speed) and the reference frequency (reference speed) comes within the frequency arrival hysteresis width specified by E30.	FAR always goes OFF when the run command is OFF or the reference speed is "0."
Frequency (speed) arrival signal 3 FAR3	72		When the run command is OFF, the inverter regards the reference speed as "0," so FAR3 comes ON as long as the output frequency (estimated/detected speed) is within the range of "0 ± the frequency arrival hysteresis width specified by E30."

- Data setting range: 0.0 to 10.0 (Hz)

The operation timings of each signal are shown below.

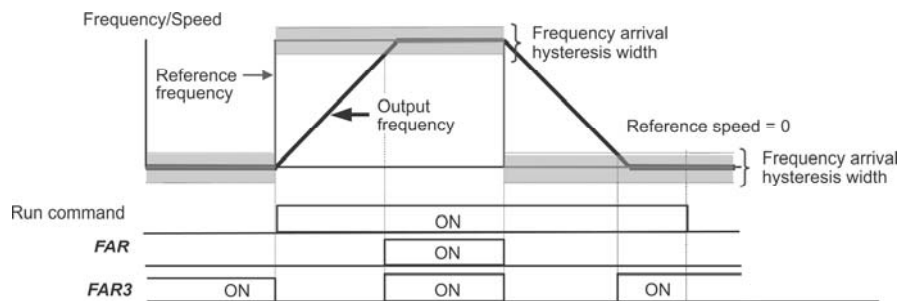

E31, E32 Frequency Detection (Level and Hysteresis width) E36, E54 (Frequency Detection 2 and 3 (Level))

When the output frequency (estimated/detected speed) exceeds the frequency detection level specified by E31, the "Frequency (speed) detected signal" comes ON; when it drops below the "Frequency detection level minus Hysteresis width specified by E32," it goes OFF.

The following three settings are available.

Output signal	Data assigned to output terminal	Operation level	Hysteresis width
		Range: 0.0 to 500.0 Hz	Range: 0.0 to 500.0 Hz
Frequency (speed) detected signal FDT	2	E31	E32
Frequency (speed) detected signal 2 FDT2	31	E36	
Frequency (speed) detected signal 3 FDT3	58	E54	

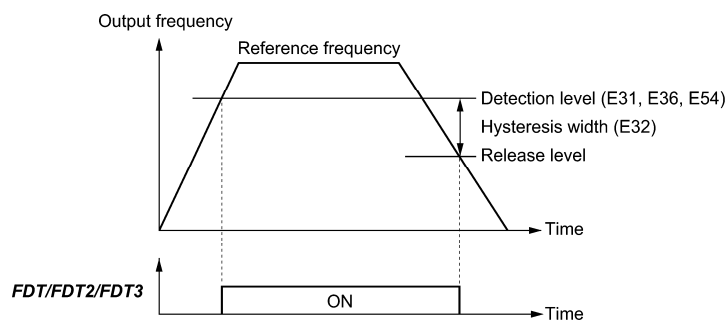

E codes

E34, E35 Overload Early Warning/Current Detection (Level and Timer)

E37, F38 (Current Detection 2/Low Current Detection (Level and Timer))
E55, E56 (Current Detection 3 (Level and Timer))

These function codes define the detection level and time for the "Motor overload early warning" **OL**, "Current detected" **ID**, "Current detected 2" **ID2**, "Current detected 3" **ID3**, and "Low current detected" **IDL** output signals.

Output signal	Data assigned to output terminal	Operation level	Timer	Motor characteristics	Thermal time constant
		Range: See below	Range: 0.01 to 600.00 s	Range: See below	Range: 0.5 to 75.0 min
OL	7	E34	-	F10	F12
ID	37	E34	E35	-	-
ID2	38	E37	E38		
ID3	39	E55	E56		
IDL	41	E37	E38		

- Data setting range

Operation level: 0.00 (Disable), 1 to 200% of inverter rated current

Motor characteristics 1: Enable (For a general-purpose motor with shaft-driven cooling fan)

2: Enable (For an inverter-driven motor, non-ventilated motor, or motor with separately powered cooling fan)

■ Motor overload early warning signal -- **OL**

The **OL** signal is used to detect a symptom of an overload condition (alarm code \overline{OL} /) of the motor so that the user can take an appropriate action before the alarm actually happens.

The **OL** signal turns ON when the inverter output current exceeds the level specified by E34. In typical cases, set E34 data to 80 to 90% against F11 data (Electronic thermal overload protection for motor 1, Overload detection level). Specify also the thermal characteristics of the motor with F10 (Select motor characteristics) and F12 (Thermal time constant).

■ Current detected, Current detected 2 and Current detected 3 -- **ID**, **ID2** and **ID3**

When the inverter output current exceeds the level specified by E34, E37 or E55 for the period specified by E35, E38 or E56, the **ID**, **ID2** or **ID3** signal turns ON, respectively. When the output current drops below 90% of the rated operation level, the **ID**, **ID2** or **ID3** turns OFF. (The minimum ON-duration is 100 ms.)

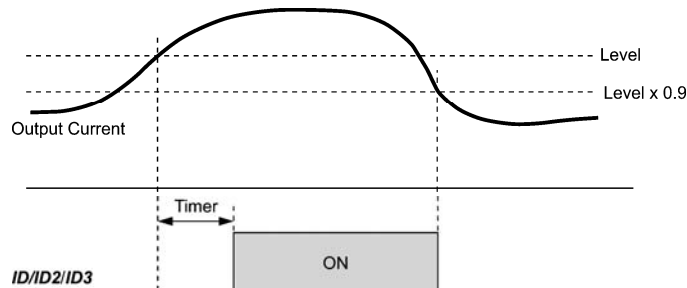

■ Low current detected -- **IDL**

This signal turns ON when the output current drops below the level specified by E37 (Low current detection, Level) for the period specified by E38 (Timer). When the output current exceeds the "Low current detection level plus 5% of the inverter rated current," it goes OFF. (The minimum ON-duration is 100 ms.)

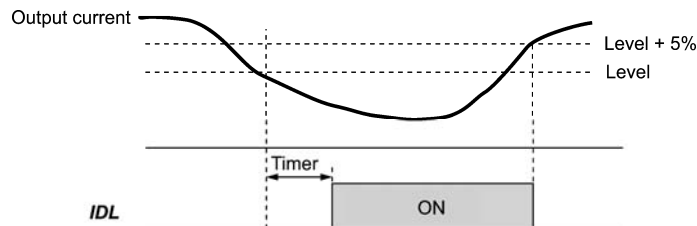

E36 **Frequency Detection 2** (Refer to E31.)

E37, E38 **Current Detection 2/Low Current Detection (Level and Timer)** (Refer to E34.)

E40, E41 **PID Display Coefficient A, B**

These function codes specify PID display coefficients A and B to convert a PID command (process command or dancer position command) and its feedback into mnemonic physical quantities to display.

- Data setting range: -999 to 0.00 to 9990 for PID display coefficients A and B

■ **Display coefficients for PID process command and its feedback (J01 = 1 or 2)**

E40 specifies coefficient A that determines the display value at 100% of the PID process command or its feedback, and E41 specifies coefficient B that determines the display value at 0%.

The display value is determined as follows:

$$\text{Display value} = (\text{PID process command or its feedback (\%)} / 100) \times (\text{Display coefficient A} - \text{B}) + \text{B}$$

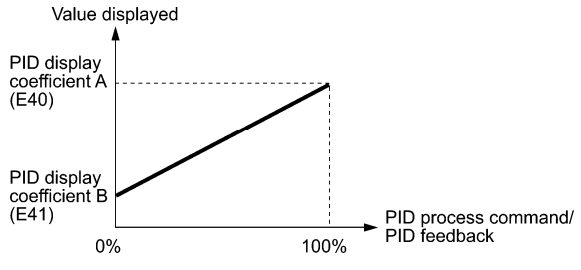

Example

Maintaining the pressure around 16 kPa (sensor voltage 3.13 V) while the pressure sensor can detect 0 to 30 kPa over the output voltage range of 1 to 5 V:

Select terminal [12] as a feedback terminal and set the gain to 200% so that 5 V corresponds to 100%.

The following E40 and E41 settings allow you to monitor or specify the values of the PID process command and its feedback on the keypad as pressure.

PID display coefficient A (E40) = 30.0, that determines the display value at 100% of PID process command or its feedback

PID display coefficient B (E41) = -7.5, that determines the display value at 0% of PID process command or its feedback

To control the pressure at 16 kPa on the keypad, set the value to 16.0.

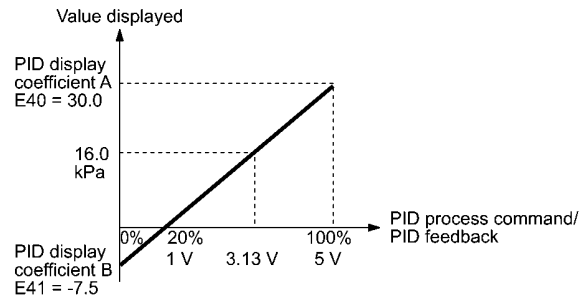

E codes

■ Display coefficients for PID dancer position command and its feedback (J01 = 3)

Under PID dancer control, the PID command and its feedback operate within the range $\pm 100\%$, so specify the value at $+100\%$ of the PID dancer position command or its feedback as coefficient A with E40, and the value at -100% as coefficient B with E41.

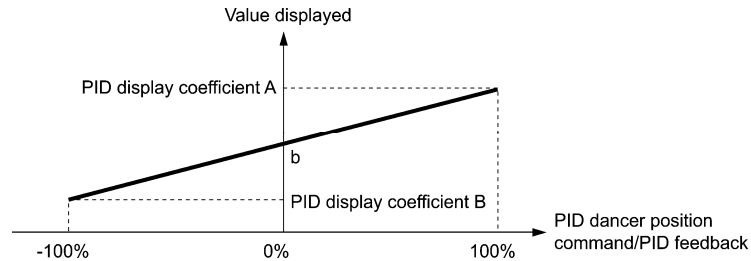

If the sensor output is unipolar, the PID dancer control operates within the range from 0 to $+100\%$, so virtually specify the value at -100% as coefficient B.

That is, suppose "b" = "Display value at 0%," then:

$$\text{Display coefficient B} = 2b - A$$

For details about the PID control, refer to the description of J01 and later.

For the display method of the PID command and its feedback, refer to the description of E43.

■ Display coefficient for analog input monitor

By inputting analog signals from various sensors such as temperature sensors in air conditioners to the inverter, you can monitor the state of peripheral devices via the communications link. By using an appropriate display coefficient, you can also have various values converted into physical values such as temperature and pressure before they are displayed.

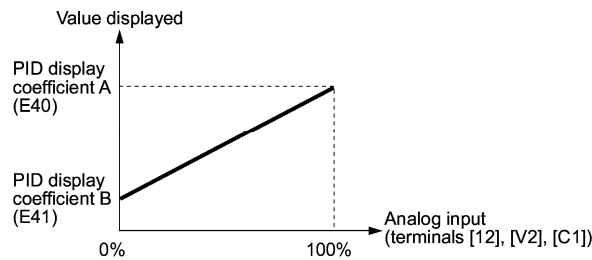

To set up the analog input monitor, use function codes E61 through E63. Use E43 to choose the item to be displayed.

E42 LED Display Filter

E42 specifies a filter time constant to be applied for displaying the monitored running status except the speed monitor (E43 = 0) on the LED monitor on the keypad. If the display varies unstably so as to be hard to read due to load fluctuation or other causes, increase this filter time constant.

- Data setting range: 0.0 to 5.0 (s)

E43 specifies the running status item to be monitored and displayed on the LED monitor.

Specifying the speed monitor with E43 provides a choice of speed-monitoring formats selectable with E48 (LED Monitor).

Monitor item	Display sample on the LED monitor	Unit	Meaning of displayed value	Function code data for E43
Speed monitor	Function code E48 specifies what to be displayed on the LED monitor.			0
Output frequency 1 (before slip compensation)	50.00	Hz	Frequency actually being output	(E48 = 0)
Output frequency 2 (after slip compensation)	50.00	Hz	Frequency actually being output	(E48 = 1)
Reference frequency	50.00	Hz	Reference frequency being specified	(E48 = 2)
Motor speed	1500	r/min	Output frequency (Hz) $\times \frac{120}{P01}$	(E48 = 3)
Load shaft speed	300.0	r/min	Output frequency (Hz) $\times E50$	(E48 = 4)
Line speed	300.0	m/min	Output frequency (Hz) $\times E50$	(E48 = 5)
Display speed (%)	50.0	%	$\frac{\text{Output frequency}}{\text{Maximum frequency}} \times 100$	(E48 = 7)
Output current	12.34	A	Current output from the inverter in RMS	3
Output voltage	200	V	Voltage output from the inverter in RMS	4
Calculated torque	50	%	Motor output torque in % (Calculated value)	8
Input power	10.25	kW	Input power to the inverter	9
PID command	10.00	—	PID command/feedback amount transformed to that of virtual physical value of the object to be controlled (e.g. temperature)	10
PID feedback amount	9.00	—		Refer to function codes E40 and E41 for details.
PID output	100.0	%	PID output in % as the maximum frequency being at 100%	14
Load factor	50	%	Load factor of the motor in % as the rated output being at 100%	15
Motor output	9.85	kW	Motor output in kW	16
Analog input	82.00	—	An analog input to the inverter in a format suitable for a desired scale. Refer to function codes E40 and E41 for details.	17
Torque current	48	%	Torque current command value or calculated torque current	23
Magnetic flux command	50	%	Magnetic flux command value (Available only under vector control)	24
Input watt-hour	100.0	kWh	$\frac{\text{Input watt-hour (kWh)}}{100}$	25

E44 LED Monitor (Display when stopped)

E44 specifies whether the specified value (data = 0) or the output value (data = 1) to be displayed on the LED monitor of the keypad when the inverter is stopped. The monitored item depends on the E48 (LED monitor, Speed monitor item) setting as shown below.

Data for E48	Monitored item	What to be displayed when the inverter stopped	
		E44 = 0 (Specified value)	E44 = 1 (Output value)
0	Output frequency 1 (before slip compensation)	Reference frequency	Output frequency 1 (before slip compensation)
1	Output frequency 2 (after slip compensation)	Reference frequency	Output frequency 2 (after slip compensation)
2	Reference frequency	Reference frequency	Reference frequency
3	Motor speed	Reference motor speed	Motor speed
4	Load shaft speed	Reference load shaft speed	Load shaft speed
5	Line speed	Reference line speed	Line speed
7	Display speed (%)	Reference display speed	Display Speed

E45 LCD Monitor (Item selection)

E45 specifies the LCD monitor display mode to be applied when the inverter is in Running mode.

Data for E45	Function
0	Running status, rotational direction and operation guide
1	Bar charts for output frequency, current and calculated torque

Example of display for E45 = 0 (during running)

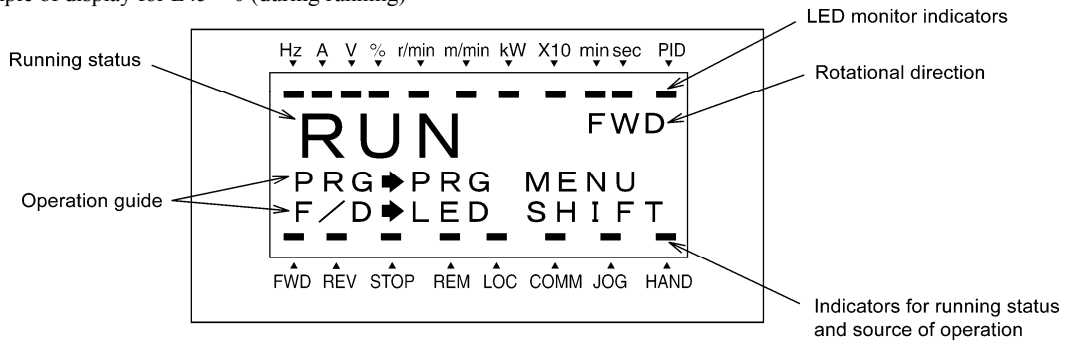

Example of display for E45 = 1 (during running)

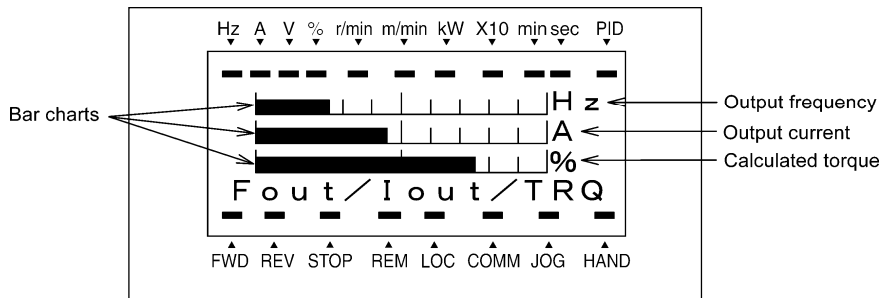

Full-scale values on bar charts

Item displayed	Full scale
Output frequency	Maximum frequency
Output current	Inverter rated current × 200%
Calculated torque	Motor rated torque × 200%

E46 LCD Monitor (Language selection)

E46 specifies the language to display on the keypad (TP-G1W-J1) as follows:

Data for E46	Language
0	Japanese
1	English
2	German
3	French
4	Spanish
5	Italian

E47 LCD Monitor (Contrast control)

E47 adjusts the contrast of the LCD monitor on the keypad as follows:

Data for E47	0, 1, 2, 3, 4, 5, 6, 7, 8, 9, 10
Contrast	Low ←————→ High

E48 LED Monitor (Speed monitor item)

(Refer to E43.)

E50 Coefficient for Speed Indication

E50 specifies the coefficient that is used when the load shaft speed or line speed is displayed on the LED monitor. (Refer to the description of E43.)

$$\text{Load shaft speed (r/min)} = (\text{E50: Coefficient for speed indication}) \times (\text{Output frequency Hz})$$

$$\text{Line speed (m/min)} = (\text{E50: Coefficient for speed indication}) \times (\text{Output frequency Hz})$$

- Data setting range: 0.01 to 200.00

E51 Display Coefficient for Input Watt-hour Data

E51 specifies a display coefficient (multiplication factor) for displaying the input watt-hour data ($\overline{5}$ $\overline{7}$) in a part of maintenance information on the keypad.

$$\text{Input watt-hour data} = \text{Display coefficient (E51 data)} \times \text{Input watt-hour (kWh)}$$

- Data setting range: 0.000 (cancel/reset); 0.001 to 9999

Note Setting E51 data to 0.000 clears the input watt-hour and its data to "0." After clearing, be sure to restore E51 data to the previous value; otherwise, input watt-hour data will not be accumulated.

E codes

E52 Keypad (Menu display mode)

E52 provides a choice of three menu display modes for the remote keypad TP-E1U (option) as listed below.

Data for E52	Menu display mode	Menus to be displayed
0	Function code data editing mode	Menus #0, #1 and #7
1	Function code data check mode	Menus #2 and #7
2	Full-menu mode	Menus #0 through #7

The menus available on the remote keypad TP-E1U (option) are described below

Menu #	Menu	LED monitor shows:	Main functions
0	"Quick Setup"	<i>Q.F.F.C</i>	Displays only basic function codes to customize the inverter operation.
1	"Data Setting"	<i>f_ _</i>	F codes (Fundamental functions)
		<i>e_ _</i>	E codes (Extension terminal functions)
		<i>c_ _</i>	C codes (Control functions)
		<i>p_ _</i>	P codes (Motor 1 parameters)
		<i>h_ _</i>	H codes (High performance functions)
		<i>a_ _</i>	A codes (Motor 2 parameters)
		<i>b_ _</i>	b codes (Motor 3 parameters)
		<i>r_ _</i>	r codes (Motor 4 parameters)
		<i>j_ _</i>	J codes (Application functions 1)
		<i>d_ _</i>	d codes (Application functions 2)
		<i>u_ _</i>	U codes (Application functions 3)
		<i>y_ _</i>	y codes (Link functions)
		<i>o_ _</i>	o codes (Optional function)
			Selecting each of these function codes enables its data to be displayed/changed.
2	"Data Checking"	<i>2.r.E.P</i>	Displays only function codes that have been changed from their factory defaults. You can refer to or change those function code data.
3	"Drive Monitoring"	<i>3.o.P.E</i>	Displays the running information required for maintenance or test running.
4	"I/O Checking"	<i>4.i.o</i>	Displays external interface information.
5	"Maintenance Information"	<i>5.M.H.E</i>	Displays maintenance information including cumulative run time.
6	"Alarm Information"	<i>6.A.L</i>	Displays the recent four alarm codes. You can refer to the running information at the time when the alarm occurred.
7	"Data Copying"	<i>7.C.P.Y</i>	Allows you to read or write function code data, as well as verifying it.

E54 **Frequency Detection 3 (Level)** (Refer to E31.)

E55, E56 **Current Detection 3 (Level, Timer)** (Refer to E34.)

E61 to E63 Terminal [12] Extended Function
Terminal [C1] Extended Function
Terminal [V2] Extended Function

E61, E62, and E63 define the function of the terminals [12], [C1], and [V2], respectively.

There is no need to set up these terminals if they are to be used for frequency command sources.

Data for E61, E62, or E63	Input assigned to [12], [C1] and [V2]:	Description
0	None	—
1	Auxiliary frequency command 1	Auxiliary frequency input to be added to the reference frequency given by frequency command 1 (F01). This is not added to any other reference frequencies given by frequency command 2 and multi-frequency commands, etc.
2	Auxiliary frequency command 2	Auxiliary frequency input to be added to all reference frequencies given by frequency command 1, frequency command 2, multi-frequency commands, etc.
3	PID command 1	Command sources such as temperature and pressure under PID control. It is also necessary to configure function code J02.
5	PID feedback amount	Feedback amounts such as temperature and pressure under PID control.
6	Ratio setting	This is used to multiply the final frequency command value by this value, for use in the constant line speed control by calculating the winder diameter or in ratio operation with multiple inverters.
7	Analog torque limit value A	This is used when analog inputs are used as torque limiters. (Refer to F40 (Torque Limiter 1-1).)
8	Analog torque limit value B	This is used when analog inputs are used as torque limiters. (Refer to F40 (Torque Limiter 1-1).)
10	Torque command	Analog inputs to be used as torque commands under torque control. (Refer to H18 (Torque Control).)
11	Torque current command	Analog inputs to be used as torque current commands under torque control. (Refer to H18 (Torque Control).)
20	Analog signal input monitor	By inputting analog signals from various sensors such as the temperature sensors in air conditioners to the inverter, you can monitor the state of external devices via the communications link. By using an appropriate display coefficient, you can also have various values to be converted into physical values such as temperature and pressure before they are displayed.

Note If these terminals have been set up to have the same data, the operation priority is given in the following order:
 E61 > E62 > E63

E64 Saving of Digital Reference Frequency

E codes

E64 specifies how to save the reference frequency specified in digital formats by the \wedge / \vee keys on the keypad as shown below.

Data for E64	Function
0	Automatic saving when the main power is turned OFF The reference frequency will be automatically saved when the main power is turned OFF. At the next power-on, the reference frequency at the time of the previous power-off applies.
1	Saving by pressing FUNC/DATA key Pressing the FUNC/DATA key saves the reference frequency. If the control power is turned OFF without pressing the FUNC/DATA key, the data will be lost. At the next power-ON, the inverter uses the reference frequency saved when the FUNC/DATA key was pressed last.

E65 Reference Loss Detection (Continuous running frequency)

When the analog frequency command (setting through terminal [12], [C1], or [V2]) has dropped below 10% of the reference frequency within 400 ms, the inverter presumes that the analog frequency command wire has been broken and continues its operation at the frequency determined by the ratio specified by E65 to the reference frequency. Refer to E20 through E24 and E27 (data = 33).

When the frequency command level (in voltage or current) returns to a level higher than that specified by E65, the inverter presumes that the broken wire has been fixed and continues to run following the frequency command.

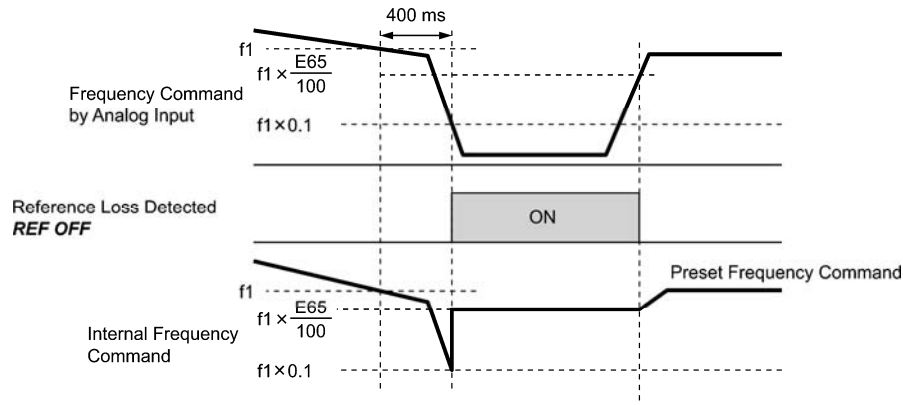

In the diagram above, f_1 is the level of the analog frequency command sampled at any given time. The sampling is repeated at regular intervals to continually monitor the wiring connection of the analog frequency command.

- Data setting range: 0 (Decelerate to stop), 20 to 120%, 999 (Disable)

Note Avoid an abrupt voltage or current change for the analog frequency command. An abrupt change may be interpreted as a wire break.

Setting E65 data at "999" (Disable) allows the **REF OFF** signal ("Reference loss detected") to be issued, but does not allow the reference frequency to change (the inverter runs at the analog frequency command as specified).

When E65 = "0" or "999," the reference frequency level at which the broken wire is recognized as fixed is " $f_1 \times 0.2$."

When E65 = "100" (%) or higher, the reference frequency level at which the wire is recognized as fixed is " $f_1 \times 1$."

The reference loss detection is not affected by the setting of analog input adjustment (filter time constants: C33, C38, and C43)

E78, E79 Torque Detection 1 (Level and Timer)

E80, E81 Torque Detection 2/Low Torque Detection (Level and Timer)

E78 specifies the operation level and E79 specifies the timer, for the output signal **TD1**. E80 specifies the operation level and E81 specifies the timer, for the output signal **TD2** or **U-TL**.

Output signal	Assigned data	Operation level	Timer
		Range: 0 to 300%	Range: 0.01 to 600.00 s
TD1	46	E78	E79
TD2	47	E80	E81
U-TL	45	E80	E81

■ Torque detected 1 -- **TD1**, Torque detected 2 -- **TD2**

The output signal **TD1** or **TD2** comes ON when the torque value calculated by the inverter or torque command exceeds the level specified by E78 or E80 (Torque detection (Level)) for the period specified by E79 or E81 (Torque detection (Timer)), respectively. The signal turns OFF when the calculated torque drops below "the level specified by E78 or E80 minus 5% of the motor rated torque." The minimum ON-duration is 100 ms.

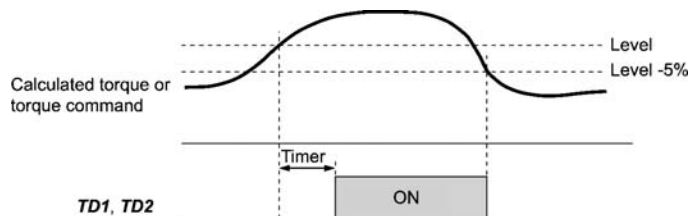

■ Low output torque detected--**U-TL**

This output signal comes ON when the torque value calculated by the inverter or torque command drops below the level specified by E80 (Low torque detection (Level)) for the period specified by E81 (Low torque detection (Timer)). The signal turns OFF when the calculated torque exceeds the "level specified by E80 plus 5% of the motor rated torque." The minimum ON-duration is 100 ms.

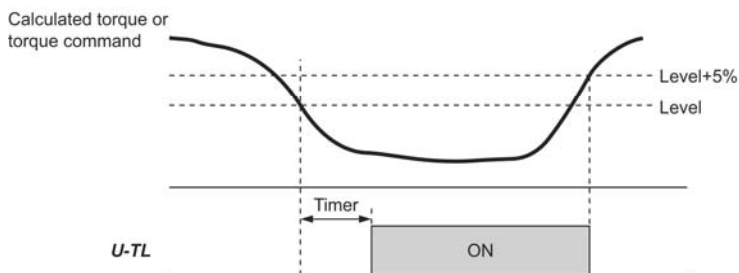

In the inverter's low frequency operation, as a substantial error in torque calculation occurs, no low torque can be detected within the operation range at less than 20% of the base frequency (F04). (In this case, the result of recognition before entering this operation range is retained.)

The **U-TL** signal goes off when the inverter is stopped.

Since the motor parameters are used in the calculation of torque, it is recommended that auto-tuning be applied by function code P04 to achieve higher accuracy.

E98, E99 Terminal [FWD] Function
Terminal [REV] Function

(Refer to E01 to E07.)

E codes

5.2.3 C codes (Control functions)

C01 to C03 Jump Frequency 1, 2 and 3 C04 Jump Frequency (Hysteresis width)

These function codes enable the inverter to jump over three different points on the output frequency in order to skip resonance caused by the motor speed and natural frequency of the driven machinery (load).

- While you are increasing the reference frequency, the moment the reference frequency reaches the bottom of the jump frequency band, the inverter keeps the output at that bottom frequency. When the reference frequency exceeds the upper limit of the jump frequency band, the internal reference frequency takes on the value of the reference frequency. When you are decreasing the reference frequency, the situation will be reversed.
- When more than two jump frequency bands overlap, the inverter actually takes the lowest frequency within the overlapped bands as the bottom frequency and the highest as the upper limit. Refer to the figure on the lower right.

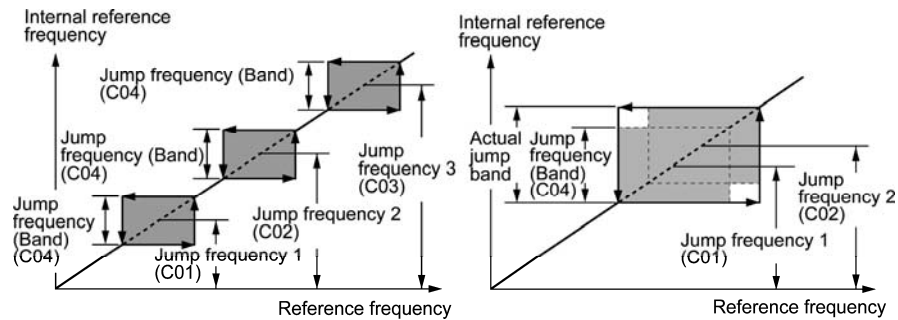

■ Jump frequencies 1, 2 and 3 (C01, C02 and C03) Data setting range: 0.0 to 500.0 (Hz)
Specify the center of the jump frequency band. (Setting to 0.0 results in no jump frequency band.)

■ Jump frequency hysteresis width (C04) Data setting range: 0.0 to 30.0 (Hz)
Specify the jump frequency hysteresis width. (Setting to 0.0 results in no jump frequency band.)

C05 to C19 Multi-frequency 1 to 15

■ These function codes specify 15 frequencies required for driving the motor at frequencies 1 to 15.

Turning terminal commands *SS1*, *SS2*, *SS4* and *SS8* ON/OFF selectively switches the reference frequency of the inverter in 15 steps. To use these features, you need to assign *SS1*, *SS2*, *SS4* and *SS8* ("Select multi-frequency") to the digital input terminals with C05 to C19 (data = 0, 1, 2, and 3).

■ Multi-frequency 1 to 15 (C05 through C19) Data setting range: 0.00 to 500.00 (Hz)

The combination of *SSI*, *SS2*, *SS4* and *SS8* and the selected frequencies are as follows.

<i>SS8</i>	<i>SS4</i>	<i>SS2</i>	<i>SSI</i>	Selected frequency command
OFF	OFF	OFF	OFF	Other than multi-frequency *
OFF	OFF	OFF	ON	C05 (multi-frequency 1)
OFF	OFF	ON	OFF	C06 (multi-frequency 2)
OFF	OFF	ON	ON	C07 (multi-frequency 3)
OFF	ON	OFF	OFF	C08 (multi-frequency 4)
OFF	ON	OFF	ON	C09 (multi-frequency 5)
OFF	ON	ON	OFF	C10 (multi-frequency 6)
OFF	ON	ON	ON	C11 (multi-frequency 7)
ON	OFF	OFF	OFF	C12 (multi-frequency 8)
ON	OFF	OFF	ON	C13 (multi-frequency 9)
ON	OFF	ON	OFF	C14 (multi-frequency 10)
ON	OFF	ON	ON	C15 (multi-frequency 11)
ON	ON	OFF	OFF	C16 (multi-frequency 12)
ON	ON	OFF	ON	C17 (multi-frequency 13)
ON	ON	ON	OFF	C18 (multi-frequency 14)
ON	ON	ON	ON	C19 (multi-frequency 15)

* "Other than multi-frequency" includes frequency command 1 (F01), frequency command 2 (C30) and other command sources except multi-frequency commands.

■ When enabling PID control (J01 = 1, 2, or 3)

Under the PID control, a multi-frequency command can be specified as a preset value (3 different frequencies). It can also be used for a manual speed command even with the PID control being canceled (*Hz/PID* = ON) or for a primary reference frequency under the PID dancer control.

• PID command

<i>SS8</i>	<i>SS4</i>	<i>SSI, SS2</i>	Command
OFF	OFF	–	Command specified by J02
OFF	ON	–	Multi-frequency by C08
ON	OFF	–	Multi-frequency by C12
ON	ON	–	Multi-frequency by C16

C08, C12, and C16 can be specified in increments of 1 Hz. The following gives the conversion formula between the PID command value and the data to be specified.

$$\text{Data to be specified} = \text{PID command (\%)} \times \text{Maximum frequency (F03)} \div 100$$

$$\text{PID command (\%)} = \frac{\text{Data to be specified (C08, C12, C16)}}{\text{Maximum frequency (F03)}} \times 100$$

• Manual speed command

<i>SS8, SS4</i>	<i>SS2</i>	<i>SSI</i>	Selected frequency command
–	OFF	OFF	Other than multi-frequency
–	OFF	ON	C05 (Multi-frequency 1)
–	ON	OFF	C06 (Multi-frequency 2)
–	ON	ON	C07 (Multi-frequency 3)



C codes

C20 Jogging FrequencyH54, H55 (Acceleration/Deceleration Time, Jogging)
d09 to d13 (Speed Control (Jogging))

To jog or inch the motor for positioning a workpiece, specify the jogging conditions using the jogging-related function codes (C20, H54, H55, and d09 through d13) beforehand, make the inverter ready for jogging, and then enter a run command.



■ Making the inverter ready for jogging



Turning ON the "Ready for jogging" terminal command **JOG** (Function code data = 10) readies the inverter for jogging.

Pressing the  +  keys" simultaneously in Running mode also readies the inverter for jogging (when the run command source is "Keypad" (F02 = 0, 2 or 3)). Pressing these keys toggles between "ready for jogging" and "normal operation."

 Switching between the normal operation state and ready-to-jog state is possible only when the inverter is stopped.

■ Starting jogging

Holding down the  or  key or turning the input terminal command **FWD** or **REV** ON jogs the motor.

In jogging with the  or  key, the inverter jogs only when the key is held down. Releasing the key decelerates the motor to a stop.

 To start jogging operation by simultaneously entering the **JOG** terminal command and a run command (e.g., **FWD**), the input delay time between the two commands should be within 100 ms. If a run command **FWD** is entered first, the inverter does not jog the motor but runs it ordinarily until the next input of the **JOG**.

The jogging conditions should be specified beforehand using the following function codes.

Function code	Data setting range	Description
C20	Jogging Frequency	0.00 to 500.00 Hz
H54	Acceleration Time (Jogging)	0.00 to 6000 s
H55	Deceleration Time (Jogging)	0.00 to 6000 s
d09	Speed Control (Jogging) (Speed command filter)	0.000 to 5.000 s
d10	Speed Control (Jogging) (Speed detection filter)	0.000 to 0.100 s
d11	Speed Control (Jogging) P (Gain)	0.1 to 200.0 times
d12	Speed Control (Jogging) I (Integral time)	0.001 to 9.999 s
d13	Speed Control (Jogging) (Output filter)	0.000 to 0.100 s

Modification items related to speed control for jogging operation under vector control without/with speed sensor
For adjustments, refer to the descriptions of d01 to d06.

C30 Frequency Command 2

(Refer to F01.)

C31 to C35 Analog Input Adjustment for [12] (Offset, Gain, Filter time constant, Gain base point, Polarity)

C36 to C39 Analog Input Adjustment for [C1] (Offset, Gain, Filter time constant, Gain base point)

C41 to C45 Analog Input Adjustment for [V2] (Offset, Gain, Filter time constant, Gain base point, Polarity)

(For details about the frequency command, refer to F01 (Frequency Command 1).)

Setting up a reference frequency using analog input

You can adjust the gain, polarity, filter time constant, and offset which are applied to analog inputs (voltage inputs to terminals [12] and [V2], and current input to terminal [C1])

Adjustable items for analog inputs

Input terminal	Input range	Gain		Polarity	Filter time constant	Offset
		Gain	Base point			
[12]	0 to +10 V, -10 to +10 V	C32	C34	C35	C33	C31
[C1]	4 to 20 mA	C37	C39	—	C38	C36
[V2]	0 to +10 V, -10 to +10 V	C42	C44	C45	C43	C41

■ **Offset (C31, C36, C41)** Data setting range: -5.0 to +5.0 (%)

C31, C36 or C41 configures an offset for an analog voltage/current input. The offset also applies to signals sent from the external equipment.

■ **Filter time constant (C33, C38, C43)** Data setting range: 0.00 to 5.00 (s)

C33, C38 or C43 configures a filter time constant for an analog voltage/current input. The larger the time constant, the slower the response. Specify the proper filter time constant taking into account the response speed of the machine (load). If the input voltage fluctuates due to line noises, increase the time constant.

■ **Polarity (C35, C45)**

C35 and C45 configure the input range for analog input voltage.

Data for C35 and C45	Specifications for terminal inputs
0	-10 to +10 V
1	0 to +10 V (A minus component of the input will be regarded as 0 VDC.)

■ **Gain**

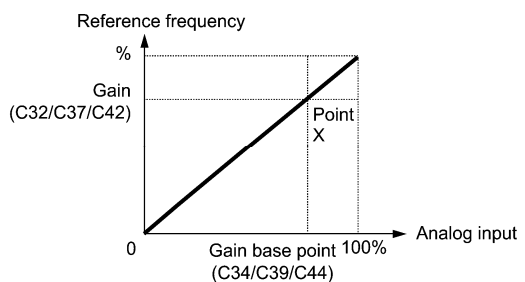

Note To input bipolar analog voltage (0 to ± 10 VDC) to terminals [12] and [V2], set C35 and C45 data to "0." Setting C35 and C45 data to "1" enables the voltage range from 0 to +10 VDC and interprets the negative polarity input from 0 to -10 VDC as 0 V.

C50 Bias (Frequency command 1) (Bias base point) (Refer to F01.)

C51, C52 Bias (PID command 1) (Bias value and Bias base point)

These function codes (and the gain-related function codes) specify the gain and bias of the analog PID command 1, enabling it to define arbitrary relationship between the analog input and PID commands.

Note The actual setting is the same as that of F18. For details, refer to F18 given in the description of F01.

Note Gain-related function codes C32, C34, C37, C39, C42, and C44 are shared by frequency commands.

- **Bias value (C51)** Data setting range: -100.00 to 100.00 (%)
- **Bias base point (C52)** Data setting range: 0.00 to 100.00 (%)

C codes

C53 Selection of Normal/Inverse Operation (Frequency command 1) (Refer to E01 to E07.)

5.2.4 P codes (Motor 1 Parameters)

The FRENIC-MEGA drives the motor under V/f control, dynamic torque vector control, V/f control with speed sensor, dynamic torque vector control with speed sensor, vector control without speed sensor, or vector control with speed sensor, which can be selected with function codes.

To use the integrated automatic control functions such as auto torque boost, torque calculation monitoring, auto-energy saving operation, torque limiter, automatic deceleration (anti-regenerative control), auto search for idling motor speed, slip compensation, torque vector control, droop control, and overload stop, it is necessary to build a motor model in the inverter by specifying proper motor parameters including the motor capacity and rated current.

The FRENIC-MEGA provides built-in motor parameters for HP rating motors. To use these motors, it is enough to specify motor parameters for P99 (Motor 1 Selection). If the cabling between the inverter and the motor is long (generally, 66 ft (20 m) or longer) or a reactor is inserted between the motor and the inverter, however, the apparent motor parameters are different from the actual ones, so auto-tuning or other adjustments are necessary. For the auto-tuning procedure, refer to Chapter 4 "RUNNING THE MOTOR."

When using a motor made by other manufacturers or a non-standard motor, obtain the datasheet of the motor and specify the motor parameters manually or perform auto-tuning.

To specify the motor parameters correctly, select the motor type with P99 (Motor 1 Selection), specify the motor rated capacity with P02, and then initialize the motor parameters with H03. This procedure also applies when the inverter is switched to the MD/HD mode and a motor with one or two ranks lower capacity is used. When switching the motor between the 1st to 4th motors, specify the corresponding function codes. (Refer to the description of A42.)

The motor parameters to be specified in P13 through P56 (such as iron loss factors and magnetic saturation factors) are usually not shown on the motor nameplate or in the test report.

If auto-tuning (P04 = 2 or 3) is not performed, it is not necessary to change the motor parameters from the ones for a standard motor.

P01 Motor 1 (No. of poles)

P01 specifies the number of poles of the motor. Enter the value given on the nameplate of the motor. This setting is used to monitor the motor speed (see E43) and control the speed. The following expression is used for the conversion.

$$\text{Motor speed (r/min)} = \frac{120}{\text{No. of poles}} \times \text{Frequency (Hz)}$$

- Data setting range: 2 to 22 (poles)

P02 Motor 1 (Rated capacity)

P02 specifies the rated capacity of the motor. Enter the rated value given on the nameplate of the motor.

Data for P02	Unit	Function
0.01 to 1000	HP	When P99 (Motor 1 Selection) = 1
	kW	When P99 (Motor 1 Selection) = 0, 2, 3 or 4

When accessing function code P02 with the keypad, take into account that the P02 data automatically updates the data of function codes P03, P06 through P23, P53 through P56, and H46.

P03 Motor 1 (Rated current)

P03 specifies the rated current of the motor. Enter the rated value given on the nameplate of the motor.

- Data setting range: 0.00 to 2000 (A)

P04 Motor 1 (Auto-tuning)

The inverter automatically detects the motor parameters and saves them in its internal memory. Basically, it is not necessary to perform tuning when using a HP rating motor with a standard connection with the inverter.

There are three types of auto-tuning as listed below. Select appropriate one considering the limitations in your equipment and control mode.

Data for P04	Auto-tuning	Operation	Motor parameters to be tuned
0	Disable	N/A	N/A
1	Tune while the motor stops	The inverter performs tuning while the motor is stopped.	Primary resistance (%R1) (P07) Leakage reactance (%X) (P08) Rated slip frequency (P12) %X correction factors 1 and 2 (P53 and P54)
2	Tune while the motor is rotating under V/f control	After tuning while the motor is stopped, the inverter performs tuning again, with the motor running at 50% of the base frequency.	No-load current (P06) Primary resistance (%R1) (P07) Leakage reactance (%X) (P08) Rated slip frequency (P12) Magnetic saturation factors 1 to 5 (P16 to P20) Magnetic saturation extension factors "a" to "c" (P21 through P23) %X correction factors 1 and 2 (P53 and P54)
3	Tune while the motor is rotating under vector control	After tuning while the motor is stopped, the inverter performs tuning, with the motor running at 50% of the base frequency twice.	No-load current (P06) Primary resistance (%R1) (P07) Leakage reactance (%X) (P08) Rated slip frequency (P12) Magnetic saturation factors 1 to 5 (P16 to P20) Magnetic saturation extension factors "a" to "c" (P21 to P23) %X correction factors 1 and 2 (P53 and P54)

 For details of auto-tuning, refer to Chapter 4, Section 4.1 "Running the Motor for a Test."

 **Note** In any of the following cases, perform auto-tuning since the motor parameters are different from those of standard motors so that the best performance cannot be obtained under some controls.

- The motor to be driven is a non-standard motor.
- Cabling between the motor and the inverter is long. (Generally, 66 ft (20 m) or longer)
- A reactor is inserted between the motor and the inverter.

■ Functions that are affected by motor parameters in running capability

Function	Related function codes (representative)
Auto torque boost	F37
Output torque monitor	F31, F35
Load factor monitor	F31, F35
Auto energy saving operation	F37
Torque limiter	F40, F41
Anti-regenerative control (Automatic deceleration)	H69
Auto search	H09
Slip compensation	F42
Dynamic torque vector control	F42
Droop control	H28
Torque detection	E78 to E81
Vector control without/with speed sensor	F42
Brake Signal (Brake-OFF torque)	J95

P05 Motor 1 (Online tuning)

Long run under "Dynamic torque vector control" or "Slip compensation control" causes motor temperature change, varying the motor parameters. This changes the motor speed compensation amount, resulting in motor speed deviation from the initial rpm.

Enabling online tuning (P05 = 1) identifies motor parameters covering the motor temperature change to decrease the motor speed fluctuation.

For use of online tuning, set P04 (Auto-tuning) to "2."



Note: Online tuning can be performed only when F42 = 1 (Dynamic torque vector control) or when F42 = 2 (V/f control with slip compensation active) and F37 = 2 or 5 (Auto torque boost).

P06 to P08 Motor 1 (No-load current, %R1 and %X)

P06 through P08 specify no-load current, %R1 and %X, respectively. Obtain the appropriate values from the test report of the motor or by calling the manufacturer of the motor.

Performing auto-tuning automatically sets these parameters.

■ **No-load current (P06)**

Enter the value obtained from the motor manufacturer.

■ **%R1 (P07)**

Enter the value calculated by the following expression.

$$\%R1 = \frac{R1 + \text{Cable } R1}{V / (\sqrt{3} \times I)} \times 100 (\%)$$

where,

R1: Primary resistance of the motor (Ω)

Cable R1: Resistance of the output cable (Ω)

V: Rated voltage of the motor (V)

I: Rated current of the motor (A)

■ **%X (P08)**

Enter the value calculated by the following expression.

$$\%X = \frac{X1 + X2 \times XM / (X2 + XM) + \text{Cable } X}{V / (\sqrt{3} \times I)} \times 100 (\%)$$

where,

X1: Primary leakage reactance of the motor (Ω)

X2: Secondary leakage reactance of the motor (converted to primary) (Ω)

XM: Exciting reactance of the motor (Ω)

Cable X: Reactance of the output cable (Ω)

V: Rated voltage of the motor (V)

I: Rated current of the motor (A)



Note For reactance, use the value at the base frequency (F04).

P09 to P11 Motor 1 (Slip compensation gain for driving, Slip compensation response time, and Slip compensation gain for braking)

P09 and P11 determine the slip compensation amount in % for driving and braking individually and adjust the slip amount from internal calculation. Specification of 100% fully compensates for the rated slip of the motor. Excessive compensation (P09, P11 > 100%) may cause hunting (undesirable oscillation of the system), so carefully check the operation on the actual machine.

P10 determines the response time for slip compensation. Basically, there is no need to modify the default setting. If you need to modify it, consult your Fuji Electric representatives.

Function codes		Operation (Slip compensation)
P09	Slip compensation gain for driving	Adjust the slip compensation amount for driving. Slip compensation amount for driving = Rated slip x Slip compensation gain for driving
P11	Slip compensation gain for braking	Adjust the slip compensation amount for braking. Slip compensation amount for braking = Rated slip x Slip compensation gain for braking
P10	Slip compensation response time	Specify the slip compensation response time. Basically, there is no need to modify the default setting.

 For details about the slip compensation control, refer to the description of F42.

P12 Motor 1 (Rated slip frequency)

P12 specifies rated slip frequency. Obtain the appropriate values from the test report of the motor or by calling the manufacturer of the motor. Performing auto-tuning automatically sets these parameters.

- Rated slip frequency: Convert the value obtained from the motor manufacturer to Hz using the following expression and enter the converted value. (**Note:** The motor rating given on the nameplate sometimes shows a larger value.)

$$\text{Rated slip frequency (Hz)} = \frac{(\text{Synchronous speed} - \text{Rated speed})}{\text{Synchronous speed}} \times \text{Base frequency}$$

 For details about the slip compensation control, refer to the description of F42.

P13 to P15 Motor 1 (Iron loss factors 1 to 3)

P13 to P15 compensates the iron loss caused inside the motor under vector control with speed sensor, in order to improve the torque control accuracy.

The combination of P99 (Motor 1 selection) and P02 (Motor 1 rated capacity) data determines the standard value. Basically, there is no need to modify the setting.

P16 to P20 Motor 1 (Magnetic saturation factors 1 to 5)
P21 to P23 Motor 1 (Magnetic saturation extension factors "a" to "c")

These function codes specify the characteristics of the exciting current to generate magnetic flux inside the motor and the characteristics of the magnetic flux generated.

The combination of P99 (Motor 1 selection) and P02 (Motor 1 rated capacity) data determines the standard value. Performing auto-tuning while the motor is rotating (P04 = 2 or 3) specifies these factors automatically.

P53, P54 Motor 1 (%X correction factors 1 and 2)

P53 and P54 specify the factors to correct fluctuations of leakage reactance (%X).

Basically, there is no need to modify the setting.

P55 Motor 1 (Torque current under vector control)

P55 specifies the rated torque current under vector control without/with speed sensor.

The combination of P99 (Motor 1 selection) and P02 (Motor 1 rated capacity) data determines the standard value. Basically, there is no need to modify the setting.

P56 Motor 1 (Induced voltage factor under vector control)

P56 specifies the induced voltage factor under vector control without/with speed sensor.

The combination of P99 (Motor 1 Selection) and P02 (Motor 1, Rated capacity) data determines the standard value. Basically, there is no need to modify the setting.

P99 Motor 1 Selection

P99 specifies the motor type to be used.

Data for P99	Motor type
0	Motor characteristics 0 (Fuji standard motors, 8-series)
1	Motor characteristics 1 (HP rating motors)
2	Motor characteristics 2 (Fuji motors exclusively designed for vector control)
3	Motor characteristics 3 (Fuji standard motors, 6-series)
4	Other motors

To select the motor drive control or to run the inverter with the integrated automatic control functions such as auto torque boost and torque calculation monitoring, it is necessary to specify the motor parameters correctly. First select the motor type to be used with P99, specify the motor rated capacity with P02, and then initialize the motor parameters with H03. This process automatically configures the related motor parameters (P01, P03, P06 through P23, P53 through P56, and H46).

The data of F09 (Torque Boost 1), H13 (Restart Mode after Momentary Power Failure (Restart time)), and F11 (Electronic Thermal Overload Protection for Motor 1, Overload detection level) depends on the motor capacity, but the process stated above does not change them. Specify and adjust the data during a test run if needed.

5.2.5 H codes (High Performance Functions)

H03 Data Initialization

H03 initializes the current function code data to the factory defaults or initializes the motor parameters.

To change the H03 data, it is necessary to press the $\text{STOP} + \text{▲}$ keys or $\text{STOP} + \text{▼}$ keys (simultaneous keying).

Data for H03	Function
0	Disable initialization (Settings manually made by the user will be retained.)
1	Initialize all function code data to the factory defaults
2	Initialize motor 1 parameters in accordance with P02 (Rated capacity) and P99 (Motor 1 selection)
3	Initialize motor 2 parameters in accordance with A16 (Rated capacity) and A39 (Motor 2 selection)
4	Initialize motor 3 parameters in accordance with b16 (Rated capacity) and b39 (Motor 3 selection)
5	Initialize motor 4 parameters in accordance with r16 (Rated capacity) and r39 (Motor 4 selection)

- To initialize the motor parameters, set the related function codes as follows.

Step	Item	Action	Function code			
			1st motor	2nd motor	3rd motor	4th motor
(1)	Motor selection	Selects the motor type	P99	A39	b39	r39
(2)	Motor (rated capacity)	Sets the motor capacity (HP)	P02	A16	b16	r16
(3)	Data initialization	Initialize motor parameters	H03 = 2	H03 = 3	H03 = 4	H03 = 5
	Function code data to be initialized	If "Data = 0, 1, 3, or 4" in Step (1)	P01, P03, P06 to P23, P53 to P56, H46	A15, A17, A20 to A37, A53 to A56	b15, b17, b20 to b37, b53 to b56	r15, r17, r20 to r37, r53 to r56
		If "Data = 2" in Step (1), function codes listed at the right are also initialized	F04, F05	A02, A03	b02, b03	r02, r03

- Upon completion of the initialization, the H03 data reverts to "0" (factory default).
- If P02, A16, b16 or r16 data is set to a value other than the nominal applied motor rating, data initialization with H03 internally converts the specified value forcibly to the standard nominal applied motor rating. (Refer to Table B in Section 5.1 "Function Code Tables.")
- Motor parameters to be initialized are for motors listed below under V/f control. When the base frequency, rated voltage, and the number of poles are different from those of the listed motors, or when non-standard motors are used, change the rated current data to that printed on the motor nameplate.

Motor selection		V/f control data	
Data = 1	HP rating motors	4 poles	230 V/60 Hz, 460 V/60 Hz
Data = 2	Fuji motors exclusively designed for vector control	4 poles	—/50 Hz, —/50 Hz
Data = 0 or 4	Fuji standard motors, 8-series	4 poles	200 V/50 Hz, 400 V/50 Hz
Data = 3	Fuji standard motors, 6-series	4 poles	200 V/50 Hz, 400 V/50 Hz

Note When accessing function code P02 with the keypad, take into account that P02 data automatically updates data of function codes P03, P06 through P23, P53 through P56, and H46. Also, when accessing function code A16, b16 or r16, data of related function codes for each are automatically updated.

H04, H05 Auto Reset (Times and Reset interval)

H04 and H05 specify the auto-reset function that makes the inverter automatically attempt to reset the tripped state and restart without issuing an alarm output (for any alarm) even if any protective function subject to reset is activated and the inverter enters the forced-to-stop state (tripped state).

If the protective function is activated in excess of the times specified by H04, the inverter will issue an alarm output (for any alarm) and not attempt to auto-reset the tripped state.

Listed below are the protective functions subject to auto-reset.

Protective function	LED monitor displays:	Protective function	LED monitor displays:
Overcurrent protection	<i>OC 1, OC2 or OC3</i>	Motor overheat	<i>OH4</i>
Overvoltage protection	<i>OV 1, OV2 or OV3</i>	Braking resistor overheat	<i>BRH</i>
Heat sink overheat	<i>OH1</i>	Motor overload	<i>OL 1 to OL4</i>
Inverter internal overheat	<i>OH3</i>	Inverter overload	<i>OLU</i>

- Number of reset times (H04) Data setting range: 0 (Disable), 1 to 10 (times)

H04 specifies the number of reset times for the inverter to automatically attempt to escape the tripped state.

⚠ WARNING

If the "auto-reset" function has been specified, the inverter may automatically restart and run the motor stopped due to a trip fault, depending on the cause of the tripping.

Design the machinery so that human body and peripheral equipment safety is ensured even when the auto-resetting succeeds.

Otherwise an accident could occur.

- Reset interval (H05) Data setting range: 0.5 to 20.0 (s)

H05 specifies the reset interval time between the time when the inverter enters the tripped state and the time when it issues the reset command to attempt to auto-reset the state. Refer to the timing scheme diagrams below.

<Operation timing scheme>

- In the figure below, normal operation restarts in the 4th retry.

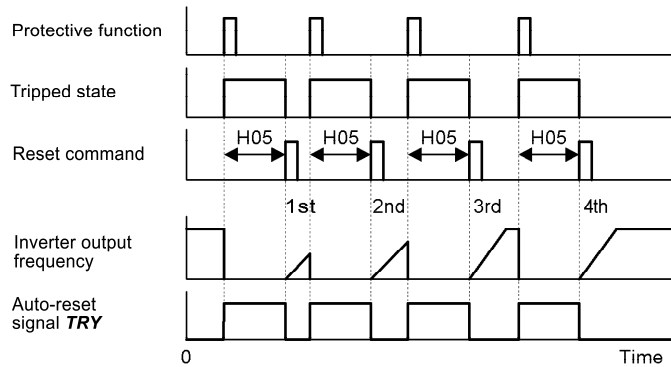

- In the figure below, the inverter failed to restart normal operation within the number of reset times specified by H04 (in this case, 3 times (H04 = 3)), and issued the alarm output (for any alarm) *ALM*.

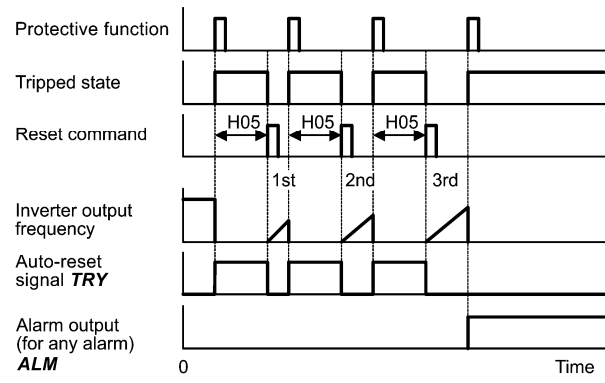

- Auto-resetting -- *TRY* (E20 to E24 and E27, data = 26)
This output signal comes ON when auto-resetting (resetting alarms automatically) is in progress.

H06 Cooling Fan ON/OFF Control

To prolong the service life of the cooling fan and reduce fan noise during running, the cooling fan stops when the temperature inside the inverter drops below a certain level while the inverter stops. However, since frequent switching of the cooling fan shortens its service life, the cooling fan keeps running for 10 minutes once started.

H06 specifies whether to keep running the cooling fan all the time or to control its ON/OFF.

Data for H06	Cooling fan ON/OFF
0	Disable (Always in operation)
1	Enable (ON/OFF controllable)

- Cooling fan in operation -- *FAN* (E20 to E24 and E27, data = 25)
With the cooling fan ON/OFF control enabled (H06 = 1), this output signal is ON when the cooling fan is in operation, and OFF when it is stopped. This signal can be used to make the cooling system of peripheral equipment interlocked for an ON/OFF control

H07 Acceleration/Deceleration Pattern (Refer to F07.)

H08 Rotational Direction Limitation

H08 inhibits the motor from running in an unexpected rotational direction due to miss-operation of run commands, miss-polarization of frequency commands, or other mistakes.

Data for H08	Function
0	Disable
1	Enable (Reverse rotation inhibited)
2	Enable (Forward rotation inhibited)

Under vector control, some restrictions apply to the speed command. Under vector control without speed sensor, a speed estimation error caused by a motor constant error or other errors may slightly rotate the motor in the direction other than the specified one.

H09	Starting Mode (Auto search)	H49 (Starting Mode, Auto search delay time 1)
d67	Starting Mode (Auto search)	H46 (Starting Mode, Auto search delay time 2)

H09 specifies the starting mode--whether to enable the auto search for idling motor speed to run the idling motor without stopping it.

The auto search can apply to the restart of the inverter after a momentary power failure and the normal startup of the inverter individually.

If the terminal command *STM* ("Enable auto search for idling motor speed at starting") is assigned to a digital input terminal with any of E01 to E07 (data = 26), the combination of the H09 data and the *STM* command status switches the starting modes (whether auto search is enabled or disabled). If no *STM* is assigned, the inverter interprets *STM* as being OFF by default.

■ H09/d67 (Starting mode, auto search) and terminal command *STM* ("Enable auto search for idling motor speed at starting")

The combination of H09/d67 data and the *STM* status determines whether to perform the auto search as listed below.

Function code	Drive control	Factory default
H09	V/f control (F42 = 0 to 2)	0: Disable
d67	Vector control without speed sensor (F42 = 5)	2: Enable

Data for H09/d67	<i>STM</i>	Auto search for idling motor speed at starting	
		For restart after momentary power failure (F14 = 3 to 5)	For normal startup
0: Disable	OFF	Disable	Disable
1: Enable	OFF	Enable	Disable
2: Enable	OFF	Enable	Enable
—	ON	Enable	Enable

When *STM* is ON, auto search for idling motor speed at starting is enabled regardless of the H09/d67 setting.

Refer to E01 to E07 (data = 26).

Auto search for idling motor speed

Starting the inverter (with a run command ON, *BX* OFF, auto-reset, etc.) with *STM* being ON searches for the idling motor speed for a maximum of 1.2 seconds to run the idling motor without stopping it. After completion of the auto search, the inverter accelerates the motor up to the reference frequency according to the frequency command and the preset acceleration time.

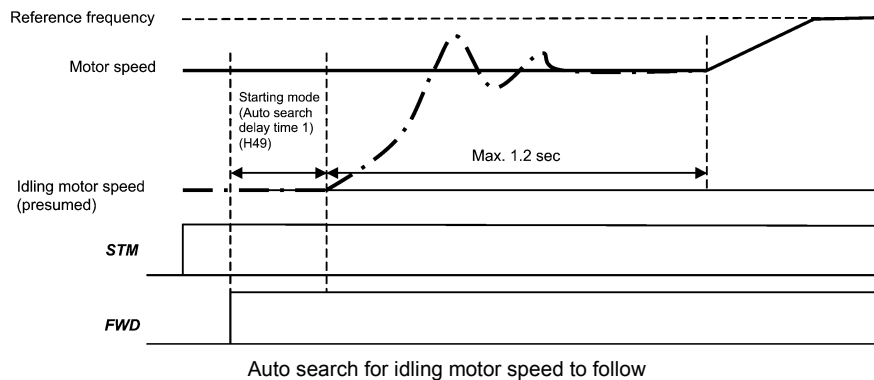

■ **Starting Mode (Auto search delay time 1) (H49)** Data setting range: 0.0 to 10.0 (s)

Auto search for the idling motor speed will become unsuccessful if it is done while the motor retains residual voltage. It is, therefore, necessary to leave the motor for an enough time for residual voltage to disappear. H49 specifies that time (0.0 to 10.0 sec.).

At the startup triggered by a run command ON, auto search starts with the delay specified by H49. Using H49, therefore, eliminates the need of the run command timing control when two inverters share a single motor to drive it alternately, allow the motor to coast to a stop, and restart it under auto search control at each time of inverter switching

■ **Starting Mode (Auto search delay time 2) (H46)** Data setting range: 0.1 to 20.0 (s)

At the restart after a momentary power failure, at the start by turning the terminal command **BX** ("Coast to a stop") OFF and ON, or at the restart by auto-reset, the inverter applies the delay time specified by H46. The inverter will not start unless the time specified by H46 has elapsed, even if the starting conditions are satisfied.

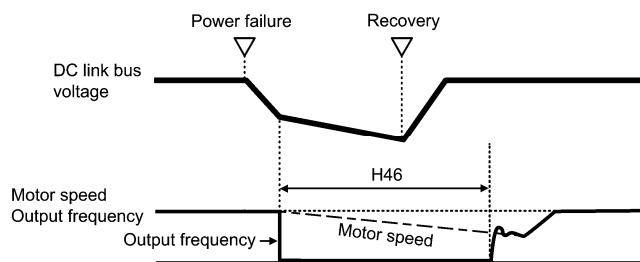

Under auto search control, the inverter searches the motor speed with the voltage applied at the motor start and the current flowing in the motor, based on the model built with the motor parameters. Therefore, the search is greatly influenced by the residual voltage in the motor.

At factory shipment, H46 data is preset to a correct value according to the motor capacity for the general purpose motor, and basically there is no need to modify the data.

Depending on the motor characteristics, however, it may take time for residual voltage to disappear (due to the secondary thermal time constant of the motor). In such a case, the inverter starts the motor with the residual voltage remaining, which will cause an error in the speed search and may result in occurrence of an inrush current or an overvoltage alarm.

If it happens, increase the value of H46 data and remove the influence of residual voltage. (If possible, it is recommended to set the value around two times as large as the factory default value allowing a margin.)

- Note**
- Be sure to auto-tune the inverter preceding the start of auto search for the idling motor speed.
 - When the estimated speed exceeds the maximum frequency or the upper limit frequency, the inverter disables auto search and starts running the motor with the maximum frequency or the upper limit frequency, whichever is lower.
 - During auto search, if an overcurrent or overvoltage trip occurs, the inverter restarts the suspended auto search.
 - Perform auto search at 60 Hz or below.
 - Note that auto search may not fully provide the performance depending on load conditions, motor parameters, wiring length, and other external factors.

H11 Deceleration Mode

H11 specifies the deceleration mode to be applied when a run command is turned OFF.

Data for H11	Function
0	Normal deceleration
1	Coast-to-stop (The inverter immediately shuts down its output, so the motor stops according to the inertia of the motor and machinery (load) and their kinetic energy losses.)

- Note** When reducing the reference frequency, the inverter decelerates the motor according to the deceleration commands even if H11 = 1 (Coast-to-stop).

H12 Instantaneous Overcurrent Limiting (Mode selection) (Refer to F43.)

**H13, H14 Restart Mode after Momentary Power Failure (Restart time, Frequency fall rate,
H15, H16 Continuous running level, and Allowable momentary power failure time)** (Refer to F14.)

When vector control with/without speed sensor is selected, the inverter can control the motor-generating torque according to a torque command sent from external sources.

■ Torque Control (Mode selection) (H18)

H18 specifies whether to enable or disable the torque control. Enabling the torque control offers two choices: with torque current command and with torque command.

Data for H18	Available control
0	Disable (Speed control)
2	Enable (Torque control with torque current command)
3	Enable (Torque control with torque command)

■ Torque Commands

Torque commands can be given as analog voltage input (via terminals [12] and [V2]) or analog current input (via terminal [C1]), or via the communications link (communication dedicated function codes S02 and S03). To use analog voltage/current inputs, it is necessary to set E61 (for terminal [12]), E62 (for terminal [C1]), or E63 (for terminal [V2]) data to "10" or "11."

Input	Command form	Function code setting	Specifications
Terminal [12] (-10 V to 10 V)	Torque command	E61 = 10	Motor rated torque $\pm 200\%$ / ± 10 V
	Torque current command	E61 = 11	Motor rated torque current $\pm 200\%$ / ± 10 V
Terminal [V2] (-10 V to 10 V)	Torque command	E63 = 10	Motor rated torque $\pm 200\%$ / ± 10 V
	Torque current command	E63 = 11	Motor rated torque current $\pm 200\%$ / ± 10 V
Terminal [C1] (4 to 20 mA)	Torque command	E62 = 10	Motor rated torque 200% / 20 mA
	Torque current command	E62 = 11	Motor rated torque current 200% / 20 mA
S02 (-327.68 to 327.67%)	Torque command	—	Motor rated torque / $\pm 100.00\%$
S03 (-327.68 to 327.67%)	Torque current command	—	Motor rated torque current / $\pm 100.00\%$

■ Polarity of Torque Commands

The polarity of a torque command switches according to the combination of the polarity of an external torque command and a run command on terminal [FWD] or [REV], as listed below.

Polarity of torque command	Run command (ON)	Torque polarity
Positive	FWD	Positive torque (Forward driving/Reverse braking)
	REV	Negative torque (Forward braking/Reverse driving)
Negative	FWD	Negative torque (Forward braking/Reverse driving)
	REV	Positive torque (Forward driving/Reverse braking)

■ Cancel torque control -- **Hz/TRQ** (E01 to E07, data = 23)

When torque control is enabled (H18 = 2 or 3), assigning the terminal command **Hz/TRQ** ("Cancel torque control") to any of the general-purpose digital input terminals (data = 23) enables switching between speed control and torque control.

Cancel torque control signal Hz/TRQ	Operation
ON	Cancel torque control (Enable speed control)
OFF	Enable torque control

■ Torque Control (Speed limits 1 and 2) (d32, d33)

Torque control controls the motor-generating torque, not the speed. The speed is determined secondarily by torque of the load, inertia of the machinery, and other factors. To prevent a dangerous situation, therefore, the speed limit functions (d32 and d33) are provided inside the inverter.

Note If a regenerative load (which is not generated usually) is generated under droop control or function codes are incorrectly configured, then the motor may rotate at an unintended high speed. To protect the machinery, it is possible to specify the overspeed level with d32 and d33 as follows.

- Forward overspeed level = Maximum frequency 1 (F03) x Speed limit 1 (d32) x 120 (%)
- Reverse overspeed level = Maximum frequency 1 (F03) x Speed limit 2 (d33) x 120 (%)

Note **Running/stopping the motor**

Under torque control, the inverter does not control the speed, so it does not perform acceleration or deceleration by soft-start and stop (acceleration/deceleration time) at the time of startup and stop. Turning ON a run command starts the inverter to run and output the commanded torque. Turning it OFF stops the inverter so that the motor coasts to a stop.

At the start of torque control under the "Vector control without speed sensor," the starting operation differs depending upon whether auto search is enabled or disabled by d67 as shown below.

Data for d67	Operation
0: Disable 1: Enable (At restart after momentary power failure)	At startup, the inverter first starts at zero frequency. Then it accelerates according to a torque command. Select this operation for use in which the motor is surely stopped before startup.
2: Enable (At normal start and at restart after momentary power failure)	At startup, the inverter searches for idling motor speed and restarts running the motor at the frequency based on the searched speed. Then it starts torque control.

H26, H27 Thermistor (for motor) (Mode selection and Level)

These function codes specify the PTC (Positive Temperature Coefficient)/NTC (Negative Temperature Coefficient) thermistor embedded in the motor. The thermistor is used to protect the motor from overheating or output an alarm signal.

■ **Thermistor (for motor) (Mode selection) (H26)**

H26 selects the function operation mode (protection or alarm) for the PTC/NTC thermistor as shown below.

Data for H26	Action
0	Disable
1	Enable When the voltage sensed by PTC thermistor exceeds the detection level, motor protective function (alarm 0h4) is triggered, causing the inverter to enter an alarm stop state.
2	Enable When the voltage sensed by the PTC thermistor exceeds the detection level, a motor alarm signal is output but the inverter continues running. You need to assign the "Motor overheat detected by thermistor" signal (THM) to one of the digital output terminals beforehand, by which a temperature alarm condition can be detected by the thermistor (PTC) (E20 to E24 and E27, data = 56).
3	Enable When the inverter is connected with the NTC thermistor built into the motor exclusively designed for vector control, the inverter senses the motor temperature and uses the information for control. If the motor overheats and the temperature exceeds the protection level, the inverter issues the Motor protection alarm 0h4 and stops the motor.

If H26 data is set to "1" or "2" (PTC thermistor), the inverter monitors the voltage sensed by PTC thermistor and protect the motor even when any of the 2nd to 4th motors is selected. If H26 data is set to "3" (NTC thermistor) and any of the 2nd to 4th motors is selected, the inverter does not perform these functions.

■ **Thermistor (for motor) (Level) (H27)** Data setting range: 0.00 to 5.00 (V)

H27 specifies the detection level (expressed in voltage) for the temperature sensed by the PTC thermistor.

The alarm temperature at which the overheat protection becomes activated depends on the characteristics of the PTC thermistor. The internal resistance of the thermistor will significantly change at the alarm temperature. The detection level (voltage) is specified based on the change of the internal resistance.

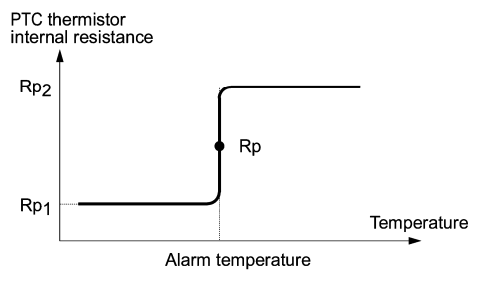

H codes

Suppose that the internal resistance of the PTC thermistor at the alarm temperature is R_p , the detection level (voltage) V_{C1} is calculated by the expression below. Set the result V_{C1} to function code H27.

$$V_{C1} = \frac{R_p}{27000 + R_p} \times 10.5 \text{ (V)}$$

Connect the PTC thermistor as shown below. The voltage obtained by dividing the input voltage on terminal [C1] with a set of internal resistors is compared with the detection level voltage specified by H27.

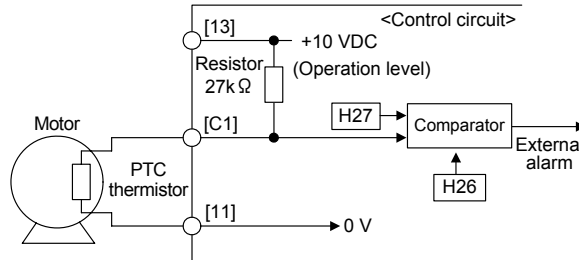

Note When using the terminal [C1] for PTC/NTC thermistor input, also turn SW5 on the control printed circuit board to the PTC/NTC side. For details, refer to Chapter 2, "SPECIFICATIONS."

H28 Droop Control

In a system in which two or more motors drive single machinery, any speed gap between inverter-driven motors results in some load unbalance between motors. The droop control allows each inverter to drive the motor with the speed droop characteristics for increasing its load, eliminating such kind of load unbalance.

- Data setting range: -60.0 to 0.0 (Hz), (0.0: Disable)

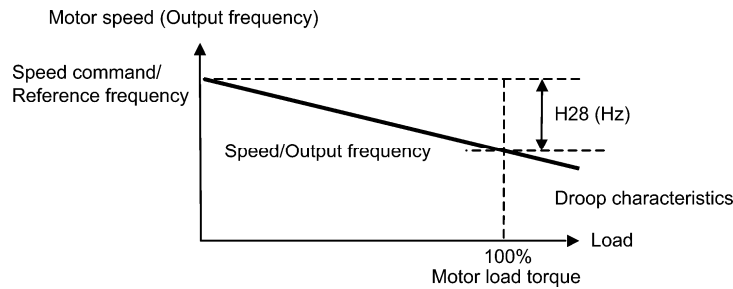

■ Select droop control -- **DROOP** (E01 to E07, data = 76)

The terminal command **DROOP** toggles droop control on and off.

DROOP	Droop control
ON	Enable
OFF	Disable

Note To use droop control, be sure to auto-tune the inverter for the motor beforehand.

Under V/f control, to prevent the inverter from tripping even at an abrupt change in load, droop control applies the acceleration/deceleration time to the frequency obtained as a result of droop control. This may delay reflection of the frequency compensated during droop control on the motor speed, thereby running the inverter as if droop control is disabled.

By contrast, under vector control with/without speed sensor, the current control system works so that the inverter does not trip even at an abrupt change in load. No acceleration/deceleration time is applied to the frequency obtained as a result of droop control. It is, therefore, possible to eliminate load unbalance even during acceleration/deceleration.

Using the RS-485 communications link (standard/option) or fieldbus (option) allows you to issue frequency commands and run commands from a computer or PLC at a remote location, as well as monitor the inverter running information and the function code data.

H30 and y98 specify the sources of those commands--"inverter itself" or "computers or PLCs via the RS-485 communications link or fieldbus." H30 is for the RS-485 communications link; y98 for the fieldbus.

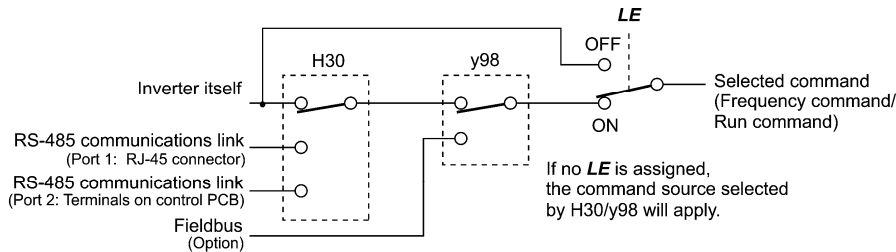

Command sources selectable

Command sources	Description
Inverter itself	Sources except RS-485 communications link and fieldbus Frequency command source: Specified by F01/C30, or multi-frequency command Run command source: Via the keypad or digital input terminals selected by F02
RS-485 communications link (port 1)	Via the standard RJ-45 port used for connecting a keypad
RS-485 communications link (port 2)	Via the terminals DX+, DX- and SD on the control PCB
Fieldbus (option)	Via fieldbus (option) using FA protocol such as DeviceNet or PROFIBUS-DP

Command sources specified by H30 (Communications link function, Mode selection)

Data for H30	Frequency command	Run command
0	Inverter itself (F01/C30)	Inverter itself (F02)
1	RS-485 communications link (port 1)	Inverter itself (F02)
2	Inverter itself (F01/C30)	RS-485 communications link (port 1)
3	RS-485 communications link (port 1)	RS-485 communications link (port 1)
4	RS-485 communications link (port 2)	Inverter itself (F02)
5	RS-485 communications link (port 2)	RS-485 communications link (port 1)
6	Inverter itself (F01/C30)	RS-485 communications link (port 2)
7	RS-485 communications link (port 1)	RS-485 communications link (port 2)
8	RS-485 communications link (port 2)	RS-485 communications link (port 2)

Command sources specified by y98 (Bus link function, Mode selection)

Data for y98	Frequency command	Run command
0	Follow H30 data	Follow H30 data
1	Via fieldbus (option)	Follow H30 data
2	Follow H30 data	Via fieldbus (option)
3	Via fieldbus (option)	Via fieldbus (option)

Combination of command sources

		Frequency command			
		Inverter itself	Via RS-485 communications link (port 1)	Via RS-485 communications link (port 2)	Via fieldbus (option)
Run command source	Inverter itself	H30 = 0 y98 = 0	H30 = 1 y98 = 0	H30=4 y98=0	H30=0 (1 or 4) y98=1
	Via RS-485 communications link (port 1)	H30 = 2 y98 = 0	H30 = 3 y98 = 0	H30=5 y98=0	H30=2 (3 or 5) y98=1
	Via RS-485 communications link (port 2)	H30 = 6 y98 = 0	H30 = 7 y98 = 0	H30=8 y98=0	H30=6 (7 or 8) y98=1
	Via fieldbus (option)	H30 = 0 (2 or 6) y98 = 2	H30 = 1 (3 or 7) y98 = 2	H30 = 4 (5 or 8) y98 = 2	H30 = 0 (1 to 8) y98 = 3

 For details, refer to the RS-485 Communication User's Manual or the Field Bus Option Instruction Manual.

When the terminal command **LE** ("Enable communications link via RS-485 or fieldbus") is assigned to a digital input terminal, turning **LE** ON makes the settings of H30 and y98 enabled. When **LE** is OFF, those settings are disabled so that both frequency commands and run commands specified from the inverter itself take control. (Refer to the descriptions of E01 through E07, data = 24.)

No **LE** assignment is functionally equivalent to the **LE** being ON.

H42, H43 Capacitance of DC Link Bus Capacitor, Cumulative Run Time of Cooling Fan
H48 Cumulative Run Time of Capacitors on Printed Circuit Boards

H47 (Initial Capacitance of DC Link Bus Capacitor)
H98 (Protection/Maintenance Function)

■ Life prediction function

The inverter has the life prediction function for some parts which measures the discharging time or counts the voltage applied time, etc. The function allows you to monitor the current lifetime state on the LED monitor and judge whether those parts are approaching the end of their service life.

The life prediction function can also issue early warning signals if the lifetime alarm command **LIFE** is assigned to any of the digital output terminals by any of E20 through E24 and E27.

 For details, refer to Chapter 7, "MAINTENANCE AND INSPECTION."

Function code	Name	Description
H42	Capacitance of DC link bus capacitor	Displays the capacitance of DC link bus capacitor (measured value) <ul style="list-style-type: none"> Start of initial capacitance measuring mode under ordinary operating conditions (0) Measurement failure (1)
H43	Cumulative run time of cooling fan	Displays the cumulative run time of cooling fan. <ul style="list-style-type: none"> Data setting range: 0 to 99990 (hours)
H47	Initial capacitance of DC link bus capacitor	Displays the initial capacitance of DC link bus capacitor (measured value) <ul style="list-style-type: none"> Start of initial capacitance measuring mode under ordinary operating conditions (0) Measurement failure (1)
H48	Cumulative run time of capacitors on printed circuit boards	Displays the cumulative run time of capacitor on the printed circuit board. <ul style="list-style-type: none"> Data setting range: 0 to 99990 (hours)

When replacing the cooling fan or capacitors on printed circuit boards, it is necessary to clear or modify the data of the function codes listed above. For details, refer to the documentation for maintenance.

H44, H78 Startup Counter for Motor 1, Maintenance Interval (M1)
H79, H94 Preset Startup Count for Maintenance (M1), Cumulative Motor Run Time 1

■ Cumulative motor run time 1 (H94)

Operating the keypad can display the cumulative run time of the 1st motor. This feature is useful for management and maintenance of the machinery. Using H94 can modify the cumulative run time to the desired value to be used as an arbitrary initial data on which the replacement timing of machine parts or inverter is based. Specifying "0" clears the cumulative run time of the motor.

Even when a motor is driven by commercial power, not by the inverter, it is possible to count the cumulative run time of the motor by detecting the ON/OFF state of the auxiliary contact of the magnetic contactor for switching to the commercial power line. To enable this function, assign **CRUN-M1** (Commercial power driving status of motor 1, function code data = 72) to one of the digital input terminals.

Note Cumulative motor run time 2 through 4 can also be counted by assigning **CRUN-M2** through **CRUN-M4** (Commercial power driving status of motor 2 through 4, function code data = 73 through 75).

■ Startup counter for motor 1 (H44)

H44 counts the number of inverter startups and displays it. Check the displayed number on the maintenance screen of the keypad, and use it as a guide for maintenance timing for parts such as belts. To start the counting over again, e.g. after a belt replacement, set the H44 data to "0."

■ Maintenance timer -- **MNT**

1) H78 (Maintenance interval (M1)) specifies the maintenance interval. When the cumulative motor run time 1 (H94) reaches the setting specified by H78 (Maintenance interval (M1)), the inverter outputs the maintenance timer signal **MNT** (if assigned to any digital terminal with any of E20 to E24 and E27) to remind the user of the need of the maintenance of the machinery.

- Data setting range: 0 (Disable); 1 to 99990 (hours)
- < Biannual maintenance >

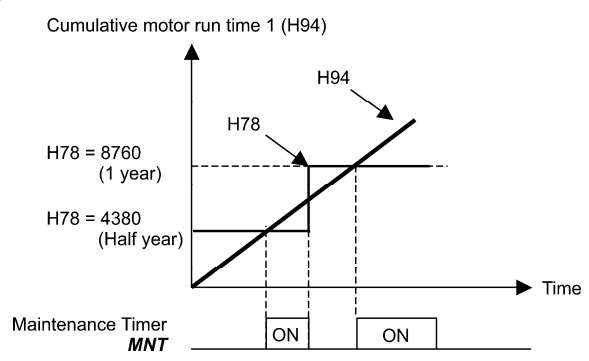

2) H79 (Preset startup count for maintenance (M1)) specifies the number of inverter startup times to determine the next maintenance timing. When the count of the startup counter for motor 1 (H44) reaches the number specified by H79 (Preset startup count for maintenance (M1)), the inverter outputs the maintenance timer signal **MNT** to remind the user of the need of system maintenance.

- Data setting range: 0 (Disable); 1 to 65535 (times)
- < Maintenance every 1,000 times of startups >

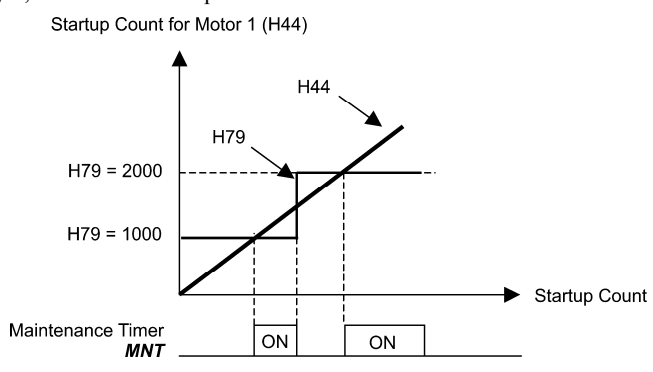

To enable this function, assign the maintenance timer signal **MNT** to one of the digital output terminals (function code data = 84).



- If the maintenance interval counter reaches the specified value, set a new value for the next maintenance in H78 and press the key to reset the output signal and restart counting. This function is exclusively applied to the 1st motor.
- If the startup counter reaches the specified value, set a new value for the next maintenance in H79 and press the key to reset the output signal and restart counting. This function is exclusively applied to the 1st motor.

H45	Mock Alarm	H97 (Clear Alarm Data)
<p>H45 causes the inverter to generate a mock alarm in order to check whether external sequences function correctly at the time of machine setup.</p> <p>Setting the H45 data to "1" displays mock alarm \overline{ERR} on the LED monitor. It also issues alarm output (for any alarm) <i>ALM</i> (if assigned to a digital output terminal by any of E20 to E24 and E27). (Accessing the H45 data requires simultaneous keying of "STOP" key + key.) After that, the H45 data automatically reverts to "0," allowing you to reset the alarm.</p> <p>Just as data (alarm history and relevant information) of those alarms that could occur in running the inverter, the inverter saves mock alarm data, enabling you to confirm the mock alarm status.</p> <p>To clear the mock alarm data, use H97. (Accessing the H97 data requires simultaneous keying of "STOP" key + key.) H97 data automatically returns to "0" after clearing the alarm data.</p> <p> A mock alarm can be issued also by simultaneous keying of "STOP" key + key" on the keypad for 5 seconds or more.</p>		
H46	Starting Mode (Auto search delay time 2)	(Refer to H09.)
H47, H48	Initial Capacitance of DC Link Bus Capacitor Cumulative Run Time of Capacitors on Printed Circuit Boards	(Refer to H42.)
H50, H51 H52, H53	Non-linear V/f Pattern 1 (Frequency and Voltage) Non-linear V/f Pattern 2 (Frequency and Voltage)	(Refer to F04.)
H49	Starting Mode (Auto search delay time 1)	(Refer to H09.)
H54, H55 H56 H57 to H60	Acceleration Time, Deceleration Time (Jogging) Deceleration Time for Forced Stop 1st/2nd S-curve Acceleration/Deceleration Range	(Refer to F07.)
H61	UP/DOWN Control (Initial frequency setting)	(Refer to F01.)
H63	Low Limiter (Mode selection)	(Refer to F15.)
H64	Low Limiter (Lower limiting frequency)	
<p>H64 specifies the lower limit of frequency to be applied when the current limiter, torque limiter, automatic deceleration (anti-regenerative control), or overload prevention control is activated. Normally, it is not necessary to change this data.</p> <p>- Data setting range: 0.0 to 60.0 (Hz)</p>		
H65, H66	Non-linear V/f Pattern 3 (Frequency and Voltage)	(Refer to F04.)
H67	Auto Energy Saving Operation (Mode selection)	(Refer to F37.)
H68	Slip Compensation 1 (Operating conditions)	(Refer to F42.)

H69 enables or disables the anti-regenerative control.

In the inverter not equipped with a PWM converter or braking unit, if the regenerative energy returned exceeds the inverter's braking capability, an overvoltage trip occurs.

To avoid such an overvoltage trip, enable the automatic deceleration (anti-regenerative control) with this function code, and the inverter controls the output frequency to keep the braking torque around "0" in both the deceleration and constant speed running phases.

FRENIC-MEGA series of inverters have two braking control modes; torque limit control and DC link bus voltage control. Understand the feature of each control and select the suitable one.

Control mode	Control process	Operation mode	Features
Torque limit control (H69=2 or 4)	Controls the output frequency to keep the braking torque around "0."	Enabled during acceleration, running at the constant speed, and deceleration.	Quick response. Causes less overvoltage trip with heavy impact load.
DC link bus voltage control (H69=3 or 5)	Control the output frequency to lower the DC link bus voltage if the voltage exceeds the limiting level.	Enabled during deceleration. Disabled during running at the constant speed.	Shorter deceleration time by making good use of the inverter's regenerative capability.

In addition, during deceleration triggered by turning the run command OFF, the anti-regenerative control increases the output frequency so that the inverter may not stop the load depending on the load state (huge moment of inertia, for example). To avoid that, H69 provides a choice of cancellation of the anti-regenerative control to apply when three times the specified deceleration time is elapsed, thus decelerating the motor forcibly.

Data for H69	Function	
	Control mode	Force-to-stop with actual deceleration time exceeding three times the specified one
0	Disable automatic deceleration	—
2	Torque limit control	Enable
3	DC link bus voltage control	Enable
4	Torque limit control	Disable
5	DC link bus voltage control	Disable

■ Torque Limiter (Frequency increment limit for braking) (H76) Data setting range: 0.0 to 500.0 (Hz)

Since increasing the output frequency too much in the torque limit control mode is dangerous, the inverter has a torque limiter (Frequency increment limit for braking) that can be specified by H76. The torque limiter limits the inverter's output frequency to less than "Reference frequency + H76 setting."

Note that the torque limiter activated restrains the anti-regenerative control, resulting in an overvoltage trip in some cases. Increasing the H76 data improves the anti-regenerative control capability.



- Enabling the automatic deceleration (anti-regenerative control) may automatically increase the deceleration time.
- When a braking unit is connected, disable anti-regenerative control. Automatic deceleration control may be activated at the same time when a braking unit starts operation, which may make the deceleration time fluctuate.
- If the set deceleration time is too short, the DC link bus voltage of the inverter rises quickly and consequently, the automatic deceleration may not follow the voltage rise. In such a case, specify a longer deceleration time.

H70 Overload Prevention Control

H70 specifies the decelerating rate of the output frequency to prevent a trip from occurring due to an overload. This control decreases the output frequency of the inverter before the inverter trips due to a heat sink overheat or inverter overload (with an alarm indication of $\overline{OL1}$ / or $\overline{OL2}$, respectively). It is useful for equipment such as pumps where a decrease in the output frequency leads to a decrease in the load and it is necessary to keep the motor running even when the output frequency drops.

Data for H70	Function
0.00	Decelerate the motor by deceleration time 1 (F08) or 2 (E11)
0.01 to 100.0	Decelerate the motor by deceleration rate from 0.01 to 100.0 (Hz/s)
999	Disable overload prevention control

■ **Overload prevention control -- OLP (E20 to E24 and E27, data = 36)**

This output signal comes ON when the overload prevention control is activated and the output frequency changed. (Minimum width of the output signal: 100 ms)

 **Note** In equipment where a decrease in the output frequency does not lead to a decrease in the load, the overload prevention control is of no use and should not be enabled.

H71 Deceleration Characteristics

Setting the H71 data to "1" enables forced brake control. If regenerative energy produced during the deceleration of the motor and returned to the inverter exceeds the inverter's braking capability, an overvoltage trip will occur. The forced brake control increases the motor energy loss during deceleration, increasing the deceleration torque.

Data for H71	Function
0	Disable
1	Enable

 **Note** This function is aimed at controlling the torque during deceleration; it has no effect if there is a braking load. Enabling the automatic deceleration (anti-regenerative control, H69 = 2 or 4) in the torque limit control mode disables the deceleration characteristics specified by H71.

H72 Main Power Down Detection (Mode selection)

H72 monitors the inverter alternate-current input power source, and disables the inverter operation if it is not established.

Data for H72	Function
0	Disable
1	Enable

In cases where the power is supplied via a PWM converter or the inverter is connected via the DC link bus, there is no alternate-current input. In such cases, set H72 data to "0," otherwise the inverter cannot operate.

H73 to H75 Torque Limiter (Operating conditions, Control target, and Target quadrants) (Refer to F40.)

H76 Torque Limiter (Frequency increment limit for braking) (Refer to H69.)

H77 Service Life of DC Link Bus Capacitor (Remaining time)

H77 displays the remaining time before the service life of DC link bus capacitor expires.

At the time of a printed circuit board replacement, transfer the service life data of the DC link bus capacitor to the new board.

- Data setting range: 0 to 87600 (hours)

H78, H79 Maintenance Interval (M1), Preset Startup Count for Maintenance (M1) (Refer to H44.)

H80 Output Current Fluctuation Damping Gain for Motor 1

The inverter output current driving the motor may fluctuate due to the motor characteristics and/or backlash in the machinery (load). Modifying the H80 data adjusts the controls in order to suppress such fluctuation. However, as incorrect setting of this gain may cause larger current fluctuation, do not modify the default setting unless it is necessary.

- Data setting range: 0.00 to 1.00

H81, H82 Light Alarm Selection 1 and 2

If the inverter detects a minor abnormal state "light alarm", it can continue the current operation without tripping while displaying the "light alarm" indication $L-FL$ on the LED monitor. In addition to the indication $L-FL$, the inverter displays the "L-ALARM" (blinking) on the LCD monitor and outputs the "light alarm" signal $L-ALM$ to a digital output terminal to alert the peripheral equipment to the occurrence of a light alarm. (To use the $L-ALM$, it is necessary to assign the signal to any of the digital output terminals by setting any of function codes E20 through E24 and E27 to "98.")

Select the desired items to be regarded as a light alarm from the following table.

Code	Name	Description
$OH1$	Heat sink overheating	Heat sink temperature increased to the trip level.
$OH2$	External alarm	An error that has occurred in peripheral equipment turned the external alarm signal THR ON.
$OH3$	Inverter internal overheating	The temperature inside the inverter abnormally has increased.
OBH	Braking resistor overheating	Estimated temperature of the coil in the braking resistor exceeded the allowable level.
$OL1$ to $OL4$	Overload of motor 1 through 4	Motor temperature calculated with the inverter output current reached the trip level.
$Er4$	Option communications error	Communications error between the inverter and an option.
$Er5$	Option error	An option judged that an error occurred.
$Er8$ ErP	RS-485 communications error (COM port 1) RS-485 communications error (COM port 2)	RS-485 communications error between the COM ports 1 and 2.
ErE	Speed mismatch or excessive speed deviation	The deviation of the automatic speed regulator (between the reference speed and the detected one) is out of the specified range (d21) for the period specified by d22.
CoF	PID feedback wire break	The PID feedback signal wire(s) is broken.
FAL	DC fan locked	Failure of the air circulation DC fan inside the inverter. 230 V series: 75 HP or above 460 V series: 125 HP or above
OL	Motor overload early warning	Early warning before a motor overload
OH	Heat sink overheating early warning	Early warning before a heat sink overheating trip

H codes

Code	Name	Description
L_{IF}	Lifetime alarm	It is judged that the service life of any one of the capacitors (DC link bus capacitors and electrolytic capacitors on the printed circuit boards) and cooling fan has expired. Or, failure of the air circulation DC fan inside the inverter. 230 V series: 75 HP or above 460 V series: 125 HP or above
r_{EF}	Reference command loss detected	Analog frequency command was lost.
P_{id}	PID alarm	Warning related to PID control (absolute-value alarm or deviation alarm)
L_{iL}	Low torque output	Output torque drops below the low torque detection level for the specified period.
P_{TC}	PTC thermistor activated	The PTC thermistor on the motor detected a temperature.
r_{rE}	Inverter life (Motor cumulative run time)	The motor cumulative run time reached the specified level.
L_{rI}	Inverter life (Number of startups)	Number of startups reached the specified level.
E_{rO}	Positioning control error	In synchronous operation, a positioning deviation has become excessive. (See the PG Interface Card instruction manual.) Note: Even if a positioning control error is regarded as a light alarm with H82, the error that occurred when the inverter was servo-locked does not cause a light alarm operation but trips the inverter.

Set data for selecting "light alarms" in hexadecimal. For details on how to select the codes, refer to the next page.
- Data setting range: 0000 to FFFF (Hexadecimal)

■ Selecting light alarm factors

To set and display the light alarm factors in hexadecimal format, each light alarm factor has been assigned to bits 0 to 15 as listed in Tables 5.1 and 5.2. Set the bit that corresponds to the desired light alarm factor to "1." Table 5.3 shows the relationship between each of the light alarm factor assignments and the LED monitor display.

Table 5.4 gives the conversion table from 4-bit binary to hexadecimal.

Table 5.1 Light Alarm Selection 1 (H81), Bit Assignment of Selectable Factors

Bit	Code	Content	Bit	Code	Content
15	—	—	7	$OL3$	Overload of motor 3
14	—	—	6	$OL2$	Overload of motor 2
13	E_{rP}	RS-485 communications error (COM port 2)	5	$OL1$	Overload of motor 1
12	E_{rB}	RS-485 communications error (COM port 1)	4	OBH	Braking resistor overheated
11	E_{rS}	Option error	3	—	—
10	E_{rY}	Option communications error	2	$OH3$	Inverter internal overheat
9	—	—	1	$OH2$	External alarm
8	$OL4$	Overload of motor 4	0	$OH1$	Heat sink overheat

Table 5.2 Light Alarm Selection 2 (H82), Bit Assignment of Selectable Factors

Bit	Code	Content	Bit	Code	Content
15	—	—	7	L_{IF}	Lifetime alarm
14	—	—	6	OH	Heat sink overheat early warning
13	L_{rI}	Inverter life (Number of startups)	5	OL	Motor overload early warning
12	r_{rE}	Inverter life (Cumulative motor run time)	4	FFL	DC fan locked
11	P_{TC}	PTC thermistor activated	3	L_{oF}	PID feedback wire break
10	L_{iL}	Low torque output	2	E_{rO}	Positioning control error
9	P_{id}	PID alarm	1	—	—
8	r_{EF}	Reference command loss detected	0	E_{rE}	Speed mismatch or excessive speed deviation

Table 5.3 Display of Light Alarm Factor

(Example) Light alarm factors "RS-485 communications error (COM port 2)," "RS-485 communications error (COM port 1)," "Option communications error," "Overload of motor 1" and "Heat sink overhear" are selected by H81.

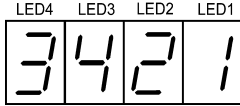
LED No.	LED4				LED3				LED2				LED1			
Bit	15	14	13	12	11	10	9	8	7	6	5	4	3	2	1	0
Code	—	—	<i>ErP</i>	<i>ErB</i>	<i>ErS</i>	<i>ErY</i>	—	<i>OL4</i>	<i>OL3</i>	<i>OL2</i>	<i>OL1</i>	<i>dbH</i>	—	<i>OH3</i>	<i>OH2</i>	<i>OH1</i>
Example	Binary				Binary				Binary				Binary			
	0 0 1 1				0 1 0 0				0 0 1 0				0 0 0 1			
	Hexa-decimal (See Table 5.4.)				Hexa-decimal (See Table 5.4.)				Hexa-decimal (See Table 5.4.)				Hexa-decimal (See Table 5.4.)			
Hexa-decimal on the LED monitor				Hexa-decimal on the LED monitor				Hexa-decimal on the LED monitor				Hexa-decimal on the LED monitor				
				<div style="display: flex; justify-content: space-around; font-size: small;"> LED4LED3LED2LED1 </div> 												

■ Hexadecimal expression

A 4-bit binary number can be expressed in hexadecimal format (1 hexadecimal digit). The table below shows the correspondence between the two notations. The hexadecimals are shown as they appear on the LED monitor.

Table 5.4 Binary and Hexadecimal Conversion

Binary				Hexadecimal	Binary				Hexadecimal
0	0	0	0	<i>0</i>	1	0	0	0	<i>0</i>
0	0	0	1	<i>1</i>	1	0	0	1	<i>1</i>
0	0	1	0	<i>2</i>	1	0	1	0	<i>2</i>
0	0	1	1	<i>3</i>	1	0	1	1	<i>3</i>
0	1	0	0	<i>4</i>	1	1	0	0	<i>4</i>
0	1	0	1	<i>5</i>	1	1	0	1	<i>5</i>
0	1	1	0	<i>6</i>	1	1	1	0	<i>6</i>

Note With the H26 data being set to "1" (PTC (The inverter immediately trips with *OL4* displayed)), if the PTC thermistor is activated, the inverter does not perform light alarm processing but stops its output, regardless of the assignment of bit 11 (PTC thermistor activated) by H82 (Light Alarm Selection 2).

■ Light alarm--**L-ALM** (E20 to E24 and E27, data = 98)

This output signal comes ON when a light alarm occurs.

H84, H85 Pre-excitation (Initial level, Time)

A motor generates torque with magnetic flux and torque current. Lag elements of the rising edge of magnetic flux causes a phenomenon in which enough torque is not generated at the moment of the motor start. To obtain enough torque even at the moment of motor start, enable the pre-excitation with H84 and H85 so that magnetic flux is established before a motor start.

- Pre-excitation (Initial level) (H84) Data setting range: 100 to 400 (%) (Ratio to the motor's no-load current)

H84 specifies the forcing function for the pre-excitation. It is used to shorten the pre-excitation time. Basically, there is no need to modify the default setting.

- Pre-excitation (Time) (H85) Data setting range: 0.00 (Disable), 0.01 to 30.00 (s)

H85 specifies the pre-excitation time before starting operation. When a run command is inputted, the pre-excitation starts. After the pre-excitation time specified by H85 has elapsed, the inverter judges magnetic flux to have been established and starts acceleration. Specify H85 data so that enough time is secured for establishing magnetic flux. The appropriate value for H85 data depends on the motor capacity. Use the default setting value of H13 data as a guide.

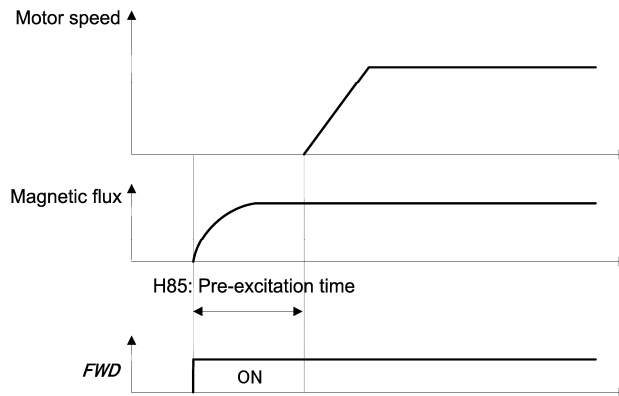

- Pre-excitation--**EXITE** (E01 to E07, data = 32)

Turning this input signal ON starts pre-excitation.

After the delay time for establishing magnetic flux has elapsed, a run command is inputted. Inputting the run command terminates pre-excitation and starts acceleration.

Use an external sequence to control the time for establishing magnetic flux.

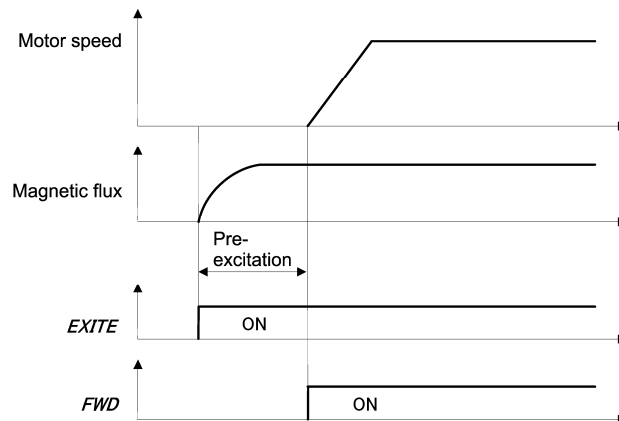

Note Under V/f control (including auto torque boost and torque vector), pre-excitation is disabled, so use DC braking or hold the starting frequency instead.

Note A transient phenomenon, which may occur when the amount of mechanical loss is small, may rotate the motor during pre-excitation. If a motor rotation during pre-excitation is not allowed in your system, install a mechanical brake or other mechanism to stop the motor.

WARNING

Even if the motor stops due to pre-excitation, voltage is output to inverter's output terminals U, V, and W.

An electric shock may occur.

H86 to H90 Reserved for particular manufacturers

H86 to H90 are reserved for particular manufacturers. Do not modify the settings.

H91 PID Feedback Wire Break Detection

Using the terminal [C1] (current input) for PID feedback signal enables wire break detection and alarm (\overline{LOF}) issuance. H91 specifies whether the wire break detection is enabled, or the duration of detection. (The inverter judges an input current to the terminal [C1] below 2 mA as a wire break.)

- Data setting range: 0.0 (Disable alarm detection)
0.1 to 60.0 s (Detect wire break and issue \overline{LOF} alarm within the time)

H92, H93 Continuity of Running (P and I) (Refer to F14.)

H94 Cumulative Motor Run Time 1 (Refer to H44.)

H95 DC Braking (Braking response mode) (Refer to F20 through F22.)

H96 STOP Key Priority/Start Check Function

H96 specifies a functional combination of "STOP key priority" and "Start check function" as listed below.

Data for H96	STOP key priority	Start check function
0	Disable	Disable
1	Enable	Disable
2	Disable	Enable
3	Enable	Enable

■ **STOP key priority**

Even when run commands are entered from the digital input terminals or via the RS-485 communications link (link operation), pressing the STOP key forces the inverter to decelerate and stop the motor. After that, \overline{ErE} appears on the LED monitor.

■ **Start check function**

For safety, this function checks whether any run command has been turned ON or not in each of the following situations. If one has been turned ON, the inverter does not start up but displays alarm code \overline{ErE} on the LED monitor.

- When the power to the inverter is turned ON.
- When the RESET key is pressed to release an alarm status or when the digital input terminal command **RST** ("Reset alarm") is turned ON.
- When the run command source is switched by a digital input terminal command such as **LE** ("Enable communications link via RS-485 or fieldbus") or **LOC** ("Select local (keypad) operation").

H codes

H97 Clear Alarm Data H45 (Mock Alarm)

H97 clears alarm data (alarm history and relevant information) stored in the inverter.

To clear alarm data, simultaneous keying of " STOP key + STOP key" is required.

Data for H97	Function
0	Disable
1	Enable (Setting "1" clears alarm data and then returns to "0.")

H98 Protection/Maintenance Function (Mode selection)

H98 specifies whether to enable or disable automatic lowering of carrier frequency, input phase loss protection, output phase loss protection, judgment threshold on the life of DC link bus capacitor, judgment on the life of DC link bus capacitor, DC fan lock detection, braking transistor error detection, and IP20/IP40 switching, in combination (Bit 0 to Bit 7).

Automatic lowering of carrier frequency (Bit 0) (Under V/f control only)

This function should be used for important machinery that requires keeping the inverter running.

Even if a heat sink overheat or overload occurs due to excessive load, abnormal surrounding temperature, or cooling system failure, enabling this function lowers the carrier frequency to avoid tripping (\overline{OH} , $\overline{H3}$ or \overline{OL}). Note that enabling this function results in increased motor noise.

Input phase loss protection (\overline{L} / \overline{r}) (Bit 1)

Upon detection of an excessive stress inflicted on the apparatus connected to the main circuit due to phase loss or line-to-line voltage unbalance in the three-phase power supplied to the inverter, this feature stops the inverter and displays an alarm \overline{L} / \overline{r} .

Note In configurations where only a light load is driven or a DC reactor is connected, phase loss or line-to-line voltage unbalance may not be detected because of the relatively small stress on the apparatus connected to the main circuit.

Output phase loss protection (\overline{OPL}) (Bit 2)

Upon detection of phase loss in the output while the inverter is running, this feature stops the inverter and displays an alarm \overline{OPL} .

Note Where a magnetic contactor is installed in the inverter output circuit, if the magnetic contactor goes OFF during operation, all the phases will be lost. In such a case, this protection feature does not work.

Judgment threshold on the life of DC link bus capacitor (Bit 3)

Bit 3 is used to select the threshold for judging the life of the DC link bus capacitor--the factory default level or user-setup one.

Note Before specifying a user-defined threshold, measure and confirm the reference level beforehand.
(Refer to the description of H42.)

Judgment on the life of DC link bus capacitor (Bit 4)

Whether the DC link bus capacitor has reached its life is determined by measuring the length of time for discharging after power OFF. The discharging time is determined by the capacitance of the DC link bus capacitor and the load inside the inverter. Therefore, if the load inside the inverter fluctuates significantly, the discharging time cannot be accurately measured, and as a result, it may be mistakenly determined that the life has been reached. To avoid such an error, you can disable the judgment on the life of the DC link bus capacitor. (Even if it is disabled, the judgment based on the "ON-time counting" while the voltage is applied to the DC link bus capacitor is continued.) For details, refer to the description of H42.

Since load may vary significantly in the following cases, disable the judgment on the life during operation. Either conduct the measurement with the judgment enabled under appropriate conditions during periodical maintenance or conduct the measurement under the operating conditions matching the actual ones.

- Auxiliary input for control power is used.
- An option card or remote keypad is used.
- Another inverter or equipment such as a PWM converter is connected to terminals of the DC link bus.

DC fan lock detection (Bit 5) (75 HP or above for 230 V series, 125 HP or above for 460 V series)

Inverters specified above are equipped with an internal air circulation DC fan. When the inverter detects that the DC fan is locked by a failure or other cause, you can select either continuing the inverter operation or entering into alarm state.

Entering alarm state: The inverter issues the alarm $\overline{H1}$ and coasts to stop the motor.

Continuing operation: The inverter does not enter the alarm mode, and continues operation of the motor.

Note that, however, the inverter turns ON the **OH** and **LIFE** signals on the transistor output terminals whenever the DC fan lock is detected regardless of your selection.

Note If the ON/OFF control of the cooling fan is enabled (H06 = 1), the cooling fan may stop depending on operating condition of the inverter. In this case, the DC fan lock detection feature is considered normal (e.g.; the cooling fan is normally stopped by the stop fan command.) so that the inverter may turn OFF the **LIFE** or **OH** signal output, or enable to cancel the alarm $\overline{H1}$, even if the internal air circulation DC fan is locked due to a failure etc. (When you start the inverter in this state, it automatically issues the run fan command, then the inverter detects the DC fan lock state, and turn ON the **LIFE** or **OH** output or enters the alarm $\overline{H1}$ state.)

Note that, operating the inverter under the condition that the DC fan is locked for long time may shorten the life of electrolytic capacitors on the PCBs due to local high temperature inside the inverter. Be sure to check with the *LIFE* signal etc., and replace the broken fan as soon as possible.

Braking transistor error detection (Bit 6) $\frac{0}{1}$ (40 HP or below)

Upon detection of a built-in braking transistor error, this feature stops the inverter and displays an alarm $\frac{0}{1}$. Set data of this bit to "0" when the inverter does not use a braking transistor and there is no need of entering an alarm state.

Switch IP20/IP40 enclosure (Bit 7) (for basic type of inverters only)

Mounting an IP40 option to inverters of 40 HP or below enables them to conform to IP40. In such a case, switch Bit 7 to "1" for the protection coordination.

For details, refer to the instruction manual of the IP40 option.

To set data of function code H98, assign the setting of each function to each bit and then convert the 8-bit binary to the decimal number.

Refer to the assignment of each function to each bit and a conversion example below.

Bit	Function	Bit data = 0	Bit data = 1	Factory default
0	Lower the carrier frequency automatically	Disable	Enable	1: Enable
1	Detect input phase loss	Continue to run	Enter alarm processing	1: Enter alarm processing
2	Detect output phase loss	Continue to run	Enter alarm processing	0: Continue to run
3	Select life judgment threshold of DC link bus capacitor	Factory default	User-defined setting	0: Factory default
4	Judge the life of DC link bus capacitor	Disable	Enable	1: Enable
5	Detect DC fan lock	Enter alarm processing	Continue to run	0: Enter alarm processing
6	Detect braking transistor error	Continue to run	Enter alarm processing	1: Enter alarm processing
7	Switch IP20/IP40 enclosure	IP20	IP40	0: IP20

An example of conversion from binary to decimal (for the number configured by the factory default setting shown above)

$$\begin{aligned}
 \text{Decimal} &= \text{Bit } 7 \times 2^7 + \text{Bit } 6 \times 2^6 + \text{Bit } 5 \times 2^5 + \text{Bit } 4 \times 2^4 + \text{Bit } 3 \times 2^3 + \text{Bit } 2 \times 2^2 + \text{Bit } 1 \times 2^1 + \text{Bit } 0 \times 2^0 \\
 &= \text{Bit } 7 \times 128 + \text{Bit } 6 \times 64 + \text{Bit } 5 \times 32 + \text{Bit } 4 \times 16 + \text{Bit } 3 \times 8 + \text{Bit } 2 \times 4 + \text{Bit } 1 \times 2 + \text{Bit } 0 \times 1 \\
 &= 0 \times 128 + 1 \times 64 + 0 \times 32 + 1 \times 16 + 0 \times 8 + 0 \times 4 + 1 \times 2 + 1 \times 1 \\
 &= 64 + 16 + 2 + 1 \\
 &= 83
 \end{aligned}$$

5.2.6 A codes (Motor 2 Parameters), b codes (Motor 3 Parameters), r codes (Motor 4 Parameters)

The FRENIC-MEGA can switch control parameters even when it is running so that a single inverter can drive four motors by switching them or turn the energy saving operation ON or OFF for the setup change (e.g., gear switching) that causes the moment of inertia of the machinery to change.

Function code	Motor to drive	Remarks
F/E/P and other codes	Motor 1	Including function codes commonly applied to motors 1 to 4.
A codes	Motor 2	
b codes	Motor 3	
r codes	Motor 4	

Note This manual describes function codes applied to motor 1 only. For ones applied to motors 2 to 4 except A42, b42, and r42 (Motor/Parameter Switching 2 to 4), refer to the corresponding function codes prepared for motor 1 in Table 5.5 on the next page.

A42, b42 r42 Motor/Parameter Switching 2, 3, and 4 (Mode selection)

d25 (ASR Switching Time)

The combination of digital input terminal commands **M2**, **M3** and **M4** (Select motor 2, 3 and 4) switches between the 1st, 2nd, 3rd and 4th motors as listed below. (Function codes E01 through E07, data = 12, 36, or 37) When the motor is switched, the function code group with which the inverter drives the motor is also switched to the corresponding one.

At the same time, the inverter outputs the corresponding signal from the "Motor 1 selected" signal **SWM1** through the "Motor 4 selected" signal **SWM4** (Function codes E20 through E27 data = 48, 49, 50, or 51) in order to switch the external switch to that selected motor.

Terminal command			Inverter-driven motor selected (Function code group enabled)	Output signals			
M2	M3	M4		SWM1	SWM2	SWM3	SWM4
OFF	OFF	OFF	1st motor (Default codes)	ON	OFF	OFF	OFF
ON	—	—	2nd motor (A codes)	OFF	ON	OFF	OFF
OFF	ON	—	3rd motor (b codes)	OFF	OFF	ON	OFF
OFF	OFF	ON	4th motor (r codes)	OFF	OFF	OFF	ON

A42, b42 or r42 selects whether the combination of terminal commands **M2**, **M3** and **M4** switches the actual motors (to the 2nd, 3rd, and 4th motors) or the particular parameters (A codes, b codes, or r codes).

Data for A42, b42 or r42	Function	Switching is possible:
0	Motor (Switch to the 2nd, 3rd or 4th motor)	Only when the inverter is stopped (all run commands are OFF).
1	Parameter (Switch to particular A codes, b codes or r codes)	Even when the inverter is running.

Note From the point of view of signal timing, a combination of **M2**, **M3** and **M4** must be determined at least 2 ms before the signal of a run command is established.

If A42, b42 or r42 is set to "0" (Motor (Switch to the 2nd, 3rd or 4th motor)), the combination of **M2**, **M3** and **M4** switches the motor to any of the 2nd to 4th motors and also switches the function code group enabled to the one corresponding to the selected motor, as listed in Table 5.5. Note that, however, the functions listed in Table 5.6 are unavailable when any of the 2nd to 4th motors are selected.

If A42, b42 or r42 is set to "1" (Parameter (Switch to particular A codes, b codes or r codes)), the combination of **M2**, **M3** and **M4** switches the particular parameters marked with Y in the "Object of parameter switching" column in Table 5.5. For other parameters, ones in the 1st motor column remain effective.

Table 5.5 Function Codes to be Switched

Name	Function code				Object of parameter switching
	1st motor	2nd motor	3rd motor	4th motor	
Maximum frequency	F03	A01	b01	r01	
Base frequency	F04	A02	b02	r02	
Rated voltage at base frequency	F05	A03	b03	r03	
Maximum output voltage	F06	A04	b04	r04	
Torque boost	F09	A05	b05	r05	
Electronic thermal overload protection for motor (Select motor characteristics) (Overload detection level) (Thermal time constant)	F10	A06	b06	r06	
	F11	A07	b07	r07	
	F12	A08	b08	r08	
DC braking (Braking starting frequency) (Braking level) (Braking time)	F20	A09	b09	r09	
	F21	A10	b10	r10	
	F22	A11	b11	r11	
Starting frequency	F23	A12	b12	r12	
Load selection/ Auto torque boost/ Auto energy saving operation	F37	A13	b13	r13	Y
Drive control selection	F42	A14	b14	r14	
Motor (No. of poles) (Rated capacity) (Rated current) (Auto-tuning) (Online tuning) (No-load current) (%R1) (%X) (Slip compensation gain for driving) (Slip compensation response time) (Slip compensation gain for braking) (Rated slip frequency) (Iron loss factor 1) (Iron loss factor 2) (Iron loss factor 3) (Magnetic saturation factor 1) (Magnetic saturation factor 2) (Magnetic saturation factor 3) (Magnetic saturation factor 4) (Magnetic saturation factor 5) (Magnetic saturation extension factor "a") (Magnetic saturation extension factor "b") (Magnetic saturation extension factor "c")	P01	A15	b15	r15	
	P02	A16	b16	r16	
	P03	A17	b17	r17	
	P04	A18	b18	r18	
	P05	A19	b19	r19	
	P06	A20	b20	r20	
	P07	A21	b21	r21	
	P08	A22	b22	r22	
	P09	A23	b23	r23	Y
	P10	A24	b24	r24	Y
	P11	A25	b25	r25	Y
	P12	A26	b26	r26	
	P13	A27	b27	r27	
	P14	A28	b28	r28	
	P15	A29	b29	r29	
	P16	A30	b30	r30	
	P17	A31	b31	r31	
	P18	A32	b32	r32	
	P19	A33	b33	r33	
	P20	A34	b34	r34	
	P21	A35	b35	r35	
	P22	A36	b36	r36	
	P23	A37	b37	r37	
Motor selection	P99	A39	b39	r39	
Slip compensation (Operating conditions)	H68	A40	b40	r40	Y
Output current fluctuation damping gain for motor	H80	A41	b41	r41	Y

Table 5.5 Function Codes to be Switched (Continued)

Name	Function code				Object of parameter switching
	1st motor	2nd motor	3rd motor	4th motor	
Speed control (Speed command filter) (Speed detection filter) P (Gain) I (Integral time) (Output filter) (Notch filter resonance frequency) (Notch filter attenuation level)	d01	A43	b43	r43	Y
	d02	A44	b44	r44	Y
	d03	A45	b45	r45	Y
	d04	A46	b46	r46	Y
	d06	A48	b48	r48	Y
	d07	A49	b49	r49	
	d08	A50	b50	r50	
	Cumulative motor run time	H94	A51	b51	r51
Startup counter for motor	H44	A52	b52	r52	
Motor (%X correction factor 1) (%X correction factor 2) (Torque current under vector control) (Induced voltage factor under vector control)	P53	A53	b53	r53	
	P54	A54	b54	r54	
	P55	A55	b55	r55	
	P56	A56	b56	r56	
Reserved for particular manufacturers	d51	d52	d53	d54	
	P57	A57	b57	r57	

Table 5.6 Function Codes Unavailable for the 2nd to 4th Motors

Name	Function codes	Operation in 2nd to 4th motors
Non-linear V/f pattern	H50 to H53, H65, H66	Disabled
Starting frequency 1 (Holding time)	F24	Disabled
Stop frequency (Holding time)	F39	Disabled
Overload early warning/Current detection	E34, E35	Disabled
Droop control	H28	Disabled
UP/DOWN control (Initial frequency setting)	H61	Fixed at the initial setting (0 Hz)
PID control	J01 to J06, J08 to J13, J15 to J19, J56 to J62, E40, E41, H91	Disabled
Dew condensation prevention	J21, F21, F22	Disabled
Brake signal	J68 to J72, J95, J96	Disabled
Current limiter	F43, F44	Disabled
Rotational direction limitation	H08	Disabled
Pre-excitation	H84, H85	Disabled
Maintenance Interval/ Preset Startup Count for Maintenance	H78, H79	Disabled
NTC thermistor	H26, H27	Disabled

■ ASR Switching Time (d25) Data setting range: 0.000 to 1.000 (s)

Parameter switching is possible even during operation. For example, speed control P (Gain) and I (Integral time) listed in Table 5.5 can be switched.

Switching these parameters during operation may cause an abrupt change of torque and result in a mechanical shock, depending on the driving condition of the load.

To reduce such a mechanical shock, the inverter decreases the abrupt torque change using the ramp function of ASR Switching Time (d25).

5.2.7 J codes (Application Functions 1)

J01 PID Control (Mode selection)

Under PID control, the inverter detects the state of a control target object with a sensor or the similar device and compares it with the commanded value (e.g., temperature control command). If there is any deviation between them, the PID control operates so as to minimize it. That is, it is a closed loop feedback system that matches controlled variable (feedback amount). The PID control expands the application area of the inverter to the process control (e.g., flow control, pressure control, and temperature control) and the speed control (e.g., dancer control).

If PID control is enabled (J01 = 1, 2 or 3), the frequency control of the inverter is switched from the drive frequency command generator block to the PID command generator block.

Mode Selection (J01)

J01 selects the PID control mode.

Data for J01	Function
0	Disable
1	Enable (Process control, normal operation)
2	Enable (Process control, inverse operation)
3	Enable (Dancer control)

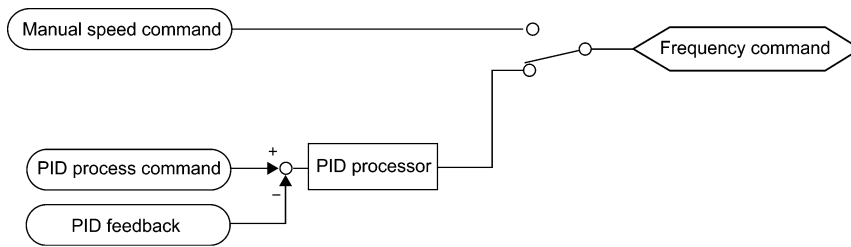

PID process control block diagram

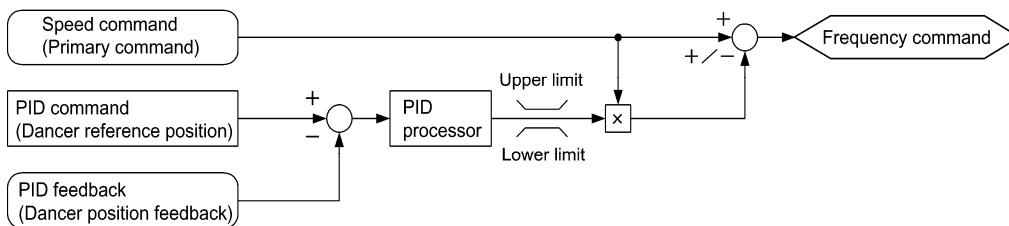
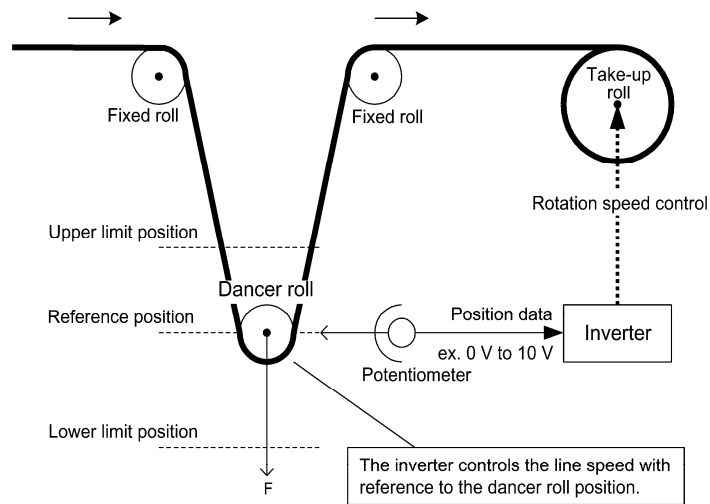

PID dancer control block diagram

Using J01 enables switching between normal and inverse operations against the PID control output, so you can specify an increase/decrease of the motor rotating speed to the difference (error component) between the commanded (input) and feedback amounts, making it possible to apply the inverter to air conditioners. The terminal command *IVS* can also switch operation between normal and inverse.

For details about the switching of normal/inverse operation, refer to the description of Switch normal/inverse operation *IVS* (E01 to E07, data = 21).

■ **Configuring the manual speed command/primary frequency command with the \odot and \ominus keys under PID control**

When function code F01 is set at "0" (\odot / \ominus keys on keypad) and frequency command 1 is selected as a manual speed command or primary frequency command (Frequency setting via communications link: Disabled; Multi-frequency setting: Disabled; PID control: Disabled), defining the LED monitor as a speed monitor in Running mode enables modification of the manual speed command or primary frequency command using the \odot and \ominus keys.

In Programming or Alarm mode, the manual speed command or primary frequency command cannot be modified with the \odot and \ominus keys, so switch to Running mode beforehand.

The figure below illustrates how the manual speed command or primary frequency command ① entered via the keypad is translated to the final manual speed command/final primary frequency command ②.

The configuration procedure is the same as that for usual frequency setting.

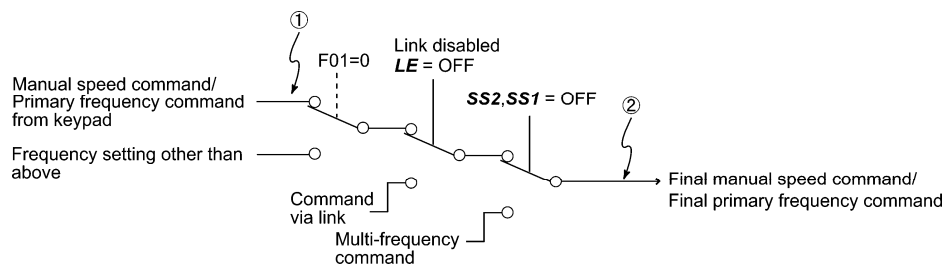

J02 PID Control (Remote command SV)

J02 sets a command source that specifies a command value (*SV*) to apply under PID control.

Data for J02	Function	Refer to:
0	\odot / \ominus keys on keypad Specify the PID command using the \odot / \ominus keys on the keypad.	[1]
1	PID command 1 (Analog input: Terminals [12], [C1] and [V2]) Voltage input to the terminal [12] (0 to ± 10 VDC, 100% PID command/ ± 10 VDC) Current input to the terminal [C1] (4 to 20 mA DC, 100% PID command/ 20 mA DC) Voltage input to the terminal [V2] (0 to ± 10 VDC, 100% PID command/ ± 10 VDC)	[2]
3	Terminal command <i>UP/DOWN</i> Using the <i>UP</i> or <i>DOWN</i> command in conjunction with PID display coefficients (specified by E40 and E41) with which the command value is transformed to virtual physical value etc., you can specify 0 to 100% of the PID command ($\pm 100\%$ for PID dancer control).	[3]
4	Command via communications link Use function code S13 that specifies the communications-linked PID command. The transmission data of 20000 (decimal) is equal to 100% (maximum frequency) of the PID command.	[4]

[1] PID command with the \triangleleft / \triangleright keys on the keypad (J02 = 0, factory default)

Configuring the PID command (PID process command or PID dancer position command) with the \triangleleft and \triangleright keys

- (1) To enable PID process control, set function code J01 at "1" or "2."
To enable PID dancer control, set function code J01 at "3."
- (2) Set function code J02 at "0" (\triangleleft / \triangleright keys on keypad).
- (3) Set the LED monitor to something other than the speed monitor (E43 = 0) when the inverter is in Running mode.
In Programming or Alarm mode, the PID command cannot be modified with the \triangleleft and \triangleright keys, so switch to Running mode beforehand.
- (4) Press the \triangleleft or \triangleright key.

The 7-segment LED monitor displays the PID command and the LCD monitor displays the related information including the operation guide, as shown below.

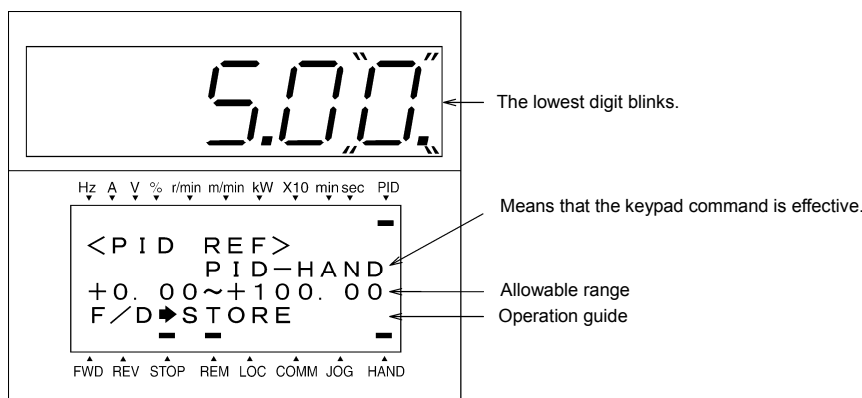

Example of PID Command Configuration Screen

Tip On the LED monitor, the decimal point of the lowest digit is used to characterize what is displayed. The decimal point of the lowest digit blinks when a PID command is displayed; the decimal point lights when a PID feedback amount is displayed.

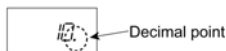

- (5) To change the PID command, press the \triangleleft or \triangleright key again. To save the new setting into the inverter's memory, press the P/D key (when E64 = 1 (factory default)). When the power is turned ON next time, the new setting will be used as an initial reference frequency.

In addition to saving with the P/D key described above, "Automatic saving when the main power is turned OFF" is also possible (when E64 = 0).

- Tip**
- Using the \triangleleft / \triangleright keys on the keypad in conjunction with PID display coefficients (specified by E40 and E41), you can specify 0 to 100% of the PID process command ($\pm 100\%$ of the PID dancer position command) in an easy-to-understand converted command format.
 - Even if multi-frequency is selected as a PID command (SS4 or SS8 = ON), setting the PID command with the keypad is possible.
 - When function code J02 is set to any value other than "0," pressing the \triangleleft or \triangleright key displays, on the LED monitor, the PID command currently selected, but cannot change the setting. The LCD monitor displays the following.

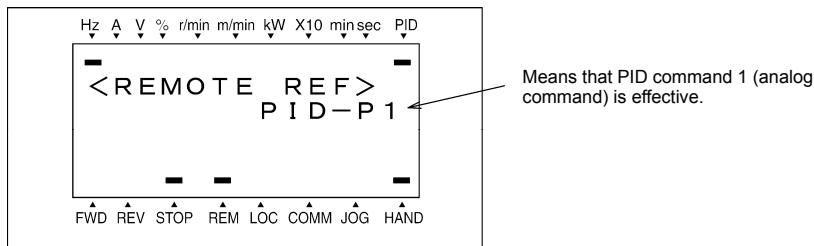

PID Command Manually Specified with \triangleleft and \triangleright Keys and Requirements

PID control (Mode selection) J01	PID control (Remote command SV) J02	LED monitor E43	Multi-frequency SS4, SS8	Display during \triangleleft / \triangleright key operation
1 or 2	0	Other than 0	ON or OFF	PID process command <u>by keypad</u>
	Other than 0			PID process command <u>currently selected</u>
3	0			PID dancer position command <u>by keypad</u>
	Other than 0			PID dancer position command <u>currently selected</u>

[2] PID command by analog inputs (J02 = 1)

When any analog input (voltage input to terminals [12] and [V2], or current input to terminal [C1]) for PID command 1 (J02 = 1) is used, it is possible to arbitrary specify the PID command by multiplying the gain and adding the bias. The polarity can be selected and the filter time constant and offset can be adjusted. In addition to J02 setting, it is necessary to select PID command 1 for analog input (specified by any of E61 to E63, function code data = 3). For details, refer to the descriptions of E61 to E63.

Adjustable elements of PID command

Input terminal	Input range	Bias		Gain		Polarity	Filter time constant	Offset
		Bias	Base point	Gain	Base point			
[12]	0 to +10 V, -10 to +10V	C51	C52	C32	C34	C35	C33	C31
[C1]	4 to 20 mA			C37	C39	-	C38	C36
[V2]	0 to +10 V, -10 to +10 V			C42	C44	C45	C43	C41

■ Offset (C31, C36, C41)

C31, C36 or C41 configures an offset for an analog voltage/current input. The offset also applies to signals sent from the external equipment.

■ Filter time constant (C33, C38, C43)

C33, C38, and C43 provide the filter time constants for the voltage and current of the analog input. Choose appropriate values for the time constants considering the response speed of the machinery system, as large time constants slow down the response. If the input voltage fluctuates because of noise, specify large time constants.

■ Polarity (C35, C45)

C35 and C45 specify the input range for analog input voltage.

Data for C35 and C45	Terminal input specifications
0	-10 to +10 V
1	0 to +10 V (negative value of voltage is regarded as 0 V)

■ Gain and bias

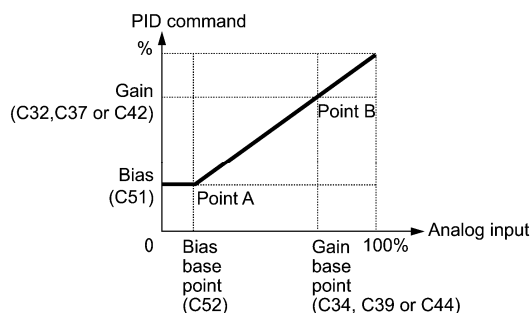

(Example) Mapping the range of 1 through 5 V at terminal [12] to 0 through 100%

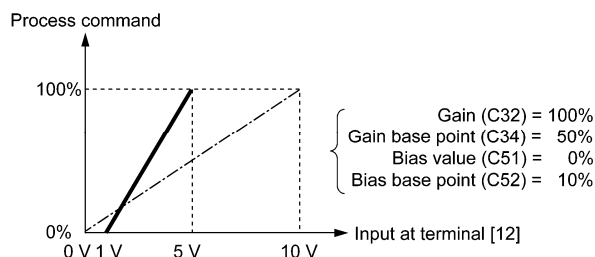

[3] PID command with UP/DOWN control (J02 = 3)

When the *UP/DOWN* control is selected as a PID command, turning the terminal command *UP* or *DOWN* ON causes the PID command to change within the range from 0 to 100%.

The PID command can be specified in mnemonic physical quantities (such as temperature or pressure) with the PID display coefficients (E40, E41).

To select the *UP/DOWN* control as a PID command, the *UP* and *DOWN* should be assigned to the digital input terminals [X1] to [X7]. (E01 to E07, data = 17, 18)

UP	DOWN	Function
Data = 17	Data = 18	
OFF	OFF	Retain PID command value.
ON	OFF	Increase PID command value at a rate between 0.1%/0.1 s and 1%/0.1 s.
OFF	ON	Decrease PID command value at a rate between 0.1%/0.1 s and 1%/0.1 s.
ON	ON	Retain PID command value.

Note The inverter internally holds the PID command value set by the *UP/DOWN* control and applies the held value at the next restart (including powering ON).

[4] PID command via communications link (J02 = 4)

Use function code S13 that specifies the communications-linked PID command. The transmission data of 20000 (decimal) is equal to 100% (maximum frequency) of the PID command. For details of the communications format, refer to the RS-485 Communication User's Manual.

Note Other than the remote command selection by J02, the multi-frequency 4, 8 or 12 (specified by C08, C12 or C16, respectively) specified by terminal commands *SS4* and *SS8* can also be selected as a preset value for the PID command.

Calculate the setting data of the PID command using the expression below.

$$\text{PID command data (\%)} = \frac{\text{Preset multi-frequency}}{\text{Maximum frequency}} \times 100$$

- In dancer control (J01 = 3), the setting from the keypad interlocks with data of J57 (PID control: Dancer reference position), and is saved as function code data.

Selecting Feedback Terminals

For feedback control, determine the connection terminal according to the type of the sensor output.

- If the sensor is a current output type, use the current input terminal [C1] of the inverter.
- If the sensor is a voltage output type, use the voltage input terminal [12] of the inverter, or switch over the terminal [V2] to the voltage input terminal and use it.

 For details, refer to the descriptions of E61 through E63.

Application example: Process control (for air conditioners, fans and pumps)

The operating range for PID process control is internally controlled as 0% through 100%. For the given feedback input, determine the operating range to be controlled by means of gain adjustment.

Example: When the output level of the external sensor is within the range of 1 to 5 V:

- Use terminal [12] since the connection terminal is for voltage input.
- Set the gain (C32 for analog input adjustment) at 200% in order to make the maximum value (5 V) of the external sensor's output correspond to 100%. Note that the input specification for terminal [12] is 0 to 10 V corresponding to 0 to 100%; thus, a gain factor of 200% ($= 10 \text{ V} \div 5 \text{ V} \times 100$) should be specified. Note also that any bias setting does not apply to feedback control.

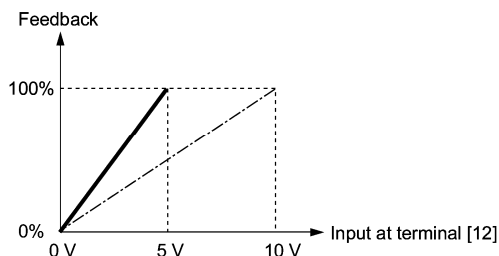

Application examples: Dancer control (for winders)

Example 1. When the output level of the external sensor is ± 7 VDC:

- Use terminal [12] since the voltage input is of bipolar.
- When the external sensor's output is of bipolar, the inverter controls the speed within the range of $\pm 100\%$. To convert the output ± 7 VDC to $\pm 100\%$, set the gain (C32 for analog input adjustment) at 143% as calculated below.

$$\frac{10 \text{ V}}{7 \text{ V}} \approx 143\%$$

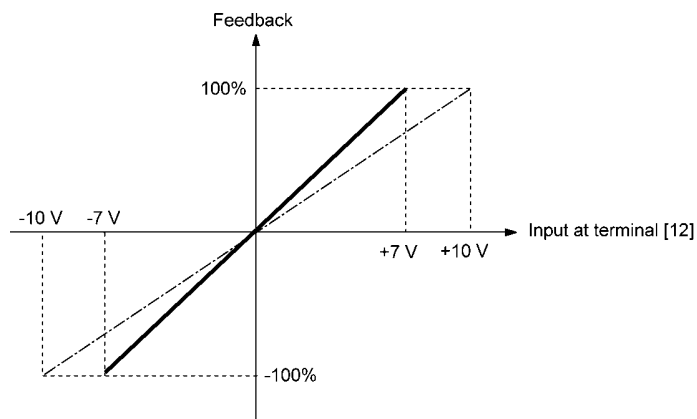

Example 2. When the output level of the external sensor is 0 to 10 VDC:

- Use terminal [12] since the connection terminal is for voltage input.
- When the external sensor's output is of unipolar, the inverter controls the speed within the range of 0 to 100%.

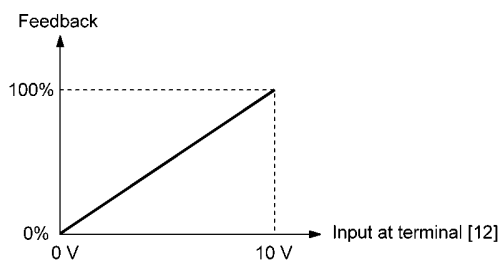

In this example, it is recommended that the dancer reference position be set around the +5 V (50%) point.

PID Display Coefficient and Monitoring

To monitor the PID command and its feedback value, set the display coefficient to convert the values into easy-to-understand mnemonic physical quantities, such as temperature.

 Refer to function codes E40 and E41 for details on display coefficients, and to E43 for details on monitoring.

J03 to J06 PID Control (P (Gain), I (Integral time), D (Differential time), Feedback filter)

- **P gain (J03)** Data setting range: 0.000 to 30.000 (times)

J03 specifies the gain for the PID processor.

P (Proportional) action

An operation in which the MV (manipulated value: output frequency) is proportional to the deviation is called P action, which outputs the MV in proportion to deviation. However, the MV alone cannot eliminate deviation.

Gain is data that determines the system response level against the deviation in P action. An increase in gain speeds up response, but an excessive gain may oscillate the inverter output. A decrease in gain delays response, but it stabilizes the inverter output.

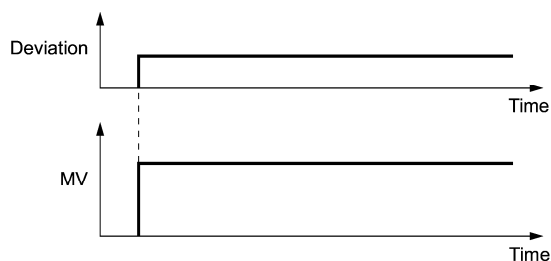

- **I integral time (J04)**

Data setting range: 0.0 to 3600.0 (s), 0.0 means that the integral component is ineffective.

J04 specifies the integral time for the PID processor.

I (Integral) action

An operation in which the change rate of the MV (manipulated value: output frequency) is proportional to the integral value of deviation is called I action, which outputs the MV that integrates the deviation. Therefore, I action is effective in bringing the feedback amount close to the commanded value. For the system whose deviation rapidly changes, however, this action cannot make it react quickly.

The effectiveness of I action is expressed by integral time as parameter, that is J04 data. The longer the integral time, the slower the response. The reaction to the external disturbance also becomes slow. The shorter the integral time, the faster the response. Setting too short integral time, however, makes the inverter output tend to oscillate against the external disturbance.

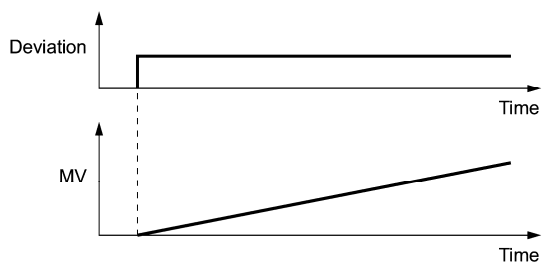

■ D differential time (J05)

Data setting range: 0.00 to 600.00 (s), 0.00 means that the differential component is ineffective.

J05 specifies the differential time for the PID processor.

D (Differential) action

An operation in which the MV (manipulated value: output frequency) is proportional to the differential value of the deviation is called D action, which outputs the MV that differentiates the deviation. D action makes the inverter quickly react to a rapid change of deviation.

The effectiveness of D action is expressed by differential time as parameter, that is J05 data. Setting a long differential time will quickly suppress oscillation caused by P action when a deviation occurs. Too long differential time makes the inverter output oscillation more. Setting short differential time will weaken the suppression effect when the deviation occurs.

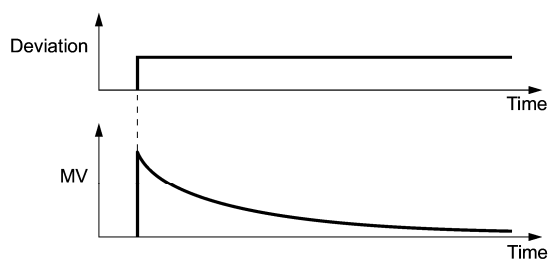

The combined uses of P, I, and D actions are described below.

(1) PI control

PI control, which is a combination of P and I actions, is generally used to minimize the remaining deviation caused by P action. PI control always acts to minimize the deviation even if a commanded value changes or external disturbance steadily occurs. However, the longer the integral time, the slower the system response to quick-changed control.

P action can be used alone for loads with very large part of integral components.

(2) PD control

In PD control, the moment that a deviation occurs, the control rapidly generates greater MV (manipulated value) than that generated by P action alone, to suppress the deviation increase. When the deviation becomes small, the behavior of P action becomes small.

A load including the integral component in the controlled system may oscillate due to the action of the integral component if P action alone is applied. In such a case, use PD control to reduce the oscillation caused by P action, for keeping the system stable. That is, PD control is applied to a system that does not contain any damping actions in its process.

(3) PID control

PID control is implemented by combining P action with the deviation suppression of I action and the oscillation suppression of D action. PID control features minimal control deviation, high precision and high stability.

In particular, PID control is effective to a system that has a long response time to the occurrence of deviation.

Follow the procedure below to set data to PID control function codes.

It is highly recommended that you adjust the PID control value while monitoring the system response waveform with an oscilloscope or equivalent. Repeat the following procedure to determine the optimal solution for each system.

- Increase the data of J03 (PID control P (Gain)) within the range where the feedback signal does not oscillate.
- Decrease the data of J04 (PID control I (Integral time)) within the range where the feedback signal does not oscillate.
- Increase the data of J05 (PID control D (Differential time)) within the range where the feedback signal does not oscillate.

Refining the system response waveforms is shown below.

1) Suppressing overshoot

Increase the data of J04 (Integral time) and decrease that of J05 (Differential time.)

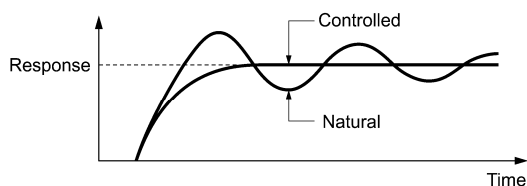

2) Quick stabilizing (moderate overshoot allowable)

Decrease the data of J03 (Gain) and increase that of J05 (Differential time).

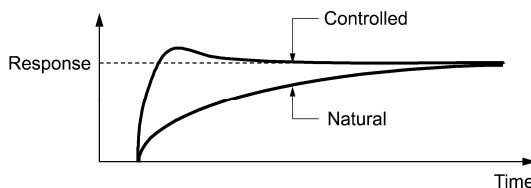

3) Suppressing oscillation whose period is longer than the integral time specified by J04

Increase the data of J04 (Integral time).

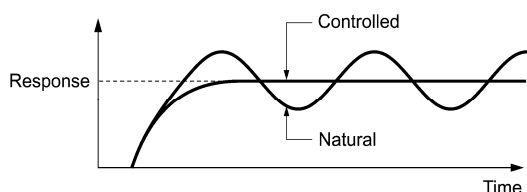

4) Suppressing oscillation whose period is approximately the same as the time specified by J05 (Differential time)

Decrease the data of J05 (Differential time).

Decrease the data of J03 (Gain), if the oscillation cannot be suppressed even though the differential time is set at 0 sec.

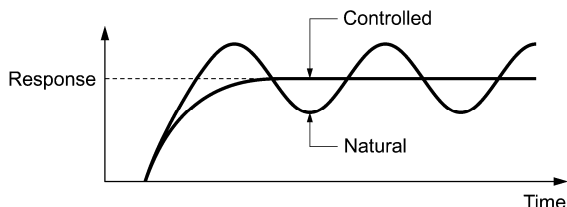

■ Feedback filter (J06) Data setting range: 0.0 to 900.0 (s)

J06 specifies the time constant of the filter for feedback signals under PID control. (This setting is used to stabilize the PID control loop. Setting too long a time constant makes the system response slow.)

Note To specify the filter for feedback signals finely under PID dancer control, apply filter time constants for analog input (C33, C38 and C43).

J08, J09 PID Control (Pressurization starting frequency, pressurizing time)

J15 (PID Control, Stop frequency for slow flowrate)
J16 (PID Control, Slow flowrate level stop latency)
J17 (PID Control, Starting frequency)

Slow flowrate stopping function (J15 to J17)

J15 to J17 configure the slow flowrate stopping function in pump control, a function that stops the inverter when the discharge pressure rises, causing the volume of water to decrease.

When the discharge pressure has increased, decreasing the reference frequency (output of the PID processor) below the stop frequency for slow flowrate level (J15) for the period of slow flowrate level stop latency (J16), the inverter decelerates to stop, while PID control itself continues to operate. When the discharge pressure decreases, increasing the reference frequency (output of the PID processor) above the starting frequency (J17), the inverter resumes operation.

- PID control (Stop frequency for slow flowrate) (J15) Data setting range: 0.0 (Disable), 1.0 to 500.0 (Hz)

J15 specifies the frequency which triggers slow flowrate stop of inverter.

- PID control (Slow flowrate level stop latency) (J16) Data setting range: 0 to 60 (s)

J16 specifies the period from when the PID output drops below the frequency specified by J15 until the inverter starts deceleration to stop.

- PID control (Starting frequency) (J17) Data setting range: 0.0 to 500.0 (Hz)

J17 specifies the starting frequency. Set J17 to a frequency higher than the stop frequency for slow flowrate (J15). If the specified starting frequency is lower than the stop frequency for slow flowrate, the latter stop frequency is ignored; the slow flowrate stopping function is triggered when the output of the PID processor drops below the specified starting frequency.

- Assignment of **PID-STP** ("Motor stopped due to slow flowrate under PID control") (E20 to E24 and E27, data = 44)

Assigning the digital output signal **PID-STP** to any of the programmable, output terminals with any of E20 through E24 and E27 (data = 44) enables the signal to output when the inverter stops due to the slow flowrate stopping function under PID control.

For the slow flowrate stopping function, see the chart below.

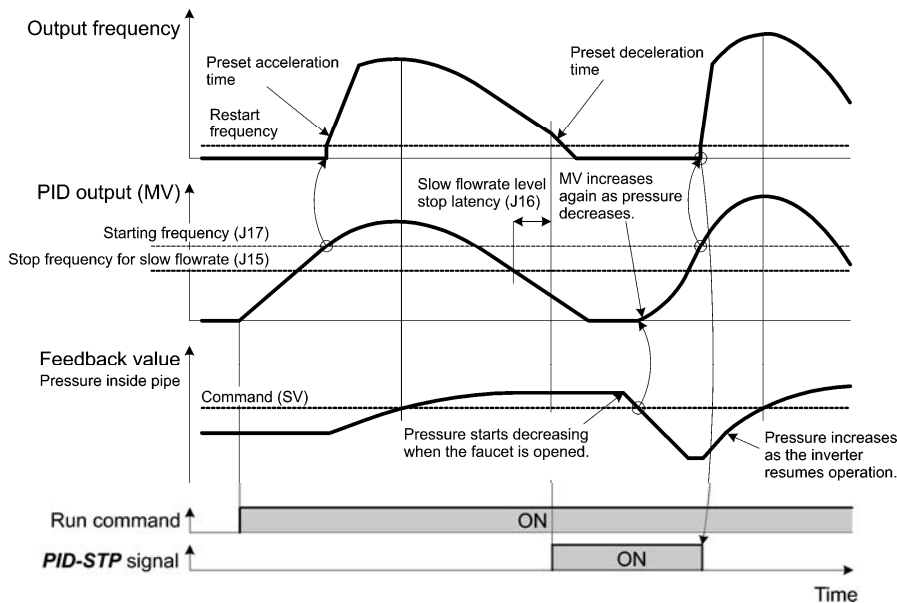

Pressurization before slow flowrate stopping (J08 and J09)

Specifying J08 (Pressurization starting frequency) and J09 (Pressurizing time) enables pressurization control when the frequency drops below the level specified by J15 (Stop frequency for slow flowrate) for the period specified by J16. During the pressurization, the PID control is in the hold state.

This function prolongs the stopping time of equipment with a bladder tank by pressurizing immediately before the frequency drops below the level at which the inverter stops the motor, thus enabling energy saving operation.

Because the pressurization starting frequency (J08) can be specified with a parameter, pressurization setting suitable for the equipment is possible.

For the pressurization control, see the chart below.

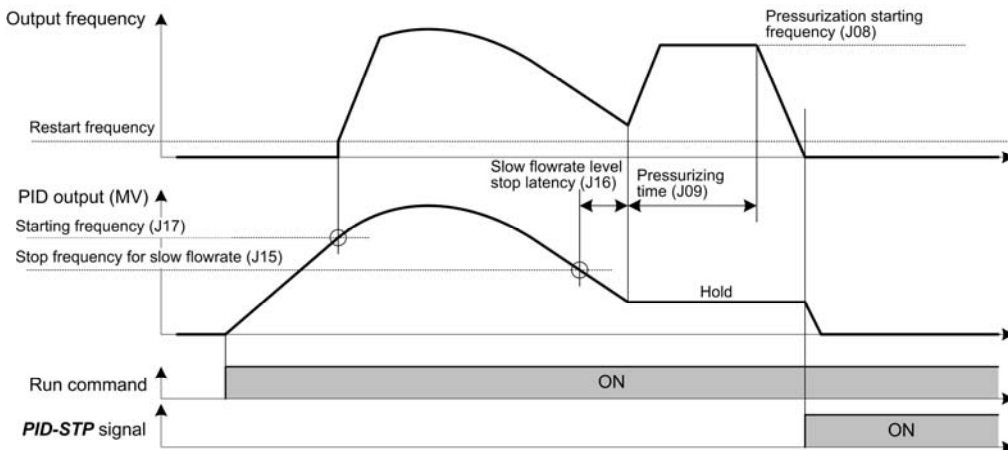

J10 PID Control (Anti reset windup)

J10 suppresses overshoot in control with the PID processor. As long as the deviation between the feedback and the PID command is beyond the preset range, the integrator holds its value and does not perform integration operation.

- Data setting range: 0 to 200 (%)

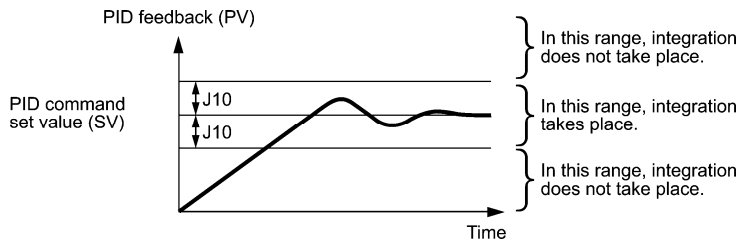

J11 to J13 PID Control (Select alarm output, Upper level alarm (AH) and Lower level alarm (AL))

The inverter can output two types of alarm signals (absolute-value and deviation alarms) associated with PID control if the digital output signal **PID-ALM** is assigned to any of the programmable, output terminals with any of E20 through E24 and E27 (data = 42).

J11 specifies the alarm output types. J12 and J13 specify the upper and lower limits for alarms, respectively.

■ Select alarm output (J11)

J11 specifies one of the following alarms available.

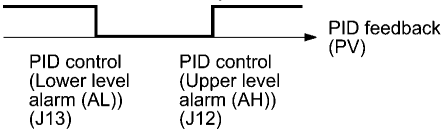
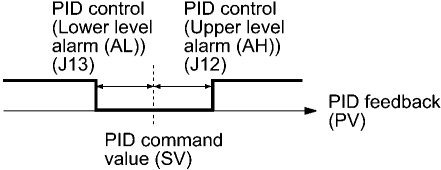
Data for J11	Alarm	Description
0	Absolute-value alarm	While $PV < AL$ or $AH < PV$, PID-ALM is ON. 
1	Absolute-value alarm (with Hold)	Same as above (with Hold)
2	Absolute-value alarm (with Latch)	Same as above (with Latch)
3	Absolute-value alarm (with Hold and Latch)	Same as above (with Hold and Latch)
4	Deviation alarm	While $PV < SV - AL$ or $SV + AH < PV$, PID-ALM is ON. 
5	Deviation alarm (with Hold)	Same as above (with Hold)
6	Deviation alarm (with Latch)	Same as above (with Latch)
7	Deviation alarm (with Hold and Latch)	Same as above (with Hold and Latch)

SV: PID process command PV: PID feedback amount

Hold: During the power-on sequence, the alarm output is kept OFF (disabled) even when the monitored quantity is within the alarm range. Once it goes out of the alarm range, and comes into the alarm range again, the alarm is enabled.

Latch: Once the monitored quantity comes into the alarm range and the alarm is turned ON, the alarm will remain ON even if it goes out of the alarm range. To release the latch, perform a reset by using the  key or turning the terminal command **RST** ON. Resetting can be done by the same way as resetting an alarm.

■ Upper level alarm (AH) (J12)

J12 specifies the upper limit of the alarm (AH) in percentage (%) of the feedback amount.

■ Lower level alarm (AL) (J13)

J13 specifies the lower limit of the alarm (AL) in percentage (%) of the feedback amount.

 **Note** The value displayed (%) is the ratio of the upper/lower limit to the full scale (10 V or 20 mA) of the feedback amount (in the case of a gain of 100%).

Upper level alarm (AH) and lower level alarm (AL) also apply to the following alarms.

Alarm	Description	How to handle the alarm:	
		Select alarm output (J11)	Parameter setting
Upper limit (absolute)	ON when AH < PV	Absolute-value alarm	J13 (AL) = 0
Lower limit (absolute)	ON when PV < AL		J12 (AH) = 100%
Upper limit (deviation)	ON when SV + AH < PV	Deviation alarm	J13 (AL) = 100%
Lower limit (deviation)	ON when PV < SV - AL		J12 (AH) = 100%
Upper/lower limit (deviation)	ON when SV - PV > AL		J13 (AL) = J12 (AH)
Upper/lower range limit (deviation)	ON when SV - AL < PV < SV + AL	Deviation alarm	A negative logic signal should be assigned to PID-ALM .
Upper/lower range limit (absolute)	ON when AL < PV < AH	Absolute-value alarm	
Upper/lower range limit (deviation)	ON when SV - AL < PV < SV + AH	Deviation alarm	

J15 to J17 PID Control (Stop frequency for slow flowrate, Slow flowrate level stop latency and Starting frequency) (Refer to J08.)

J18, J19 PID Control (Upper limit of PID process output, Lower limit of PID process output)

The upper and lower limiters can be specified to the PID output, exclusively used for PID control. The settings are ignored when PID cancel is enabled and the inverter is operated at the reference frequency previously specified. (E01 to E07, data = 20)

■ PID Control (Upper limit of PID process output) (J18)

J18 specifies the upper limit of the PID processor output limiter in %. If you specify "999," the setting of the frequency limiter (High) (F15) will serve as the upper limit.

■ PID Control (Lower limit of PID process output) (J19)

J19 specifies the lower limit of the PID processor output limiter in %. If you specify "999," the setting of the frequency limiter (Low) (F16) will serve as the lower limit.

J21 Dew Condensation Prevention (Duty)

When the inverter is stopped, dew condensation on the motor can be prevented, by feeding DC power to the motor at regular intervals to keep the temperature of the motor above a certain level.

■ Enabling Dew Condensation Prevention

To utilize this feature, you need to assign the terminal command **DWP** ("Protect motor from dew condensation") to one of the general-purpose digital input terminals. (E01 to E07, data = 39)

■ Dew Condensation Prevention (Duty) (J21)

The magnitude of the DC power applied to the motor is the same as the setting of F21 (DC braking 1, Braking level) and its duration of each interval is the same as the setting of F22 (DC braking 1, Braking time). Interval T is determined so that the ratio of the duration of the DC power to T is the value (Duty) set for J21.

$$\text{Duty for condensation prevention (J21)} = \frac{F22}{T} \times 100 (\%)$$

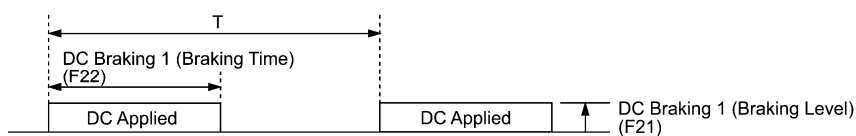

Condensation Prevention Cycle

J22 Commercial Power Switching Sequence (Refer to E01 through E07.)

J56 PID Control (Speed command filter)

J57 PID Control (Dancer reference position) (Refer to J02.)

J57 specifies the dancer reference position in the range of -100% to +100% for dancer control.
 If J02 = 0 (keypad), this function code is enabled as the dancer reference position.
 It is also possible to modify the PID command with the ⤴ / ⤵ keys. If it is modified, the new command value is saved as J57 data.

J58 PID Control (Detection width of dancer position deviation)
J59 to J61 PID Control (P (Gain) 2, I (Integral time) 2 and D (Differential time) 2)

The moment the feedback value of dancer roll position comes into the range of "the dancer reference position ± detection width of dancer position deviation (J58)," the inverter switches PID constants from the combination of J03, J04 and J05 to that of J59, J60 and J61, respectively in its PID processor. Giving a boost to the system response by raising the P gain may improve the system performance in the dancer roll positioning accuracy.

- **Detection width of dancer position deviation (J58)**
 J58 specifies the bandwidth in the range of 1 to 100%. Specifying "0" does not switch PID constants.
 - **P (Gain) 2 (J59)** Data setting range: 0.000 to 30.000 (times)
 - **I (Integral time) 2 (J60)** Data setting range: 0.0 to 3600.0 (s)
 - **D (Differential time) 2 (J61)** Data setting range: 0.00 to 600.00 (s)
- Descriptions for J59, J60, and J61 are the same as those of PID control P (Gain) (J03), I (Integral time) (J04), and D (Differential time) (J05), respectively.

J62 PID Control (PID control block selection)

J62 allows you to select either adding or subtracting the PID dancer processor output to or from the primary speed command. Also, it allows you to select either controlling the PID dancer processor output by the ratio (%) against the primary speed command or compensating the primary speed command by the absolute value (Hz).

Data for J62			Control function	
Decimal	Bit 1	Bit 0	Control value type	Operation for the primary speed command
0	0	0	Ratio (%)	Addition
1	0	1	Ratio (%)	Subtraction
2	1	0	Absolute value (Hz)	Addition
3	1	1	Absolute value (Hz)	Subtraction

J68 to J70	Brake Signal (Brake-OFF current, Brake-OFF frequency/speed and Brake-OFF timer)
J71, J72	Brake Signal (Brake-ON frequency/speed and Brake-ON timer)
J95, J96	Brake Signal (Brake-OFF torque and Speed condition selection)

These function codes are for the brake releasing/turning-on signals of vertical carrier machines.

It is possible to set the conditions of the brake releasing/turning-on signals (current, frequency or torque) so that a hoisted load does not fall down at the start or stop of the operation, or so that the load applied to the brake is reduced.

■ Brake signal -- **BRKS** (E20 to E24 and E27, data = 57)

This signal outputs a brake control command that releases or activates the brake.

Releasing the Brake

When any of the inverter output current, output frequency, or torque command value exceeds the specified level of the brake signal (J68/J69/J95) for the period specified by J70 (Brake signal (Brake-OFF timer)), the inverter judges that required motor torque is generated and turns the signal **BRKS** ON for releasing the brake.

This prevents a hoisted load from falling down due to an insufficient torque when the brake is released.

Function code	Name	Data setting range	Remarks
J68	Brake-OFF current	0% to 300%: Set it putting the inverter rated current at 100%.	See Note below.
J69	Brake-OFF frequency/speed	0.0 to 25.0 Hz	Available only under V/f control.
J70	Brake-OFF timer	0.0 to 5.0 s	
J95	Brake-OFF torque	0% to 300%	Available only under vector control.
J96	Speed condition selection (Braking conditions)	Response for brake-OFF current (Bit 2) 0: Slow response (default) 1: Quick response	Specifies the response type for brake-OFF current detection. Selecting slow response inserts a detection filter into the current detection circuit so that the brake-OFF timing will be slightly behind the rising edge of the actual current. If the delay is not negligible with adjustments, select quick response.

 **Note** The inverter rated current differs depending upon the drive mode selected (LD, MD or HD).

Turning the Brake ON

When the run command is OFF and the output frequency drops below the level specified by J71 (Brake signal (Brake-ON frequency/speed)) and stays below the level for the period specified by J72 (Brake signal (Brake-ON timer)), the inverter judges that the motor rotation is below a certain level and turns the signal **BRKS** OFF for activating the brake.

Under vector control, when the reference speed or the detected one drops below the level of the brake-ON frequency (specified by bit 3 of J96) and stays below the level for the period specified by J72 (Brake signal (Brake-ON timer)), the inverter judges that the motor rotation is below a certain level and turns the signal **BRKS** OFF for activating the brake.

This operation reduces the load applied to the brake, extending lifetime of the brake.

Function code	Name	Data setting range	Remarks
J71	Brake-ON frequency/speed	0.0 to 25.0 Hz	
J72	Brake-ON timer	0.0 to 5.0 s	
J96	Speed condition selection (Braking conditions) Available when using vector control with/without speed sensor.	Criteria of speed condition for brake-ON (Bit 0) 0: Detected speed 1: Reference speed	Specifies the criteria of speed to be used for brake-ON condition. When "Vector control without speed sensor" is selected, specify "Reference speed" (Bit 0 = 1).
		Criteria of frequency for brake-ON (Bit 3) 0: Stop frequency (F25) 1: Brake-ON frequency (J71)	Specifies the criteria of frequency to be used for brake-ON timing. If "Detected speed" and "Stop frequency" are selected (Bit 0 = 0 and Bit 3 = 0) to determine brake-ON timing, the brake may be applied after running at the stop frequency (F25) due to a speed error. If it is required that brake is applied during running at the stop frequency, select "Brake-ON frequency" (Bit 3 = 1) as criteria of frequency. When jogging or inching the motor for vertical conveyance, use J71 as brake-ON frequency.
		Turn-on condition of brake signal (Bit 4) 0: Independent of a run command ON/OFF 1: Only when a run command is OFF	Specifies whether to turn on a brake signal independent of a run command ON/OFF or only when a run command is OFF. When normal and reverse operations are switched, brake-ON conditions may be met in the vicinity of zero speed. For such a case, select "Only when a run command is OFF" (Bit 4 = 1).

- Note**
- The brake signal control is only applicable to the 1st motor. If the motor switching function selects any of the 2nd to 4th motors, the brake signal remains ON.
 - If the inverter is shut down due to an occurrence of alarm state or by the terminal command **BX** ("Coast to a stop"), the brake signal is immediately turned ON.
 - Bit 1 of J96 is reserved (fixed at "0").

Operation time chart under V/f control

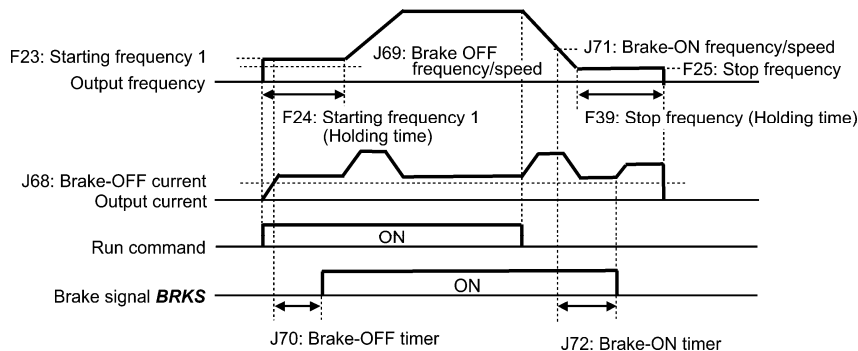

Operation time chart under vector control without speed sensor

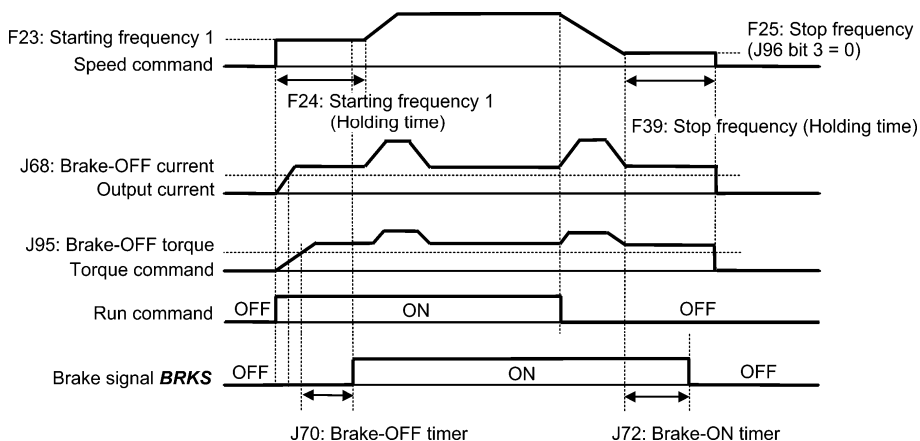

Operation time chart under vector control with speed sensor

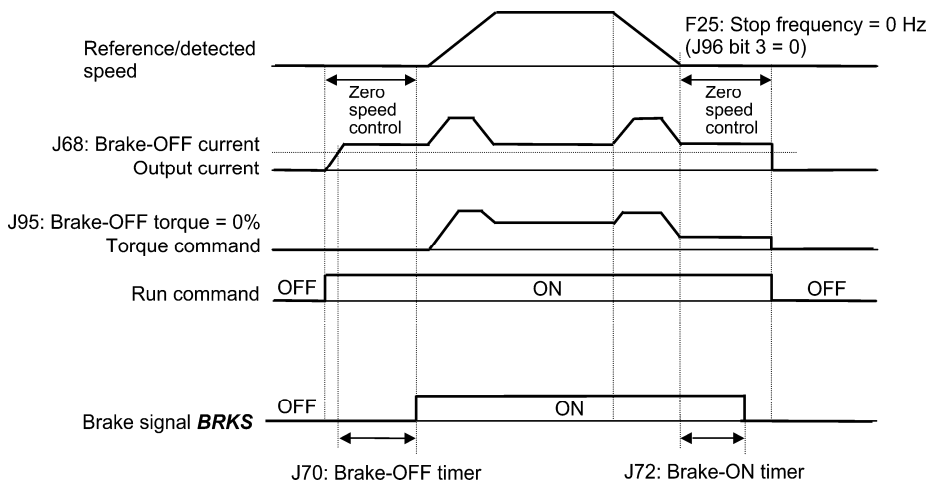

- Note**
- If the zero speed control is enabled under vector control, set J95 (Brake-OFF torque) at 0%.
 - After releasing the brake (**BRKS ON**), operating for a while, and then activating the brake (**BRKS OFF**) to stop the motor, if you want to release the brake (**BRKS ON**), turn the inverter's run command OFF and then ON.

J97 to J99 Servo-lock (Gain, Completion timer, Completion range)

Servo-lock

This function servo-locks the inverter to hold the motor within the positioning completion range specified by J99 for the period specified by J98 even if an external force applies to the load.

Note When the inverter is servo-locked, it keeps the output frequency low; therefore, use the inverter under the following specified thermal restriction: Output current within the range of 150% of the rated current for 3 seconds and 80% for continuous operation. (Note that under the restriction, the inverter automatically limits the carrier frequency under 5 kHz.)

Servo-lock starting conditions

Servo-lock control starts when the following conditions are met:	
	F38 = 0 (Use detected speed as a decision criteria)
1	Run command OFF, or Reference frequency < Stop frequency (F25)
2	LOCK ("Servo-lock command") ON (Assignment of LOCK (Function code data = 47))
3	The detected speed is less than stop frequency (F25).

Operation examples

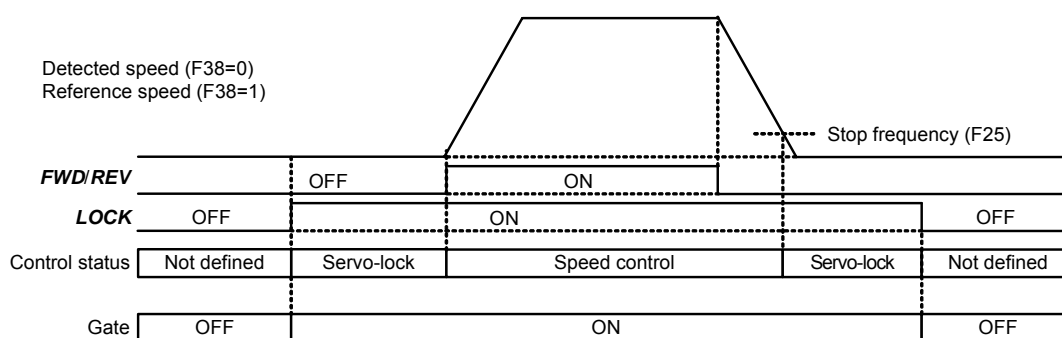

Typical Control Sequence of Servo-lock

⚠ WARNING

When the servo-lock command is ON, the inverter keeps on outputting voltage on output terminals [U], [V] and [W] even if a run command is OFF and the motor seems to stop.

An electric shock may occur.

Specifying servo-lock control

- Positioning completion signal -- **PSET** (Function code data = 82), Servo-lock (Completion timer) (J98), and Servo-lock (Completion range) (J99)

This output signal comes ON when the inverter has been servo-locked so that the motor is held within the positioning completion range specified by J99 for the period specified by J98.

- Servo-lock (Gain) (J97)

J97 specifies the gain of the servo-lock positioning device to adjust the stop behavior and shaft holding torque.

J97	Small ↔ Large
Stop behavior	Response slow, but smooth ↔ Response quick, but hunting large
Shaft holding torque	Small ↔ Large

Monitor for servo-lock control

Monitor item	LCD monitor	Function code	Remarks
Current position	Menu #3 "3: OPR MNTR," Page 8, "P4"	Current position pulse Upper digit: Z90 Lower digit: Z91	Only when the positioning device is in operation (positioning control is active), the LED monitor displays these data. When it is not in operation, the monitor is zero-cleared.
Positioning error	Menu #3 "3: OPR MNTR," Page 8, "dP4"	Positioning error pulse Upper digit: Z94 Lower digit: Z95	

The values on the LED monitor appear based on PG pulses 4-multiplied. Under servo-lock, no current positioning pulses or positioning error pulses are displayed on the LED monitor.

Notes for using servo-lock

- (1) Positioning control error $\overline{E}r\text{-}O$
 If a positioning error exceeds the value equivalent to four rotations of the motor shaft when the inverter is servo-locked, the inverter issues a positioning control error signal $\overline{E}r\text{-}O$.
- (2) Stop frequency (F25) under servo-lock
 Since servo-lock starts when the output frequency is below the stop frequency (F25), it is necessary to specify such F25 data that does not trigger $\overline{E}r\text{-}O$ (that is, specify the value equivalent to less than 4 rotations of the motor shaft).
 Stop frequency (F25) < (4 × Gain (J97) × Maximum frequency)
 (Example) When Gain (J97) = 0.01 and Maximum frequency (F03) = 60 Hz, specify F25 data < 2.4 Hz.
- (3) Enabling the servo-lock control disables the following:
 - Operation controlled with a stop frequency
 - Rotation direction limitation

5.2.8 d codes (Application Functions 2)

d01 to d04 Speed Control 1 (Speed command filter, Speed detection filter, P (Gain) and I (Integral time)) d06 Speed Control 1 (Output filter)

These function codes control the speed control sequence for normal operations. For application of each function code, refer to the figure below and the subsequent descriptions.

Block diagram of the speed control sequence

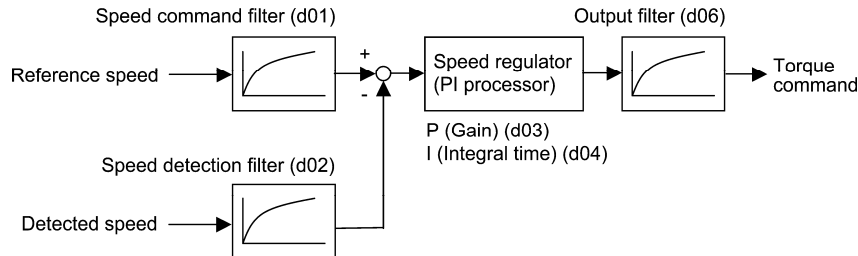

- **Speed command filter (d01)** Data setting range: 0.000 to 5.000 (s)

d01 specifies a time constant determining the first order delay of the speed command filter.

Modify this data when an excessive overshoot occurs against the change of the reference speed.

Increasing the filter time constant stabilizes the reference speed and reduces overshoot against the change of the reference speed, but it slows the response speed of the inverter.

- **Speed detection filter (d02)** Data setting range: 0.000 to 0.100 (s)

d02 specifies a time constant determining the first order delay of the speed detection filter.

Modify this data when the control target (machinery) is oscillatory due to deflection of a drive belt or other causes so that ripples (oscillatory components) are superimposed on the detected speed, causing hunting (undesirable oscillation of the system) and blocking the PI processor gain from increasing (resulting in a slow response speed of the inverter). In addition, if the lower encoder (PG) resolution makes the system oscillatory, try to modify this data.

Increasing the time constant stabilizes the detected speed and raises the PI processor gain even with ripples superimposed on the detected speed. However, the speed detection itself delays, resulting in a slower speed response, larger overshoot, or hunting.

- **P gain (d03)** Data setting range: 0.1 to 200.0 (times)
■ **I integral time (d04)** Data setting range: 0.001 to 9.999 (s)

d03 and d04 specify the gain and integral time of the speed regulator (PI processor), respectively.

P gain

Definition of "P gain = 1.0" is that the torque command is 100% (100% torque output of each inverter capacity) when the speed deviation (reference speed – detected speed) is 100% (equivalent to the maximum speed).

Determine the P gain according to moment of inertia of machinery loaded to the motor output shaft. Larger moment of inertia needs larger P gain to keep the flat response in whole operations.

Specifying a larger P gain improves the quickness of control response, but may cause a motor speed overshooting or hunting (undesirable oscillation of the system). Moreover, mechanical resonance or vibration sound on the machine or motor could occur due to excessively amplified noises. If it happens, decreasing P gain will reduce the amplitude of the resonance/vibration. A too small P gain results in a slow inverter response and a speed fluctuation in low frequency, which may prolong the time required for stabilizing the motor speed.

Integral time

Specifying a shorter integral time shortens the time needed to compensate the speed deviation, resulting in quick response in speed. Specify a short integral time if quick arrival to the target speed is necessary and a slight overshooting in the control is allowed; specify a long time if any overshooting is not allowed and taking longer time is allowed.

If a mechanical resonance occurs and the motor or gears sound abnormally, setting a longer integral time can transfer the resonance point to the low frequency zone and suppress the resonance in the high frequency zone.

- **Output Filter (d06)** Data setting range: 0.000 to 0.100 (s)

d06 specifies the time constant for the first order delay of the speed controller output filter.

Use d06 when even adjusting the P gain or integral time cannot suppress mechanical resonance such as hunting or vibration. Generally, setting a larger value to the time constant of the output filter decreases the amplitude of resonance; however, a too large time constant may make the system unstable.

d07	Speed Control 1 (Notch filter resonance frequency)	
d08	Speed Control 1 (Notch filter attenuation level)	
		A49, b49, r49 (Speed control 2 to 4, Notch filter resonance frequency) A50, b50, r50 (Speed control 2 to 4, Notch filter attenuation level)

These function codes specify speed control using notch filters. The notch filters make it possible to decrease the speed loop gain only in the vicinity of the predetermined resonance points, suppressing the mechanical resonance.

The notch filters are available only under "vector control with speed sensor."

Setting the speed loop gain at a high level in order to obtain quicker speed response may cause mechanical resonance. If it happens, decreasing the speed loop gain is required to slow the speed response as a whole. In such a case, using the notch filters makes it possible to decrease the speed loop gain only in the vicinity of the predetermined resonance points and set the speed loop gain at a high level in other resonance points, enabling a quicker speed response as a whole.

The following four types of notch filters can be specified.

	Function code	Name	Data setting range	Unit	Default setting
Notch filter 1	d07	Speed control 1 (Notch filter resonance frequency)	1 to 200	Hz	200
	d08	Speed control 1 (Notch filter attenuation level)	0 to 20	dB	0 (Disable)
Notch filter 2	A49	Speed control 2 (Notch filter resonance frequency)	1 to 200	Hz	200
	A50	Speed control 2 (Notch filter attenuation level)	0 to 20	dB	0 (Disable)
Notch filter 3	b49	Speed control 3 (Notch filter resonance frequency)	1 to 200	Hz	200
	b50	Speed control 3 (Notch filter attenuation level)	0 to 20	dB	0 (Disable)
Notch filter 4	r49	Speed control 4 (Notch filter resonance frequency)	1 to 200	Hz	200
	r50	Speed control 4 (Notch filter attenuation level)	0 to 20	dB	0 (Disable)

Setting the notch filter attenuation level to "0" (dB) disables the corresponding notch filter.

It is possible to apply all of the four notch filters to the 1st motor or apply each notch filter to each of the 1st to 4th motors.

Requisite for use of notch filters	Notch filter 1	Notch filter 2	Notch filter 3	Notch filter 4
		d07 and d08	A49 and A50	b49 and b50
M2 , M3 , and M4 ("Select motor 2, 3, and 4") are not in use. (E01 to E07, E98, E99 ≠ 12, 36, 37)	All of the four notch filters apply to the 1st motor.			
All of the three "Motor/Parameter Switching" items are set to "Parameter." (A42, b42, r42 = 1)				
Other than the above	To the 1st motor	To the 2nd motor	To the 3rd motor	To the 4th motor

d09, d10	Speed Control (Jogging) (Speed command filter and Speed detection filter)	
d11 to d13	(P (Gain), I (Integral time) and Output filter)	(Refer to d01.)

These function codes control the speed control sequence for jogging operations.

The block diagrams and function codes related to jogging operations are the same as for normal operations.

Since this speed control sequence is exclusive to jogging operations, specify these function codes to obtain higher speed response than that of normal operations for smooth jogging operations.

For details, refer to the corresponding descriptions (d01 to d04 and d06) about the speed control sequence for normal operations.

d14 to d17 Feedback Input (Pulse input format, Encoder pulse resolution, Pulse count factor 1 and Pulse count factor 2)

These function codes specify the speed feedback input under vector control with speed sensor.

■ Feedback Input, Pulse input format (d14)

d14 specifies the speed feedback input format.

Data for d14	Pulse input mode	Remarks
0	Pulse train sign/Pulse train input	
1	Forward rotation pulse/Reverse rotation pulse	
2	A and B phases with 90 degree phase difference	

■ Feedback Input, Encoder pulse resolution (d15) Data setting range: 20 to 60000 (P/R)

d15 specifies the pulse resolution (P/R) of the speed feedback encoder.

■ Feedback Input, Pulse count factor 1 (d16) and Pulse count factor 2 (d17) Data setting range: 1 to 9999

d16 and d17 specify the factors to convert the speed feedback input pulse rate into the motor shaft speed (r/min).

Specify the data according to the transmission ratios of the pulley and gear train as shown below.

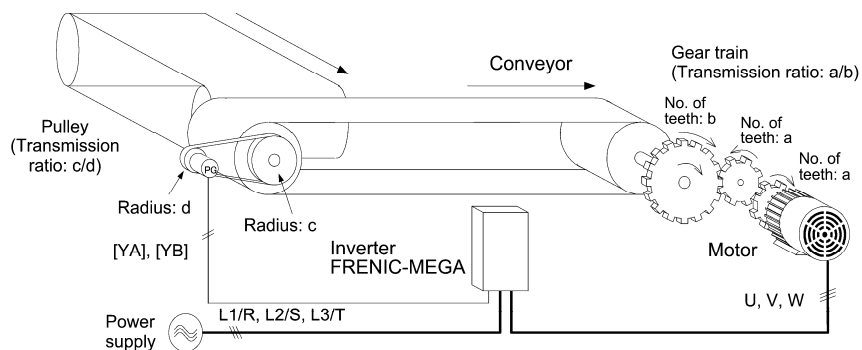

An Example of a Closed Loop Speed Control System (Conveyor)

Listed below are expressions for conversion between a speed feedback input pulse rate and motor shaft speed.

$$\text{Motor shaft speed} = \frac{\text{Pulse count factor 2 (d17)}}{\text{Pulse count factor 1 (d16)}} \times \text{Encoder shaft speed}$$

$$\frac{\text{Pulse count factor 2 (d17)}}{\text{Pulse count factor 1 (d16)}} = \frac{b}{a} \times \frac{d}{c}$$

$$\text{Pulse count factor 1 (d16)} = a \times c$$

$$\text{Pulse count factor 2 (d17)} = b \times d$$



When enabling the vector control with speed sensor, mount the sensor encoder on the motor output shaft directly, or on a shaft with the rigidity equivalent to the motor output shaft. A backlash or deflection being on the mounting shaft could interfere with normal control.

d21, d22 Speed Agreement/PG Error (Hysteresis width and Detection timer)
d23 PG Error Processing

These function codes specify the detection levels of the speed agreement signal **DSAG** and PG error detected signal **PG-ERR**.

Speed agreement signal **DSAG** (E20 to E24 and E27, data = 71)

■ Speed Agreement/PG Error (Hysteresis width (d21) and Detection timer (d22))

- Data setting range: (d21) 0.0 to 50.0 (%), 100 (%) at the maximum speed
(d22) 0.00 to 10.00 (s)

If the speed regulator's deviation (between the reference speed and detected one) is within the specified range (d21), the signal **DSAG** turns ON. If the deviation is out of the specified range (d21) for the specified period (d22), the signal turns OFF. This signal allows the user to check whether the speed regulator works properly or not.

PG error detected signal **PG-ERR** (E20 to E24 and E27, data = 76)

■ Speed Agreement/PG Error (Hysteresis width (d21), Detection timer (d22), and PG Error Processing (d23))

- Data setting range: (d21) 0.0 to 50.0 (%), 100 (%) at the maximum speed
(d22) 0.00 to 10.00 (s)
(d23) 0 to 5

If the speed regulator's deviation (between the reference speed and detected one) is out of the specified range (d21) for the specified period (d22), the inverter judges it as a PG error.

d23 defines the detection condition (and exception), processing after error detection, and hysteresis width as listed below.

Data for d23	Function	Detection condition (and exception)	Processing after error detection	Hysteresis width for error detection
0	Continue to run 1	When the inverter cannot follow the reference speed (even after soft-starting) due to a heavy overload or similar, so that the detected speed is less than the reference speed, the inverter does not interpret this situation as a PG error.	The inverter outputs the PG error detected signal PG-ERR and continues to run.	Detection width = d21, which is constant, even if the speed command is above the base frequency (F04).
1	Stop running with alarm 1		The inverter initiates a motor coast to stop, with the $\bar{E}_r\text{-}\bar{E}$ alarm.	
2	Stop running with alarm 2		No exception. It also outputs the PG error detected signal PG-ERR .	
3	Continue to run 2	When the inverter cannot follow the reference speed (even after soft-starting) due to a heavy overload or similar, so that the detected speed is less than the reference speed, the inverter does not interpret this situation as a PG error.	The inverter outputs the PG error detected signal PG-ERR and continues to run.	If the speed command is below the base frequency (F04), detection width = d21, which is constant. If it is above the base frequency, detection width = d21*Speed command*Maximum frequency/Base frequency (F04).
4	Stop running with alarm 3		The inverter initiates a motor coast to stop, with the $\bar{E}_r\text{-}\bar{E}$ alarm.	
5	Stop running with alarm 4		No exception. It also outputs the PG error detected signal PG-ERR .	



Enabling an operation limiting function such as the torque limit and droop control will increase the deviation caused by a huge gap between the reference speed and detected one. In this case, the inverter may trip interpreting this situation as a PG error, depending on the running state. To avoid this incident, set the d23 data to "0" (Continue to run) to prevent the inverter from tripping even if any of those limiting functions is activated.

d24	Zero Speed Control	(Refer to F23.)
d25	ASR Switching Time	(Refer to A42.)
d32, d33	Torque Control (Speed limit 1 and Speed limit 2)	(Refer to H18.)

d41 Application-Defined Control

d41 selects/deselects constant peripheral speed control or synchronous control (simultaneous or standby synchronization). Constant peripheral speed control suppresses an increase in peripheral speed (line speed) resulting from the increasing radius of the take-up roll in a winder system. Synchronous control drives two or more shafts of a conveyer while keeping their positions in synchronization. For details about synchronous control, refer to the PG Interface Card instruction manual.

■ Application-Defined Control (d41)

Data for d41	Function
0	Disable (Ordinary control)
1	Enable (Constant peripheral speed control) Note: This control is valid only when "V/f control with speed sensor" or "Dynamic torque vector control with speed sensor" is selected with F42, A14, b14, or r14 (data = 3 or 4).
2	Enable (Simultaneous synchronization, without Z phase)
3	Enable (Standby synchronization)
4	Enable (Simultaneous synchronization, with Z phase)

[1] Constant Peripheral Speed Control

In a winder system (e.g., roving frames, wiredrawing machines), if the inverter continues to run the motor at a constant speed, the take-up roll gets bigger with materials (roving, wire, etc.) and its radius increases so that the winding speed of the take-up roll increases.

To keep the peripheral speed (winding speed) constant, the inverter detects the winding speed using an encoder and controls the motor rotation according to the encoder feedback.

Machinery configuration of a winder system and function code settings

Shown below is a typical machinery configuration of a winder system for which it is necessary to configure the function codes as listed below.

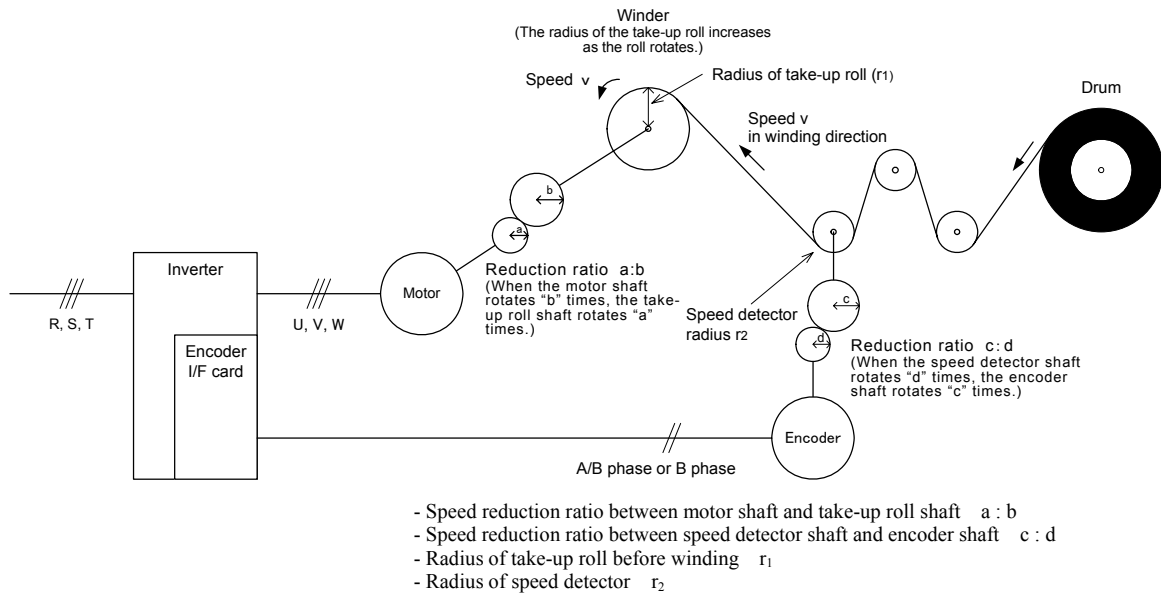

Setting the Reduction Ratio

Function code	Name	Settings
d15	Encoder pulse resolution	Encoder pulse resolution (P/R)
d16	Pulse count factor 1	Speed reduction ratio of the whole machinery (load)
d17	Pulse count factor 2	$\frac{K_2}{K_1} = \frac{r_2}{r_1} \times \frac{b}{a} \times \frac{d}{c} = d17/d16$ <p>d16: Denominator factor for the speed reduction ratio (K1 = r₁ × a × c) d17: Numerator factor for the speed reduction ratio (K2 = r₂ × b × d)</p>

■ Peripheral speed (line speed) command

Under constant peripheral speed control, speed commands should be given as peripheral speed (line speed) commands.

Setting with digital inputs

To digitally specify a peripheral speed (line speed) in m/min, make the following settings.

Function code	Name	Settings
E48	LED monitor	5: Line speed
E50	Coefficient for speed indication	$K_s = \frac{240\pi \times a \times r_1}{p \times b}$ <p>Ks: Coefficient for speed indication (E50) p: Number of motor poles a, b: Components of speed reduction ratio between motor shaft and take-up roll shaft (When the motor shaft rotates "b" times, the take-up roll shaft rotates "a" times.) r₁: Radius of take-up roll before winding (initial value) in m</p>

Setting with analog inputs

To specify a peripheral speed (line speed) using analog inputs, set an analog input (0 to 100%) based on the following equation.

$$\text{Analog input (\%)} = \frac{p \times b \times 100}{240\pi \times r_1 \times a \times f_{\max}} \times V$$

Where

V: Peripheral speed (Line speed) in m/min

f_{max}: Maximum frequency 1 (F03)

■ Adjustment

Like usual speed controls, it is necessary to adjust the speed command filter, speed detection filter, P gain, and integral time in the speed control sequence that controls the peripheral speed at a constant level.

Function code	Name	Key points
d01	Speed control (Speed command filter)	If an excessive overshoot occurs for a speed command change, increase the filter constant.
d02	Speed control (Speed detection filter)	If ripples are superimposed on the speed detection signal so that the speed control gain cannot be increased, increase the filter constant to obtain a larger gain.
d03	Speed control P (Gain)	If hunting is caused in the motor speed control, decrease the gain. If the motor response is slow, increase the gain.
d04	Speed control I (Integral time)	If the motor response is slow, decrease the integral time.

■ Cancel constant peripheral speed control -- **Hz/LSC** (Function code E01 to E07, data = 70)

Turning ON **Hz/LSC** cancels constant peripheral speed control. This disables the frequency compensation of PI operation, resulting in no compensation for a take-up roll getting bigger and an increase in the winding speed.

Use this signal to temporarily interrupt the control for repairing a thread break, for example.

Hz/LSC	Function
OFF	Enable constant peripheral speed control (depending on d41 setting)
ON	Cancel constant peripheral speed control (V/f control, without compensation for a take-up roll getting bigger)

■ Hold the constant peripheral speed control frequency in the memory -- **LSC-HLD**
(Function code E01 to E07, data = 71)

If **LSC-HLD** is ON under constant peripheral speed control, stopping the inverter (including an occurrence of an alarm and a coast-to-stop command) or turning OFF **Hz/LSC** saves the current frequency command compensating for a take-up roll getting bigger, in the memory. At the time of restart, the saved frequency command applies and the inverter keeps the peripheral speed constant.

LSC-HLD	Function
OFF	Disable (No saving operation)
ON	Enable (Saving the frequency command compensating for a take-up roll getting bigger)

 **Note** Shutting down the inverter power during an operation stop loses the frequency compensation data saved in the memory. At the time of restart, therefore, the inverter runs at the frequency without compensation so that a large overshoot may occur.

d51 to d55 Reserved for particular manufacturers
d68, d69,
d99

Function codes d51 to d55, d68, d69 and d99 appear on the LED monitor, but they are reserved for particular manufacturers. Unless otherwise specified, do not access these function codes.

d59, d61 Command (Pulse Rate Input)
d62, d63 (Pulse input format, Filter time constant, Pulse count factor 1 and Pulse count factor 2)
(Refer to F01.)

d60 **Command (Pulse Rate Input) (Encoder pulse resolution)**
d71 to d78 **Synchronous Operation**

These function codes specify various parameters required for synchronous operation. For details, refer to the PG Interface Card instruction manual.

d70 **Speed Control Limiter**

d70 specifies a limiter for the PI value output calculated in speed control sequence under V/f control with speed sensor or dynamic torque vector control with speed sensor.

A PI value output is within the "slip frequency × maximum torque (%)" in a normally controlled state.

If an abnormal state such as a temporary overload arises, the PI value output greatly fluctuates and it may take a long time for the PI value output to return to the normal level. Limiting the PI value output with d70 suppresses such abnormal operation.

Data setting range: 0 to 100 (%) (assuming the maximum frequency as 100%)

5.2.9 U codes (Application functions 3)

U00	Customizable Logic (Mode selection)
U01 to U50	Customizable Logic: Step 1 to 10 (Setting)
U71 to U75	Customizable Logic Output Signal 1 to 5 (Output selection)
U81 to U85	Customizable Logic Output Signal 1 to 5 (Function selection)
U91	Customizable Logic Timer Monitor (Step selection)

The customizable logic function allows the user to form a logic circuit for digital input/output signals, customize those signals arbitrarily, and configure a simple relay sequence inside the inverter.

In a customizable logic, one step (component) is composed of "2 inputs and 1 output + logical operation (including timer)" and a total of ten steps can be used to configure a sequence.

■ Specifications

Item	Specifications
Input signal	2 inputs
Operation block	Logical operation, counter, etc.: 13 types Timer: 5 types
Output signal	1 output
Number of steps	10 steps
Customizable logic output signal	5 outputs
Customizable logic processing time	2 ms

■ Block diagram

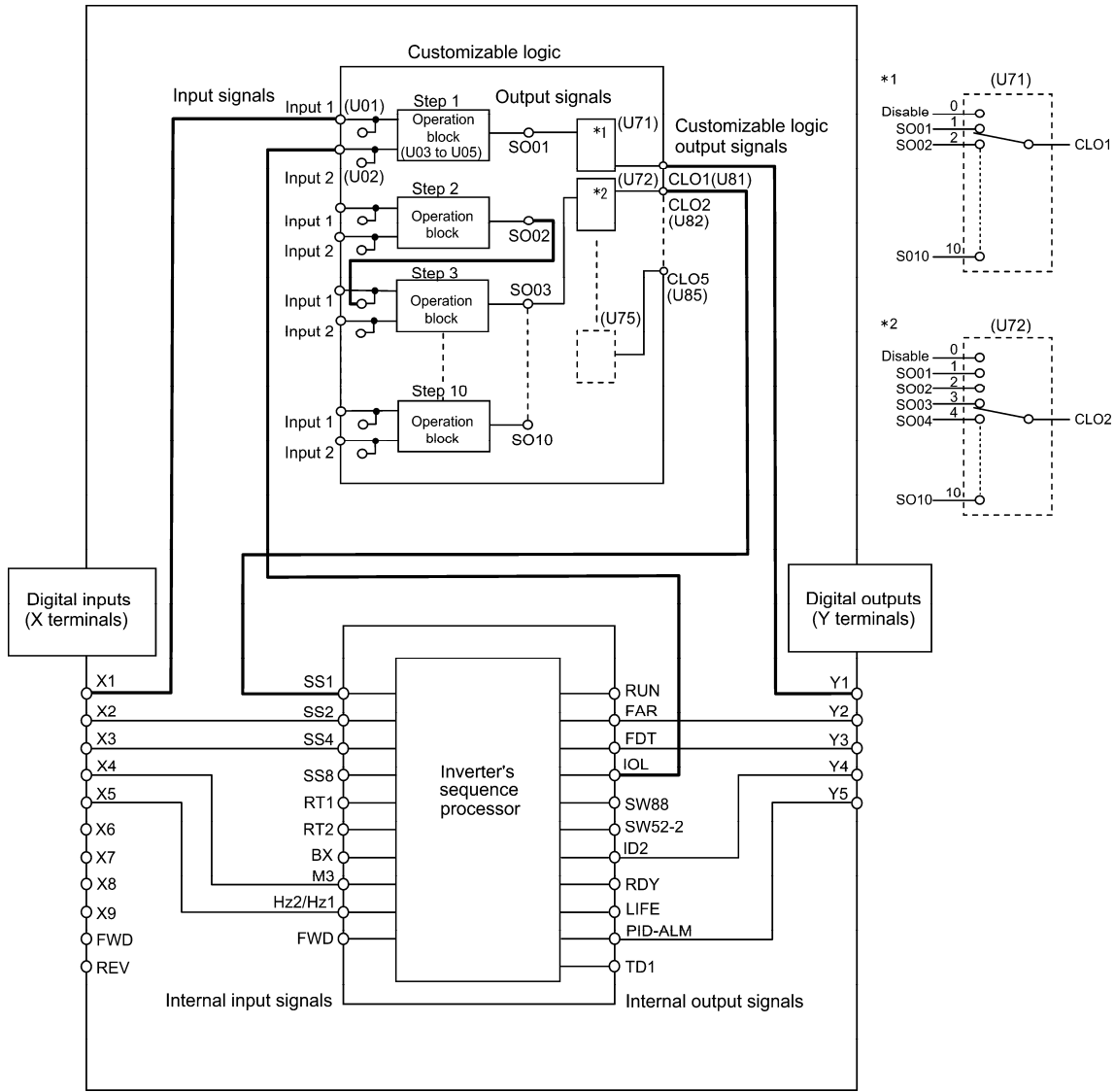

■ Customizable Logic (Mode selection) (U00)

U00 specifies whether to enable the sequence configured with the customizable logic function or disable it to run the inverter only via its input terminals and others.

Data for U00	Function
0	Disable
1	Enable (Customizable logic operation)

■ Customizable Logic (Setting) (U01 to U50)

In a customizable logic, one step is composed of the components shown in the following block diagram.

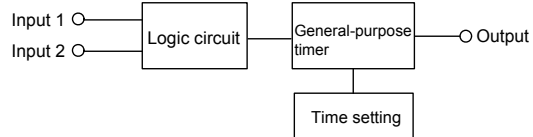

Configuration of function codes for each step

Step No.	Input 1	Input 2	Logic circuit	General-purpose timer	Time setting	Output (Note)
Step 1	U01	U02	U03	U04	U05	SO01
Step 2	U06	U07	U08	U09	U10	SO02
Step 3	U11	U12	U13	U14	U15	SO03
Step 4	U16	U17	U18	U19	U20	SO04
Step 5	U21	U22	U23	U24	U25	SO05
Step 6	U26	U27	U28	U29	U30	SO06
Step 7	U31	U32	U33	U34	U35	SO07
Step 8	U36	U37	U38	U39	U40	SO08
Step 9	U41	U42	U43	U44	U45	SO09
Step 10	U46	U47	U48	U49	U50	SO10

(Note) These items shown in this column are output signals, not function codes.

■ Inputs 1 and 2 (U01, U02, etc.)

The following signals are available as input signals.

Data	Selectable Signals
0000 (1000) 0105 (1105)	General-purpose output signals Same as the ones specified by E20, e.g., RUN (Inverter running), FAR (Frequency (speed) arrival signal), FDT (Frequency (speed) detected), LU (Undervoltage detected (Inverter stopped)), B/D (Torque polarity detected) Note: 27 (Universal DO) is not available.
2001 (3001)	Output of step 1 SO01
2002 (3002)	Output of step 2 SO02
2003 (3003)	Output of step 3 SO03
2004 (3004)	Output of step 4 SO04
2005 (3005)	Output of step 5 SO05
2006 (3006)	Output of step 6 SO06
2007 (3007)	Output of step 7 SO07
2008 (3008)	Output of step 8 SO08
2009 (3009)	Output of step 9 SO09
2010 (3010)	Output of step 10 SO10
4001 (5001)	Terminal [X1] input signal X1
4002 (5002)	Terminal [X2] input signal X2
4003 (5003)	Terminal [X3] input signal X3
4004 (5004)	Terminal [X4] input signal X4
4005 (5005)	Terminal [X5] input signal X5
4006 (5006)	Terminal [X6] input signal X6
4007 (5007)	Terminal [X7] input signal X7
4010 (5010)	Terminal [FWD] input signal FWD
4011 (5011)	Terminal [REV] input signal REV
6000 (7000)	Final run command FL_RUN (ON when "frequency command ≠ 0" and a run command is given)
6001 (7001)	Final FWD run command FL_FWD (ON when "frequency command ≠ 0" and a run forward command is given)
6002 (7002)	Final REV run command FL_REV (ON when "frequency command ≠ 0" and a run reverse command is given)
6003 (7003)	During acceleration DACC (ON during acceleration)
6004 (7004)	During deceleration DDEC (ON during deceleration)

Data	Selectable Signals
6005 (7005)	Under anti-regenerative control REGA (ON under anti-regenerative control)
6006 (7006)	Within dancer reference position DR_REF (ON when the dancer roll position is within the reference range)
6007 (7007)	Alarm factor presence ALM_ACT (ON when there is no alarm factor)

■ Logic circuit (U03, etc.)

Any of the following functions is selectable as a logic circuit (with general-purpose timer).

Data	Function	Description
0	No function assigned	Output is always OFF.
1	Through output + General-purpose timer	Only a general-purpose timer. No logic circuit exists.
2	ANDing + General-purpose timer	AND circuit with 2 inputs and 1 output, plus general-purpose timer.
3	ORing + General-purpose timer	OR circuit with 2 inputs and 1 output, plus general-purpose timer.
4	XORing + General-purpose timer	XOR circuit with 2 inputs and 1 output, plus general-purpose timer.
5	Set priority flip-flop + General-purpose timer	Set priority flip-flop with 2 inputs and 1 output, plus general-purpose timer.
6	Reset priority flip-flop + General-purpose timer	Reset priority flip-flop with 2 inputs and 1 output, plus general-purpose timer.
7	Rising edge detector + General-purpose timer	Rising edge detector with 1 input and 1 output, plus general-purpose timer. This detects the rising edge of an input signal and outputs the ON signal for 2 ms.
8	Falling edge detector + General-purpose timer	Falling edge detector with 1 input and 1 output, plus general-purpose timer. This detects the falling edge of an input signal and outputs the ON signal for 2 ms.
9	Rising & falling edges detector + General-purpose timer	Rising and falling edges detector with 1 input and 1 output, plus general-purpose timer. This detects both the falling and rising edges of an input signal and outputs the ON signal for 2 ms.
10	Hold + General-purpose timer	Hold function of previous values of 2 inputs and 1 output, plus general-purpose timer. If the hold control signal is OFF, the logic circuit outputs input signals; if it is ON, the logic circuit retains the previous values of input signals.
11	Increment counter	Increment counter with reset input. By the rising edge of an input signal, the logic circuit increments the counter value by one. When the counter value reaches the target one, the output signal turns ON. Turning the reset signal ON resets the counter to zero.
12	Decrement counter	Decrement counter with reset input. By the rising edge of an input signal, the logic circuit decrements the counter value by one. When the counter value reaches zero, the output signal turns ON. Turning the reset signal ON resets the counter to the initial value.
13	Timer with reset input	Timer output with reset input. If an input signal turns ON, the output signal turns ON and the timer starts. When the period specified by the timer has elapsed, the output signal turns OFF, regardless of the input signal state. Turning the reset signal ON resets the current timer value to zero and turns the output OFF.

The block diagrams for individual functions are given below.

(1) Through output

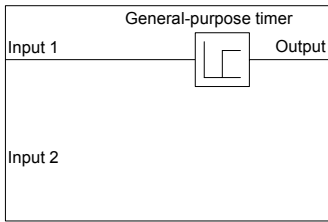

(2) AND

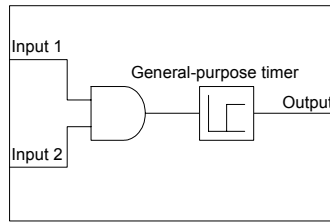

(3) OR

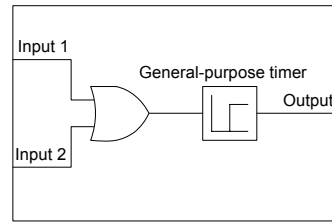

(4) XOR

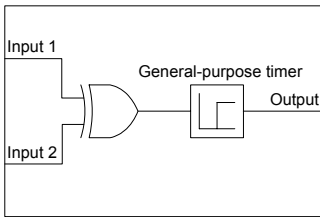

(5) Set priority flip-flop

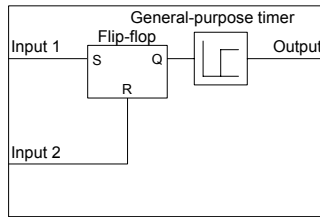

Input 1	Input 2	Previous output	Output	Remarks
OFF	OFF	OFF	OFF	Hold previous value
		ON	ON	
	ON	—	OFF	
ON	—	—	ON	Set priority

(6) Reset priority flip-flop

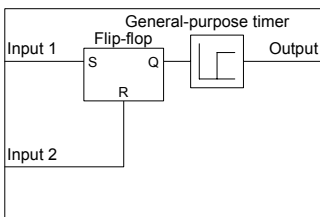

Input 1	Input 2	Previous output	Output	Remarks
OFF	OFF	OFF	OFF	Hold previous value
		ON	ON	
—	ON	—	OFF	Reset priority
ON	OFF	—	ON	

(7) Rising edge detector

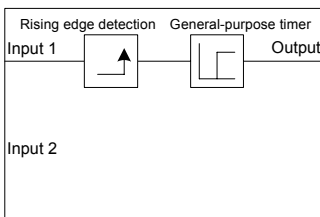

(8) Falling edge detector

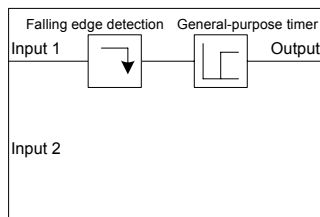

(9) Rising & falling edges detector

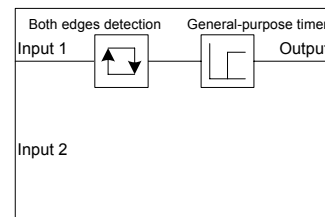

(10) Hold

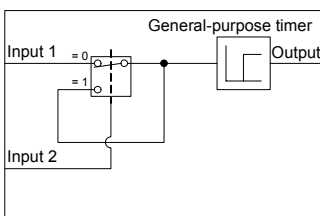

(11) Increment counter

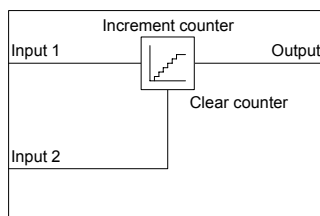

(12) Decrement counter

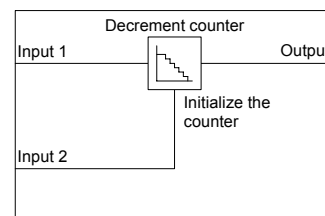

(13) Timer with reset input

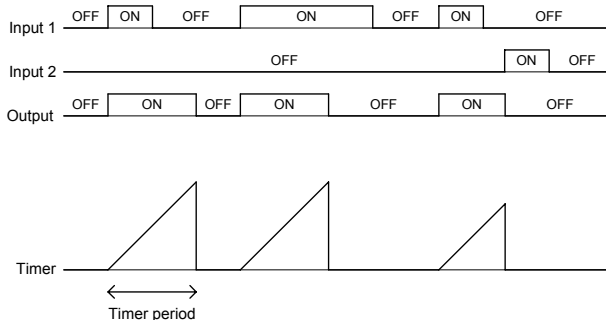
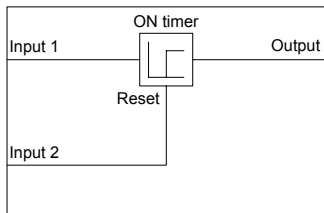

■ General-purpose timer (U04, etc.)

The table below lists the general-purpose timers available.

Data	Function	Description
0	No timer	
1	On-delay timer	Turning an input signal ON starts the on-delay timer. When the period specified by the timer has elapsed, an output signal turns ON. Turning the input signal OFF turns the output signal OFF.
2	Off-delay timer	Turning an input signal ON turns an output signal ON. Turning the input signal OFF starts the off-delay timer. When the period specified by the timer has elapsed, the output signal turns OFF.
3	One-shot pulse output	Turning an input signal ON issues a one-shot pulse whose length is specified by the timer.
4	Retriggerable timer	Turning an input signal ON issues a one-shot pulse whose length is specified by the timer. If an input signal is turned ON again during the preceding one-shot pulse length, however, the logic circuit issues another one-shot pulse.
5	Pulse train output	If an input signal turns ON, the logic circuit issues ON and OFF pulses (whose lengths are specified by the timer) alternately and repeatedly. This function is used to flash a luminescent device.

The operation schemes for individual timers are shown below.

(1) On-delay timer

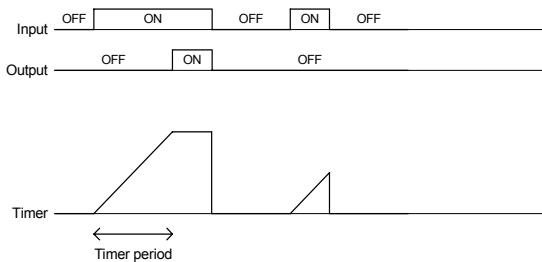

(2) Off-delay timer

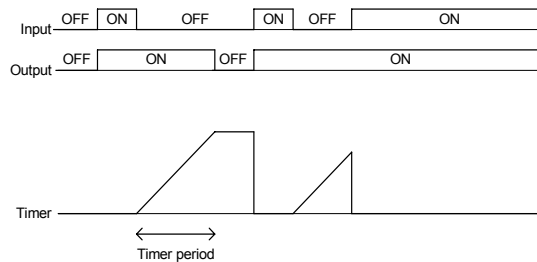

(3) One-shot pulse output

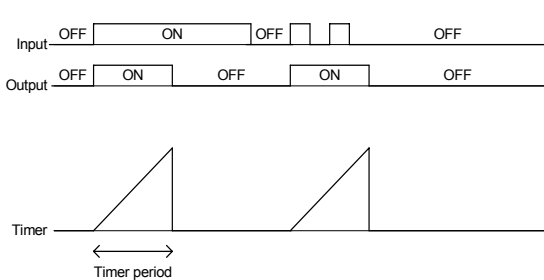

(4) Retriggerable timer

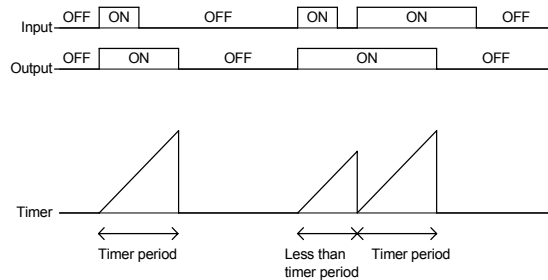

(5) Pulse train output

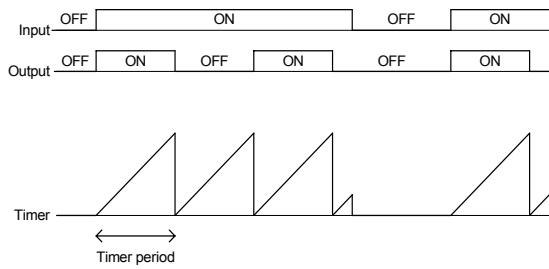

■ Time setting (U05, etc.)

U05 and other related function codes specify the general-purpose timer period or the increment/decrement counter value.

Data	Function	Description
0.00 to 600.00	Timer period	The period is specified by seconds.
	Counter value	The specified value is multiplied by 100 times. (If 0.01 is specified, it is converted to 1.)

■ Output signals

In a customizable logic, outputs from steps 1 to 10 are issued to SO01 to SO10, respectively.

SO01 to SO10 differ in configuration depending upon the connection destination, as listed below. (To relay those outputs to any function other than the customizable logic, route them via customizable logic outputs CLO1 to CLO5.)

If the connection destination is:	Configuration	Function codes
Customizable logic input	Select one of the internal step output signals <i>SO01</i> to <i>SO10</i> in customizable logic input setting.	U01, U02, etc.
Input to the inverter's sequence processor (e.g., "Select multi-frequency" <i>SSI</i> , "Run forward" <i>FWD</i>)	Select one of the internal step output signals <i>SO01</i> to <i>SO10</i> to be connected to customizable logic output signals 1 to 5 (<i>CLO1</i> to <i>CLO5</i>).	U71 to U75
	Select an inverter's sequence processor input function to which one of the customizable logic output signals 1 to 5 (<i>CLO1</i> to <i>CLO5</i>) is to be connected. (Same as in E01)	U81 to U85
General-purpose digital output (Y terminals)	Select one of the internal step output signals <i>SO01</i> to <i>SO10</i> to be connected to customizable logic output signals 1 to 5 (<i>CLO1</i> to <i>CLO5</i>).	U71 to U75
	To specify a general-purpose digital output function (on Y terminals) to which one of the customizable logic output signals 1 to 5 (<i>CLO1</i> to <i>CLO5</i>) is to be connected, select one of <i>CLO1</i> to <i>CLO5</i> by specifying the general-purpose digital output function on any Y terminal.	E20 to E24, E27

Note General-purpose digital outputs (on Y terminals) are updated every 5 ms. To securely output a customizable logic signal via Y terminals, include on- or off-delay timers in the customizable logic. Otherwise, short ON or OFF signals may not be reflected on those terminals.

Function code	Name	Data setting range	Default setting
U71	Customizable logic output signal 1 (Output selection)	0: Disable 1: Output of step 1, SO01 2: Output of step 2, SO02 3: Output of step 3, SO03 4: Output of step 4, SO04 5: Output of step 5, SO05 6: Output of step 6, SO06 7: Output of step 7, SO07 8: Output of step 8, SO08 9: Output of step 9, SO09 10: Output of step 10, SO10	0
U72	Customizable logic output signal 2 (Output selection)		0
U73	Customizable logic output signal 3 (Output selection)		0
U74	Customizable logic output signal 4 (Output selection)		0
U75	Customizable logic output signal 5 (Output selection)		0
U81	Customizable logic output signal 1 (Function selection)	0 to 100, 1000 to 1081 Same as data of E98/E99, except the following. 19 (1019): Enable data change with keypad (data can be modified) 80 (1080): Cancel customizable logic	100
U82	Customizable logic output signal 2 (Function selection)		100
U83	Customizable logic output signal 3 (Function selection)		100
U84	Customizable logic output signal 4 (Function selection)		100
U85	Customizable logic output signal 5 (Function selection)		100

■ **Notes for using a customizable logic**

A customizable logic performs processing every 2 ms in the following sequence.

- (1) At the start of processing, the customizable logic latches all of the external input signals entered to steps 1 to 10 to ensure simultaneity.
- (2) Logical operations are performed in the order of steps 1 to 10.
- (3) If an output of a particular step applies to an input at the next step, the output of the step having processing priority can be used in the same processing.
- (4) The customizable logic updates all of the five output signals at the same time.

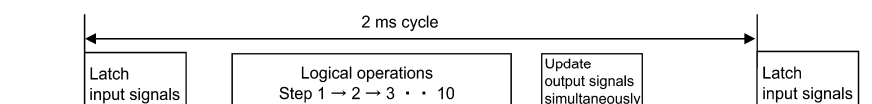

When configuring a logic circuit, take into account the processing order of the customizable logic. Otherwise, a delay in processing of logical operation leads to a signal delay problem, resulting in no expected output, slow processing, or a hazard signal issued.

⚠ CAUTION

Ensure safety before modifying customizable logic related function code settings (U codes and related function codes) or turning ON the "Cancel customizable logic" terminal command **CLC**. Depending upon the settings, such modification or cancellation of the customizable logic may change the operation sequence to cause a sudden motor start or an unexpected motor operation.

An accident or injuries could occur.

■ Customizable logic timer monitor (Step selection) (U91)

The contents of the timer in a customizable logic can be monitored using the monitor-related function code or the keypad.

Selecting a timer to be monitored

Function code	Function	Remarks
U91	1 to 10 U91 specifies the step number whose timer or counter is to be monitored	

Monitoring

Monitored by:	Related function code and LED monitor display	Monitored item
Communications link	X90 Customizable logic (Timer monitor)	Timer or counter value specified by U91 (dedicated to monitoring)

■ Cancel customizable logic -- **CLC** (E01 to E07, data = 80)

This terminal command disables the customizable logic temporarily. Use it to run the inverter without using the customizable logic circuit or timers for maintenance or other purposes.

CLC	Function
OFF	Enable customizable logic (Depends on the U00 setting)
ON	Disable customizable logic

 **Note** Before changing the setting of **CLC**, ensure safety. Turning **CLC** ON disables the sequence of the customizable logic, causing a sudden motor start depending upon the settings.

■ Clear all customizable logic timers -- **CLTC** (E01 to E07, data = 81)

Assigning **CLTC** to any of the general-purpose digital input terminals and turning it ON resets all of the general-purpose timers and counters in the customizable logic. Use this command when the timings between the external sequence and the internal customizable logic do not match due to a momentary power failure or other reasons so that resetting and restarting the system is required.

CLTC	Function
OFF	Ordinary operation
ON	Reset all of the general-purpose timers and counters in the customizable logic. (To operate the timers and counters again, revert CLTC to OFF.)

5.2.10 y codes (Link Functions)

y01 to y20 RS-485 Communication 1 and 2

Up to two ports of RS-485 communications link are available as listed below.

Port	Route	Function code	Applicable equipment
Port 1	RS-485 communications link (via the RJ-45 connector prepared for keypad connection)	y01 through y10	Keypad FRENIC Loader Host equipment
Port 2	RS-485 communications link (via terminals DX+, DX- and SD on the control PCB)	y11 through y20	Host equipment

To connect any of the applicable devices, follow the procedures shown below.

(1) Keypad

The keypad allows you to run and monitor the inverter.

It can be used independent of the y code setting.

(2) FRENIC Loader

Connecting your computer running FRENIC Loader to the inverter via RS-485 communication (port 1), you can monitor the inverter's running status information, edit function codes, and test-run the inverters.

 For the setting of y codes, refer to the descriptions of y01 to y10.



A remote keypad equipped with a USB port is optionally available. To use the FRENIC Loader via the USB port, simply set the station address (y01) to "1" (factory default).

(3) Host equipment

The inverter can be managed and monitored by connecting host equipment such as a PC and PLC to the inverter. Modbus RTU* and Fuji general-purpose inverter protocol are available for communications protocols.

* Modbus RTU is a protocol established by Modicon, Inc.

 For details, refer to the RS-485 Communication User's Manual.

■ Station address (y01 for port 1 and y11 for port 2)

y01 or y11 specifies the station address for the RS-485 communications link. The table below lists the protocols and the station address setting ranges.

Protocol	Station address	Broadcast address
Modbus RTU protocol	1 to 247	0
FRENIC Loader protocol	1 to 255	None
FUJI general-purpose inverter protocol	1 to 31	99

- If any wrong address beyond the above range is specified, no response is returned since the inverter will be unable to receive any enquiries except the broadcast message.

- To use FRENIC Loader via the RS-485 communications link (port 1), set the station address that matches the connected computer.

■ Communications error processing (y02 for port 1 and y12 for port 2)

y02 or y12 specifies the error processing to be performed if an RS-485 communications error occurs.

RS-485 communications errors include logical errors (such as address error, parity error, framing error), transmission protocol error, and physical errors (such as no-response error specified by y08 and y18). The inverter can recognize such an error only when it is configured with a run or frequency command sourced through the RS-485 communications link and it is running. If none of run and frequency commands is sourced through the RS-485 communications link or the inverter is not running, the inverter does not recognize any error occurrence.

Data for y02, y12	Function
0	Immediately trip, displaying an RS-485 communications error ($\overline{E_r}$ for y02 and $\overline{E_r}$ for y12). (The inverter stops with alarm issue.)
1	Run during the period specified by the error processing timer (y03, y13), display an RS-485 communications error ($\overline{E_r}$ for y02 and $\overline{E_r}$ for y12), and then stop operation. (The inverter stops with alarm issue.)
2	Retry communication during the period specified by the error processing timer (y03, y13). If a communications link is recovered, continue operation. Otherwise, display an RS-485 communications error ($\overline{E_r}$ for y02 and $\overline{E_r}$ for y12) and stop operation. (The inverter stops with alarm issue.)
3	Continue to run even when a communications error occurs.

 For details, refer to the RS-485 Communication User's Manual.

■ Timer (y03 for port 1 and y13 for port 2) Data setting range: 0.0 to 60.0 (s)

y03 or y13 specifies an error processing timer. If the timer count has elapsed due to no response from the other end when a query has been issued, the inverter interprets it as an error occurrence. See the "No-response error detection time (y08, y18)" given on the next page.

■ Baud rate (y04 for port 1 and y14 for port 2)

y04 or y14 specifies the transmission speed for RS-485 communication.

For FRENIC Loader (via the RS-485 communications link), specify the transmission speed that matches the connected computer.

Data for y04 and y14	Transmission speed (bps)
0	2400
1	4800
2	9600
3	19200
4	38400

■ Data length (y05 for port 1 and y15 for port 2)

y05 or y15 specifies the character length for RS-485 communication.

For FRENIC Loader (via the RS-485 communications link), no setting is required since Loader automatically sets 8 bits. (The same applies to the Modbus RTU protocol.)

Data for y05 and y15	Data length
0	8 bits
1	7 bits

■ Parity check (y06 for port 1 and y16 for port 2)

y06 or y16 specifies the property of the parity bit.

For FRENIC Loader, no setting is required since Loader automatically sets the even parity.

Data for y06 and y16	Parity
0	None (2 stop bits for Modbus RTU)
1	Even parity (1 stop bit for Modbus RTU)
2	Odd parity (1 stop bit for Modbus RTU)
3	None (1 stop bit for Modbus RTU)

■ Stop bits (y07 for port 1 and y17 for port 2)

y07 or y17 specifies the number of stop bits.

For FRENIC Loader, no setting is required since Loader automatically sets 1 bit.

For the Modbus RTU protocol, no setting is required since the stop bits are automatically determined associated with the property of parity bits.

Data for y07 and y17	Stop bit(s)
0	2 bits
1	1 bit

■ No-response error detection time (y08 for port 1 and y18 for port 2)

y08 or y18 specifies the timeout period for receiving a response from the host equipment (such as a computer or PLC) in RS-485 communication, in order to detect network breaks. This applies to the machinery that accesses the host equipment at the predetermined intervals.

If the response timeout occurs, the inverter starts communications error processing.

For the processing of communications errors, refer to y02 and y12.

Data for y08 and y18	No-response error detection
0	No detection
1 to 60	1 to 60 s

■ Response interval (y09 for port 1 and y19 for port 2) Data setting range: 0.00 to 1.00 (s)

y09 or y19 specifies the latency time after the end of receiving a query sent from the host equipment (such as a computer or PLC) until the start of sending the response. This enables the inverter to control the response timing to match the host equipment that is slow in processing.

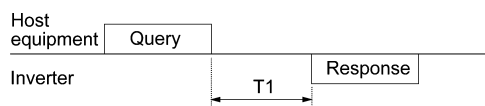

$$T1 = \text{Response interval} + \alpha$$

where α is the processing time inside the inverter. α may vary depending on the processing status and the command processed in the inverter.

For details, refer to the RS-485 Communication User's Manual.

Note When configuring the inverter with FRENIC Loader via the RS-485 communications link, pay sufficient attention to the performance and configuration of the PC and protocol converter such as USB-RS-485 converter. Some protocol converters monitor the communications status and switch between sending and receiving of transmission data with a timer.

■ Protocol selection (y10 for port 1)

y10 specifies the communications protocol for port 1.

For FRENIC Loader (via the RS-485 communications link), only y10 can be used for protocol selection. Set the y10 data at "1."

Data for y10	Protocol
0	Modbus RTU protocol
1	FRENIC Loader protocol
2	Fuji general-purpose inverter protocol

■ Protocol selection (y20 for port 2)

y20 specifies the communications protocol for port 2.



Data for y20	Protocol
0	Modbus RTU protocol
2	Fuji general-purpose inverter protocol

y97 Communication Data Storage Selection

A nonvolatile storage in the inverter has a limited number of rewritable times (100,000 to 1,000,000 times). Saving data into the storage so many times unnecessarily will no longer allow the storage to save data, causing memory errors.

For frequent data writing via the communications link, therefore, a temporary storage is provided instead of the nonvolatile storage. To use the temporary storage, set the y97 data at "1." Using the temporary storage reduces the number of data writing times into the nonvolatile storage, preventing memory errors.

Setting the y97 data at "2" saves all data written in the temporary storage into the nonvolatile one.

Changing the y97 data requires simultaneous keying of  and  /  keys.

Data for y97	Function
0	Save into nonvolatile storage (Rewritable times limited)
1	Write into temporary storage (Rewritable times unlimited)
2	Save all data from temporary storage to nonvolatile one (After saving data, the data automatically returns to "1.")

y98 Bus Link Function (Mode selection)

(Refer to H30.)

y99 Loader Link Function (Mode selection)

This is a link switching function for FRENIC Loader. Rewriting the data of y99 to enable RS-485 communications from Loader helps Loader send the inverter the frequency and/or run commands. Since the data to be set in the function code of the inverter is automatically set by Loader, no keypad operation is required.

With Loader being selected as a run command source, if the computer runs out of control and cannot be stopped by a stop command sent from Loader, disconnect the RS-485 communications cable from the port 1 (or disconnect the USB cable in the case of a remote keypad equipped with a USB port), connect a keypad instead, and reset the y99 data to "0." The setting of "0" in y99 means that the run and frequency command source specified by function code H30 takes place instead of FRENIC Loader.

Note that the inverter cannot save the setting of y99. When power is turned off, the data in y99 is lost (y99 is reset to "0").

Data for y99	Function	
	Frequency command	Run command
0	Follow H30 and y98 data	Follow H30 and y98 data
1	Via RS-485 link (FRENIC Loader)	Follow H30 and y98 data
2	Follow H30 and y98 data	Via RS-485 link (FRENIC Loader)
3	Via RS-485 link (FRENIC Loader)	Via RS-485 link (FRENIC Loader)

Chapter 6 TROUBLESHOOTING

6.1 Protective Functions

The FRENIC-MEGA series of inverters has various protective functions as listed below to prevent the system from going down and reduce system downtime. The protective functions marked with an asterisk (*) in the table are disabled by default. Enable them according to your needs.

The protective functions include, for example, the "alarm" detection function which, upon detection of an abnormal state, displays the alarm code on the LED monitor and causes the inverter to trip, the "light alarm" detection function which displays the alarm code but lets the inverter continue the current operation, and other warning signal output functions.

If any problem arises, understand the protective functions listed below and follow the procedures given in Sections 6.2 and onwards for troubleshooting.

Protective function	Description	Related function code
"Alarm" detection	This function detects an abnormal state, displays the corresponding alarm code, and causes the inverter to trip. The "alarm" codes are check-marked in the "Alarm" object column in Table 6.1. For details of each alarm code, see the corresponding item in the troubleshooting. The inverter retains the last four alarm codes and their factors together with their running information applied when the alarm occurred, so it can display them.	H98
"Light alarm" detection*	This function detects an abnormal state categorized as a "light alarm," displays $\angle -FL$ and lets the inverter continue the current operation without tripping. It is possible to define which abnormal states should be categorized as a "light alarm" using function codes H81 and H82. The "light alarm" codes are check-marked in the "Light alarm" object column in Table 6.1. For how to check and release light alarms, see Section 6.5 "If the "Light Alarm" Indication ($\angle -FL$) Appears on the LED Monitor."	H81 H82
Stall prevention	When the output current exceeds the current limiter level (F44) during acceleration/ deceleration or constant speed running, this function decreases the output frequency to avoid an overcurrent trip.	F44
Overload prevention control*	Before the inverter trips due to a heat sink overheat ($\angle HI$) or inverter overload ($\angle LL$), this function decreases the output frequency to reduce the load.	H70
Automatic deceleration* (Anti-regenerative control)	If regenerative energy returned exceeds the inverter's braking capability, this function automatically increases the deceleration time or controls the output frequency to avoid an overvoltage trip.	H69
Deceleration characteristics* (Excessive regenerative energy proof braking capability)	During deceleration, this function increases the motor energy loss and decreases the regenerative energy returned to avoid an overvoltage trip ($\angle LL$).	H71
Reference loss detection*	This function detects a reference frequency loss (due to a broken wire, etc.), continues the inverter operation at the specified frequency, and issues the "Command loss detected" signal REF OFF .	E65
Automatic lowering of carrier frequency	Before the inverter trips due to an abnormal surrounding temperature or output current, this function automatically lowers the carrier frequency to avoid a trip.	H98
Dew condensation prevention*	Even when the inverter is in stopped state, this function feeds DC current across the motor at certain intervals to raise the motor temperature for preventing dew condensation.	J21
Motor overload early warning*	When the inverter output current has exceeded the specified level, this function issues the "Motor overload early warning" signal OL before the thermal overload protection function causes the inverter to trip for motor protection. This function exclusively applies to the 1st motor.	E34 E35
Auto-reset*	When the inverter has stopped because of a trip, this function allows the inverter to automatically reset and restart itself. (The number of retries and the latency between stop and reset can be specified.)	H04 H05
Forced stop*	Upon receipt of the "Force to stop" terminal command STOP , this function interrupts the run and other commands currently applied in order to forcedly decelerate the inverter to a stop.	H56
Surge protection	This function protects the inverter from a surge voltage invaded between main circuit power lines and the ground.	--

Table 6.1 Abnormal States Detectable ("Alarm" and "Light Alarm" Objects)

Code	Name	"Alarm" objects	"Light alarm" objects	Remarks	Ref. page
<i>OC 1, OC2, OC3</i>	Instantaneous overcurrent	√	--		6-12
<i>EF</i>	Ground fault	√	--	50 HP or above	6-12
<i>OU 1, OU2, OU3</i>	Overvoltage	√	--		6-12
<i>LU</i>	Undervoltage	√	--		6-13
<i>L in</i>	Input phase loss	√	--		6-14
<i>OPL</i>	Output phase loss	√	--		6-14
<i>OH 1</i>	Heat sink overheat	√	√		6-14
<i>OH2</i>	External alarm	√	√		6-15
<i>OH3</i>	Inverter internal overheat	√	√		6-15
<i>OH4</i>	Motor protection (PTC/NTC thermistor)	√	--		6-16
<i>obH</i>	Braking resistor overheat	√	√	40 HP or below	6-16
<i>FUS</i>	Fuse blown	√	--	125 HP or above for 230 V series 150 HP or above for 460 V series	6-17
<i>PbF</i>	Charger circuit fault	√	--	60 HP or above for 230 V series 125 HP or above for 460 V series	6-17
<i>OL 1 to OL 4</i>	Overload of motor 1 through 4	√	√		6-17
<i>OLU</i>	Inverter overload	√	--		6-18
<i>OS</i>	Overspeed	√	--		6-18
<i>PG</i>	PG wire break	√	--		6-19
<i>Er 1</i>	Memory error	√	--		6-19
<i>Er 2</i>	Keypad communications error	√	--		6-19
<i>Er 3</i>	CPU error	√	--		6-20
<i>Er 4</i>	Option communications error	√	√		6-20
<i>Er 5</i>	Option error	√	√		6-20
<i>Er 6</i>	Operation protection	√	--		6-20
<i>Er 7</i>	Tuning error	√	--		6-21
<i>Er 8</i> <i>Er P</i>	RS-485 communications error (COM port 1) RS-485 communications error (COM port 2)	√	√		6-21
<i>Er F</i>	Data saving error during undervoltage	√	--		6-22
<i>Er H</i>	Hardware error	√	--	60 HP or above for 230 V series 75 HP or above for 460 V series	6-22
<i>Er E</i>	Speed mismatch or excessive speed deviation	√	√		6-22
<i>nr b</i>	NTC wire break error	√	--		6-23
<i>Err</i>	Mock alarm	√	--		6-23
<i>Lo F</i>	PID feedback wire break	√	√		6-24
<i>ob R</i>	Braking transistor broken	√	--		6-24
<i>Er o</i>	Positioning control error	(Servo-lock)	√	--	6-24
		(Synchronous control)	√	√	6-24
<i>ECF</i>	Enable circuit failure	√	--		6-24

Table 6.1 Abnormal States Detectable ("Alarm" and "Light Alarm" Objects) (Continued)

Code	Name	"Alarm" objects	"Light alarm" objects	Remarks	Ref. page
<i>L-AL</i>	Light alarm	--	--		--
<i>FAL</i>	DC fan locked	--	√	75 HP or above for 230 V series 125 HP or above for 460 V series	--
<i>OL</i>	Motor overload early warning	--	√		--
<i>OH</i>	Heat sink overheat early warning	--	√		--
<i>LIF</i>	Lifetime alarm	--	√		--
<i>r-EL</i>	Reference command loss detected	--	√		--
<i>PID</i>	PID alarm	--	√		--
<i>LTL</i>	Low torque output	--	√		--
<i>PTC</i>	PTC thermistor activated	--	√		--
<i>r-LE</i>	Inverter life (Motor cumulative run time)	--	√		--
<i>LrL</i>	Inverter life (Number of startups)	--	√		--

6.2 Before Proceeding with Troubleshooting

⚠ WARNING ⚠

If any of the protective functions has been activated, first remove the cause. Then, after checking that the all run commands are set to OFF, release the alarm. If the alarm is released while any run commands are set to ON, the inverter may supply the power to the motor, running the motor.

Injury may occur.

- Even if the inverter has interrupted power to the motor, if the voltage is applied to the main circuit input terminals L1/R, L2/S and L3/T, voltage may be output to inverter output terminals U, V, and W.
- **Turn OFF the power and wait at least five minutes for inverters of 40 HP or below, or at least ten minutes for inverters of 50 HP or above.** Make sure that the LED monitor and charging lamp are turned OFF. Further, make sure, using a multimeter or a similar instrument, that the DC link bus voltage between the terminals P (+) and N (-) has dropped to the safe level (+25 VDC or below).

Electric shock may occur.

Follow the procedure below to solve problems.

(1) First, check that the inverter is correctly wired, referring to Chapter 2, Section 2.3.4 "Wiring of main circuit terminals and grounding terminals."

(2) Check whether an alarm code or the "light alarm" indication ($\angle -FL$) is displayed on the LED monitor.

- If neither an alarm code nor "light alarm" indication ($\angle -FL$) appears on the LED monitor

Abnormal motor operation → Go to Section 6.3.1.

- [1] The motor does not rotate.
- [2] The motor rotates, but the speed does not increase.
- [3] The motor runs in the opposite direction to the command.
- [4] Speed fluctuation or current oscillation (e.g., hunting) occurs during running at constant speed.
- [5] Grating sound is heard from the motor or the motor sound fluctuates.
- [6] The motor does not accelerate or decelerate within the specified time.
- [7] The motor does not restart even after the power recovers from a momentary power failure.
- [8] The motor abnormally heats up.
- [9] The motor does not run as expected.

Problems with inverter settings → Go to Section 6.3.2.

- [1] Nothing appears on the LED monitor.
- [2] The desired menu is not displayed.
- [3] Data of function codes cannot be changed.

- If an alarm code appears on the LED monitor → Go to Section 6.4.

- If the "light alarm" indication ($\angle -FL$) appears on the LED monitor → Go to Section 6.5.

- If an abnormal pattern appears on the LED monitor while neither an alarm code nor "light alarm" indication ($\angle -FL$) is displayed → Go to Section 6.6.

- For problems that could be caused by running the inverter on single-phase power → Go to Section 6.7.

If any problems persist after the above recovery procedure, contact your Fuji Electric representative.

6.3 If Neither an Alarm Code Nor "Light Alarm" Indication (\underline{L} - \overline{AL}) Appears on the LED Monitor

This section describes the troubleshooting procedure based on function codes dedicated to motor 1 which are marked with an asterisk (*). For motors 2 to 4, replace those asterisked function codes with respective motor dedicated ones (refer to Chapter 5, Section 5.2.6, Table 5.5).

 For the function codes dedicated to motors 2 to 4, see Chapter 5 "FUNCTION CODES."

6.3.1 Abnormal motor operation

[1] The motor does not rotate.

Possible Causes	What to Check and Suggested Measures
(1) No power supplied to the inverter.	<p>Check the input voltage and interphase voltage unbalance.</p> <ul style="list-style-type: none"> ➔ Turn ON a molded case circuit breaker (MCCB), a residual-current-operated protective device (RCD)/earth leakage circuit breaker (ELCB) (with overcurrent protection) or a magnetic contactor (MC). ➔ Check for voltage drop, phase loss, poor connections, or poor contacts, and fix them if necessary. ➔ If only the auxiliary control power input is supplied, also supply the main power to the inverter.
(2) No run forward/reverse command was inputted, or both the commands were inputted simultaneously (external signal operation).	<p>Check the input status of the forward/reverse command with Menu #4 "I/O Checking" using the keypad.</p> <ul style="list-style-type: none"> ➔ Input a run command. ➔ Set either the forward or reverse run command off if both commands are being entered. ➔ Correct the run command source. (Set F02 data to "1.") ➔ Correct the assignment of commands <i>FWD</i> and <i>REV</i> with function codes E98 and E99. ➔ Connect the external circuit wires to control circuit terminals [FWD] and [REV] correctly. ➔ Make sure that the sink/source slide switch (SW1) on the control printed circuit board (control PCB) is properly configured.
(3) No Enable input	<p>Check the input status of terminal [EN] with Menu #4 "I/O Checking" using the keypad.</p> <ul style="list-style-type: none"> ➔ Correct the external circuit wiring to control circuit terminal [EN].
(4) The inverter could not accept any run commands from the keypad since it was in Programming mode.	<p>Check which operation mode the inverter is in, using the keypad.</p> <ul style="list-style-type: none"> ➔ Shift the operation mode to Running mode and enter a run command.
(5) A run command with higher priority than the one attempted was active, and the run command was stopped.	<p>Referring to the block diagram of the frequency command block (given in FRENIC-MEGA User's Manual, Chapter 6), check the higher priority run command with Menu #2 "Data Checking" and Menu #4 "I/O Checking" using the keypad.</p> <ul style="list-style-type: none"> ➔ Correct any incorrect function code data settings (in H30, y98, etc.) or cancel the higher priority run command.
(6) No analog frequency command input.	<p>Check whether the analog frequency command (reference frequency) is correctly inputted, using Menu #4 "I/O Checking" on the keypad.</p> <ul style="list-style-type: none"> ➔ Connect the external circuit wires to terminals [13], [12], [11], [C1], and [V2] correctly. ➔ When terminal [C1] is used, check the slider position of terminal [C1] property switch (SW5) and the setting of the thermistor mode selection (H26).
(7) The reference frequency was below the starting or stop frequency.	<p>Check that a reference frequency has been entered correctly, using Menu #4 "I/O Checking" on the keypad.</p> <ul style="list-style-type: none"> ➔ Set the reference frequency at the same or higher than that of the starting and stop frequencies (F23* and F25). ➔ Reconsider the starting and stop frequencies (F23* and F25), and if necessary, change them to the lower values. ➔ Inspect the external frequency command potentiometers, signal converters, switches, and relay contacts. Replace any ones that are faulty. ➔ Connect the external circuit wires to terminals [13], [12], [11], [C1], and [V2] correctly.

Possible Causes	What to Check and Suggested Measures
(8) A frequency command with higher priority than the one attempted was active.	Check the higher priority run command with Menu #2 "Data Checking" and Menu #4 "I/O Checking" using the keypad, referring to the block diagram of the frequency command block (refer to the FRENIC-MEGA User's Manual, Chapter 6). ➔ Correct any incorrect function code data (e.g. cancel the higher priority run command).
(9) The upper and lower frequencies for the frequency limiters were set incorrectly.	Check the data of function codes F15 (Frequency limiter (High)) and F16 (Frequency limiter (Low)). ➔ Change the settings of F15 and F16 to the correct ones.
(10) The coast-to-stop command was effective.	Check the data of function codes E01 through E07, E98, and E99 and the input signal status, using Menu #4 "I/O Checking" on the keypad. ➔ Release the coast-to-stop command setting.
(11) Broken wires, incorrect connection or poor contact with the motor.	Check the wiring (Measure the output current). ➔ Repair the wires to the motor, or replace them.
(12) Overload	Measure the output current. ➔ Reduce the load (In winter, the load tends to increase.)
	Check whether any mechanical brake is activated. ➔ Release the mechanical brake, if any.
(13) Torque generated by the motor was insufficient.	Check that the motor starts running if the value of torque boost (F09*) is increased. ➔ Increase the value of torque boost (F09*) and try to run the motor.
	Check the data of function codes F04*, F05*, H50, H51, H52, H53, H65, and H66. ➔ Change the V/f pattern to match the motor's characteristics.
	Check that the motor switching signal (selecting motor 1, 2, 3 or 4) is correct and the data of function codes matches each motor. ➔ Correct the motor switching signal. ➔ Modify the function code data to match the connected motor.
	Check whether the reference frequency is below the slip-compensated frequency of the motor. ➔ Change the reference frequency so that it becomes higher than the slip-compensated frequency of the motor.
(14) Wrong connection or poor contact of DC reactor (DCR)	Check the wiring. Inverters of 100 HP or above require a DCR to be connected. Without a DCR, these inverters cannot run. ➔ Connect the DCR correctly. Repair or replace DCR wires.

[2] The motor rotates, but the speed does not increase.

Possible Causes	What to Check and Suggested Measures
(1) The maximum frequency currently specified was too low.	Check the data of function code F03* (Maximum frequency). ➔ Correct the F03* data.
(2) The data of frequency limiter (High) currently specified was too low.	Check the data of function code F15 (Frequency limiter (High)). ➔ Correct the F15 data.
(3) The reference frequency currently specified was too low.	Check that the reference frequency has been entered correctly, using Menu #4 "I/O Checking" on the keypad. ➔ Increase the reference frequency. ➔ Inspect the external frequency command potentiometers, signal converters, switches, and relay contacts. Replace any ones that are faulty. ➔ Connect the external circuit wires to terminals [13], [12], [11], [C1], and [V2] correctly.
(4) A frequency command (e.g., multi-frequency or via communications) with higher priority than the one attempted was active and its reference frequency was too low.	Check the data of the relevant function codes and what frequency commands are being received, through Menu #1 "Data Setting," Menu #2 "Data Checking" and Menu #4 "I/O Checking," on the keypad by referring to the block diagram of the frequency command (refer to the FRENIC-MEGA User's Manual, Chapter 6). ➔ Correct any incorrect data of function codes (e.g. cancel the higher priority frequency command).

Possible Causes	What to Check and Suggested Measures
(5) The acceleration time was too long or too short.	Check the data of function codes F07, E10, E12, and E14 (Acceleration time). ➔ Change the acceleration time to match the load.
(6) Overload.	Measure the output current. ➔ Reduce the load.
	Check whether any mechanical brake is activated. ➔ Release the mechanical brake.
(7) Function code settings do not agree with the motor characteristics.	If auto-torque boost or auto-energy saving operation is specified, check whether the data of P02*, P03*, P06*, P07*, and P08* agree with the parameters of the motor. ➔ Perform auto-tuning of the inverter for the motor to be used.
(8) The output frequency does not increase due to the current limiter operation.	Make sure that F43 (Current limiter (Mode selection)) is set to "2" and check the data of F44 (Current limiter (Level)). ➔ Correct the F44 data. Or, if the current limiter operation is not needed, set F43 to "0" (disabled).
	Decrease the value of torque boost (F09*), then run the motor again and check if the speed increases. ➔ Adjust the value of the torque boost (F09*).
	Check the data of function codes F04*, F05*, H50, H51, H52, H53, H65, and H66 to ensure that the V/f pattern setting is right. ➔ Match the V/f pattern setting with the motor ratings.
(9) The output frequency does not increase due to the torque limiter operation.	Check whether data of torque limiter related function codes (F40, F41, E16 and E17) is correctly configured and the "Select torque limiter level" terminal command TL2/TLI is correct. ➔ Correct data of F40, F41, E16 and E17 or reset them to the factory defaults (disable). ➔ Set the TL2/TLI correctly.
(10) Bias and gain incorrectly specified.	Check the data of function codes F18, C50, C32, C34, C37, C39, C42, and C44. ➔ Readjust the bias and gain to appropriate values.

[3] The motor runs in the opposite direction to the command.

Possible Causes	What to Check and Suggested Measures
(1) Wiring to the motor is incorrect.	Check the wiring to the motor. ➔ Connect terminals U, V, and W of the inverter to the U, V, and W terminals of the motor, respectively.
(2) Incorrect connection and settings for run commands and rotation direction commands FWD and REV .	Check the data of function codes E98 and E99 and the connection to terminals [FWD] and [REV]. ➔ Correct the data of the function codes and the connection.
(3) The rotation direction specification of the motor is opposite to that of the inverter.	The rotation direction of IEC-compliant motors is opposite to that of incompliant motors. ➔ Switch the FWD/REV signal setting.

[4] Speed fluctuation or current oscillation (e.g., hunting) occurs during running at constant speed.

Possible Causes	What to Check and Suggested Measures
(1) The frequency command fluctuates.	Check the signals for the frequency command with Menu #4 "I/O Checking" using the keypad. ➔ Increase the filter constants (C33, C38, and C43) for the frequency command.
(2) An external potentiometer is used for frequency setting.	Check that there is no noise in the control signal wires from external sources. ➔ Isolate the control signal wires from the main circuit wires as far as possible. ➔ Use shielded or twisted wires for control signals.
	Check whether the external frequency command potentiometer is malfunctioning due to noise from the inverter. ➔ Connect a capacitor to the output terminal of the potentiometer or set a ferrite core on the signal wire. (Refer to Chapter 2.)

Possible Causes	What to Check and Suggested Measures
(3) Frequency switching or multi-frequency command was enabled.	Check whether the relay signal for switching the frequency command is chattering. → If the relay contact is defective, replace the relay.
(4) The wiring length between the inverter and the motor is too long.	Check whether auto-torque boost, auto-energy saving operation, or dynamic torque vector control is enabled. → Perform auto-tuning of the inverter for every motor to be used. → Disable the automatic control systems by setting F37* to "1" (Constant torque load) and F42* to "0" (V/f control with slip compensation active), then check that the motor vibration stops. → Make the output wires as short as possible.
(5) The machinery is hunting due to vibration caused by low rigidity of the load. Or the current is irregularly oscillating due to special motor parameters.	Once disable all the automatic control systems such as auto torque boost, auto energy saving operation, overload prevention control, current limiter, torque limiter, automatic deceleration (anti-regenerative control), auto search for idling motor speed, slip compensation, dynamic torque vector control, droop control, overload stop function, speed control, tuning, notch filter, observer, and then check that the motor vibration comes to a stop. → Disable the functions causing the vibration. → Readjust the output current fluctuation damping gain (H80*). → Readjust the speed control systems. (d01* through d06*)
	Check that the motor vibration is suppressed if you decrease the level of F26 (Motor sound (Carrier frequency)) or set F27 (Motor sound (Tone)) to "0." → Decrease the carrier frequency (F26) or set the tone to "0" (F27 = 0).

[5] Grating sound is heard from the motor or the motor sound fluctuates.

Possible Causes	What to Check and Suggested Measures
(1) The specified carrier frequency is too low.	Check the data of function codes F26 (Motor sound (Carrier frequency)) and F27 (Motor sound (Tone)). → Increase the carrier frequency (F26). → Change the setting of F27 to appropriate value.
(2) The surrounding temperature of the inverter was too high (when automatic lowering of the carrier frequency was enabled by H98).	Measure the temperature inside the panel where the inverter is mounted. → If it is over 40°C (104°F), lower it by improving the ventilation. → Lower the temperature of the inverter by reducing the load. (For fans or pumps, decrease the frequency limiter value (F15).) Note: If you disable H98, an <i>OH</i> , <i>OH3</i> , or <i>OLU</i> alarm may occur.
(3) Resonance with the load.	Check the machinery mounting accuracy or check whether there is resonance with the mounting base. → Disconnect the motor from the machinery and run it alone, then find where the resonance comes from. Upon locating the cause, improve the characteristics of the source of the resonance. → Adjust the settings of C01 (Jump frequency 1) to C04 (Jump frequency (Hysteresis width)) so as to avoid continuous running in the frequency range causing resonance. → Enable the speed control (notch filter) (d07*, d08*) and the observer (d18 to d20) to suppress vibration. (Depending on the characteristics of the load, this may take no effect.)

[6] The motor does not accelerate or decelerate within the specified time.

Possible Causes	What to Check and Suggested Measures
(1) The inverter runs the motor with S-curve or curvilinear pattern.	Check the data of function code H07 (Acceleration/deceleration pattern). → Select the linear pattern (H07 = 0). → Shorten the acceleration/deceleration time (F07, F08, E10 through E15).
(2) The current limiting operation prevented the output frequency from increasing (during acceleration).	Make sure that F43 (Current limiter (Mode selection)) is set to "2: Enable during acceleration and at constant speed," then check that the setting of F44 (Current limiter (Level)) is reasonable. → Readjust the setting of F44 to appropriate value, or disable the function of current limiter with F43. → Increase the acceleration/deceleration time (F07, F08, E10 through E15).
(3) The automatic deceleration (Anti-regenerative control) is enabled during deceleration.	Check the data of function code H69 (Automatic deceleration (Mode selection)). → Increase the deceleration time (F08, E11, E13, and E15).
(4) Overload.	Measure the output current. → Reduce the load (For fans or pumps, decrease the frequency limiter value (F15).) (In winter, the load tends to increase.)
(5) Torque generated by the motor was insufficient.	Check that the motor starts running if the value of the torque boost (F09*) is increased. → Increase the value of the torque boost (F09*).
(6) An external potentiometer is used for frequency setting.	Check that there is no noise in the control signal wires from external sources. → Isolate the control signal wires from the main circuit wires as far as possible. → Use shielded or twisted wires for control signals. → Connect a capacitor to the output terminal of the external frequency command potentiometer or set a ferrite core on the signal wire. (Refer to Chapter 2.)
(7) The output frequency is limited by the torque limiter.	Check whether data of torque limiter related function codes (F40, F41, E16 and E17) is correctly configured and the TL2/TL1 terminal command ("Select torque limiter level 2/1") is correct. → Correct the data of F40, F41, E16 and E17 or reset them to the factory defaults. → Set the TL2/TL1 correctly. → Increase the acceleration/deceleration time (F07, F08, E10 through E15).
(8) The specified acceleration or deceleration time was incorrect.	Check the terminal commands RT1 and RT2 for acceleration/deceleration times. → Correct the RT1 and RT2 settings.

[7] The motor does not restart even after the power recovers from a momentary power failure.

Possible Causes	What to Check and Suggested Measures
(1) The data of function code F14 is either "0," "1," or "2."	Check if an undervoltage trip (\underline{L} \underline{L}) occurs. → Change the data of function code F14 (Restart mode after momentary power failure (Mode selection)) to "3," "4," or "5."
(2) The run command remains OFF even after the power has been restored.	Check the input signal with Menu #4 "I/O Checking" using the keypad. → Check the power recovery sequence with an external circuit. If necessary, consider the use of a relay that can keep the run command ON. In 3-wire operation, the power to the control printed circuit board (control PCB) has been shut down once because of a long momentary power failure time, or the "Enable 3-wire operation" signal HOLD has been turned OFF once. → Change the design or the setting so that a run command can be issued again within 2 seconds after the power has been restored.

[8] The motor abnormally heats up.

Possible Causes	What to Check and Suggested Measures
(1) Excessive torque boost specified.	Check whether decreasing the torque boost (F09*) decreases the output current but does not stall the motor. ➔ If no stall occurs, decrease the torque boost (F09*).
(2) Continuous running in extremely slow speed.	Check the running speed of the inverter. ➔ Change the speed setting or replace the motor with a motor exclusively designed for inverters.
(3) Overload.	Measure the inverter output current. ➔ Reduce the load (For fans or pumps, decrease the frequency limiter value (F15).) (In winter, the load tends to increase.)

[9] The motor does not run as expected.



Possible Causes	What to Check and Suggested Measures
(1) Incorrect setting of function code data.	Check that function codes are correctly configured and no unnecessary configuration has been done. ➔ Configure all the function codes correctly.
	Make a note of function code data currently configured and then initialize all function code data using H03. ➔ After the above process, reconfigure function codes one by one, checking the running status of the motor.
(2) Running on single-phase power	➔ Refer to Section 6.7 "If the Inverter is Running on Single-Phase Power," [3].

6.3.2 Problems with inverter settings

[1] Nothing appears on the LED monitor.

Possible Causes	What to Check and Suggested Measures
(1) No power (neither main power nor auxiliary control power) supplied to the inverter.	<p>Check the input voltage and interphase voltage unbalance.</p> <ul style="list-style-type: none"> ➔ Turn ON a molded case circuit breaker (MCCB), a residual-current-operated protective device (RCD)/earth leakage circuit breaker (ELCB) (with overcurrent protection) or a magnetic contactor (MC). ➔ Check for voltage drop, phase loss, poor connections, or poor contacts and fix them if necessary.
(2) The power for the control PCB did not reach a sufficiently high level.	<p>Check if the jumper bar has been removed between terminals P1 and P(+) or if there is a poor contact between the jumper bar and those terminals.</p> <ul style="list-style-type: none"> ➔ Mount a jumper bar or a DC reactor between terminals P1 and P(+). For poor contact, tighten up the screws.
(3) The keypad was not properly connected to the inverter.	<p>Check whether the keypad is properly connected to the inverter.</p> <ul style="list-style-type: none"> ➔ Remove the keypad, put it back, and see whether the problem recurs. ➔ Replace the keypad with another one and check whether the problem recurs.
	<p>When running the inverter remotely, ensure that the extension cable is securely connected both to the keypad and to the inverter.</p> <ul style="list-style-type: none"> ➔ Disconnect the cable, reconnect it, and see whether the problem recurs. ➔ Replace the keypad with another one and check whether the problem per recurs.

[2] Data of function codes cannot be changed.

Possible Causes	What to Check and Suggested Measures
(1) An attempt was made to change function code data that cannot be changed when the inverter is running.	<p>Check if the inverter is running with Menu #3 "Drive Monitoring" using the keypad and then confirm whether the data of the function codes can be changed when the motor is running by referring to the function code tables.</p> <ul style="list-style-type: none"> ➔ Stop the motor then change the data of the function codes.
(2) The data of the function codes is protected.	<p>Check the data of function code F00 (Data Protection).</p> <ul style="list-style-type: none"> ➔ Change the F00 data from "Enable data protection" (1 or 3) to "Disable data protection" (0 or 2).
(3) The WE-KP terminal command ("Enable data change with keypad") is not entered, though it has been assigned to a digital input terminal.	<p>Check the data of function codes E01 through E07, E98 and E99 and the input signal status with Menu #4 "I/O Checking" using the keypad.</p> <ul style="list-style-type: none"> ➔ Input a WE-KP command through a digital input terminal.
(4) The  key was not pressed.	<p>Check whether you have pressed the  key after changing the function code data.</p> <ul style="list-style-type: none"> ➔ Press the  key after changing the function code data. ➔ Check that SPULC is displayed on the LED monitor.
(5) The data of function codes F02, E01 through E07, E98, and E99 cannot be changed.	<p>Either one of the FWD and REV terminal commands is turned ON.</p> <ul style="list-style-type: none"> ➔ Turn OFF both FWD and REV.
(6) The target function code(s) does not appear.	<p>When "0. QUICK SET" is selected, only the particular function code(s) appears.</p> <ul style="list-style-type: none"> ➔ Select "10. USER SET" and add the target function code(s) to the set of function codes registered for Quick Setup. After that, select the target function code(s) and change its data. For details, refer to Chapter 3, Table 3.5 "Menus Available in Programming Mode."

6.4 If an Alarm Code Appears on the LED Monitor

[1] *OCn* Instantaneous overcurrent

Problem The inverter momentary output current exceeded the overcurrent level.

- OC1* Overcurrent occurred during acceleration.
- OC2* Overcurrent occurred during deceleration.
- OC3* Overcurrent occurred during running at a constant speed.

Possible Causes	What to Check and Suggested Measures
(1) The inverter output lines were short-circuited.	Disconnect the wiring from the inverter output terminals ([U], [V] and [W]) and measure the interphase resistance of the motor wiring. Check if the resistance is too low. ➔ Remove the short-circuited part (including replacement of the wires, relay terminals and motor).
(2) Ground faults have occurred at the inverter output lines.	Disconnect the wiring from the output terminals ([U], [V] and [W]) and perform a Megger test. ➔ Remove the grounded parts (including replacement of the wires, relay terminals and motor).
(3) Overload.	Measure the motor current with a measuring device to trace the current trend. Then, use this data to judge if the trend is over the calculated load value for your system design. ➔ If the load is too heavy, reduce it or increase the inverter capacity. Trace the current trend and check if there are any sudden changes in the current. ➔ If there are any sudden changes, make the load fluctuation smaller or increase the inverter capacity. ➔ Enable instantaneous overcurrent limiting (H12 = 1).
(4) Excessive torque boost specified. (when F37* = 0, 1, 3, or 4)	Check whether decreasing the torque boost (F09*) decreases the output current but does not stall the motor. ➔ If no stall occurs, decrease the torque boost (F09*).
(5) The acceleration/ deceleration time was too short.	Check that the motor generates enough torque required during acceleration/deceleration. That torque is calculated from the moment of inertia for the load and the acceleration/deceleration time. ➔ Increase the acceleration/deceleration time (F07, F08, E10 through E15, and H56). ➔ Enable the current limiter (F43) and torque limiter (F40, F41, E16, and E17). ➔ Increase the inverter capacity.
(6) Malfunction caused by noise.	Check if noise control measures are appropriate (e.g., correct grounding and routing of control and main circuit wires). ➔ Implement noise control measures. For details, refer to the FRENIC-MEGA User's Manual, "Appendix A." ➔ Enable the Auto-reset (H04). ➔ Connect a surge absorber to magnetic contactor's coils or other solenoids (if any) causing noise.

[2] *EF* Ground fault

Problem A ground fault current flew from the output terminal of the inverter.

Possible Causes	What to Check and Suggested Measures
(1) Inverter output terminal(s) grounded (ground fault).	Disconnect the wiring from the output terminals ([U], [V], and [W]) and perform a Megger test. ➔ Remove the grounded parts (including replacement of the wires, relay terminals and motor).

[3] *OUh* Overvoltage

Problem The DC link bus voltage was over the detection level of overvoltage.

- OU1* Overvoltage occurred during acceleration.
- OU2* Overvoltage occurred during deceleration.
- OU3* Overvoltage occurred during running at constant speed.

Possible Causes	What to Check and Suggested Measures
(1) The power supply voltage exceeded the inverter's specification range.	Measure the input voltage. ➔ Decrease the voltage to within the specified range.

Possible Causes	What to Check and Suggested Measures
(2) A surge current entered the input power supply.	In the same power line, if a phase-advancing capacitor is turned ON/OFF or a thyristor converter is activated, a surge (momentary large increase in the voltage or current) may be caused in the input power. ➔ Install a DC reactor.
(3) The deceleration time was too short for the moment of inertia for load.	Recalculate the deceleration torque based on the moment of inertia for the load and the deceleration time. ➔ Increase the deceleration time (F08, E11, E13, E15, and H56). ➔ Enable the automatic deceleration (anti-regenerative control) (H69), or deceleration characteristics (H71). ➔ Enable torque limiter (F40, F41, E16, E17, and H73). ➔ Set the rated voltage (at base frequency) (F05*) to "0" to improve the braking capability. ➔ Consider the use of a braking resistor.
(4) The acceleration time was too short.	Check if the overvoltage alarm occurs after rapid acceleration. ➔ Increase the acceleration time (F07, E10, E12, and E14). ➔ Select the S-curve pattern (H07). ➔ Consider the use of a braking resistor.
(5) Braking load was too heavy.	Compare the braking torque of the load with that of the inverter. ➔ Set the rated voltage (at base frequency) (F05*) to "0" to improve the braking capability. ➔ Consider the use of a braking resistor.
(6) Malfunction caused by noise.	Check if the DC link bus voltage was below the protective level when the overvoltage alarm occurred. ➔ Implement noise control measures. For details, refer to the FRENIC-MEGA User's Manual, "Appendix A." ➔ Enable the auto-reset (H04). ➔ Connect a surge absorber to magnetic contactor's coils or other solenoids (if any) causing noise.

[4] \lll Undervoltage

Problem DC link bus voltage has dropped below the undervoltage detection level.

Possible Causes	What to Check and Suggested Measures
(1) A momentary power failure occurred.	➔ Release the alarm. ➔ If you want to restart running the motor without treating this condition as an alarm, set F14 to "3," "4," or "5," depending on the load type.
(2) The power to the inverter was switched back to ON too soon (when F14 = 1).	Check if the power to the inverter was switched back to ON while the control power was still alive. (Check whether the LEDs on the keypad light.) ➔ Turn the power ON again after all LEDs on the keypad go off.
(3) The power supply voltage did not reach the inverter's specification range.	Measure the input voltage. ➔ Increase the voltage to within the specified range.
(4) Peripheral equipment for the power circuit malfunctioned, or the connection was incorrect.	Measure the input voltage to find which peripheral equipment malfunctioned or which connection is incorrect. ➔ Replace any faulty peripheral equipment, or correct any incorrect connections.
(5) Any other loads connected to the same power supply has required a large starting current, causing a temporary voltage drop.	Measure the input voltage and check the voltage fluctuation. ➔ Reconsider the power supply system configuration.
(6) Inverter's inrush current caused the power voltage drop because the power supply transformer capacity was insufficient.	Check if the alarm occurs when a molded case circuit breaker (MCCB), residual-current-operated protective device (RCD)/earth leakage circuit breaker (ELCB) (with overcurrent protection) or magnetic contactor (MC) is turned ON. ➔ Reconsider the capacity of the power supply transformer.

[5] *IL* Input phase loss

Problem Input phase loss occurred, or interphase voltage unbalance rate was large.

Possible Causes	What to Check and Suggested Measures
(1) Breaks in wiring to the main power input terminals.	Measure the input voltage. ➔ Repair or replace the main circuit power input wires or input devices (MCCB, MC, etc.).
(2) The screws on the main power input terminals are loosely tightened.	Check if the screws on the main power input terminals have become loose. ➔ Tighten the terminal screws to the recommended torque.
(3) Interphase voltage unbalance between three phases was too large.	Measure the input voltage. ➔ Connect an AC reactor (ACR) to lower the voltage unbalance between input phases. ➔ Increase the inverter capacity.
(4) Overload cyclically occurred.	Measure the ripple wave of the DC link bus voltage. ➔ If the ripple is large, increase the inverter capacity.
(5) Single-phase voltage was input to the three-phase input inverter.	Check the inverter settings and service condition. ➔ Correct them for single-phase use, referring to Chapter 1, Section 1.3.4 "Precautions for use on single-phase input.
(6) Running on single-phase power	➔ Refer to Section 6.7 "If the Inverter is Running on Single-Phase Power," [5].

Note The input phase loss protection can be disabled with the function code H98 (Protection/Maintenance Function).

[6] *OPL* Output phase loss

Problem Output phase loss occurred.

Possible Causes	What to Check and Suggested Measures
(1) Inverter output wires are broken.	Measure the output current. ➔ Replace the output wires.
(2) The motor winding is broken.	Measure the output current. ➔ Replace the motor.
(3) The terminal screws for inverter output were not tight enough.	Check if any screws on the inverter output terminals have become loose. ➔ Tighten the terminal screws to the recommended torque.
(4) A single-phase motor has been connected.	➔ Single-phase motors cannot be used. Note that the FRENIC-MEGA only drives three-phase induction motors.

[7] *OH* Heat sink overheat

Problem Temperature around heat sink has risen abnormally.

Possible Causes	What to Check and Suggested Measures
(1) Temperature around the inverter exceeded the inverter's specification range.	Measure the temperature around the inverter. ➔ Lower the temperature around the inverter (e.g., ventilate the panel where the inverter is mounted).
(2) Ventilation path is blocked.	Check if there is sufficient clearance around the inverter. ➔ Change the mounting place to ensure the clearance.
	Check if the heat sink is not clogged. ➔ Clean the heat sink.

Possible Causes	What to Check and Suggested Measures
(3) Cooling fan's airflow volume decreased due to the service life expired or failure.	Check the cumulative run time of the cooling fan. Refer to Chapter 3, Section 3.4.6 "Reading maintenance information – Menu #5 "Maintenance Information"." ➔ Replace the cooling fan.
	Visually check whether the cooling fan rotates normally. ➔ Replace the cooling fan.
	Inverters of 60 HP or above for three-phase 230 V series and those of 125 HP or above for three-phase 460 V series are equipped with not only a cooling fan for heat sink but also an internal air circulation fan. Check the following. ➔ Check the connection of the fan power switching connectors "CN R" and "CN W." ➔ Correct the connection. (Refer to "Ⓞ Switching connectors" in Chapter 2, Section 2.3.4 "Wiring of main circuit terminals and grounding terminals".
(4) Overload.	Measure the output current. ➔ Reduce the load (e.g. Use the heat sink overheat early warning (E01 through E07) or the overload early warning (E34) and reduce the load before the overload protection is activated.). ➔ Decrease the motor sound (carrier frequency) (F26). ➔ Enable the overload prevention control (H70).
(5) Running on single-phase power	➔ Refer to Section 6.7 "If the Inverter is Running on Single-Phase Power, [1] and [6].

[8] *OH2* External alarm

Problem External alarm was inputted (*THR*).
(when the "Enable external alarm trip" *THR* has been assigned to any of digital input terminals)

Possible Causes	What to Check and Suggested Measures
(1) An alarm function of external equipment was activated.	Check the operation of external equipment. ➔ Remove the cause of the alarm that occurred.
(2) Wrong connection or poor contact in external alarm signal wiring.	Check if the external alarm signal wiring is correctly connected to the terminal to which the "Enable external alarm trip" terminal command <i>THR</i> has been assigned (Any of E01 through E07, E98, and E99 should be set to "9"). ➔ Connect the external alarm signal wire correctly.
(3) Incorrect setting of function code data.	Check whether the "Enable external alarm trip" terminal command <i>THR</i> has been assigned to an unavailable terminal (with E01 through E07, E98, or E99). ➔ Correct the assignment.
	Check whether the normal/negative logic of the external signal matches that of the <i>THR</i> command specified by any of E01 through E07, E98, and E99. ➔ Ensure the matching of the normal/negative logic.

[9] *OH3* Inverter internal overheat

Problem Temperature inside the inverter has exceeded the allowable limit.

Possible Causes	What to Check and Suggested Measures
(1) The surrounding temperature exceeded the inverter's specification limit.	Measure the surrounding temperature. ➔ Lower the temperature around the inverter (e.g., ventilate the panel where the inverter is mounted).
(2) Running on single-phase power	➔ Refer to Section 6.7 "If the Inverter is Running on Single-Phase Power," [6].

[10] *OH* Motor protection (PTC/NTC thermistor)

Problem Temperature of the motor has risen abnormally.

Possible Causes	What to Check and Suggested Measures
(1) The temperature around the motor exceeded the motor's specification range.	Measure the temperature around the motor. → Lower the temperature.
(2) Cooling system for the motor defective.	Check if the cooling system of the motor is operating normally. → Repair or replace the cooling system of the motor.
(3) Overload.	Measure the output current. → Reduce the load (e.g. Use the heat sink overheat early warning (E01 through E07) or the overload early warning (E34) and reduce the load before the overload protection is activated.). (In winter, the load tends to increase.) → Lower the temperature around the motor. → Increase the motor sound (Carrier frequency) (F26).
(4) The activation level (H27) of the PTC thermistor for motor overheat protection was set inadequately.	Check the PTC thermistor specifications and recalculate the detection voltage. → Modify the data of function code H27.
(5) Settings for the PTC/NTC thermistor are improper.	Check the setting of the thermistor mode selection (H26) and the slider position of terminal [C1] property switch SW5. → Change the H26 data in accordance with the thermistor used and set the SW5 to the PTC/NTC position.
(6) Excessive torque boost specified. (F09*)	Check whether decreasing the torque boost (F09*) does not stall the motor. → If no stall occurs, decrease the F09* data.
(7) The V/f pattern did not match the motor.	Check if the base frequency (F04*) and the rated voltage at base frequency (F05*) match the values on the motor's nameplate. → Match the function code data with the values on the motor's nameplate.
(8) Incorrect setting of function code data.	Although no PTC/NTC thermistor is used, the thermistor mode is enabled (H26). → Set the H26 data to "0" (Disable).

[11] *OH* Braking resistor overheated

Problem The electronic thermal protection for the braking resistor has been activated.

Possible Causes	What to Check and Suggested Measures
(1) Braking load is too heavy.	Reconsider the relationship between the braking load estimated and the real load. → Lower the real braking load. → Review the selection of the braking resistor and increase the braking capability (Modification of related function code data (F50, F51, and F52) is also required.)
(2) Specified deceleration time is too short.	Recalculate the deceleration torque and time needed for the load currently applied, based on a moment of inertia for the load and the deceleration time. → Increase the deceleration time (F08, E11, E13, E15, and H56). → Review the selection of the braking resistor and increase the braking capability. (Modification of related function code data (F50, F51, and F52) is also required.)
(3) Incorrect setting of function code data F50, F51, and F52.	Recheck the specifications of the braking resistor. → Review data of function codes F50, F51, and F52, then modify them.

Note: The inverter issues an overheat alarm of the braking resistor by monitoring the magnitude of the braking load, not by measuring its surface temperature.

When the braking resistor is frequently used so as to exceed the settings made by function codes F50, F51, and F52, therefore, the inverter issues an overheat alarm even if the surface temperature of the braking resistor does not rise. To squeeze out full performance of the braking resistor, configure function codes F50, F51, and F52 while actually measuring the surface temperature of the braking resistor.

[12] FUS Fuse blown

Problem The fuse inside the inverter blew.

Possible Causes	What to Check and Suggested Measures
(1) The fuse blew due to short-circuiting inside the inverter.	Check whether there has been any excess surge or noise coming from outside. → Take measures against surges and noise. → Have the inverter repaired.





[13] PBF Charger circuit fault

Problem The magnetic contactor for short-circuiting the charging resistor failed to work.

Possible Causes	What to Check and Suggested Measures
(1) The control power was not supplied to the magnetic contactor intended for short-circuiting the charging resistor.	Check that, in normal connection of the main circuit (not a connection via the DC link bus), the connector (CN R) on the power printed circuit board (power PCB) is not inserted to [NC]. → Insert the connector (CN R) to [FAN]. Check whether you quickly turned the circuit breaker ON and OFF to confirm safety after cabling/wiring. → Wait until the DC link bus voltage has dropped to a sufficiently low level and then release the current alarm. After that, turn ON the power again. (Do not turn the circuit breaker ON and OFF quickly.) (Turning ON the circuit breaker supplies power to the control circuit to the operation level (lighting the LEDs on the keypad) in a short period. Immediately turning it OFF even retains the control circuit power for a time, while it shuts down the power to the magnetic contactor intended for short-circuiting the charging resistor since the contactor is directly powered from the main power. Under such conditions, the control circuit can issue a turn-on command to the magnetic contactor, but the contactor not powered can produce nothing. This state is regarded as abnormal, causing an alarm.)
(2) Running on single-phase power	→ Refer to Section 6.7 "If the Inverter is Running on Single-Phase Power," [4].

[14] OL1 Overload of motor 1 through 4

Problem Electronic thermal protection for motor 1, 2, 3, or 4 activated.

-  Motor 1 overload
-  Motor 2 overload
-  Motor 3 overload
-  Motor 4 overload

Possible Causes	What to Check and Suggested Measures
(1) The electronic thermal characteristics do not match the motor overload characteristics.	Check the motor characteristics. → Reconsider the data of function codes (P99*, F10* and F12*). → Use an external thermal relay.
(2) Activation level for the electronic thermal protection was inadequate.	Check the continuous allowable current of the motor. → Reconsider and change the data of function code F11*.
(3) The specified acceleration/ deceleration time was too short.	Recalculate the acceleration/deceleration torque and time needed for the load, based on the moment of inertia for the load and the acceleration/deceleration time. → Increase the acceleration/ deceleration time (F07, F08, E10 through E15, and H56).
(4) Overload.	Measure the output current. → Reduce the load (e.g. Use the overload early warning (E34) and reduce the load before the overload protection is activated.). (In winter, the load tends to increase.)
(5) Excessive torque boost specified (F09*)	Check whether decreasing the torque boost (F09*) does not stall the motor. → If no stall occurs, decrease the F09* data.

[15] *OLU* Inverter overload

Problem Temperature inside inverter has risen abnormally.

Possible Causes	What to Check and Suggested Measures
(1) Temperature around the inverter exceeded the inverter's specification range.	Measure the temperature around the inverter. → Lower the temperature (e.g., ventilate the panel where the inverter is mounted).
(2) Excessive torque boost specified (F09*)	Check whether decreasing the torque boost (F09*) does not stall the motor. → If no stall occurs, decrease the F09* data.
(3) The specified acceleration/ deceleration time was too short.	Recalculate the acceleration/deceleration torque and time needed for the load, based on the moment of inertia for the load and the acceleration/deceleration time. → Increase the acceleration/deceleration time (F07, F08, E10 through E15, and H56).
(4) Overload.	Measure the output current. → Reduce the load (e.g., Use the overload early warning (E34) and reduce the load before the overload protection is activated.). (In winter, the load tends to increase.). → Decrease the motor sound (Carrier frequency) (F26). → Enable overload prevention control (H70).
(5) Ventilation paths are blocked.	Check if there is sufficient clearance around the inverter. → Change the mounting place to ensure the clearance.
	Check if the heat sink is not clogged. → Clean the heat sink.
(6) Cooling fan's airflow volume decreased due to the service life expired or failure.	Check the cumulative run time of the cooling fan. Refer to Chapter 3, Section 3.4.6 "Reading maintenance information – Menu #5 "Maintenance Information"." → Replace the cooling fan.
	Visually check that the cooling fan rotates normally. → Replace the cooling fan.
(7) The wires to the motor are too long, causing a large leakage current from them.	Measure the leakage current. → Insert an output circuit filter (OFL).
(8) Running on single-phase power	→ Refer to Section 6.7 "If the Inverter is Running on Single-Phase Power," [1] and [6].

[16] *OS* Overspeed

Problem The motor rotates in an excessive speed (Motor speed \geq (F03 data) \times (d32 data, d33 data) \times 1.2)

Possible Causes	What to Check and Suggested Measures
(1) Incorrect setting of function code data.	Check the motor parameter "Number of poles" (P01*). → Specify the P01* data in accordance with the motor to be used.
	Check the maximum frequency setting (F03*). → Specify the F03* data in accordance with the output frequency.
	Check the setting of speed limit function (d32 and d33). → Disable the speed limit function (d32 and d33).
(2) Insufficient gain of the speed controller.	Check whether the actual speed overshoots the commanded one in higher speed operation. → Increase the speed controller gain (d03*.) (Depending on the situations, reconsider the setting of the filter constant or the integral time.)
(3) Noises superimposed on the PG wire.	Check whether appropriate noise control measures have been implemented (e.g., correct grounding and routing of signal wires and main circuit wires). → Implement noise control measures. For details, refer to the FRENIC-MEGA User's Manual, "Appendix A."



[17] E_r PG wire break

Problem The pulse generator (PG) wire has been broken somewhere in the circuit.

Possible Causes	What to Check and Suggested Measures
(1) The wire between the pulse generator (PG) and the option card has been broken.	<p>Check whether the pulse generator (PG) is correctly connected to the option card or any wire is broken.</p> <ul style="list-style-type: none"> ➔ Check whether the PG is connected correctly. Or, tighten up the related terminal screws. ➔ Check whether any joint or connecting part bites the wire sheath. ➔ Replace the wire.
(2) PG related circuit affected by strong electrical noise.	<p>Check if appropriate noise control measures have been implemented (e.g., correct grounding and routing of signal wires, communication cables, and main circuit wires).</p> <ul style="list-style-type: none"> ➔ Implement noise control measures. ➔ Separate the signal wires from the main power wires as far as possible.

[18] E_r / Memory error

Problem Error occurred in writing the data to the memory in the inverter.

Possible Causes	What to Check and Suggested Measures
(1) When writing data (especially initializing or copying data), the inverter was shut down so that the voltage to the control PCB has dropped.	<p>Initialize the function code data with H03 (= 1). After initialization, check if pressing the  key releases the alarm.</p> <ul style="list-style-type: none"> ➔ Revert the initialized function code data to their previous settings, then restart the operation.
(2) Inverter affected by strong electrical noise when writing data (especially initializing or copying data).	<p>Check if appropriate noise control measures have been implemented (e.g., correct grounding and routing of control and main circuit wires). Also, perform the same check as described in (1) above.</p> <ul style="list-style-type: none"> ➔ Implement noise control measures. Revert the initialized function code data to their previous settings, then restart the operation.
(3) The control PCB failed.	<p>Initialize the function code data by setting H03 to "1," then reset the alarm by pressing the  key and check that the alarm goes on.</p> <ul style="list-style-type: none"> ➔ The control PCB (on which the CPU is mounted) is defective. Contact your Fuji Electric representative.

[19] E_r Keypad communications error

Problem A communications error occurred between the remote keypad or the multi-function keypad and the inverter.

Possible Causes	What to Check and Suggested Measures
(1) Broken communications cable or poor contact.	<p>Check continuity of the cable, contacts and connections.</p> <ul style="list-style-type: none"> ➔ Re-insert the connector firmly. ➔ Replace the cable.
(2) Connecting many control wires hinders the front cover from being mounted, lifting the keypad.	<p>Check the mounting condition of the front cover.</p> <ul style="list-style-type: none"> ➔ Use wires of the recommended size AWG 19 or 18 (0.65 to 0.82 mm²) for wiring. ➔ Change the wiring layout inside the unit so that the front cover can be mounted firmly.
(3) Inverter affected by strong electrical noise.	<p>Check if appropriate noise control measures have been implemented (e.g., correct grounding and routing of communication cables and main circuit wires).</p> <ul style="list-style-type: none"> ➔ Implement noise control measures. <p>For details, refer to the FRENIC-MEGA User's Manual, "Appendix A."</p>
(4) A keypad failure occurred.	<p>Replace the keypad with another one and check whether a keypad communications error (E_r) occurs.</p> <ul style="list-style-type: none"> ➔ Replace the keypad.

[20] E-3 CPU error

Problem A CPU error (e.g. erratic CPU operation) occurred.

Possible Causes	What to Check and Suggested Measures
(1) Inverter affected by strong electrical noise.	Check if appropriate noise control measures have been implemented (e.g. correct grounding and routing of signal wires, communications cables, and main circuit wires). ➔ Implement noise control measures.

[21] E-4 Option communications error

Problem A communications error occurred between the option card and the inverter.



Possible Causes	What to Check and Suggested Measures
(1) There was a problem with the connection between the option card and the inverter.	Check whether the connector on the option card is properly engaged with that of the inverter. ➔ Reload the option card into the inverter.
(2) Strong electrical noise.	Check whether appropriate noise control measures have been implemented (e.g. correct grounding and routing of signal wires, communications cables, and main circuit wires). ➔ Implement noise control measures.

[22] E-5 Option error

An error detected by the option card. Refer to the instruction manual of the option card for details.

[23] E-6 Operation protection

Problem An incorrect operation was attempted.

Possible Causes	What to Check and Suggested Measures
(1) The  key was pressed when H96 = 1 or 3.	Check that the  key was pressed when a run command had been entered from the input terminal or through the communications port. ➔ If this was not intended, check the setting of H96.
(2) The start check function was activated when H96 = 2 or 3.	Check that any of the following operations has been performed with a run command being entered. - Turning the power ON - Releasing the alarm - Switching the enable communications link LE operation ➔ Review the running sequence to avoid input of a Run command when this error occurs. If this was not intended, check the setting of H96. (Turn the run command OFF before releasing the alarm.)
(3) The forced stop digital input STOP was turned OFF.	Check that turning the STOP OFF decelerated the inverter to stop. ➔ If this was not intended, check the settings of E01 through E07 for terminals [X1] through [X7].

[24] E-7 Tuning error

Problem Auto-tuning failed.

Possible Causes	What to Check and Suggested Measures
(1) A phase was missing (There was a phase loss) in the connection between the inverter and the motor.	➔ Properly connect the motor to the inverter.
(2) V/f or the rated current of the motor was not properly set.	Check whether the data of function codes (F04*, F05*, H50 through H53, H65, H66, P02*, and P03*) matches the motor specifications.
(3) The wiring length between the inverter and the motor was too long.	Check whether the wiring length between the inverter and the motor exceeds 164 ft (50 m). (Small capacity inverters are greatly affected by the wiring length.) ➔ Review, and if necessary, change the layout of the inverter and the motor to shorten the connection wire. Alternatively, minimize the wiring length without changing the layout. ➔ Disable both auto-tuning and auto-torque boost (set data of F37* to "1").
(4) The rated capacity of the motor was significantly different from that of the inverter.	Check whether the rated capacity of the motor is three or more ranks lower, or two or more ranks higher than that of the inverter. ➔ Replace the inverter with one with an appropriate capacity. ➔ Manually specify the values for the motor parameters P06*, P07*, and P08*. ➔ Disable both auto-tuning and auto-torque boost (set data of F37* to "1").
(5) The motor was a special type such as a high-speed motor.	➔ Disable both auto-tuning and auto-torque boost (set data of F37* to "1").
(6) A tuning operation involving motor rotation (P04* = 2 or 3) was attempted while the brake was applied to the motor.	➔ Specify the tuning that does not involve the motor rotation (P04* = 1). ➔ Release the brake before tuning that involves the motor rotation (P04* = 2 or 3).

📖 For details of tuning errors, refer to Chapter 4, Section 4.1.7 "Function code basic settings and tuning < 2 >, ■ Tuning errors."

**[25] E-8 RS-485 communications error (COM port 1)
E-9 RS-485 communications error (COM port 2)**

Problem A communications error occurred during RS-485 communications.

Possible Causes	What to Check and Suggested Measures
(1) Communications conditions of the inverter do not match that of the host equipment.	Compare the settings of the y codes (y01 to y10, y11 to y20) with those of the host equipment. ➔ Correct any settings that differ.
(2) Even though no-response error detection time (y08, y18) has been set, communications is not performed within the specified cycle.	Check the host equipment. ➔ Change the settings of host equipment software or disable the no-response error detection (y08, y18 = 0).
(3) The host equipment did not operate due to defective software, settings, or defective hardware.	Check the host equipment (e.g., PLCs and computers). ➔ Remove the cause of the equipment error.
(4) The RS-485 converter did not operate due to incorrect connections and settings, or defective hardware.	Check the RS-485 converter (e.g., check for poor contact). ➔ Change the various RS-485 converter settings, reconnect the wires, or replace hardware with recommended devices as appropriate.
(5) Broken communications cable or poor contact.	Check the continuity of the cables, contacts and connections. ➔ Replace the cable.

Possible Causes	What to Check and Suggested Measures
(6) Inverter affected by strong electrical noise.	Check if appropriate noise control measures have been implemented (e.g., correct grounding and routing of communications cables and main circuit wires). → Implement noise control measures. → Implement noise reduction measures on the host side. → Replace the RS-485 converter with a recommended insulated one.
(7) Terminating resistor not properly configured.	Check that the inverter serves as a terminating device in the network. → Configure the terminating resistor switch(es) (SW2/SW3) for RS-485 communication correctly. (That is, turn the switch(es) to ON.)

[26] $\overline{E-F}$ Data saving error during undervoltage

Problem The inverter failed to save data such as the frequency commands and PID commands (which are specified through the keypad), or the output frequencies modified by the **UP/DOWN** terminal commands when the power was turned OFF.

Possible Causes	What to Check and Suggested Measures
(1) During data saving performed when the power was turned OFF, the voltage fed to the control PCB dropped in an abnormally short period due to the rapid discharge of the DC link bus.	Check how long it takes for the DC link bus voltage to drop to the preset voltage when the power is turned OFF. → Remove whatever is causing the rapid discharge of the DC link bus voltage. After pressing the RESET key and releasing the alarm, return the data of the relevant function codes (such as the frequency commands and PID commands (specified through the keypad) or the output frequencies modified by the UP/DOWN terminal commands) back to the original values and then restart the operation.
(2) Inverter operation affected by strong electrical noise when the power was turned OFF.	Check if appropriate noise control measures have been implemented (e.g., correct grounding and routing of control and main circuit wires). → Implement noise control measures. After pressing the RESET key and releasing the alarm, return the data of the relevant function codes (such as the frequency commands and PID commands (specified through the keypad) or the output frequencies modified by the UP/DOWN terminal commands) back to the original values and then restart the operation.
(3) The control circuit failed.	Check if $\overline{E-F}$ occurs each time the power is turned ON. → The control PCB (on which the CPU is mounted) is defective. Contact your Fuji Electric representative.

[27] $\overline{E-H}$ Hardware error

Problem The LSI on the power printed circuit board malfunctions.

Possible Causes	What to Check and Suggested Measures
(1) The inverter capacity setting on the control printed circuit board is wrong.	It is necessary to set the inverter capacity correctly. → Contact your Fuji Electric representative.
(2) Data stored in the power printed circuit board memory is corrupted.	It is necessary to replace the power printed circuit board. → Contact your Fuji Electric representative.
(3) The control printed circuit board is misconnected to the power printed circuit board.	It is necessary to replace the power or control printed circuit board. → Contact your Fuji Electric representative.

[28] $\overline{E-E}$ Speed mismatch or excessive speed deviation

Problem An excessive deviation appears between the speed command and the detected speed.

Possible Causes	What to Check and Suggested Measures
(1) Incorrect setting of function code data.	Check the following function code data; P01* (Motor (No. of poles)), d15 (Feedback encoder pulse count/rev), and d16 and d17 (Feedback pulse correction factor 1 and 2). → Specify data of function codes P01*, d15, d16, and d17 in accordance with the motor and PG.
(2) Overload.	Measure the inverter output current. → Reduce the load. Check whether any mechanical brake is working. → Release the mechanical brake.

Possible Causes	What to Check and Suggested Measures
(3) The motor speed does not rise due to the current limiter operation.	Check the data of function code F44 (Current limiter (Level)). ➔ Change the F44 data correctly. Or, set the F43 data to "0" (Disable) if the current limiter operation is not needed.
	Check the data of function codes F04*, F05*, and P01* through P12* to ensure that the V/f pattern setting is right. ➔ Match the V/f pattern setting with the motor ratings. ➔ Change the function code data in accordance with the motor parameters.
(4) Function code settings do not match the motor characteristics.	Check whether the data of P01*, P02*, P03*, P06*, P07*, P08*, P09*, P10* and P12* match the parameters of the motor. ➔ Perform auto-tuning of the inverter, using the function code P04*.
(5) Wrong wiring between the pulse generator (PG) and the inverter.	Check the wiring between the PG and the inverter. ➔ Correct the wiring.
	Check that the relationships between the PG feedback signal and the run command are as follows: • For the FWD command: the B phase pulse is in the High level at rising edge of the A phase pulse • For the REV command: the B phase pulse is in the Low level at rising edge of the A phase pulse ➔ If the relationship is wrong, interchange the A and B phase wires.
(6) Wiring to the motor is incorrect.	Check the wiring to the motor. ➔ Connect the inverter output terminals U, V, and W to the motor input terminals U, V, and W, respectively.
(7) The motor speed does not rise due to the torque limiter operation.	Check the data of F40 (Torque limiter 1-1). ➔ Correct the F40 data. Or, set the F40 data to "999" (Disable) if the torque limiter operation is not needed.



[29] *nrb* NTC wire break error

Problem A wire break is found in the NTC thermistor detection circuit.

Possible Causes	What to Check and Suggested Measures
(1) The NTC thermistor cable is broken.	Check whether the motor cable is broken. ➔ Replace the motor cable.
(2) The temperature around the motor is extremely low (lower than -30°C (-22°F)).	Measure the temperature around the motor. ➔ Reconsider the use environment of the motor.
(3) The NTC thermistor is broken.	Measure the resistance of the NTC thermistor. ➔ Replace the motor.

[30] *E-r-* Mock alarm

Problem The LED displays the alarm *E-r-*.

Possible Causes	What to Check and Suggested Measures
(1) The  +  keys were held down for more than 5 seconds.	➔ To escape from this alarm state, press the  key.

[31] \overline{COP} PID feedback wire break

Problem The PID feedback wire is broken.

Possible Causes	What to Check and Suggested Measures
(1) The PID feedback signal wire is broken.	Check whether the PID feedback signal wires are connected correctly. → Check whether the PID feedback signal wires are connected correctly. Or, tighten up the related terminal screws. → Check whether any contact part bites the wire sheath.
(2) PID feedback related circuit affected by strong electrical noise.	Check if appropriate noise control measures have been implemented (e.g., correct grounding and routing of signal wires, communication cables, and main circuit wires). → Implement noise control measures. → Separate the signal wires from the main power wires as far as possible.

[32] \overline{dbr} Braking transistor error

Problem A braking transistor error is detected.

Possible Causes	What to Check and Suggested Measures
(1) The braking transistor is broken.	Check whether resistance of the braking resistor is correct or there is a misconnection of the resistor. → Consult your Fuji Electric representative for repair.

[33] \overline{Erd} Positioning control error (Servo-lock)

Problem An excessive positioning deviation has occurred when the servo-lock function was activated.

Possible Causes	What to Check and Suggested Measures
(1) Insufficient gain in positioning control system.	Readjust the settings of J97 (Servo-lock (Gain)) and d03 (Speed control 1 P (Gain)).
(2) Incorrect control completion width.	Check whether the setting of J99 (Servo-lock (Completion width)) is correct. → Correct the setting of J99.

[34] \overline{Erd} Positioning control error (Synchronous control)

Problem An excessive positioning deviation has occurred when the synchronous control function was activated.
 For details, refer to the instruction manual of the PG interface card.

Possible Causes	What to Check and Suggested Measures
(1) Insufficient gain in positioning control system.	Readjust the settings of d72 (Synchronous Control Parameters (APR P gain)) and d03 (Speed control 1 P (Gain)).
(2) Incorrect control completion width.	Check whether the setting of d78 (Synchronous Control Parameters (Over-deviation detection width)) is correct. → Correct the setting of d78.

[35] \overline{EEF} Enable circuit failure

Problem The circuit that detects the status of the enable circuit is broken.

Possible Causes	What to Check and Suggested Measures
(1) Circuit related to the Enable circuit affected by strong electrical noise.	Check if appropriate noise control measures have been implemented (e.g., correct grounding and routing of signal wires, communication cables, and main circuit wires). → Implement noise control measures. → Separate the signal wires from the main power wires as far as possible.

Note The "Reset alarm" terminal command **RST** cannot reset this alarm \overline{EEF} . If even a power-off reset cannot restore the inverter state, the inverter needs to be repaired.

6.5 If the "Light Alarm" Indication ($\angle -F_L$) Appears on the LED Monitor

If the inverter detects a minor abnormal state "light alarm," it can continue the current operation without tripping while displaying the "light alarm" indication $\angle -F_L$ on the LED monitor. In addition to the indication $\angle -F_L$, the inverter displays the "L-ALARM" (blinking) on the LCD monitor and outputs the "light alarm" signal **L-ALM** to a digital output terminal to alert the peripheral equipment to the occurrence of a light alarm. (To use the **L-ALM**, it is necessary to assign the signal to any of the digital output terminals by setting any of function codes E20 through E24 and E27 to "98.")

Function codes H81 and H82 specify which alarms should be categorized as "light alarm." The available "light alarm" codes are check-marked in the "Light alarm" object column in Table 6.1.

To display the "light alarm" and escape from the light alarm state, follow the instructions below.

■ Displaying the light alarm

- 1) Press the PROG key to enter Programming mode.
- 2) Shift to Menu #5 "5: MAINTENANC," scroll to Page 11, and check the "LALM1" (Light alarm (Latest)). The light alarm is displayed in alarm codes. For details about those codes, see Table 6.1 "Abnormal States Detectable ("Alarm" and "Light Alarm" Objects)."

 For details about the menu transition in Menu #5 "Maintenance Information", see Chapter 3, Section 3.4.6 "Reading maintenance information – Menu #5 "Maintenance Information." It is also possible to display the factors of other three light alarms--"LALM2" (Light alarm (Last)) to "LALM4" (Light alarm (3rd)).

■ Switching the LED monitor from the light alarm to normal display

If it is necessary to return the LED monitor to the normal display state (showing the running status such as reference frequency) before the light alarm is removed (e.g., when it takes a long time to remove the light alarm), follow the steps below.

- 1) Press the RESET key to return the LED monitor to the light alarm indication ($\angle -F_L$).
- 2) With $\angle -F_L$ being displayed, press the FUNC/DATA key. The LED monitor returns to the normal display state, but the "L-ALARM" on the LCD monitor continues blinking.

■ Releasing the light alarm



- 1) First remove the "LALM1" (Light alarm (Latest)) under Menu #5, in accordance with the troubleshooting procedure. The reference page for the troubleshooting corresponding to each light alarm is shown in "Ref. page" column in Table 6.1.
- 2) To return the LED monitor from the $\angle -F_L$ display to the normal display state (showing the running status such as reference frequency), press the FUNC/DATA key in Running mode.

If the light alarm(s) has been successfully removed in step 1) above, the "L-ALARM" blinking on the LCD monitor disappears and the digital output **L-ALM** also goes OFF. (If any light alarm persists, e.g., detecting a DC fan lock, the "L-ALARM" continues blinking and the **L-ALM** remains ON.)



6.6 If an Abnormal Pattern Appears on the LED Monitor except Alarm Codes and "Light Alarm" Indication (L -FL)

[1] ---- (center bar) appears

Problem A center bar (----) appeared on the LED monitor.

Possible Causes	What to Check and Suggested Measures
(1) When PID control had been disabled (J01 = 0), you changed E43 (LED Monitor (Item selection)) to 10 or 12. With the PID being enabled (J01 = 1, 2, or 3), you disabled PID control (J01 = 0) when the LED monitor had been set to display the PID command or PID feedback amount by pressing the  key.	Make sure that when you wish to view other monitor items, E43 is not set to "10: PID command" or "12: PID feedback amount." → Set E43 to a value other than "10" or "12." Make sure that when you wish to view a PID command or a PID feedback amount, J01 (PID control) is not set to "0: Disable." → Set J01 to "1: Enable (Process control normal operation)," "2: Enable (Process control inverse operation)," or "3: Enable (Dancer control)."
(2) The keypad was poorly connected.	Prior to proceed, check that pressing the  key does not change the display on the LED monitor. Check continuity of the extension cable for the keypad used in remote operation. → Replace the cable.

[2] _ _ _ _ (under bar) appears

Problem Although you pressed the  /  key or entered a run forward command **FWD** or a run reverse command **REV**, the motor did not start and an under bar (_ _ _ _) appeared on the LED monitor.

Possible Causes	What to Check and Suggested Measures
(1) The voltage of the DC link bus was low.	Select  / under Menu #5 "Maintenance Information" in Programming mode on the keypad, then check the DC link bus voltage which should be 200 VDC or below for three-phase 230 V series, and 400 VDC or below for three-phase 460 V series. → Connect the inverter to a power supply that meets its input specifications.
(2) The main power is not ON, while the auxiliary input power to the control circuit is supplied.	Check whether the main power is turned ON. → Turn the main power ON.
(3) Although power is supplied not via the commercial power line but via the DC link bus, the main power down detection is enabled (H72 = 1).	Check the connection to the main power and check if the H72 data is set to "1" (factory default). → Correct the H72 data.
(4) Inverter running on single-phase power	→ Refer to Section 6.7 "If the Inverter is Running on Single-Phase Power, " [2].

[3] () appears

Problem Parentheses () appeared on the LED monitor during speed monitoring on the keypad.

Possible Causes	What to Check and Suggested Measures
(1) The display data overflows the LED monitor.	Check whether the output frequency multiplied by the display coefficient (E50) is 1,000,000 or more. → Correct the E50 data.

6.7 If the Inverter is Running on Single-Phase Power

[1] The AC fan(s) does not work. (230 V series with 60 HP or above or 460 V series with 125 HP or above)

Possible Causes	Suggested Measures
The power supply is connected to the main circuit power input terminal L2.	Connect the power supply to L1 and L3.

[2] (under bar) appears

Possible Causes	Suggested Measures
The power supply is connected to the main circuit power input terminal L2 and the main power down detection is activated.	Connect the power supply to L1 and L3.

[3] The motor does not run as expected.

Possible Causes	Suggested Measures
Large voltage ripple inside the inverter due to single-phase power	When the inverter runs on single-phase power, the voltage ripple becomes larger than that on three-phase power so that an operation error span becomes wider, causing lower performance than expected. To improve the accuracy in operation, use the inverter on three-phase power.

[4] Charger circuit fault (230 V series with 60 HP or above or 460 V series with 125 HP or above)

Possible Causes	Suggested Measures
The power supply is connected to the main circuit power input terminal L2.	Connect the power supply to L1 and L3.

[5] Input phase loss

Possible Causes	Suggested Measures
The input phase loss protection is activated.	Disable the input phase loss protection by switching Bit 1 of H98 to "0." When switching from the factory default of H98, modify the H98 data from 82 to 81 in decimal.

[6] Heat sink overheating, Inverter internal overheating, or Inverter overload

Possible Causes	Suggested Measures
The inverter was running with load exceeding the single-phase rating.	To run the inverter on single-phase power, it is necessary to derate the output to the lower level than that on three-phase power. Review the load conditions to run the inverter within the single-phase rating, or increase the inverter capacity.

Chapter 7 MAINTENANCE AND INSPECTION

Perform daily and periodic inspections to avoid trouble and keep the reliability of the inverter at its maximum. When performing inspections, follow the instructions given in this chapter.

⚠️ WARNING ⚠️

- Before proceeding to the maintenance/inspection jobs, **turn OFF the power and wait at least five minutes for inverters of 40 HP or below, or at least ten minutes for inverters of 50 HP or above.** Make sure that the LED monitor and charging lamp are turned OFF. Further, make sure, using a multimeter or a similar instrument, that the DC link bus voltage between the terminals P(+) and N(-) has dropped to the safe level (+25 VDC or below).

Electric shock may occur.

- Maintenance, inspection, and parts replacement should be made only by authorized persons.
- Take off the watch, rings and other metallic objects before starting work.
- Use insulated tools.
- Never modify the inverter.

Electric shock or injuries could occur.

7.1 Daily Inspection

Visually inspect the inverter for operation errors from the outside without removing the covers when the inverter is ON or operating.

- Check that the expected performance (satisfying the standard specification) is obtained.
- Check that the surrounding environment satisfies the requirements given in Chapter 2, Section 2.1 "Operating Environment."
- Check that the LED monitor and LCD monitor on the keypad display normally.
- Check for abnormal noise, odor, or excessive vibration.
- Check for traces of overheat, discoloration and other defects.

7.2 Periodic Inspection

Perform periodic inspections according to the items listed in Table 7.1. Before performing periodic inspections, be sure to stop the motor and remove the front cover with the inverter power OFF.

Table 7.1 List of Periodic Inspections

Check part	Check item	How to inspect	Evaluation criteria
Environment	1) Check the surrounding temperature, humidity, vibration and atmosphere (dust, gas, oil mist, or water drops). 2) Check that tools or other foreign materials or dangerous objects are not left around the equipment.	1) Check visually or measure using apparatus. 2) Visual inspection	1) The standard specifications must be satisfied. 2) No foreign or dangerous objects are left.
Input voltage	Check that the input voltages of the main and control circuit are correct.	Measure the input voltages using a multimeter or the like.	The standard specifications must be satisfied.
Keypad	1) Check that the display is clear. 2) Check that there is no missing part in the displayed characters.	1), 2) Visual inspection	1), 2) The display can be read and there is no fault.
Structure such as frame and cover	Check for: 1) Abnormal noise or excessive vibration 2) Loose bolts (at clamp sections). 3) Deformation and breakage 4) Discoloration caused by overheat 5) Contamination and accumulation of dust or dirt	1) Visual or auditory inspection 2) Retighten. 3), 4), 5) Visual inspection	1), 2), 3), 4), 5) No abnormalities

Table 7.1 List of Periodic Inspections (Continued)

Check part	Check item	How to inspect	Evaluation criteria	
Main circuit	Common	1) Check that bolts and screws are tight and not missing. 2) Check the devices and insulators for deformation, cracks, breakage and discoloration caused by overheat or deterioration. 3) Check for contamination or accumulation of dust or dirt.	1) Retighten. 2), 3) Visual inspection	1), 2), 3) No abnormalities
	Conductors and wires	1) Check conductors for discoloration and distortion caused by overheat. 2) Check the sheath of the wires for cracks and discoloration.	1), 2) Visual inspection	1), 2) No abnormalities
	Terminal blocks	Check that the terminal blocks are not damaged.	Visual inspection	No abnormalities
	Braking resistor	1) Check for abnormal odor or cracks in insulators caused by overheat. 2) Check for wire breakage.	1) Olfactory and visual inspection 2) Check the wires visually, or disconnect either wire and measure the conductivity with a multimeter.	1) No abnormalities 2) Within $\pm 10\%$ of the resistance of the braking resistor
	DC link bus capacitor	1) Check for electrolyte leakage, discoloration, cracks and swelling of the casing. 2) Check that the safety valve does not protrude remarkably. 3) Measure the capacitance if necessary.	1), 2) Visual inspection 3) Measure the discharge time with capacitance probe.	1), 2) No abnormalities 3) The discharge time should not be shorter than the one specified by the replacement manual.
	Transformer and reactor	Check for abnormal roaring noise and odor.	Auditory, visual, and olfactory inspection	No abnormalities
	Magnetic contactor and relay	1) Check for chatters during operation. 2) Check that contact surface is not rough.	1) Auditory inspection 2) Visual inspection	1), 2) No abnormalities
Control circuit	Printed circuit board	1) Check for loose screws and connectors. 2) Check for odor and discoloration. 3) Check for cracks, breakage, deformation and remarkable rust. 4) Check the capacitors for electrolyte leaks and deformation.	1) Retighten. 2) Olfactory and visual inspection 3), 4) Visual inspection	1), 2), 3), 4) No abnormalities
Cooling system	Cooling fan	1) Check for abnormal noise and excessive vibration. 2) Check for loose bolts. 3) Check for discoloration caused by overheat.	1) Auditory and visual inspection, or turn manually (be sure to turn the power OFF). 2) Retighten. 3) Visual inspection	1) Smooth rotation 2), 3) No abnormalities
	Ventilation path	Check the heat sink, intake and exhaust ports for clogging and foreign materials.	Visual inspection	No abnormalities

Remove dust accumulating on the inverter with a vacuum cleaner. If the inverter is stained, wipe it off with a chemically neutral cloth.

7.3 List of Periodic Replacement Parts

Each part of the inverter has its own service life that will vary according to the environmental and operating conditions. It is recommended that the following parts be replaced at the specified intervals.

When the replacement is necessary, consult your Fuji Electric representative.

Table 7.2 Replacement Parts

Part name	Standard replacement intervals (See Note below.)
DC link bus capacitor	10 years
Electrolytic capacitors on printed circuit boards	10 years
Cooling fans	10 years
Fuse	10 years (for inverters of 150 HP or above)

(Note) These replacement intervals are based on the inverter's service life estimated at a surrounding temperature of 40°C (104°F) at 80% (LD/MD-mode inverters) or 100% (HD-mode inverters) of full load. In environments with a surrounding temperature above 40°C (104°F) or a large amount of dust or dirt, the replacement intervals may be shorter.

Standard replacement intervals mentioned above are only a guide for replacement, not a guaranteed service life.

7.3.1 Judgment on service life

The inverter has the life prediction function for some parts which measures the discharging time or counts the voltage applied time, etc. The function allows you to monitor the current lifetime state on the LCD monitor and judge whether those parts are approaching the end of their service life.

The life prediction function can also issue early warning signals if the life time alarm command **LIFE** is assigned to any of the digital output terminals. (Refer to "[3] Early warning of lifetime alarm" later in this section.)

Table 7.3 lists the parts whose service life can be predicted and details the life prediction function. The predicted values should be used only as a guide since the actual service life is influenced by the surrounding temperature and other usage environments.

Table 7.3 Life Prediction

Object of life prediction	Prediction function	End-of-life criteria	Prediction timing	On the LCD monitor
DC link bus capacitor	<u>Measurement of discharging time</u> Measures the discharging time of the DC link bus capacitor when the main power is shut down and calculates the capacitance.	85% or lower of the initial capacitance at shipment (See "[1] Measuring the capacitance of DC link bus capacitor in comparison with initial one at shipment" on the next page.)	At periodic inspection (H98: Bit 3 = 0)	Menu #5 "5: MAINTENANC" ↓ Page 2, "CAP"
		85% or lower of the reference capacitance under ordinary operating conditions at the user site (See "[2] Measuring the capacitance of DC link bus capacitor under ordinary operating conditions" on page 7-5.)	During ordinary operation (H98: Bit 3 = 1)	Menu #5 "5: MAINTENANC" ↓ Page 2, "CAP"
	<u>ON-time counting</u> Counts the time elapsed when the voltage is applied to the DC link bus capacitor, while correcting it according to the capacitance measured above.	Exceeding 87,600 hours (10 years)	During ordinary operation	Menu #5 "5: MAINTENANC" ↓ Page 8, "CAPEH" and "CAPRH"
Electrolytic capacitors on printed circuit boards	Counts the time elapsed when the voltage is applied to the capacitors, while correcting it according to the surrounding temperature.	Exceeding 87,600 hours (10 years)	During ordinary operation	Menu #5 "5: MAINTENANC" ↓ Page 3, "TCAP"
Cooling fans	Counts the run time of the cooling fans.	Exceeding 87,600 hours (10 years)	During ordinary operation	Menu #5 "5: MAINTENANC" ↓ Page 3, "TFAN"

■ Notes for the judgment on the service life of the DC link bus capacitor

The service life of the DC link bus capacitor can be judged by the "measurement of discharging time" or "ON-time counting."

Measurement of discharging time

- The discharging time of the DC link bus capacitor depends largely on the inverter's internal load conditions, e.g. options attached or ON/OFF of digital I/O signals. If actual load conditions are so different from the ones at which the initial/reference capacitance is measured that the measurement result falls out of the accuracy level required, then the inverter does not perform measuring.
- The capacitance measuring conditions at shipment are extremely restricted, e.g., all input terminals being OFF, in order to stabilize the load and measure the capacitance accurately. Those conditions are, therefore, different from the actual operating conditions in almost all cases. If the actual operating conditions are the same as those at shipment, shutting down the inverter power automatically measures the discharging time; however, if they are different, no automatic measurement is performed. To perform it, put those conditions back to the factory default ones and shut down the inverter. For the measuring procedure, see [1] given below.
- To measure the capacitance of the DC link bus capacitor *under ordinary operating conditions* when the power is turned OFF, it is necessary to set up the load conditions for ordinary operation and measure the reference capacitance (initial setting) when the inverter is introduced. For the reference capacitance setup procedure, see [2] given on the next page. Performing the setup procedure automatically detects and saves the measuring conditions of the DC link bus capacitor.

Setting bit 3 of H98 data to 0 restores the inverter to the measurement in comparison with the initial capacitance measured at shipment.

Note When the inverter uses an auxiliary control power input, the load conditions widely differ so that the discharging time cannot be accurately measured. To prevent unintended measuring, the discharging time measurement can be disabled with the function code H98 (Bit 4 = 0).

ON-time counting

- In a machinery system where the inverter main power is rarely shut down, the inverter cannot measure the discharging time. For such a case, ON-time counting is provided. The ON-time counting result can be represented as "elapsed hours" (Menu #5 "5. MAINTENANC," Page 8, CAPEH) and "remaining hours" (Menu #5 "5. MAINTENANC," Page 8, CAPRH) as shown in Table 7.3, "On the LCD monitor."

[1] Measuring the capacitance of DC link bus capacitor in comparison with initial one at shipment

When bit 3 of H98 data is 0, the measuring procedure given below measures the capacitance of DC link bus capacitor in comparison with initial one at shipment when the power is turned OFF. The measuring result can be displayed on the keypad as a ratio (%) to the initial capacitance.

----- Capacitance measuring procedure -----

- 1) To ensure validity in the comparative measurement, put the condition of the inverter back to the state at factory shipment.
 - If the original keypad has been replaced with an optional remote keypad (equipped with a USB port), replace the remote one with the original one.
 - Remove the option card (if already in use) from the inverter.
 - In case another inverter is connected via the DC link bus to the P(+) and N(-) terminals of the main circuit, disconnect the wires. (You do not need to disconnect a DC reactor (optional), if any.)
 - Disconnect power wires for the auxiliary input to the control circuit (R0, T0).
 - Mount the remote keypad on the inverter.
 - Turn OFF all the digital input signals fed to terminals [FWD], [REV], and [X1] through [X7] of the control circuit.
 - If an external frequency command potentiometer is connected to terminal [13], disconnect it.
 - If an external apparatus is attached to terminal [PLC], disconnect it.
 - Ensure that transistor output signals ([Y1] to [Y4]) and relay output signals ([Y5A] - [Y5C], and [30A/B/C]) will not be turned ON.
 - Disable the RS-485 communications link.

Tip It is recommended that terminal [EN] be short-circuited for the measurement of the capacitance.

Note If negative logic is specified for the transistor output and relay output signals, they are considered ON when the inverter is not running. Specify positive logic for them.

 - Keep the surrounding temperature within $25 \pm 10^{\circ}\text{C}$ ($77 \pm 50^{\circ}\text{F}$).
- 2) Turn ON the main circuit power.
- 3) Confirm that the cooling fan is rotating and the inverter is in stopped state.
- 4) Turn OFF the main circuit power.

- 5) The inverter automatically starts the measurement of the capacitance of the DC link bus capacitor. Make sure that ". . . ." appears on the LED monitor.

Note If ". . . ." does not appear on the LED monitor, the measurement has not started. Check the conditions listed in 1).

- 6) After ". . . ." has disappeared from the LED monitor, turn ON the main circuit power again.
 - 7) Shift to Menu #5 "5: MAINTENANC" in Programming mode, scroll to Page 2, and check the "CAP" value (Capacitance of the DC link bus capacitor).
-

[2] Measuring the capacitance of the DC link bus capacitor under ordinary operating conditions

When bit 3 of H98 data is 1, the inverter automatically measures the capacitance of the DC link bus capacitor under ordinary operating conditions when the power is turned OFF. This measurement requires setting up the load conditions for ordinary operation and measuring the reference capacitance when the inverter is introduced to the practical operation, using the setup procedure given below.

----- Reference capacitance setup procedure -----

- 1) Set function code H98 (Protection/maintenance function) to enable the user to specify the judgment criteria for the service life of the DC link bus capacitor (Bit 3 = 1) (refer to function code H98).
- 2) Turn OFF all run commands.
- 3) Make the inverter ready to be turned OFF under ordinary operating conditions.
- 4) Set both function codes H42 (Capacitance of DC link bus capacitor) and H47 (Initial capacitance of DC link bus capacitor) to "0."
- 5) Turn OFF the inverter, and the following operations are automatically performed.

The inverter measures the discharging time of the DC link bus capacitor and saves the result in function code H47 (Initial capacitance of DC link bus capacitor).

The conditions under which the measurement has been conducted will be automatically collected and saved.

During the measurement, ". . . ." will appear on the LED monitor.

- 6) Turn ON the inverter again.

Confirm that H42 (Capacitance of DC link bus capacitor) and H47 (Initial capacitance of DC link bus capacitor) hold right values. Shift to Menu #5 "5: MAINTENANC" in Programming mode, scroll to Page 2, and confirm that the "CAP" value (ratio to full capacitance) is 100%.

Note If the measurement has failed, "1" is entered into both H42 and H47. Remove the factor of the failure and conduct the measurement again.

Hereafter, each time the inverter is turned OFF, it automatically measures the discharging time of the DC link bus capacitor if the above conditions are met. Periodically check the relative capacitance of the DC link bus capacitor (%) with Menu #5 "5: MAINTENANC," Page 2, "CAP" in Programming mode.

Note The condition given above produces a rather large measurement error. If this mode gives you a lifetime alarm, set H98 (Maintenance operation) back to the default setting (Bit 3 (Select life judgment threshold of DC link bus capacitor) = 0) and conduct the measurement under the condition at the time of factory shipment.

[3] Early warning of lifetime alarm

For the components listed in Table 7.3, the inverter can issue an early warning of lifetime alarm **LIFE** at one of the transistor output terminals ([Y1] to [Y4]) and the relay contact terminals ([Y5A] - [Y5C], and [30A/B/C]) as soon as any of the levels specified in Table 7.3 has been exceeded.

The early warning signal is also turned ON when a lock condition on the internal air circulation DC fan (provided on inverters of 75 HP or above for 230 V series and on those of 125 HP or above for 460 V series) has been detected.

7.4 Measurement of Electrical Amounts in Main Circuit

Because the voltage and current of the power supply (input, primary circuit) of the main circuit of the inverter and those of the motor (output, secondary circuit) contain harmonic components, the readings may vary with the type of the meter. Use meters indicated in Table 7.4 when measuring with meters for commercial frequencies.

The power factor cannot be measured by a commercially available power-factor meter that measures the phase difference between the voltage and current. To obtain the power factor, measure the power, voltage and current on each of the input and output sides and use the following formula.

■ Three-phase input

$$\text{Power factor} = \frac{\text{Electric power (W)}}{\sqrt{3} \times \text{Voltage (V)} \times \text{Current (A)}} \times 100 \%$$

Table 7.4 Meters for Measurement of Main Circuit

Item	Input (primary) side			Output (secondary) side			DC link bus voltage (P(+)-N(-))
Waveform	Voltage		Current	Voltage		Current	
Name of meter	Ammeter AR, AS, AT	Voltmeter VR, VS, VT	Wattmeter WR, WT	Ammeter AU, AV, AW	Voltmeter VU, VV, VW	Wattmeter WU, WW	DC voltmeter V
Type of meter	Moving iron type	Rectifier or moving iron type	Digital AC power meter	Digital AC power meter	Digital AC power meter	Digital AC power meter	Moving coil type
Symbol of meter			—	—	—	—	

Note It is not recommended that meters other than a digital AC power meter be used for measuring the output voltage or output current since they may cause larger measurement errors or, in the worst case, they may be damaged.

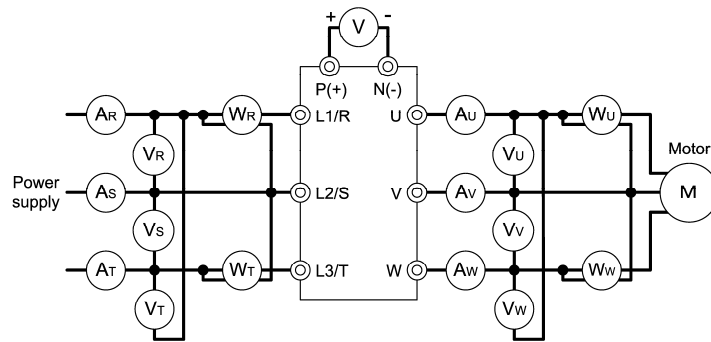

Figure 7.1 Connection of Meters

7.5 Insulation Test

Since the inverter has undergone an insulation test before shipment, avoid making a Megger test at the customer's site.

If a Megger test is unavoidable for the main circuit, observe the following instructions; otherwise, the inverter may be damaged.

A withstand voltage test may also damage the inverter if the test procedure is wrong. When the withstand voltage test is necessary, consult your Fuji Electric representative.

(1) Megger test of main circuit

- 1) Use a 500 VDC Megger and shut off the main power supply without fail before measurement.
- 2) If the test voltage leaks to the control circuit due to the wiring, disconnect all the wiring from the control circuit.
- 3) Connect the main circuit terminals with a common line as shown in Figure 7.2.
- 4) The Megger test must be limited to across the common line of the main circuit and the ground (⊕).
- 5) Value of 5 MΩ or more displayed on the Megger indicates a correct state. (The value is measured on an inverter alone.)

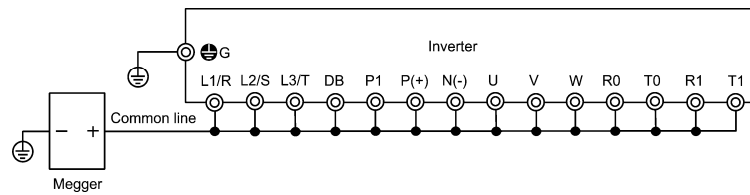

Figure 7.2 Main Circuit Terminal Connection for Megger Test

(2) Insulation test of control circuit

Do not make a Megger test or withstand voltage test for the control circuit. Use a high resistance range tester for the control circuit.

- 1) Disconnect all the external wiring from the control circuit terminals.
- 2) Perform a continuity test to the ground. One MΩ or a larger measurement indicates a correct state.

(3) Insulation test of external main circuit and sequence control circuit

Disconnect all the wiring connected to the inverter so that the test voltage is not applied to the inverter.

7.6 Inquiries about Product and Guarantee

7.6.1 When making an inquiry

Upon breakage of the product, uncertainties, failure or inquiries, inform your Fuji Electric representative of the following information.

- 1) Inverter type (Refer to Chapter 1, Section 1.1.)
- 2) SER No. (serial number of equipment) (Refer to Chapter 1, Section 1.1.)
- 3) Function codes and their data that you have changed (Refer to Chapter 3, Section 3.4.3.)
- 4) ROM version (Refer to Chapter 3, Section 3.4.6.)
- 5) Date of purchase
- 6) Inquiries (for example, point and extent of breakage, uncertainties, failure phenomena, and other circumstances)

7.6.2 Product warranty

To all our customers who purchase Fuji Electric products included in this documentation:

Please take the following items into consideration when placing your order.

When requesting an estimate and placing your orders for the products included in these materials, please be aware that any items such as specifications which are not specifically mentioned in the contract, catalog, specifications or other materials will be as mentioned below.

In addition, the products included in these materials are limited in the use they are put to and the place where they can be used, etc., and may require periodic inspection. Please confirm these points with your sales representative or directly with this company.

Furthermore, regarding purchased products and delivered products, we request that you take adequate consideration of the necessity of rapid receiving inspections and of product management and maintenance even before receiving your products.

[1] Free of charge warranty period and warranty range

(1) Free of charge warranty period

- 1) The product warranty period is "3 years from the shipment date."
- 2) However, in cases where the use environment, conditions of use, use frequency and times used, etc., have an effect on product life, this warranty period may not apply.
- 3) Furthermore, the warranty period for parts restored by Fuji Electric's Service Department is "6 months from the date that repairs are completed."

(2) Warranty range

- 1) In the event that breakdown occurs during the product's warranty period which is the responsibility of Fuji Electric, Fuji Electric will replace or repair the part of the product that has broken down free of charge at the place where the product was purchased or where it was delivered. However, if the following cases are applicable, the terms of this warranty may not apply.
 - ① The breakdown was caused by inappropriate conditions, environment, handling or use methods, etc. which are not specified in the catalog, operation manual, specifications or other relevant documents.
 - ② The breakdown was caused by the product other than the purchased or delivered Fuji's product.
 - ③ The breakdown was caused by the product other than Fuji's product, such as the customer's equipment or software design, etc.
 - ④ Concerning the Fuji's programmable products, the breakdown was caused by a program other than a program supplied by this company, or the results from using such a program.
 - ⑤ The breakdown was caused by modifications or repairs affected by a party other than Fuji Electric.
 - ⑥ The breakdown was caused by improper maintenance or replacement using consumables, etc. specified in the operation manual or catalog, etc.
 - ⑦ The breakdown was caused by a science or technical problem that was not foreseen when making practical application of the product at the time it was purchased or delivered.
 - ⑧ The product was not used in the manner the product was originally intended to be used.
 - ⑨ The breakdown was caused by a reason which is not this company's responsibility, such as lightning or other disaster.
- 2) Furthermore, the warranty specified herein shall be limited to the purchased or delivered product alone.
- 3) The upper limit for the warranty range shall be as specified in item (1) above and any damages (damage to or loss of machinery or equipment, or lost profits from the same, etc.) consequent to or resulting from breakdown of the purchased or delivered product shall be excluded from coverage by this warranty.

(3) Trouble diagnosis

As a rule, the customer is requested to carry out a preliminary trouble diagnosis. However, at the customer's request, this company or its service network can perform the trouble diagnosis on a chargeable basis. In this case, the customer is asked to assume the burden for charges levied in accordance with this company's fee schedule.

[2] Exclusion of liability for loss of opportunity, etc.

Regardless of whether a breakdown occurs during or after the free of charge warranty period, this company shall not be liable for any loss of opportunity, loss of profits, or damages arising from special circumstances, secondary damages, accident compensation to another company, or damages to products other than this company's products, whether foreseen or not by this company, which this company is not be responsible for causing.

[3] Repair period after production stop, spare parts supply period (holding period)

Concerning models (products) which have gone out of production, this company will perform repairs for a period of 7 years after production stop, counting from the month and year when the production stop occurs. In addition, we will continue to supply the spare parts required for repairs for a period of 7 years, counting from the month and year when the production stop occurs. However, if it is estimated that the life cycle of certain electronic and other parts is short and it will be difficult to procure or produce those parts, there may be cases where it is difficult to provide repairs or supply spare parts even within this 7-year period. For details, please confirm at our company's business office or our service office.

[4] Transfer rights

In the case of standard products which do not include settings or adjustments in an application program, the products shall be transported to and transferred to the customer and this company shall not be responsible for local adjustments or trial operation.

[5] Service contents

The cost of purchased and delivered products does not include the cost of dispatching engineers or service costs. Depending on the request, these can be discussed separately.

[6] Applicable scope of service

Above contents shall be assumed to apply to transactions and use of the country where you purchased the products. Consult the local supplier or Fuji for the detail separately.

Chapter 8 SPECIFICATIONS

8.1 Standard Model 1 (Basic Type)

8.1.1 Three-phase 230 V series

LD (Low Duty)-mode inverters for light load

Item	Specifications																		
Type (FRN__G1S-2U)	F50	001	002	003	005	007	010	015	020	025	030	040	050	060	075	100	125	150	
Nominal applied motor (HP) (Output rating) *1	0.5	1	2	3	5	7.5	10	15	20	25	30	40	50	60	75	100	125	150	
Output ratings	Rated capacity (kVA) *2	1.2	2.0	3.2	4.4	7.2	11	13	18	24	30	35	46	58	72	86	113	138	165
	Rated voltage (V) *3	Three-phase 200 to 240 V (with AVR function)											Three-phase 200 to 230 V (with AVR function)						
	Rated current (A) *4	3	5	8	11	18	27	31.8 (29)	46.2 (42)	59.4 (55)	74.8 (68)	88 (80)	115 (107)	146	180	215	283	346	415
	Overload capability	150%-1 min, 200%-3.0 s						120%-1 min											
Input power	Voltage, frequency	200 to 240 V, 50/60 Hz											200 to 220 V, 50 Hz, 200 to 230 V, 60 Hz						
	Allowable voltage/frequency	Voltage: +10 to -15% (Interphase voltage unbalance: 2% or less) *5, Frequency: +5 to -5%																	
Braking	Required capacity (with DCR) (kVA) *6	0.6	1.2	2.2	3.1	5.2	7.4	10.0	15.0	20.0	25.0	30.0	40.0	48.0	58.0	71.0	98.0	116	143
	Torque (%) *7	150%		100%			70%			15%			7 to 12%						
	Braking transistor	Built-in																	
	Built-in braking resistor	Built-in																	
Braking	Braking time (s)	5 s					3.7 s		3.4 s		-								
	Duty cycle (%ED)	5	3	5	3	2	2.2		1.4		-								
DC reactor (DCR)	Option														Standard *8				
Applicable safety standards	UL508C, C22.2 No.14, EN61800-5-1:2007																		
Enclosure (IEC60529)	IP20, UL open type											IP00, UL open type							
Cooling method	Natural cooling					Fan cooling													
Weight / Mass (lbs (kg))	3.8 (1.7)	4.4 (2.0)	6.2 (2.8)	6.6 (3.0)	6.6 (3.0)	14 (6.5)	14 (6.5)	14 (6.5)	13 (5.8)	21 (9.5)	21 (9.5)	22 (10)	55 (25)	71 (32)	93 (42)	95 (43)	137 (62)	232 (105)	

HD (High Duty)-mode inverters for heavy load

Item	Specifications																		
Type (FRN__G1S-2U)	F50	001	002	003	005	007	010	015	020	025	030	040	050	060	075	100	125	150	
Nominal applied motor (HP) (Output rating) *1	0.5	1	2	3	5	7.5	7.5	10	15	20	25	30	40	50	60	75	100	125	
Output ratings	Rated capacity (kVA) *2	1.2	2.0	3.2	4.4	7.2	11	11	15	20	25	30	36	47	58	72	86	113	138
	Rated voltage (V) *3	Three-phase 200 to 240 V (with AVR function)											Three-phase 200 to 230 V (with AVR function)						
	Rated current (A)	3	5	8	11	18	27	27	37	49	63	76	90	119	146	180	215	283	346
	Overload capability	150%-1 min, 200%-3.0 s																	
Input power	Voltage, frequency	200 to 240 V, 50/60 Hz											200 to 220 V, 50 Hz, 200 to 230 V, 60 Hz						
	Allowable voltage/frequency	Voltage: +10 to -15% (Interphase voltage unbalance: 2% or less) *5, Frequency: +5 to -5%																	
Braking	Required capacity (with DCR) (kVA) *6	0.6	1.2	2.2	3.1	5.2	7.4	7.4	10	15	20	25	30	40	48	58	71	98	116
	Torque (%) *7	150%		100%			20%			10 to 15%									
	Braking transistor	Built-in																	
	Built-in braking resistor	Built-in																	
Braking	Braking time (s)	5 s																	
	Duty cycle (%ED)	5	3	5	3	2	3	3	2	-									
DC reactor (DCR)	Option														Standard *8				
Applicable safety standards	UL508C, C22.2 No.14, EN61800-5-1:2007																		
Enclosure (IEC60529)	IP20, UL open type											IP00, UL open type							
Cooling method	Natural cooling					Fan cooling													
Weight / Mass (lbs (kg))	3.8 (1.7)	4.4 (2.0)	6.2 (2.8)	6.6 (3.0)	6.6 (3.0)	14 (6.5)	14 (6.5)	14 (6.5)	13 (5.8)	21 (9.5)	21 (9.5)	22 (10)	55 (25)	71 (32)	93 (42)	95 (43)	137 (62)	232 (105)	

*1 US-4P standard induction motor

*2 Rated capacity is calculated assuming the rated output voltage as 230 V for 230 V series and 460 V for 460 V series.

*3 Output voltage cannot exceed the power supply voltage.

*4 To use the inverter with the carrier frequency of 3 kHz or more at the surrounding temperature of 40°C (104°F) or higher, manage the load so that the current comes to be within the rated ones enclosed in parentheses () in continuous running.

*5 Voltage unbalance (%) = $\frac{\text{Max. voltage (V)} - \text{Min. voltage (V)}}{\text{Three-phase average voltage (V)}} \times 67$ (IEC 61800-3)

If this value is 2 to 3%, use an optional AC reactor (ACR).

*6 Required when a DC reactor (DCR) is used.

*7 Average braking torque for the motor running alone, without external braking resistor. (It varies with the efficiency of the motor.)

*8 The FRN100G1S-2U or higher type comes with a DC reactor (DCR).

8.1.2 Three-phase 460 V series

LD (Low Duty)-mode inverters for light load

(0.5 to 100 HP)

Item	Specifications																	
Type (FRN___G1S-4U)	F50	001	002	003	005	007	010	015	020	025	030	040	050	060	075	100		
Nominal applied motor (HP) (Output rating) *1	0.5	1	2	3	5	7.5	10	15	20	25	30	40	50	60	75	100		
Output ratings	Rated capacity (kVA) *2	1.2	2.0	3.2	4.4	7.2	11	13.1	18.3	24	29	36	48	60	73	89	120	
	Rated voltage (V) *3	Three-phase 380 to 480 V (with AVR function)																
	Rated current (A)	1.5	2.5	4	5.5	9	13.5	16.5	23	30.5	37	45	60	75	91	112	150	
	Overload capability	150%-1 min, 200%-3.0 s						120%-1 min										
Input power	Voltage, frequency	380 to 480 V, 50/60 Hz																
	Allowable voltage/frequency	Voltage: +10 to -15% (Interphase voltage unbalance: 2% or less) *4, Frequency: +5 to -5%																
	Required capacity (with DCR) (kVA) *5	0.6	1.2	2.2	3.1	5.2	7.4	10	15	20	25	29	40	48	58	71	96	
Braking	Torque (%) *6	150%		100%			70%			15%			7 to 12%					
	Braking transistor	Built-in																
	Built-in braking resistor	Built-in																
	Braking time (s)	5 s					3.7 s		3.4 s		-							
	Duty cycle (%ED)	5	3	5	3	2	2.2		1.4		-							
DC reactor (DCR)	Option															Standard *7		
Applicable safety standards	UL508C, C22.2 No.14, EN61800-5-1:2007																	
Enclosure (IEC60529)	IP20, UL open type											IP00, UL open type						
Cooling method	Natural cooling					Fan cooling												
Weight / Mass lbs (kg)	3.8 (1.7)	4.4 (2.0)	5.7 (2.6)	6.0 (2.7)	6.6 (3.0)	6.6 (3.0)	14 (6.5)	14 (6.5)	14 (6.5)	13 (5.8)	21 (9.5)	21 (9.5)	22 (10)	55 (25)	57 (26)	68 (31)	73 (33)	

(125 to 1000 HP)

Item	Specifications																	
Type (FRN___G1S-4U)	125	150	200	250	300	350	450	500	600	700	800	900	1000					
Nominal applied motor (HP) (Output rating) *1	125	150	200	250	300	350	450	500	600	700	800	900	1000					
Output ratings	Rated capacity (kVA) *2	140	167	202	242	300	331	414	518	590	669	765	932	1092				
	Rated voltage (V) *3	Three-phase 380 to 480 V (with AVR function)																
	Rated current (A)	176	210	253	304	377	415	520	650	740	840	960	1170	1370				
	Overload capability	120%-1 min																
Input power	Voltage, frequency	380 to 440 V, 50 Hz 380 to 480 V, 60 Hz																
	Allowable voltage/frequency	Voltage: +10 to -15% (Interphase voltage unbalance: 2% or less) *4, Frequency: +5 to -5%																
Braking	Required capacity (with DCR) (kVA) *5	114	140	165	199	248	271	347	436	489	547	611	773	871				
	Torque (%) *6	7 to 12%																
	Braking transistor	-																
	Built-in braking resistor	-																
DC reactor (DCR)	Braking time (s)	-																
	Duty cycle (%ED)	-																
DC reactor (DCR)	Standard *7																	
Applicable safety standards	UL508C, C22.2 No.14, EN61800-5-1:2007																	
Enclosure (IEC60529)	IP00, UL open type																	
Cooling method	Fan cooling																	
Weight / Mass lbs (kg)	93 (42)	137 (62)	141 (64)	207 (94)	216 (98)	284 (129)	309 (140)	540 (245)	540 (245)	728 (330)	728 (330)	1169 (530)	1169 (530)					

*1 US-4P standard induction motor

*2 Rated capacity is calculated assuming the rated output voltage as 230 V for 230 V series and 460 V for 460 V series.

*3 Output voltage cannot exceed the power supply voltage.

*4 Voltage unbalance (%) = $\frac{\text{Max. voltage (V)} - \text{Min. voltage (V)}}{\text{Three-phase average voltage (V)}} \times 67$ (IEC 61800-3)

If this value is 2 to 3%, use an optional AC reactor (ACR).

*5 Required when a DC reactor (DCR) is used.

*6 Average braking torque for the motor running alone, without external braking resistor. (It varies with the efficiency of the motor.)

*7 The FRN100G1S-4U or higher type comes with a DC reactor (DCR).

MD (Medium Duty)-mode inverters for medium load

(150 to 700 HP)

Item	Specifications															
Type (FRN___G1S-4U)	150	200	250	300	350	450	500	600	700	800						
Nominal applied motor (HP) (Output rating) *1	150	200	250	300	350	350	450	500	600	700						
Rated capacity (kVA) *2	167	202	242	300	331	373	466	518	590	669						
Rated voltage (V) *3	Three-phase 380 to 480 V (with AVR function)															
Rated current (A)	210	253	304	377	415	468	585	650	740	840						
Overload capability	150%-1 min															
Voltage, frequency	380 to 440 V, 50 Hz 380 to 480 V, 60 Hz															
Allowable voltage/frequency	Voltage: +10 to -15% (Interphase voltage unbalance: 2% or less) *4, Frequency: +5 to -5%															
Required capacity (with DCR) (kVA) *5	140	165	199	248	271	308	388	436	489	547						
Torque (%) *6	7 to 12%															
Braking transistor	-															
Built-in braking resistor	-															
Braking time (s)	-															
Duty cycle (%ED)	-															
DC reactor (DCR)	Standard *7															
Applicable safety standards	UL508C, C22.2 No.14, EN61800-5-1:2007															
Enclosure (IEC60529)	IP00, UL open type															
Cooling method	Fan cooling															
Weight / Mass lbs (kg)	137 (62)	141 (64)	207 (94)	216 (98)	284 (129)	309 (140)	540 (245)	540 (245)	728 (330)	728 (330)						

*1 US-4P standard induction motor

*2 Rated capacity is calculated assuming the rated output voltage as 230 V for 230 V series and 460 V for 460 V series.

*3 Output voltage cannot exceed the power supply voltage.

*4
$$\text{Voltage unbalance (\%)} = \frac{\text{Max. voltage (V)} - \text{Min. voltage (V)}}{\text{Three-phase average voltage (V)}} \times 67 \text{ (IEC 61800-3)}$$

If this value is 2 to 3%, use an optional AC reactor (ACR).

*5 Required when a DC reactor (DCR) is used.

*6 Average braking torque for the motor running alone, without external braking resistor. (It varies with the efficiency of the motor.)

*7 The FRN100G1S-4U or higher type comes with a DC reactor (DCR).

HD (High Duty)-mode inverters for heavy load

(0.5 to 75 HP)

Item	Specifications																					
Type (FRN___G1S-4U)	F50	001	002	003	005	007	010	015	020	025	030	040	050	060	075	100						
Nominal applied motor (HP) (Output rating) *1	0.5	1	2	3	5	7.5	7.5	10	15	20	25	30	40	50	60	75						
Output ratings	Rated capacity (kVA) *2	1.2	2.0	3.2	4.4	7.2	11	11	15	20	25	31	36	48	60	73	89					
	Rated voltage (V) *3	Three-phase 380 to 480 V (with AVR function)																				
	Rated current (A)	1.5	2.5	4	5.5	9	13.5	13.5	18.5	24.5	32	39	45	60	75	91	112					
	Overload capability	150%-1 min, 200%-3.0 s																				
Input power	Voltage, frequency	380 to 480 V, 50/60 Hz																				
	Allowable voltage/frequency	Voltage: +10 to -15% (Interphase voltage unbalance: 2% or less) *4, Frequency: +5 to -5%																				
	Required capacity (with DCR) (kVA) *5	0.6	1.2	2.1	3.2	5.3	7.4	7.4	9.9	15.0	20.0	25.0	29.0	40.0	48.0	58.0	71.0					
Braking	Torque (%) *6	150%		100%					20%					10 to 15%								
	Braking transistor	Built-in																				
	Built-in braking resistor	Built-in																				
	Braking time (s)	5 s																				
DC reactor (DCR)	Duty cycle (%ED)	5	3	5	3	2	3	3	2										Standard *7			
	Option																					
Applicable safety standards	UL508C, C22.2 No.14, EN61800-5-1:2007																					
Enclosure (IEC60529)	IP20, UL open type											IP00, UL open type										
Cooling method	Natural cooling					Fan cooling																
Weight / Mass lbs (kg)	3.8 (1.7)	4.4 (2.0)	5.7 (2.6)	6.0 (2.7)	6.6 (3.0)	14 (6.5)	14 (6.5)	14 (6.5)	13 (5.8)	21 (9.5)	21 (9.5)	22 (10)	55 (25)	57 (26)	68 (31)	73 (33)						

(100 to 900 HP)

Item	Specifications																	
Type (FRN___G1S-4U)	125	150	200	250	300	350	450	500	600	700	800	900	1000					
Nominal applied motor (HP) (Output rating) *1	100	125	150	200	250	300	350	400	450	500	600	800	900					
Output ratings	Rated capacity (kVA) *2	120	140	167	202	242	300	330	414	466	518	590	765	932				
	Rated voltage (V) *3	Three-phase 380 to 480 V (with AVR function)																
	Rated current (A)	150	176	210	253	304	377	415	520	585	650	740	960	1170				
	Overload capability	150%-1 min, 200%-3.0 s																
Input power	Voltage, frequency	380 to 440 V, 50 Hz 380 to 480 V, 60 Hz																
	Allowable voltage/frequency	Voltage: +10 to -15% (Interphase voltage unbalance: 2% or less) *4, Frequency: +5 to -5%																
	Required capacity (with DCR) (kVA) *5	96	114	140	165	199	248	271	347	388	436	489	611	773				
Braking	Torque (%) *6	10 to 15%																
	Braking transistor	-																
	Built-in braking resistor	-																
	Braking time (s)	-																
DC reactor (DCR)	Duty cycle (%ED)	-																
	Standard *7																	
Applicable safety standards	UL508C, C22.2 No.14, EN61800-5-1:2007																	
Enclosure (IEC60529)	IP00, UL open type																	
Cooling method	Fan cooling																	
Weight / Mass lbs (kg)	93 (42)	137 (62)	141 (64)	207 (94)	216 (98)	284 (129)	309 (140)	540 (245)	540 (245)	728 (330)	728 (330)	1169 (530)	1169 (530)					

*1 US-4P standard induction motor

*2 Rated capacity is calculated assuming the rated output voltage as 230 V for 230 V series and 460 V for 460 V series.

*3 Output voltage cannot exceed the power supply voltage.

*4 Voltage unbalance (%) = $\frac{\text{Max. voltage (V)} - \text{Min. voltage (V)}}{\text{Three-phase average voltage (V)}} \times 67$ (IEC 61800-3)

If this value is 2 to 3%, use an optional AC reactor (ACR).

*5 Required when a DC reactor (DCR) is used.

*6 Average braking torque for the motor running alone, without external braking resistor. (It varies with the efficiency of the motor.)

*7 The FRN100G1S-4U or higher type comes with a DC reactor (DCR).

8.2 Standard Model 2 (DCR Built-in Type)

8.2.1 Three-phase 230 V series

LD (Low Duty)-mode inverters for light load

Item	Specifications												
Type (FRN_ _G1H-2U)	007	010	015	020	025	030	040	050	060	075	100		
Nominal applied motor (HP) (Output rating) *1	7.5	10	15	20	25	30	40	50	60	75	100		
Rated capacity (kVA) *2	11	13	18	24	30	35	46	58	72	86	113		
Rated voltage (V) *3	Three-phase 200 to 240 V (with AVR function)							Three-phase 200 to 230 V (with AVR function)					
Rated current (A) *4	27	31.8 (29)	46.2 (42)	59.4 (55)	74.8 (68)	88 (80)	115 (107)	146	180	215	283		
Overload capability	150%-1 min, 200%-3.0 s		120%-1 min										
Voltage, frequency	200 to 240 V, 50/60 Hz							200 to 220 V, 50 Hz, 200 to 230 V, 60 Hz					
Allowable voltage/frequency	Voltage: +10 to -15% (Interphase voltage unbalance: 2% or less) *5, Frequency: +5 to -5%												
Required capacity (kVA)	7.7	10	15	20	25	30	40	50	62	74	98		
Torque (%) *6	70%			15%				7 to 12%					
Braking transistor	Built-in							-					
Built-in braking resistor	Built-in			-									
Braking time (s)	3.7 s		3.4 s		-								
Duty cycle (%ED)	2.2		1.4		-								
DC reactor (DCR)	Built-in as standard												
Applicable safety standards	UL508C, C22.2 No.14, EN61800-5-1:2007												
Enclosure (IEC60529)	IP20, UL open type							IP00, UL open type					
Cooling method	Fan cooling												
Weight / Mass lbs (kg)	24 (10.7)	24 (10.7)	25 (11.1)	25 (11.5)	38 (17.3)	39 (17.6)	41 (18.5)	68 (31)	86 (39)	112 (51)	115 (52)		

HD (High Duty)-mode inverters for heavy load

Item	Specifications												
Type (FRN_ _G1H-2U)	007	010	015	020	025	030	040	050	060	075	100		
Nominal applied motor (HP) (Output rating) *1	7.5	7.5	10	15	20	25	30	40	50	60	75		
Rated capacity (kVA) *2	11	11	15	20	25	30	36	47	58	72	86		
Rated voltage (V) *3	Three-phase 200 to 240 V (with AVR function)							Three-phase 200 to 230 V (with AVR function)					
Rated current (A)	27	27	37	49	63	76	90	119	146	180	215		
Overload capability	150%-1 min, 200%-3.0 s												
Voltage, frequency	200 to 240 V, 50/60 Hz							200 to 220 V, 50 Hz, 200 to 230 V, 60 Hz					
Allowable voltage/frequency	Voltage: +10 to -15% (Interphase voltage unbalance: 2% or less) *5, Frequency: +5 to -5%												
Required capacity (kVA)	7.7	7.7	10.5	15.5	21	26	31	42	52	64	77		
Torque (%) *6	100%			20%				10 to 15%					
Braking transistor	Built-in							-					
Built-in braking resistor	Built-in			-									
Braking time (s)	5 s			-									
Duty cycle (%ED)	3		2		-								
DC reactor (DCR)	Built-in as standard												
Applicable safety standards	UL508C, C22.2 No.14, EN61800-5-1:2007												
Enclosure (IEC60529)	IP20, UL open type							IP00, UL open type					
Cooling method	Fan cooling												
Weight / Mass lbs (kg)	24 (10.7)	24 (10.7)	25 (11.1)	25 (11.5)	38 (17.3)	39 (17.6)	41 (18.5)	68 (31)	86 (39)	112 (51)	115 (52)		

*1 US-4P standard induction motor

*2 Rated capacity is calculated assuming the rated output voltage as 230 V for 230 V series and 460 V for 460 V series.

*3 Output voltage cannot exceed the power supply voltage.

*4 To use the inverter with the carrier frequency of 3 kHz or more at the surrounding temperature of 40°C (104°F) or higher, manage the load so that the current comes to be within the rated ones enclosed in parentheses () in continuous running.

*5 Voltage unbalance (%) = $\frac{\text{Max. voltage (V)} - \text{Min. voltage (V)}}{\text{Three-phase average voltage (V)}} \times 67$ (IEC 61800-3)

If this value is 2 to 3%, use an optional AC reactor (ACR).

*6 Average braking torque for the motor running alone, without external braking resistor. (It varies with the efficiency of the motor.)

8.2.2 Three-phase 460 V series

LD (Low Duty)-mode inverters for light load

Item	Specifications												
Type (FRN__G1H-4U)	007	010	015	020	025	030	040	050	060	075	100		
Nominal applied motor (HP) (Output rating) *1	7.5	10	15	20	25	30	40	50	60	75	100		
Output ratings	Rated capacity (kVA) *2	11	13.1	18.3	24	29	36	48	60	73	89	120	
	Rated voltage (V) *3	Three-phase 380 to 480 V (with AVR function)											
	Rated current (A)	13.5	16.5	23	30.5	37	45	60	75	91	112	150	
	Overload capability	150%-1 min, 200%-3.0 s		120%-1 min									
Input power	Voltage, frequency	380 to 480 V, 50/60 Hz											
	Allowable voltage/frequency	Voltage: +10 to -15% (Interphase voltage unbalance: 2% or less) *4, Frequency: +5 to -5%											
	Required capacity (kVA)	7.7	10	15	20	25	30	41	49	61	74	100	
Braking	Torque (%) *5	70%			15%			7 to 12%					
	Braking transistor	Built-in			Built-in			-					
	Built-in braking resistor	Built-in			-			-					
	Braking time (s)	3.7 s		3.4 s		-							
	Duty cycle (%ED)	2.2		1.4		-							
DC reactor (DCR)	Built-in as standard												
Applicable safety standards	UL508C, C22.2 No.14, EN61800-5-1:2007												
Enclosure (IEC60529)	IP20, UL open type						IP00, UL open type						
Cooling method	Fan cooling												
Weight / Mass lbs (kg)	24 (10.8)	24 (10.8)	26 (11.9)	26 (11.6)	39 (17.6)	40 (18.1)	41 (18.6)	71 (32)	73 (33)	86 (39)	93 (42)		

HD (High Duty)-mode inverters for heavy load

Item	Specifications												
Type (FRN__G1H-4U)	007	010	015	020	025	030	040	050	060	075	100		
Nominal applied motor (HP) (Output rating) *1	7.5	7.5	10	15	20	25	30	40	50	60	75		
Output ratings	Rated capacity (kVA) *2	11	11	15	20	25	31	36	48	60	73	89	
	Rated voltage (V) *3	Three-phase 380 to 480 V (with AVR function)											
	Rated current (A)	13.5	13.5	18.5	24.5	32	39	45	60	75	91	112	
	Overload capability	150%-1 min, 200%-3.0 s											
Input power	Voltage, frequency	380 to 480 V, 50/60 Hz											
	Allowable voltage/frequency	Voltage: +10 to -15% (Interphase voltage unbalance: 2% or less) *4, Frequency: +5 to -5%											
	Required capacity (kVA)	7.7	7.7	11	16	21	26	31	41	52	64	79	
Braking	Torque (%) *5	100%			20%			10 to 15%					
	Braking transistor	Built-in			Built-in			-					
	Built-in braking resistor	Built-in			-			-					
	Braking time (s)	5 s			-								
	Duty cycle (%ED)	3		2		-							
DC reactor (DCR)	Built-in as standard												
Applicable safety standards	UL508C, C22.2 No.14, EN61800-5-1:2007												
Enclosure (IEC60529)	IP20, UL open type						IP00, UL open type						
Cooling method	Fan cooling												
Weight / Mass lbs (kg)	24 (10.8)	24 (10.8)	26 (11.9)	26 (11.6)	39 (17.6)	40 (18.1)	41 (18.6)	71 (32)	73 (33)	86 (39)	93 (42)		

*1 US-4P standard induction motor

*2 Rated capacity is calculated assuming the rated output voltage as 230 V for 230 V series and 460 V for 460 V series.

*3 Output voltage cannot exceed the power supply voltage.

*4 Voltage unbalance (%) = $\frac{\text{Max. voltage (V)} - \text{Min. voltage (V)}}{\text{Three-phase average voltage (V)}} \times 67$ (IEC 61800-3)

If this value is 2 to 3%, use an optional AC reactor (ACR).

*5 Average braking torque for the motor running alone, without external braking resistor. (It varies with the efficiency of the motor.)

8.3 Common Specifications

Item		Explanation	
Output frequency	Setting range	Maximum frequency	25 to 500 Hz (120 Hz for inverters in LD/MD mode) (120 Hz under vector control without speed sensor) (200 Hz under V/f control with speed sensor or vector control with speed sensor)
		Base frequency	25 to 500 Hz (in conjunction with the maximum frequency)
		Starting frequency	0.1 to 60.0 Hz (0.0 Hz under vector control with/without speed sensor)
		Carrier frequency	<ul style="list-style-type: none"> • 0.75 to 16 kHz (LD mode: 7 to 30 HP, HD mode: 0.5 to 100 HP) • 0.75 to 10 kHz (LD mode: 40 to 100 HP, HD mode: 120 to 800 HP) • 0.75 to 6 kHz (LD mode: 125 to 900 HP, HD mode: 900 and 1000 HP) • 0.75 to 4 kHz (LD mode: 1000 HP) • 0.75 to 2 kHz (MD mode: 150 to 800 HP) <p>Note: The carrier frequency may automatically drop depending upon the surrounding temperature or the output current to protect the inverter. (The automatic drop function can be disabled.)</p>
		Accuracy (Stability)	<ul style="list-style-type: none"> • Analog setting: $\pm 0.2\%$ of maximum frequency (at $25 \pm 10^\circ\text{C}$ ($77 \pm 55^\circ\text{F}$)) • Digital setting: $\pm 0.01\%$ of maximum frequency (at -10 to $+50^\circ\text{C}$ (14 to 122°F))
	Setting resolution	<ul style="list-style-type: none"> • Analog setting: 1/3000 of maximum frequency (1/1500 for V2 input) • Digital setting: 0.01 Hz (99.99 Hz or less), 0.1 Hz (100.0 to 500.0 Hz) • Link operation setting: Selectable from the following two types <ul style="list-style-type: none"> - 1/20000 of maximum frequency - 0.01 Hz (fixed) 	
	Under V/f control with speed sensor	Speed control range	<ul style="list-style-type: none"> • 1 : 100 (Minimum speed : Base speed, 4P, 15 to 1500 r/min) • 1 : 2 (Constant torque range : Constant output range)
	Under dynamic torque vector control with speed sensor	Speed control accuracy	<ul style="list-style-type: none"> • Analog setting: $\pm 0.2\%$ of maximum frequency (at $25 \pm 10^\circ\text{C}$ ($77 \pm 55^\circ\text{F}$)) • Digital setting: $\pm 0.01\%$ of maximum frequency (at -10 to $+50^\circ\text{C}$ (14 to 122°F))
	Under vector control without speed sensor	Speed control range	<ul style="list-style-type: none"> • 1 : 200 (Minimum speed : Base speed, 4P, 7.5 to 1500 r/min) • 1 : 2 (Constant torque range : Constant output range)
		Speed control accuracy	<ul style="list-style-type: none"> • Analog setting: $\pm 0.5\%$ of base speed (at $25 \pm 10^\circ\text{C}$ ($77 \pm 55^\circ\text{F}$)) • Digital setting: $\pm 0.5\%$ of base speed (at -10 to $+50^\circ\text{C}$ (14 to 122°F))
Under vector control with speed sensor	Speed control range	<ul style="list-style-type: none"> • 1 : 1500 (Minimum speed : Base speed, 4P, 1 to 1500 r/min, 1024 p/r) • 1 : 4 (Constant torque range : Constant output range) 	
	Speed control accuracy	<ul style="list-style-type: none"> • Analog setting: $\pm 0.2\%$ of maximum frequency (at $25 \pm 10^\circ\text{C}$ ($77 \pm 55^\circ\text{F}$)) • Digital setting: $\pm 0.01\%$ of maximum frequency (at -10 to $+50^\circ\text{C}$ (14 to 122°F)) 	
Control	Control method	<ul style="list-style-type: none"> • V/f control • Dynamic torque vector control • V/f control with speed sensor or dynamic torque vector control with speed sensor • Vector control without speed sensor (Not available for MD-mode inverters) • Vector control with speed sensor (with an optional PG interface card mounted) 	
	V/f characteristics	<ul style="list-style-type: none"> • Possible to set output voltage at base frequency and at maximum frequency • AVR control ON/OFF selectable. Non-linear V/f pattern with three arbitrary points. 	
	Torque boost	<ul style="list-style-type: none"> • Auto torque boost (for constant torque load) • Manual torque boost: Desired torque boost (0.0 to 20.0%) can be set. • Select application load with function code F37. (Variable torque load or constant torque load) 	
	Starting torque	40 HP or below: 200% or over, 50 HP or above: 180% or over at HD mode Reference frequency: 0.3 Hz with slip compensation and auto torque boost	
	Start/stop operation	<ul style="list-style-type: none"> • Keypad (FWD, REV and STOP keys), external signals (run forward (run reverse) command, etc.), Communications link (RS-485/fieldbus (option)) • Remote/local operation 	
	Enable input (Safe Torque Off (STO))	Opening the circuit between terminals [EN] and [PLC] stops the inverter's output transistor (coast-to-stop). (Compliant with EN954-1 Cat.3)	

Item	Explanation
Frequency command	<ul style="list-style-type: none"> Keypad: Ⓐ and Ⓑ keys Analog input (Analog input can be set with external voltage/current input): 0 to ± 10 VDC/0 to ± 100% (terminals [12], [V2]) +4 to +20 mA DC/0 to 100% (terminal [C1]) UP/DOWN operation: Multi-frequency (16 steps), 16-bit parallel Pulse train input (standard): Pulse input = [X7] terminal, Rotational direction = One of the digital input terminals except [X7] Link operation: Various buses (option) Reference frequency switching, Remote/local mode switching, Auxiliary frequency setting, Proportional operation setting, and Inverse operation
Acceleration/ deceleration time	0.00 to 6000 s Linear/S-curve/curvilinear, Acceleration/deceleration time settings 1 to 4 switchable
Stop control	<ul style="list-style-type: none"> Running continued at the stop frequency, coast-to-stop, or force to stop. DC braking: Braking starting frequency (up to 60 Hz), time (up to 30.0 s), and operation level (up to 100%) Zero speed control (under vector control with speed sensor.)
Auto-restart after momentary power failure	<ul style="list-style-type: none"> Trip immediately, trip after recovery from power failure, trip after deceleration to stop Continue to run, restart at the frequency at which the power failure occurred, restart at the starting frequency, restart after searching for idling motor speed
Hardware current limiter	<ul style="list-style-type: none"> Current limiter operation level (20 to 200%) Overcurrent limiting by hardware (This can be canceled.)
Torque limiter	<ul style="list-style-type: none"> Torque limit value (±300%) Torque limiter 1/2, torque limiter enabled/disabled, analog torque limit value
Control functions	<ul style="list-style-type: none"> Analog input adjustment (gain/offset/filter time constant), frequency limiter (high and low), bias frequency, jump frequency, jogging operation, pre-excitation, switch to commercial power, commercial power switching sequence, cooling fan ON/OFF control, select motor 2 to 4, protect motor from dew condensation, universal DI, universal DO, universal AO, rotational direction limitation Overload prevention control, auto search, slip compensation, automatic deceleration (anti-regenerative control), droop control, PID process control, PID dancer control, Deceleration characteristics (improving braking capability), auto energy saving function Auto-tuning (offline) Life early warning, cumulative inverter run time, cumulative motor run time Light alarm, retry, command loss detection
Digital input	Run forward command, run reverse command, select multi-frequency, select ACC/DEC time, enable 3-wire operation, coast to a stop, reset alarm, enable external alarm trip, ready for jogging, select frequency command 2/1, select motor 1 to 4, enable DC braking, select torque limiter level, switch to commercial power, UP (increase output frequency), DOWN (decrease output frequency), enable data change with keypad, cancel PID control, switch normal/inverse operation, interlock, cancel torque control, enable communications link via RS-485 or fieldbus (option), universal DI, enable auto search for idling motor speed at starting, force to stop, pre-excitation, reset PID integral and differential components, hold PID integral component, select local (keypad) operation, protect the motor from dew condensation, enable internal sequence to commercial lines, pulse train input, pulse train sign, cancel constant peripheral speed control, hold the constant peripheral speed control frequency in the memory, switch to commercial power operation, select droop control, servo-lock command, cancel PG alarm, cancel customizable logic, clear all customizable logic timers
Transistor output	Inverter running, frequency arrival signal 1/3, frequency detected (3 points), undervoltage detected (inverter stopped), torque polarity detected, inverter output limiting, auto-restarting after momentary power failure, motor overload early warning, keypad operation, inverter ready to run, switch motor power between commercial line and inverter output (inverter input/output/commercial power), select the AX terminal function (primary side MC), inverter output limiting with delay, cooling fan in operation, auto-resetting, universal DO, heat sink overheat early warning, service lifetime alarm, reference loss detected, inverter output on, overload prevention control, current detected (3 points), low level current detected, PID alarm, under PID control, PID control stopped due to slow flowrate, low output torque detected, torque detected (2 points), switched to motor 1 to 4, run forward signal, run reverse signal, inverter in remote operation, PTC status detection enabled, brake signal, analog frequency reference loss on the terminal [C1], inverter keeping speed output, speed arrived, PG error detected, maintenance timer, light alarm, alarm relay contact output (for any fault), braking resistor broken, positioning completion signal, enable circuit failure detected, customizable logic output signal

Control

Item		Explanation
Control	Analog output	Terminals [FM1] and [FM2]: Output a selected signal with analog DC voltage (0 to +10 V) or analog DC current (4 to 20 mA) Selectable output signals: Output frequency (before slip compensation, after slip compensation), output current, output voltage, output torque, load factor, input power, PID feedback amount, speed (PG feedback value), DC link bus voltage, universal AO, motor output, calibration, PID command (SV), PID output (MV)
	Running/stopping	Speed monitor (reference frequency (Hz), output frequency, motor speed, load shaft speed, line speed, speed in %) Output current, output voltage, torque calculation value, input power, PID command value, PID feedback amount, PID output, load factor, motor output, torque current, flux command, analog signal input monitor, input watt-hour Life early warning, cumulative inverter run time, cumulative motor run time, input watt-hour, number of startups I/O checking, energy-saving monitor (input power, input power x coefficient (charges for input power))
Indication	Trip mode	Trip history: Saves and displays the last 4 trip factors and their detailed description.
	Communications	RS-485 COM port 1 (for keypad connection), RS-485 COM port 2 (on terminal block), USB port (provided on an optional remote keypad)
Other features	Protection against momentary power failure	Upon detection of a momentary power failure lasting more than 15 ms, this function stops the inverter output. If restart after momentary power failure is selected, this function invokes a restart process if power is restored within a predetermined period (allowable momentary power failure time).

8.4 External Dimensions

8.4.1 Standard models

Inverter type FRN_ _ _GIS-2U/4U		Dimensions inch (mm)															
230 V	460 V	W	W1	W2	H	H1	H2	D	D1	D2	D3	ØA					
0.5	0.5	4.33 (110)	3.78 (96)	0.24 (6)	10.24 (260)	9.69 (246)	0.28 (7)	5.2 (132)	4.45 (113)	0.75 (19)	0.12 (3)	0.24 (6)					
1	1	5.91 (150)	5.35 (136)					5.71 (145)		1.26 (32)							
2	2							9.37 (238)		0.43 (11)			7.68 (195)	4.13 (105)	3.54 (90)	0.39 (10)	
3	3																
5	5	8.66 (220)	7.72 (196)	0.39 (10)	15.75 (400)	14.88 (378)	0.47 (12)	10.04 (255)	5.51 (140)	0.39 (10)							
7.5	7.5	9.84 (250)	8.9 (226)								21.65 (550)	20.87 (530)	10.63 (270)	4.53 (115)	6.1 (155)		
10	10										24.21 (615)	23.43 (595)				26.57 (675)	25.79 (655)
15	15																
20	20	13.98 (355)	10.83 (275)	0.59 (15)	29.13 (740)	28.35 (720)	0.61 (15.5)	11.22 (285)	5.71 (145)	5.51 (140)	0.16 (4)						
25	25											20.87 (530)	16.93 (430)	14.17 (360)	7.09 (180)		
30	30	24.8 (630)	11.42 (290)											12.4 (315)	5.31 (135)		
40	40																
50	50	20.87 (530)	16.93 (430)	0.59 (15)	39.37 (1000)	38.19 (970)	14.17 (360)	7.09 (180)	7.09 (180)	0.59 (15)							
60	75										26.77 (680)	11.42 (290)	17.32 (440)	10.24 (260)			
—	100	34.65 (880)	10.24 (260)										19.69 (500)	12.33 (313.2)	7.35 (186.8)		
75	125																
100	125	20.87 (530)	16.93 (430)	0.25 (6.4)	55.12 (1400)	53.94 (1370)	17.32 (440)	10.24 (260)	7.35 (186.8)	0.25 (6.4)							
—	150	26.77 (680)	11.42 (290)								61.02 (1550)	59.84 (1520)					
—	200												39.37 (1000)	11.81 (300)			
—	250																
—	300	34.65 (880)	10.24 (260)	0.59 (15)	55.12 (1400)	53.94 (1370)	17.32 (440)	10.24 (260)	7.35 (186.8)	0.25 (6.4)							
—	350										39.37 (1000)	11.81 (300)					
—	450	55.12 (1400)	53.94 (1370)														
—	500																
—	600	34.65 (880)	10.24 (260)	0.59 (15)	55.12 (1400)	53.94 (1370)	17.32 (440)	10.24 (260)	7.35 (186.8)	0.25 (6.4)							
—	700										39.37 (1000)	11.81 (300)					
—	800	55.12 (1400)	53.94 (1370)														
—	900																
—	1000																

40 HP or below

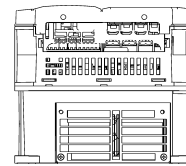
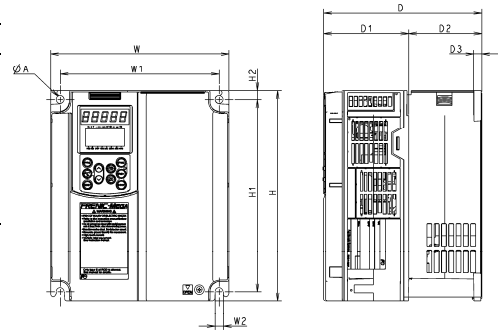

50 HP or above

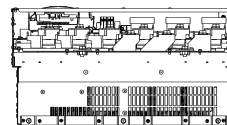
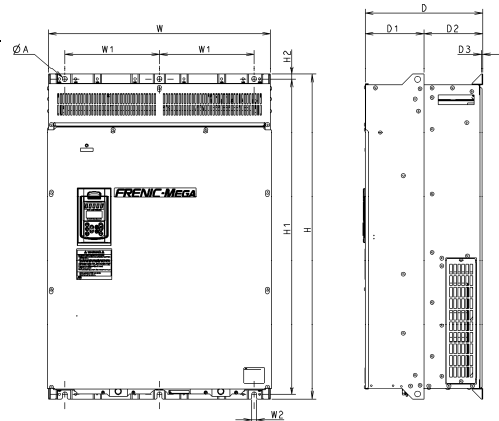

8.4.2 Panel cutting of standard model (50 HP or above)

Inverter type FRN_ _ _G1S-2U/4U		Refer to:	Dimensions inch (mm)							
230V	460V		W3	W4	W5	H3	H4	H5	B	
50	50	Figure A	12.28 (312)	11.34 (288)	9.45 (240)	20.87 (530)	20.16 (512)	0.35 (9)	M8	
-	60		13.66 (347)	12.72 (323)	10.83 (275)	23.43 (595)	22.72 (577)			
60	-					25.79 (655)	25.08 (637)			
-	75			28.35 (720)		27.64 (702)				
-	100									
75	-		20.08 (510)	16.93 (430)	16.93 (430)	27.36 (695)				
100	-		Figure B	25.98 (660)	11.42 (290)	-	33.46 (850)			32.48 (825)
-	125									
125	-	Figure A	20.08 (510)	16.93 (430)	16.93 (430)	27.95 (710)	26.97 (685)			
-	150					38.19 (970)	37.2 (945)			
-	200									
-	250									
-	300	Figure B	25.98 (660)	11.42 (290)	-	53.94 (1370)	53.07 (1348)	0.43 (11)		
-	350		26.14 (664)			59.84 (1520)	58.66 (1490)			
-	450									
-	500									
-	600	Figure C	34.02 (864)	10.24 (260)	-	59.84 (1520)	58.66 (1490)	0.57 (14.5)		
-	700		38.58 (980)	11.81 (300)						
-	800									
-	900									
-	1000									

Figure A

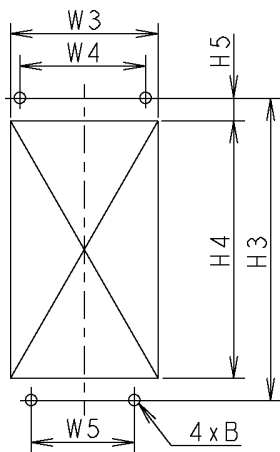

Figure B

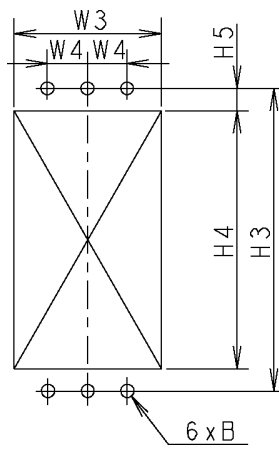
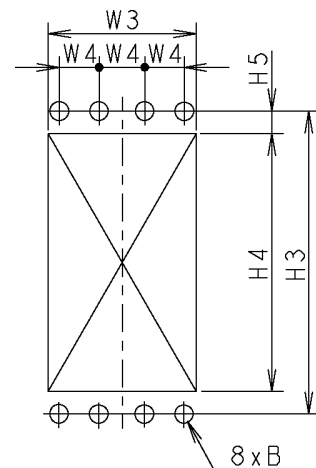

Figure C



8.4.3 DC reactor (DCR)

Power supply voltage	Inverter type FRN--G1S -2U/4U	Option/ Standard	Reactor	Refer to:	Dimensions inch (mm)									Mass lb (kg)		
					W	W1	D	D1	D2	D3	H	Mounting hole	Terminal hole			
230 V	F50	Option	DCR2-0.4	Figure A	2.6 (66)	2.2 (56)	3.54 (90)	2.83 (72)	0.59 (15)	-	3.7 (94)	0.2×0.31 (5.2×8)	M4	0.04 (1)		
	001		DCR2-0.75						0.79 (20)					0.06 (1.4)		
	002		DCR2-1.5											0.06 (1.6)		
	003		DCR2-2.2		3.39 (86)	2.8 (71)	-	-	-	-	4.33 (110)	0.24×0.35 (6×9)	-	0.07 (1.8)		
	005		DCR2-3.7											0.39 (10)	0.1 (2.6)	
	007		DCR2-5.5		4.37 (111)	3.74 (95)	3.94 (100)	3.15 (80)	0.79 (20)	-	-	-	5.12 (130)	-	-	0.14 (3.6)
	010		DCR2-7.5						0.91 (23)							0.15 (3.8)
	015		DCR2-11						0.94 (24)							0.17 (4.3)
	020		DCR2-15		5.75 (146)	4.88 (124)	4.72 (120)	3.78 (96)	0.59 (15)	-	-	-	7.09 (180)	0.28×0.43 (7×11)	-	0.23 (5.9)
	025		DCR2-18.5						0.98 (25)							0.29 (7.4)
	030	DCR2-22A		0.3 (7.5)												
	040	DCR2-30B	Standard	DCR2-30B	Figure B	5.98±0.12 (152±3)	3.54±0.04 (90±1)	6.14±0.12 (156±3)	4.57±0.08 (116±2)	4.53 (115)	3.07±0.2 (78±5)	5.12 (130)	0.31 (8)	M10	0.47 (12)	
	050	DCR2-37C		8.27±0.39 (210±10)		7.28 (185)	3.98±0.08 (101±2)	3.19 (81)	4.92 (125)	1.99±0.04 (50.5±1)	4.92 (125)	-	-		-	-
	060	DCR2-45C					4.17±0.08 (106±2)	3.39 (86)	5.31 (135)	2.09±0.04 (53±1)				M6		
	075	DCR2-55C		10.04±0.39 (255±10)		8.86 (225)	3.78±0.08 (96±2)	2.99 (76)	5.51 (140)	1.89±0.04 (48±1)	5.71 (145)	-	-		-	-
	100	DCR2-75C					4.17±0.08 (106±2)	3.39 (86)	5.71 (145)	2.09±0.04 (53±1)	M12			25 (11.4)		
	125	DCR2-90C					4.57±0.08 (116±2)	3.78 (96)	6.1 (155)	2.28±0.04 (58±1)				5.71 (145)		
150	DCR2-110C	11.81±0.39 (300±10)		10.43 (265)		4.57±0.16 (116±4)	3.54 (90)	7.28 (185)	2.28±0.04 (58±1)	6.3 (160)	M8	37 (17)				

Note: 100 HP or above type comes with a DC reactor (DCR) suitable for the LD-mode use.

Power supply voltage	Inverter type FRN___G1S -2U/4U	Option/ Standard	Reactor	Refer to:	Dimensions inch (mm)									Mass lb (kg)		
					W	W1	D	D1	D2	D3	H	Mounting hole	Terminal hole			
460 V	F50	Option	DCR4-0.4	Figure A	2.6 (66)	2.2 (56)	3.54 (90)	2.83 (72)	0.59 (15)	-	3.7 (94)	0.2×0.31 (5.2×8)	M4	0.04 (1)		
	001		DCR4-0.75						0.79 (20)					0.06 (1.4)		
	002		DCR4-1.5						0.59 (15)					0.06 (1.6)		
	003		DCR4-2.2						0.79 (20)					0.08 (2)		
	005		DCR4-3.7						4.33 (110)					0.24×0.35 (6×9)	0.1 (2.6)	
	007		DCR4-5.5						0.94 (24)							
	010		DCR4-7.5		5.12 (130)		0.17 (4.2)									
	015		DCR4-11		6.61 (168)	0.28×0.43 (7×11)	0.17 (4.3)									
	020		DCR4-15		6.73 (171)		0.23 (5.9)									
	025		DCR4-18.5													
	030		DCR4-22A													
	040		DCR4-30B		Figure B	5.98±0.12 (152±3)	3.54±0.04 (90±1)	6.18±0.12 (157±3)	4.53±0.08 (115±2)	4.33 (110)	3.07±0.2 (78±5)	5.12 (130)	0.31 (8)			0.51 (13)
	050		DCR4-37C		Figure C	8.27±0.39 (210±10)	7.28 (185)	3.98±0.08 (101±2)	3.19 (81)	4.13 (105)	1.99±0.04 (50.5±1)	4.92 (125)	M8			0.29 (7.4)
	060		DCR4-45C					4.17±0.08 (106±2)	3.39 (86)	4.72 (120)	2.09±0.04 (53±1)			0.33 (8.4)		
	075	DCR4-55C	10.04±0.39 (255±10)	8.86 (225)		3.78±0.08 (96±2)	2.99 (76)	4.92 (125)	1.89±0.04 (48±1)	5.71 (145)	M6	M10			0.41 (10.3)	
	100	DCR4-75C				4.17±0.08 (106±2)	3.39 (86)	4.92 (125)	2.09±0.04 (53±1)	5.71 (145)			27 (12.4)			
	125	DCR4-90C	11.81±0.39 (300±10)	10.43 (265)		4.57±0.08 (116±2)	3.78 (96)	5.51 (140)	2.28±0.04 (58±1)	6.1 (155)	M8	M12			32 (14.7)	
	150	DCR4-110C				3.54 (90)	6.89 (175)	6.3 (160)	41 (18.4)							
	200	DCR4-132C				4.96±0.16 (126±4)	3.94 (100)	7.09 (180)	2.48±0.08 (63±2)				6.3 (160)	49 (22)		
	250	DCR4-160C				5.16±0.16 (131±4)	4.06 (103)	2.58±0.08 (65.5±2)	7.48 (190)				56 (25.5)			
	300	DCR4-200C	13.78±0.39 (350±10)	12.2 (310)		5.55±0.16 (141±4)	4.45 (113)	7.28 (185)	2.78±0.08 (70.5±2)	7.48 (190)	M10	M10			65 (29.5)	
	350	DCR4-220C				5.75±0.16 (146±4)	4.65 (118)	7.87 (200)	2.87±0.08 (73±2)				72 (32.5)			
	450	DCR4-280C	Standard	13.78±0.39 (350±10)	12.2 (310)	6.34±0.16 (161±4)	5.24 (133)	8.27 (210)	3.17±0.08 (80.5±2)	7.48 (190)	M16			79 (36)		
	500	DCR4-355C				6.14±0.16 (156±4)	5.04 (128)	7.87 (200)	3.07±0.04 (78±1)	8.86 (225)		104 (47)				
	600	DCR4-400C		17.52±0.39 (445±10)	15.16 (385)	5.71±0.16 (145±4)	4.61 (117)	8.39 (213)	2.85±0.04 (72.5±1)	9.65 (245)	M10	Ø15			115 (52)	
	700	DCR4-450C				5.91±0.16 (150±4)	4.8 (122)	8.46 (215)	2.95±0.08 (75±2)				132 (60)			
	800	DCR4-500C				5.71±0.16 (145±10)	15.35 (390)	6.5±0.16 (165±4)	5.39 (137)				8.66 (220)	3.25±0.08 (82.5±2)	154 (70)	
	900	DCR4-630C				11.22±0.39 (285±10)	5.71 (145)	7.99±0.16 (203±4)	6.69 (170)				7.68 (195)	4.09±0.08 (104±2)	18.9 (480)	165 (75)
	1000	DCR4-710C		Figure E	13.39±0.39 (340±10)	6.3 (160)	11.61±0.1 (295±4)	10.04 (255)	8.86 (225)	4.21±0.08 (107±2)		M12			209 (95)	

Note: 100 HP or above type comes with a DC reactor (DCR) suitable for the LD-mode use.

Figure A

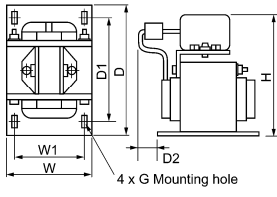

Figure B

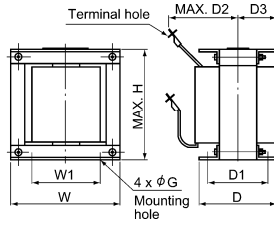

Figure C

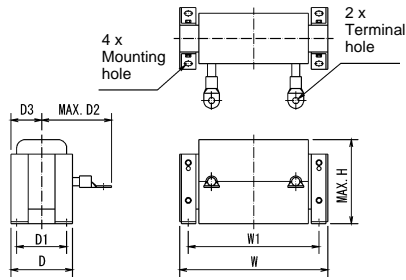

Figure D

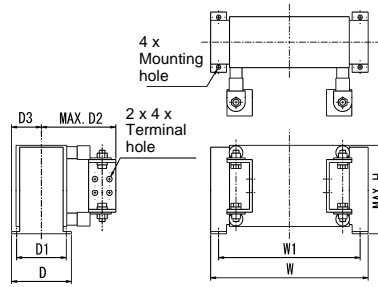
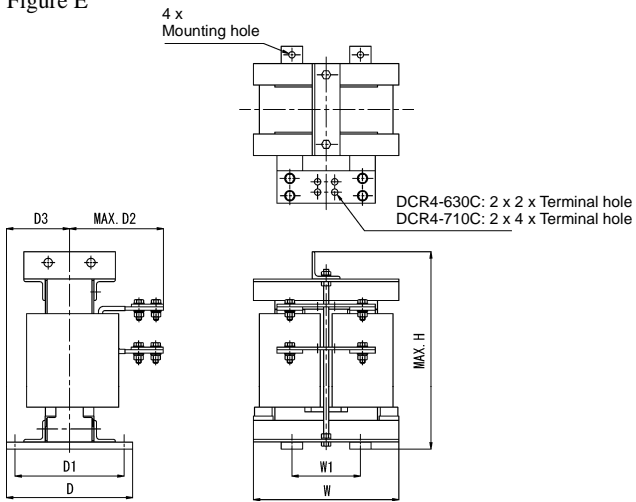

Figure E



8.4.4 DCR built-in type

Inverter type FRN__G1H-2U/4U		Dimensions inch (mm)																Mounting hole φA1	Mounting hole φA2		
230 V	460 V	W	W1	W2	W3	W4	W5	W6	H	H1	H2	H3	H4	H5	H6	D	D1			D2	D3
7.5	7.5	8.66 (220)	5.49 (139.4)	1.59 (40.3)	1.59 (40.3)	7.72 (196)	4.17 (106)	0.39 (10)	12.6 (320)	10.24 (260)	1.18 (30)	9.37 (238)	11.7 (298)	0.43 (11)	10.63 (270)	4.06 (103)	6.56 (166.5)	0.43 (10.8)	0.39 (10)	0.39 (10)	
10	10																				
15	15																				
20	20																				
25	25	9.84 (250)	5.75 (146)	115 (52)	115 (52)	8.9 (226)	4.41 (112)	0.39 (10)	18.1 (460)	15.75 (400)	1.18 (30)	14.88 (378)	17.32 (440)	0.39 (10)	10.63 (270)	4.06 (103)	6.56 (166.5)	0.43 (10.8)	0.39 (10)	0.39 (10)	
30	30																				
40	40																				
50	50	12.6 (320)	-	-	-	9.45 (240)	-	0.39 (10)	21.65 (550)	-	-	20.87 (530)	-	-	10.04 (255)	4.53 (115)	6.1 (155)	0.16 (4)	0.39 (10)	-	
60	60																				
-	100	13.98 (355)	-	-	-	10.83 (275)	-	0.39 (10)	24.21 (615)	-	-	23.43 (595)	0.47 (12)	-	-	10.63 (270)	4.53 (115)	6.1 (155)	0.16 (4)	0.39 (10)	-
75	75																				
75	75																				
100	100																				

40 HP or below

Note: The DCR built-in type of inverters of 40 HP or below cannot employ external cooling.

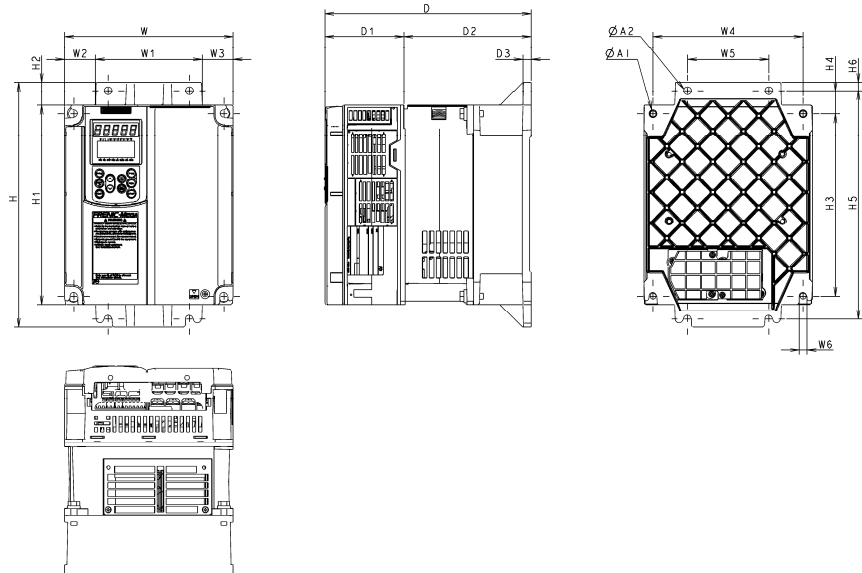

50 HP or above

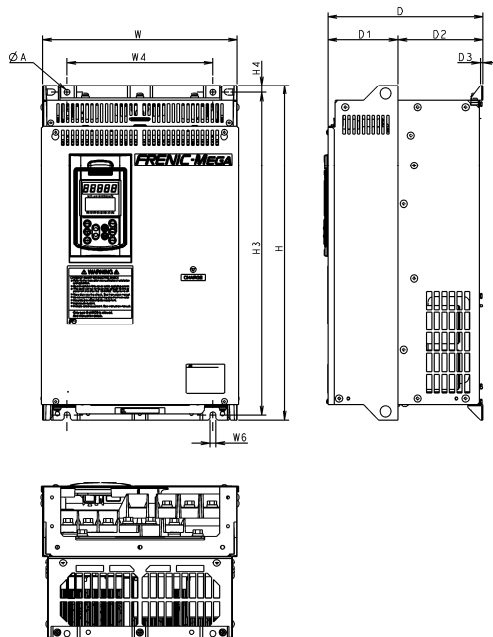

8.4.5 Standard models with NEMA1 kit (option)

Inverter type FRN__GIS-2U/4U		Dimensions inch (mm)		
230 V	460 V	W	H	D
0.5	0.5	4.45 (113)	12.2 (310)	5.26 (133.5)
1	1			5.76 (146.3)
2	2	5.87 (149)	12.2 (310)	5.76 (146.2)
3	3			
5	5			
7.5	7.5	8.66 (220)	13.24 (336.2)	7.68 (195)
10	10			
15	15			
20	20	9.84 (250)	19.27 (490)	7.68 (195)
25	25		22.05 (560)	
30	30		19.27 (490)	
—	40	12.73 (323.4)	26.97 (685)	10.04 (255)
50	50			
60	—			
—	60	12.73 (323.4)	26.97 (685)	10.04 (255)
75	—	14.11 (358.4)	34.84 (885)	10.63 (270)
—	75		29.92 (760)	
100	—		34.84 (885)	
—	100		32.28 (820)	
125	—	21 (533.4)	37.8 (960)	11.22 (285)
—	125	14.11 (358.4)	34.84 (885)	10.63 (270)
150	—	26.91 (683.4)	46.46 (1180)	14.17 (360)
—	150	21 (533.4)	35.43 (900)	12.4 (315)
—	200			
—	250			
—	300			
—	350	26.91 (683.4)	51.18 (1300)	14.17 (360)
—	450	26.94 (684.2)	63.78 (1620)	
—	500	34.81 (884.2)	64.17 (1630)	17.39 (441.6)
—	600			
—	700	39.54 (1004.2)	64.57 (1640)	19.75 (501.6)
—	800			
—	900	39.54 (1004.2)	64.57 (1640)	19.75 (501.6)
—	1000			

40 HP or below

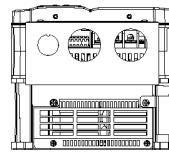
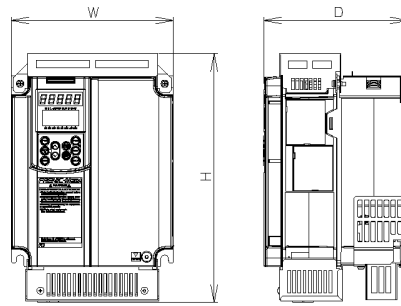

50 HP or above

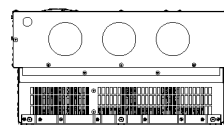
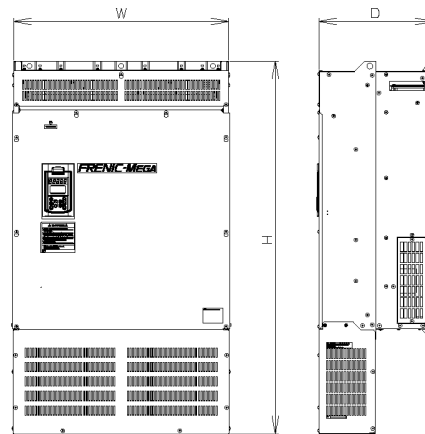

Note: Standard models with NEMA1 kit cannot employ external cooling.

8.4.6 Keypad (TP-G1W-J1)

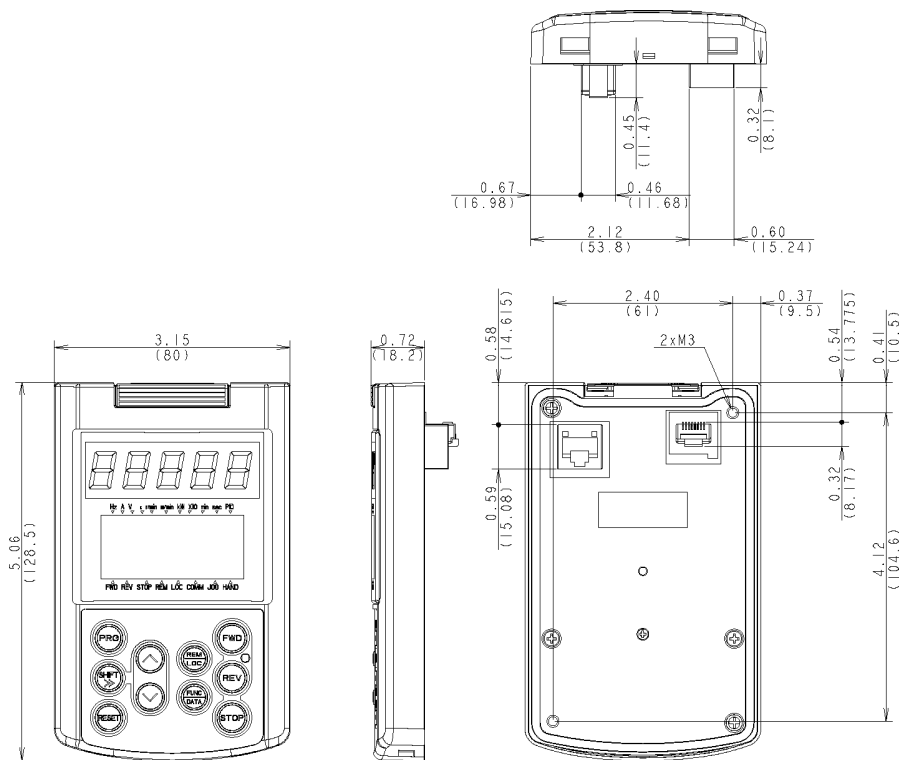

Drill four screw holes and cut a square hole in a panel as specified below.

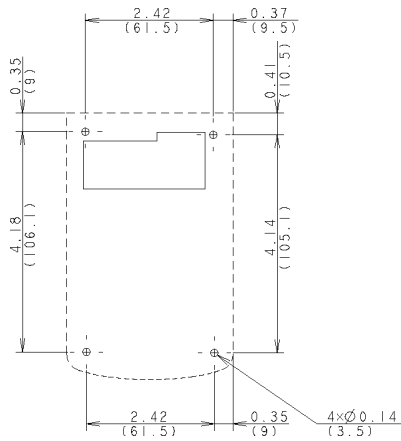

Location of Screw Holes in Panel (viewed from back)

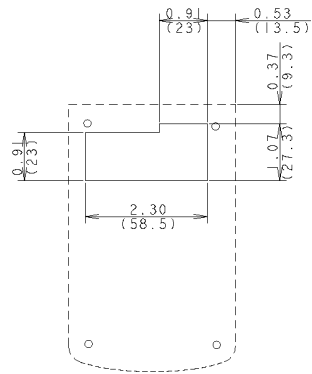

Dimensions of Panel Cutting

Chapter 9 CONFORMITY WITH STANDARDS

9.1 Compliance with UL Standards and Canadian Standards (cUL certification)

9.1.1 General

Originally, the UL standards were established by Underwriters Laboratories, Inc. as private criteria for inspections/investigations pertaining to fire/accident insurance in the USA. Later, these standards were authorized as the official standards to protect operators, service personnel and the general populace from fires and other accidents in the USA.

cUL certification means that UL has given certification for products to clear CSA Standards. cUL certified products are equivalent to those compliant with CSA Standards.

9.1.2 Considerations when using FRENIC-MEGA in systems to be certified by UL and cUL

If you want to use the FRENIC-MEGA series of inverters as a part of UL Standards or CSA Standards (cUL certified) certified product, refer to the related guidelines described on pages ix to xvi.

9.2 Compliance with European Standards

The CE marking on Fuji products indicates that they comply with the essential requirements of the Electromagnetic Compatibility (EMC) Directive 2004/108/EC and Low Voltage Directive 2006/95/EC which are issued by the Council of the European Communities

The products comply with the following standards

	Basic type
EMC Directives	Depends upon a filter dedicated to Fuji inverters*
Low Voltage Directive	EN61800-5-1: 2007
Safety Standard	EN954-1: Category 3

*The basic type of inverters that bear a CE marking but have no built-in EMC filter becomes compliant with these EMC Directives.

9.3 Compliance with EMC Standards

9.3.1 General

The CE marking on inverters does not ensure that the entire equipment including our CE-marked products is compliant with the EMC Directive. Therefore, CE marking for the equipment shall be the responsibility of the equipment manufacturer. For this reason, Fuji's CE mark is indicated under the condition that the product shall be used within equipment meeting all requirements for the relevant Directives. Instrumentation of such equipment shall be the responsibility of the equipment manufacturer.

Generally, machinery or equipment includes not only our products but other devices as well. Manufacturers, therefore, shall design the whole system to be compliant with the relevant Directives.

In addition, to satisfy the requirements noted above, use the combination of the basic type of inverters that have no built-in EMC filter and an external filter (option) dedicated to Fuji inverters. In this case, mount inverters in accordance with the installation procedure given below. To ensure the compliance, it is recommended that inverters be mounted in a metal panel.

 **Tip** Our EMC compliance test is performed under the following conditions.
Wiring length (of the shielded cable) between the inverter and motor: 16.4 ft (5 m)

 **Note** To use Fuji inverters in combination with a PWM converter, the basic type of inverters having no built-in EMC filter should be used. Use of an EMC filter built-in type may increase heat of capacitors in the inverter, resulting in a break. In addition, the effect of the EMC filter can no longer be expected.

9.3.2 Recommended installation procedure

To make the machinery or equipment fully compliant with the EMC Directive, have certified technicians wire the motor and inverter in strict accordance with the procedure described below.

■ In case an EMC-compliant filter (optional) is externally used

- 1) Mount the inverter and the filter on a grounded panel or metal plate. Use shielded wires for the motor cable and route the cable as short as possible. Firmly clamp the shields to the metal plate to ground them. Further, connect the shielding layers electrically to the grounding terminal of the motor.
- 2) For connection to inverter's control terminals and for connection of the RS-485 communication signal cable, use shielded wires. As with the motor, clamp the shields firmly to a grounded panel.
- 3) If noise from the inverter exceeds the permissible level, enclose the inverter and its peripherals within a metal panel as shown in Figure 9.1.

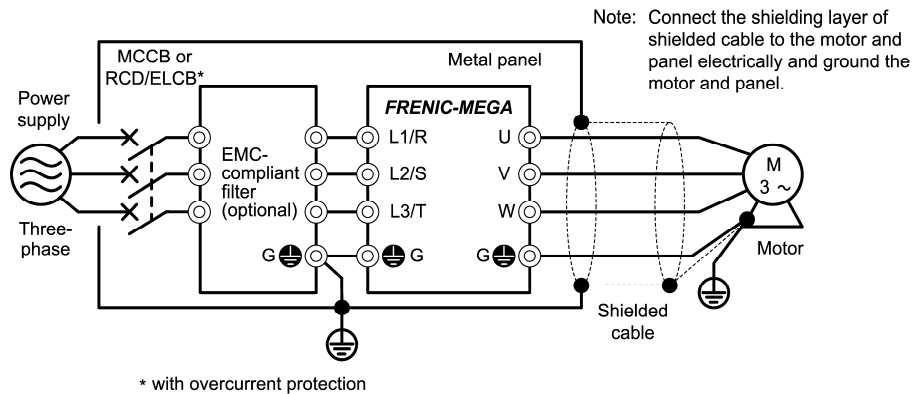

Figure 9.1 Mounting the Inverter with EMC-compliant Filter in a Metal Panel

9.4 Compliance with EN954-1, Category 3

9.4.1 General

In FRENIC-MEGA series of inverters, opening the hardware circuit between terminals [EN] and [PLC] stops the output transistor, coasting the motor to a stop. (EN: Enable input) This is the Safe Torque Off (STO) on prescribed in EN60204-1, Category 0 (Uncontrolled stop) and compliant with EN954-1, Category 3.

Note: Depending on applications, it may be necessary (for end-user) to apply additional measures, such as 'brake function', to prevent movement. Also protect against possible electrical hazard(s) at motor terminals.

Use of terminals [EN] and [PLC] eliminates the need of external safety circuit breakers while conventional inverters need those breakers to configure the EN954-1 Category 3 compliant safety system.

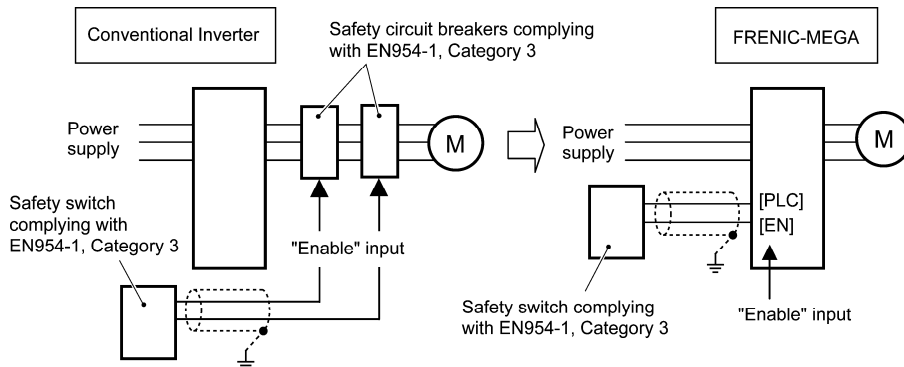

9.4.2 Notes for compliance to EN954-1 category 3

(1) Wiring for terminal [EN]

- When using terminal [EN], be sure to remove the short-circuit wire from terminals [EN] and [PLC], which has been connected at the shipment.
- '[EN] & [PLC]' terminals are safety related wire connections and therefore careful installation practices shall be applied to ensure no 'short-circuit(s)' can occur to these connections.
- For opening and closing the hardware circuit between terminals [EN] and [PLC], use safety approved components such as safety switches and safety relays that comply with EN954-1, Category 3 or higher to ensure a complete shutoff.
- Be sure to use shielded wires for connecting terminals [EN] and [PLC] and ground the shielding layer. Do not connect/mix any other control signal wire within the same shielded core.
- It is the responsibility of the machinery manufacturer to guarantee that a short-circuiting or other fault does not occur in wiring of external safety components between terminals [EN] and [PLC].

Fault examples:

- Terminals [EN] and [PLC] are short-circuited due to the wiring being caught in the door of the control panel so that a current continues to flow in terminal [EN] although the safety component is OFF and therefore the safety function will/may NOT operate
- The wiring is in contact with any other wire so that a current continues to flow in terminal [EN] and therefore the safety function will/may NOT operate

(2) Note for Safe Torque Off (STO)

- When configuring the product safety system with this Safe Torque Off (STO), make a risk assessment of not only the external equipment and wiring connected to terminal [EN] but also the whole system including other equipment, devices and wiring against the product safety system required by the machinery manufacturer under the manufacturer's responsibility in order to confirm that the whole system conforms to the product safety system required by the machinery manufacturer.

In addition, as preventive maintenance, the machinery manufacturer must perform periodical inspections to check that the product safety system properly functions.

- To make the inverter compliant with EN954-1, Category 3, it is necessary to install the inverter on a control panel with the enclosure rating of IP54 or above.

This Safe Torque Off (STO) coasts the motor to a stop. When a mechanical brake is used to stop or hold the motor for the sake of the product safety system of whole system, do not use the inverter's control signals such as output from terminal [Y]. (Using control signals does not satisfy the safety standards because of software intervention.) Use safety components complying with EN954-1, Category 3 or higher to activate mechanical brakes.

- The safety shutdown circuit between terminal [EN] input section and inverter's output shutdown section is dual-configured (redundant circuit) so that an occurrence of a single fault does not detract the Safe Torque Off (STO).

If a single fault is detected in the safety shutdown circuit, the inverter coasts the motor to a stop even with the terminal [EN]-[PLC] state being ON, as well as outputting an alarm to external equipment. (Note that the alarm output function is not guaranteed to all of single faults.)

- The Safe Torque Off (STO) may not completely shut off the power supply to the motor electrically. Before performing wiring or maintenance jobs, be sure to disconnect/isolate the input power to the inverter and wait at least 5 minutes for 40 HP or below of inverters, and at least 10 minutes for 50 HP or above.

(3) A test of Safe Torque Off (STO)

- In application where no regular activation of the Safe Torque Off (STO) is guaranteed, a test of the Safe Torque Off (STO) needs to be performed at least once a year.

9.4.3 EN954-1

European Standard EN954-1 (Safety of machinery–Safety related parts of control systems) prescribes the basic safety requirements for machinery categorized according to the requirement level. Category 3 represents the requirements that the machinery shall be designed with redundancy so that a single fault does not lead to the loss of the safety function. Table 9.3 shows an outline of the category levels and their safety requirements. (For detailed requirements refer to EN 954-1)

Table 9.3

Category	Summary of requirements	System behavior
B	Safety related parts of control systems and/or their safety devices and their components shall be designed, constructed, selected, assembled and combined in accordance with the relevant standards so that they can withstand the expected influence.	The occurrence of a fault can lead to the loss of the safety function.
1	Requirements of Category B shall apply. Well-ried safety principles and well-ried components shall be used.	The occurrence of a fault can lead to the loss of the safety function, but the probability of occurrence is lower than for Category B.
2	Requirements of Category 1 shall apply. The safety function shall be checked at intervals suitable for the machinery.	The occurrence of a fault can lead to the loss of the safety function between the checks.
3	Requirements of Category 1 shall apply. Safety-related parts shall be designed, so that: - a single fault in any of these parts does not lead to the loss of the safety function, and - a single fault is detected whenever reasonably practicable.	When the single fault occurs, the safety function is still maintained. Accumulation of undetected faults can lead to the loss of the safety function.
4	Requirements of Category 1 shall apply. Safety-related parts shall be designed, so that a single fault is detected during or prior to the next demand on the safety function. If this is not possible, an accumulation of faults shall not lead to the loss of the safety function.	When faults occur, the safety function is still maintained.

MEMO

High Performance, Multifunction Inverter

FRENIC-MEGA

Instruction Manual

First Edition, April 2010
Second Edition, April 2011
Fuji Electric Co., Ltd.
Fuji Electric Corp. of America

The purpose of this instruction manual is to provide accurate information in handling, setting up and operating of the FRENIC-MEGA series of inverters. Please feel free to send your comments regarding any errors or omissions you may have found, or any suggestions you may have for generally improving the manual.

In no event will Fuji Electric Corp. of America be liable for any direct or indirect damages resulting from the application of the information in this manual.

Fuji Electric Co., Ltd.
Fuji Electric Corp. of America

<http://www.fujielectric.com/fecoa>
