

*FRENIC-Eco*

# Multi-function Keypad "TP-G1"

---

## **CAUTION**

Thank you for purchasing our Multi-function Keypad TP-G1.

- This product is designed to remotely control the FRENIC-Eco series of inverters. Read through this instruction manual and be familiar with the handling procedure for correct use.
- Improper handling blocks correct operation or causes a short life or failure.
- Deliver this manual to the end user of the product. Keep this manual in a safe place until the Multi-function Keypad is discarded.
- For the usage of inverters and optional equipment, refer to the instruction manuals prepared for the FRENIC-Eco series of inverters and its optional equipment.

Copyright © 2004 Fuji Electric FA Components & Systems Co., Ltd.

All rights reserved.

No part of this publication may be reproduced or copied without prior written permission from Fuji Electric FA Components & Systems Co., Ltd.

All products and company names mentioned in this manual are trademarks or registered trademarks of their respective holders.

The information contained herein is subject to change without prior notice for improvement.

## Preface

Thank you for purchasing our Multi-function Keypad "TP-G1."

By installing a TP-G1 Multi-function Keypad directly on a FRENIC-Eco series inverter as an attached keypad or connecting them together using an optional Remote Operation Extension Cable (CB-5S, CB-3S, or CB-1S, depending on the distance), you can operate the inverter locally or remotely. In either mode, you can, in the same way as with a standard built-in keypad, run and stop the motor, monitor the running status, and set the function codes. In addition, you can perform "data copying": You can read function code data from an inverter, copy (write) it into another inverter, or verify it.

Before installing and using the Multi-function Keypad, read through this manual in conjunction with the FRENIC-Eco Instruction Manual and familiarize yourself with its proper use. Improper use may prevent normal operation or cause a failure or reduced life of the inverter.

### Related Publications

Listed below are other publications on the FRENIC-Eco to be consulted in conjunction with this manual as necessary.



- FRENIC-Eco User's Manual (MEH456)
- RS485 Communication User's Manual (MEH448a)
- Catalog (MEH442)
- FRENIC-Eco Instruction Manual (INR-SI47-0882-E)
- RS485 Communications Card "OPC-F1-RS" Installation Manual (INR-SI47-0872)
- Relay Output Card "OPC-F1-RY" Instruction Manual (INR-SI47-0873)
- Mounting Adapter for External Cooling "PB-F1" Installation Manual (INR-SI47-0880)
- Panel-mount Adapter "MA-F1" Installation Manual (INR-SI47-0881)
- FRENIC Loader Instruction Manual (INR-SI47-0903-E)

The materials are subject to change without notice. Be sure to obtain the latest editions for use.

## ■ Safety precautions

Read this manual thoroughly before proceeding with installation, connections (wiring), operation, or maintenance and inspection. Ensure you have sound knowledge of the device and familiarize yourself with all safety information and precautions before proceeding to operate the inverter.

Safety precautions are classified into the following two categories in this manual.

 <b>WARNING</b>	Failure to heed the information indicated by this symbol may lead to dangerous conditions, possibly resulting in death or serious bodily injuries.
 <b>CAUTION</b>	Failure to heed the information indicated by this symbol may lead to dangerous conditions, possibly resulting in minor or light bodily injuries and/or substantial property damage.

Failure to heed the information contained under the CAUTION title can also result in serious consequences. These safety precautions are of utmost importance and must be observed at all times.

## Operation

### **WARNING**

- Be sure to install the terminal block cover and the front cover before turning the power on. Do not remove the covers while power is applied.

**Otherwise electric shock could occur.**

- Do not operate switches/buttons with wet hands.

**Doing so could cause electric shock.**

- If the retry function has been selected, the inverter may automatically restart and drive the motor depending on the cause of tripping.  
(Design the machinery or equipment so that human safety is ensured after restarting.)
- If the stall prevention function has been selected, the inverter may operate at an acceleration/deceleration time or frequency different from the set ones. Design the machine so that safety is ensured even in such cases.

**Otherwise an accident could occur.**

- The STOP key is effective only when function setting (Function code F02) has been established to enable the STOP key. Prepare an emergency stop switch separately. If you disable the STOP key priority function and enable operation by external commands, you cannot emergency-stop the inverter using the STOP key on the keypad.
- If an alarm reset is made with the operation signal turned on, a sudden start will occur. Ensure that the operation signal is turned off in advance.

**Otherwise an accident could occur.**

- If you enable the "restart mode after instantaneous power failure" (Function code F14 = 3, 4, or 5), then the inverter automatically restarts running the motor when the power is recovered.  
(Design the machinery or equipment so that human safety is ensured after restarting.)
- If you set the function codes wrongly or without completely understanding this instruction manual and the FRENIC-Eco User's Manual (MEH456), the motor may rotate with a torque or at a speed not permitted for the machine.

**An accident or injuries could occur.**

- Do not touch the inverter terminals while the power is applied to the inverter even if the inverter stops.

**Doing so could cause electric shock.**

## Wiring

### **WARNING**

- Do not operate the switch with wet hands.

**Doing so could cause electric shock.**

- Before opening the cover of the inverter to install the multi-functional keypad, turn off the inverter and wait for at least five minutes for models of 30 kW or below, or ten minutes for models of 37 kW or above. Further, make sure that the LED monitor is turned off, the charger indicator is off, and the DC link circuit voltage between the terminals P (+) and N (-) has dropped below the safe voltage level (+25 VDC), using a circuit tester or another appropriate instrument.

**Otherwise electric shock could occur.**

- In general, the insulation property of the sleeve of the signal wire and that of the sheath of the signal cable are not sufficient for high voltages. Therefore, if a signal wire or cable comes into direct contact with a live part of the main circuit, the insulation may be broken, causing the signal wire to be exposed to the high voltage of the main circuit. Be sure to keep all signal wires and cables away from live parts of the main circuit.

**Otherwise, an accident or electric shock could occur.**

## Disposal

### CAUTION

- For disposal, treat the Multi-functional Keypad as industrial waste.  
**Otherwise injuries could occur.**

## Others

### WARNING

- Never attempt to modify the Multi-function Keypad or inverter.  
**Doing so could cause electric shock or injuries.**

### GENERAL PRECAUTIONS

Drawings in this manual may be illustrated without covers or safety shields for explanation of detail parts. Restore the covers and shields in the original state and observe the description in the manual before starting operation.

## How this manual is organized

This manual is made up of chapters 1 through 4

### Chapter 1 BEFORE USING THE MULTI-FUNCTION KEYPAD "TP-G1"

This chapter describes the points to check upon delivery and lists the inverters the Multi-function Keypad is designed to interface with.

### Chapter 2 INSTALLATION AND INTERCONNECTION

This chapter describes how to install the Multi-function Keypad and how to interconnect it with an inverter.

### Chapter 3 OPERATION USING THE MULTI-FUNCTION KEYPAD "TP-G1"

This chapter describes the operation of the inverter using the Multi-function Keypad. More specifically, this chapter gives an overview of the inverter's three operation modes (Running, Programming, and Alarm modes) and describes how to run and stop the inverter/motor, set function code data, monitor running status, view maintenance information and alarm data, and perform data copying.

### Chapter 4 SPECIFICATIONS

This chapter lists the general specifications such as operating environments, communication specifications and transmission specifications.

## Icons

The following icons are used throughout this manual.

 **Note** This icon indicates information which, if not heeded, can result in the product not operating to full efficiency, as well as information concerning incorrect operations and settings which can result in accidents.

 This icon indicates a reference to more detailed information.

## Table of Contents

Preface .....	i	Chapter 4 SPECIFICATIONS .....	4-1
■ Safety precautions .....	i	4.1 General Specifications .....	4-1
How this manual is organized .....	iii	4.2 Communication Specifications .....	4-2
4.3 Transmission Specifications .....		4-2	
Chapter 1 BEFORE USING THE MULTI-FUNCTION KEYPAD "TP-G1" .....	1-1		
1.1 Acceptance Inspection .....	1-1		
1.2 Inverters with which the Multi-function Keypad Interfaces .....	1-1		
Chapter 2 INSTALLATION AND INTERCONNECTION ..	2-1		
2.1 Accessories and Parts Required for Interconnection .....	2-1		
2.2 Installing the TP-G1 Multi-function Keypad .....	2-2		
2.2.1 Three ways of installation/use .....	2-2		
2.2.2 Installing the TP-G1 multi-function keypad .....	2-3		
Chapter 3 OPERATION USING THE MULTI-FUNCTION KEYPAD .....	3-1		
3.1 Keys, LED, and LCD Monitors on the Keypad .....	3-1		
3.2 Overview of Operation Modes .....	3-4		
3.3 Running Mode .....	3-5		
3.3.1 Running/stopping the motor .....	3-5		
3.3.2 Setting up the frequency and PID process commands .....	3-8		
3.3.3 LED monitor (Monitoring the running status) .....	3-12		
3.4 Programming Mode .....	3-13		
3.4.1 Setting function codes – "1. Data Setting" .....	3-14		
3.4.2 Setting up function codes quickly using Quick setup – "0. QUICK SET" .....	3-17		
3.4.3 Checking changed function codes – "2. DATA CHECK" .....	3-17		
3.4.4 Monitoring the running status – "3. OPR MNTR" .....	3-18		
3.4.5 Checking I/O signal status – "4. I/O CHECK" .....	3-20		
3.4.6 Reading maintenance information – "5. MAINTENANC" .....	3-23		
3.4.7 Reading alarm information – "6. ALM INF" .....	3-26		
3.4.8 Viewing cause of alarm – "7. ALM CAUSE" .....	3-29		
3.4.9 Data copying – "8. DATA COPY" .....	3-31		
3.4.10 Measuring load factor – "9. LOAD FCTR" .....	3-38		
3.4.11 Changing function codes covered by Quick setup – "10. USER SET" .....	3-41		
3.4.12 Performing communication debugging – "11. COMM DEBUG" .....	3-42		
3.5 Alarm Mode .....	3-43		
3.6 Other Precautions .....	3-45		
3.6.1 Function code setting for F02 (Run and operation) .....	3-45		
3.6.2 Remote/local operation .....	3-45		
3.6.3 Tuning motor parameters .....	3-46		

# Chapter 1 BEFORE USING THE MULTI-FUNCTION KEYPAD "TP-G1"

## 1.1 Acceptance Inspection

Unpack the package and check the following:

- (1) The package contains a Multi-function Keypad and its instruction manual (this book).
- (2) There have been no problems during transportation. In particular, no parts are damaged or have fallen out of place nor are there any dents on the body.
- (3) The model name "TP-G1" is inscribed on the back of the Multi-function Keypad as shown in Figure 1.1.

If you suspect the product is not working properly or if you have any questions about your product, contact your Fuji Electric representative.

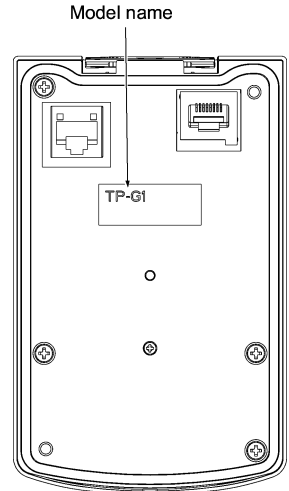

Figure 1.1 Back of Multi-function Keypad TP-G1

## 1.2 Inverters with which the Multi-function Keypad Interfaces

The Multi-function Keypad "TP-G1" interfaces with the following Fuji inverters:

Series	Type of inverter*	Remarks
FRENIC-Eco	FRN□□□F1S-□□ FRN□□□F1E-□□ FRN□□□F1H-□□  (Each □ has its meaning as shown below, represented by an alphanumeric character.)	The Multi-function Keypad is fully supported by inverters with a ROM version of F1S10300 or later. (You can check the inverter's ROM version by entering menu #5, "S- /4" in "Maintenance Information" in Programming Mode.)  There are restrictions on the support for the Multi-function Keypad by inverters with a ROM version of F1S10300 or earlier. For details, consult your Fuji Electric representative.

\* Type of inverter

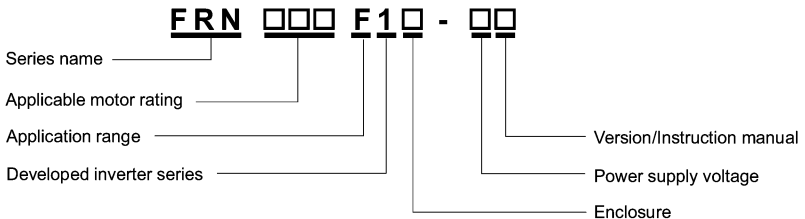

For the details of the Inverter type identification, refer to the FRENIC-Eco Instruction Manual (INR-SI47-0882-E), Chapter 1, Section 1.1 "Acceptance Inspection."

## Chapter 2 INSTALLATION AND INTERCONNECTION

### 2.1 Accessories and Parts Required for Interconnection

To install your TP-G1 Multi-function Keypad on the enclosure's panel instead of the inverter, you need the following accessories and parts:

Accessories/Parts	Type or Specifications	Remarks
Remote Operation Extension Cable (Note 1)	CB-5S, CB-3S, or CB-1S	You have a choice of three lengths: 5 m, 3 m, and 1 m.
Screws (for mounting the Multi-function Keypad)	M3 x □ (Note 2)	Provide 2 screws (to be provided by the customer) beforehand.

Note 1: Alternatively, you can use an off-the-shelf 10BASE-T/100BASE-TX LAN cable (straight type) that meets the ANSI/TIA/EIA-568A Category 5 standard (maximum length: 20 m).

Recommended LAN Cable:

Manufacturer: Sanwa Supply, Co. Ltd.

Model: KB-10T5-01K (for 1 m)

KB-STP-01K (for 1 m) (shielded cable, EMC-compliant)

Note 2: Use the screws of the length just right for the panel. (See Figure 2.7.)



## 2.2 Installing the TP-G1 Multi-function Keypad

### 2.2.1 Three ways of installation/use

You can install and/or use your TP-G1 in one of the following three ways:

- Install it directly on the inverter (see Figure 2.1).
- Install it on the front panel of enclosure (see Figure 2.2).
- Use it remotely in your hand (see Figure 2.3).

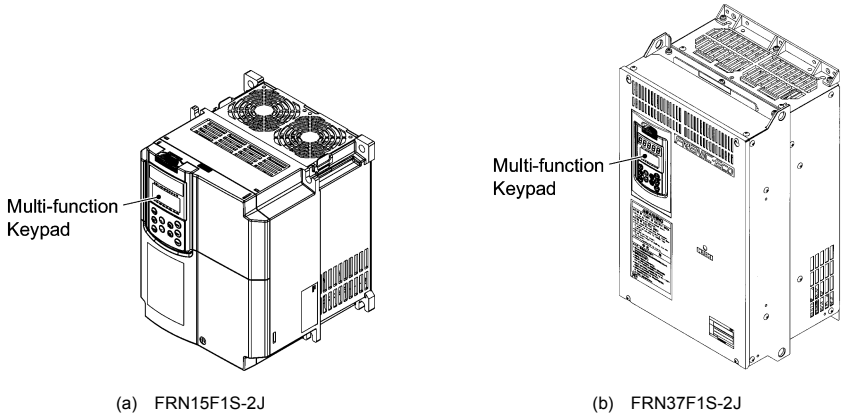

Figure 2.1 Installing Multi-function Keypad Directly on Inverter

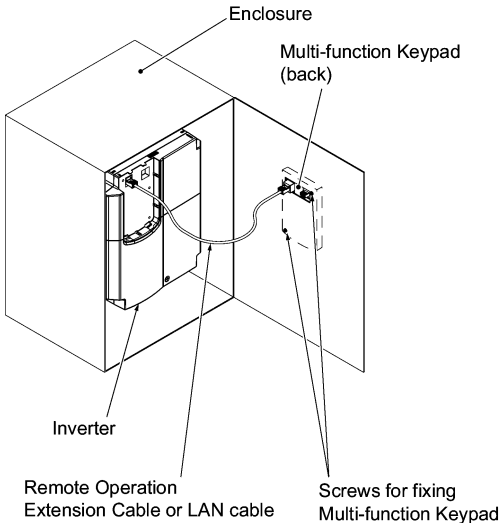

Figure 2.2 Installing Multi-function Keypad on Enclosure

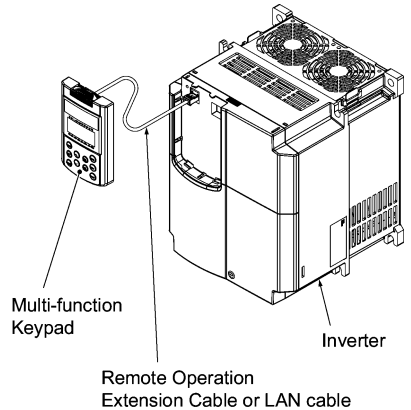

Figure 2.3 Using Multi-function Keypad remotely in Your Hand

## 2.2.2 Installing the TP-G1 multi-function keypad

After completion of interconnection, follow the next steps to install the multi-function keypad in place. Be sure to turn off the power of the inverter beforehand.

### ■ Installing the TP-G1 directly on the inverter

- ① Remove the standard keypad mounted on the inverter.

Pull the standard keypad toward you while holding down the hook (as directed by the arrows in Figure 2.4 below).

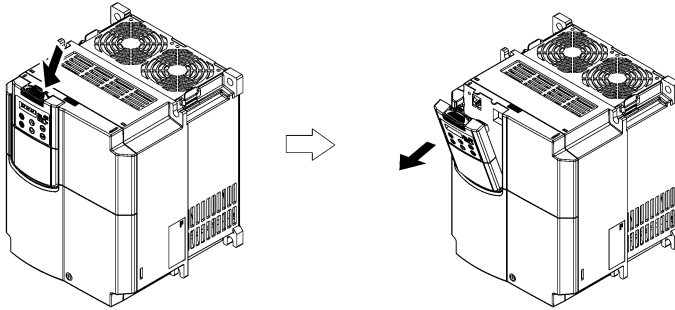

Figure 2.4 Removing the Standard Keypad

- ② Mount the TP-G1 Multi-function Keypad onto the inverter.

Put your TP-G1 Multi-function Keypad in the original slot while engaging its bottom latches with the holes (as shown below), and push it onto the case of the inverter (arrow ②) while holding it downward (against the terminal block cover) (arrow ①).

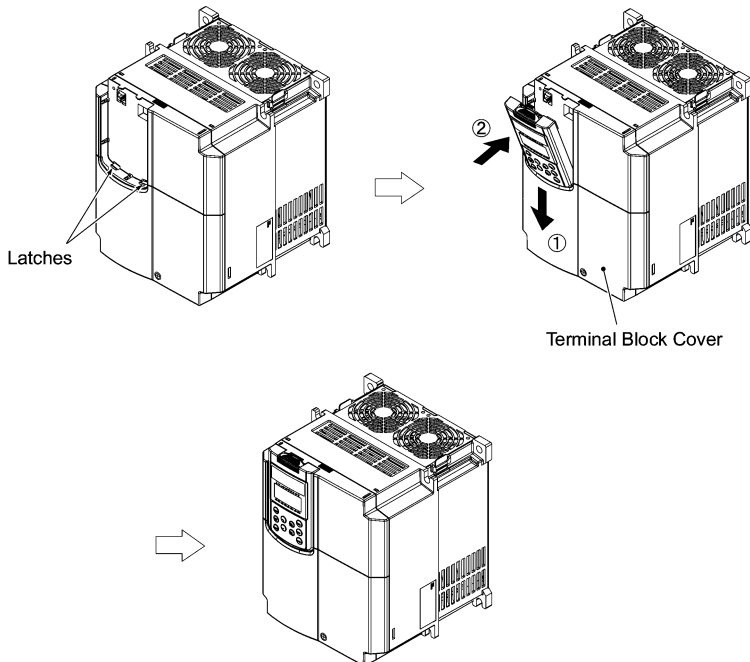



Figure 2.5 Mounting the Multi-function Keypad

<Protection from abnormal vibration: for inverters with capacity of 30 kW or less>

In an environment with large ambient vibrations, the inverter may be exposed to them, causing abnormal vibrations on the Multi-function Keypad. If this happens, remove the terminal block cover and the front cover and fix, using the keypad fixing screws attached to the inverter, the Multi-function Keypad.

 For the procedures for removing the covers, refer to the FRENIC-Eco Instruction Manual (INR-SI47-0882-E), Chapter 2, Section 2.3.1 "Removing and mounting the terminal block (TB) cover and the front cover."

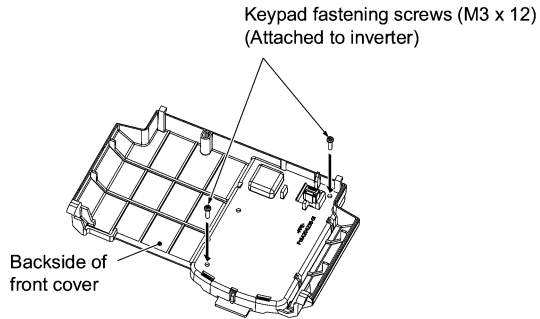
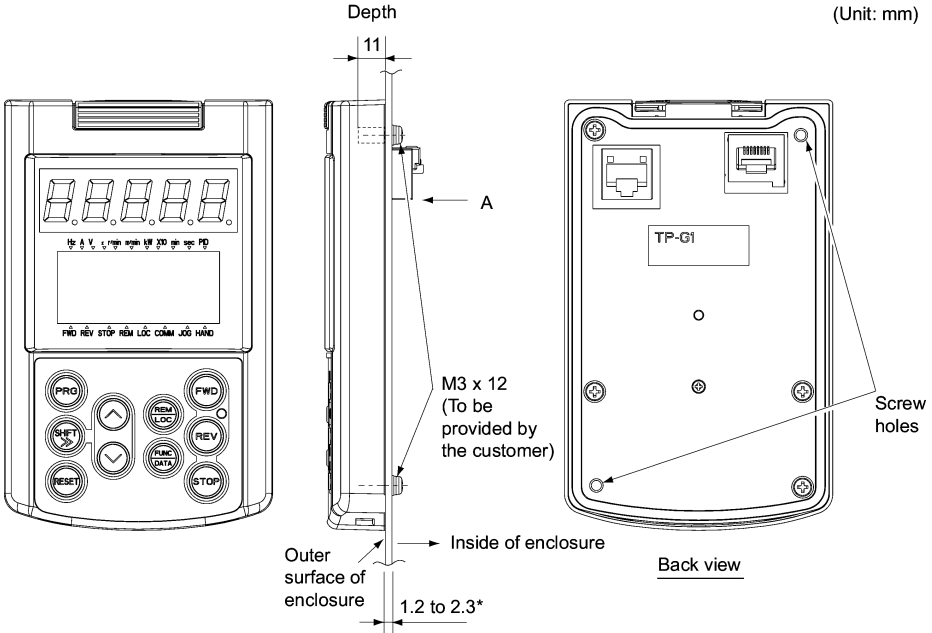

Figure 2.6 Fixing the Multi-function Keypad

■ Installing the multi-function keypad on the enclosure panel

- ① Cut the panel out for a single square area and perforate two screw holes on the panel of the enclosure as shown in Figure 2.7.



\*If the thickness of the enclosure is outside the range shown above, use screws of an appropriate length.

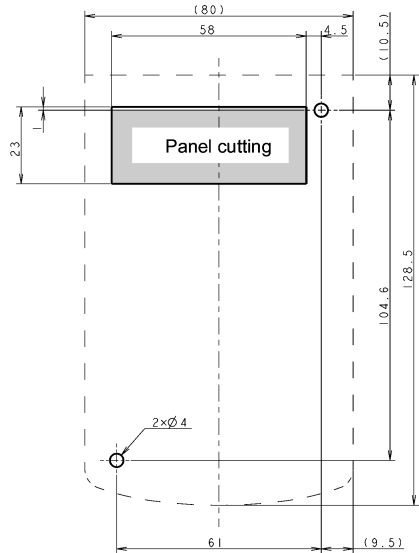

Dimensions of holes in enclosure (viewed from A)

Figure 2.7 Dimensions of Square Cut-out and Screw Holes

- ② Mount the Multi-function Keypad onto the enclosure with 2 screws as shown in Figure 2.8. (Recommended tightening torque: 0.7 N·m)

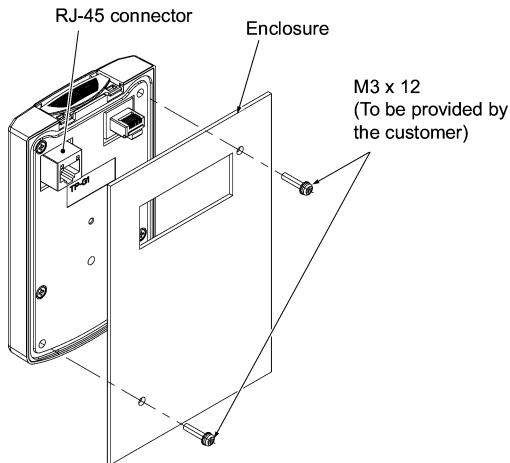

Figure 2.8 Mounting Multi-function Keypad

- ③ Remove the standard keypad mounted on the inverter (see Figure 2.4) and, using a Remote Operation Extension Cable or a LAN cable, interconnect the Multi-function Keypad and the Inverter (insert one end of the cable into the RS485 port with RJ-45 connector on the Multi-function Keypad and the other end into that on the inverter) (See Figure 2.9.).

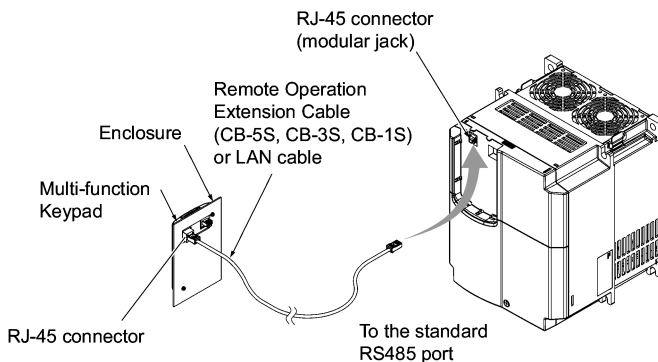

Figure 2.9 Connecting Multi-function Keypad to the Inverter with Remote Operation Extension Cable or an off-the-shelf LAN Cable

#### ■ Using the multi-function keypad in hand

Follow step ③ of "Installing the multi-function keypad on the enclosure panel" above.

# Chapter 3 OPERATION USING THE MULTI-FUNCTION KEYPAD

## 3.1 Key, LED, and LCD Monitors on the Keypad

The keypad allows you to start and stop the motor, view various data including maintenance information and alarm information, set function codes, monitor I/O signal status, copy data, and calculate the load factor.

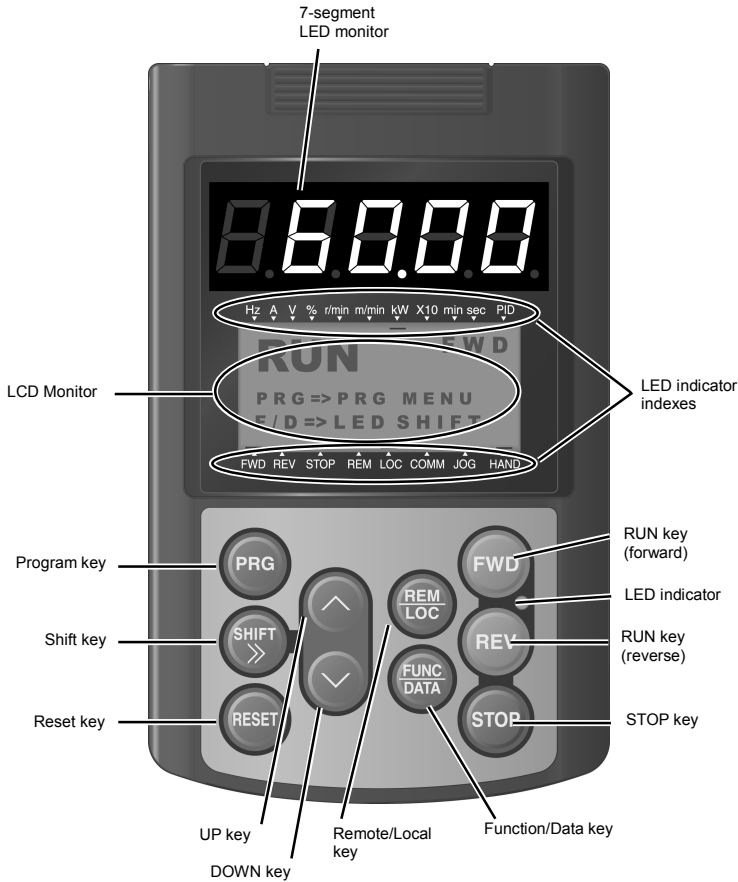





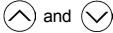





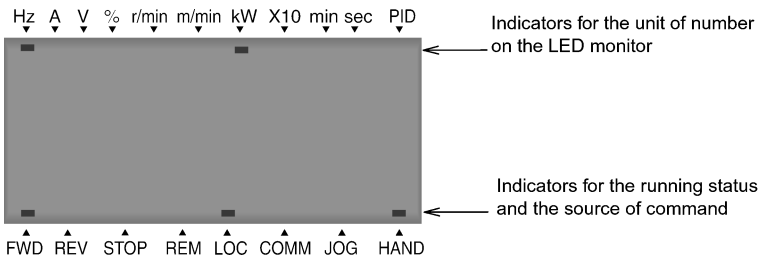

Table 3.1 Overview of Keypad Functions

Item	Monitor, LED indicator or Key	Functions
LED/LCD Monitor		<p>Five-digit, 7-segment LED monitor which displays the following according to the operation modes:</p> <ul style="list-style-type: none"> <li>■ In Running Mode: Running status information (e.g., output frequency, current, and voltage)</li> <li>■ In Programming Mode: same as above</li> <li>■ In Alarm Mode: Alarm code, which identifies the cause of alarm if the protective function is activated.</li> </ul>
		<p>LCD monitor which displays the following according to the operation modes:</p> <ul style="list-style-type: none"> <li>■ In Running Mode: Running status information</li> <li>■ In Programming Mode: Menus, function codes and their data</li> <li>■ In Alarm Mode: Alarm code, which identifies the cause of alarm if the protective function is activated.</li> </ul>
	LED indicator indexes	In running mode, display the unit of the number displayed on the LED monitor and the running status information shown on the LCD monitor. For details, see next page.
Keypad Operation Key		Switches the operation modes of the inverter.
		Shifts the cursor to the right when entering a number.
		<p>Pressing this key after removing the cause of an alarm will switch the inverter to Running Mode.</p> <p>Used to reset a setting or screen transition.</p>
		UP and DOWN keys. Used to select the setting items or change the function code data displayed on the LED monitor.
		<p>Function/Data key. Switches the operation as follows:</p> <ul style="list-style-type: none"> <li>■ In Running Mode: Pressing this key switches the information to be displayed concerning the status of the inverter (output frequency (Hz), output current (A), output voltage (V), etc.).</li> <li>■ In Programming Mode: Pressing this key displays the function code and confirms the data you have entered.</li> <li>■ In Alarm Mode: Pressing this key displays the details of the problem indicated by the alarm code that has come up on the LED monitor.</li> </ul>
Run Operation Key		Starts running the motor (forward rotation).
		Starts running the motor (reverse rotation).
		Stops the motor.
		Pressing this toggle key for more than 1 second switches between Local and Remote modes.
LED Indicator		Lights while a run command is supplied to the inverter.

Items Displayed on LED Indicators

Type	Item	Description (information, condition, status)
Unit of Number Displayed on LED Monitor	Hz	Output frequency, frequency command
	A	Output current
	V	Output voltage
	%	Calculated torque, load factor, speed
	r/min	Motor speed, set motor speed, load shaft speed, set load shaft speed
	m/min	Line speed, set line speed (Not applicable to FRENIC-Eco)
	kW	Input power, motor output
	X10	Data greater than 99,999
	min	Constant feeding rate time, constant feeding rate time setting (Not applicable to FRENIC-Eco)
	sec	Timer
	PID	PID process value
Operating Status	FWD	Running (forward rotation)
	REV	Running (reverse rotation)
	STOP	No output frequency
Source of Operation	REM	Remote mode
	LOC	Local mode
	COMM	Communication enabled (RS485 (standard, optional), field bus option)
	JOG	Jogging mode (Not applicable to FRENIC-Eco)
	HAND	Keypad effective (lights also in local mode)





### 3.2 Overview of Operation Modes

FRENIC-Eco features the following three operation modes:

- **Running Mode:** This mode allows you to enter run/stop commands in regular operation. You can also monitor the running status in real time.
- **Programming Mode:** This mode allows you to set function code data and check a variety of information relating to the inverter status and maintenance.
- **Alarm Mode:** If an alarm condition occurs, the inverter automatically enters the Alarm Mode. In this mode, you can view the corresponding alarm code\* and its related information on the LED and LCD Monitors.

\* Alarm code: Indicates the cause of the alarm condition that has triggered a protective function. For details, refer to the FRENIC-Eco Instruction Manual (INR-SI47-0882-E), Chapter 8, Section 8.5 "Protection Features."

Figure 3.1 shows the status transition of the inverter between these three operation modes.

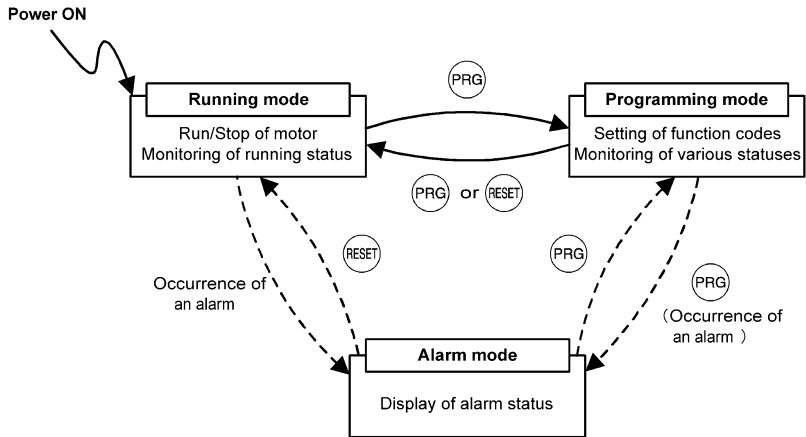

Figure 3.1 Status Transition between Operation Modes

### 3.3 Running Mode

When the inverter is turned on, it automatically enters Running Mode. In Running Mode, you can:

- [ 1 ] Run or stop the motor;
- [ 2 ] Set the frequency command and others;
- [ 3 ] Monitor the running status (e.g., output frequency, output current)

#### 3.3.1 Running/stopping the motor

By factory default, pressing the **FWD** key starts running the motor in the forward direction and pressing the **STOP** key decelerates the motor to stop. The **REV** key is disabled. You can run or stop the motor using the keypad only in Running mode and Programming mode.

To run the motor in reverse direction, or to run the motor in reversible mode, change the setting of function code F02.

For details of function code F02, refer to the FRENIC-Eco Instruction Manual (INR-SI47-0882-E), Chapter 5.

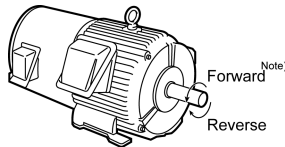

Figure 3.2 Rotational Direction of Motor

Note) The rotational direction of IEC-compliant motor is opposite to the one shown here.

#### ■ Display of running status (on LCD monitor)

(1) When function code E45 (LCD Monitor (optional)) is set to "0," the LCD Monitor displays the running status, the rotational direction, and the operation guide.

(The indicators above the LCD Monitor indicate the unit of the number displayed on the LED Monitor; the indicators underneath the LCD Monitor indicate the running status and the source of Run command.)

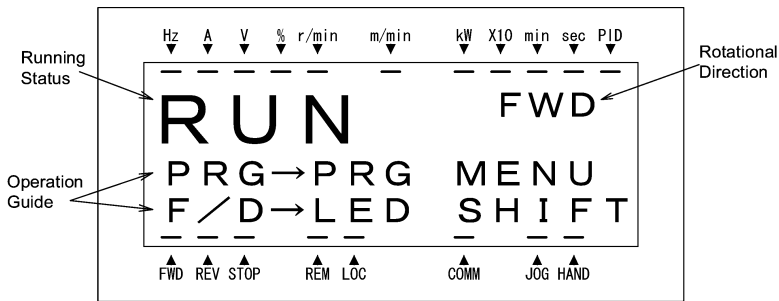

Figure 3.3 Display of Running Status

The running status and the rotational direction are displayed as shown in Table 3.2.

Table 3.2 Running Status and Rotational Direction

Status/Direction	Description
Running status	RUN: The Run command is present, or the inverter is driving the motor. STOP: The Run command is not present, or the inverter is in stopped state.
Rotational direction	FWD: Forward REV: Reverse Blank: Stopped

(2) When function code E45 (LCD Monitor (optional)) is set to "1," the LCD Monitor displays the output frequency, output current, and calculated torque in a bar chart.

(The indicators above the LCD Monitor indicate the unit of the number displayed on the LED Monitor; the indicators underneath the LCD Monitor indicate the running status and the source of Run command.)

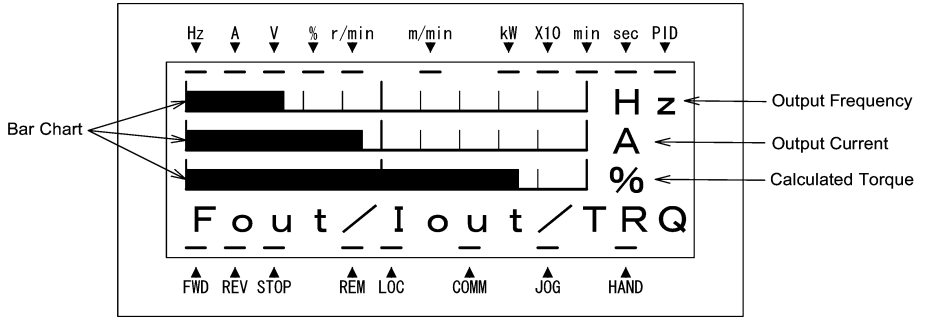

The full scale (maximum value) for each parameter is as follows:

- Output frequency: Maximum frequency
- Output current: 200% of inverter's rated current
- Calculated torque: 200% of rated torque generated by motor

Figure 3.4 Bar Chart

#### ■ Switching the operation mode between remote and local









The inverter can be operated either in remote mode or in local mode. In remote mode, which applies to normal operation, the inverter is driven under the control of the data settings held in it, whereas in local mode, which applies to maintenance operation, it is separated from the system and is driven manually under the control of the keypad.

**Remote mode:** The sources for setting run and frequency commands is determined by various setting means switching signals such as function codes, switching of run command 1/2, and link priority function.

**Local mode:** The sources for setting run and frequency commands is the keypad, regardless of the settings specified by function codes. The keypad takes precedence over the setting means specified by the run command 1/2 or the link priority function.

What follows shows the setting means of run command using the keypad in the local operation mode.

Table 3.3 Run Commands from the Keypad in the Local Operation Mode

If function code F02 is set to:	Setting means of the run command
0: Keypad	You can run/stop the motor using the  /  /  key on the keypad.
1: External signal	
2: Keypad (forward)	You can run/stop the motor using the  /  key on the keypad. You can run the motor in forward direction only. (The  key has been disabled.)
3: Keypad (reverse)	You can run/stop the motor using the  /  key on the keypad. You can run the motor in reverse direction only. (The  key has been disabled.)

The source for setting run and frequency commands can be switched between Remote and Local modes by the  key on the keypad. (This key is a toggle switch: Each time you press it for more than 1 second, the mode switches from Remote to Local or vice versa.)

The mode can be switched also by an external digital input signal. To enable the switching you need to assign (LOC) to one of the digital input terminals, which means that the commands from the keypad are given precedence (one of function codes E01 to E05, E98, or E99 must be set to "35"). By factory default, (LOC) is assigned to [X5].

You can confirm the current mode on the indicators (REM: Remote mode; LOC: Local mode).

When the mode is switched from Remote to Local, the frequency settings in the Remote mode are automatically inherited. Further, if the inverter is in Running mode at the time of the switching from Remote to Local, the Run command is automatically turned ON so that all the necessary data settings will be carried over. If, however, there is a discrepancy between the settings on the keypad and those on the inverter itself (e.g., switching from reverse rotation in the Remote mode to forward rotation in the Local mode using the keypad that is for forward rotation only), the inverter automatically stops.

The paths of transition between Remote and Local modes depend on the current mode and the value (ON/OFF) of (LOC), the signal giving precedence to the commands from the keypad, as shown in the state transition diagram (Figure 3.5) given below.

 For further details on how to set operation commands and frequencies in Remote and Local modes, refer to the FRENIC-Eco User's Manual (MEH456), Chapter 4 "BLOCK DIAGRAMS FOR CONTROL LOGIC" (especially Section 4.3 "Drive Command Generator" block diagram).

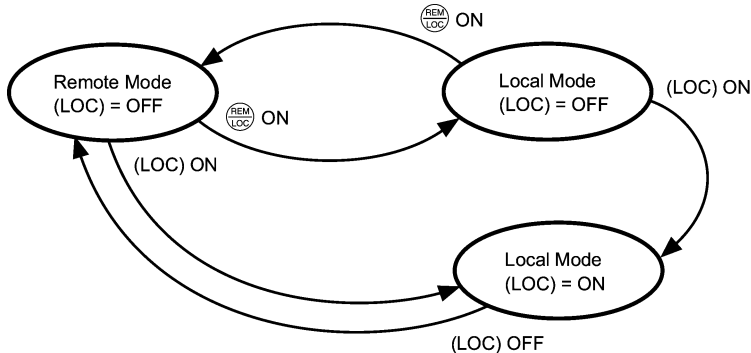

Figure 3.5 Transition between Remote and Local Modes

### 3.3.2 Setting up the frequency and PID process commands

You can set up the desired frequency command and PID process command by using  $\triangle$  and  $\nabla$  keys on the keypad.

You can also view and set up the frequency command as load shaft speed by setting function code E48.

#### ■ Setting the frequency command

Using  $\triangle$  and  $\nabla$  keys (factory default)

- (1) Set function code F01 to "0: Keypad operation." This cannot be done when the keypad is in Programming mode or Alarm mode. To enable frequency setting by using  $\triangle$  and  $\nabla$  keys, first move the keypad in Running mode.
- (2) Pressing the  $\triangle$  /  $\nabla$  key causes the frequency command to be displayed on the LCD Monitor, with the lowermost digit blinking.

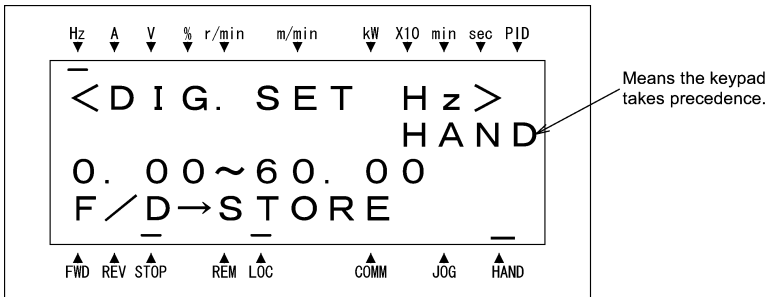
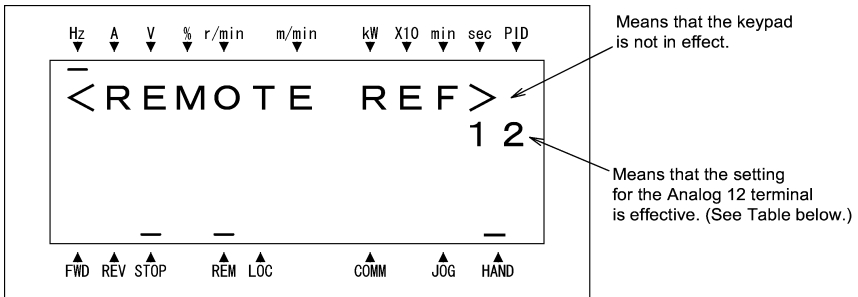

Figure 3.6 Setting the Frequency Command in Local Mode

- (3) If you need to change the frequency command, press the  $\triangle$  /  $\nabla$  key again. The new setting will be automatically saved into the inverter's internal non-volatile memory. It is kept there even while the inverter is powered OFF, and will be used as the initial frequency next time the inverter is powered ON.



- The frequency setting can be saved either automatically as mentioned above or by pressing the key. You can choose either way using function code E64.
- When you start specifying or changing the frequency command or any other parameter with the key, the lowest digit on the display will blink and start changing. As you are holding the key down, blinking will gradually move to the upper digit places and the upper digits will be changeable.
- Pressing the key moves the changeable digit place (blinking) and thus allows you to change upper digits easily.
- By setting function code C30 to "0: Keypad operation ( / key)" and selecting frequency command 2 as the frequency setting method, you can also specify or change the frequency command in the same manner using the key.
- If you have set the function code F01 to "0: Keypad operation ( / key)" but have selected a frequency setting other than frequency 1 (i.e., frequency 2, set it via communications, or as a multistep frequency), then you cannot use the key for setting the frequency command even if the keypad is in Running Mode. Pressing either of these keys will just display the currently selected frequency command.



To have the frequency command displayed as the motor speed, load shaft speed, or speed (%), set function code E48 (speed monitor selection) to 3, 4, or 7, respectively, as shown in Table 3.6 Monitored Items.

Table 3.4 Available Means of Setting

Symbol	Command sources	Symbol	Command sources	Symbol	Command sources
HAND	Keypad	MULTI	Multistep frequency	PID-HAND	PID keypad command
12	Terminal [12]			PID-P1	PID process command 1
C1	Terminal [C1]	RS485-1	RS485 (standard)	PID-P2	PID process command 2
12 + C1	Terminal [12] + Terminal [C1]	RS485-2	RS485 (optional)	PID-U/D	PID UP/DOWN process command
V2	Terminal [V2]	BUS	Bus option	PID_LINK	PID communication process command
U/D	UP/DOWN control	LOADER	FRENIC loader	PID+MULTI	PID multistep frequency command

### ■ Make setting under PID control

To enable PID control, you need to set function code J01 to 1 or 2.

Under the PID control, the items that can be set or checked with  $\triangle$  and  $\nabla$  keys are different from those under regular frequency control, depending upon the current LED monitor setting. If the LED monitor is set to the speed monitor, you may access manual speed commands (frequency command) with  $\triangle$  and  $\nabla$  keys; if it is set to any other value, you may access the PID process command with those keys.

 Refer to the FRENIC-Eco User's Manual (MEH456) for details on the PID control.

### ■ Setting the PID process command with $\triangle$ and $\nabla$ keys

- (1) Set function code J02 to "0: Keypad operation."
- (2) Set the LED monitor to something other than the speed monitor (E43 = 0) while the keypad is in Running Mode. You cannot modify the PID process command using the  $\triangle$  /  $\nabla$  key while the keypad is in Programming Mode or Alarm Mode. To enable the modification of the PID process command by the  $\triangle$  /  $\nabla$  key, first switch to Running Mode.
- (3) Press the  $\triangle$  /  $\nabla$  key to have the PID process command displayed. The lowest digit will blink together with the dot on the LED monitor.

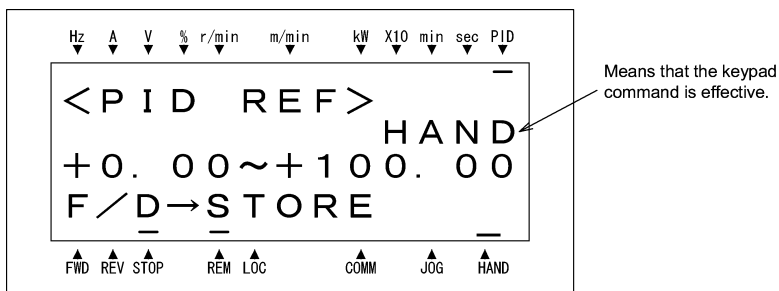
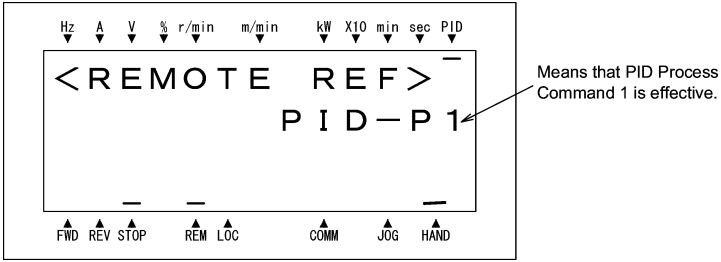

Figure 3.7 PID Process Commands

- (4) To change the PID process command, press the  $\triangle$  /  $\nabla$  key again. The PID process command you have specified will be automatically saved into the inverter's internal memory. It is kept there even if you temporarily switch to another means of specifying the PID process command and then go back to the means of specifying the PID process command via the keypad. Also, it is kept there even while the inverter is powered OFF, and will be used as the initial PID process command next time the inverter is powered ON.

**Tip**

- Even if multistep frequency is selected as the PID process command ((SS4) = ON), you still can set the process command using the keypad.
- When function code J02 is set to any value other than 0, pressing the  $\wedge$  /  $\vee$  key displays, on the 7-segment LED monitor, the PID command currently selected, while you cannot change the setting.



- On the 7-segment LED monitor, the decimal point of the lowest digit is used to characterize what is displayed. The decimal point of the lowest digit blinks when a PID process command is displayed; the decimal point lights when a PID feedback value is displayed.



■ Setting up the frequency command with  $\wedge$  and  $\vee$  keys under PID control

When function code F01 is set at "0: Keypad operation" and frequency command 1 (Frequency setting via communications link: Disabled; Multistep frequency setting: Disabled; PID control: Disabled) is selected as the manual speed command, you can modify the frequency setting using the  $\wedge$  /  $\vee$  key if you specify the LED monitor as the speed monitor while the keypad is in Running Mode. You cannot modify the frequency setting using the  $\wedge$  /  $\vee$  key while the keypad is in Programming Mode or Alarm Mode. To enable the modification of the frequency setting using the  $\wedge$  /  $\vee$  key, first switch to Running Mode. These conditions are summarized in Table 3.5 and the figure below. Table 3.5 shows the combinations of the parameters, while the figure below illustrates how the manual speed command ① entered via the keypad is translated to the final frequency command ②.

The setting and viewing procedures are the same as those for usual frequency setting.

Table 3.5 Speed (Frequency) Command Manually Set with  $\wedge$  /  $\vee$  Key and Requirements

Frequency command 1 (F01)	Frequency setting via communications link	Multistep frequency setting	PID control disabled	Display during $\wedge$ / $\vee$ key operation
0	Disabled	Disabled	PID enabled	PID output (as final frequency command)
			Disabled	Manual speed setting by keypad (frequency setting)
Other than the above			PID enabled	PID output (as final frequency command)
			Disabled	Manual speed command currently selected (frequency setting)

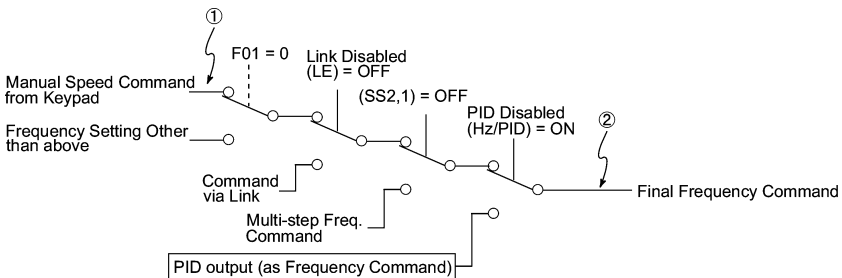



### 3.3.3 LED monitor (Monitoring the running status)



The eleven items listed below can be monitored on the LED Monitor. Immediately after the inverter is turned ON, the monitor item specified by function code E43 is displayed. In Running Mode, press the  key to switch between monitor items. The item being monitored shifts as you press the  key in the sequence shown in Table 3.6.

Table 3.6 Items Monitored

Page to be selected	Monitored Item	Example	Unit	Meaning of Displayed Value	Function code E43
0	Speed Monitor	Function code E48 specifies what to be displayed.			0
	Output frequency	50.00	Hz	Frequency actually being output (Hz)	(E48 = 0)
	Motor speed	1500	r/min	Output frequency × $\frac{120}{P01}$	(E48 = 3)
	Load shaft speed	300.0	r/min	Output frequency (Hz) × E50	(E48 = 4)
	Speed (%)	50.0	%	$\frac{\text{Output frequency}}{\text{Maximum frequency}} \times 100$	(E48 = 7)
8	Output current	12.34	A	Output of the inverter in current in rms	3
9	Input Power	10.25	kW	Input power to the inverter	9
10	Calculated torque	50	%	Motor output torque in % (Calculated value)	8
11	Output voltage	200	V	Output of the inverter in voltage in rms	4
12	Motor output	9.85	kW	Motor output in kW	16
13	Load factor	50	%	Load rate of the motor in % with the rated output being at 100%	15
14	PID process command (Note 1)	10.00	—	PID process command/feedback value transformed to that of physical value of the object to be controlled.	10
15	PID feedback value (Note 1)	9.00	—	Refer to the function codes E40 and E41 for details.	12
16	PID output (Note 1)	100.0	%	PID output in % with the maximum output frequency (F03) being at 100%	14
18	Analog input monitor (Note 2)	82.00	—	Analog input to the inverter converted per E40 and E41 Refer to the function codes E40 and E41 for details.	17

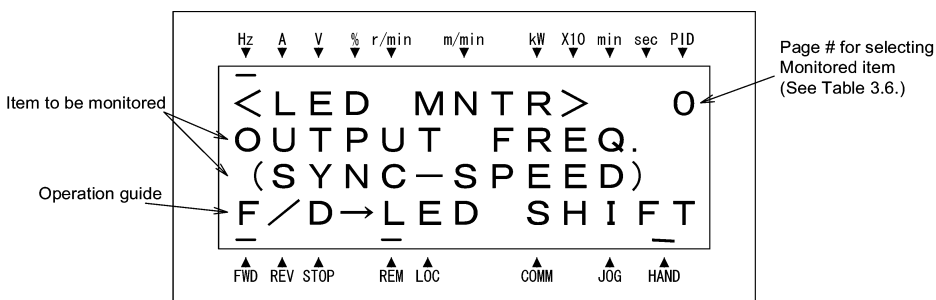

Figure 3.8 Selecting Items to be Monitored on LED Monitor

(Note 1) Displayed only if the inverter PID-controls the motor according to a PID process command specified by the function code J01 (= 1 or 2). While the 7-segment LED monitor is displaying PID process command, PID feedback value, or PID output value, the dot (decimal point) at the lowest digit on it is lit or blinking respectively.

(Note 2) Analog input monitoring becomes active only when enabled by any data of the function codes E61, E62 or E63 (Select terminal function).

### 3.4 Programming Mode

Programming Mode provides you with the functions of setting and checking function code data, monitoring maintenance information and checking input/output (I/O) signal status. The functions can be easily selected with a menu-driven system. Table 3.7 lists menus available in the Programming Mode.

Table 3.7 Menus Available in Programming Mode

Menu #	Menu	Main functions	Refer to:
0	Quick Setup	Displays only basic function codes that are pre-selected.	3.4.2
1	Data Setting	Allows you to view and change the setting of the function code you select. (Note)	3.4.1
2	Data Checking	Allows you to view and change a function code and its setting (data) on the same screen. Also allows you to check the function codes that have been changed from their factory defaults.	3.4.3
3	Drive Monitoring	Displays the running information required for maintenance or test running.	3.4.4
4	I/O Checking	Displays external interface information.	3.4.5
5	Maintenance Information	Displays maintenance information including cumulative run time.	3.4.6
6	Alarm Information	Displays four latest alarm codes. Also allows you to view the information on the running status at the time the alarm occurred.	3.4.7
7	Alarm cause	Displays the cause of the alarm.	
8	Data Copying	Allows you to read or write function code data, as well as to verify it.	3.4.8
9	Load Factor Measurement	Allows you to measure the maximum output current, average output current, and average braking power.	
10	User Setting	Allows you to add or delete function codes covered by Quick Setup.	
11	Communication Debugging	Allows you to confirm the data of the function codes for communication (S, M, W, X, and Z codes).	

(Note) The function codes for optional features (o code) are displayed only when they are installed. For details, refer to their instruction manuals.

Figure 3.9 shows the transitions between menus in Programming mode.

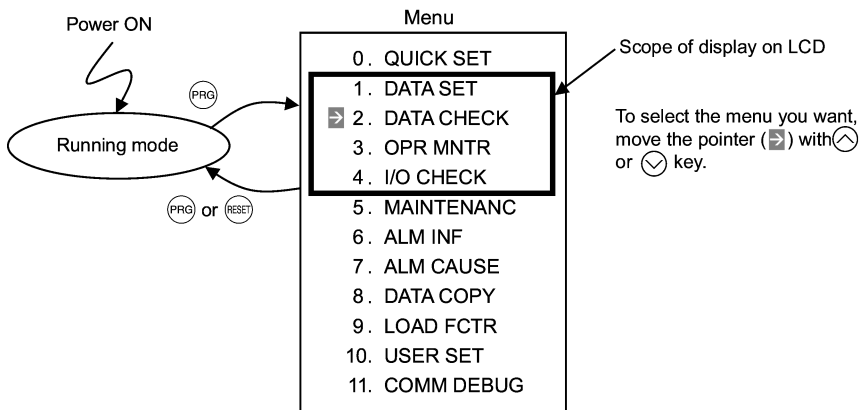

Figure 3.9 Menu Transition in Programming Mode

When there has been no key operation for about 5 minutes, the inverter automatically goes back to the Running mode and the back light goes OFF.

### 3.4.1 Setting function codes – "1. Data Setting"

Menu #1 "Data Setting" in Programming Mode allows you to set function codes according to your needs.

Table 3.8 lists the function codes available on the FRENIC-Eco.





Table 3.8 Function Codes Available on FRENIC-Eco

Function Code Group	Function Code	Function	Description
F code (Fundamental functions)	F00 to F44	Fundamental functions	Fundamental functions used in operation of the motor
E code (Extension terminal functions)	E01 to E99	Terminal functions	Functions concerning the selection of operation of the control circuit terminals; Functions concerning the display on the LED monitor
C code (Control functions of frequency)	C01 to C53	Control functions	Functions associated with frequency settings
P code (Motor parameters)	P01 to P99	Motor parameters	Functions for setting up characteristics parameters (such as capacity) of the motor
H code (High performance functions)	H03 to H98	High-level functions	Highly added-value functions; Functions for sophisticated control
J code (Application functions)	J01 to J22	Application functions	Functions for applications such as PID Control
y code (Link functions)	y01 to y99	Link functions	Functions for controlling communications
o code (Option functions)	o27 to o59	Optional functions	Functions for optional features (Note)

(Note) The o code is displayed only when the corresponding optional feature is installed.

For details of the o code, refer to the Instruction Manual for the corresponding optional feature.

#### ■ Function codes requiring simultaneous keying

To modify the data for function code F00 (data protection), H03 (data initialization), or H97 (clear alarm data), simultaneous keying is needed, involving the  key + the  key, or the  key + the  key.

#### ■ Modifying function code data during running; making the modification valid and saving the modification

Some function codes can be modified while the inverter is running, whereas others cannot. Further, depending on the function code, modifications may or may not become effective immediately. For details, refer to the "Change when running" column in 5.1 "Function Code Tables" in Chapter 5 of the FRENIC-Eco Instruction Manual (INR-SI47-0882-E).

 For details of function codes, refer to 5.1 "Function Code Tables" in Chapter 5 of the FRENIC-Eco Instruction Manual (INR-SI47-0882-E).

Figure 3.10 illustrates LCD screen transition for Menu item 1. DATA SET.

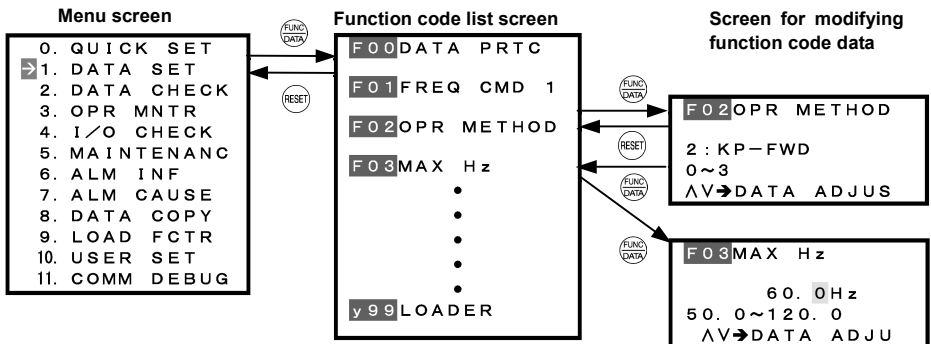

Figure 3.10 Screen Transition for Data Setting Menu

### Basic key operation

This section will give a description of the basic key operation, following the example of the function code data changing procedure shown in Figure 3.11.

This example shows you how to change function code F03 data (maximum frequency) from 58.0 Hz to 58.1 Hz.

- (1) When the inverter is powered ON, it automatically enters Running Mode. In Running Mode, press the **PRG** key to enter Programming Mode. The menu for function selection will be displayed.
- (2) Using **▲** and **▼** keys, move the pointer **→** to "1. DATA SET" and then press the **FUNC DATA** key, which will display a list of function codes.
- (3) Use **▲** and **▼** keys to select the desired function code group (in this example, F03:), and press the **FUNC DATA** key, which will display the screen for changing the desired function code data.
- (4) Change the function code data by using **▲** and **▼** keys. Pressing the **SHIFT** key causes the blinking digit place to shift (cursor shifting) (The blinking digit can be changed).
- (5) Press the **FUNC DATA** key to finalize the function code data.

The data will be saved in the memory inside the inverter. The display will return to the function code list, then move to the next function code (in this example, F04).

If you press the **RESET** key before the **FUNC DATA** key, the change made to data of the function code is cancelled. The data reverts to the previous value, the screen returns to the function code list, and the function code (F03) reappears.

- (6) Press the **RESET** key to return to the menu from the function code list.

Screen

Function code      Function code name

FO0 DATA PRTC  
FO1 FREQ CMD 1  
FO2 OPR METHOD  
FO3 MAX Hz  
DATA SET ▲▼→F

Operation guide: The function of each key is displayed by automatic scrolling of this line.

Function code #, name  
\*: Function code that has been changed from factory default  
Data  
Allowable range  
Operation guide

FO3 MAX Hz  
\*      58.0 Hz  
25.0 ~ 120.0  
▲▼→DATA ADJUS

Data before change  
Data after change

FO3 MAX Hz  
\*      58.0 Hz  
      58.1 Hz  
25.0 ~ 120.0  
▲▼→DATA ADJUS

Figure 3.11 Screen for Changing Function Code Data

**Tip** ■ Additional note on function code being selected

The function code being selected blinks, indicating the movement of the cursor (F03 blinks in this example).

```

-> 0. QUICK SET
  1. DATA SET
  2. DATA CHECK
  3. OPR MNTR
  ^V->MENU SHIF v
  
```

Press **PRG** key to enter Menu.

Select desired menu by shifting the pointer **->** with **^** / **v** key.

```

  0. QUICK SET
-> 1. DATA SET
  2. DATA CHECK
  3. OPR MNTR
  ^V->MENU SHIF v
  
```

**REAL DATA**

**RESET**

Press **REAL DATA** key to finalize desired menu.

```

FOODATA PRTC
FO1 FREQ CMD 1
FO2 OPR METHOD
FO3 MAX Hz
DATA SET ^V->F
  
```

Press **RESET** key to return to Menu.

Select desired function code by moving the cursor with **^** / **v** key.

```

FOODATA PRTC
FO1 FREQ CMD 1
FO2 OPR METHOD
FO3 MAX Hz
DATA SET ^V->F
  
```

**REAL DATA**

Press **REAL DATA** key to finalize desired function code.

```

FO3 MAX Hz
*
      58. 0 Hz
25. 0 ~ 120. 0
^V->DATA ADJUS
  
```

Press **^** / **v** key to change function code data.

```

FO3 MAX Hz
*
      58. 0 Hz
      58. 1 Hz
25. 0 ~ 120. 0
^V->DATA ADJUS
  
```

Press **REAL DATA** key to finalize function code data.

Press **RESET** key to cancel change of data.

Figure 3.12 Changing Function Code Data

### 3.4.2 Setting up function codes quickly using Quick setup – "0. QUICK SET"

Menu #0 "QUICK SET" in Programming Mode allows you to quickly set up a fundamental set of function codes that you specify beforehand. Whereas at shipment from factory, only a predetermined set of function codes is registered, you can add or delete some function codes using "10. USER SET." The set of function codes covered by Quick Setup is held in the inverter (not the keypad). Therefore, if you mount your keypad onto another inverter, the set of function codes held in the new inverter is subject to Quick Setup. If necessary, you may copy the set of function codes subject to Quick Setup using the copy function ("8. DATA COPY").

If you perform data initialization (function code H03), the set of function codes subject to Quick Setup will be reset to the factory default.

 For the list of function codes subject to Quick Setup by factory default, refer to the FRENIC-Eco Instruction Manual (INR-SI47-0882-E), Chapter 5 "FUNCTION CODES."

LCD screen transition from the "0. QUICK SET" menu is the same as with "1. DATA SET."

#### **Basic key operation**

Same as the basic key operation for "1. DATA SET."

### 3.4.3 Checking changed function codes –"2. DATA CHECK"

Menu #2 "DATA CHECK" in Programming Mode allows you to check function codes (together with their data) that have been changed. The function codes whose data have been changed from factory default are marked with \*. By selecting a function code and pressing the  key, you can view or change its data.

LCD screen transition from the "2. DATA CHECK" menu is the same as with "1. DATA SET," except for the different screen listing function codes as shown below.

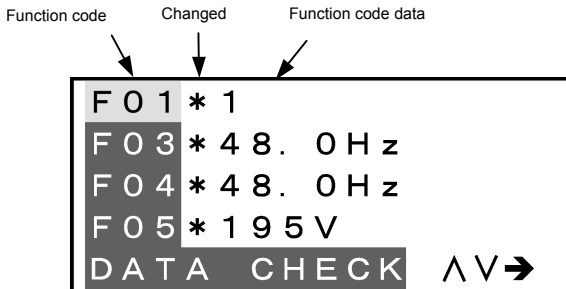

Figure 3.13 LCD Screen Listing Function Codes

#### **Basic key operation**

Same as the basic key operation for "1. DATA SET."

### 3.4.4 Monitoring the running status –"3. OPR MNTR"

Menu #3 "OPR MNTR" allows you to check the running status during maintenance and test running. The display items for "Drive Monitoring" are listed in Table 3.9.

Table 3.9 Drive Monitoring Display Items

Symbol	Item	Description
Fot1	Output frequency	Output frequency
Fot2		Reserved
Iout	Output current	Output current
Vout	Output voltage	Output voltage
TRQ	Calculated torque	Calculated output torque generated by motor
Fref	Frequency command	Frequency command
	Running direction	FWD: Forward, REV: Reverse, Blank: Stopped
	Running status	IL: Current limitation, LU: Undervoltage, VL: Voltage limitation
SYN	Motor shaft speed	Display value = (Output frequency Hz) × $\frac{120}{P01}$
LOD	Load shaft speed	Display value = (Output frequency Hz) × (Function code E50)
LIN		Reserved
SV	PID process command	The PID process command and PID feedback value are displayed after converting the value to a virtual physical value (e.g., temperature or pressure) of the object to be controlled using the function code E40 and E41 data (PID display coefficients A and B). Display value = (PID process command/feedback value) × (Coefficient A - B) + B
PV	PID feedback value	
MV	PID output value	PID output value, displayed in % (with Maximum frequency (F03) being 100%).

Figure 3.14 shows the LCD screen transition starting from the "OPR MNTR" menu.

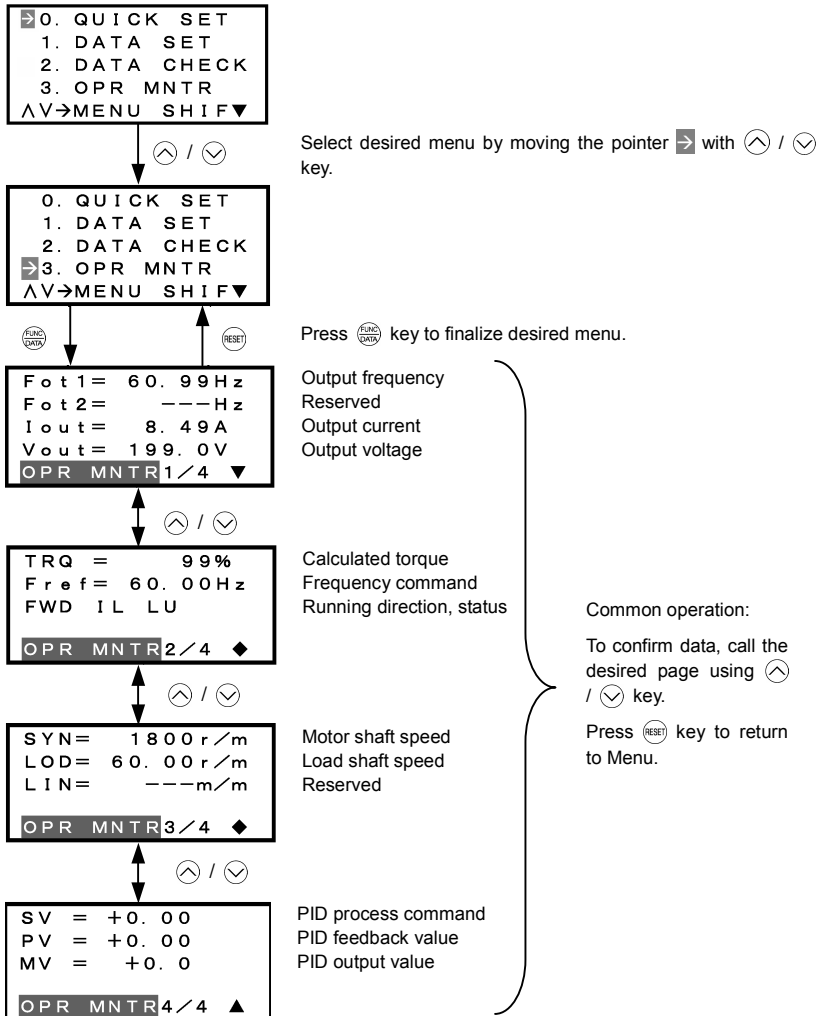

Figure 3.14 Menu Transition for "OPR MNTR"

### Basic key operation

- (1) When the inverter is powered ON, it automatically enters Running Mode. In Running Mode, press the (PRG) key to enter Programming Mode. The menu for function selection will be displayed.
- (2) Select "3. OPR MNTR" by using ▲ and ▼ keys (moving →).
- (3) Press the (PRG DATA) key to display the screen for Operation Monitor (1 page out of a total of 4 pages).
- (4) Select the page for the desired item by using ▲ and ▼ keys and confirm the running status information for the desired item.
- (5) Press the (RESET) key to go back to the menu.



### 3.4.5 Checking I/O signal status – "4. I/O CHECK"

Menu #4 "I/O CHECK" in Programming mode allows you to check the digital and analog input/output signals coming in/out of the inverter. This menu is used to check the running status during maintenance or test run.

Table 3.10 lists check items available.

Table 3.10 I/O Check Items

Item	Symbol	Description
Input signals at terminal block of control circuit	FWD, REV, X1 - X5	Shows the ON/OFF state of the input signals at the terminal block of the control circuit. (Highlighted when short-circuited; normal when open)
Input signals coming via Communication link	FWD, REV, X1 - X5, XF, XR, RST	Input information for function code S06 (communication) (Highlighted when 1; normal when 0)
Output signals	Y1 - Y3, Y5, 30ABC	Output signal information
I/O signals (hexadecimal)	DI	Input signal at terminal block of control circuit (in hexadecimal)
	DO	Output signal (in hexadecimal)
	LNK	Input signal via communication link (hexadecimal)
Analog input signals	12	Input voltage at terminal [12]
	C1	Input current at terminal [C1]
	V2	Input voltage at terminal [V2]
Analog output signals	FMA	Output voltage at terminal [FMA]
	FMA	Output current at terminal [[FMA]
	FMP	Average output voltage at terminal [FMP]
	FMP	Pulse rate at terminal [FMP]

#### **Basic key operation**









- (1) When the inverter is powered ON, it automatically enters Running Mode. In Running Mode, press the  key to enter Programming Mode. The menu for function selection will be displayed.
- (2) Select "4. I/O CHECK" by using  and  keys (moving ).
- (3) Press the  key to display the screen for I/O Checking (1 page out of a total of 6 pages).
- (4) Select the page for the desired item by using  and  keys and confirm the I/O check data for the desired item.
- (5) Press the  key to go back to the menu.

Figure 3.15 shows the LCD screen transition starting from the "4. I/O CHECK" menu.

```

0. QUICK SET
 1. DATA SET
 2. DATA CHECK
 3. OPR MNTR
^V→MENU SHIF▼

```

Select desired menu by moving the pointer → with ▲ / ▼ key.

```

 1. DATA SET
 2. DATA CHECK
 3. OPR MNTR
 →4. I/O CHECK
^V→MENU SHIF◆

```

Press **FUNC DATA** key to finalize desired menu.

```

TRM X2 --- --
FWD X3 --- --
REV X4 --- --
X1 X5 --- --
I/O CHECK1/6▼

```

**Input signal at control circuit terminal block**  
Highlighted when short-circuited; normal when open

```

LNK X2 -- XF
FWD X3 -- XR
REV X4 -- RST
X1 X5 -- --
I/O CHECK2/6◆

```

**Input signal coming via communication link**  
Highlighted when 1; normal when 0

```

Y1 Y5
Y2 30 ABC
Y3
--
I/O CHECK3/6◆

```

**Output signal**  
Highlighted when ON;  
normal when OFF

```

Di = 0000H
Do = 0000H
LNK = 0000H
I/O CHECK4/6◆

```

**I/O signal (hex)**  
Input signal at control circuit terminal block  
Output signal  
Input signal coming via communication link

```

12 = +0.0V
C1 = 0.0mA
V2 = +0.0V
I/O CHECK5/6◆

```

**Analog input signal**  
Input voltage at terminal [12]  
Input current at terminal [C1]  
Input voltage at terminal [V2]

```

FMA = 0.0V
FMA = 0.0mA
FMP = 0.0V
FMP = 0 p/s
I/O CHECK6/6▲

```

**Analog output signal**  
Output voltage at terminal [FMA]  
Output current at terminal [FMA]  
Average output voltage at terminal [FMP]  
Pulse rate at terminal [FMP]

Common operation:  
To confirm data, call the desired page using ▲ / ▼ key.  
Press **RESET** key to return to Menu.

Figure 3.15 Menu Transition for "I/O CHECK"

■ Hexadecimal expression

Each I/O terminal is assigned to one of the 16 binary bits (bit 0 through bit 15). The bit to which no I/O terminal is assigned is considered to have a value of "0." The I/O signals are thus collectively expressed as a hexadecimal number (0 through F).

In the FRENIC-Eco Series, digital input terminals [FWD] and [[REV] are assigned to bits 0 and 1, and [X1] through [X5] to bits 2 through 6, respectively. Each bit assumes a value of "1" when the corresponding signal is ON and a value of "0" when it is OFF<sup>(Note)</sup>. For example, when signals [FWD] and [X1] are ON while all the other signals are OFF, the status is expressed as "0005H."

(Note) The ON/OFF state of each signal at terminals [FWD], [REV], and X1 through [X5] is to be interpreted according to the states of the source/sink switch as shown in Table 2.9 in Chapter 2 of the FRENIC-Eco Instruction Manual (INR-SI47-0882-E).

Digital output terminals [Y1] through [Y3] are assigned to bits 0 through 2. Each is given a value of "1" when it is short-circuited to [CMY], or a value of "0" when its circuit to [CMY] is open. The status of relay output terminal [Y5A/C] is assigned to bit 4, which assumes a value of "1" when the contact between [Y5A] and [Y5C] is closed. The status of relay output terminal [30A/B/C] is assigned to bit 8, which assumes a value of "1" when the contact between [30A] and [30C] is closed or "0" when the contact between [30B] and [30C] is closed. For example, when terminal [Y1] is ON, terminals [Y2] and [Y3] are OFF, the contact between [Y5A] and [Y5C] is opened, and the link between 30A and 30C is closed, the status is expressed as "0101H."

Table 3.11 Hexadecimal Notation

Data Displayed		Highest digit								Lowest digit							
		Bit	15	14	13	12	11	10	9	8	7	6	5	4	3	2	1
Input signal		(RST)	(XR)	(XF)	-	-	-	-	-	-	[X5]	[X4]	[X3]	[X2]	[X1]	[REV]	[FWD]
Output signal		-	-	-	-	-	-	[30A/B /C]	-	-	-	[Y5A /C]	-	[Y3]	[Y2]	[Y1]	
Example (input)	Binary	0	0	0	0	0	0	0	0	0	0	0	0	0	1	0	1
	Hex	0005H															

-: unassigned

\* (XF), (XR), (RST) are for communications. Refer to the subsection below.

■ **Displaying control I/O signal terminals under communication control**

During control via communication, input commands sent via RS485 communications can be displayed in two ways depending on setting of the function code S06: "Display with ON/OFF of the LED segment" or "In hexadecimal format." The content to be displayed is basically the same as that for the control I/O signal terminal status display; however, (XF), (XR), and (RST) are added as inputs. Note that under communications control, I/O display is in normal logic (ON when active) (using the original signals that are not inverted).

 Refer to the RS485 Communication User's Manual (MEH448a) for details on input commands sent through RS485 communications and the instruction manual of communication-related options as well.

### 3.4.6 Reading maintenance information – "5. MAINTENANC"

Menu #5 "MAINTENANC" in Programming Mode allows you to view information necessary for performing maintenance on the inverter.

Table 3.12 lists the maintenance information display items.

Table 3.12 Display Items for Maintenance

Symbol	Item	Description
TIME	Cumulative run time	Shows the cumulative run time during which the inverter was powered ON. When the total time exceeds 65,535 hours, the counter will be reset to 0 and the count will start again.
EDC	DC link circuit voltage	Shows the DC link circuit voltage of the inverter's main circuit.
TMPI	Max. temperature inside the inverter	Shows a maximum temperature inside the inverter every hour.
TMPF	Max. temperature of heat sink	Shows the maximum temperature of the heat sink every hour.
Imax	Max. effective current	Shows the maximum current in rms every hour.
CAP	Capacitance of the DC bus capacitor	Shows the current capacitance of the DC bus capacitor as % of the capacitance at factory shipment. Refer to the FRENIC-Eco Instruction Manual (INR-SI47-0882-E), Chapter 7 "MAINTENANCE AND INSPECTION" for details.
MTIM	Cumulative motor run time	Shows the cumulative run time of the motor. When the total time exceeds 65,535 hours, the counter will be reset to 0 and the count will start again.
TCAP	Cumulative run time of electrolytic capacitor on the printed circuit board	Shows the product of the cumulative time of voltage being applied to the electrolytic capacitor on the printed circuit board and a coefficient determined by the environmental condition. When the total time exceeds 65,535 hours, the counting will stop. As a guide, 61,000 hours is considered as life.
TFAN	Cumulative run time of the cooling fan	Shows the cumulative run time of the cooling fan. When the total time exceeds 65,535 hours, the counting will stop. As a guide, 61,000 hours is considered as life (This number varies with the capacity of the inverter.)
NST	Count of start-ups	Shows the total count of start-ups of the motor (count of times when the run command for the inverter was turned ON). When the total time exceeds 65,535 hours, the counter will be reset to 0 and the count will start again.
Wh	Input watt-hour <span style="float: right;">Note 1)</span>	Shows the input watt-hours of the inverter. Upon exceeding 1,000,000 kWh, the count goes back to 0.
PD	Input watt-hour data <span style="float: right;">Note 1)</span>	Shows the input watt-hour data as input watt-hour (kWh) x function code E51. (The range of display is 0.001 to 9,999. Values exceeding 9,999 are expressed as 9,999.)
NRR1	Count of RS485-1 errors	Shows the cumulative count of RS485 communications card (standard) errors since first power ON.
	RS485-1 error content <span style="float: right;">Note 2)</span>	Shows the latest error that has occurred with RS485 communications (standard) in a code.
NRR2	Count of RS485-2 errors	Shows the cumulative count of RS485 communications card (option) errors since first power ON.
	RS485-2 error content <span style="float: right;">Note 2)</span>	Shows the latest error that has occurred with RS485 communications (option) in a code.
NRO	Count of option errors	Shows the cumulative count of errors detected during optional communication with option installed.
	Option error code	Shows the latest error that has been detected during optional communication in a code.
MAIN	ROM version of the inverter	Shows the ROM version of the inverter in 4 digits.
KP	ROM version of the keypad	Shows the ROM version of the keypad in 4 digits.
OP1	ROM version of the option	Shows the ROM version of the option in 4 digits.

Note 1) To reset the input watt-hour and input watt-hour data to 0, set function code E51 to "0.000."

Note 2) For details of errors, refer to the RS485 Communication User's Manual (MEH448a).

### **Basic key operation**









- (1) When the inverter is powered ON, it automatically enters Running Mode. In Running Mode, press the  key to enter Programming Mode. The menu for function selection will be displayed.
- (2) Select "5. MAINTENANC" by using  and  keys (moving ).
- (3) Press the  key to display the screen for Maintenance (1 page out of a total of 7 pages).
- (4) Select the page for the desired item by using  and  keys and confirm the Maintenance data for the desired item.
- (5) Press the  key to go back to the menu.

Figure 3.16 shows the LCD screen transition starting from the "5. MAINTENANC" menu.

```

0. QUICK SET
  1. DATA SET
  2. DATA CHECK
  3. OPR MNTR
  ^V→MENU SHIF▼
  
```

Select desired menu by moving the pointer → with ▲ / ▼ key.

```

2. DATA CHECK
  3. OPR MNTR
  4. I/O CHECK
  →5. MAINTENANC
  ^V→MENU SHIF◆
  
```

Press key to finalize desired menu.

```

TIME= 14 h
EDC = 493 V
TMP I= 38°C
TMP F= 88°C
MAINTENANC1/▼
  
```

Cumulative run time  
DC link circuit voltage  
Max. temperature inside the inverter  
Max. temperature of heat sink

```

I max = 0.00 A
CAP = 0.0%
MTIM= 14 h
MAINTENANC2/◆
  
```

Max. effective current  
Capacitance of the DC bus capacitor  
Cumulative motor run time

```

TCAP= 11 h
      (61000h)
TFAN= 31 h
      (61000h)
MAINTENANC3/◆
  
```

Cumulative run time of electrolytic capacitor (reference)  
Cumulative run time of the cooling fan (reference)

```

NST= 0
Wh = 999900 kWh
PD = 2265
MAINTENANC4/◆
  
```

Number of start-ups  
Input watt-hour  
Input watt-hour data

```

NRR1= 13 78
NRR2= 25 77
NRO = 11 72
MAINTENANC5/◆
  
```

No. of errors & Error content for RS485-1  
No. of errors & Error content for RS485-2  
No. of errors & Error code for Option communication

```

MAIN= 0000
KP = 0000
MAINTENANC6/◆
  
```

ROM version of the inverter  
ROM version of the keypad

```

OP1 = 0000
MAINTENANC7/▲
  
```

ROM version of the option

Common operation:

To confirm data, call the desired page using ▲ / ▼ key.

Press key to return to Menu.

Figure 3.16 Menu Transition for "MAINTENANC"

### 3.4.7 Reading alarm information – "6. ALM INF"

Menu #6 "ALM INF" in Programming Mode allows you to view the information on the four most recent alarm conditions that triggered protective functions (in alarm code and the number of occurrences). It also shows the status of the inverter when the alarm condition occurred.

Table 3.13 lists the details of the alarm information.

Table 3.13 Alarm Information Displayed

Symbol	Item	Description
O/1	Most recent alarm	Alarm code and count of occurrences
-1	2 <sup>nd</sup> recent alarm	Alarm code and count of occurrences
-2	3 <sup>rd</sup> recent alarm	Alarm code and count of occurrences
-3	4 <sup>th</sup> recent alarm	Alarm code and count of occurrences
Fot1	Output frequency	Output frequency
Iout	Output current	Output current
Vout	Output voltage	Output voltage
TRQ	Calculated torque	Motor output torque
Fref	Frequency command	Frequency command
	Running direction	FWD: Forward, REV: Reverse, Blank: Stopped
	Running status	IL: current limitation, LU: undervoltage, VL: voltage limitation
TIME	Cumulative run time	Shows the cumulative power-ON time of the inverter. When the total time exceeds 65,535 hours, the display will be reset to 0 and the count will start again.
NST	Count of startups	Shows the cumulative count of times the motor has been started (the inverter run command has been issued). When the total count exceeds 65,535, the display will be reset to 0 and the count will start again.
EDC	DC link circuit voltage	Shows the DC link circuit voltage of the inverter's main circuit.
TMPI	Temperature inside the inverter	Shows the temperature inside the inverter.
TMPF	Max. temperature of heat sink	Shows the maximum temperature of the heat sink.
TRM	Input signal status at terminal block of control circuit	ON/OFF status of input signals of the terminals [FWD], [REV], [X1] to [X5] (Highlighted when short-circuited; normal when open)
LNK	Terminal input signal status under communication control	ON/OFF status of input signals for function code S06 (Communication). [FWD], [REV], [X1] to [X5], (XF), (XR), (RST) (Highlighted when 1; normal when 0)
-	Output signal	Output signals to the terminals [Y1] to [Y3], [Y5], [30ABC]
3	Overlapping alarm 1	Simultaneously occurring alarm codes (1) ("----" is displayed if no alarms have occurred.)
2	Overlapping alarm 1	Simultaneously occurring alarm codes (2) ("----" is displayed if no alarms have occurred.)
SUB	Error sub-code	Secondary error code for the alarm.

**Note** When the same alarm occurs a number of times in succession (reoccurring alarm), the alarm information for the first occurrence is retained and the information for the subsequent occurrences is discarded. Only the number of consecutive occurrences will be updated.

**Basic key operation**

- (1) When the inverter is powered ON, it automatically enters Running Mode. In Running Mode, press the (PRG) key to enter Programming Mode. The menu for function selection will be displayed.
- (2) Select "6. ALM INF" by using (▲) and (▼) keys (moving →).
- (3) Press the (FUNC DATA) key to get the Alarm list screen, which displays information on the four most recent alarm conditions (alarm code and the number of occurrences for each alarm condition).
- (4) Select the alarm condition to be displayed, by using (▲) and (▼) keys.
- (5) Press the (FUNC DATA) key to display the alarm code on the LED Monitor and the screen for the status data at the time of the alarm (1 page out of a total of 7 pages) on the LCD Monitor.
- (6) Select the page for the desired item by using (▲) and (▼) keys and confirm the status data for the desired item.
- (7) Press the (RESET) key to return to the alarm list. Press the (RESET) key again to return to the menu.

Figure 3.17 shows the LCD screen transition starting from the "6. ALM INF" menu.

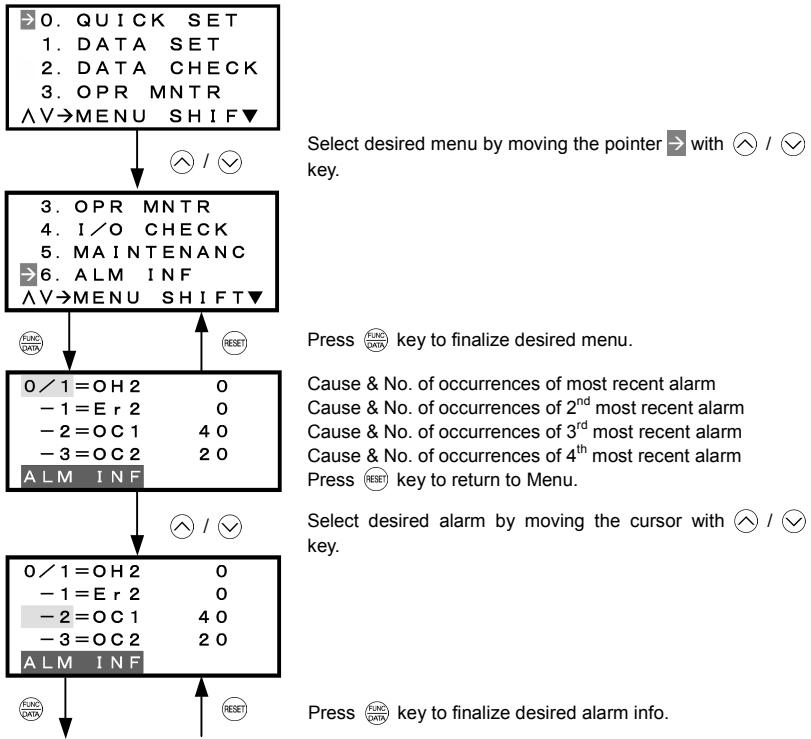
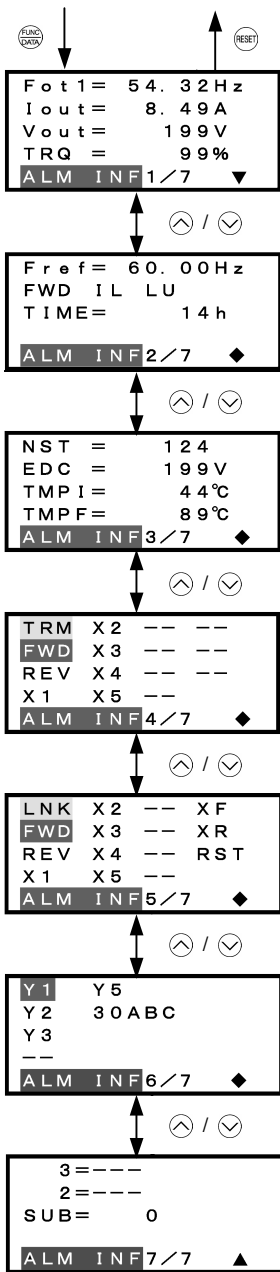

Figure 3.17 Menu Transition for "ALM INF"





Press **FUNC DATA** key to finalize desired alarm info.

Output frequency  
Output current  
Output voltage  
Calculated torque

Frequency command  
Running direction/status  
Cumulative run time

No. of startups  
DC link circuit voltage  
Temperature inside inverter  
Max. temperature of heat sink

**Input signal status at terminal block of control circuit**

Highlighted when short-circuited; normal when opened

**Terminal input signal status under communication control**

Highlighted when 1; normal when 0

**Output signal**

Highlighted when ON; normal when OFF

Overlapping alarm 2  
Overlapping alarm 1  
Error sub-code

Common operation:

To confirm data, call the desired page using **UP** / **DOWN** key.

Press **RESET** key to return to Menu.

Figure 3.17 Menu Transition for "ALM INF" (continued)

### 3.4.8 Viewing cause of alarm – "7. ALM CAUSE"

Menu #7 "ALM CAUSE" in Programming Mode allows you to view the information on the four most recent alarm conditions that triggered protective functions (in alarm code and the number of occurrences). It also shows the cause of each alarm.

#### Basic key operation













- (1) When the inverter is powered ON, it automatically enters Running Mode. In Running Mode, press the  key to enter Programming Mode. The menu for function selection will be displayed.
- (2) Select "7. ALM CAUSEF" by using  and  keys (moving ).
- (3) Press the  key to get the Alarm list screen, which displays information on the four most recent alarm conditions (alarm code and the number of occurrences for each alarm condition).
- (4) Select the alarm condition to be displayed, by using  and  keys.
- (5) Press the  key to display the alarm code on the LED Monitor and the screen for the cause of the alarm (can be more than 1 page) on the LCD Monitor.
- (6) Press  and  keys to view the previous/next page.
- (7) Press the  key to return to the alarm list. Press the  key again to return to the menu.

Figure 3.18 shows the LCD screen transition starting from the "7. ALM CAUSE" menu.

```

0. QUICK SET
  1. DATA SET
  2. DATA CHECK
  3. OPR MNTR
  ^V->MENU SHIF▼
  
```

Select desired menu by moving the pointer → with ^ / v key.

```

4. I/O CHECK
5. MAINTENANC
6. ALM INF
->7. ALM CAUSE
  ^V->MENU SHIF◆
  
```

Press FUNC key to finalize desired menu.

```

0/1=OH2      0
-1=Er 2      0
-2=OC 1      40
-3=OC 2      20
ALM CAUSE
  
```

Cause & No. of occurrences of most recent alarm  
 Cause & No. of occurrences of 2<sup>nd</sup> most recent alarm  
 Cause & No. of occurrences of 3<sup>rd</sup> most recent alarm  
 Cause & No. of occurrences of 4<sup>th</sup> most recent alarm  
 Press RESET key to return to Menu.

```

0/1=OH2      0
-1=Er 2      0
-2=OC 1      40
-3=OC 2      20
ALM CAUSE
  
```

Select desired alarm by moving the cursor with ^ / v key.

```

0/1=OH2      0
-1=Er 2      0
-2=OC 1      40
-3=OC 2      20
ALM CAUSE
  
```

Press FUNC key to finalize desired alarm cause page.

```

0/1=OH2      0
-1=Er 2      0
-2=OC 1      40
-3=OC 2      20
ALM CAUSE
  
```

Alarm cause (1<sup>st</sup> page)

```

KP CONNECTOR
WIRING
INVERTER UNIT
KEYPAD
ALM CAUSE ▼
  
```

Press RESET key to return to alarm list screen.

```

WIRING
INVERTER UNIT
KEYPAD
ELEC NOISE
ALM CAUSE ▲
  
```

Press ^ / v key to check all alarm causes.

```

WIRING
INVERTER UNIT
KEYPAD
ELEC NOISE
ALM CAUSE ▲
  
```

Alarm cause (2<sup>nd</sup> page)

Figure 3.18 Menu Transition for "ALM CAUSE"

### 3.4.9 Data copying – "8. DATA COPY"

Menu #8 "Data Copying" in Programming Mode allows you to read function code data out of an inverter for which function codes are already set up and then to write such function code data altogether into another inverter, or to verify the function code data held in the keypad with the one in the inverter.

The keypad can hold three sets of function code data in three areas of its internal memory so that it can be used with three different inverters. You can read the function code data of an inverter into one of these memory areas or write the function code data held in one of these memory areas into the inverter you select. On the LCD screen, each set of function code data or memory area is given a name such as DATA 1 and DATA 2.

#### Basic key operation

- (1) When the inverter is powered ON, it automatically enters Running Mode. In Running Mode, press the **(PRG)** key to enter Programming Mode. The menu for function selection will be displayed.
- (2) Select "8. DATA COPY" by using **(▲)** and **(▼)** keys (moving **(▶)**).
- (3) Press the **(FUNC DATA)** key to get the data copy index screen (list of data copy operations).
- (4) Select the operation (read, write, verify, check), by using **(▲)** and **(▼)** keys (moving **(▶)**).
- (5) Press the **(FUNC DATA)** key to finalize the choice of operation and then select the data set (or storage area) on the keypad.
- (6) Press the **(FUNC DATA)** key to finalize the selection and perform the operation of your choice (for details, refer to the LCD screen transition diagram below).
- (7) Press the **(RESET)** key to return to the menu.

Figure 3.19 shows the LCD screen transition starting from the "8. DATA COPY" menu.

#### 1) Selecting Copy Operation

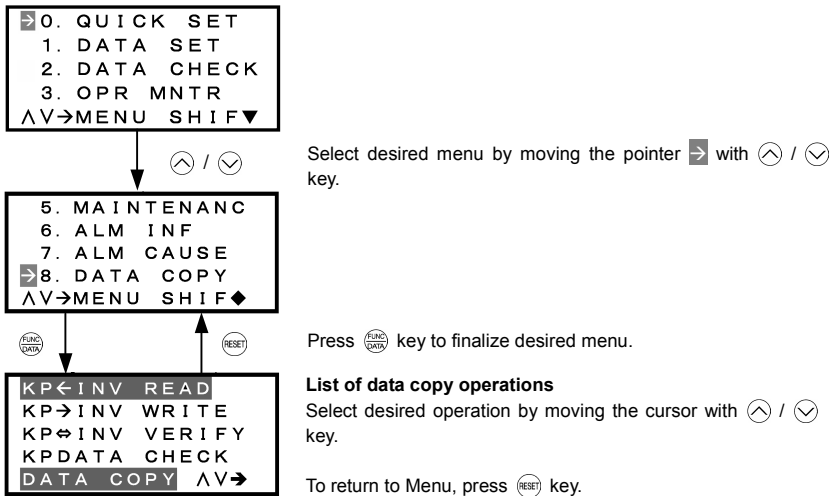
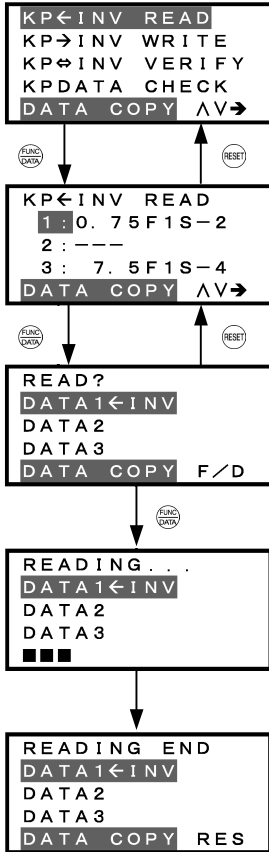

Figure 3.19 Menu Transition for "DATA COPY"

Table 3.14 List of DATA COPY Operations

Operation	Description
Read: Read data	Reads out function code data from the inverter and stores it into the internal memory of the keypad.
Write: Write data	Writes the data held in the selected memory area of the keypad into the inverter.
Verify: Verify data	Verifies the data held in the keypad's internal memory against the function code data in the inverter.
Check: Check data	Checks the model information (format) and function code data held in the three memory areas of the keypad.

## 2) Read Operation



### List of data copy operations

Select desired operation by moving the cursor with  $\uparrow$  /  $\downarrow$  key.

Press  $\text{FUNC DATA}$  key to finalize desired operation.

### Data selection screen

Select desired data by moving the cursor with  $\uparrow$  /  $\downarrow$  key. To go back to List of data copy operations, press  $\text{RESET}$  key.

Press  $\text{FUNC DATA}$  key to finalize desired data.

### Confirmation screen

If "Read" is actually performed, the data read out from the inverter will overwrite the data held in this memory area in the keypad. If OK, press  $\text{FUNC DATA}$  key.

To go back to Data selection screen, press  $\text{RESET}$  key.

Press  $\text{FUNC DATA}$  key to start Read operation.

### "In progress" screen

A bar indicating progress appears in the bottom.

Upon completion, Completion screen automatically appears.

### Completion screen

Indicates that Read operation has completed successfully.

To go back to List of data copy operations, press  $\text{RESET}$  key.

### Error screens

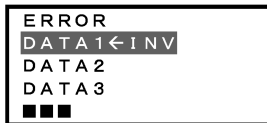

If you press  $\text{PRG}$  /  $\text{RESET}$  key during Read operation, the operation under way will be aborted, and this Error screen will appear. (Note) Once aborted, all the data held in the keypad's memory would be deleted.

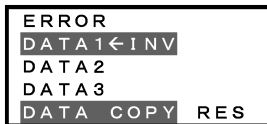

If a communication error is detected between the keypad and the inverter, this Error screen will appear.

Figure 3.20 Menu Transition for "READ"

**Note** If an ERROR screen or an ERROR Ver. Screen appears during operation, press the  $\text{RESET}$  key to reset the error condition. When Reset is complete, the screen will go back to List of data copy operations.

### 3) Write operation

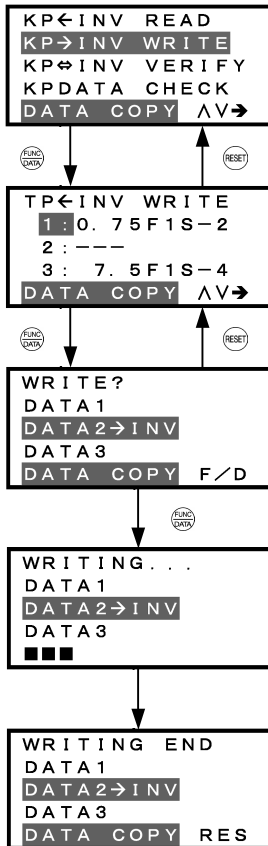

#### List of data copy operations

Select desired operation by moving the cursor with  $\uparrow$  /  $\downarrow$  key.

Press  $\text{FUNC DATA}$  key to finalize desired operation.

#### Data selection screen

Select desired data by moving the cursor with  $\uparrow$  /  $\downarrow$  key. To go back to List of data copy operations, press  $\text{RESET}$  key.

Press  $\text{FUNC DATA}$  key to finalize desired data.

#### Confirmation screen

If "Write" is actually performed, the selected data will overwrite the data held in the inverter. If OK, press  $\text{FUNC DATA}$  key. To go back to Data selection screen, press  $\text{RESET}$  key.

Press  $\text{FUNC DATA}$  key to start Write operation.

#### "In progress" screen

A bar indicating progress appears in the bottom.

Upon completion, Completion screen automatically appears.

#### Completion screen

Indicates that Write operation has completed successfully. To go back to List of data copy operations, press  $\text{RESET}$  key.

Figure 3.21 Menu Transition for "WRITE"

## Error screens

```
ERROR
DATA 1
DATA 2→INV
DATA 3
■■■
```

If you press (PRG) / (RESET) key during Write operation, the operation under way will be aborted, and this Error screen will appear. (Note) Updating of the function code data in the inverter is incomplete, with some of it remaining old. Do not run the inverter in this state. Before running the inverter, redo the writing or perform initialization.

```
ERROR
DATA 1
DATA 2→INV
DATA 3
DATA COPY RES
```

For safety considerations, the following situations are treated as an error:

- No valid data is found in the keypad's memory. (No Read operation has been performed since factory shipment; or, a Read operation has been cancelled or aborted.)
- The data held in the keypad's memory has an error.
- There is a mismatch in inverter's model number.
- A Write operation has been performed while the inverter is running.
- The inverter is data-protected.
- The Write enable for keypad command (WE-KP) is OFF.

```
ERROR V e r .
DATA 1
DATA 2→INV
DATA 3
DATA COPY RES
```

The function code data held in the keypad is incompatible with that in the inverter. (Either data may be non-standard; or a version upgrade performed in the past may have made the keypad or the inverter incompatible. Contact your Fuji Electric representative.)

Figure 3.21 Menu Transition for "WRITE" (continued)

**Note** If an ERROR screen or an ERROR Ver. Screen appears during operation, press the (RESET) key to reset the error condition. When Reset is complete, the screen will go back to List of data copy operations.

#### 4) Verify operation

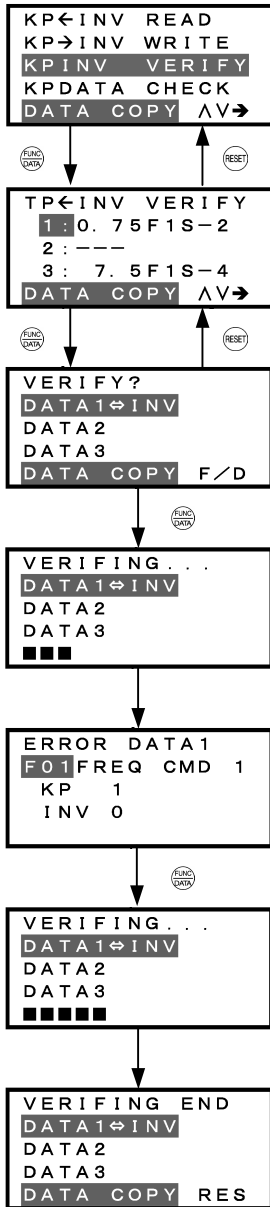

#### List of data copy operations

Select desired operation by moving the cursor with  $\uparrow$  /  $\downarrow$  key.

Press  $\text{FUNC DATA}$  key to finalize desired operation.

#### Data selection screen

Select data to be verified by moving the cursor with  $\uparrow$  /  $\downarrow$  key.

To go back to List of data copy operations, press  $\text{RESET}$  key.

Press  $\text{FUNC DATA}$  key to finalize desired data.

#### Confirmation screen

If OK, press  $\text{FUNC DATA}$  key.

To go back to Data selection screen, press  $\text{RESET}$  key.

Press  $\text{FUNC DATA}$  key to start Verify operation.

#### "In progress" screen

A bar indicating progress appears in the bottom.

When a mismatch is found, the Verify operation is halted, with the function code and its data displayed on the LCD Monitor. To resume the Verify operation from the next function code, press  $\text{FUNC DATA}$  key again.

To resume Verify, press  $\text{FUNC DATA}$  key.

#### "In progress" screen

A bar indicating progress appears in the bottom.

Upon completion, Completion screen automatically appears.

#### Completion screen

Indicates that Verify operation has completed successfully.

To go back to List of data copy operations, press  $\text{RESET}$  key.

Figure 3.22 Menu Transition for "VERIFY"



## Error screens

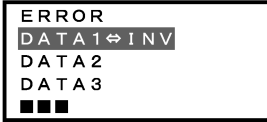

```
ERROR
DATA 1 ⇄ INV
DATA 2
DATA 3
■■■
```

If you press (PRG) / (RESET) key during Verify operation, the operation under way will be aborted, and this Error screen will appear. (Note)

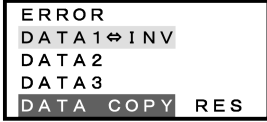

```
ERROR
DATA 1 ⇄ INV
DATA 2
DATA 3
DATA COPY RES
```

If the keypad does not have any valid data, this Error screen will appear. (Note)



```
ERROR Ver.
DATA 1 ⇄ INV
DATA 2
DATA 3
DATA COPY RES
```

The function code data held in the keypad is incompatible with that in the inverter. (Either data may be non-standard; or a version upgrade performed in the past may have made the keypad or the inverter incompatible. Contact your Fuji Electric representative.)

Figure 3.22 Menu Transition for "VERIFY" (continued)

 **Note** If an ERROR screen or an ERROR Ver. Screen appears during operation, press the (RESET) key to reset the error factor. When Reset is complete, the screen will go back to List of data copy operations.

## 5) Check operation

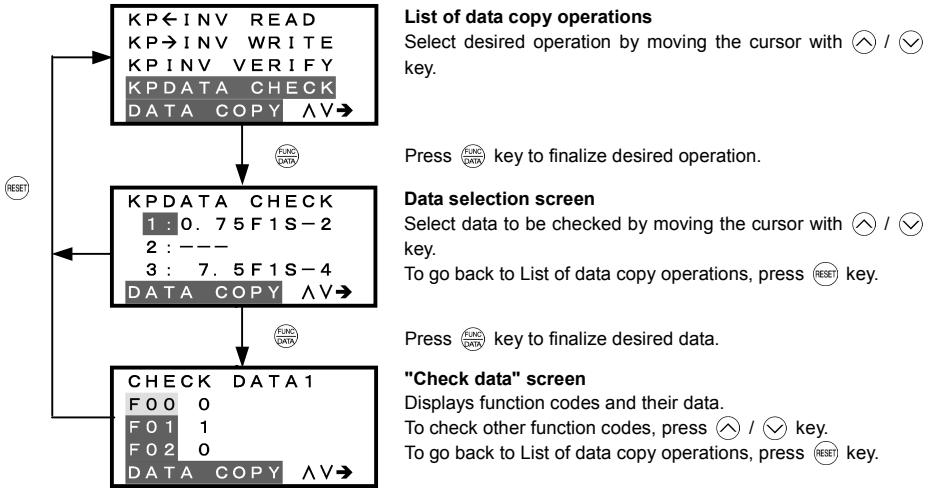
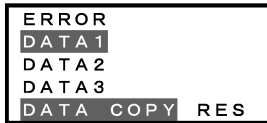

Figure 3.23 Menu Transition for "DATA CHECK"

### Error screen



If no valid data is found in the keypad, this Error screen will appear. (Note)

Figure 3.24 Error Screen for "DATA COPY"

**Note** If an ERROR screen appears during operation, press the  $\text{RESET}$  key to reset the error factor. When Reset is complete, the screen will go back to List of data copy operations.

### 3.4.10 Measuring load factor – "9. LOAD FCTR"

Menu #9 "LOAD FCTR" in Programming Mode allows you to measure the maximum output current, the average output current, and the average braking power. There are two modes of measurement: "hours," in which the measurement takes place for a specified length of time, and "start to stop," in which the measurement takes place from the start of running to the stop.

**Note** If the "start to stop" mode is entered while the inverter is running, the measurement takes place until it is stopped. If the "start to stop" mode is entered while the inverter is stopped, the measurement will take place from the next start of running until it is stopped.

#### Basic key operation











- (1) When the inverter is powered ON, it automatically enters Running Mode. In Running Mode, press the  key to enter Programming Mode. The menu for function selection will be displayed.
- (2) Select "9. LOAD FCTR" by using  and  keys (moving ).
- (3) Press the  key to get the measurement mode selection screen.
- (4) Select the measurement mode, by using  and  keys (moving ).
- (5) Press the  key to start the measurement. For "start to stop" mode, you will be prompted to enter a run command via a confirmation screen. For details, refer to the LCD screen transition chart.
- (6) Press the  key to return to the menu.

Figure 3.25 shows the LCD screen transition starting from the "9. LOAD FCTR" menu.

#### 1) Selecting measurement mode

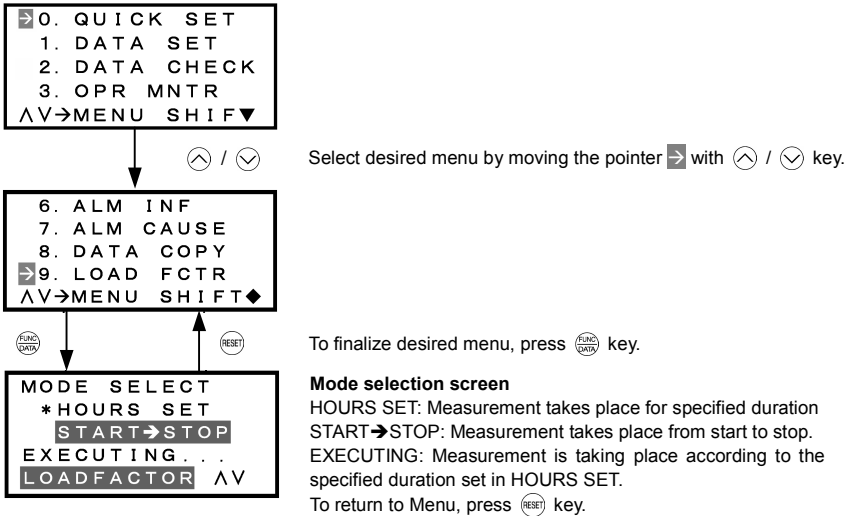

Figure 3.25 Menu Transition for Selecting Measurement Mode

## 2) Selecting "hours set" mode

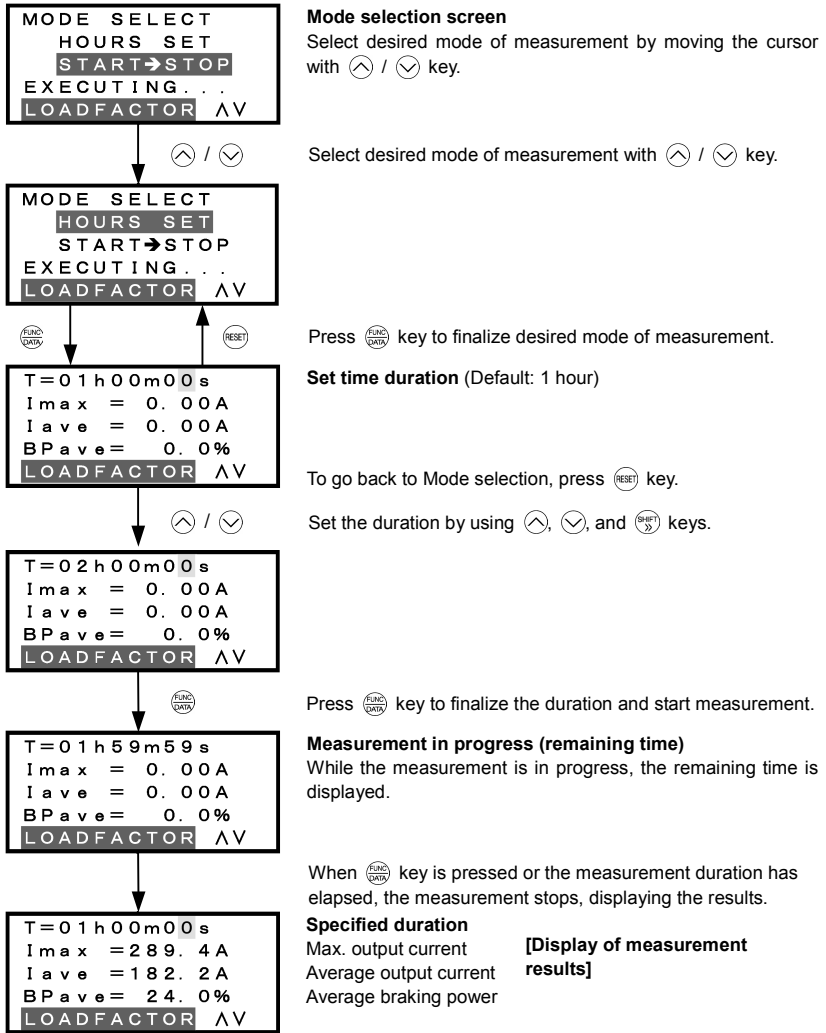

Figure 3.26 Menu Transition for "LOAD FCTR" (hours set mode)

### 3) Selecting "start to stop" mode



#### Mode selection screen

Select desired mode of measurement by moving the cursor with  $\Delta$  /  $\nabla$  key.

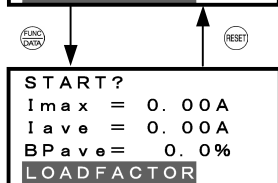

#### Confirmation screen

If OK, press  $\Delta$  key.

To go back to Mode selection, press  $\text{RESET}$  key.

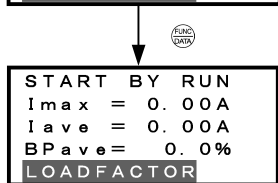

Press  $\Delta$  key to signal "Ready."

#### Waiting for Run command (Standby for measurement)

Upon receiving Run command, the measurement will start. If a Run command has already been received, this screen will be skipped.

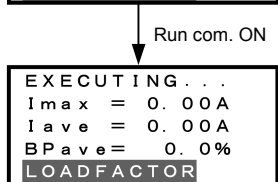

Measurement will start upon receiving Run command.

#### Measurement in progress

The measurement will continue until the inverter is stopped.

To discontinue the measurement, press  $\Delta$  key.

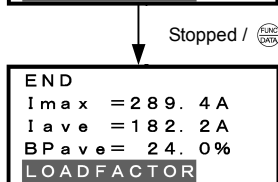

Measurement will stop when the inverter is stopped or you press  $\Delta$  key.

#### Duration

Max. output current

**[Display of measurement results]**

Average output current

Average braking power

To return to Mode selection, press  $\text{RESET}$  key.

Figure 3.27 Menu Transition for "LOAD FCTR" (start to stop mode)

### 4) Going back to Running mode

While the measurement of the load factor is in progress, you can go back to the running mode by pressing the  $\text{PRG}$  key (or, to the Mode selection screen by pressing the  $\text{RESET}$  key).

In these cases, the measurement of the load factor will continue. You can go back to "9. LOAD FCTR" and confirm, on the Mode selection screen, that the measurement is in progress.

After the measurement has ended, you can view the results of the measurement by pressing the  $\Delta$  key on the Mode selection screen.



The results of the measurement will be deleted when the inverter is powered OFF.

### 3.4.11 Changing function codes covered by Quick setup – "10. USER SET"

Menu #10 "USER SET" in Programming Mode allows you to change the set of function codes that are covered by Quick setup.

#### Basic key operation











- (1) When the inverter is powered ON, it automatically enters Running Mode. In Running Mode, press the  key to enter Programming Mode. The menu for function selection will be displayed.
- (2) Select "10. USER SET" by using  and  keys (moving ).
- (3) Press the  key to get the list of function codes.
- (4) Select the function codes to be added or deleted, by using  and  keys (moving ).
- (5) Press the  key to perform the addition or deletion.
- (6) Press the  key to return to the menu.

Figure 3.28 shows the LCD screen transition starting from the "10. USER SET" menu.

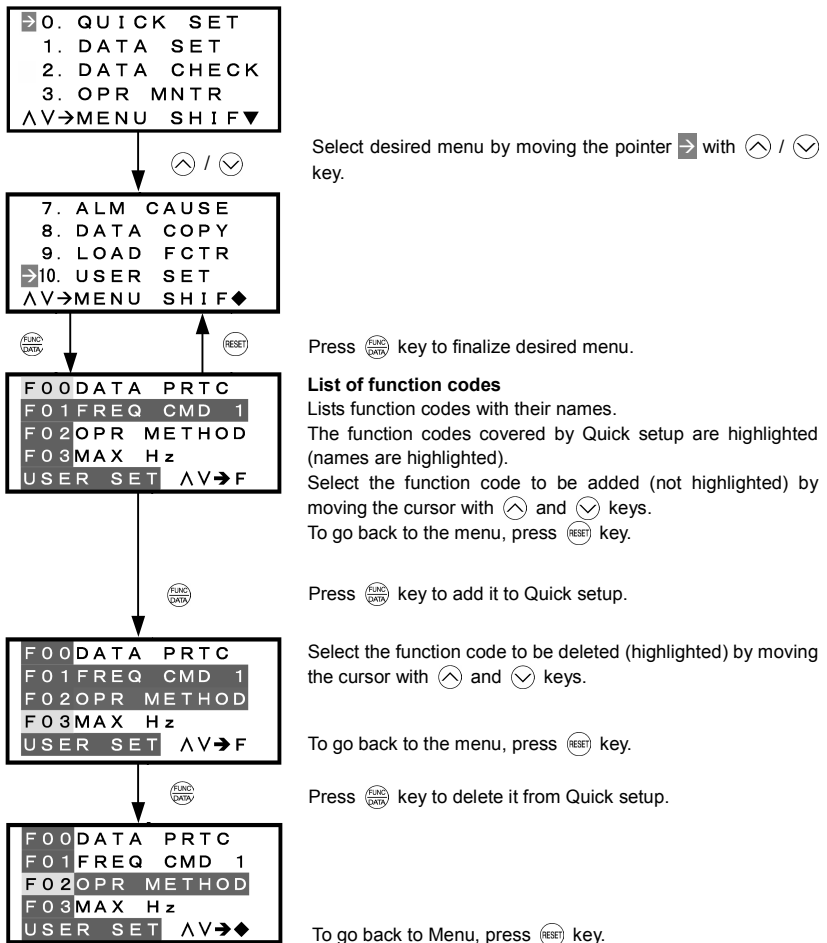

Figure 3.28 Menu Transition for Changing Function Codes Covered by Quick Setup

### 3.4.12 Performing communication debugging – "11. COMM DEBUG"

Menu #11 "COMM DEBUG" in Programming Mode allows you to view the data of communication-related function codes (S, M, W, X, and Z codes) to help debug programs for communication with an upper-level device.

#### Basic key operation

- (1) When the inverter is powered ON, it automatically enters Running Mode. In Running Mode, press the **PPRG** key to enter Programming Mode. The menu for function selection will be displayed.
- (2) Select "11. COMM DEBUG" by using **▲** and **▼** keys (moving **→**).
- (3) Press the **FUNC DATA** key to get the list of communication-related function codes.
- (4) Select the function code, by using **▲** and **▼** keys (moving **→**).
- (5) Press the **FUNC DATA** key to check or change the function code.
- (6) Press the **RESET** key to return to the menu.

Figure 3.29 shows the LCD screen transition starting from the "11. COMM DEBUG" menu.

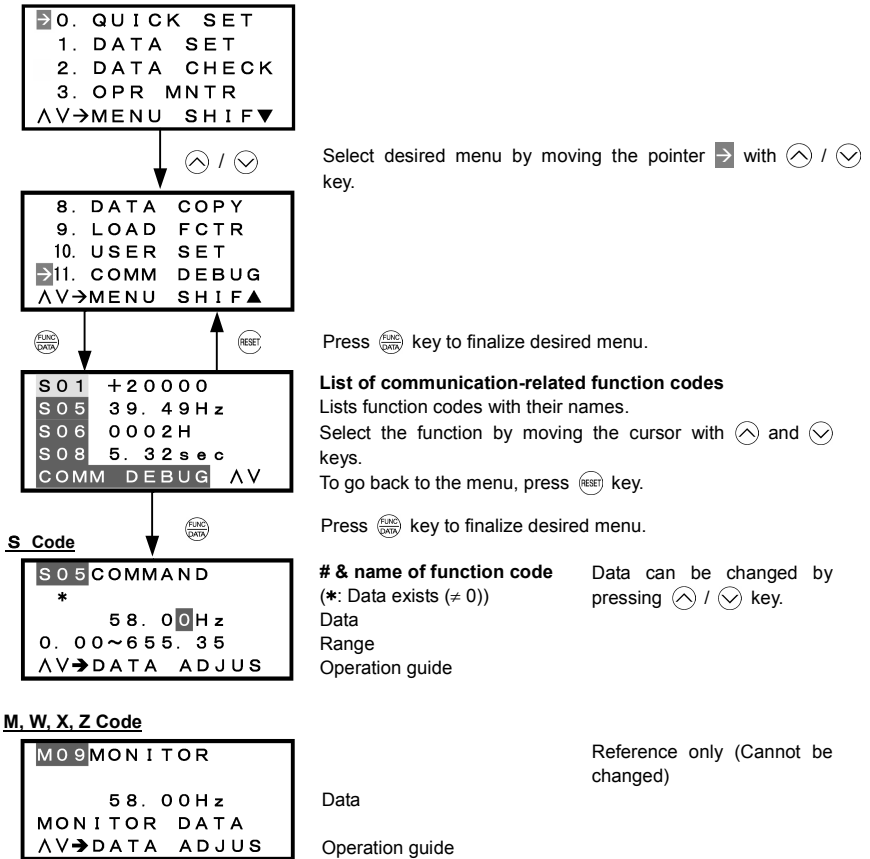

Figure 3.29 Menu Transition for Communication Debugging

### 3.5 Alarm Mode

When a protective function is triggered, resulting in an alarm, the inverter automatically enters the alarm mode, displaying the alarm code on the LED Monitor and the details of the alarm on the LCD Monitor as shown below.

#### If there is no overlapping alarm



Most recent cause; No. of consecutive occurrences  
Cause of alarm  
Operation guide  
Operation guide

Figure 3.30 Without Non-overlapping Alarm

#### If there is an overlapping alarm



Most recent cause; No. of consecutive occurrences  
Cause of alarm (▲ is added if there is an overlapping alarm.)  
Operation guide  
Operation guide

Figure 3.31 With Overlapping Alarm

If there is an overlapping alarm, you can view more detailed information by pressing the  $\odot$  key.

In the examples below, "2 = Er6" corresponds to the first overlapping occurrence, and "3 = Er6" to the second overlapping occurrence.

#### ■ Display of alarm history

In addition to the most recent (current) alarm, you can view three recent alarms and any overlapping alarms by pressing the  $\odot$  /  $\ominus$  key while the most recent one is being displayed.

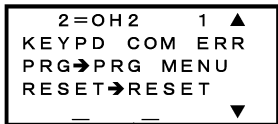

Overlapping alarm; No. of consecutive occurrences  
Cause of alarm  
Operation guide  
Operation guide

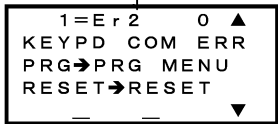

Most recent alarm; No. of consecutive occurrences  
Cause of alarm (▲ is added if there is an overlapping alarm.)  
Operation guide  
Operation guide

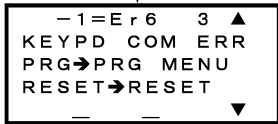

Previous alarm; No. of consecutive occurrences  
Cause of alarm  
Operation guide  
Operation guide

Figure 3.32 Switching of Display of Overlapping Alarm History



■ Display of running status information at the time of alarm

By pressing the **FUNC/DATA** key while an alarm code is displayed, you can view the output frequency, output current, and other data concerning the running status. The data you can view is the same as with "6. ALM INF." Use **▲** and **▼** keys for scrolling pages within the menu.

Pressing the **PRG** key or the **RESET** key while the running status information is displayed will take you back to the display of the alarm code.

■ Transition to Programming mode

By pressing the **PRG** key while alarm information is displayed, you can switch to the Programming mode, in which you can use a variety of features such as changing function code data.

■ Resetting alarm: transition to Running mode

When you remove the cause of the alarm and press the **RESET** key, the alarm condition will be reset, and the inverter will go back to the Running mode.

Figure 3.33 summarizes the menu transition between these modes.

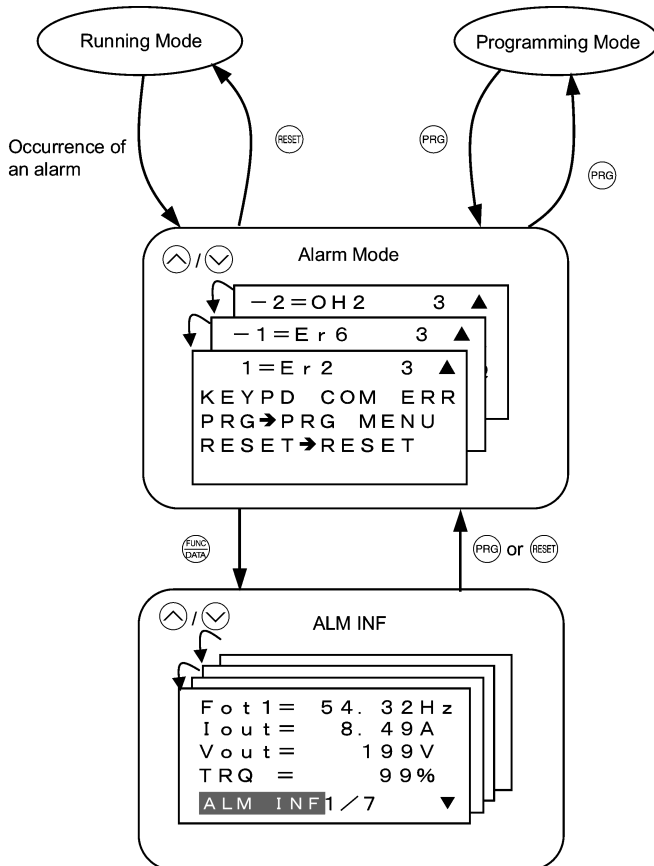







Figure 3.33 Menu Transition in/from Alarm Mode







### 3.6 Other Precautions

For using a multi-function keypad note that your key operation will be differed from ones on a standard keypad (TP-E1) for following points.



#### 3.6.1 Function code setting for F02 (Run and operation)

The  /  key controls to run/stop the motor on the standard keypad (TP-E1) while the rotation command input is required. On the contrary, the  /  /  key on the multi-function keypad controls to run forward/reverse the motor without inputting any rotation command or stop it.

The function code F02 specifies the Run command source to drive the motor.



F02 data	Run command source
0: Keypad	Pressing the  /  /  key runs/stops the motor.
1: Digital input	The terminal command (FWD) or (REV) runs/stops the motor.
2: Keypad (Forward)	The  /  key runs the motor forward or stops it, but does not run it reverse.
3: Keypad (Reverse)	The  /  key runs the motor reverse or stops it, but does not run it forward.

If you select Local by the Remote/Local switching command, operation of the run command from the keypad will be changed by setting of the function code F02.

 For details, refer to “ Switching the operation mode between remote and local” in “3.3.1 Running/stopping the motor.”

#### 3.6.2 Remote/local operation

The multi-function keypad features the  key to switch the operation between remote and local modes.

 For details, refer to “ Switching the operation mode between remote and local” in “3.3.1 Running/stopping the motor.”

### 3.6.3 Tuning motor parameters

The LCD monitor of multi-function keypad shows the lead-through screen for tuning of motor parameters. To tune motor parameters follow screens below.

Entering into tuning motor parameters

Set data 1 or 2 into the function code P04 and press the  key.

```
P 0 4 M-TUN
0 : D I S A B L E
0 ~ 2
^ V → DATA ADJUS
```

Press  key to select the data either 1 or 2 being set to the function code P04.

```
P 0 4 M-TUN
0 : D I S A B L E
1 : A T-S T O P
0 ~ 2
^ V → DATA ADJUS
```



Press  key to select the tuning mode.

```
P 0 4 M-TUN
1 : A T-S T O P

S T A R T B Y R U N
C O M M A N D
```

Waiting for a run command.

Turn on the run command.

Give the specific run command, Run forward or Run reverse. (Note 1)

```
P 0 4 M-TUN
1 : A T-S T O P

E X E C U T I N G . . .
```

Tuning the motor parameters. (Note 2)

End of tuning

```
P 0 4 M-TUN
1 : A T-S T O P

C L O S E B Y R U N
C O M M A N D O F F
```

Turn off the run command.

Upon turning off the run command (while the run command given by the keypad or the link operation is automatically turned off) the lead-through ends the tuning process, and moves to the next function code P06.

```
P 0 6 M-I o
P 0 7 M-% R 1
P 0 8 M-% X
P 9 9 M-S E L E C T
^ V → F N C O D E S H
```

(Note 1) The factory default setting is "Run forward" by using the  key on the keypad. To tune the motor parameters in "Run reverse", change data of the function code F02.

- (Note 2)
- Time needed for tuning while the motor is stopped (P04 = 1) will be less than 40 seconds.
  - In tuning while the motor is running (P04 = 2), the inverter accelerates the motor up to around 50% of the base frequency, starts tuning of motor parameters, and decelerates to stop the motor after the end of tuning. Estimated time needed for tuning in this case will be (acceleration time + 10 + deceleration time) seconds.

# Chapter 4 SPECIFICATIONS

## 4.1 General Specifications

Table 4.1 summarizes the general specifications of the Multi-function Keypad "TP-G1."

Table 4.1 General Specifications

Item	Specifications	Remarks
Enclosure	Front side: IP40; Rear side: IP20	
Environment	Indoor only. Shall be free from corrosive gases, flammable gases, dust, and direct sunlight.	
Ambient temperature (during operation)	-10 to +50°C	
Ambient humidity	5 to 95% RH (no condensation)	
Altitude	1000 m or below	
Vibration	3 mm (max.) : 2 - 9 Hz 9.8 m/s <sup>2</sup> : 9 - 20 Hz 2 m/s <sup>2</sup> : 20 - 55 Hz 1 m/s <sup>2</sup> : 55 - 200 Hz	
Ambient temperature (during storage)	-25 to +65°C	
Ambient humidity (during storage)	5 to 95% RH (no condensation)	
External dimensions	See the figure below.	
Mass	129 g	

### ■ External dimensions

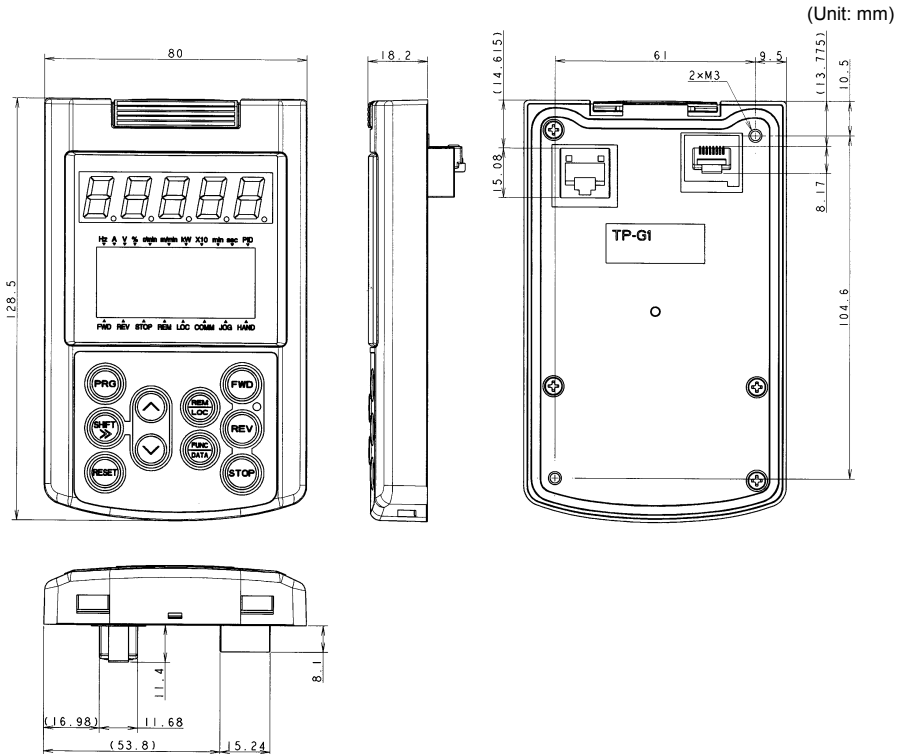

## 4.2 Communication Specifications

Tables 4.2 and 4.3 summarize the communication specifications.

Table 4.2 Hardware Specifications

Item	Specifications	Remarks
No. of inverters connected	One inverter for one Multi-function Keypad	
Connection cable	Shall meet the US ANSI/TIA/EIA-568A Category 5 standard (10BASE-T/100BASE-TX, straight).	A Remote Operation Extension Cable is available as an option (CB-5S, CB-3S, or CB-1S, depending on the distance).
Maximum communication distance	20 m	
Connector	RJ-45 connector	See Table 4.3.

Table 4.3 RJ-45 Connector Pin Assignment

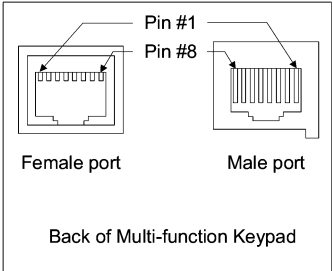
Pin #	Signal name	Description	Remarks
1, 8	Vcc	DC power source for Multi-function Keypad (5 V)	
2, 7	GND	Signal ground	
3, 6	NC	Unassigned (reserved)	
4	DX -	RS485 communication data ( - )	
5	DX +	RS485 communication data ( + )	

**Note** SW3 for the terminating resistor on the control circuit board in the inverter must be set to OFF (open).

## 4.3 Transmission Specifications

Table 4.4 summarizes the transmission specifications.

Table 4.4 Transmission Specifications

Item	Specifications	Remarks
Area code	No need to specify.	There is no need to specify function codes y01 through y10 for RS485 communication, which will be ignored anyway.
Communication protocol	Modbus-RTU	
Synchronization system	Start-stop	
Communication system	Half-duplex	
Communication speed (Baud rate)	19200 bps	
Parity	Even parity	
Stop bit length	1 bit	
Error checking	CRC-16	

MEMO

## **Multi-function Keypad "TP-G1"**

---

### **Instruction Manual**

First Edition, September 2004

Fuji Electric FA Components & Systems Co., Ltd.

---

The purpose of this manual is to provide accurate information in the handling, setting up and operating of Multi-function Keypad "TP-G1" for the FRENIC-Eco series of inverters. Please feel free to send your comments regarding any errors or omissions you may have found, or any suggestions you may have for generally improving the manual.

In no event will Fuji Electric FA Components & Systems Co., Ltd. be liable for any direct or indirect damages resulting from the application of the information in this manual.

---

**Fuji Electric FA Components & Systems Co., Ltd.**

---