

**F**e-Front runners

Variable Torque Load Inverters for Fans and Pumps

# **FRENIC-ECO** Series



# FRENIC **Eco**



## FUJI HVAC INVERTERS

GREAT PERFORMANCE THROUGH DEDICATED DESIGNS  
WELCOME TO NEW GENERATION OF INVERTER  
FOR HEATING, VENTILATING & AIR CONDITIONING.



UL US LISTED

CE

MEH532a

# Variable Torque AC Drives for Fans and Pumps!



## Enhanced Energy Savings !

### Optimizing Energy-Savings for the complete system

In addition to optimizing the control of the applied motor for Energy-Savings, FRENIC-Eco series drives also optimizes power consumption of the drive for maximizing Energy-Savings for the complete system. With regulations expected to call for a reduction of 1% or more in annual energy consumption, Fuji Electric is aiming to optimize energy-savings as a complete system approach and not focusing only on reducing energy consumed by the motor.

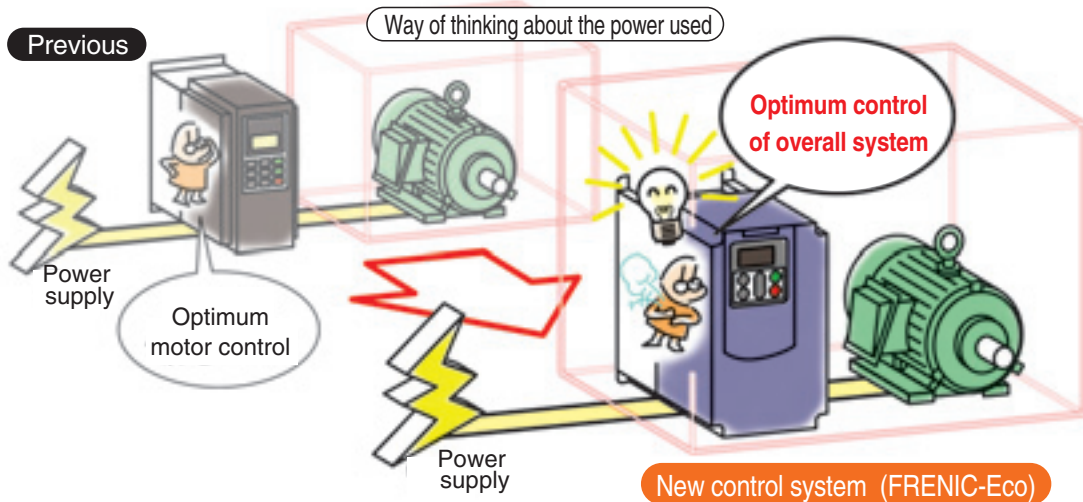

Using this new system, energy savings is several percent improved over that of the previous models.

Kyoto Agreement, which was studied at the Conference on Prevention of Global Warming (COP3), was ratified by Russia in October 2004, and thereby put into effect on February 16, 2005. In the future, the related regulations are calling for a reduction in energy consumption of 1% or more each succeeding year, and therefore, we are aiming to build energy saving features into equipment as a whole. **FRENIC-Eco is the inverter equipped with the industry's highest level of efficiency (low power loss).**

### Power Monitor

Power-related data can be checked via the inverter unit's keypad.

Items
Power (kW)
Cumulative power (kWh)
Cumulative power rates (\$/kWh)

\* Cumulative values can be reset. Cumulative power rates are shown with the power rate set at so much per kWh (display coefficient). Rates in other currency can also be displayed.

■ Energy saving effect compared with Fuji's previous models

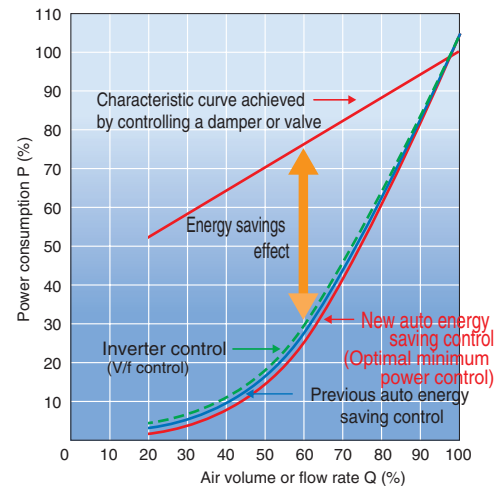

(The effect varies dependent on the motor's characteristics.)



## Long life design that meets your expectation !

### Built with longer lasting replaceable components to give a longer service life!

The design life of replaceable components in each inverter model has been extended to **10 years**. In addition, the capacity of the main circuit capacitors is measured and temperature compensation carried out to match the cumulative operating time of the electrolytic capacitors on the printed circuit board.

Life-limited component name	Designed life
Main circuit capacitors	10 years
Electrolytic capacitors on printed circuit board	10 years
Cooling fan (Note)	10 years

Note: 7 years for 50HP or larger models  
 [Conditions] Ambient temperature: 40°C (104°F), Load factor: 80% of inverter's rated current  
 \*The life may be shorter depending on surrounding conditions.



# Saves energy and cuts costs.



Maintenance is simplified for both the drive and equipment!

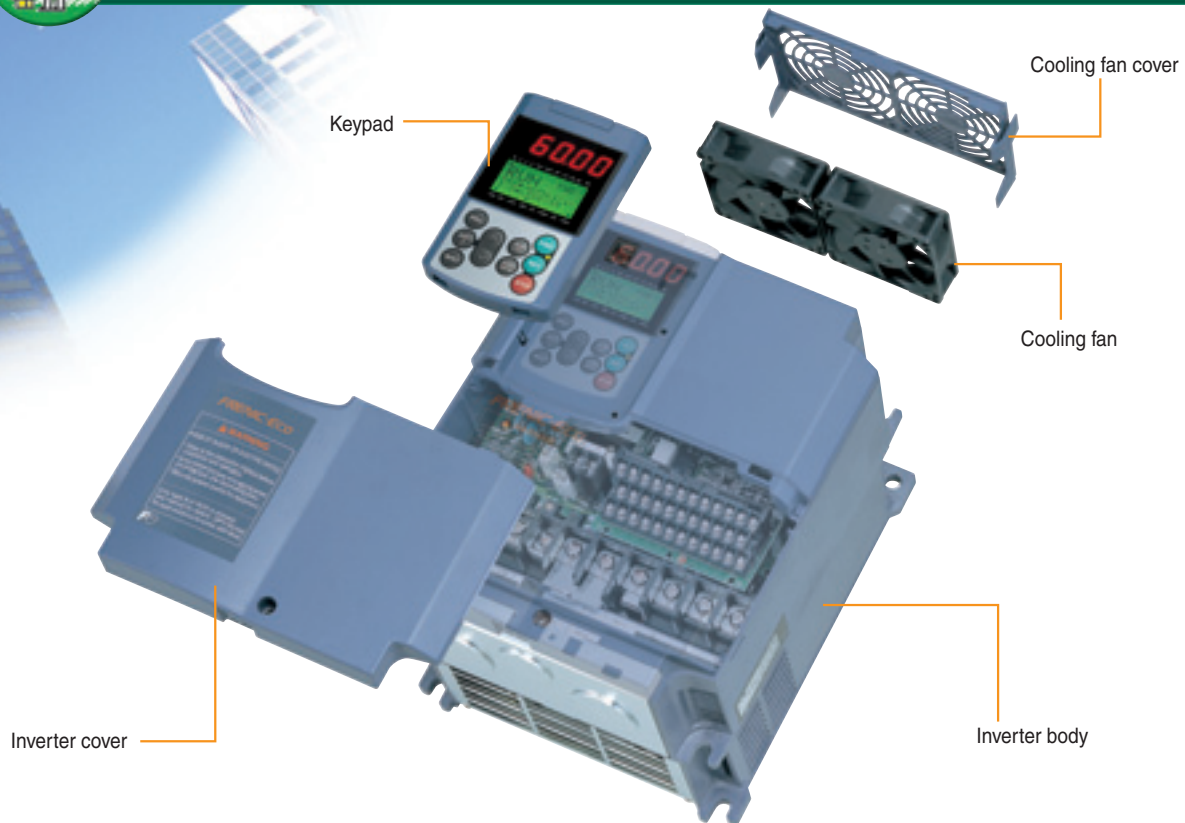

## The service life information for replaceable inverter components is displayed.

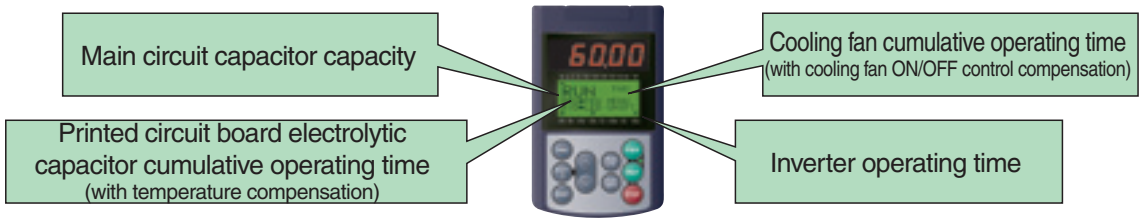

## Simple replacement of replaceable components

### Cooling fan replacement procedure

●20HP model



Cooling cover can be removed with one touch.

●60HP model



The inverter's mounting screws and power connector can be removed from the front.



Disconnect the power connector and change the cooling fan cartridge.



The cooling fan cartridge can be replaced by sliding the holder out to the front

Industry first

## Information is displayed with equipment maintenance in mind.

In addition to maintenance information for the inverter unit, information related to equipment maintenance is also displayed.

Item	Purpose
Motor cumulative operating time (hours)	The cumulative operating time of the equipment the inverter is used with is calculated. <b>Example of Use</b> If the inverter is used for fan control, this time can be used as a criterion for replacing the belts used on pulleys.
Number of starts (times)	The number of times the inverter is run and stopped can be counted. <b>Example of Use</b> The number of times the equipment is started and stopped is recorded, so this can be used as a criterion for replacing parts in equipment where starting and stopping is a burden on the machine.

- Specifications
- Protective Functions
- External Dimensions
- Wiring Diagram
- Terminal Functions
- Keypad Operations
- Function Settings
- Peripheral Equipment Connection Diagrams
- Options
- Warranty



# Equipped with the optimum functions for HVAC (Air conditioning systems) !

## Operation is continued even after the momentary power failure thanks to the auto-restart function.

Even if a momentary power failure occurs, load inertia of a fan or blower, etc. is used to maintain the motor's operation while the motor's operating speed gradually drops, and enables the motor to restart operation without stopping. (The motor may stop on occasion due to the load's inertia.)

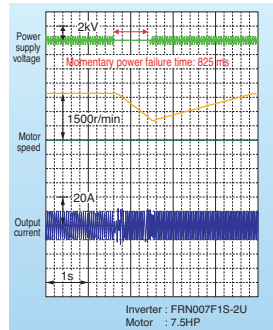

## A pick-up function provides smooth starts.

If you desire to run a fan which the inverter is not currently running and which is turning free. This function will pick up on its motion regardless of the direction it is turning and take operation. Momentary switching is performed in the inverter from the commercial power supply and provides a convenient function when starting motors, etc.

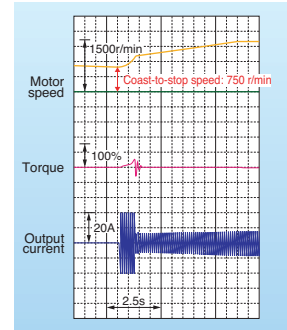

## Tripless operation through regenerated current avoidance control

Deceleration time is controlled to match the internal energy level generated in the inverter, and so deceleration and stopping is accomplished without tripping due to overload.

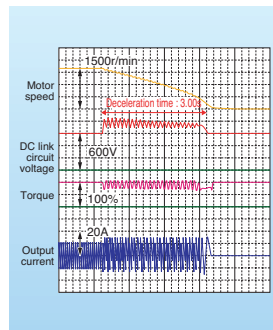

## Even greater energy savings through the low water volume stop function

When there is pump operation accompanying "pressure drop" that occurs due to pressure loss or leakage, etc. in the piping, etc., or at times when the pump runs repeatedly to obtain a small volume of water, this function controls the pump's operation, preventing it from being driven with the water volume below a predetermined level, and thus reducing wasteful pump operation and saving even more energy.

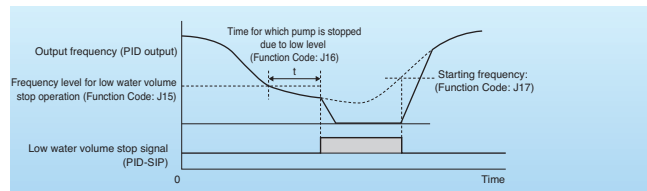

## The equipment's operating condition is determined by the low torque detection function.

The inverter determines the load state of the connected motor and if it drops below a predetermined level, it judges that a "Low Torque" state exists and outputs a signal to that effect. In this way, any trouble that occurs in the equipment (such as a belt on a pulley breaking) can be detected by the inverter.

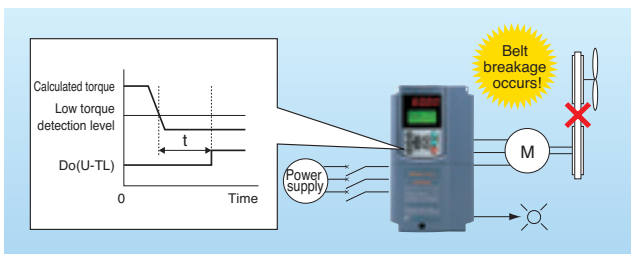

## Also avoids operation signal trouble through the command loss detection function.

If the frequency signals (0 to 10V, 4 to 20mA, multi-step speed operation signals, communications, etc.) that are connected to the inverter are lost, signals are output as a "command loss," indicating that a frequency command was lost. In addition, output frequency when the command loss occurred can be set in advance, so even if a frequency signal line to equipment is broken due to machine vibration, etc., machine operation can be continued uninterrupted.

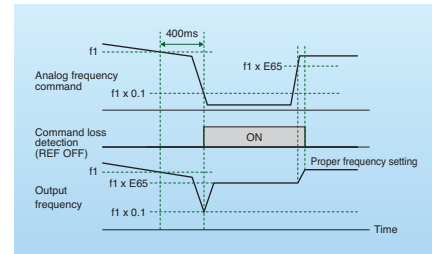

### Simple circuit configuration using the commercial line switching sequence

Inverters are equipped with the commercial line start function that enables switching between the commercial line and the inverter by an external sequence. In addition, inverters are equipped with two types of built-in sequence for operation with commercial line; i.e., Fuji's standard sequence and the automatic switching sequence to the commercial line activated when the inverter alarm occurs.

Note: The latter sequence differs from the one for forcible switching to the commercial line during inverter breakdown.

### Inverters are equipped with full PID control functions.

Low water level stop function, deviation alarm and absolute value alarm outputs have been added to the PID regulator which performs such tasks as temperature, pressure and flow rate control. In addition, an anti-reset windup function that prevents PID control overshoot as well as a PID output limiter and integral hold/reset signal provide easy-to-adjust PID control functions.

### Continuous equipment operation through overload avoidance control

If the load on a fan or pulley increases due some foreign object overloading around the shaft, etc., and the inverter's internal temperature rises suddenly or the ambient temperature rises to an abnormal level, etc., causing an inverter overload state, the motor's speed is lowered, reducing the load and enabling operation to continue.

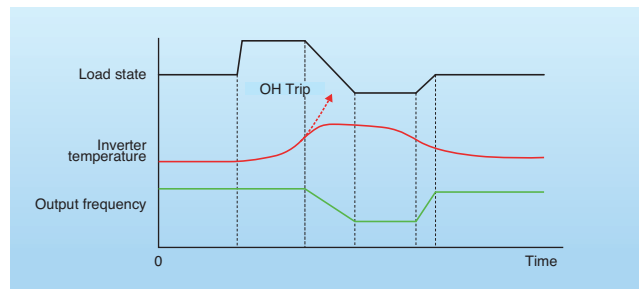

### Simple Sequences through Universal DI/DO

Signals can be transmitted to a higher level controller or PC by connecting digital signals to an inverter from different types of sensors, such as a float switch used to judge the level in a water storage tank, which serve as peripheral devices to the inverter. In the case of small-scale equipment, even if a programmable logic controller (PLC) is not used, information can be sent to a higher-level system easily.

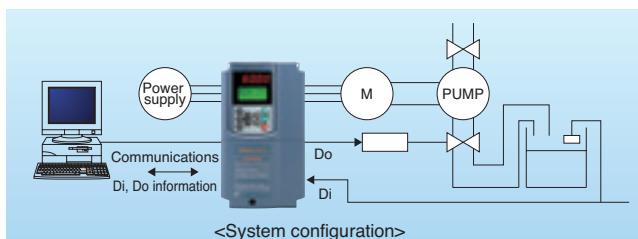

### Elimination of display devices by use of the analog input monitor

Using the display coefficient of signals from devices such as flow rate or temperature sensors in air conditioning equipment, these signals can be converted into physical values such as temperature and pressure and displayed on the inverter's keypad without making the use of exclusive flow meters or air flow meters.

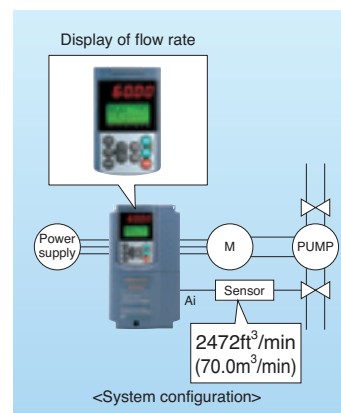

### Improved capability for handling regenerated energy

When the inverter slows down and stops the motor, if the braking energy regenerated by the motor exceeds the braking capacity of the inverter's main circuit capacitor, the inverter will trip. At such a time, if even a little excess energy trips the inverter, using this function you may be able to absorb the excess braking energy without connecting to a braking resistor.

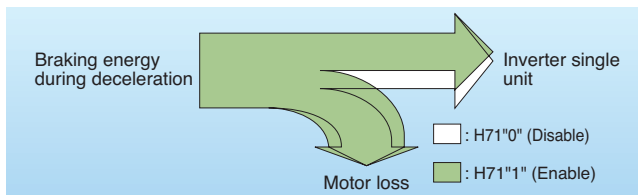

### Other convenient functions

#### ● Motor condensation prevention function

Prevents condensation of the motor from occurring in cases where the surrounding temperature changes suddenly while the motor is stopped.

#### ● Motor speed display with percent

The inverter's keypad displays the operating frequency (Hz) or the motor's rotational speed (r/min), but it can also display the maximum speed as 100%, so it is easy to get a grasp of the equipment's operating state.

## Dynamic Rotation of Pump Motors

### ●With a fixed inverter-driven motor

This configuration consists of a motor driven by the inverter (M0) and motors driven by commercial power (M1 to M4).

The inverter-driven motor is fixed at M0 and is controlled for variable speed. When the inverter-driven motor M0 alone cannot sustain the desired discharge flowrate, the inverter starts one or more motors driven by commercial power as necessary.

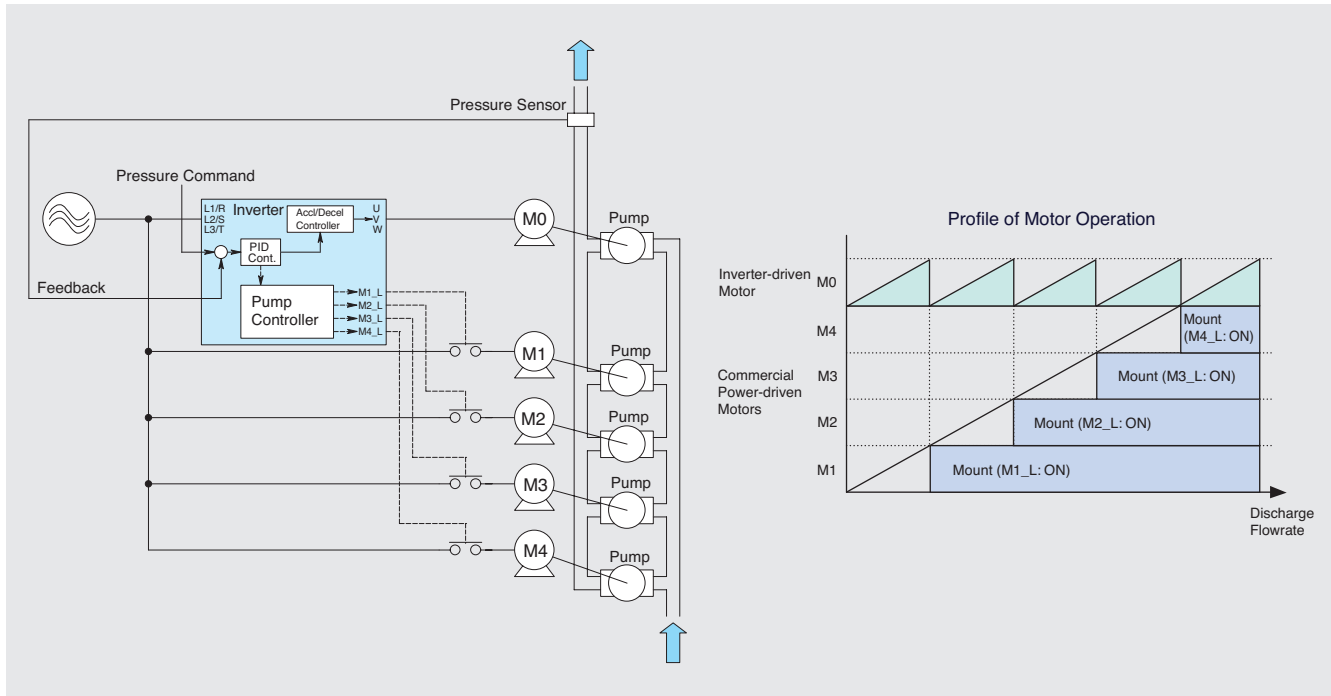

### ●With a floating inverter-driven motor

In this configuration, all the motors can be driven by the inverter or commercial power. At the start of operation, each motor is driven by the inverter and is controlled for varying speed. When the first motor alone cannot sustain the desired discharge flowrate, it is switched to commercial-power operation, and the inverter drives the second motor.

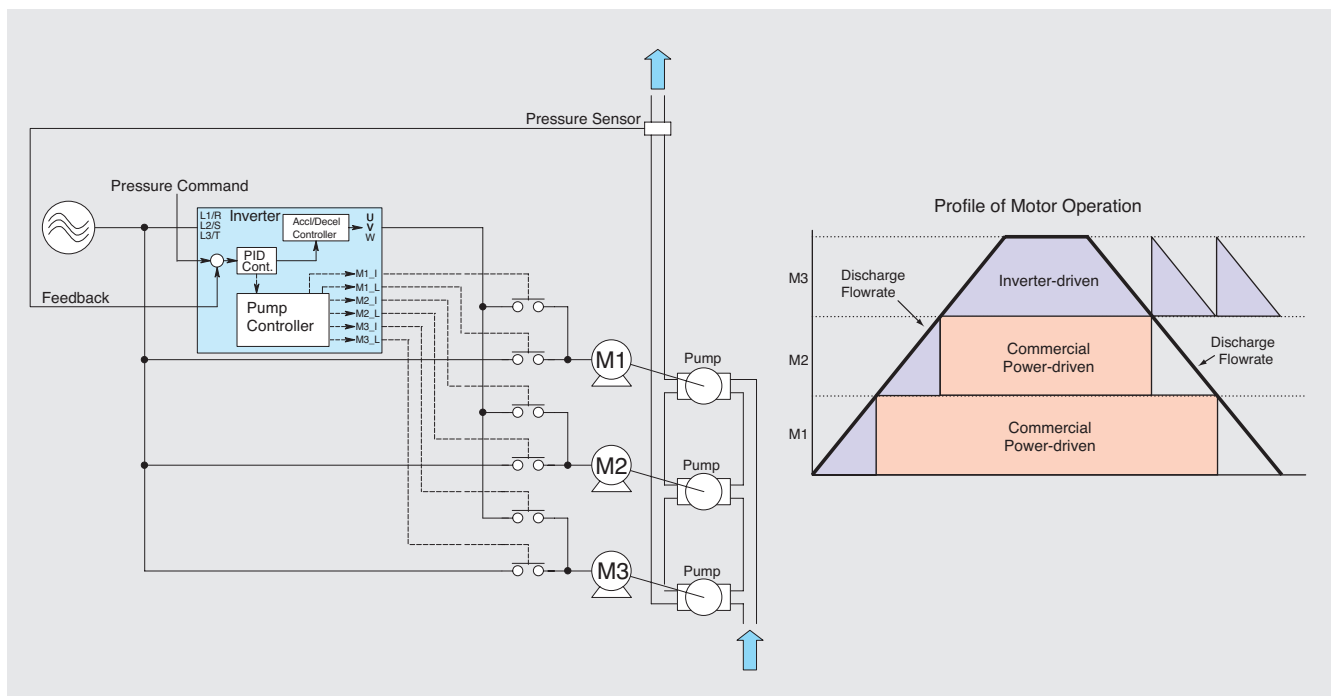



## Consideration of the surrounding environment and panel design !

### Side-by-side installation saves space!

If multiple inverter units are to be used in a panel and the panel is designed accordingly, it is possible to mount these inverters side-by-side horizontally, so the panel can be designed to take up less space. (5HP for 208V, 7.5HP for 460V or smaller capacity inverters)



### Built-in charging resistors (in rush current suppressing resistors) help reduce peripheral equipment sizing!

When the FRENIC-Eco series (Fuji's FRENIC-Mini Series and 11 Series) is used, the charging resistors (in rush current suppressing resistors) built into the inverter as standard equipment suppress in rush current when motors are started, so compared to operation of motors with direct input, peripheral equipment with reduced capacity can be selected.

### Cooling outside the panel is made possible by an external cooling attachment!

Use of the external cooling attachment (optional on 30HP for 208V, 40HP for 460V or smaller inverters and standard on 40HP for 208V, 50HP for 460V or larger inverters) to cool the inverter outside the panel makes it possible to install a simple cooling system outside the panel.



## Operator-friendly features !

### A multi-function keypad is available as standard.

- Includes an easier to see LCD with backlight.
- It has a large 7-segment, 5-digit LED display.
- It is possible to add and delete quick setup items.
- A remote/local key has been added.
- Copying up to 3 sets of data is possible.



### A keypad that enables remote operation is standard equipment.

The standard keypad has a decorative cover on the bottom that can be slid sideways and removed. A LAN cable can be used to connect the panel, making it possible to use it as a remote operation keypad.



### Personal computer loader software



Store, manage and verify settings data.



Monitoring



Real-time tracing



Maintenance Information



Operation



## Network compatibility !

- RS-485 communication is standard.  
Selectable from Modbus-RTU, Metasys-N2, FLN P1.
- It is compatible with the following networks by inserting the option card.

- Device Net
- LONWORKS Network
- PROFIBUS-DP
- BACnet (available soon)



## Global compatibility !

European Union  
EC Regulation (CE mark)



North America/Canada  
UL Standards (cUL certified)



- Compliance with standards
- Synk/source switchable
- Wide voltage range
- Multi-function keypad displaying multiple languages (Japanese, English, German, French, Spanish, Italian)



## Model List

Applicable motor rating (HP)	Standard type	
	Three-phase 208V	Three-phase 460V
1	FRN001F1S-2U	FRN001F1S-4U
2	FRN002F1S-2U	FRN002F1S-4U
3	FRN003F1S-2U	FRN003F1S-4U
5	FRN005F1S-2U	FRN005F1S-4U
7.5	FRN007F1S-2U	FRN007F1S-4U
10	FRN010F1S-2U	FRN010F1S-4U
15	FRN015F1S-2U	FRN015F1S-4U
20	FRN020F1S-2U	FRN020F1S-4U
25	FRN025F1S-2U	FRN025F1S-4U
30	FRN030F1S-2U	FRN030F1S-4U
40	FRN040F1S-2U	FRN040F1S-4U
50	FRN050F1S-2U	FRN050F1S-4U
60	FRN060F1S-2U	FRN060F1S-4U
75	FRN075F1S-2U	FRN075F1S-4U
100	FRN100F1S-2U	FRN100F1S-4U
125	FRN125F1S-2U	FRN125F1S-4U
150		FRN150F1S-4U
200		FRN200F1S-4U
250		FRN250F1S-4U
300		FRN300F1S-4U
350		FRN350F1S-4U
400		FRN400F1S-4U
450		FRN450F1S-4U
500		FRN500F1S-4U
600		FRN600F1S-4U
700		FRN700F1S-4U
800		FRN800F1S-4U
900		FRN900F1S-4U

## How to read the model number

**FRN 007 F 1 S - 2 U**

Code	Series name
FRN	FRENIC series

Code	Applicable motor rating [HP]
001	1HP
002	2HP
003	3HP
005	5HP
007	7.5HP
010	10HP
015	15HP
020	20HP
∞	∞
700	700HP
800	800HP
900	900HP

Code	Application range
F	Fans and pumps (For variable torque load)

Code	Developed inverter series
1	1

Code	Version/Manual
U	USA/English

Code	Input power supply
2	3-phase 208V
4	3-phase 460V

Code	Structure
S	Standard type(IP20/IP00)

## How does using an inverter save me energy?

- If you run a fan or pump and you have damper (valve) control or control it with an inverter, the relation between the air flow (flow rate) and the required power, as well as the relation between the power supply frequency  $f_s$  (Hz) and operating frequency with the inverter  $f_{INV}$  (Hz) are as shown in the table at right.
- If the air flow rate is low, the energy saving effect is particularly great.

Item	Relation between $f_s$ (Hz) and $f_{INV}$ (Hz) (Note 1)	Examples with actual numbers (Note 2)	
		$f_{INV}=45$ (Hz) (10%DOWN)	$f_{INV}=30$ (Hz) (40%DOWN)
Air flow or flow rate Q [m <sup>3</sup> /min]	$Q \propto \left(\frac{f_{INV}}{f_s}\right)$	$Q = \frac{45}{50} \cdot Q = 0.9 \cdot Q$	$Q = \frac{30}{50} \cdot Q = 0.6 \cdot Q$
Head H (m) or pressure H [Pa]	$H \propto \left(\frac{f_{INV}}{f_s}\right)^2$	$H = \left(\frac{45}{50}\right)^2 \cdot H = 0.81 \cdot H$	$H = \left(\frac{30}{50}\right)^2 \cdot H = 0.36 \cdot H$
Shaft power or power consumption P [W]	$P \propto \left(\frac{f_{INV}}{f_s}\right)^3$	$P = \left(\frac{45}{50}\right)^3 \cdot P = 0.729 \cdot P$	$P = \left(\frac{30}{50}\right)^3 \cdot P = 0.216 \cdot P$

Note 1: Power supply frequency  $f_s$  (Hz); operating frequency with the inverter  $f_{INV}$  (Hz) Note 2: When  $f_s = 50$  (Hz)

## Formula (theoretical) for calculating the energy savings effect achieved by an inverter

### ● Fan equipment

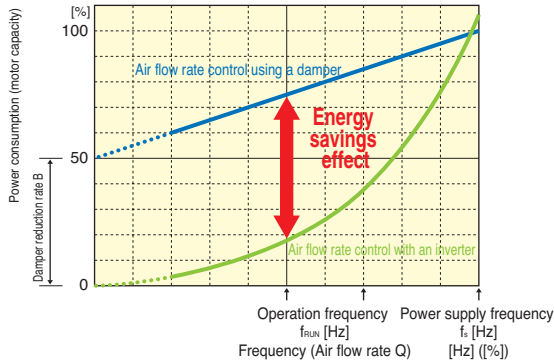

#### ■ Energy savings effect in monetary terms: Ms [\$/year]

$$= \text{Power charges at the time the damper was used} - \text{Power charges MINV when an inverter is used} [$/year]$$

#### ■ Power charges when a damper is used: Mo [\$/year]

$$= (P \times (1 - B) \times Q + P \times B) \times \frac{1}{\eta_M} \times D \times H \times M$$

#### ■ Power charges when an inverter is used: MINV [\$/year]

$$= \left( P \times \left( \frac{f_{RUN}}{f_s} \right)^3 \right) \times \frac{1}{\eta_M} \times \frac{1}{\eta_{INV}} \times D \times H \times M$$

P: Motor capacity (kW) D: Annual operating days (day/year)  
 B: Damper reduction rate (%) H: Operating hours per day (h/day)  
 Q: Air flow (%) M: Power charge unit price (\$/kWh)  
 $f_{RUN}$ : Inverter operating frequency (Hz)  $\eta_M$ : Motor efficiency (%)  
 $f_s$ : Power supply frequency (Hz)  $\eta_{INV}$ : Inverter efficiency (%)

(Note 1) The air flow rate Q (%) shows the air flow when the damper is closed (%). The operating frequency  $f_{RUN}$  (Hz) when using an inverter is being proportional to the air flow Q (%), so decide a  $f_{RUN}$  (Hz) value so that the relationship  $Q (\%) = f_{RUN} (\text{Hz}) / f_s (\text{Hz})$  is established.

For example, if air flow Q: 60 (%) = Power supply frequency  $f_s$ : 50 (Hz)  
 $Q (\%) = f_{RUN} (\text{Hz}) / f_s (\text{Hz})$   
 $60 (\%) = f_{RUN} (\text{Hz}) / 50 (\text{Hz}) \rightarrow f_{RUN} (\text{Hz}) = 50 (\text{Hz}) \times 0.6 = 30 (\text{Hz})$

(Note 2) The air flow rate Q (%) does not show the damper's opening angle, but rather the air flow (%) at the point when the opening angle is adjusted from the damper's fully open state. Depending on the type of damper, there may not be a proportional relation between the opening angle and the air flow, so exercise caution.

### ● Pump equipment

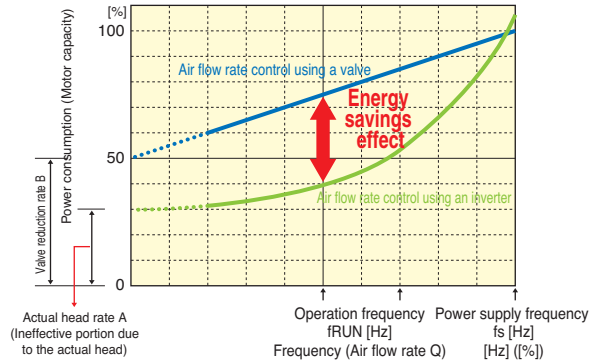

#### ■ Monetary amount of energy savings effect: Ms [\$/year]

$$= \text{Power charge Mv when a valve is used} - \text{Power charge MINV when an inverter is used} [$/year]$$

#### ■ Power charge when a valve is used: Mv [\$/year]

$$= (P \times (1 - B) \times Q + P \times B) \times \frac{1}{\eta_M} \times D \times H \times M$$

#### ■ Power charge when an inverter is used: MINV [\$/year]

$$= \left( (P - P \times A) \times \left( \frac{f_{RUN}}{f_s} \right)^3 + P \times A \right) \times \frac{1}{\eta_M} \times \frac{1}{\eta_{INV}} \times D \times H \times M$$

P: Motor capacity (kW) D: Annual operating days (day/year)  
 A: Actual head rate (%) H: Operating hours per day (h/day)  
 B: Valve reduction rate (%) M: Power charge unit price (\$/kWh)  
 Q: Flow rate (%)  $\eta_M$ : Motor efficiency (%)  
 $f_{RUN}$ : Inverter operating frequency (Hz)  $\eta_{INV}$ : Inverter efficiency (%)  
 $f_s$ : Power supply frequency (Hz)

(Note 1) The actual head rate A (%) is determined by the pump's load characteristics and is a rate that the power consumption (motor capacity) is multiplied by. See the following calculation formula.

$$\text{Actual head rate A (\%)} = \frac{\text{Actual head (m)}}{\text{Loss head (m)}}$$

(Note 2) The flow rate Q (%) value shows a volume (%) when the flow rate is restricted by the closing of the valve. The operating frequency when an inverter is used  $f_{RUN}$  (Hz) is proportional to the flow rate Q (%), so decide a  $f_{RUN}$  (Hz) so that the relationship  $Q (\%) = f_{RUN} (\text{Hz}) / f_s (\text{Hz})$  can be established. For example, if the flow rate Q: 50 (%) and the power supply frequency  $f_s$  is 50Hz,  $Q (\%) = f_{RUN} (\text{Hz}) / f_s (\text{Hz})$   
 $50 (\%) = f_{RUN} (\text{Hz}) / 50 (\text{Hz}) \rightarrow f_{RUN} (\text{Hz}) = 50 (\text{Hz}) \times 0.6 = 30 (\text{Hz})$

(Note 3) The flow rate Q (%) does not show the valve's opening angle, but rather the flow rate (%) at the point when the opening angle is adjusted from the valve's fully open state. Depending on the type of valve, there may not be a proportional relation between the opening angle and the flow rate, so exercise caution.

## Energy Savings effect of replacing damper (valve) control with inverter control

Example: The energy savings effect on an office's air conditioning equipment if the operating pattern is as follows: Air flow: 85% for 2,000 hrs, and 60% for 2,000 hrs. Total 4,000 hrs/year. Motor output is 15kW x 1 unit.

### ● Under damper (valve) control, the required power is as follows:

$$(15\text{kW} \times 91\% \times 2,000 \text{ hrs.}) + (15\text{kW} \times 76\% \times 2,000 \text{ hrs.}) = 50,100\text{kWh}$$

Air flow rate 85%                      Air flow rate 60%

### ● If an inverter is used and the motor's rotational speed is controlled, the required power is as follows:

$$(15\text{kW} \times 61\% \times 2,000 \text{ hrs.}) + (15\text{kW} \times 22\% \times 2,000 \text{ hrs.}) = 24,900\text{kWh}$$

Air flow rate 85%                      Air flow rate 60%

### ● The power saving effect when the power charges are \$0.087/kWh is

$$25,200\text{kWh} \times \$0.087 = \$2,192/\text{year}$$

### ● The amount of time it takes to amortize the equipment cost if the inverter's cost is \$2,348 is

$$\$2,348 / \$2,192 = 1.1 \text{ years}$$

### ● Also, if we let the CO<sub>2</sub> emissions coefficient be 0.12 kg/kWh (environmental statistics from the Environmental Department of the Environmental Agency), the annual CO<sub>2</sub> reduction amounts to

$$25,200\text{kWh} \times 0.12 \text{ kg/kWh} = 3,024\text{kg/year}$$

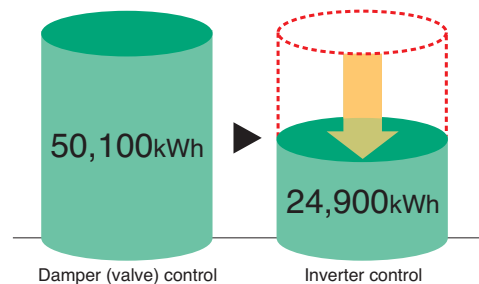

### Energy savings effect

$$50,100\text{kWh} - 24,900\text{kWh} = 25,200\text{kWh/year}$$

## Examples of measurements with actual equipment

### ■ Exhaust fan (generating variable torque load)

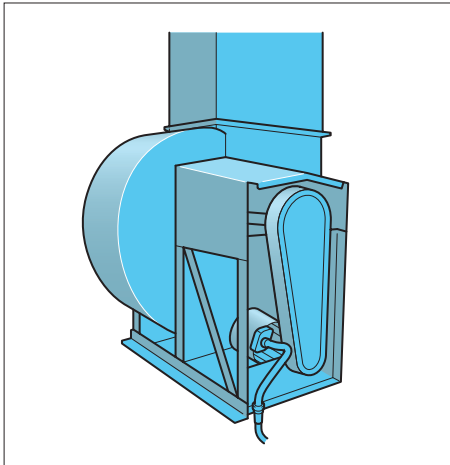

- Motor capacity and inverter capacity
  - Motor capacity : 30HP
  - Inverter model : FRN030F1S-2U
  - DC REACTOR : DCR2-22A

● Power reduction rate and energy saving effect amount

Item	Operation using commercial power	Inverter-controlled operation		
		45	40	35
Operation frequency (Hz)	50	45	40	35
Average power use (kW)	17.2	13.1	9.10	6.23
Power reduction rate (%)	-	▲30.7	▲47.1	▲63.8
Annual power charge (\$)	11,133	8,479	5,890	4,032
Annual amount (\$) of energy saving effect	-	2,653	5,242	7,096
Annual CO <sub>2</sub> reduction volume (kg/year)	-	3,660	7,232	9,794

- Operating conditions
  - Annual operating days : 310 (days/year)
  - Working hours per day : 24 (hrs/day)
  - Power charge unit price : \$0.087/kWh

### ■ Cooling tower (generating variable torque load)

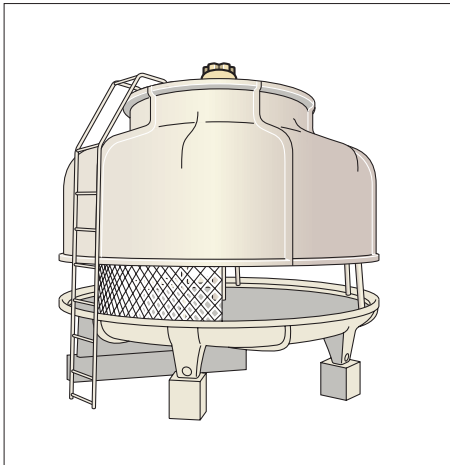

- Motor capacity and Inverter capacity
  - Motor capacity : 7.5HP
  - Inverter model : FRN007F1S-2U
  - DC REACTOR : DCR2-5.5

● Power reduction rate and energy saving effect amount

Item	Operation using commercial power	Inverter-controlled operation		
		45	40	35
Operation frequency (Hz)	60	45	40	35
Average power use (kW)	5.18	2.31	1.63	1.10
Power reduction rate (%)	-	▲55.4	▲68.5	▲78.8
Annual power charge (\$)	2,703	1,205	850	574
Annual amount (\$) of energy savings effect	-	1,506	1,851	769
Annual CO <sub>2</sub> reduction volume (kg/year)	-	2,066	2,556	2,938

- Operating conditions
  - Annual operating days : 300 (days/year)
  - Working hours per day : 20 (hrs/day)
  - Power charge unit price : \$0.087/kWh

### ■ Mist collector (generating variable torque load)

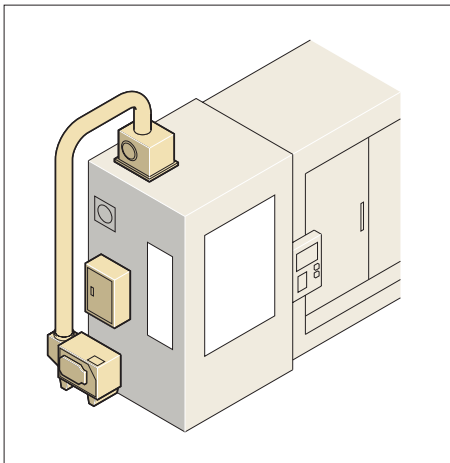

- Motor capacity and Inverter capacity
  - Motor capacity : 5HP
  - Inverter Model : FRN005F1S-2U
  - DC REACTOR : DCR2-3.7

● Power reduction rate and energy saving effect amount

Item	Operation using commercial power	Inverter-controlled operation		
		45	40	35
Operation frequency (Hz)	60	45	40	35
Average power use (kW)	3.27	1.44	0.99	0.69
Power reduction rate (%)	-	▲56.0	▲69.7	▲78.9
Annual power charge (\$)	1,479	651	447	312
Annual amount (\$) of energy savings effect	-	827	1,029	1,166
Annual CO <sub>2</sub> reduction volume (kg/year)	-	1,142	1,423	1,610

- Operating conditions
  - Annual operating days : 260 (days/year)
  - Working hours per day : 20 (hrs/day)
  - Power charge unit price : \$0.087/kWh

Conduct a search. You can study energy savings with the following types of equipment.



- Air conditioning fans
- AHU
- Dust collectors
- Mist -collectors
- Exhaust fans
- Package air conditioners, etc.



- Cooling water pumps
- Circulating pumps
- Cleaning pump
- Roots blowers
- Coolant pumps
- Water cooler pumps, etc.

## ■ Three-phase 208V

Item		Specifications																
Type (FRN --- F1S-2U)		001	002	003	005	007	010	015	020	025	030	040	050	060	075	100	125	
Nominal applied motor [HP]		*1	1	2	3	5	7.5	10	15	20	25	30	40	50	60	75	100	125
Output ratings	Rated capacity [kVA]	*2	1.6	2.7	3.8	6.0	9.0	11	16	21	27	31	41	51	60	76	98	123
	Rated voltage [V]	*3	Three-phase, 200V to 240V (With AVR function)										Three-phase, 200V to 230V (With AVR function)					
	Rated current [A]	*4	4.6	7.5	10.6	16.7	25	31	47	60	75	88	114	143	169	211	273	343
	Overload capability		120% of rated current for 1min.															
	Rated frequency		50, 60 Hz															
Input ratings	Phases, voltage, frequency	Main power supply	Three-phase, 200 to 240V, 50/60Hz										Three-phase, 200 to 220V, 50Hz Three-phase, 200 to 230V, 60Hz					
		Auxiliary control power input	Single-phase, 200 to 240V, 50/60Hz										Single-phase, 200 to 230V, 50/60Hz					
		Auxiliary fan power input	*5	None										Single-phase, 200 to 220V, 50Hz Single-phase, 200 to 230V, 60Hz				
	Voltage/frequency variations		Voltage: +10 to -15% (Voltage unbalance 2% or less) *9, Frequency: +5 to -5%															
	Rated current [A]	*6	(with DCR)	3.1	5.8	8.7	14.5	20.6	27.5	41.3	55.1	68.8	82.6	109	134	160	199	270
		(without DCR)	5.1	9.1	12.9	21.5	30.8	40.8	59.4	76.6	94.0	110	144	179	215	—	—	—
Required power supply capacity [kVA]	*7	1.2	2.2	3.2	5.3	7.5	10	15	20	25	30	40	49	58	72	98	120	
Braking	Torque [%]	*8	20.0										10 to 15					
	DC injection braking		Starting frequency: 0.0 to 60.0Hz, Braking time: 0.0 to 30.0s, Braking level: 0 to 60%															
DC reactor (DCR)		Option												Standard				
Applicable safety standards		UL508C, C22.2 No.14, EN50178-1997															UL508C C22.2 No.14	
Enclosure (IEC60529)		IP20, UL open type										IP00, UL open type						
Cooling method		Natural cooling	Fan cooling															
Mass [lbs(kg)]		7.1 (3.2)	7.3 (3.3)	7.3 (3.3)	7.5 (3.4)	13 (5.8)	13 (6.0)	15 (6.9)	21 (9.7)	21 (9.7)	25 (11.5)	51 (23)	73 (33)	75 (34)	90 (41)	90 (41)	265 (120)	

\*1 Standard 4-pole motor

\*2 Rated capacity is calculated by assuming the output rated voltage as 208V for three-phase 208V.

\*3 Output voltage cannot exceed the power supply voltage.

\*4 An excessively low setting of the carrier frequency may result in the higher motor temperature or tripping of the inverter by its overcurrent limiter setting. Lower the continuous load or maximum load instead. (When setting the carrier frequency (F26) to 1kHz, reduce the load to 80% of its rating.)

\*5 Use [R1,T1] terminals for driving AC cooling fans of an inverter powered by the DC link bus, such as by a high power factor PWM converter. (In ordinary operation, the terminals are not used.)

\*6 Calculated under Fuji-specified conditions.

\*7 Obtained when a DC reactor (DCR) is used.

\*8 Average braking torque (Varies with the efficiency of the motor.)

\*9 Voltage unbalance (%) =  $\frac{\text{Max. voltage (V)} - \text{Min. voltage (V)}}{\text{Three-phase average voltage (V)}} \times 67$  (IEC61800-3 (5.2.3))

If this value is 2 to 3%, use an AC reactor (ACR).



## ■ Three-phase 460V

### ● 1 to 75HP

Item		Specifications														
Type (FRN _ _ _ F1S-4U)		001	002	003	005	007	010	015	020	025	030	040	050	060	075	
Nominal applied motor [HP]		*1	1	2	3	5	7.5	10	15	20	25	30	40	50	60	75
Output ratings	Rated capacity [kVA]	*2	1.9	2.9	4.3	7.1	9.9	13	18	23	29	35	47	57	67	83
	Rated voltage [V]	*3	Three-phase, 380 to 480V (With AVR function)													
	Rated current [A]	*4	2.5	3.7	5.5	9.0	12.5	16.5	23	30	37	44	59	72	85	105
	Overload capability		120% of rated current for 1min.													
	Rated frequency		50, 60 Hz													
Input ratings	Phases, voltage, frequency	Main power supply	Three-phase, 380 to 480V, 50/60Hz										Three-phase, 380 to 440V,50Hz Three-phase, 380 to 480V,60Hz			
		Auxiliary control power input	Single-phase, 380 to 480V, 50/60Hz													
		Auxiliary fan power input	*5	None												
	Voltage/frequency variations		Voltage: +10 to -15% (Voltage unbalance 2% or less) *9, Frequency: +5 to -5%													
Rated current [A]	*6	(with DCR)	1.3	2.5	3.8	6.2	8.9	11.8	17.7	23.7	29.6	35.5	46.8	57.0	68.4	85.7
		(without DCR)	2.5	4.8	6.9	10.8	14.5	19.1	27.7	36.0	43.6	50.9	64.0	78.5	93.7	118
Required power supply capacity [kVA]	*7	1.1	2.0	3.1	5.0	7.1	10	15	19	24	29	38	46	55	69	
Braking	Torque [%]	*8	20										10 to 15			
	DC injection braking		Starting frequency: 0.0 to 60.0Hz, Braking time:0.0 to 30.0s, Braking level: 0 to 60%													
DC reactor (DCR)		Option														
Applicable safety standards		UL508C, C22.2 No.14, EN50178-1997														
Enclosure (IEC60529)		IP20, UL open type										IP00, UL open type				
Cooling method		Natural cooling	Fan cooling													
			6.8 (3.1)	7.1 (3.2)	7.3 (3.3)	7.5 (3.4)	7.5 (3.4)	13 (6.0)	13 (6.0)	15 (6.9)	22 (9.9)	22 (9.9)	25 (11.5)	51 (23)	53 (24)	73 (33)
Mass [lbs(kg)]																

### ● 100 to 900HP

Item		Specifications														
Type (FRN _ _ _ F1S-4U)		100	125	150	200	250	300	350	400	450	500	600	700	800	900	
Nominal applied motor [HP]		*1	100	125	150	200	250	300	350	400	450	500	600	700	800	900
Output ratings	Rated capacity [kVA]	*2	110	133	161	191	240	286	330	380	414	517	589	669	764	828
	Rated voltage [V]	*3	Three-phase, 380 to 480V (With AVR function)													
	Rated current [A]	*4	139	168	203	240	302	360	415	477	520	650	740	840	960	1040
	Overload capability		120% of rated current for 1min.													
	Rated frequency		50, 60 Hz													
Input ratings	Phases, voltage, frequency	Main power supply	Three-phase, 380 to 440V, 50Hz Three-phase, 380 to 480V, 60Hz													
		Auxiliary control power input	Single-phase, 380 to 480V, 50/60Hz													
		Auxiliary fan power input	*5	Single-phase, 380 to 440V/50Hz Single-phase, 380 to 480V/60Hz												
	Voltage/frequency variations		Voltage: +10 to -15% (Voltage unbalance 2% or less) *9, Frequency: +5% to -5%													
Rated current [A]	*6	(with DCR)	113	140	169	222	275	330	382	440	495	545	652	756	869	981
		(without DCR)	—	—	—	—	—	—	—	—	—	—	—	—	—	—
Required power supply capacity [kVA]	*7	91	112	135	177	220	263	305	351	395	435	520	603	693	782	
Braking	Torque [%]	*8	10 to 15													
	DC injection braking		Starting frequency: 0.0 to 60.0Hz, Braking time:0.0 to 30.0s, Braking level: 0 to 60%													
DC reactor (DCR)		Standard														
Applicable safety standards		UL508C, C22.2 No.14, EN50178-1997								UL508C, C22.2 No.14						
Enclosure (IEC60529)		IP00, UL open type														
Cooling method		Fan cooling														
Mass [lbs(kg)]		75 (34)	93 (42)	99 (45)	139 (63)	212 (96)	212 (96)	216 (98)	357 (162)	357 (162)	529 (240)	529 (240)	783 (355)	794 (360)	794 (360)	

\*1 Standard 4-pole motor

\*2 Rated capacity is calculated by assuming the output rated voltage as 460V for three-phase 460V.

\*3 Output voltage cannot exceed the power supply voltage.

\*4 An excessively low setting of the carrier frequency may result in the higher motor temperature or tripping of the inverter by its overcurrent limiter setting. Lower the continuous load or maximum load instead. (When setting the carrier frequency (F26) to 1kHz, reduce the load to 80% of its rating.)

\*5 Use [R1,T1] terminals for driving AC cooling fans of an inverter powered by the DC link bus, such as by a high power factor PWM converter. (In ordinary operation, the terminals are not used.)

\*6 Calculated under Fuji-specified conditions.







\*7 Obtained when a DC reactor (DCR) is used.

\*8 Average braking torque (Varies with the efficiency of the motor.)

\*9 Voltage unbalance (%) =  $\frac{\text{Max. voltage (V)} - \text{Min. voltage (V)}}{\text{Three-phase average voltage (V)}} \times 67$  (IEC61800-3(5.2.3))

If this value is 2 to 3%, use an AC reactor (ACR).

# Common specifications



Item		Explanation	Remarks	Related function code	
Output frequency	Setting range				
	Maximum frequency	25 to 120Hz		F03	
	Base frequency	25 to 120Hz		F04	
	Starting frequency	0.1 to 60.0Hz		F23	
	Carrier frequency	<ul style="list-style-type: none"> <li>0.75 to 15kHz (208V/460V: 1 to 25HP for 208V and 1 to 30HP for 460V)</li> <li>0.75 to 10kHz (208V/460V: 30 to 100HP for 208V and 40 to 100HP for 460V)</li> <li>0.75 to 6kHz (208V/460V: 125HP for 208V and 125 to 900HP for 460V)</li> </ul>	The carrier frequency may drop automatically according to the ambient temperature or output current to protect the inverter. This protective operation can be canceled by function code H98.	F26, F27, H98	
	Accuracy (Stability)	<ul style="list-style-type: none"> <li>Analog setting: <math>\pm 0.2\%</math> of maximum frequency (at <math>25 \pm 10^\circ\text{C}</math> (<math>77 \pm 50^\circ\text{F}</math>))</li> <li>Keypad setting: <math>\pm 0.01\%</math> of maximum frequency (at <math>-10</math> to <math>+50^\circ\text{C}</math> (<math>14</math> to <math>122^\circ\text{F}</math>))</li> </ul>			
Setting resolution	<ul style="list-style-type: none"> <li>Analog setting: 1/1000 of maximum frequency (ex. 0.06Hz at 60Hz, 0.12Hz at 120Hz)</li> <li>Keypad setting: 0.01Hz (99.99Hz or less), 0.1Hz (100.0Hz or more)</li> <li>Link setting: Selectable from 2 types                             <ul style="list-style-type: none"> <li>1/20000 of maximum frequency (ex. 0.003Hz at 60Hz, 0.006Hz at 120Hz)</li> <li>0.01Hz (fixed)</li> </ul> </li> </ul>	Setting with  /  keys			
Control	Control method	V/f control			
	Voltage/freq. characteristic (Non-linear V/f setting)	Possible to set output voltage at base frequency and at maximum output frequency (common spec.). AVR control can be turned ON or OFF. 1 point (Arbitrary voltage and frequency can be set.)	Three-phase 208V: 80 to 240V Three-phase 460V: 160 to 500V Three-phase 208V: 0 to 240V/0 to 120Hz Three-phase 460V: 0 to 500V/0 to 120Hz	F03 to F05 H50, H51	
	Torque boost (Load selection)	Torque boost can be set with the function code F09. Select application load type with the function code F37. 0: Variable torque load 1: Variable torque load (for high starting torque) 2: Auto-torque boost 3: Auto-energy-saving operation (variable torque load in acceleration/deceleration) 4: Auto-energy-saving operation (variable torque load (for high starting torque) for acceleration/deceleration) 5: Auto-energy-saving operation (auto-torque boost in acceleration/deceleration)	Set when 0, 1, 3, or 4 is selected at F37.	F09, F37 F09, F37	
	Starting torque	50% or over			
	Start/stop	Keypad operation	Start and stop with  /  and  keys.		F02
		External signals	Forward (reverse) rotation, stop command (capable of 3-wire operation), (7 digital inputs) second operation command, coast-to-stop command, external alarm, alarm reset, etc.		E01 to E05 E98, E99
		Link operation	Operation through RS-485 communication and Field Bus communication (option)		H30, y98
		Operation command switching	Remote/local switch, link switch, second operation command switch		
	Frequency command source	Keypad operation	Can be set with  /  keys.		F01, C30
		External potentiometer (1 to 5kΩ, 1/2W)	Prepared by users	Connected to analog input terminals [13], [12], [11].	
		Analog input	Can be set with external voltage/current input. 0 to +10V DC (0 to +5V DC)/0 to 100% (terminal [12],[V2]) 4 to 20mA DC/0 to 100% (terminal [C1])	E.g. : 0 to 5 VDC/1 to 5 VDC is applicable with bias/gain for analog input.	F18, C50, C32 to C34, C37 to C39, C42 to C44
		Multistep frequency	Selectable from 8 steps (step 0 to 7)		C05 to C11
		UP/DOWN operation	The frequency rises or lowers while the digital input signal is turned on.		F01, C30
		Link operation	Can be set with RS-485 communications and field bus communications (option).		H30, y98
		Frequency setting change	Two types of frequency settings can be switched with an external signal (digital input). Changeover between remote and local (keypad operation) or frequency setup through communication is also possible.		F01, C30
		Auxiliary frequency setting	Inputs at terminal [12],[C1] or [V2] can be added to the main setting as auxiliary frequency settings.		E61 to E63
	Acceleration/ deceleration time	Inverse operation	The digital input signal and function code setting sets or switches between the normal and inverse operations. • +10 to 0V DC/0 to 100%(Terminal [12], [V2]) • 20 to 4mA DC/0 to 100%(Terminal [C1])		C53
		Acceleration and deceleration pattern	0 to 3600s • Acceleration and deceleration pattern can be selected from 4 types: Linear, S-curve (weak), S-curve (strong), Curve (constant output max. capacity). • Shutoff of the operation command coasts the motor to decelerate and stop.		F07, F08 H07 H11
	Frequency limiter	High and low limiters can be set (setting range: 0 to 120Hz)	Selection can be made between continuation of operation and stopping at frequencies equal to or smaller than the lower limit.		F15, F16 H63
	Bias frequency	Bias of set frequency and PID command can be set in the range between 0 and $\pm 100\%$ .			F18, C50 to C52
Gain for frequency setting	The analog input gain can be set in the range from 0 to 200%.	Voltage signals (terminal [12],[V2]) and current signal (terminal [C1]) can be set independently.		C32, C34, C37, C39, C42, C44	
Jump frequency setting	Three operation points and their common jump hysteresis width (0 to 30Hz) can be set.			C01 to C04	
Restart after momentary power failure	<ul style="list-style-type: none"> <li>The inverter restarts upon recovery from power failure without stopping the motor.</li> <li>In the "operation continuation mode," recovery of the power supply is waited for while the output frequency slightly drops.</li> <li>Selection can be made among starting at 0Hz, starting at the frequency immediately before the momentary power failure, and starting at the frequency specified in the starting mode after power recovery.</li> </ul>			F14 H13 to H16, H92, H93	
Current limit	Keeps the current under the preset value during operation.			F43, F44	
Line/inverter switching	<ul style="list-style-type: none"> <li>Line/inverter switching (starting at line frequency) can be made with a digital input signal (SW50, SW60).</li> <li>A built-in line/inverter switching sequence performs sequence control with a digital input signal (ISW50, ISW60) to output a signal (SW88, SW52-1, SW52-2) for controlling an external magnetic contactor (MC). As a built-in sequence, two types can be selected, including the one switching automatically to the line upon an inverter alarm.</li> </ul>			J22	
PID control	Capable of PID regulator control for process			E61 to E63 J01 to J06 J10 to OJ19	
	Process commands	<ul style="list-style-type: none"> <li>Key operation (UP and DOWN keys): 0 to 100%</li> <li>Analog input (terminal [12],[V2]): 0 to +10V DC/0 to 100%</li> <li>Analog input (terminal [C1]): 4 to 20mA DC/0 to 100%</li> <li>UP/DOWN (digital input): 0 to 100%</li> <li>Communication (RS-485, bus option): 0 to 20,000/0 to 100%</li> </ul>			

Item	Explanation	Remarks	Related function code	
Control	PID control <ul style="list-style-type: none"> <li>■ Feedback value</li> <li>• Analog input (terminal [I2],[V2]) :0 to +10V DC/0 to 100%</li> <li>• Analog input (terminal [C1]) : 4 to 20mA DC/0 to 100%</li> <li>■ Accessory functions</li> <li>• Alarm output (absolute value alarm, deviation alarm) • Normal operation/inverse operation</li> <li>• Sleep function • Anti-reset wind-up function</li> <li>• PID output limiter • Integration reset/hold</li> </ul>		E61 to E63, J01 to J06, J10 to J19	
	Auto search for idling motor's speed	Starting at the preset frequency, the inverter automatically searches the idling motor speed to be harmonized and starts to drive it without stopping it.		
	Automatic deceleration	Upon a DC link voltage exceeding the overvoltage limit level during deceleration, the deceleration time automatically extends to avoid an <b>OU</b> trip.		H69, F08
	Deceleration characteristic	The motor loss increases during deceleration to reduce the load energy regenerating at the inverter to avoid an <b>OU</b> trip upon mode selection.		H71
	Automatic energy-saving operation	The output voltage is controlled to minimize the total sum of the motor loss and inverter loss at a constant speed.		F37,F09
	Overload protection control	The output frequency is automatically reduced to suppress the overload protection trip of the inverter caused by an increase in the ambient temperature or motor load, or by other operating conditions.		
	Auto-tuning	The motor parameters are automatically tuned.		P04
Cooling fan ON/OFF control	Detects inverter internal temperature and stops cooling fan when the temperature is low.	An external output is issued in a transistor or relay output signal.	H06	
Pump control	An inverter controls multiple driving pumps at a time combining with driving sources of the inverter and commercial power. The inverter's integrated PID controller controls them in the flowrate, pressure and so on. The inverter controls each member of pump control sequences issuing the power source switching signal between the inverter output and commercial power. Two control modes are available. One is a fixed motor-driving mode where the inverter exclusively controls the single pump. Another is a cyclic motor-driving mode where the inverter cyclically controls a member of pumps. <ul style="list-style-type: none"> <li>• Fixed motor-driving mode : Pumps under control = one inverter driven + four commercial power driven</li> <li>• Cyclic motor-driving mode : Pumps under control = three inverter /commercial power driven (In this mode, a relay output card option (OPC-F1S-RY) is required.)</li> </ul> Furthermore, this control features a periodic switching function, an average time drive-switching function, a cumulative pump run time monitor, a cumulative relay activating times monitor and so on.			
Indication	Running/stopping	<ul style="list-style-type: none"> <li>• Speed monitor, output current [A], output voltage [V], torque calculation value, input power [kW],PID reference value, PID feedback value, PID output, load factor, motor output</li> <li>• Slect the speed monitor to be displayed from the following.</li> <li>Output frequency [Hz], motor speed [r/min.], load shaft speed [r/min.], % indication</li> </ul>		E43 E48
	Lifetime early warning	Shows the lifetime early warnings of the electrolytic capacitors on the printed circuit boards, the DC link bus capacitor, and the cooling fan.	An external output can be issued in a transistor or relay output signal.	
	Cumulative run time	Shows the cumulative running hours of the motor and inverter, and the input watt-hour.		
	Output	Transistor outputs - quantity 3 Relay outputs - quantity 1 from C and quantity 1 from A Voltage output - 0 - 10 Vdc Current output - 4-20 mA		
	Trip error code	Displays the cause of trip by codes. <ul style="list-style-type: none"> <li>• <b>OC 1</b> (Overcurrent during acceleration) • <b>OC 2</b> (Overcurrent during deceleration) • <b>OC 3</b> (Overcurrent at constant speed)</li> <li>• <b>EF</b> (Grounding fault) • <b>Lrn</b> (Input phase loss) • <b>LU</b> (Undervoltage)</li> <li>• <b>OPL</b> (Output phase loss) • <b>OU 1</b> (Overvoltage during acceleration) • <b>OU 2</b> (Overvoltage during deceleration)</li> <li>• <b>OU 3</b> (Overvoltage at constant speed) • <b>OH 1</b> (Overheating of the heat sink) • <b>OH 2</b> (External alarm)</li> <li>• <b>OH 3</b> (Inverter overheat) • <b>OH 4</b> (Motor protection (PTC thermistor)) • <b>OL 1</b> (Motor overload)</li> <li>• <b>OLU</b> (Inverter overload) • <b>FUS</b> (Blown fuse) • <b>PbF</b> (Charging circuit fault)</li> <li>• <b>Er 1</b> (Memory error) • <b>Er 2</b> (Keypad communication error) • <b>Er 3</b> (CPU error)</li> <li>• <b>Er 4</b> (Optional communication error) • <b>Er 5</b> (Option error) • <b>Er 6</b> (Option action error)</li> <li>• <b>Er 7</b> (Tuning error) • <b>Er 8</b> (RS-485 communication error) • <b>Er F</b> (Data save error due to undervoltage)</li> <li>• <b>Er P</b> (RS-485 communication error (option)) • <b>Er H</b> (LSI error)</li> </ul>		
	Trip history	Saves and displays the last 4 trip codes and their detailed description.		E52

# Common specifications

Item	Explanation	Remarks	Related function code																							
Overcurrent protection	The inverter is stopped upon an overcurrent caused by an overload.																									
Short-circuit protection	The inverter is stopped upon an overcurrent caused by a short-circuit in the output circuit.																									
Grounding fault protection	The inverter is stopped upon an overcurrent caused by a grounding fault in the output circuit.																									
Overvoltage protection	An excessive DC link circuit voltage is detected to stop the inverter.	3-phase 208V / 400VDC 3-phase 460V / 800VDC																								
Surge protection	The inverter is protected against surge voltages intruding across the main circuit power cable and ground.																									
Undervoltage	Stops the inverter by detecting voltage drop in DC link circuit.	3-phase 208V / 200VDC 3-phase 460V / 400VDC	F14																							
Input phase loss	Stops or protects the inverter against input phase loss.	The protective function can be canceled with function code 98.	H98																							
Output phase loss	Detects breaks in inverter output wiring at the start of running and during running, stopping the inverter output.	The protective function can be canceled with function code 98.	H98																							
Overheating	The temperature of the heat sink of the inverter or that inside the inverter unit is detected to stop the inverter, upon a failure or overload of the cooling fan.		H43																							
Overload	The inverter is stopped upon the temperature of the heat sink of the inverter or the temperature of the switching element calculated from the output current.																									
Motor protection	Electronic thermal	The inverter is stopped upon an electronic thermal function setting to protect the motor.	Thermal time constant can be adjusted (0.5 to 75.0min.).																							
	PTC thermistor	A PTC thermistor input stops the inverter to protect the motor.	H26, H27																							
	Overload early warning	Warning signal can be output based on the set level before the inverter trips.	F10, F12, E34, E35, P99																							
Stall prevention	The output frequency decreases upon an output current exceeding the limit during acceleration or constant speed operation, to avoid overcurrent trip.		H12																							
Momentary power failure protection	<ul style="list-style-type: none"> <li>A protective function (inverter stoppage) is activated upon a momentary power failure for 15msec or longer.</li> <li>If restart upon momentary power failure is selected, the inverter restarts upon recovery of the voltage within the set time.</li> </ul>		H13 to H16, F14																							
Retry function	When the motor is tripped and stopped, this function automatically resets the tripping state and restarts operation.	Waiting time before resetting and the number of retry times can be set.	H04, H05																							
Command loss detection	A loss (broken wire, etc.) of the frequency command is detected to output an alarm and continue operation at the preset frequency (set at a ratio to the frequency before detection)		E65																							
Environment	Installation location	Shall be free from corrosive gases, flammable gases, oil mist, dusts, and direct sunlight. [Pollution degree 2 (IEC60664-1)] Indoor use only.																								
	Ambient temperature	-10 to +50 °C (14 to 122°F) -10 to +40 °C (14 to 104°F) (IP54 series)	-10 to 40 °C (14 to 104°F) when inverters are installed side-by-side without clearance.																							
	5 to 95% (nocondensation)	5 to 95% (no condensation)																								
	Altitude	<table border="1"> <thead> <tr> <th>Altitude [ft (m)]</th> <th>Output derating</th> </tr> </thead> <tbody> <tr> <td>Lower than 3300 (1000)</td> <td>None</td> </tr> <tr> <td>3301 to 6600 (1001 to 2000)</td> <td>Decreases</td> </tr> <tr> <td>6601 to 9800 (2001 to 3000)</td> <td>Decreases*</td> </tr> </tbody> </table>	Altitude [ft (m)]	Output derating	Lower than 3300 (1000)	None	3301 to 6600 (1001 to 2000)	Decreases	6601 to 9800 (2001 to 3000)	Decreases*	* If the altitude exceeds 6600ft (2000m), insulate the interface circuit from the main power supply to conform to the Low Voltage Directives.															
	Altitude [ft (m)]	Output derating																								
Lower than 3300 (1000)	None																									
3301 to 6600 (1001 to 2000)	Decreases																									
6601 to 9800 (2001 to 3000)	Decreases*																									
Vibration	<table border="1"> <thead> <tr> <th>Smaller than 100HP</th> <th>3mm (vibration width)</th> <th>2 to less than 9Hz</th> <th>[125HP or more]</th> <th>3mm (vibration width)</th> <th>2 to less than 9Hz</th> </tr> </thead> <tbody> <tr> <td></td> <td>9.8m/s<sup>2</sup></td> <td>: 9 to less than 20Hz</td> <td></td> <td>2m/s<sup>2</sup></td> <td>: 9 to less than 55Hz</td> </tr> <tr> <td></td> <td>2m/s<sup>2</sup></td> <td>: 20 to less than 55Hz</td> <td></td> <td>1m/s<sup>2</sup></td> <td>: 55 to less than 200Hz</td> </tr> <tr> <td></td> <td>1m/s<sup>2</sup></td> <td>: 55 to less than 200Hz</td> <td></td> <td></td> <td></td> </tr> </tbody> </table>	Smaller than 100HP	3mm (vibration width)	2 to less than 9Hz	[125HP or more]	3mm (vibration width)	2 to less than 9Hz		9.8m/s <sup>2</sup>	: 9 to less than 20Hz		2m/s <sup>2</sup>	: 9 to less than 55Hz		2m/s <sup>2</sup>	: 20 to less than 55Hz		1m/s <sup>2</sup>	: 55 to less than 200Hz		1m/s <sup>2</sup>	: 55 to less than 200Hz				
Smaller than 100HP	3mm (vibration width)	2 to less than 9Hz	[125HP or more]	3mm (vibration width)	2 to less than 9Hz																					
	9.8m/s <sup>2</sup>	: 9 to less than 20Hz		2m/s <sup>2</sup>	: 9 to less than 55Hz																					
	2m/s <sup>2</sup>	: 20 to less than 55Hz		1m/s <sup>2</sup>	: 55 to less than 200Hz																					
	1m/s <sup>2</sup>	: 55 to less than 200Hz																								
Storage	Amb. temp	-25 to +65 °C (-13 to 149°F)																								
	Amb. humidity	5 to 95%RH (no condensation)																								



Function	Description	LED indication	Alarm output (30A, B, C) Note)	Related function code	
<b>Overcurrent protection</b>	Stops the inverter output to protect the inverter from an overcurrent resulting from overload.	During acceleration <i>OC1</i>	○		
<b>Short-circuit protection</b>	Stops the inverter output to protect the inverter from overcurrent due to a short-circuiting in the output circuit.	During deceleration <i>OC2</i>			
<b>Ground fault protection</b>	Stops the inverter output to protect the inverter from overcurrent due to a ground fault in the output circuit. This protection is effective only during startup of the inverter. If you turn ON the inverter without removing the ground fault, this protection may not work. (Applicable to inverters of 75HP for 208V, 100HP for 460V or below (3-phase 208 V) or 350HP or below (3-phase 460 V))	During running at constant speed <i>OC3</i>			
	Upon detection of zero-phase current in the output power, this function stops the inverter output to protect the inverter from overcurrent due to a ground fault in the output circuit. (Applicable to inverters of 125HP for 208V and 125HP for 460V or above (3-phase 208 V) or 450HP or above (3-phase 460 V))	<i>EF</i>	○		
<b>Overvoltage protection</b>	The inverter stops the inverter output upon detection of an overvoltage condition (400 VDC for 3-phase 208V, 800 VDC for 3-phase 460V) in the DC link bus. This protection is not assured if extremely large AC line voltage is applied inadvertently.	During acceleration <i>OU1</i> During deceleration <i>OU2</i> During running at constant speed (when stopped) <i>OU3</i>	○		
<b>Undervoltage protection</b>	Stops the inverter output when the DC link bus voltage drops below the undervoltage level (200 VDC for 3-phase 208V, 400 VDC for 3-phase 460 V). However, if data "3, 4, or 5" is selected for F14, no alarm is output even if the DC link bus voltage drops.	<i>LU</i>	△	F14	
<b>Input phase loss protection</b>	Detects input phase loss, stopping the inverter output. This function prevents the inverter from undergoing heavy stress that may be caused by input phase loss or inter-phase voltage unbalance and may damage the inverter. If connected load is light or a DC reactor is connected to the inverter, this function will not detect input phase loss if any.	<i>L in</i>	○	H98	
<b>Output phase loss protection</b>	Detects breaks in inverter output wiring at the start of running and during running, stopping the inverter output.	<i>OPL</i>	○	H98	
<b>Overheating protection</b>	- Stops the inverter output upon detecting excess heat sink temperature in case of cooling fan failure or overload. - Detects a failure of the internal air circulation DC fan and alarm-stops the inverter (For models of 50HP or above in 208 V, 75HP or above in 460 V)	<i>OH1</i>	○	H43, H98	
	Stops the inverter output upon detecting an excessively high ambient temperature inside the inverter caused by a failure or an overload condition of the cooling fan.	<i>OH3</i>	○		
<b>Overload protection</b>	Stops the inverter output if the Insulated Gate Bipolar Transistor (IGBT) internal temperature calculated from the output current and temperature of inside the inverter is over the preset value.	<i>OLU</i>	○		
<b>External alarm input</b>	Places the inverter in alarm-stop state upon receiving digital input signal (THR).	<i>OH2</i>	○	E01 to E05 E98, E99	
<b>Blown fuse</b>	Upon detection of a fuse blown in the inverter's main circuit, this function stops the inverter output. (Applicable to 125HP or above (for both 3-phase 208 V and 3-phase 460 V))	<i>FUS</i>	○		
<b>Abnormal condition in charging circuit</b>	Upon detection of an abnormal condition in the charging circuit inside the inverter, this function stops the inverter output. (Applicable to 50HP or above (3-phase 208 V) or 75HP or above (3-phase 460 V))	<i>PbF</i>	○		
<b>Motor protection</b>	<b>Electronic thermal overload</b>	In the following cases, the inverter stops running the motor to protect the motor in accordance with the electronic thermal overload protection setting. • Protects general-purpose motors over the entire frequency range (F10 = 1.) • Protects inverter motors over the entire frequency range (F10 = 2.) * The operation level and thermal time constant can be set by F11 and F12.	<i>OL1</i>	○	F10
	<b>PTC thermistor</b>	A PTC thermistor input stops the inverter output for motor protection. Connect a PTC thermistor between terminals [V2] and [I1] and set the function codes and slide switch on the control PCB accordingly.	<i>OH4</i>	○	H26, H27
	<b>Overload early warning</b>	Outputs a preliminary alarm at a preset level before the motor is stopped by the electronic thermal overload protection for the motor.	—	—	E34, E35
<b>Stall prevention</b>	Operates when instantaneous overcurrent limiting is active. • Instantaneous overcurrent limiting: Operates if the inverter's output current exceeds the instantaneous overcurrent limit level, avoiding tripping of the inverter (during constant speed operation or during acceleration).	—	—	H12	
<b>Alarm relay output (for any fault)</b>	• The inverter outputs a relay contact signal when the inverter issues an alarm and stops the inverter output. < Alarm reset > The alarm stop state is reset by pressing the  key or by the digital input signal (RST). < Saving the alarm history and detailed data > The information on the previous 4 alarms can be saved and displayed.	—	○	E20, E27 E01 to E05 E98, E99	
<b>Memory error detection</b>	The inverter checks memory data after power-on and when the data is written. If a memory error is detected, the inverter stops.	<i>Er1</i>	○		
<b>Keypad communications error detection</b>	The inverter stops by detecting a communications error between the inverter and the keypad during operation using the keypad.	<i>Er2</i>	○	F02	
<b>CPU error detection</b>	If the inverter detects a CPU error or LSI error caused by noise or some other factors, this function stops the inverter.	<i>Er3</i>	○		
<b>Option communications error detection</b>	Upon detection of an error in the communication between the inverter and an optional card, stops the inverter output.	<i>Er4</i>	—		
<b>Option error detection</b>	When an option card has detected an error, this function stops the inverter output.	<i>Er5</i>	—		
<b>Operation error detection</b>	<b>STOP key priority</b>	Pressing the  key on the keypad forces the inverter to decelerate and stop the motor even if the inverter is running by any run command given via the terminals or communications link. After the motor stops, the inverter issues alarm <i>Er6</i> .	<i>Er6</i>	○	H96
	<b>Start check function</b>	The inverter prohibits any run operations and displays <i>Er6</i> on the 7-segment LED monitor if any run command is present when: • Powering up • An alarm is released (the  key is turned ON or an alarm reset (RST) is input.) • "Enable link (LE)" has been activated and the run command is active in the linked source.			
<b>Tuning error detection</b>	During tuning of motor parameters, the tuning has failed or has aborted, or an abnormal condition has been detected in the tuning result, the inverter stops its output.	<i>Er7</i>	○	P04	
<b>RS-485 communications error detection</b>	When the inverter is connected to a communications network via the RS-485 port designed for the keypad, detecting a communications error stops the inverter output and displays an error code <i>Er8</i> .	<i>Er8</i>	○		
<b>Data save error during undervoltage</b>	If the data could not be saved during activation of the undervoltage protection function, the inverter displays the alarm code.	<i>ErF</i>	○		
<b>RS-485 communications error detection</b>	When the inverter is connected to a communications network via RS-485 communications card, detecting a communications error stops the inverter output and displays an error code <i>ErP</i> .	<i>ErP</i>	○		
<b>LSI error detection (Power PCB)</b>	When an error occurred in the LSI on the power printed circuit board (power PCB), this function stops the inverter. (Applicable to: 208 V 50HP or above, and 460 V 75HP or above)	<i>ErH</i>	○		
<b>Retry</b>	When the inverter has stopped because of a trip, this function allows the inverter to automatically reset itself and restart. (You can specify the number of retries and the latency between stop and reset.)	—	—	H04, H05	
<b>Surge protection</b>	Protects the inverter against a surge voltage which might appear between one of the power lines for the main circuit and the ground.	—	—		
<b>Command loss detected</b>	Upon detecting a loss of a frequency command (because of a broken wire, etc.), this function issues an alarm and continues the inverter operation at the preset reference frequency (specified as a ratio to the frequency just before the detection).	—	—	E65	
<b>Protection against momentary power failure</b>	Upon detecting a momentary power failure lasting more than 15 ms, this function stops the inverter output. If restart after momentary power failure is selected, this function invokes a restart process when power has been restored within a predetermined period.	—	—	F14 H13 to H16	
<b>Overload prevention control</b>	In the event of overheating of the heat sink or an overload condition (alarm code: <i>OH1</i> or <i>OLU</i> ), the output frequency of the inverter is reduced to keep the inverter from tripping.	—	—	H70	

Note : The item indicated with △ in the alarm output (30A, B, C) column may not be issued according to some function code settings.

# External Dimensions

## Inverter Outline (5HP for 208V, 7.5HP for 460V or smaller)

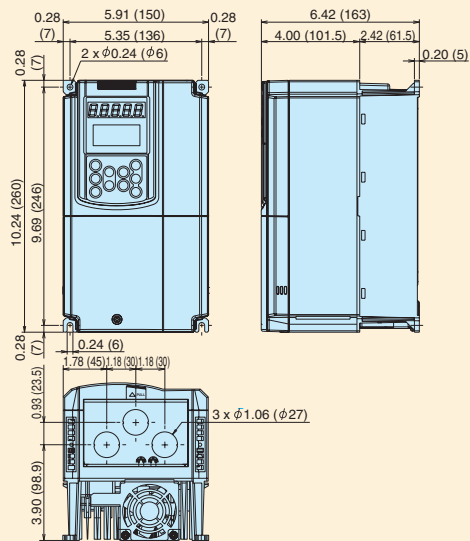

Unit:inch (mm)

Power supply voltage	Type
Three-phase 208V	FRN001F1S-2U
	FRN002F1S-2U
	FRN003F1S-2U
Three-phase 460V	FRN005F1S-2U
	FRN001F1S-4U
	FRN002F1S-4U
	FRN003F1S-4U
	FRN005F1S-4U
	FRN007F1S-4U

## Inverter Outline (7.5HP to 30HP for 208V, 10HP to 40HP for 460V)

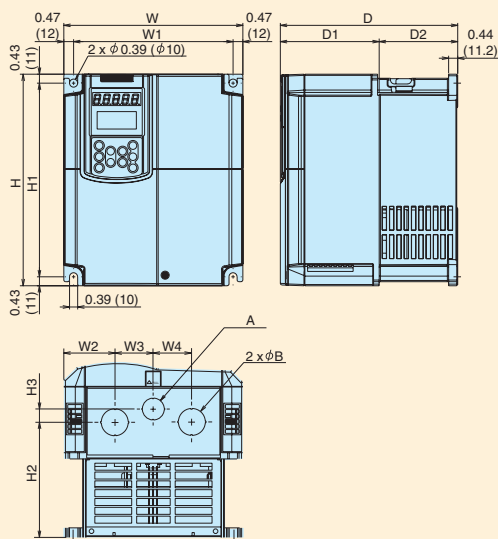

Unit:inch (mm)

Power supply voltage	Type	Dimensions [inch (mm)]															
		W	W1	W2	W3	W4	H	H1	H2	H3	D	D1	D2	φA	φB		
Three-phase 208V	FRN007F1S-2U	8.66 (220)	7.72 (196)	2.50 (63.5)	1.83 (46.5)	1.83 (46.5)	10.24 (260)	9.37 (238)	5.58 (141.7)	0.63 (16)	8.46 (215)	4.67 (118.5)	3.80 (96.5)	1.06 (27)	1.34 (34)		
	FRN010F1S-2U	9.84 (250)	8.90 (226)	2.64 (67)	2.28 (58)	2.28 (58)	15.75 (400)	14.88 (378)	6.54 (166.2)	0.08 (2)				3.35 (85)	5.12 (130)	1.34 (34)	1.65 (42)
	FRN020F1S-2U	8.66 (220)	7.72 (196)	2.50 (63.5)	1.83 (46.5)	1.83 (46.5)	10.24 (260)	9.37 (238)	5.58 (141.7)	0.63 (16)				4.67 (118.5)	3.80 (96.5)	1.06 (27)	1.34 (34)
	FRN030F1S-2U	9.84 (250)	8.90 (226)	2.64 (67)	2.28 (58)	2.28 (58)	15.75 (400)	14.88 (378)	6.54 (166.2)	0.08 (2)				3.35 (85)	5.12 (130)	1.34 (34)	1.65 (42)
Three-phase 460V	FRN010F1S-4U	8.66 (220)	7.72 (196)	2.50 (63.5)	1.83 (46.5)	1.83 (46.5)	10.24 (260)	9.37 (238)	5.58 (141.7)	0.63 (16)	8.46 (215)	4.67 (118.5)	3.80 (96.5)	1.06 (27)	1.34 (34)		
	FRN015F1S-4U	9.84 (250)	8.90 (226)	2.64 (67)	2.28 (58)	2.28 (58)	15.75 (400)	14.88 (378)	6.54 (166.2)	0.08 (2)				3.35 (85)	5.12 (130)	1.34 (34)	1.65 (42)
	FRN025F1S-4U	8.66 (220)	7.72 (196)	2.50 (63.5)	1.83 (46.5)	1.83 (46.5)	10.24 (260)	9.37 (238)	5.58 (141.7)	0.63 (16)				4.67 (118.5)	3.80 (96.5)	1.06 (27)	1.34 (34)
	FRN030F1S-4U	9.84 (250)	8.90 (226)	2.64 (67)	2.28 (58)	2.28 (58)	15.75 (400)	14.88 (378)	6.54 (166.2)	0.08 (2)				3.35 (85)	5.12 (130)	1.34 (34)	1.65 (42)
	FRN040F1S-4U	—	—	—	—	—	—	—	—	—	—	—	—	—	—		

## Inverter Outline 40HP to 125HP for 208V, 50HP to 900HP for 460V

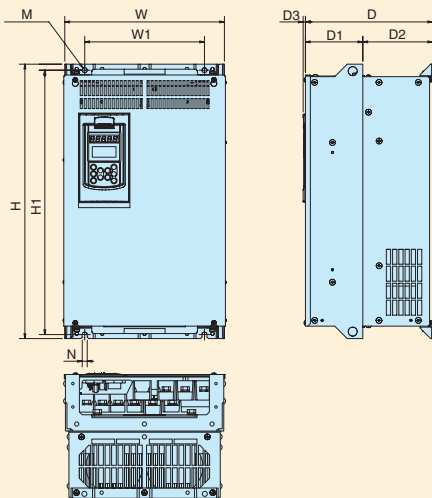

Unit:inch (mm)

Power supply voltage	Type	Dimensions [inch (mm)]													
		W	W1	H	H1	D	D1	D2	D3	M	N				
Three-phase 208V	FRN040F1S-2U	12.6 (320)	9.45 (240)	21.65 (550)	20.87 (530)	10.04 (255)	4.53 (115)	5.51 (140)	0.18 (4.5)	2xφ0.39 (2xφ10)	0.39 (10)				
	FRN050F1S-2U	13.98 (355)	10.83 (275)	24.21 (615)	23.43 (595)	10.63 (270)		6.10 (155)							
	FRN060F1S-2U	26.77 (680)	22.83 (580)	34.85 (880)	33.46 (850)	15.55 (395)		10.04 (255)				5.51 (140)	0.24 (6)	3xφ0.59 (3xφ15)	0.59 (15)
	FRN075F1S-2U	12.60 (320)	9.45 (240)	21.65 (550)	20.87 (530)	10.04 (255)		4.53 (115)				5.51 (140)	0.18 (4.5)	2xφ0.39 (2xφ10)	0.39 (10)
	FRN100F1S-2U	13.98 (355)	10.83 (275)	24.21 (615)	23.43 (595)	10.63 (270)		6.10 (155)				6.10 (155)	0.18 (4.5)	2xφ0.39 (2xφ10)	0.39 (10)
Three-phase 460V	FRN125F1S-4U	26.77 (680)	22.83 (580)	34.85 (880)	33.46 (850)	15.55 (395)	10.04 (255)	5.51 (140)	0.24 (6)	3xφ0.59 (3xφ15)	0.59 (15)				
	FRN050F1S-4U	12.60 (320)	9.45 (240)	21.65 (550)	20.87 (530)	10.04 (255)	4.53 (115)	5.51 (140)	0.18 (4.5)	2xφ0.39 (2xφ10)	0.39 (10)				
	FRN060F1S-4U	13.98 (355)	10.83 (275)	24.21 (615)	23.43 (595)	10.63 (270)		6.10 (155)							
	FRN075F1S-4U	26.77 (680)	22.83 (580)	34.85 (880)	33.46 (850)	15.55 (395)		10.04 (255)				5.51 (140)	0.24 (6)	3xφ0.59 (3xφ15)	0.59 (15)
	FRN100F1S-4U	13.98 (355)	10.83 (275)	24.21 (615)	23.43 (595)	10.63 (270)		6.10 (155)				6.10 (155)	0.18 (4.5)	2xφ0.39 (2xφ10)	0.39 (10)
	FRN125F1S-4U	26.77 (680)	22.83 (580)	34.85 (880)	33.46 (850)	15.55 (395)		10.04 (255)				5.51 (140)	0.24 (6)	3xφ0.59 (3xφ15)	0.59 (15)
	FRN200F1S-4U	20.87 (530)	16.93 (430)	29.13 (740)	27.95 (710)	12.40 (315)	5.31 (135)	7.09 (180)	0.24 (6)	2xφ0.39 (2xφ10)	0.39 (10)				
	FRN250F1S-4U	26.77 (680)	22.83 (580)	39.37 (1000)	38.19 (970)	14.17 (360)	7.09 (180)	7.09 (180)	0.24 (6)	2xφ0.39 (2xφ10)	0.39 (10)				
	FRN300F1S-4U	26.77 (680)	22.83 (580)	39.37 (1000)	38.19 (970)	14.17 (360)	7.09 (180)	7.09 (180)	0.24 (6)	2xφ0.39 (2xφ10)	0.39 (10)				
	FRN350F1S-4U	26.77 (680)	22.83 (580)	39.37 (1000)	38.19 (970)	14.17 (360)	7.09 (180)	7.09 (180)	0.24 (6)	2xφ0.39 (2xφ10)	0.39 (10)				
	FRN400F1S-4U	26.77 (680)	22.83 (580)	39.37 (1000)	38.19 (970)	14.17 (360)	7.09 (180)	7.09 (180)	0.24 (6)	2xφ0.39 (2xφ10)	0.39 (10)				
	FRN450F1S-4U	26.77 (680)	22.83 (580)	39.37 (1000)	38.19 (970)	14.17 (360)	7.09 (180)	7.09 (180)	0.24 (6)	2xφ0.39 (2xφ10)	0.39 (10)				
	FRN500F1S-4U	26.77 (680)	22.83 (580)	39.37 (1000)	38.19 (970)	14.17 (360)	7.09 (180)	7.09 (180)	0.24 (6)	2xφ0.39 (2xφ10)	0.39 (10)				
FRN600F1S-4U	26.77 (680)	22.83 (580)	39.37 (1000)	38.19 (970)	14.17 (360)	7.09 (180)	7.09 (180)	0.24 (6)	2xφ0.39 (2xφ10)	0.39 (10)					
FRN700F1S-4U	34.65 (880)	30.71 (780)	55.12 (1400)	53.94 (1370)	17.32 (440)	10.24 (260)	7.09 (180)	0.24 (6)	4xφ0.59 (4xφ15)	0.59 (15)					
FRN800F1S-4U	34.65 (880)	30.71 (780)	55.12 (1400)	53.94 (1370)	17.32 (440)	10.24 (260)	7.09 (180)	0.24 (6)	4xφ0.59 (4xφ15)	0.59 (15)					
FRN900F1S-4U	34.65 (880)	30.71 (780)	55.12 (1400)	53.94 (1370)	17.32 (440)	10.24 (260)	7.09 (180)	0.24 (6)	4xφ0.59 (4xφ15)	0.59 (15)					

### Multi-function keypad (TP-G1) (standard accessory)

Unit:inch (mm)

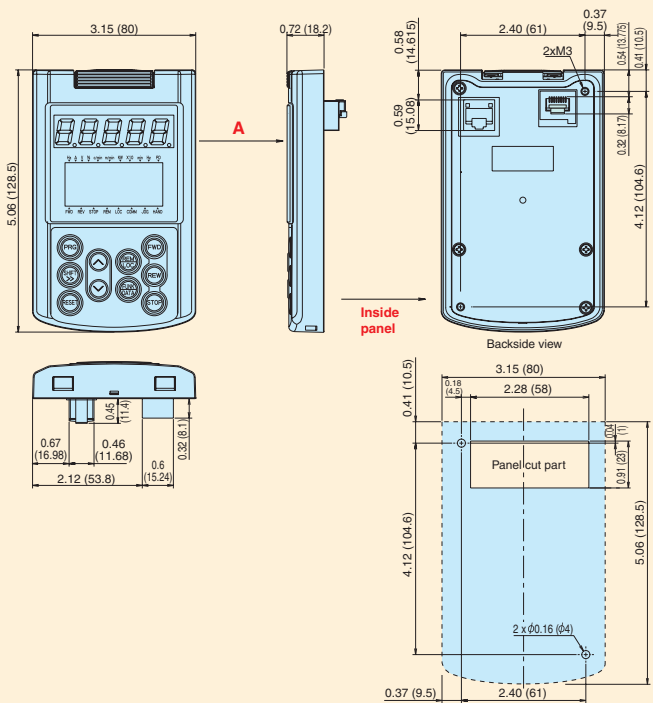

Dimensions of panel cutting (viewed from "A")

The following diagram is for reference only. For detailed wiring diagrams, refer to the Instruction Manual.

## Keypad operation

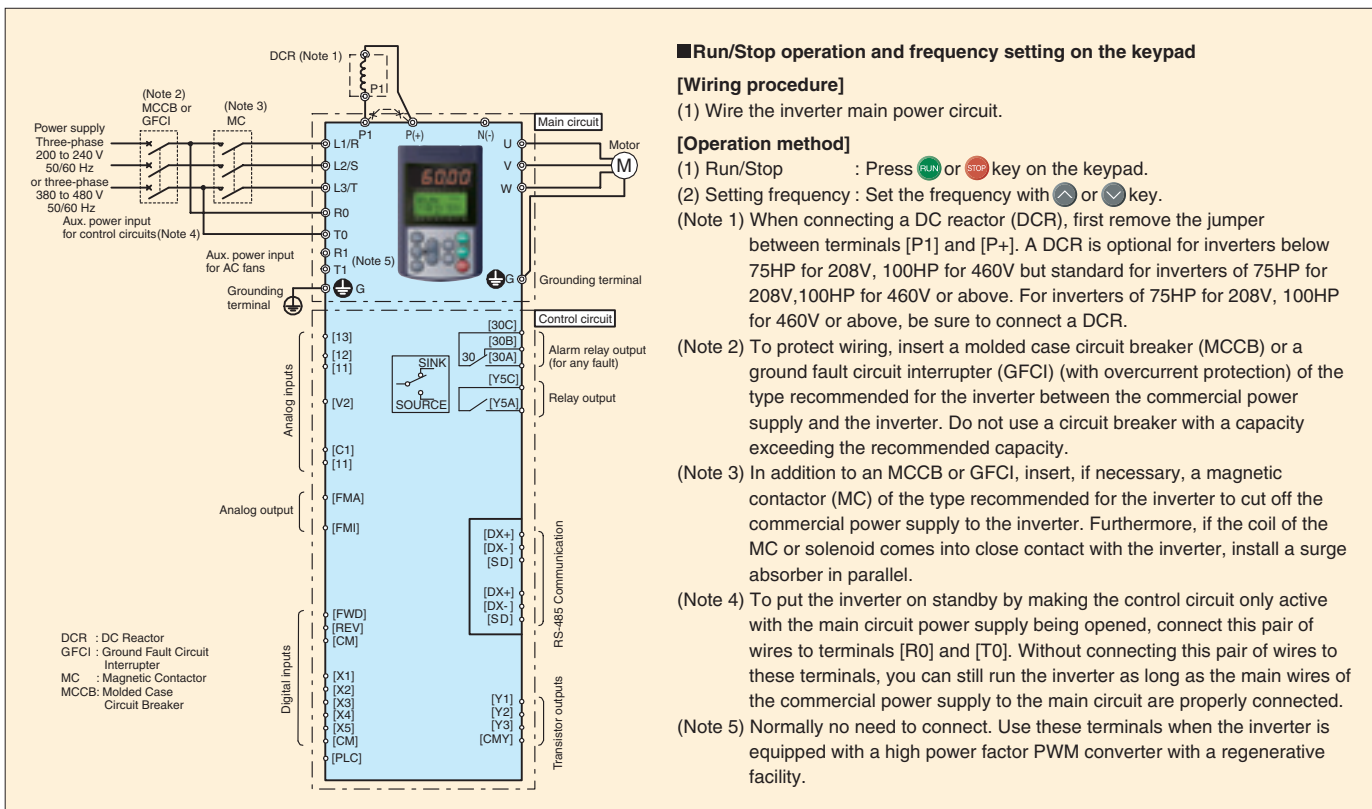

### Run/Stop operation and frequency setting on the keypad

#### [Wiring procedure]

(1) Wire the inverter main power circuit.

#### [Operation method]

(1) Run/Stop : Press **RUN** or **STOP** key on the keypad.

(2) Setting frequency : Set the frequency with **▲** or **▼** key.

(Note 1) When connecting a DC reactor (DCR), first remove the jumper between terminals [P1] and [P+]. A DCR is optional for inverters below 75HP for 208V, 100HP for 460V but standard for inverters of 75HP for 208V, 100HP for 460V or above. For inverters of 75HP for 208V, 100HP for 460V or above, be sure to connect a DCR.

(Note 2) To protect wiring, insert a molded case circuit breaker (MCCB) or a ground fault circuit interrupter (GFCI) (with overcurrent protection) of the type recommended for the inverter between the commercial power supply and the inverter. Do not use a circuit breaker with a capacity exceeding the recommended capacity.

(Note 3) In addition to an MCCB or GFCI, insert, if necessary, a magnetic contactor (MC) of the type recommended for the inverter to cut off the commercial power supply to the inverter. Furthermore, if the coil of the MC or solenoid comes into close contact with the inverter, install a surge absorber in parallel.

(Note 4) To put the inverter on standby by making the control circuit only active with the main circuit power supply being opened, connect this pair of wires to terminals [R0] and [T0]. Without connecting this pair of wires to these terminals, you can still run the inverter as long as the main wires of the commercial power supply to the main circuit are properly connected.

(Note 5) Normally no need to connect. Use these terminals when the inverter is equipped with a high power factor PWM converter with a regenerative facility.

## Operation by external signal inputs

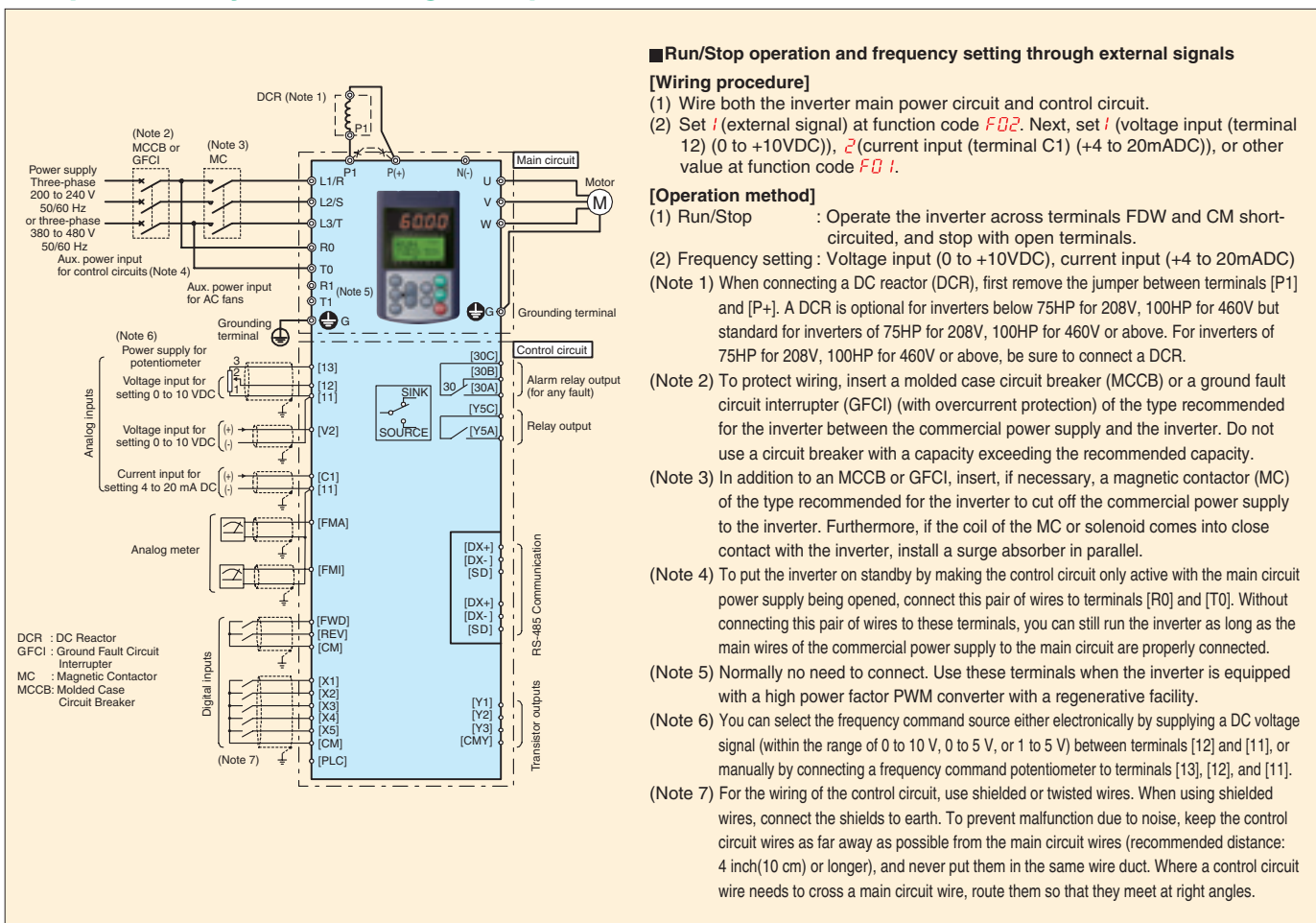

### Run/Stop operation and frequency setting through external signals

#### [Wiring procedure]

(1) Wire both the inverter main power circuit and control circuit.

(2) Set **i** (external signal) at function code **FB2**. Next, set **i** (voltage input (terminal 12) (0 to +10VDC)), **z** (current input (terminal C1) (+4 to 20mADC)), or other value at function code **FB1**.

#### [Operation method]

(1) Run/Stop : Operate the inverter across terminals FDW and CM short-circuited, and stop with open terminals.

(2) Frequency setting : Voltage input (0 to +10VDC), current input (+4 to 20mADC)

(Note 1) When connecting a DC reactor (DCR), first remove the jumper between terminals [P1] and [P+]. A DCR is optional for inverters below 75HP for 208V, 100HP for 460V but standard for inverters of 75HP for 208V, 100HP for 460V or above. For inverters of 75HP for 208V, 100HP for 460V or above, be sure to connect a DCR.

(Note 2) To protect wiring, insert a molded case circuit breaker (MCCB) or a ground fault circuit interrupter (GFCI) (with overcurrent protection) of the type recommended for the inverter between the commercial power supply and the inverter. Do not use a circuit breaker with a capacity exceeding the recommended capacity.

(Note 3) In addition to an MCCB or GFCI, insert, if necessary, a magnetic contactor (MC) of the type recommended for the inverter to cut off the commercial power supply to the inverter. Furthermore, if the coil of the MC or solenoid comes into close contact with the inverter, install a surge absorber in parallel.

(Note 4) To put the inverter on standby by making the control circuit only active with the main circuit power supply being opened, connect this pair of wires to terminals [R0] and [T0]. Without connecting this pair of wires to these terminals, you can still run the inverter as long as the main wires of the commercial power supply to the main circuit are properly connected.

(Note 5) Normally no need to connect. Use these terminals when the inverter is equipped with a high power factor PWM converter with a regenerative facility.

(Note 6) You can select the frequency command source either electronically by supplying a DC voltage signal (within the range of 0 to 10 V, 0 to 5 V, or 1 to 5 V) between terminals [12] and [11], or manually by connecting a frequency command potentiometer to terminals [13], [12], and [11].

(Note 7) For the wiring of the control circuit, use shielded or twisted wires. When using shielded wires, connect the shields to earth. To prevent malfunction due to noise, keep the control circuit wires as far away as possible from the main circuit wires (recommended distance: 4 inch(10 cm) or longer), and never put them in the same wire duct. Where a control circuit wire needs to cross a main circuit wire, route them so that they meet at right angles.



## Terminal Functions

Division	Symbol	Terminal name	Functions	Remarks	Related function code																																												
Main circuit	L1/R,L2/S,L3/T	Power input	Connect a three-phase power supply.																																														
	R0,T0	Auxiliary control power input	Connect a single-phase power supply.																																														
	R1,T1	Auxiliary fan power input	There is no need to connect during normal operation. Use these terminals for applications combined with a high power-factor PWM converter with power regeneration function or the like.																																														
	U,V,W	Inverter output	Connect a three-phase motor.																																														
	P(+),P1	For DC REACTOR	Connect the DC reactor (DCR).																																														
	P(+),N(-)	For DC bus connection	Used for DC bus connection.																																														
Frequency setting	⊕G	Grounding	Terminal for inverter grounding	Two terminals are provided.																																													
	13	Potentiometer power supply	Used for frequency setting device power supply (variable resistance: 1 to 5kΩ) (10V DC 10mA DC max.)																																														
	12	Voltage input	Used as a frequency setting voltage input. 0 to +10V DC/0 to 100% (0 to +5V DC/0 to 100%) +10 to 0V DC/0 to 100%	Input impedance: 22kΩ Maximum input: +15V DC	F18 C32 to C34 E61																																												
		(Inverse operation) (PID control)	Used for setting signal (PID process command value) or feedback signal.																																														
		(Frequency aux. setting) (Analog input monitor)	Used as additional auxiliary setting to various frequency settings. The peripheral analog signal can be displayed on the keypad. (Displaying coefficient: valid)																																														
		C1	Current input	Used as a frequency setting current input. 4 to 20mA DC/0 to 100% 20 to 4mA DC/0 to 100%	Input impedance: 250Ω Maximum input: 30mA DC	F18 C37 to C39 E62																																											
	V2	Analog setting voltage input	Used as a frequency setting voltage input. 0 to +10V DC/0 to 100% (0 to +5V DC/0 to 100%) +10 to 0V DC/0 to 100%	Input impedance: 22kΩ Maximum input: +15V DC	F18 C42 to C44 E63																																												
		(Inverse operation) (PID control)	Used for setting signal (PID process command value) or feedback signal.																																														
		(For PTC thermistor)	Connects PTC thermistor for motor protection.																																														
		(Frequency aux. setting) (Analog input monitor)	Used as additional auxiliary setting to various frequency settings. The peripheral analog signal can be displayed on the keypad. (Displaying coefficient: valid)																																														
11	Analog common	Common terminal for frequency setting signals (12, 13, C1, V2, FMA)	Isolated from terminals CM and CMY. Two terminals are provided.																																														
Digital input	X1	Digital input 1	The following functions can be set at terminals X1 to X5, FWD and REV for signal input. <Common function> • Sink and source are changeable using the built-in sliding switch. • ON timing can be changed between short-circuit of terminals X1 and CM and open circuits of them. The same setting is possible between CM and any of the terminals among X2, X3, X4, X5, FWD, and REV.	ON state Source current: 2.5 to 5mA Voltage level: 2V OFF state Allowable leakage current: Smaller than 0.5mA Voltage: 22 to 27V	E01																																												
	X2	Digital input 2			E02																																												
	X3	Digital input 3			E03																																												
	X4	Digital input 4			E04																																												
	X5	Digital input 5			E05																																												
	FWD	Forward operation command	The motor runs in the forward direction upon ON across (FWD) and CM. The motor decelerates and stops upon OFF. The motor runs in the reverse direction upon ON across (REV) and CM. The motor decelerates and stops upon OFF. 8-step operation can be conducted with ON/OFF signals at (SS1) to (SS4).	This function can be set only for the terminals FWD and REV.	E98																																												
	REV	Reverse operation command			E99																																												
	(FWD) (REV) (SS1) (SS2) (SS4)	Forward operation command Reverse operation command Multistep freq. selection			<table border="1"> <thead> <tr> <th rowspan="2">Digital input</th> <th colspan="7">Multistep frequency</th> </tr> <tr> <th>0</th> <th>1</th> <th>2</th> <th>3</th> <th>4</th> <th>5</th> <th>6</th> <th>7</th> </tr> </thead> <tbody> <tr> <td>(SS1)</td> <td>-</td> <td>ON</td> <td>-</td> <td>ON</td> <td>-</td> <td>ON</td> <td>-</td> <td>ON</td> </tr> <tr> <td>(SS2)</td> <td>-</td> <td>-</td> <td>ON</td> <td>ON</td> <td>-</td> <td>-</td> <td>ON</td> <td>ON</td> </tr> <tr> <td>(SS4)</td> <td>-</td> <td>-</td> <td>-</td> <td>-</td> <td>ON</td> <td>ON</td> <td>ON</td> <td>ON</td> </tr> </tbody> </table>	Digital input	Multistep frequency							0	1	2	3	4	5	6	7	(SS1)	-	ON	-	ON	-	ON	-	ON	(SS2)	-	-	ON	ON	-	-	ON	ON	(SS4)	-	-	-	-	ON	ON	ON	ON	C05 to C11
	Digital input	Multistep frequency																																															
		0	1	2	3	4	5	6	7																																								
	(SS1)	-	ON	-	ON	-	ON	-	ON																																								
	(SS2)	-	-	ON	ON	-	-	ON	ON																																								
	(SS4)	-	-	-	-	ON	ON	ON	ON																																								
	(HLD)	3-wire operation stop command	Used for 3-wire operation. ON across (HLD) and CM: The inverter self-holds FWD or REV signal. OFF across (HLD) and CM: The inverter releases self-holding.																																														
	(BX) (RST) (THR)	Coast-to-stop command Alarm reset Trip command (External fault)	ON across (BX) and CM: The inverter output is shut off immediately and the motor coasts to a stop. ON across (RST) and CM: Faults are reset. OFF across (THR) and CM: The inverter output is shut off immediately and the motor coasts-to-stop.	No alarm signal will be output. Alarm reset signal width: 0.1(s) or more Alarm signal <b>0Hz</b> will be output.																																													
	(Hz2/Hz1) (DCBRK) (SW50) (SW60)	Freq. set 2/Freq. set 1 DC braking command Line/inverter switch(50Hz) Line/inverter switch(60Hz)	ON across (Hz2/Hz1) and CM: Freq. set 2 is effective. ON across (DCBRK) and CM: Starts DC braking action. OFF across (SW50) and CM: Starts at 50Hz. OFF across (SW60) and CM: Starts at 60Hz		F01, F30 F20 to F22																																												
	(UP) (DOWN) (WE-KP) (Hz/PID)	UP command DOWN command Write enable for KEYPAD PID cancel	The output frequency rises while the circuit across (UP) and CM is connected. The output frequency drops while the circuit across (DOWN) and CM is connected. The function code data can be changed from the keypad only when (WEE-KP) is ON. PID control can be canceled when the circuit across (Hz/PID) and CM is connected. (Operation proceeds according to the selected frequency setting method such as the multi-step frequency, keypad and analog input.)		F01, C30 J02 F00 J01 to J06 J10 to J19 C50, J01																																												
	(IVS) (IL)	Inverse mode changeover Interlock	The frequency setting or PID control output signal (frequency setting) action mode switches between normal and inverse actions when the circuit across (IVS) and CM is connected. Connect an auxiliary contact of a switch installed between the inverter and motor. This signal is input upon momentary power failure to detect momentary power failure, and the inverter restarts upon power recovery.		F14																																												
	(LE) (U-DI) (STM) (STOP) (PID-RST) (PID-HLD) (LOC) (RE) (DWP)	Link enable (RS-485, Bus) Universal DI Starting characteristic selection Forcible stop PID differentiation / integration reset PID integral hold Local (keypad) command selection Operation permission Dew prevention	Operation proceeds according to commands sent via RS-485 communication or field bus (option) when the circuit across (LE) and CM is connected. An arbitrary digital input signal is transmitted to the host controller. ON across (STM) and CM: Starting at the pick-up frequency becomes valid. OFF across (STOP) and CM: The inverter is forcibly stopped in the special deceleration time. ON across (PID-RST) and CM: Resets differentiation and integration values of PID. ON across (PID-HLD) and CM: Holds integration values of PID. ON across (LOC) and CM: The operation commands and frequency settings given at the keypad become valid. After an operation command is input, operation starts upon activation of (RE).		H30, y98 H17, H09 H56 J01 to J06 J10 to J19 J21 F21, F22 J22																																												
	(ISW50) (ISW60)	Line/inverter switching sequence(50Hz) Line/inverter switching sequence(60Hz)	OFF across (ISW50) and CM: Line operation starts according to the switching sequence built in the inverter. (For 50Hz commercial line) OFF across (ISW60) and CM: Line operation starts according to the switching sequence built in the inverter. (For 60Hz commercial line)		J22																																												
	(FR2/FR1) (FWD2) (REV2)	Operation command 2/1 Forward rotation/stop command 2 Reverse operation/stop command 2	ON across (FR2/FR1) and CM: The operation command switches to (FWD2) (REV2) side. Forward operation upon ON across (FWD) and CM. Deceleration and stop upon OFF. (Second operation command) Reverse operation upon ON across (REV) and CM. Deceleration and stop upon OFF. (Second operation command)		F02																																												
	PLC	PLC terminal	Connect to PLC output signal power supply. Common for 24V power.	+24V 50mA max.																																													
	CM	Common	Common terminal for digital input signal	Isolated from terminals 11 and CMY. Two terminals are provided.																																													

# Terminal Functions

## Terminal Functions

Division	Symbol	Terminal name	Functions	Remarks	Related function code
Analog output	FMA	Analog monitor	The output style can be selected between DC voltage (0 to 10V) and DC current (4 to 20mA). One of the following items can be output in the selected output style. • Output frequency. • Output current. • Output voltage. • Output torque. • Load factor. • Input power. • PID feedback value. • DC link circuit voltage. • Universal AO. • Motor output. • Analog output test. • PID command. • PID output	In the case of voltage output, up to two analog voltmeters (0 to 10Vdc, input impedance: 10kΩ) can be connected. In the case of current output, analog ammeters (up to 500Ω) can be connected. Gain adjustment range: 0 to 200%	F29 to F31
	FMP	Pulse monitor	One of the following items can be output in a pulse frequency. • Output frequency. • Output current. • Output voltage. • Output torque. • Load factor. • Power consumption. • PID feedback value. • DC link circuit voltage. • Universal AO. • Motor output. • Analog output test. • PID command. • PID output	Up to two analog voltmeters (0 to 10Vdc, input impedance: 10kΩ) can be connected. (Driven at average voltage) Gain adjustment range: 0 to 200%	F33 to F35
Transistor output	(PLC)	Transistor output power	• Power supply for a transistor output load. (24Vdc 50mA Max.) (Note: Same terminal as digital input PLC terminal)	Short circuit across terminals CM and CMY to use.	
	Y1	Transistor output 1	The following functions can be set at terminals Y1 to Y3 for signal output. • The setting of "short circuit upon active signal output" or "open upon active signal output" is possible. • Sink/source support (switching unnecessary)	Max. voltage: 27Vdc, max. current: 50mA, leak current: 0.1mA max., ON voltage: within 2V (at 50mA)	E20
	Y2	Transistor output 2			E21
	Y3	Transistor output 3			E22
	(RUN)	Inverter running (speed exists)	An active signal is issued when the inverter runs at higher than the starting frequency.		
	(RUN2)	Inverter output on	A signal is issued when the inverter runs at smaller than the starting frequency or when DC braking is in action.		
	(FAR)	Speed/freq. arrival	An active signal is issued when the output frequency reaches the set frequency.	Detection width (fixed): 2.5 (Hz)	
	(FDT)	Speed/freq. detection	An active signal is issued at output frequencies above a preset detection level. The signal is deactivated if the output frequency falls below the detection level.	Hysteresis width (fixed): 1.0 (Hz)	E31
	(LV)	Undervoltage detection	The signal is output when the inverter stops because of undervoltage.		
	(IOL)	Inverter output limit (limit on current)	The signal is output when the inverter is limiting the current.		F43, F44
	(IPF)	Auto-restarting	The signal is output during auto restart operation (after momentary power failure and until completion of restart).		F14
	(OL)	Overload early warning (motor)	The signal is output when the electronic thermal relay value is higher than the preset alarm level.		F10 to F12
	(RDY)	Operation ready output	A signal is issued if preparation for inverter operation is completed.		
	(SW88)	Line-to-inverter switching	The magnetic contactor on the line side of line-to-inverter switching is controlled.		
	(SW52-2)	Line-to-inverter switching	The magnetic contactor on the inverter output side (secondary side) of line-to-inverter switching is controlled.		
	(SW52-1)	Line-to-inverter switching	The magnetic contactor on the inverter input side (primary side) of line-to-inverter switching is controlled.		
	(AX)	AX terminal function	The electromagnetic contactor on the inverter input side (primary side) is controlled.		
	(FAN)	Cooling fan ON/OFF control	The ON/OFF signal of the cooling fan is issued.		H06
	(TRY)	Retry in action	The signal is output during an active retry.		H04, H05
	(U-DO)	Universal DO	The signal transmitted from the host controller is issued.		
	(OH)	Heat sink overheat early warning	An early warning signal is issued before the heat sink trips due to an overheat.		
	(LIFE)	Lifetime alarm	Outputs alarm according to the preset lifetime level.		H42, H43, H98
	(REF OFF)	Command loss detection	A loss of the frequency command is detected.		E65
	(OLP)	Overload preventive control	The signal is output when the overload control is activated.		H70
	(ID)	Current detection	The signal is output when a current larger than the set value has been detected for the timer-set time.		E34, E35
	(PID-ALM)	PID alarm output	An absolute value alarm or deviation alarm under PID control is issued as a signal.		J11 to J13
	(PID-CTL)	Under PID control	The valid state of PID control is issued as a signal.		
	(PID-STP)	PID stop upon small water flow	A signal is issued if operation is stopped due to a small water flow under PID control. (The inverter is stopped even if the operation command is issued.)		J15 to J17
	(U-TL)	Low torque detection	A signal is issued if the torque falls below the preset low torque detection level for a set time.		E80, E81
	(RMT)	In remote mode	A signal is issued in the remote mode.		
	(AX2)	Operation command input	A signal is issued if there is an operation command input and operation ready is completed.		
	(ALM)	Alarm relay output (for any fault)	An alarm relay output (for any fault) signal is issued as a transistor output signal.		
	CMY	Transistor output common	Common terminal for transistor output	The terminal is isolated from terminals 11 and CM.	
Contact output	Y5A, Y5C	General-purpose relay output	• Multi-purpose relay output; signals similar to above-mentioned signals Y1 to Y3 can be selected. • An alarm output is issued upon either excitation or no excitation according to selection.	Contact capacity: 250 V AC, 0.3A, cos φ=0.3 +48 V DC, 0.5A	E24
	30A, 30B, 30C	Alarm relay output (for any fault)	• A no-voltage contact signal (1c) is issued when the inverter is stopped due to an alarm. • Multi-purpose relay output; signals similar to above-mentioned signals Y1 to Y3 can be selected. • An alarm output is issued upon either excitation or no excitation according to selection.		E27
Communication	—	RJ45 connector for connection with the keypad	One of the following protocols can be selected. • Modbus RTU • Protocol exclusively for keypad (default selection) • Fuji's special inverter protocol • SX protocol for PC loader	Power (+5V) is supplied to the keypad.	H30 y01 to y20 y98, y99

# Terminal Arrangement

## Main circuit terminals

Power supply voltage	Applicable motor rating (HP)	Inverter type	Reference
Three-phase 208V	1	FRN001F1S-2U	Fig. A
	2	FRN002F1S-2U	
	3	FRN003F1S-2U	
	5	FRN005F1S-2U	Fig. B
	7	FRN007F1S-2U	
	10	FRN010F1S-2U	
	15	FRN015F1S-2U	Fig. C
	20	FRN020F1S-2U	
	25	FRN025F1S-2U	
	30	FRN030F1S-2U	Fig. D
	40	FRN040F1S-2U	Fig. E
	50	FRN050F1S-2U	Fig. G
60	FRN060F1S-2U		
75	FRN075F1S-2U		
100	FRN100F1S-2U	Fig. J	
125	FRN125F1S-2U		
Three-phase 460V	1		FRN001F1S-4U
	2	FRN002F1S-4U	
	3	FRN003F1S-4U	
	5	FRN005F1S-4U	Fig. B
	7	FRN007F1S-4U	
	10	FRN010F1S-4U	
	15	FRN015F1S-4U	Fig. C
	20	FRN020F1S-4U	
	25	FRN025F1S-4U	
	30	FRN030F1S-4U	Fig. D
	40	FRN040F1S-4U	Fig. E
	50	FRN050F1S-4U	Fig. F
	60	FRN060F1S-4U	
	75	FRN075F1S-4U	
	100	FRN100F1S-4U	Fig. G
	125	FRN125F1S-4U	
	150	FRN150F1S-4U	
	200	FRN200F1S-4U	Fig. H
250	FRN250F1S-4U	Fig. I	
300	FRN300F1S-4U		
350	FRN350F1S-4U		
400	FRN400F1S-4U	Fig. K	
450	FRN450F1S-4U		
500	FRN500F1S-4U		
600	FRN600F1S-4U	Fig. L	
700	FRN700F1S-4U	Fig. M	
800	FRN800F1S-4U		
900	FRN900F1S-4U		

Fig. A

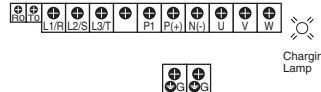

Fig. B

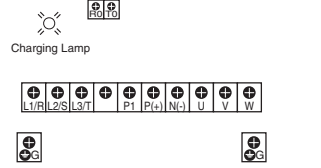

Fig. C

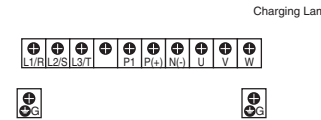

Fig. D

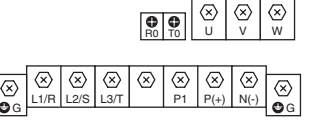

Fig. E

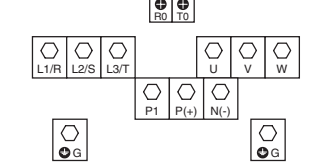

Fig. F

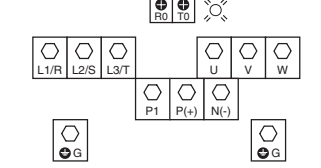

Fig. G

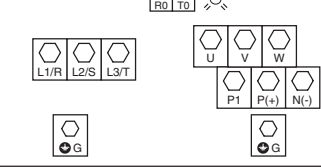

Fig. H

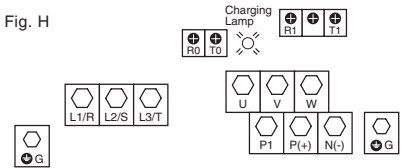

Fig. I

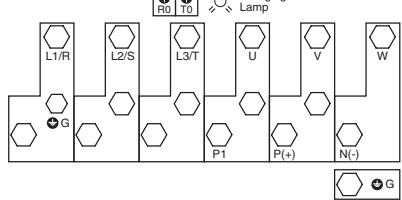

Fig. J

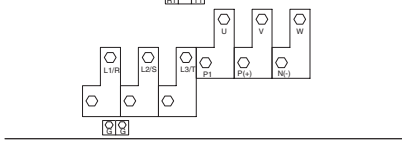

Fig. K

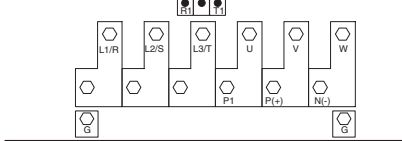

Fig. L

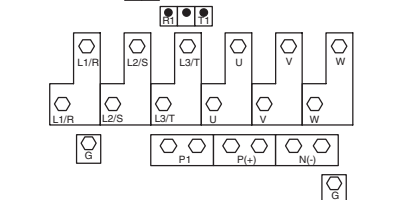
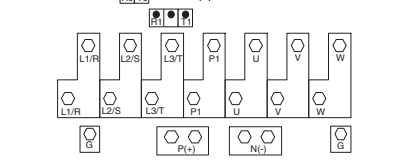
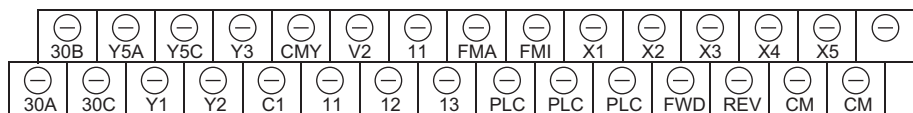

Fig. M



## Control circuit terminals (common to all models)



Screw size: M3 Tightening torque: 4.4 to 5.3lb-in(0.5 to 0.6 (N·m))

### Control Circuit Terminals

Screwdriver to be used (Head style)	Allowable wire size	Bared wire length	Dimension of openings in the control circuit terminals
Flat head (0.6 x 3.5mm)	AWG26 to AWG16 (0.14 to 1.5 mm <sup>2</sup> )	0.28 inch (7 mm)	0.10 (W) x 0.11 (H) inch (2.75 (W) x 2.86 (H) mm)

## Multi-function keypad

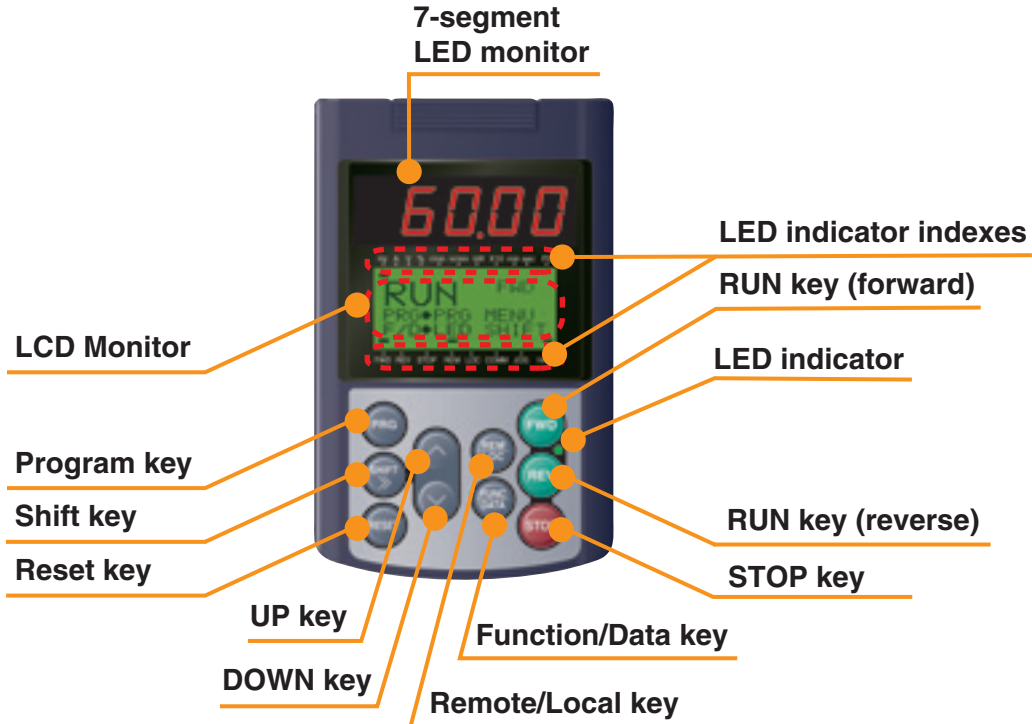

Item	Monitor, LED indicator or Key	Functions
LED/LCD Monitor		Five-digit, 7-segment LED monitor which displays the following according to the operation mode: ■ In Running Mode: Running status information (e.g., output frequency, current, and voltage) ■ In Programming Mode: same as above ■ In Alarm Mode: Alarm code, which identifies the cause of alarm if the protective function is activated.
		LCD monitor which displays the following according to the operation modes: ■ In Running Mode: Running status information ■ In Programming Mode: Menus, function codes and their data ■ In Alarm Mode: Alarm code, which identifies the cause of alarm if the protective function is activated.
	LED indicator indexes	In running mode, display the unit of the number displayed on the LED monitor and the running status information shown on the LCD monitor. For details, see next page.
Keypad Operation Key		Switches the operation modes of the inverter.
		Shifts the cursor to the right when entering a number.
		Pressing this key after removing the cause of an alarm will switch the inverter to Running Mode. Used to reset a setting or screen transition.
		UP and DOWN keys. Used to select the setting items or change the function code data displayed on the LED monitor.
Run Operation Key		Starts running the motor (forward rotation).
		Starts running the motor (reverse rotation).
		Stops the motor.
		Pressing this toggle key for more than 1 second switches between Local and Remote modes.
LED Indicator		Lights while a run command is supplied to the inverter.

Type	Item	Description (information, condition, status)
Unit of Number Displayed on LED Monitor	Hz	Output frequency, frequency command
	A	Output current
	V	Output voltage
	%	Calculated torque, load factor, speed
	r/min	Motor speed, set motor speed, load shaft speed, set load shaft speed
	m/min	Line speed, set line speed (Not applicable to FRENIC-Eco)
	kW	Input power, motor output
	X10	Data greater than 99,999
	min	Constant feeding rate time, constant feeding rate time setting (Not applicable to FRENIC-Eco)
	sec	Timer
Operating Status	FWD	Running (forward rotation)
	REV	Running (reverse rotation)
	STOP	No output frequency
Source of Operation	REM	Remote mode
	LOC	Local mode
	COMM	Communication enabled (RS-485 (standard, optional), field bus option)
	JOG	Jogging mode (Not applicable to FRENIC-Eco)
	HAND	Keypad effective (lights also in local mode)

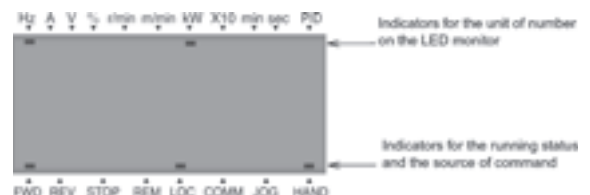

## Function Settings

### F codes: Fundamental Functions

Code	Name	Data setting range	Increment	Unit	Data copying <sup>2</sup>	Default setting
F00	Data Protection	0 : Disable data protection (Function code data can be edited.) 1 : Enable data protection	—	—	Y	0
F01	Frequency Command 1	0 : Enable  /  keys on keypad 1 : Enable voltage input to terminal [12] (0 to 10 VDC) 2 : Enable current input to terminal [C1] (4 to 20 mA DC) 3 : Enable sum of voltage and current inputs to terminals [12] and [C1] 5 : Enable voltage input to terminal [V2] (0 to 10 VDC) 7 : Enable terminal command (UP) / (DOWN) control	—	—	Y	0
F02	Run Command	0 : Enable  /  /  keys on keypad (Motor rotational direction from digital terminals [FWD] / [REV]) 1 : Enable terminal command (FWD) or (REV) 2 : Enable  /  keys on keypad (forward) 3 : Enable  /  keys on keypad (reverse)	—	—	Y	0
F03	Maximum Frequency	25.0 to 120.0	0.1	Hz	Y	60.0
F04	Base Frequency	25.0 to 120.0	0.1	Hz	Y	60.0
F05	Rated Voltage at Base Frequency	0 : Output a voltage in proportion to input voltage 80 to 240V: Output a voltage AVR-controlled (for 3-phase 208 V series) 160 to 500V: Output a voltage AVR-controlled (for 3-phase 460 V series)	1	V	Y2	Refer to table below
F07	Acceleration Time 1	0.00 to 3600 Note: Entering 0.00 cancels the acceleration time, requiring external soft-start.	0.01	s	Y	20.0
F08	Deceleration Time 1	0.00 to 3600 Note: Entering 0.00 cancels the deceleration time, requiring external soft-start.	0.01	s	Y	20.0
F09	Torque Boost	0.0 to 20.0 (Percentage of the rated voltage at base frequency (F05)) Note: This setting is effective when F37 = 0, 1, 3, or 4.	0.1	%	Y	0.0
F10	Electronic Thermal Overload Protection for Motor (Select motor characteristics) (Overload detection level)	1 : For general-purpose motors with built-in self-cooling fan 2 : For inverter-driven motors or high-speed motors with forced-ventilation fan	—	—	Y	1
F11		0.00: Disable 1 to 135% of the rated current (allowable continuous drive current) of the motor	0.01	A	Y1 Y2	Refer to table below
F12	(Thermal time constant)	0.5 to 75.0	0.1	min	Y	Refer to table below
F14	Restart Mode after Momentary Power Failure (Mode selection)	0 : Disable restart (Trip immediately) 1 : Disable restart (Trip after a recovery from power failure) 3 : Enable restart (Continue to run, for heavy inertia or general loads) 4 : Enable restart (Restart at the frequency at which the power failure occurred, for general loads) 5 : Enable restart (Restart at the starting frequency, for low-inertia load)	—	—	Y	0
F15	Frequency Limiter (High)	0.0 to 120.0	0.1	Hz	Y	70.0
F16	(Low)	0.0 to 120.0	0.1	Hz	Y	0.0
F18	Bias (Frequency command 1)	-100.00 to 100.00 *1	0.01	%	Y	0.00
F20	DC Braking (Braking start frequency)	0.0 to 60.0	0.1	Hz	Y	0.0
F21	(Braking level)	0 to 60 (Rated output current of the inverter interpreted as 100%)	1	%	Y	0
F22	(Braking time)	0.00 : Disable 0.01 to 30.00	0.01	s	Y	0.00
F23	Starting Frequency	0.1 to 60.0	0.1	Hz	Y	0.5
F25	Stop Frequency	0.1 to 60.0	0.1	Hz	Y	0.2
F26	Motor Sound (Carrier frequency)	0.75 to 15 (208 V : 25 HP or below, 460 V : 30 HP or below) *3 0.75 to 10 (208 V : 30 HP or above, 460 V : 40 HP to 100 HP) 0.75 to 6 (125 HP or above)	1	kHz	Y	2
F27	(Tone)	0 : Level 0 (Inactive) 1 : Level 1 2 : Level 2 3 : Level 3	—	—	Y	0
F29	Analog Output [FMA] (Mode selection)	0 : Output in voltage (0 to 10 VDC) 1 : Output in current (4 to 20 mA DC)	—	—	Y	0
F30	(Output adjustment)	0 to 200	1	%	Y	100
F31	Analog Output [FMA] (Function)	Select a function to be monitored from the followings. 0 : Output frequency 2 : Output current 3 : Output voltage 4 : Output torque 5 : Load factor 6 : Input power 7 : PID feedback value (PV) 9 : DC link bus voltage 10 : Universal AO 13 : Motor output 14 : Test analog output 15 : PID process command (SV) 16 : PID process output (MV)	—	—	Y	0
F33	Reserved *4	(Pulse rate at 100% output)	—	—	Y	1440

\*1 When you make settings from the keypad, the incremental unit is restricted by the number of digits that the LED monitor can display.  
(Example) If the setting range is from -200.00 to 200.00, the incremental unit is as follows:  
"1" for -200 to -100, "0.1" for -99.9 to -10.0, "0.01" for -9.99 to -0.01, "0.01" for 0.00 to 99.99, and "0.1" for 100.0 to 200.0

\*2 Symbols used in the data copy column:

Y: Copied Y1: Not copied if the inverter capacity differs. Y2: Not copied if the voltage series differs. N: Not copied

\*3 When setting the carrier frequency at 1kHz or below, lower the maximum motor load to 80% of the rated load.

\*4 F33 is displayed, but it is reserved for particular manufacturers. Unless otherwise specified, do not access this function code.

<Changing, setting, and saving data during operation>

: No data change allowed : Change with / key, and set and save with key. : Change and set with / key, and save with key.



## Function Settings

### F codes: Fundamental Functions

Code	Name	Data setting range	Increment	Unit	Data copying <sup>2</sup>	Default setting
F34	Terminal [FMI] (Output adjustment)	0 to 200: Voltage output adjustment	1	%	Y	100
F35	(Function)	Select a function to be monitored from the followings. 0 : Output frequency 2 : Output current 3 : Output voltage 4 : Output torque 5 : Load factor 6 : Input power 7 : PID feedback value (PV) 9 : DC link bus voltage 10 : Universal AO 13 : Motor output 14 : Test analog output 15 : PID process command (SV) 16 : PID process output (MV)	—	—	Y	0
F37	Load Selection/ Auto Torque Boost/ Auto Energy Saving Operation	0 : Variable torque load increasing in proportion to square of speed 1 : Variable torque load increasing in proportion to square of speed (Higher startup torque required) 2 : Auto-torque boost 3 : Auto-energy saving operation(Variable torque load increasing in proportion to square of speed) 4 : Auto-energy saving operation(Variable torque load increasing in proportion to square of speed (Higher startup torque required)) Note:Apply this setting to a load with short acceleration time. 5 : Auto-energy saving operation(Auto torque boost) Note: Apply this setting to a load with long acceleration time.	—	—	Y	1
F43	Current Limiter (Mode selection)	0 : Disable (No current limiter works.) 1 : Enable at constant speed (Disabled during acceleration and deceleration) 2 : Enable during acceleration and at constant speed	—	—	Y	0
F44	(Level)	20 to 120 (The data is interpreted as the rated output current of the inverter for 100%.)	1	%	Y	110

### E codes: Extension Terminal Functions

Code	Name	Data setting range	Increment	Unit	Data copying <sup>2</sup>	Default setting	
E01	Command Assignment to:	[X1] Selecting function code data assigns the corresponding function to terminals [X1] to [X5] as listed below.	—	—	Y	6	
E02		[X2] Setting the value of 1000s in parentheses ( ) shown below assigns a negative logic input to a terminal.	—	—	Y	7	
E03		[X3] 0 (1000) : (SS1)	—	—	Y	8	
E04		[X4] 1 (1001) : Select multistep frequency (SS2)	—	—	Y	11	
E05		[X5] 2 (1002) : (SS4)	—	—	Y	35	
			6 (1006) : Enable 3-wire operation (HLD)				
			7 (1007) : Coast to a stop (BX)				
			8 (1008) : Reset alarm (RST)				
			9 (1009) : Enable external alarm trip (THR)				
			11 (1011) : Switch frequency command 2/1 (Hz2/Hz1)				
			13 : Enable DC brake (DCBRK)				
			15 : Switch to commercial power (50 Hz) (SW50)				
			16 : Switch to commercial power (60 Hz) (SW60)				
			17 (1017) : UP (Increase output frequency) (UP)				
			18 (1018) : DOWN (Decrease output frequency) (DOWN)				
		19 (1019) : Enable write from keypad (Data changeable) (WE-KP)					
		20 (1020) : Cancel PID control (Hz/PID)					
		21 (1021) : Switch normal/inverse operation (IVS)					
		22 (1022) : Interlock (IL)					
		24 (1024) : Enable communications link via RS-485 or field bus (option) (LE)					
		25 (1025) : Universal DI (U-DI)					
		26 (1026) : Select starting characteristics (STM)					
		30 (1030) : Force to stop (STOP)					
		33 (1033) : Reset PID integral and differential components (PID-RST)					
		34 (1034) : Hold PID integral component (PID-HLD)					
		35 (1035) : Select local (keypad) operation (LOC)					
		38 (1038) : Enable to run (RE)					
		39 : Protect motor from dew condensation (DWP)					
		40 : Enable integrated sequence to switch to commercial power (50 Hz) (ISW50)					
		41 : Enable integrated sequence to switch to commercial power (60 Hz) (ISW60)					
		50 (1050) : Clear periodic switching time (MCLR)					
		51 (1051) : Enable pump drive (motor 1) (MEN1)					
		52 (1052) : Enable pump drive (motor 2) (MEN2)					
		53 (1053) : Enable pump drive (motor 3) (MEN3)					
		54 (1054) : Enable pump drive (motor 4) (MEN4)					
		87 (1087) : Switch run command 2/1 (FR2/FR1)					
		88 : Run forward 2 (FWD2)					
		89 : Run reverse 2 (REV2)					
		Note: In the case of (THR) and (STOP), data (1009) and (1030) are for normal logic, and "9" and "30" are for negative logic, respectively.					

\*1 When you make settings from the keypad, the incremental unit is restricted by the number of digits that the LED monitor can display.

(Example) If the setting range is from -200.00 to 200.00, the incremental unit is as follows:

"1" for -200 to -100, "0.1" for -99.9 to -10.0, "0.01" for -9.99 to -0.01, "0.01" for 0.00 to 99.99, and "0.1" for 100.0 to 200.0

\*2 Symbols used in the data copy column:

Y: Copied

Y1: Not copied if the inverter capacity differs.

Y2: Not copied if the voltage series differs.

N: Not copied

<Changing, setting, and saving data during operation>

□ : No data change allowed □ : Change with key, and set and save with key. □ : Change and set with key, and save with key.

●E codes: Extension Terminal Functions

Code	Name	Data setting range	Incre- ment	Unit	Data copying <sup>2</sup>	Default setting
E20	Signal Assignment to: (Transistor signal) [Y1]	Selecting function code data assigns the corresponding function to terminals	—	—	Y	0
E21	[Y2]	[Y1] to [Y3], [Y5A/C], and [30A/B/C] as listed below.	—	—	Y	1
E22	[Y3]	Setting the value of 1000s in parentheses ( ) shown below assigns a negative logic input to a terminal.	—	—	Y	2
E24	(Relay contact signal) [Y5A/C]	0 (1000) : Inverter running (RUN)	—	—	Y	15
E27	[30A/B/C]	1 (1001) : Frequency arrival signal (FAR)	—	—	Y	99
		2 (1002) : Frequency detected (FDT)				
		3 (1003) : Undervoltage detected (Inverter stopped) (LU)				
		5 (1005) : Inverter output limiting (IOL)				
		6 (1006) : Auto-restarting after momentary power failure (IPF)				
		7 (1007) : Motor overload early warning (OL)				
		10 (1010) : Inverter ready to run (RDY)				
		11 : Switch motor drive source between commercial power and inverter output (For MC on commercial line) (SW88)				
		12 : Switch motor drive source between commercial power and inverter output (For primary side) (SW52-2)				
		13 : Switch motor drive source between commercial power and inverter output (For secondary side) (SW52-1)				
		15 (1015) : Select AX terminal function (For MC on primary side) (AX)				
		25 (1025) : Cooling fan in operation (FAN)				
		26 (1026) : Auto-resetting (TRY)				
		27 (1027) : Universal DO (U-DO)				
		28 (1028) : Heat sink overheat early warning (OH)				
		30 (1030) : Service life alarm (LIFE)				
		33 (1033) : Command loss detected (REF OFF)				
		35 (1035) : Inverter output on (RUN2)				
		36 (1036) : Overload prevention control (OLP)				
		37 (1037) : Current detected (ID)				
		42 (1042) : PID alarm (PID-ALM)				
		43 (1043) : Under PID control (PID-CTL)				
		44 (1044) : Motor stopping due to slow flowrate under PID control (PID-STP)				
		45 (1045) : Low output torque detected (U-TL)				
		54 (1054) : Inverter in remote operation (RMT)				
		55 (1055) : Run command activated (AX2)				
		56 (1056) : Motor overheat detected (PTC) (THM)				
		59 (1059) : Terminal C1 off signal (C1OFF)				
		60 (1060) : Mount motor 1, inverter-driven (M1_I)				
		61 (1061) : Mount motor 1, commercial-power-driven (M1_L)				
		62 (1062) : Mount motor 2, inverter-driven (M2_I)				
		63 (1063) : Mount motor 2, commercial-power-driven (M2_L)				
		64 (1064) : Mount motor 3, inverter-driven (M3_I)				
		65 (1065) : Mount motor 3, commercial-power-driven (M3_L)				
		67 (1067) : Mount motor 4, commercial-power-driven (M4_L)				
		68 (1068) : Periodic switching early warning (MCHG)				
		69 (1069) : Pump control limit signal (MLIM)				
		99 (1099) : Alarm output (for any alarm) (ALM)				
E31	Frequency Detection (FDT) (Detection level)	0.0 to 120.0	0.1	Hz	Y	60.0
E32	(Hysteresis width)	0.0 to 120.0	0.1	Hz	Y	1.0
E34	Overload Early Warning (Level) /Current Detection	0: (Disable) Current value of 1 to 150% of the inverter rated current	0.01	A	Y1 Y2	Refer to table below
E35	(Timer)	0.01 to 600.00 *1	0.01	s	Y	10.00
E40	PID Display Coefficient A	-999 to 0.00 to 999	0.01	—	Y	100
E41	PID Display Coefficient B	-999 to 0.00 to 999	0.01	—	Y	0.00
E43	LED Monitor (Item selection)	0: Speed monitor (Select by E48.) 3: Output current 4: Output voltage 8: Calculated torque 9: Input power 10: PID process command (Final) 12: PID feedback value 14: PID output 15: Load factor 16: Motor output 17: Analog input	—	—	Y	0
E45	LCD Monitor (Item selection)	0: Running status, rotational direction and operation guide 1: Bar charts for output frequency, current and calculated torque	—	—	Y	0
E46	(Language selection)	0: Japanese 1: English 2: German 3: French 4: Spanish 5: Italian	—	—	Y	1
E47	(Contrast control)	0 (Low) to 10 (High)	1	—	Y	5
E48	LED Monitor (Speed monitor item)	0: Output frequency 3: Motor speed in r/min 4: Load shaft speed in r/min 7: Display speed in %	—	—	Y	0
E50	Coefficient for Speed Indication	0.01 to 200.00 *1	0.01	—	Y	30.00
E51	Display Coefficient for Input Watt-hour Data	0.000: (Cancel/reset) 0.001 to 9999	0.001	—	Y	0.010
E52	Keypad (Menu display mode)	0: Function code data editing mode (Menus #0, #1 and #7) 1: Function code data check mode (Menus #2 and #7) 2: Full-menu mode (Menus #0 through #7)	—	—	Y	0

## ■ Function Settings

### ● E codes: Extension Terminal Functions

Code	Name	Data setting range	Increment	Unit	Data copying <sup>2</sup>	Default setting
E61	Analog Input for (Extension function selection) [12] [C1] [V2]	Selecting function code data assigns the corresponding function to terminals [12], [C1] and [V2] as listed below.  0 : None 1 : Auxiliary frequency command 1 2 : Auxiliary frequency command 2 3 : PID process command 1 5 : PID feedback value 20 : Analog input monitor	—	—	Y	0
E62			—	—	Y	0
E63			—	—	Y	0
E64	Saving Digital Reference Frequency	0 : Auto saving (at the time of main power turned off) 1 : Saving by pressing  key	—	—	Y	0
E65	Command Loss Detection (Level)	0 : Decelerate to stop 20 to 120 999: Disable	1	%	Y	999
E80	Detect Low Torque (Detection level) (Timer)	0 to 150	1	%	Y	20
E81		0.01 to 600.00 *1	0.01	s	Y	20.00
E98	Command Assignment to: [FWD] [REV]	Selecting function code data assigns the corresponding function to terminals [FWD] and [REV] as listed below. Setting the value of 1000s in parentheses ( ) shown below assigns a negative logic input to a terminal.  0 (1000) : (SS1) 1 (1001) : Select multistep frequency (SS2) 2 (1002) : (SS4) 6 (1006) : Enable 3-wire operation (HLD) 7 (1007) : Coast to a stop (BX) 8 (1008) : Reset alarm (RST) 9 (1009) : Enable external alarm trip (THR) 11 (1011) : Switch frequency command 2/1 (Hz2/Hz1) 13 : Enable DC brake (DCBRK) 15 : Switch to commercial power (50 Hz) (SW50) 16 : Switch to commercial power (60 Hz) (SW60) 17 (1017) : UP (Increase output frequency) (UP) 18 (1018) : DOWN (Decrease output frequency) (DOWN) 19 (1019) : Enable write from keypad (Data changeable) (WE-KP) 20 (1020) : Cancel PID control (Hz/PID) 21 (1021) : Switch normal/inverse operation (IVS) 22 (1022) : Interlock (IL) 24 (1024) : Enable communications link via RS-485 or field bus (option) (LE) 25 (1025) : Universal DI (U-DI) 26 (1026) : Select starting characteristics (STM) 30 (1030) : Force to stop (STOP) 33 (1033) : Reset PID integral and differential components (PID-RST) 34 (1034) : Hold PID integral component (PID-HLD) 35 (1035) : Select local (keypad) operation (LOC) 38 (1038) : Enable to run (RE) 39 : Protect motor from dew condensation (DWP) 40 : Enable integrated sequence to switch to commercial power (50 Hz) (ISW50) 41 : Enable integrated sequence to switch to commercial power (60 Hz) (ISW60) 50 (1050) : Clear periodic switching time (MCLR) 51 (1051) : Enable pump drive (motor 1) (MEN1) 52 (1052) : Enable pump drive (motor 2) (MEN2) 53 (1053) : Enable pump drive (motor 3) (MEN3) 54 (1054) : Enable pump drive (motor 4) (MEN4) 87 (1087) : Switch run command 2/1 (FR2/FR1) 88 : Run forward 2 (FWD2) 89 : Run reverse 2 (REV2) 98 : Run forward (FWD) 99 : Run reverse (REV)  Note: In the case of (THR) and (STOP), data (1009) and (1030) are for normal logic, and "9" and "30" are for negative logic, respectively.	—	—	Y	98
E99			—	—	Y	99

\*1 When you make settings from the keypad, the incremental unit is restricted by the number of digits that the LED monitor can display.

(Example) If the setting range is from -200.00 to 200.00, the incremental unit is as follows:

"1" for -200 to -100, "0.1" for -99.9 to -10.0, "0.01" for -9.99 to -0.01, "0.01" for 0.00 to 99.99, and "0.1" for 100.0 to 200.0

\*2 Symbols used in the data copy column:







Y: Copied

Y1: Not copied if the inverter capacity differs.

Y2: Not copied if the voltage series differs.

N: Not copied

<Changing, setting, and saving data during operation>

: No data change allowed : Change with  key, and set and save with  key. : Change and set with  key, and save with  key.

●C codes: Control Functions of Frequency

Code	Name	Data setting range	Increment	Unit	Data copying <sup>2</sup>	Default setting
<b>C01</b>	Jump Frequency 1 2 3	0.0 to 120.0	0.1	Hz	Y	0.0
<b>C02</b>					Y	0.0
<b>C03</b>					Y	0.0
<b>C04</b>	(Band)	0.0 to 30.0	0.1	Hz	Y	3.0
<b>C05</b>	Multistep Frequency 1 2 3 4 5 6 7	0.00 to 120.00 <sup>*1</sup>	0.01	Hz	Y	0.00
<b>C06</b>					Y	0.00
<b>C07</b>					Y	0.00
<b>C08</b>					Y	0.00
<b>C09</b>					Y	0.00
<b>C10</b>					Y	0.00
<b>C11</b>					Y	0.00
<b>C30</b>	Frequency Command 2	0 : Enable  /  keys on keypad 1 : Enable voltage input to terminal [12] (0 to 10 VDC) 2 : Enable current input to terminal [C1] (4 to 20 mA DC) 3 : Enable sum of voltage and current inputs to terminals [12] and [C1] 5 : Enable voltage input to terminal [V2] (0 to 10 VDC) 7 : Enable terminal command (UP) / (DOWN) control	—	—	Y	2
<b>C32</b>	Analog Input Adjustment for [12] (Gain)	0.00 to 200.00 <sup>*1</sup>	0.01	%	Y	100.0
<b>C33</b>	(Filter time constant)	0.00 to 5.00	0.01	s	Y	0.05
<b>C34</b>	(Gain reference point)	0.00 to 100.00 <sup>*1</sup>	0.01	%	Y	100.0
<b>C37</b>	Analog Input Adjustment for [C1] (Gain)	0.00 to 200.00 <sup>*1</sup>	0.01	%	Y	100.0
<b>C38</b>	(Filter time constant)	0.00 to 5.00	0.01	s	Y	0.05
<b>C39</b>	(Gain reference point)	0.00 to 100.00 <sup>*1</sup>	0.01	%	Y	100.0
<b>C42</b>	Analog Input Adjustment for [V2] (Gain)	0.00 to 200.00 <sup>*1</sup>	0.01	%	Y	100.0
<b>C43</b>	(Filter time constant)	0.00 to 5.00	0.01	s	Y	0.05
<b>C44</b>	(Gain reference point)	0.00 to 100.00 <sup>*1</sup>	0.01	%	Y	100.0
<b>C50</b>	Bias Reference Point (Frequency command 1)	0.00 to 100.0 <sup>*1</sup>	0.01	%	Y	0.00
<b>C51</b>	Bias for PID command 1 (Bias value)	-100.0 to 100.00 <sup>*1</sup>	0.01	%	Y	0.00
<b>C52</b>	(Bias reference point)	0.00 to 100.00 <sup>*1</sup>	0.01	%	Y	0.00
<b>C53</b>	Selection of Normal/ Inverse Operation (Frequency command 1)	0 : Normal operation 1 : Inverse operation	—	—	Y	0

●P codes: Motor Parameters

Code	Name	Data setting range	Increment	Unit	Data copying <sup>2</sup>	Default setting
<b>P01</b>	Motor (No. of poles)	2 to 22	2	Pole	Y1 Y2	4
<b>P02</b>	(Rated capacity)	0.01 to 1000 (where, the data of function code P99 is 0, 3, or 4.) 0.01 to 1000 (where, the data of function code P99 is 1.)	0.01 0.01	kW HP	Y1 Y2	Refer to table below
<b>P03</b>	(Rated current)	0.00 to 2000	0.01	A	Y1Y2	Refer to table below
<b>P04</b>	(Auto-tuning)	0 : Disable 1 : Enable (Tune %R1 and %X while the motor is stopped.) 2 : Enable (Tune %R1 and %X while the motor is stopped, and no-load current while running.)	—	—	N	0
<b>P06</b>	(No-load current)	0.00 to 2000	0.01	A	Y1Y2	Refer to table below
<b>P07</b>	(%R1)	0.00 to 50.00	0.01	%	Y1Y2	Refer to table below
<b>P08</b>	(%X)	0.00 to 50.00	0.01	%	Y1Y2	Refer to table below
<b>P99</b>	Motor Selection	0 : Characteristics of motor 0 (Fuji standard motors, 8-series) 1 : Characteristics of motor 1 (HP-rated motors) 3 : Characteristics of motor 3 (Fuji standard motors, 6-series) 4 : Other motors	—	—	Y1Y2	1

●H codes: High Performance Functions

Code	Name	Data setting range	Increment	Unit	Data copying	Default setting
<b>H03</b>	Data Initialization	0 : Disable initialization 1 : Initialize all function code data to the factory defaults 2 : Initialize motor parameters	—	—	N	0
<b>H04</b>	Auto-resetting (Times)	0 : Disable 1 to 10	1	Times	Y	0
<b>H05</b>	(Reset interval)	0.5 to 20.0	0.1	s	Y	5.0
<b>H06</b>	Cooling Fan ON/OFF Control	0 : Disable (Always in operation) 1 : Enable (ON/OFF controllable)	—	—	Y	0
<b>H07</b>	Acceleration/Deceleration Pattern	0 : Linear 1 : S-curve (Weak) 2 : S-curve (Strong) 3 : Curvilinear	—	—	Y	0
<b>H09</b>	Select Starting Characteristics (Auto search for idling motor speed)	0 : Disable 3 : Enable (Follow Run command, either forward or reverse.) 4 : Enable (Follow Run command, both forward and reverse.) 5 : Enable (Follow Run command, inversely both forward and reverse.)	—	—	Y	0
<b>H11</b>	Deceleration Mode	0 : Normal deceleration 1 : Coast-to-stop	—	—	Y	0
<b>H12</b>	Instantaneous Overcurrent Limiting	0 : Disable 1 : Enable	—	—	Y	1

## Function Settings

### H codes: High Performance Functions

Code	Name	Data setting range	Increment	Unit	Data copying <sup>2)</sup>	Default setting															
H13	Restart Mode after Momentary Power Failure (Restart time)	0.1 to 10.0	0.1	s	Y1 Y2	Refer to table below															
H14	(Frequency fall rate)	0.00 : Set deceleration time 0.01 to 100.00 999 : Follow the current limit command	0.01	Hz/s	Y	999															
H15	(Continuous running level)	208V series: 200 to 300 460V series: 400 to 600	1	V	Y2	235 470															
H16	(Allowable momentary power failure time)	0.0 to 30.0 999: The longest time automatically determined by the inverter	0.1	s	Y	999															
H17	Select Starting Characteristics (Frequency for idling motor speed)	0.0 to 120.0 999: Harmonize at the maximum frequency	0.1	Hz	Y	999															
H26	PTC Thermistor (Mode selection)	0 : Disable 1 : Enable (Upon detection of (PTC), the inverter immediately trips and stops with <b>OH4</b> displayed.) 2 : Enable (Upon detection of (PTC), the inverter continues running while outputting alarm signal (THM).)	—	—	Y	0															
H27	(Level)	0.00 to 5.00	0.01	V	Y	1.60															
H30	Communications Link Function (Mode selection)	Frequency command                      Run command 0 : F01/C30                                  F02 1 : RS-485 link                              F02 2 : F01/C30                                  RS-485 link 3 : RS-485 link                              RS-485 link 4 : RS-485 link (Option)                  F02 5 : RS-485 link (Option)                  RS-485 link 6 : F01/C30                                  RS-485 link (Option) 7 : RS-485 link                              RS-485 link (Option) 8 : RS-485 link (Option)                  RS-485 link (Option)	—	—	Y	0															
H42	Capacitance of DC Link Bus Capacitor	Indication for replacing DC link bus capacitor (0000 to FFFF: Hexadecimal)	1	—	N	—															
H43	Cumulative Run Time of Cooling Fan	Indication of cumulative run time of cooling fan for replacement	—	—	N	—															
H47	Initial Capacitance of DC Link Bus Capacitor	Indication for replacing DC link bus capacitor (0000 to FFFF: Hexadecimal)	—	—	N	Set at factory shipping															
H48	Cumulative Run Time of Capacitors on the Printed Circuit Board	Indication for replacing capacitors on printed circuit board (0000 to FFFF: Hexadecimal). Resettable.	—	—	N	—															
H49	Select Starting Characteristics (Auto search time for idling motor speed)	0.0 to 10.0	0.1	s	Y	0.0															
H50	Non-linear V/f Pattern (Frequency)	0.0 : Cancel 0.1 to 120.0	0.1	Hz	Y	0.0															
H51	(Voltage)	0 to 240: Output a voltage AVR-controlled (for 208 V series) 0 to 500: Output a voltage AVR-controlled (for 460 V series)	1	V	Y2	0															
H56	Deceleration Time for Forced Stop	0.00 to 3600	0.01	s	Y	20.0															
H63	Low Limiter (Mode selection)	0 : Limit by F16 (Frequency Limiter: Low) and continue to run 1 : If the output frequency lowers less than the one limited by F16 (Frequency Limiter: Low), decelerates to stop the motor.	—	—	Y	0															
H64	(Lower limiting frequency)	0.0 (Depends on F16 (Frequency Limiter: Low)) 0.1 to 60.0	0.1	Hz	Y	2.0															
H69	Automatic Deceleration	0 : Disable 3 : Enable (Control DC link bus voltage at a constant.)	—	—	Y	0															
H70	Overload Prevention Control (Frequency drop rate)	0.00: Follow deceleration time specified by F08 0.01 to 100.00 999: Disable	0.01	Hz/s	Y	999															
H71	Deceleration Characteristics	0 : Disable 1 : Enable	—	—	Y	0															
H80	Gain for Suppression of Output Current Fluctuation for Motor	0.00 to 0.40	0.01	—	Y	Refer to table below															
H86	Reserved. <sup>5)</sup>	0 to 2	1	—	Y1 Y2	Refer to table below															
H87	Reserved. <sup>5)</sup>	25.0 to 120.0	0.1	Hz	Y	25.0															
H88	Reserved. <sup>5)</sup>	0 to 3,999	1	—	N	0															
H89	Motor overload memory retention	0 : Inactive 1 : Active	—	—	Y	1															
H90	Reserved. <sup>5)</sup>	0,1	—	—	Y	0															
H91	C1 disconnection detection time (PID control feedback line)	0.0 : Disable 0.1 to 60.0 : Detection time	0.1	s	Y	0.0															
H92	Continue to Run (P-component: gain)	0.000 to 10.000,999 <sup>1)</sup>	0.001	Times	Y1 Y2	999															
H93	(I-component: time)	0.010 to 10.000,999 <sup>1)</sup>	0.001	s	Y1 Y2	999															
H94	Cumulative Run Time of Motor	Change or reset the cumulative data	—	—	N	—															
H95	DC Braking (Braking response mode)	0 : Slow 1 : Quick	—	—	Y	1															
H96	STOP Key Priority/ Start Check Function	<table border="1"> <thead> <tr> <th>Data</th> <th>STOP key priority</th> <th>Start check function</th> </tr> </thead> <tbody> <tr> <td>0</td> <td>Disable</td> <td>Disable</td> </tr> <tr> <td>1</td> <td>Enable</td> <td>Disable</td> </tr> <tr> <td>2</td> <td>Disable</td> <td>Enable</td> </tr> <tr> <td>3</td> <td>Enable</td> <td>Enable</td> </tr> </tbody> </table>	Data	STOP key priority	Start check function	0	Disable	Disable	1	Enable	Disable	2	Disable	Enable	3	Enable	Enable	—	—	Y	3
Data	STOP key priority	Start check function																			
0	Disable	Disable																			
1	Enable	Disable																			
2	Disable	Enable																			
3	Enable	Enable																			
H97	Clear Alarm Data	Setting H97 data to "1" clears alarm data and then returns to zero.	—	—	N	0															
H98	Protection/ Maintenance Function	0 to 63: Display data on the keypad's LED monitor in decimal format (In each bit, "0" for disabled, "1" for enabled.) Bit 0 : Lower the carrier frequency automatically Bit 1 : Detect input phase loss Bit 2 : Detect output phase loss Bit 3 : Select life judgment criteria of DC link bus capacitor Bit 4 : Judge the life of DC link bus capacitor Bit 5 : Detect DC fan lock	—	—	Y	19 (Bits 4, 1, 0 = 1 Bits 5, 3, 2 = 0)															



● J codes: Application Functions

Code	Name	Data setting range	Increment	Unit	Data copying <sup>2</sup>	Default setting
J01	PID Control (Mode selection)	0 : Disable 1 : Enable (normal operation) 2 : Enable (inverse operation)	—	—	Y	0
J02	(Remote process command)	0 : Enable (▲ / ▼) keys on keypad 1 : PID process command 1 3 : Enable terminal command (UP) / (DOWN) control 4 : Command via communications link	—	—	Y	0
J03	P (Gain)	0.000 to 30.000 *1	0.001	Times	Y	0.100
J04	I (Integral time)	0.0 to 3600.0 *1	0.1	s	Y	0.0
J05	D (Differential time)	0.00 to 600.00 *1	0.01	s	Y	0.00
J06	(Feedback filter)	0.0 to 900.0	0.1	s	Y	0.5
J10	(Anti reset windup)	0 to 200	1	%	Y	200
J11	(Select alarm output)	0 : Absolute-value alarm 1 : Absolute-value alarm (with Hold) 2 : Absolute-value alarm (with Latch) 3 : Absolute-value alarm (with Hold and Latch) 4 : Deviation alarm 5 : Deviation alarm (with Hold) 6 : Deviation alarm (with Latch) 7 : Deviation alarm (with Hold and Latch)	—	—	Y	0
J12	(Upper limit alarm (AH))	0 to 100	1	%	Y	100
J13	(Lower limit alarm (AL))	0 to 100	1	%	Y	0
J15	(Stop frequency for slow flowrate)	0: Disable 1 to 120	1	Hz	Y	0
J16	(Slow flowrate level stop latency)	1 to 60	1	s	Y	30
J17	(Starting frequency)	0 : Disable 1 to 120	1	Hz	Y	0
J18	(Upper limit of PID process output)	1 to 120 999: Depends on setting of F15	1	Hz	Y	999
J19	(Lower limit of PID process output)	1 to 120 999: Depends on setting of F16	1	Hz	Y	999
J21	Dew Condensation Prevention (Duty)	1 to 50	1	%	Y	1
J22	Commercial Power Switching Sequence	0 : Keep inverter operation (Stop due to alarm) 1 : Automatically switch to commercial-power operation	—	—	Y	0
J25	Pump Control (Mode selection)	0 : Disable 1 : Enable (Fixed, inverter-driven) 2 : Enable (Floating, inverter-driven)	—	—	Y	0
J26	Motor 1 Mode	0 : Disable (Always OFF) 1 : Enable 2 : Force to run by commercial power	—	—	Y	0
J27	Motor 2 Mode		—	—	Y	0
J28	Motor 3 Mode		—	—	Y	0
J29	Motor 4 Mode		—	—	Y	0
J30	Motor Switching Order	0 : Fixed 1 : Automatically (Constant run time)	—	—	Y	0
J31	Motor Stop Mode	0 : Stop all motors (inverter- and commercial power-driven) 1 : Stop inverter-driven motor only (excl. alarm state) 2 : Stop inverter-driven motor only (incl. alarm state)	—	—	Y	0
J32	Periodic Switching Time for Motor Drive	0.0 : Disable switching 0.1 to 720.0: Switching time range 999 : Fix to 3 minutes	0.1	h	Y	0.0
J33	Periodic Switching Signaling Period	0.00 to 600.00	0.01	s	Y	0.10
J34	Mount of Commercial Power-driven Motor (Frequency)	0 to 120 999: Depends on setting of J18 (This code is used to judge whether or not to mount a commercial power-driven motor by checking the output frequency of the inverter-driven motor.)	1	Hz	Y	999
J35	(Duration)	0.00 to 3600	Variable	s	Y	0.00
J36	Unmount of Commercial Power-driven Motor (Frequency)	0 to 120 999 : Depends on setting of J19 (This code is used to judge whether or not to unmount a commercial power-driven motor by checking the output frequency of the inverter-driven motor.)	1	Hz	Y	999
J37	(Duration)	0.00 to 3600	Variable	s	Y	0.00
J38	Contacting Delay Time	0.01 to 2.00	0.01	s	Y	0.10
J39	Switching Time for Motor Mount (Decl. time)	0.00 : Depends on the setting of F08, 0.01 to 3600	Variable	s	Y	0.00
J40	Switching Time for Motor Unmount (Accl. time)	0.00 : Depends on the setting of F07, 0.01 to 3600	Variable	s	Y	0.00
J41	Motor Mount/Unmount Switching Level	0 to 100	1	%	Y	0
J42	Switching Motor Mount/ Unmount (Dead band)	0.0 : Disable 0.1 to 50.0	0.1	%	Y	0.0

\*1 When you make settings from the keypad, the incremental unit is restricted by the number of digits that the LED monitor can display.

(Example) If the setting range is from -200.00 to 200.00, the incremental unit is as follows:

"1" for -200 to -100, "0.1" for -99.9 to -10.0, "0.01" for -9.99 to -0.01, "0.01" for 0.00 to 99.99, and "0.1" for 100.0 to 200.0

\*2 Symbols used in the data copy column:

Y: Copied

Y1: Not copied if the inverter capacity differs.

Y2: Not copied if the voltage series differs.

N: Not copied

\*5 H86, H87, H88 and H90 are displayed, but they are reserved for particular manufacturers. Unless otherwise specified, do not access these function codes.

<Changing, setting, and saving data during operation>

□: No data change allowed □: Change with ▲▼ key, and set and save with ⏏ key. □: Change and set with ▲▼ key, and save with ⏏ key.

## ● J codes: Application Functions

Code	Name	Data setting range	Increment	Unit	Data copying <sup>*2</sup>	Default setting	
J43	PID Control Startup Frequency	0: Disable 1 to 120 999: Depends on the setting of J36	1	Hz	Y	999	
J45	Signal Assignment to: (For relay output card) [Y1A/B/C] [Y2A/B/C] [Y3A/B/C]	Selecting function code data assigns the corresponding function to terminals [Y1A/B/C], [Y2A/B/C], and [Y3A/B/C].	—	—	Y	100	
J46		100: Depends on the setting of E20 to E22	—	—	Y	100	
J47		60 (1060) : Mount motor 1, inverter-driven (M1_I) 61 (1061) : Mount motor 1, commercial-power-driven (M1_L) 62 (1062) : Mount motor 2, inverter-driven (M2_I) 63 (1063) : Mount motor 2, commercial-power-driven (M2_L) 64 (1064) : Mount motor 3, inverter-driven (M3_I) 65 (1065) : Mount motor 3, commercial-power-driven (M3_L) 67 (1067) : Mount motor 4, commercial-power-driven (M4_L) 68 (1068) : Periodic switching early warning (MCHG) 69 (1069) : Pump control limit signal (MLIM)	—	—	Y	100	
J48		Cumulative Run Time of Motor (Motor 0)	Indication of cumulative run time of motor for replacement	1	h	Y	—
J49		(Motor 1)		1	h	Y	—
J50	(Motor 2)	1		h	Y	—	
J51	(Motor 3)	1		h	Y	—	
J52	(Motor 4)	1		h	Y	—	
J53	Maximum Cumulative Number of Relay ON Times [Y1A/B/C] to [Y3A/B/C]	Indication of the maximum number of ON times of relay contacts on the relay output card or those built in inverter Display of 1.000 means 1000 times.	1	Times	Y	—	
J54	[Y1], [Y2], [Y3]		1	Times	Y	—	
J55	[Y5A], [30A/B/C]		1	Times	Y	—	

## ● y codes: Link Functions

Code	Name	Data setting range	Increment	Unit	Data copying <sup>*2</sup>	Default setting
401	RS-485 Communication(Standard) (Station address)	1 to 255	1	—	Y	1
402	(Communications error processing)	0 : Immediately trip and alarm <i>E-r-B</i> 1 : Trip and alarm <i>E-r-B</i> after running for the period specified by timer y03 2 : Retry during the period specified by timer y03. If retry fails, trip and alarm <i>E-r-B</i> . If it succeeds, continue to run. 3 : Continue to run	—	—	Y	0
403	(Error processing timer)	0.0 to 60.0	0.1	s	Y	2.0
404	(Transmission speed)	0 : 2400 bps 1 : 4800 bps 2 : 9600 bps 3 : 19200 bps 4 : 38400 bps	—	—	Y	3
405	(Data length)	0 : 8 bits 1 : 7 bits	—	—	Y	0
406	(Parity check)	0 : None 1 : Even parity 2 : Odd parity	—	—	Y	0
407	(Stop bits)	0 : 2 bits 1 : 1 bit	—	—	Y	0
408	(No-response error detection time)	0 (No detection), 1 to 60	1	s	Y	0
409	(Response latency time)	0.00 to 1.00	0.01	s	Y	0.01
410	(Protocol selection)	0 : Modbus RTU protocol 1 : FRENIC Loader protocol (SX protocol) 3 : Metasys-N2 4 : FLN P1	—	—	Y	1

\*2 Symbols used in the data copy column:

Y: Copied

Y1: Not copied if the inverter capacity differs.

Y2: Not copied if the voltage series differs.

N: Not copied

<Changing, setting, and saving data during operation>

: No data change allowed : Change with key, and set and save with key. : Change and set with key, and save with key.

● y codes: Link Functions

Code	Name	Data setting range	Increment	Unit	Data copying <sup>2</sup>	Default setting
y11	RS-485 Communication (Option) (Station address)	1 to 255	1	—	Y	1
y12	(Communications error processing)	0 : Immediately trip and alarm <i>ErP</i> 1 : Trip and alarm <i>ErP</i> after running for the period specified by timer y13. 2 : Retry during the period specified by timer y13. If retry fails, trip and alarm <i>ErP</i> . If it succeeds, continue to run. 3 : Continue to run.	—	—	Y	0
y13	(Error processing timer)	0.0 to 60.0	0.1	s	Y	2.0
y14	(Transmission speed)	0 : 2400 bps 1 : 4800 bps 2 : 9600 bps 3 : 19200 bps 4 : 38400 bps	—	—	Y	3
y15	(Data length)	0 : 8 bits 1 : 7 bits	—	—	Y	0
y16	(Parity check)	0 : None 1 : Even parity 2 : Odd parity	—	—	Y	0
y17	(Stop bits)	0 : 2 bits 1 : 1 bit	—	—	Y	0
y18	(No-response error detection time)	0 : (No detection), 1 to 60	1	s	Y	0
y19	(Response latency time)	0.00 to 1.00	0.01	s	Y	0.01
y20	(Protocol selection)	0 : Modbus RTU protocol 3 : Metasys-N2 4 : FLN P1	—	—	Y	0
y98	Bus Link Function (Mode selection)	Frequency command Run command 0: Follow H30 data Follow H30 data 1: Via field bus option Follow H30 data 2: Follow H30 data Via field bus option 3: Via field bus option Via field bus option	—	—	Y	0
y99	Loader Link Function (Mode selection)	Frequency command Run command 0: Follow H30 and y98 data Follow H30 and y98 data 1: Via RS-485 link (Loader) Follow H30 and y98 data 2: Follow H30 and y98 data Via RS-485 link (Loader) 3: Via RS-485 link (Loader) Via RS-485 link (Loader)	—	—	N	0

■ 208V Default setting

Inverter type	F05	F11	F12	E34	P02	P03	P06	P07	P08	H13	H80	H86
FRN001F1S-2U	208	3.16	5.0	3.16	1.00	3.16	1.39	4.61	10.32	0.5	0.20	0
FRN002F1S-2U	208	6.16	5.0	6.16	2.00	6.16	2.53	5.04	9.09	0.5	0.20	0
FRN003F1S-2U	208	8.44	5.0	8.44	3.00	8.44	3.23	3.72	24.58	0.5	0.20	0
FRN005F1S-2U	208	13.60	5.0	13.60	5.00	13.60	4.32	3.99	28.13	0.5	0.20	0
FRN007F1S-2U	208	20.19	5.0	20.19	7.50	20.19	5.63	3.18	34.70	0.5	0.20	0
FRN010F1S-2U	208	27.42	5.0	27.42	10.00	27.42	7.91	2.91	36.89	0.5	0.20	0
FRN015F1S-2U	208	40.44	5.0	40.44	15.00	40.44	11.49	2.48	34.92	1.0	0.20	0
FRN020F1S-2U	208	53.98	5.0	53.98	20.00	53.98	8.32	2.54	35.90	1.0	0.20	0
FRN025F1S-2U	208	65.49	5.0	65.49	25.00	65.49	15.10	2.11	38.01	1.0	0.20	0
FRN030F1S-2U	208	79.06	5.0	79.06	30.00	79.06	17.91	2.29	39.31	1.0	0.20	0
FRN040F1S-2U	208	100.20	10.00	100.20	40.00	100.20	12.30	2.22	30.83	1.0	0.20	0
FRN050F1S-2U	208	126.60	10.00	126.60	50.00	126.60	16.91	2.34	30.27	1.0	0.10	2
FRN060F1S-2U	208	150.80	10.00	150.80	60.00	150.80	18.81	1.57	32.85	1.5	0.10	2
FRN075F1S-2U	208	191.50	10.00	191.50	75.00	191.50	25.86	1.67	32.97	1.5	0.10	2
FRN100F1S-2U	208	248.80	10.00	248.80	100.00	248.80	33.82	1.31	28.97	1.5	0.10	2
FRN125F1S-2U	208	295.60	10.00	295.60	125.00	295.60	26.95	1.28	27.93	1.5	0.10	2

■ 460V Default setting

Inverter type	F05	F11	F12	E34	P02	P03	P06	P07	P08	H13	H80	H86
FRN001F1S-4U	460	1.50	5.0	1.50	1.00	1.50	0.77	3.96	8.86	0.5	0.20	0
FRN002F1S-4U	460	2.90	5.0	2.90	2.00	2.90	1.40	4.29	7.74	0.5	0.20	0
FRN003F1S-4U	460	4.00	5.0	4.00	3.00	4.00	1.79	3.15	20.81	0.5	0.20	0
FRN005F1S-4U	460	6.30	5.0	6.30	5.00	6.30	2.39	3.34	23.57	0.5	0.20	0
FRN007F1S-4U	460	9.30	5.0	9.30	7.50	9.30	3.12	2.65	28.91	0.5	0.20	0
FRN010F1S-4U	460	12.70	5.0	12.70	10.00	12.70	4.37	2.43	30.78	0.5	0.20	0
FRN015F1S-4U	460	18.70	5.0	18.70	15.00	18.70	6.36	2.07	29.13	1.0	0.20	0
FRN020F1S-4U	460	24.60	5.0	24.60	20.00	24.60	4.60	2.09	29.53	1.0	0.20	0
FRN025F1S-4U	460	30.00	5.0	30.00	25.00	30.00	8.33	1.75	31.49	1.0	0.20	0
FRN030F1S-4U	460	36.20	5.0	36.20	30.00	36.20	9.88	1.90	32.55	1.0	0.20	0
FRN040F1S-4U	460	45.50	5.0	45.50	40.00	45.50	6.80	1.82	25.32	1.0	0.20	0
FRN050F1S-4U	460	57.50	10.00	57.50	50.00	57.50	9.33	1.92	24.87	1.0	0.20	0
FRN060F1S-4U	460	68.70	10.00	68.70	60.00	68.70	10.40	1.29	26.99	1.5	0.20	0
FRN075F1S-4U	460	86.90	10.00	86.90	75.00	86.90	14.30	1.37	27.09	1.5	0.10	2
FRN100F1S-4U	460	113.00	10.00	113.00	100.00	113.00	18.70	1.08	23.80	1.5	0.10	2
FRN125F1S-4U	460	134.00	10.00	134.00	125.00	134.00	14.90	1.05	22.90	1.5	0.10	2
FRN150F1S-4U	460	169.00	10.00	169.00	150.00	169.00	45.20	0.96	21.61	1.5	0.10	2
FRN200F1S-4U	460	231.00	10.00	231.00	200.00	231.00	81.80	0.72	20.84	2.0	0.10	2
FRN250F1S-4U	460	272.00	10.00	272.00	250.00	272.00	41.10	0.71	18.72	2.5	0.10	2
FRN300F1S-4U	460	323.00	10.00	323.00	300.00	323.00	45.10	0.53	18.44	2.5	0.10	2
FRN350F1S-4U	460	375.00	10.00	375.00	350.00	375.00	68.30	0.99	19.24	2.5	0.10	2
FRN400F1S-4U	460	429.00	10.00	429.00	400.00	429.00	80.70	1.11	18.92	4.0	0.10	2
FRN450F1S-4U	460	481.00	10.00	481.00	450.00	481.00	85.50	0.95	19.01	4.0	0.10	2
FRN500F1S-4U	460	534.00	10.00	534.00	500.00	534.00	99.20	1.05	18.39	5.0	0.10	2
FRN600F1S-4U	460	638.00	10.00	638.00	600.00	638.00	140.00	0.85	18.38	5.0	0.10	2
FRN700F1S-4U	460	638.00	10.00	638.00	700.00	638.00	140.00	0.85	18.38	5.0	0.10	2
FRN800F1S-4U	460	638.00	10.00	638.00	800.00	638.00	140.00	0.85	18.38	5.0	0.10	2
FRN900F1S-4U	460	638.00	10.00	638.00	900.00	638.00	140.00	0.85	18.38	5.0	0.10	2

# Peripheral Equipment Connection Diagrams

**Remote keypad (Standard equipment)**  
Use an extension cable to perform remote operation.  
**Multi-function keypad**  
TP-G1  
This multi-function keypad has a large 5-digit 7-segment LED with backlit LCD.

**Extension cable for remote operation**  
This cable is used if remote operation is to be performed.  
\* Connector type: RJ-45

Model	Length [ft (m)]
CB-5S	16 (5)
CB-3S	9.8 (3)
CB-1S	3.3 (1)

**Inverter loader software for Windows**  
This software is used to set function codes in the inverter from a personal computer, to manage data, etc.  
**USB-RS-485 converter**, **USB cable**  
[Handled by System Sacom Sales Corp.]

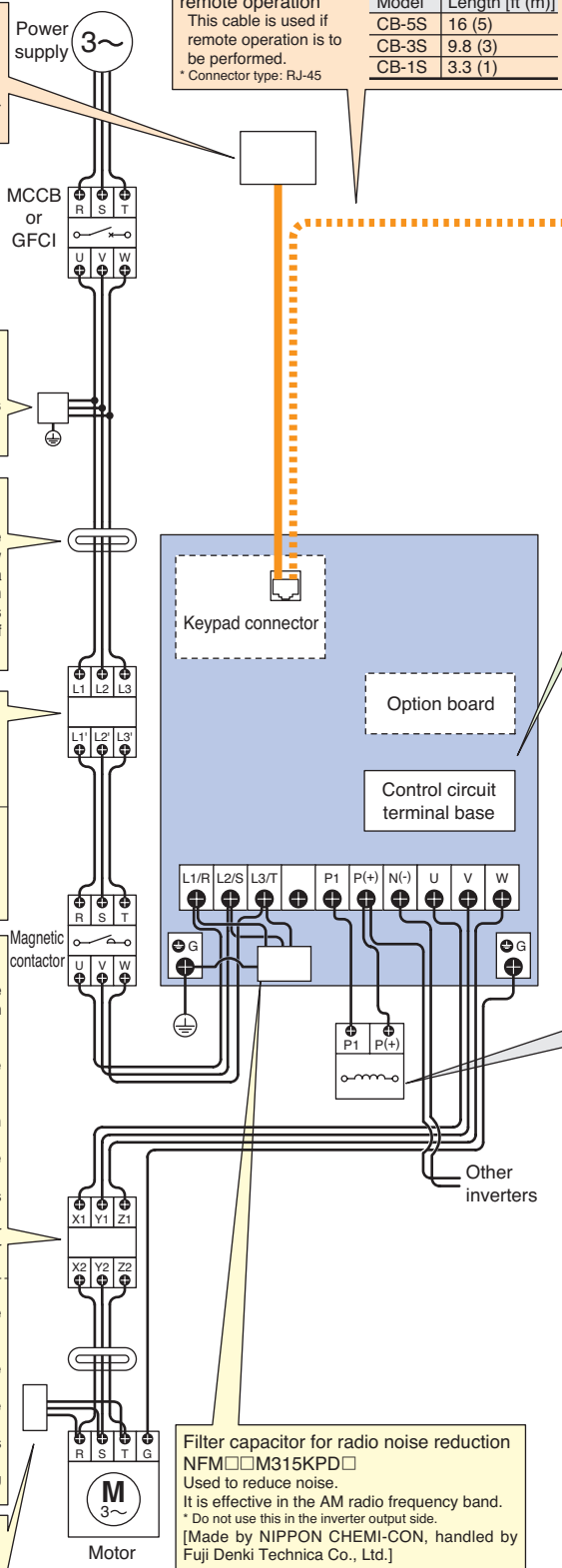
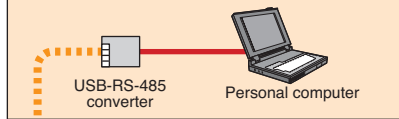

**Arrestor**  
CN232□□□□  
Used to absorb lightning surges that come in from the power supply to protect all the equipment that is connected to the power supply.  
[Handled by Fuji Electric Technica Co., Ltd.]

**Radio noise reducing zero phase reactor**  
ACL-40B, ACL-74B, F200160  
This is used to reduce noise. For the most part, control effects can be obtained in frequency band of 1MHz or higher. Since the frequency band where effects can be obtained is broad, it is effective as a simple countermeasure against noise. If the wiring distance between a motor and the inverter is short (66ft (20m) is a good guideline), it is recommended that it be connected to the power supply side, and if the distance exceeds 66ft (20m), connect it to the output side.

**EMC compliant filter**  
EFL-□□□□  
This is an exclusive filter used to comply with European regulations in the EMC Directives (emissions). For details, make connections in accordance with the "Installation Manual."

**Power filter**  
RNF□□□□-□□  
This filter can be used for the same purpose as the "EMC compliant filter" described above, but it does not comply with the EMC Directives.

**Output circuit filter**  
OFL-□□□□-□  
This filter is connected to the output circuits of low noise type inverters (carrier frequency 8kHz to 15kHz, 6kHz or greater in 40HP or higher inverter) and is used for the following purposes.  
• Suppresses fluctuation of motor terminal voltages.  
Prevents damage to motor insulation due to surge voltage in 460V series inverters.  
• Suppresses leak current in output side wiring.  
Reduces leak current when multiple motors are run side by side or when there is long distance wiring.  
• Suppresses radiation noise and induction noise from output side wiring.  
If the wiring length in a plant, etc. is long, it is effective as a countermeasure for noise reduction.  
\* When this filter is connected, be sure to set the carrier frequency (F26) at 8kHz or higher (6kHz or higher for 40HP or larger model).

**OFL-□□□□-4A**  
This filter is connected to the inverter output circuit for the following purposes.  
• Suppresses fluctuation of motor terminal voltages.  
Prevents damage to motor insulation due to surge voltage in 460V series inverters.  
• Suppresses radiation noise and induction noise from output side wiring.  
If the wiring length in a plant, etc. is long, it is effective as a noise reduction countermeasure.  
\* This filter is not limited by carrier frequency. Also, motor tuning can be carried out with this option in the installed state.

**Surge suppression unit**  
SSU-□□□□-□TA-NS  
Prevents the motor insulation from being damaged by the surge current of the inverter.

**Surge absorber**  
S2-A-O: For magnetic contactors  
S1-B-O: For mini control relays, timers  
Absorbs external surges and noise and prevents malfunction of magnetic contactors, mini control relays and timers, etc.  
[Handled by Fuji Electric Technica Co., Ltd.]

**Surge killer**  
FLS-323  
Absorbs external surges and noise, preventing malfunction of electronic devices used in control panels, etc.

- **Interface card**
- DeviceNet card  
OPC-F1-DEV
- PROFIBUS card  
OPC-F1-PDP
- LONWORKS card  
OPC-F1-LNW
- BACnet card  
OPC-F1-BAC(available soon)
- Relay output card  
OPC-F1-RY  
This option card is used to convert the transistor outputs from the FRENIC Eco's terminals Y1 to Y3 into the relay outputs.  
Caution: FRENIC Eco's terminals Y1 to Y3 cannot be used while this card is installed.  
• Relay output: Built-in three circuits  
• Signal type: SPDT contact  
• Contact capacity: 250V AC, 0.3A cosφ=0.3  
48V DC, 0.5A (resistance load)

- DC Reactor**  
DCR□-□□□□  
(For power supply coordination)
- 1) Used when the power supply's transformer capacity is 500kVA or higher and is 10 or more times the rated capacity of the inverter.
  - 2) Used in cases where a thyristor converter is connected as a load on the same transformer.  
\* If a commutating reactor is not used in the thyristor converter, it is necessary to connect an AC reactor on the inverter's input side, and so be sure to verify that this is done.
  - 3) Used to prevent tripping in cases where an inverter overvoltage trip is caused by opening and closing of the phase advancing capacitor in the power supply system
  - 4) Used when there is a phase unbalance of 2% or greater in the power supply voltage.  
(For improving input power factor, reducing harmonics)
- Used to reduce the input harmonics current (or improve power factor).
  - \* Concerning reduction effects, please refer to the accompanying guidelines.

**NEMA1 kit (NEMA1-□□□F1-□□)**  
NEMA1 kit, when fitted to the FRENIC-Eco series, protects the inverter body with the structure that conforms to the NEMA1 standard (approved as UL TYPE1).

**Panel-mount adapter**  
This adapter makes the latest inverters interchangeable with older inverter models manufactured by Fuji Electric.

MA-F1-5.5	FRN007P11S-2/4U → FRN007F1S-2/4U
MA-F1-15	FRN020P11S-2/4U → FRN020F1S-2/4U
MA-F1-30	FRN040P11S-2/4U → FRN040F1S-2/4U

**Analog frequency meter**  
(1.77, 2.36inch square (45, 60mm square)) TRM-45, FM-60  
[Handled by Fuji Denki Technica Co., Ltd.]

**Frequency setting VR**  
RJ-13, WAR3W-1kΩ  
[Handled by Fuji Denki Technica Co., Ltd.]

**Mounting adapter for external cooling**  
This is an adapter for relocating the inverter's cooling fan to the outside of the control panel.

PB-F1-5.5	FRN001F1S-2/4U → FRN007F1S-2/4U
PB-F1-15	FRN010F1S-2/4U → FRN020F1S-2/4U
PB-F1-30	FRN025F1S-2/4U → FRN040F1S-2/4U

DC REACTOR

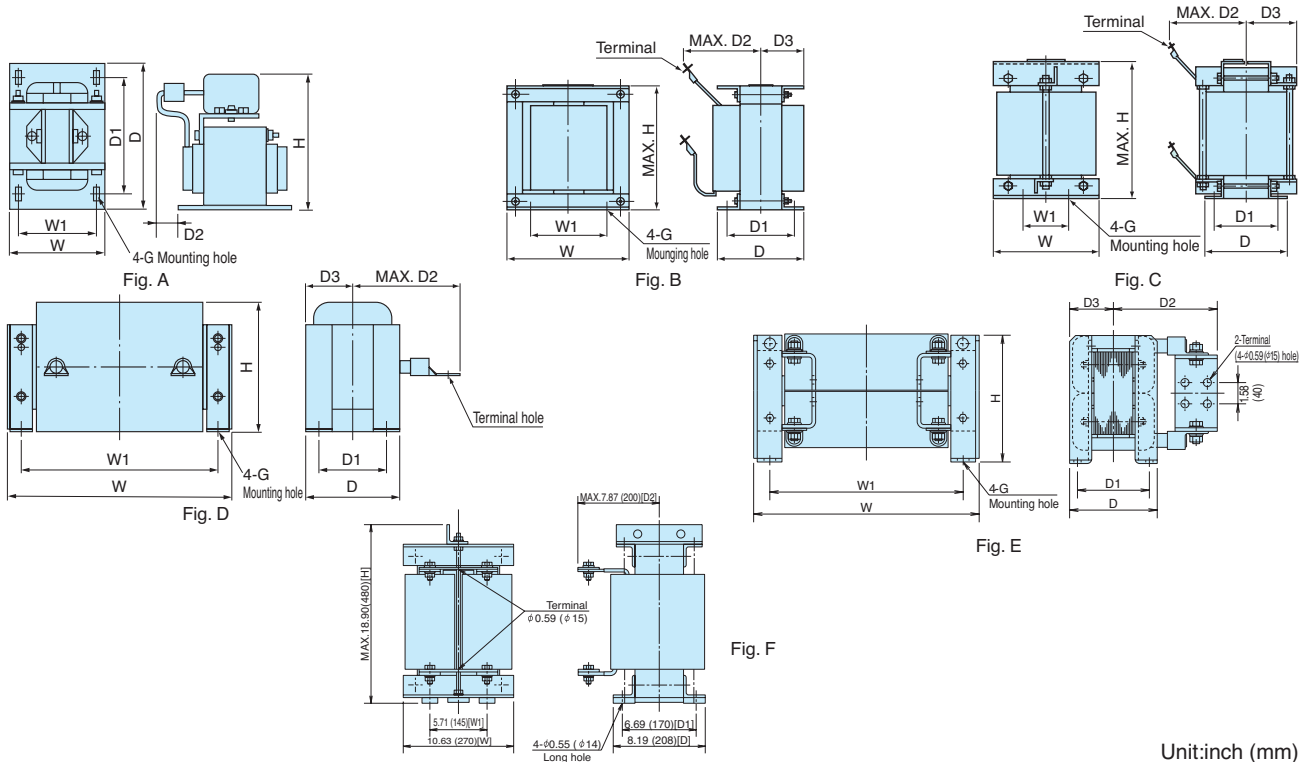

Unit:inch (mm)

Power supply voltage	Applicable motor rating (HP)	Inverter type	REACTOR type	Fig.	Dimensions [inch (mm)]										Mass [lbs(kg)]
					W	W1	D	D1	D2	D3	H	Mounting hole	Terminal hole		
3-phase 208V	1	FRN001F1S-2U	DCR2-1.5	A	2.6(66)	2.20(56)	3.54(90)	2.83(72)	0.79(20)	—	3.70(94)	0.2x0.31(5.2x8)	M4	3.5(1.6)	
	2	FRN002F1S-2U	DCR2-2.2	A	3.39(86)	2.80(71)	3.94(100)	3.15(80)	0.39(10)	—	4.33(110)	0.24x0.43(6x11)	M4	4.0(1.8)	
	3	FRN003F1S-2U	DCR2-3.7	A	3.39(86)	2.80(71)	3.94(100)	3.15(80)	0.79(20)	—	4.33(110)	0.24x0.43(6x11)	M4	5.7(2.6)	
	5	FRN005F1S-2U	DCR2-7.5	A	4.37(111)	3.74(95)	3.94(100)	3.15(80)	0.91(23)	—	5.12(130)	0.28x0.43(7x11)	M5	8.4(3.8)	
	7	FRN007F1S-2U	DCR2-11	A	4.37(111)	3.74(95)	3.94(100)	3.15(80)	0.94(24)	—	5.39(137)	0.28x0.43(7x11)	M6	9.5(4.3)	
	10	FRN010F1S-2U	DCR2-15	A	5.75(146)	4.88(124)	4.72(120)	3.78(96)	0.59(15)	—	7.09(180)	0.28x0.43(7x11)	M6	13(5.9)	
	15	FRN015F1S-2U	DCR2-18.5	A	5.75(146)	4.88(124)	4.72(120)	3.78(96)	0.98(25)	—	7.09(180)	0.28x0.43(7x11)	M8	16(7.4)	
	20	FRN020F1S-2U	DCR2-24U	A	5.75(146)	4.88(124)	4.72(120)	3.78(96)	0.98(25)	—	7.09(180)	0.28x0.43(7x11)	M8	17(7.5)	
	25	FRN025F1S-2U	DCR2-30B	B	5.98(152)	3.54(90)	6.14(156)	4.57(116)	3.07(78)	5.12(130)	3.07(78)	0.31(8)	M8	26(12)	
	30	FRN030F1S-2U	DCR2-37B	B	6.73(171)	4.33(110)	5.94(151)	4.33(110)	4.53(115)	2.95(75)	5.91(150)	0.31(8)	M8	31(14)	
	40	FRN040F1S-2U	DCR2-45B	B	6.73(171)	4.33(110)	6.54(166)	4.92(125)	4.72(120)	3.39(86)	5.91(150)	0.31(8)	M10	35(16)	
	50	FRN050F1S-2U	DCR2-55B	C	7.48(190)	6.30(160)	5.16(131)	3.54(90)	3.94(100)	2.56(65)	8.27(210)	0.31(8)	M12	35(16)	
	75	FRN075F1S-2U	DCR2-75C	D	10.04(255)	8.86(225)	4.17(106)	3.39(86)	5.71(145)	2.09(53)	5.71(145)	0.24(6)	M12	25(11.4)	
	100	FRN100F1S-2U	DCR2-110C	D	11.81(300)	10.43(265)	4.57(116)	3.54(90)	7.28(185)	2.28(58)	6.30(160)	M8	M12	37(17)	
125	FRN125F1S-2U	DCR4-0.75	A	2.6(66)	2.20(56)	3.54(90)	2.83(72)	0.79(20)	—	3.70(94)	0.20x0.31(5.2x8)	M4	3.1(1.4)		
3-phase 460V	1	FRN001F1S-4U	DCR4-1.5	A	2.6(66)	2.20(56)	3.54(90)	2.83(72)	0.79(20)	—	3.70(94)	0.20x0.31(5.2x8)	M4	3.5(1.6)	
	2	FRN002F1S-4U	DCR4-2.2	A	3.39(86)	2.80(71)	3.94(100)	3.15(80)	0.59(15)	—	4.33(110)	0.24x0.35(6x9)	M4	4.4(2.0)	
	3	FRN003F1S-4U	DCR4-3.7	A	3.39(86)	2.80(71)	3.94(100)	3.15(80)	0.79(20)	—	4.33(110)	0.24x0.35(6x9)	M4	5.7(2.6)	
	5	FRN005F1S-4U	DCR4-7.5	A	4.37(111)	3.74(95)	3.94(100)	3.15(80)	0.94(24)	—	5.12(130)	0.28x0.43(7x11)	M5	9.3(4.2)	
	7	FRN007F1S-4U	DCR4-11	A	4.37(111)	3.74(95)	3.94(100)	3.15(80)	0.94(24)	—	5.12(130)	0.28x0.43(7x11)	M5	9.5(4.3)	
	10	FRN010F1S-4U	DCR4-15	A	5.75(146)	4.88(124)	4.72(120)	3.78(96)	0.59(15)	—	6.73(171)	0.28x0.43(7x11)	M5	13(5.9)	
	15	FRN015F1S-4U	DCR4-18.5	A	5.75(146)	4.88(124)	4.72(120)	3.78(96)	0.98(25)	—	6.73(171)	0.28x0.43(7x11)	M6	16(7.2)	
	20	FRN020F1S-4U	DCR4-22A	A	5.75(146)	4.88(124)	4.72(120)	3.78(96)	0.98(25)	—	6.73(171)	0.28x0.43(7x11)	M6	16(7.2)	
	25	FRN025F1S-4U	DCR4-30B	B	5.98(152)	3.54(90)	6.18(157)	4.53(115)	3.94(100)	3.07(78)	5.12(130)	0.31(8)	M8	29(13)	
	30	FRN030F1S-4U	DCR4-37B	B	6.73(171)	4.33(110)	5.91(150)	4.33(110)	3.94(100)	2.95(75)	5.91(150)	0.31(8)	M8	33(15)	
	40	FRN040F1S-4U	DCR4-45B	B	6.73(171)	4.33(110)	6.50(165)	4.92(125)	4.33(110)	3.23(82)	5.91(150)	0.31(8)	M8	40(18)	
	50	FRN050F1S-4U	DCR4-55B	B	6.73(171)	4.33(110)	6.69(170)	5.12(130)	4.33(110)	3.35(85)	5.91(150)	0.31(8)	M8	44(20)	
	60	FRN060F1S-4U	DCR4-75C	D	10.04(255)	8.86(225)	4.17(106)	3.39(86)	4.92(125)	2.09(53)	5.71(145)	0.24(6)	M10	27(12.4)	
	75	FRN075F1S-4U	DCR4-90C	D	10.08(256)	8.86(225)	4.57(116)	3.78(96)	5.12(130)	2.28(58)	5.71(145)	0.24(6)	M12	32(14.7)	
	100	FRN100F1S-4U	DCR4-110C	D	12.05(306)	10.43(265)	4.57(116)	3.54(90)	5.51(140)	2.28(58)	6.10(155)	0.31(8)	M12	41(18.4)	
	150	FRN150F1S-4U	DCR4-132C	D	12.05(306)	10.43(265)	4.96(126)	3.94(100)	5.91(150)	2.48(63)	6.30(160)	0.31(8)	M12	49(22)	
	200	FRN200F1S-4U	DCR4-200C	D	14.06(357)	12.20(310)	5.55(141)	4.45(113)	6.50(165)	2.78(70.5)	7.48(190)	0.39(10)	M12	65(29.5)	
	250	FRN250F1S-4U	DCR4-220C	D	14.06(357)	12.20(310)	5.75(146)	4.65(118)	7.28(185)	2.87(73)	7.48(190)	0.39(10)	M12	72(32.5)	
	300	FRN300F1S-4U	DCR4-280C	D	13.78(350)	12.20(310)	6.34(161)	5.24(133)	8.27(210)	3.17(80.5)	7.48(190)	M10	M16	79(36)	
	350	FRN350F1S-4U	DCR4-355C	E	15.75(400)	13.58(345)	6.14(156)	5.04(128)	7.87(200)	3.07(78)	8.86(225)	M10	—	104(47)	
	400	FRN400F1S-4U	DCR4-400C	E	17.52(445)	15.16(385)	5.71(145)	4.61(117)	8.39(213)	2.85(72.5)	9.65(245)	M10	—	115(52)	
450	FRN450F1S-4U	DCR4-450C	E	17.52(445)	15.16(385)	5.91(150)	4.80(122)	8.46(215)	2.95(75)	9.65(245)	M10	—	132(60)		
500	FRN500F1S-4U	DCR4-500C	E	17.52(445)	15.35(390)	6.50(165)	5.39(137)	8.66(220)	3.25(82.5)	9.65(245)	M10	—	154(70)		
600	FRN600F1S-4U	DCR4-560C	F	10.63(270)	5.71(145)	8.19(208)	6.69(170)	7.87(200)	—	18.90(480)	φ0.55(φ14) long hole	φ0.59(φ15)	154(70)		



## ●Interface card

### DeviceNet card (OPC-F1-DEV)

Use this interface card to enter or monitor operation commands or frequency or to change or check the settings of function codes necessary for operation at the master station of DeviceNet.

- Number of connectable nodes: Max. 64 (including the master)
- MAC ID: 0 to 63
- Insulation: 500V DC (by photocoupler)
- Transmission speed: 500kbps/250kbps/125kbps
- Network power consumption: Max. 50mA at 24V DC

### BACnet card (OPC-F1-BAC)

Available soon

### Relay output card (OPC-F1-RY)

Use this option card to convert the transistor outputs issued from the terminals Y1 to Y3 of the main body of FRENIC-Eco into relay outputs.  
Note: FRENIC-Eco's terminals Y1 to Y3 cannot be used while this card is installed.

- Relay outputs: Built-in three circuits
- Contact: SPDT contact
- Contact capacity: 250V AC, 0.3A  $\cos\phi=0.3$   
48V DC, 0.5A (resistance load)

### PROFIBUS card (OPC-F1-PDP)

With this interface card, you can do the following operations from the PROFIBUS-DP master: issuing the inverter operation command, issuing the frequency command, monitoring the operating status, and changing the settings in all the function codes of FRENIC-Eco.

- Transmission speed: 9.6kbps to 12Mbps
- Transmission distance: Max. 3900ft (1200m)
- Connector: 6-pole terminal base

### LONWORKS interface card (OPC-F1-LNW)

With use of this interface card, the peripheral devices (including a master) linked through LONWORKS can be connected to FRENIC-Eco. This allows you to issue an operation command or a frequency setting command from the master.

- No. of network variables: 62
- No. of connectable devices: 24
- Transmission speed: 78kbps

## ●Mounting adapter for external cooling (PB-F1-□□□)

Use this adapter to shift the heat sink to the outside of the control panel. For 50HP or larger inverters, the head sink can be extended, without using this adapter, by simply relocating the mounting base.

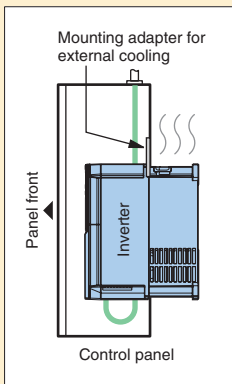

Optional type	Applicable inverter type
PB-F1-5.5	FRN001F1 *-2U
	FRN002F1 *-2U
	FRN003F1 *-2U
	FRN005F1 *-2U
	FRN007F1 *-2U
PB-F1-15	FRN001F1 *-4U
	FRN002F1 *-4U
	FRN003F1 *-4U
	FRN005F1 *-4U
	FRN007F1 *-4U
PB-F1-30	FRN007F1 *-2U
	FRN010F1 *-2U
	FRN015F1 *-2U
	FRN010F1 *-4U
	FRN015F1 *-4U
	FRN020F1 *-4U
	FRN020F1 *-2U
	FRN025F1 *-2U
FRN030F1 *-2U	
PB-F1-50	FRN025F1 *-4U
	FRN030F1 *-4U
	FRN040F1 *-4U
	FRN040F1 *-2U

## ●Extension cable for remote operation (CB-□S)

This straight cable is used to connect the inverter and the remote keypad.

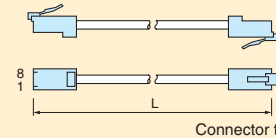

Connector type: RJ-45

Optional type	Length (ft (m))
CB-5S	16 (5)
CB-3S	9.8 (3)
CB-1S	3.3 (1)

**NEMA1 kit (NEMA1-□□□F1-□□)**

NEMA1 kit, when fitted to the FRENIC-Eco series, protects the inverter body with the structure the conforms to the NEMA1 standard (approved as UL TYPE1).

**●Combination between F1S Series Inverter and NEMA1 Cover**

Optional type	Inverter type	Dimensions [inch(mm)]								Outside figure	
		W	H	D	A	B	C	E	Conduit dia × pcs		
NEMA1-5.5F1-24	FRN001 to 005F1S-2U	5.91 (150)	10.24 (260)	6.42 (163)	—	—	—	—	—	φ1.06(27)×3	A
	FRN002 to 007F1S-4U										
NEMA1-11F1-24	FRN007 to 010F1S-2U	8.66 (220)	10.24 (260)	8.47 (215)	—	—	—	—	—	φ1.06(27)×1 φ1.34(34)×2	A
	FRN010 to 015F1S-4U										
NEMA1-15F1-24	FRN015F1S-2U	8.66 (220)	10.24 (260)	8.47 (215)	1.18 (30)	3.57 (90.7)	6.55 (166.4)	—	—	φ1.34(34)×1 φ1.65(42)×2	B
	FRN020F1S-4U										
NEMA1-22F1-24	FRN020 to 025F1S-2U	9.84 (250)	15.75 (400)	8.47 (215)	—	—	—	—	—	φ1.34(34)×1 φ1.65(42)×2	A
	FRN025 to 030F1S-4U										
NEMA1-30F1-24	FRN030F1S-2U	9.84 (250)	15.75 (400)	8.47 (215)	3.94 (100)	7.21 (183.2)	8.07 (205)	—	—	φ1.34(34)×1 φ1.89(48)×2	C
	FRN040F1S-4U										
NEMA1-45F1-24	FRN040F1S-2U	12.60 (320)	21.65 (550)	10.04 (255)	4.92 (125)	4.35 (110.5)	12.73 (323.4)	5.90 (150)	—	φ1.89(48)×1 φ2.52(64)×3	D
	FRN050 to 060F1S-4U										
NEMA1-75F1-2	FRN050 to 60F1S-2U	13.98 (355)	24.21 (615)	10.63 (270)	7.48 (190)	4.35 (110.5)	14.11 (358.4)	8.47 (215)	—	φ1.89(48)×1 φ3.03(77)×3	D
	FRN075 to 100F1S-2U										
NEMA1-75F1-4	FRN075F1S-4U	13.98 (355)	21.65 (550)	10.63 (270)	3.54 (90)	4.35 (110.5)	14.11 (358.4)	4.53 (115)	—	φ1.89(48)×1 φ2.52(64)×3	D
	FRN100F1S-4U										
NEMA1-110F1-4	FRN125 to 150F1S-4U	13.98 (355)	29.13 (740)	11.81 (300)	3.74 (95)	5.53 (140.5)	14.11 (358.4)	4.72 (120)	—	φ1.89(48)×1 φ2.52(64)×3	D
NEMA1-132F1-4	FRN200F1S-4U	20.87 (530)	29.13 (740)	12.40 (315)	3.74 (95)	5.24 (133)	21.00 (533.4)	5.12 (130)	—	φ1.89(48)×1 φ2.52(64)×3	D
NEMA1-110F1-2	FRN125F1S-2U	26.77 (680)	34.65 (880)	15.55 (395)	14.02 (356)	10.04 (255)	26.90 (683.2)	15.16 (385)	—	φ1.89(48)×1 φ3.54(90)×3	D
NEMA1-220F1-4	FRN250 to 300F1S-4U	20.87 (530)	39.37 (1000)	14.17 (360)	5.12 (130)	7.01 (178)	21.00 (533.4)	6.50 (165)	—	φ1.89(48)×1 φ4.33(110)×3	D
	FRN350F1S-4U										
NEMA1-280F1-4	FRN400 to 450F1S-4U	26.77 (680)	39.37 (1000)	14.96 (380)	9.65 (245)	5.58 (141.6)	26.94 (684.2)	11.02 (280)	—	φ1.89(48)×1 φ4.33(110)×3	D
NEMA1-400F1-4	FRN500F1S-4U	26.77 (680)	55.12 (1400)	17.32 (440)	9.95 (240)	7.94 (201.6)	26.94 (684.2)	10.83 (275)	—	φ1.89(48)×1 φ5.63(14)×3	D
	FRN600F1S-4U										
NEMA1-560F1-4	FRN700F1S-4U	34.65 (880)	55.12 (1400)	17.32 (440)	9.95 (240)	7.94 (201.6)	34.81 (884.2)	10.83 (275)	—	φ1.89(48)×1 φ5.63(14)×3	D
	FRN800F1S-4U										
	FRN900F1S-4U										

Fig. A

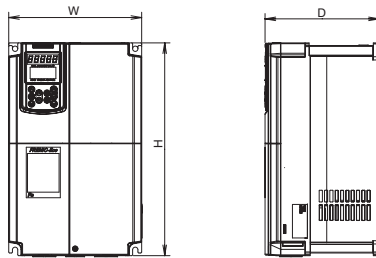

Fig. B

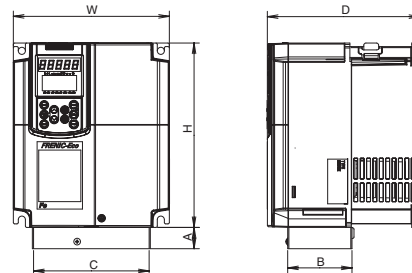

Fig. C

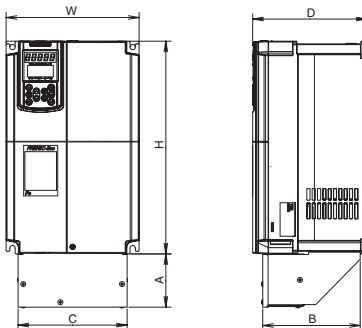
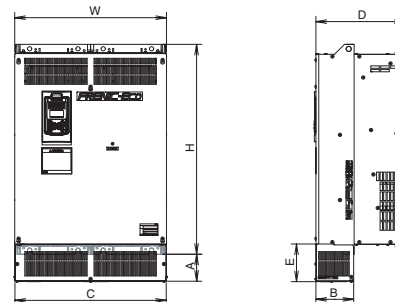

Fig. D



Options

## Required torque and wire size

Power supply voltage	Inverter type	Required torque lb-in (N·m)			Wire size AWG				Class J fuse size (A)	Circuit breaker trip size (A)
		Main terminal	Aux. Control Power Supply R0, T0	Control circuit	Main terminal	Aux. Control Power Supply R0, T0	Aux. Fan Power Supply R1, T1	Control circuit		
				Europe type terminal block				Europe type terminal block		
Three-phase 208 V	FRN001F1S-2U	15.9 (1.8)	10.6 (1.2)	4.4 (0.5)	14	14	—	20	10	15
	FRN002F1S-2U								15	
	FRN003F1S-2U								20	
	FRN005F1S-2U								35	
	FRN007F1S-2U	33.6 (3.8)			8			4	60	50
	FRN010F1S-2U				4				70	70
	FRN015F1S-2U	51.3 (5.8)			3			14	100	100
	FRN020F1S-2U				2				125	125
	FRN025F1S-2U				1/0				150	150
	FRN030F1S-2U				3/0				175	175
	FRN040F1S-2U	119.4 (13.5)			4/0			14	200	200
	FRN050F1S-2U				300				225	225
	FRN060F1S-2U				2/0x2				300	300
	FRN075F1S-2U				4/0x2				350	350
FRN100F1S-2U	238.9 (27)			400	400					
FRN125F1S-2U		424.7 (48)								
Three-phase 460 V	FRN001F1S-4U	15.9 (1.8)	10.6 (1.2)	4.4 (0.5)	14	14	—	20	6	15
	FRN002F1S-4U								10	
	FRN003F1S-4U								15	
	FRN005F1S-4U								20	
	FRN007F1S-4U	33.6 (3.8)			12			10	30	30
	FRN010F1S-4U				10				40	40
	FRN015F1S-4U	51.3 (5.8)			8			14	50	40
	FRN020F1S-4U				6				70	50
	FRN025F1S-4U				4				80	70
	FRN030F1S-4U				2				100	80
	FRN040F1S-4U	119.4 (13.5)			1			14	125	125
	FRN050F1S-4U				1/0				150	150
	FRN060F1S-4U				3x2				175	175
	FRN075F1S-4U				4/0				200	200
	FRN100F1S-4U	238.9 (27)			250			14	225	225
	FRN125F1S-4U				2/0x2				300	300
	FRN150F1S-4U	424.7 (48)			500			14	400	400
	FRN200F1S-4U				4/0x2				450	450
	FRN250F1S-4U				300x2				500	500
	FRN300F1S-4U				350x2				600	600
	FRN350F1S-4U				400x2				700	700
	FRN400F1S-4U				300x3					
	FRN450F1S-4U				350x3					
	FRN500F1S-4U				300x4					
FRN600F1S-4U	350x4									
FRN700F1S-4U	400x4									
FRN800F1S-4U										
FRN900F1S-4U										

\*1: Select the rated current of a fuse or a circuit breaker which is suitable to the connecting wire size.

## To all our customers who purchase Fuji Electric FA Components & Systems' products:

Please take the following items into consideration when placing your order.

When requesting an estimate and placing your orders for the products included in these materials, please be aware that any items such as specifications which are not specifically mentioned in the contract, catalog, specifications or other materials will be as mentioned below.

In addition, the products included in these materials are limited in the use they are put to and the place where they can be used, etc., and may require periodic inspection. Please confirm these points with your sales representative or directly with this company.

Furthermore, regarding purchased products and delivered products, we request that you take adequate consideration of the necessity of rapid receiving inspections and of product management and maintenance even before receiving your products.

### 1. Free of Charge Warranty Period and Warranty Range

#### 1-1 Free of charge warranty period

- (1) The product warranty period is "1 year from the date of purchase" or 24 months from the manufacturing date imprinted on the name place, whichever date is earlier.
- (2) However, in cases where the installation environment, conditions of use, use frequency and times used, etc., have an effect on product life, this warranty period may not apply.
- (3) Furthermore, the warranty period for parts restored by Fuji Electric's Service Department is "6 months from the date that repairs are completed."

#### 1-2 Warranty range

- (1) In the event that breakdown occurs during the product's warranty period which is the responsibility of Fuji Electric, Fuji Electric will replace or repair the part of the product that has broken down free of charge at the place where the product was purchased or where it was delivered. However, if the following cases are applicable, the terms of this warranty may not apply.
  - 1) The breakdown was caused by inappropriate conditions, environment, handling or use methods, etc. which are not specified in the catalog, operation manual, specifications or other relevant documents.
  - 2) The breakdown was caused by product other than the purchased or delivered Fuji product.
  - 3) The breakdown was caused by product other than Fuji product, such as the customer's equipment or software design, etc.
  - 4) Concerning the Fuji's programmable products, the breakdown was caused by a program other than a program supplied by this company, or the results from using such a program.
  - 5) The breakdown was caused by modifications or repairs affected by a party other than Fuji Electric.
  - 6) The breakdown was caused by improper maintenance or replacement using consumables, etc. specified in the operation manual or catalog, etc.
  - 7) The breakdown was caused by a chemical or technical problem that was not foreseen when making practical application of the product at the time it was purchased or delivered.
  - 8) The product was not used in the manner the product was originally intended to be used.
  - 9) The breakdown was caused by a reason which is not this company's responsibility, such as lightning or other disaster.
- (2) Furthermore, the warranty specified herein shall be limited to the purchased or delivered product alone.
- (3) The upper limit for the warranty range shall be as specified in item (1) above and any damages (damage to or loss of machinery or equipment, or lost profits from the same, etc.) consequent to or resulting from breakdown of the purchased or delivered product shall be excluded from coverage by this warranty.

#### 1-3. Trouble diagnosis

As a rule, the customer is requested to carry out a preliminary trouble diagnosis. However, at the customer's request, this company or its service network can perform the trouble diagnosis on a chargeable basis. In this case, the customer is asked to assume the burden for charges levied in accordance with this company's fee schedule.

### 2. Exclusion of Liability for Loss of Opportunity, etc.

Regardless of whether a breakdown occurs during or after the free of charge warranty period, this company shall not be liable for any loss of opportunity, loss of profits, or damages arising from special circumstances, secondary damages, accident compensation to another company, or damages to products other than this company's products, whether foreseen or not by this company, which this company is not be responsible for causing.

### 3. Repair Period after Production Stop, Spare Parts Supply Period (Holding Period)

Concerning models (products) which have gone out of production, this company will perform repairs for a period of 7 years after production stop, counting from the month and year when the production stop occurs. In addition, we will continue to supply the spare parts required for repairs for a period of 7 years, counting from the month and year when the production stop occurs. However, if it is estimated that the life cycle of certain electronic and other parts is short and it will be difficult to procure or produce those parts, there may be cases where it is difficult to provide repairs or supply spare parts even within this 7-year period. For details, please confirm at our company's business office or our service office.

### 4. Transfer Rights

In the case of standard products which do not include settings or adjustments in an application program, the products shall be transported to and transferred to the customer and this company shall not be responsible for local adjustments or trial operation.

### 5. Service Contents

The cost of purchased and delivered products does not include the cost of dispatching engineers or service costs. Depending on the request, these can be discussed separately.

### 6. Applicable Scope of Service

Above contents shall be assumed to apply to transactions and use of the country where you purchased the products. Consult the local supplier or Fuji for the detail separately.



## NOTES

### When running general-purpose motors

- **Driving a 460V general-purpose motor**  
When driving a 460V general-purpose motor with an inverter using extremely long cables, damage to the insulation of the motor may occur. Use an output circuit filter (OFL) if necessary after checking with the motor manufacturer. Fuji's motors do not require the use of output circuit filters because of their reinforced insulation.
- **Torque characteristics and temperature rise**  
When the inverter is used to run a general-purpose motor, the temperature of the motor becomes higher than when it is operated using a commercial power supply. In the low-speed range, the cooling effect will be weakened, so decrease the output torque of the motor. If constant torque is required in the low-speed range, use a Fuji inverter motor or a motor equipped with an externally powered ventilating fan.
- **Vibration**  
When the motor is mounted to a machine, resonance may be caused by the natural frequencies, including that of the machine. Operation of a 2-pole motor at 60Hz or more may cause abnormal vibration.  
\* Study use of tier coupling or dampening rubber.  
\* It is also recommended to use the inverter jump frequency control to avoid resonance points.
- **Noise**  
When an inverter is used with a general-purpose motor, the motor noise level is higher than that with a commercial power supply. To reduce noise, raise carrier frequency of the inverter. High-speed operation at 60Hz or more can also result in more noise.

### When running special motors

- **High-speed motors**  
When driving a high-speed motor while setting the frequency higher than 120Hz, test the combination with another motor to confirm the safety of high-speed motors.
- **Explosion-proof motors**  
When driving an explosion-proof motor with an inverter, use a combination of a motor and an inverter that has been approved in advance.
- **Submersible motors and pumps**  
These motors have a larger rated current than general-purpose motors. Select an inverter whose rated output current is greater than that of the motor.  
These motors differ from general-purpose motors in thermal characteristics. Set a low value in the thermal time constant of the motor when setting the electronic thermal facility.
- **Brake motors**  
For motors equipped with parallel-connected brakes, their braking power must be supplied from the primary circuit (commercial power supply). If the brake power is connected to the inverter power output circuit (secondary circuit) by mistake, problems may occur.  
Do not use inverters for driving motors equipped with series-connected brakes.
- **Geared motors**  
If the power transmission mechanism uses an oil-

lubricated gearbox or speed changer/reducer, then continuous motor operation at low speed may cause poor lubrication. Avoid such operation.

- **Synchronous motors**  
It is necessary to use software suitable for this motor type. Contact Fuji for details.
- **Single-phase motors**  
Single-phase motors are not suitable for inverter-driven variable speed operation. Use three-phase motors.  
\* Even if a single-phase power supply is available, use a three-phase motor as the inverter provides three-phase output.

### Environmental conditions

- **Installation location**  
Use the inverter in a location with an ambient temperature range of -10 to 50°C (14 to 122°F). The inverter and braking resistor surfaces become hot under certain operating conditions. Install the inverter on nonflammable material such as metal. Ensure that the installation location meets the environmental conditions specified in "Environment" in inverter specifications.

### Combination with peripheral devices

- **Installing a molded case circuit breaker (MCCB)**  
Install a recommended molded case circuit breaker (MCCB) or a ground-fault circuit interrupter (GFCI) in the primary circuit of each inverter to protect the wiring. Ensure that the circuit breaker capacity is equivalent to or lower than the recommended capacity.
- **Installing a magnetic contactor (MC) in the output (secondary) circuit**  
If a magnetic contactor (MC) is mounted in the inverter's secondary circuit for switching the motor to commercial power or for any other purpose, ensure that both the inverter and the motor are fully stopped before you turn the MC on or off. Remove the surge killer integrated with the MC.
- **Installing a magnetic contactor (MC) in the input (primary) circuit**  
Do not turn the magnetic contactor (MC) in the primary circuit on or off more than once an hour as an inverter fault may result. If frequent starts or stops are required during motor operation, use FWD/REV signals.
- **Protecting the motor**  
The electronic thermal facility of the inverter can protect the motor. The operation level and the motor type (general-purpose motor, inverter motor) should be set. For high-speed motors or water-cooled motors, set a small value for the thermal time constant to protect the motor.  
If you connect the motor thermal relay to the motor with a long cable, a high-frequency current may flow into the wiring stray capacitance. This may cause the relay to trip at a current lower than the set value for the thermal relay. If this happens, lower the carrier frequency or use the output circuit filter (OFL).
- **Discontinuance of power-factor correcting capacitor**  
Do not mount power factor correcting capacitors in the inverter (primary) circuit. (Use the DC REACTOR to improve the inverter power factor.) Do

not use power factor correcting capacitors in the inverter output circuit (secondary). An overcurrent trip will occur, disabling motor operation.

- **Discontinuance of surge killer**  
Do not mount surge killers in the inverter output (secondary) circuit.
- **Reducing noise**  
Use of a filter and shielded wires are typical measures against noise to ensure that EMC Directives are met.
- **Measures against surge currents**  
If an overvoltage trip occurs while the inverter is stopped or operated under a light load, it is assumed that the surge current is generated by open/close of the phase-advancing capacitor in the power system.  
We recommend connecting a DC REACTOR to the inverter.
- **Megger test**  
When checking the insulation resistance of the inverter, use a 500V megger and follow the instructions contained in the Instruction Manual.

### Wiring

- **Wiring distance of control circuit**  
When performing remote operation, use the twisted shield wire and limit the distance between the inverter and the control box to 65.6ft (20m).
- **Wiring length between inverter and motor**  
If long wiring is used between the inverter and the motor, the inverter will overheat or trip as a result of overcurrent (high-frequency current flowing into the stray capacitance) in the wires connected to the phases. Ensure that the wiring is shorter than 164ft (50m). If this length must be exceeded, lower the carrier frequency or mount an output circuit filter (OFL).
- **Wiring size**  
Select cables with a sufficient capacity by referring to the current value or recommended wire size.
- **Wiring type**  
Do not use multicore cables that are normally used for connecting several inverters and motors.
- **Grounding**  
Securely ground the inverter using the grounding terminal.

### Selecting inverter capacity

- **Driving general-purpose motor**  
Select an inverter according to the applicable motor ratings listed in the standard specifications table for the inverter. When high starting torque is required or quick acceleration or deceleration is required, select an inverter with a capacity one size greater than the standard.
- **Driving special motors**  
Select an inverter that meets the following condition:  
Inverter rated current > Motor rated current.

### Transportation and storage

When transporting or storing inverters, follow the procedures and select locations that meet the environmental conditions that agree with the inverter specifications.

# Fuji Electric FA Components & Systems Co., Ltd.

## Fuji Electric Corp. of America

47520 Westinghouse Drive Fremont, CA 94539, U.S.A.  
Tel.+1-510-440-1060 Fax.+1-510-440-1063

<http://www.fujielectric.com>

Printed on recycled paper

Information in this catalog is subject to change without notice.

Printed in Japan 2008-6 (F08a/E08) CM 30 FIS