

Fox Thermal Instruments, Inc.

**SPECIAL FEATURE OF THE FOX MODEL FT3
THERMAL MASS FLOW METER & TEMPERATURE TRANSMITTER**



Calibration Validation User's Guide



Notice

This publication must be read in its entirety before performing any operation. Failure to understand and follow these instructions could result in serious personal injury and/or damage to the equipment. Should this equipment require repair or adjustment beyond the procedures given herein, contact the factory at:

FOX THERMAL INSTRUMENTS, INC.

399 RESERVATION ROAD

MARINA, CA 93933

TELEPHONE: 831-384-4300

FAX: 831-337-5787

EMAIL: SERVICE@FOXTHERMALINSTRUMENTS.COM

**Download Technical Data Sheets from our website:
www.foxthermalinstruments.com**

Fox Thermal Instruments believes that the information provided herein is accurate however be advised that the information contained herein is NOT a guarantee for satisfactory results. Specifically, this information is neither a warranty nor guarantee, expressed or implied, regarding performance; merchantability; fitness; or any other matter with respect to the products; nor recommendation for the use of the product/process information in conflict with any patent. Please note that Fox Thermal Instruments, Inc. reserves the right to change and/or improve the product design and specification without notice.

Fox FT3 Manuals:

- **Model FT3 Instruction Manual**
- **Fox FT3 RS485 Modbus Manual**
- **Fox FT3 HART Manual**
- **Fox FT3 View™ Software Manual**

Table Of Contents

1. Introduction	Page 4
a. Calibration	Page 4
b. Calibration Validation	Page 4
c. CAL-V™	Page 6
d. Zero CAL-CHECK™	Page 7
2. Start Up	Page 8
a. CAL-V™	Page 8
b. Zero CAL-CHECK™	Page 8
c. Achieving Zero Flow	Page 8
In Pipe	Page 8
Out of Pipe	Page 8
d. Setting Field Baseline	Page 9
e. Packing Gland Assembly	Page 10
f. Starting the Field Baseline Set	Page 13
3. Operation	Page 16
a. Performing CAL-V™	Page 16
b. Performing Zero CAL-CHECK™	Page 18
In Pipe	Page 19
Out of Pipe	Page 20
4. Glossary of Terms and Abbreviations	Page 24
5. Troubleshooting	Page 23
6. Index	Page 25

Introduction

Introduction

Introduction

Thank you for purchasing the Model FT3 Thermal Gas Mass Flow meter and Temperature Transmitter from Fox Thermal Instruments. The Model FT3 is one of the most technically advanced flow meters in the world. Extensive engineering effort has been invested to deliver advanced features, accuracy measurement performance and outstanding reliability.

The new FT3 View software allows users to easily display data and configure the FT3 to their specific application parameters. Then, log flow/temperature data to an Excel file. The software can also activate the new Fox CAL-V™ and Zero CAL-CHECK™ diagnostic functions.

This User's Guide contains the operation instructions for the Calibration Validation diagnostic tests: CAL-V™ and Zero CAL-CHECK™.

This User's Guide is divided into the following sections: Introduction, Start Up, Operation, Troubleshooting, Glossary and Index.

Calibration

Calibration of the Fox Model FT3 Thermal Flow Meter

To ensure that all Fox flow meters meet specified performance parameters and provide accurate, repeatable measurements in the field, all calibrations are performed with NIST-traceable flow standards. Each meter is shipped from the factory with a Fox Calibration Certificate.

Calibration Validation

Calibration Validation

Validating the calibration of your FT3 Flow Meter is simple and easy. By performing two simple tests in the field, operators can verify that the meter is running accurately by testing the functionality of the sensor and its associated signal processing circuitry.

The first test, CAL-V™, tests the functionality of the sensor and its associated signal processing circuitry and can be done in the pipe and in normal processing conditions (see "CAL-V™ Calibration Validation Test" on page 6). The second test, Zero CAL-CHECK™, ensures the repeatability and cleanliness of the sensor (see "Zero CAL-CHECK™ Calibration Validation Test" on page 7).

See Figure 1.1 on the following page to understand Calibration Validation with these two tests.

Introduction

Calibration Validation

Fig. 1.1: Total Calibration Validation

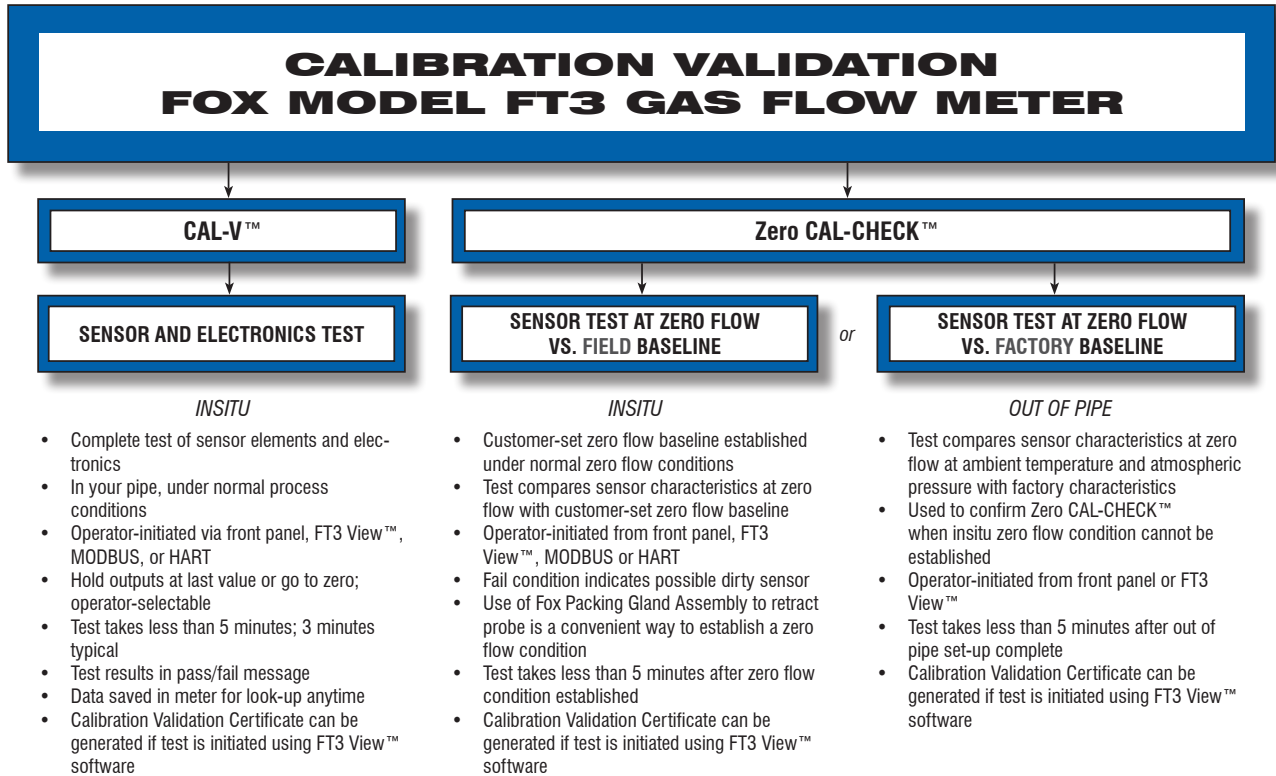

Figure 1.1 above illustrates the Calibration Validation feature and a summary of the details for each of the two tests.

Fox has developed Calibration Validation, using the CAL-V™ and Zero CAL-CHECK™ tests to help our customers avoid sending the meter back for annual or biennial re-calibrations.

Using Calibration Validation allows our customers to validate the accuracy and functionality of the meter in the field with a push of a button.

Introduction

CAL-V™

CAL-V™ Calibration Validation Test

This menu allows the user to confirm the calibration accuracy of the Fox FT3 Flow Meter by verifying the functionality of the sensor and sensor signal processing circuitry. During the CAL-V™ calibration validation test, the microprocessor adjusts the current to the sensor elements and determines the resulting electrical characteristics. These site-determined characteristics are compared with the data that was collected at the factory during the original meter calibration. Matching data within established tolerances confirms the meter is accurate within published accuracy specifications. This test can be performed under no flow or normal flow conditions. The test takes about 4 minutes to complete. At the conclusion of the test, a Pass or Fail message will be displayed.

Note: If the CAL-V™ test is performed using the Fox FT3 View™ Software, at the completion of the test, a CAL-V™ Certificate may be printed for a record of the test. This certificate will display the CAL-V™ values and a pass/fail result.

Fig. 1.2: Normal Mode vs. CAL-V™ Mode

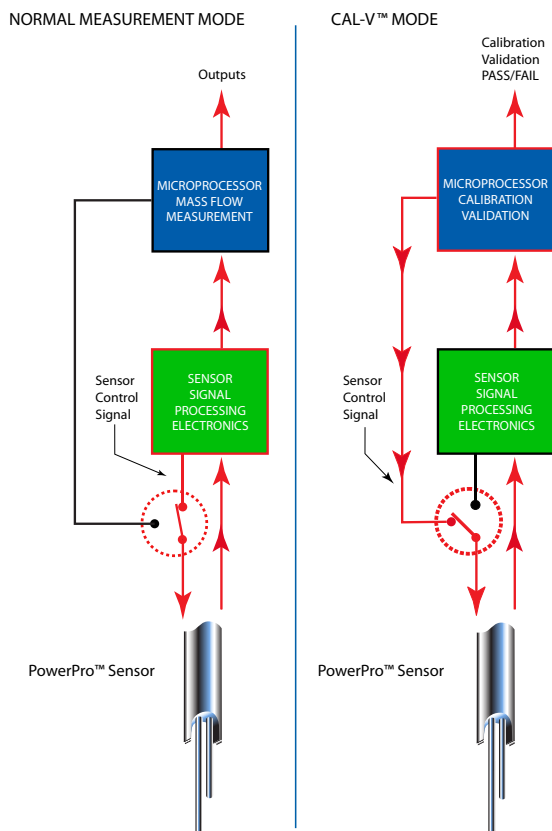

Introduction

Zero CAL-CHECK™

Zero CAL-CHECK™ Calibration Validation Test

The Zero CAL-CHECK™ test is used to ensure that the flow meter still retains its original NIST-traceable calibration at zero flow. If zero flow can be established, the sensor does not need to be removed and the procedure can be done in the pipe. Alternatively, a Fox Packing Gland Assembly can be used to remove the sensor from the gas stream to create a “no flow” condition.

Note: If the Zero CAL-CHECK™ test is performed using the Fox FT3 View™ Software, at the completion of the test, a Zero CAL-CHECK™ Certificate may be printed for a record of the test. This certificate will display a pass/fail result.



Fig. 1.3: Normal Mode vs. Zero CAL-CHECK™ Mode

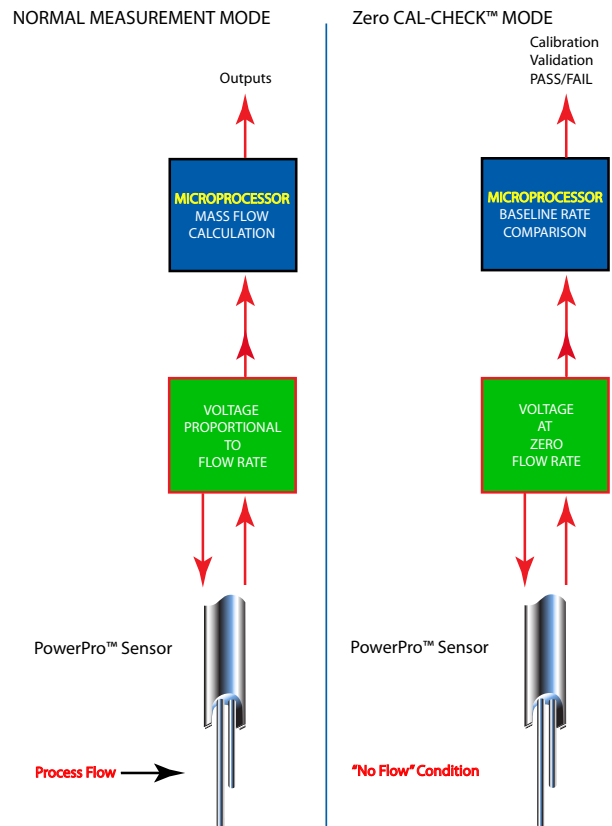

Start Up

CAL-V™

Starting Up CAL-V™

CAL-V™ may be performed at any time after installation and at any flow rate, including zero flow. You do not need any extra equipment or paperwork to perform a CAL-V™ test. Refer to "Performing a CAL-V™ Calibration Validation Test" on p. 16 of this User's Guide to start CAL-V™.

Zero CAL-CHECK™

Starting Up Zero CAL-CHECK™

There are a few ways that Zero CAL-CHECK™ is different than CAL-V™:

- The Zero CAL-CHECK™ test must be performed at a "no flow" condition (ie zero flow)
- If the Zero CAL-CHECK™ test is to be performed in the pipe, the field baseline must be set before an actual test can be performed (see "Setting Field Baseline for In-Situ Zero CAL-CHECK™ Tests" on p. 9).
- If the Zero CAL-CHECK™ test is to be performed out of the pipe, the meter must be set upside-down (probe pointing up) and the PVC sensor protector that the meter was shipped with must be placed back over the sensor to achieve the factory baseline that the meter has been set with.

Achieving Zero Flow - In-Situ (In the Pipe)

Techniques for Achieving Zero Flow - In the Pipe

In-situ (in the pipe) Zero CAL-CHECK™ testing can be achieved in one of two common ways:

1. Fox Packing Gland Assembly

The first in-situ option is achieved through the use of a Fox Packing Gland Assembly that may be ordered as an option for most inline- or insertion-type meters. The assembly allows the operator to retract and isolate the sensor from the process in order to conduct the Zero CAL-CHECK™ test. This is particularly beneficial for applications in which the process is not easily stopped.

2. Pipe Bypass / Valving-Off

The second in-situ option, if space allows, is to redirect the flow through a bypass pipe section or valve off the meter in order to isolate the meter's sensor in the place where it has been installed. While the flow is redirected, the Zero CAL-CHECK™ test can be performed. Once the test is complete, the valves to the bypass may be closed and flow may be directed back to the meter's sensor where flow monitoring can continue as normal.

Achieving Zero Flow - Out of Pipe

Achieving Zero Flow - Out of Pipe

If space limitations prevent in-situ testing at zero flow as listed above, then

Start Up

Out of Pipe testing must be performed.

With this configuration, the meter must be removed from the process, the test performed, and then the meter returned to the process after testing has been completed.

Due to the high sensitivity of the PowerPro™ sensor, it is necessary to isolate the sensor once the meter has been removed from the pipe. Therefore, Fox provides a sensor cover when the meter is shipped to the customer. An alternative to the sensor cover is to use a bottle or other closed container in order to isolate the sensor and achieve the "no flow" condition necessary to perform the Zero CAL-CHECK™ test.

Fig. 2.1: Fox-Supplied PVC Sensor Protector vs. Plastic Bottle

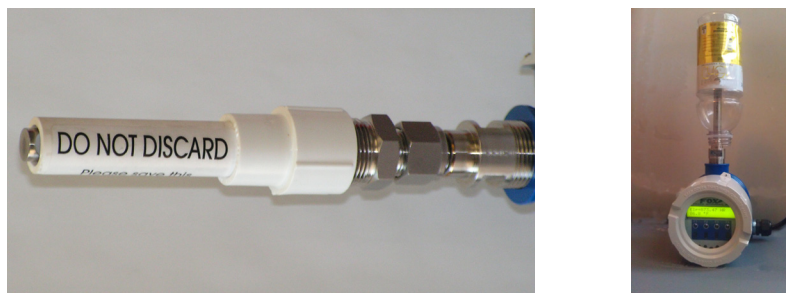

NOTE: For best results:

1. Use the factory-supplied PVC sensor protector shipped with the meter (see Fig. 2.1 above).
2. Place the meter upside-down on a flat, solid surface before starting the test.
3. Do not allow the meter to get jostled - make sure the meter is stable and the sensor completely isolated.

Setting Field Baseline

Setting Field Baseline for In-Situ Zero CAL-CHECK™ tests

After calibration of every FT3 meter, a lab technician sets the factory baseline for Zero CAL-CHECK™ tests. If you are planning on removing the meter from the process to perform the test, you do not have to set the baseline; however, if you plan to perform the test in-situ (in the pipe) or using a Fox Packing Gland Assembly, you must set the field baseline before performing the test.

Start Up

Packing Gland Assembly



Using a Fox Packing Gland Assembly

The following are the instructions for using a Fox Packing Gland Assembly to set the field baseline for - or performing - an in-situ Zero CAL-CHECK™ test. If you are not using a Fox Packing Gland Assembly, move ahead to "Starting the Field Baseline Set" on p. 13.

Note: If you need information on the installation of the Fox Packing Gland Assembly, refer to Fox Document 102497.

Fig. 2.2: FT3 and Parts of Fox Packing Gland Assembly

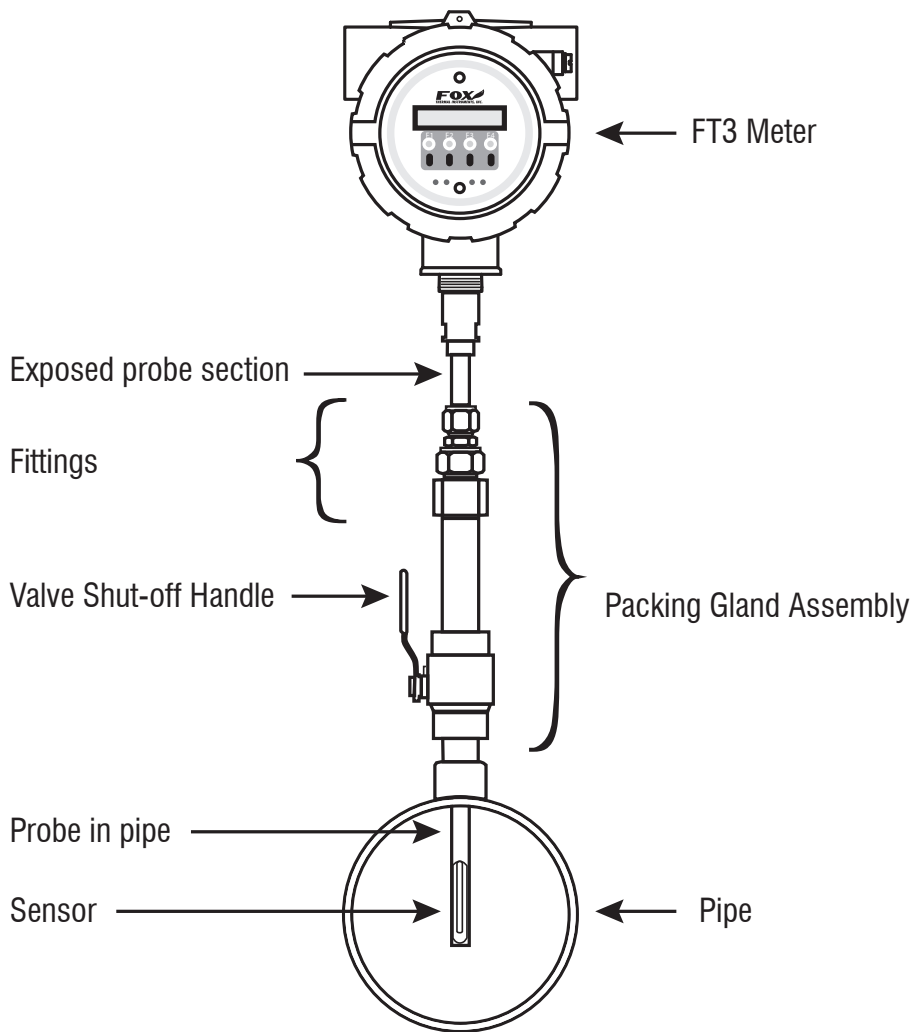

Start Up

Packing Gland Assembly

Fig. 2.3: Close-Up: Fittings of Fox Packing Gland Assembly

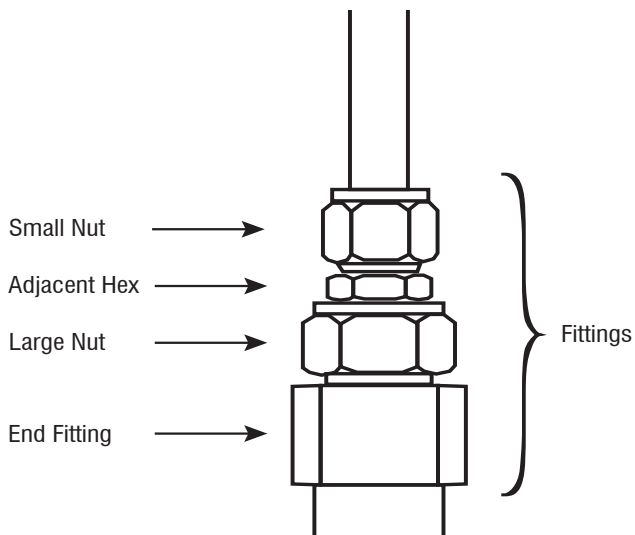

In order to isolate the sensor, it must be retracted from the pipe. Loosen the small nut of the compression fitting using 7/8" and 13/16" wrenches. Once loosened, the probe will be able to slide upwards (see Figure 2.4 below).

Fig. 2.4: Loosening the Compression Fitting

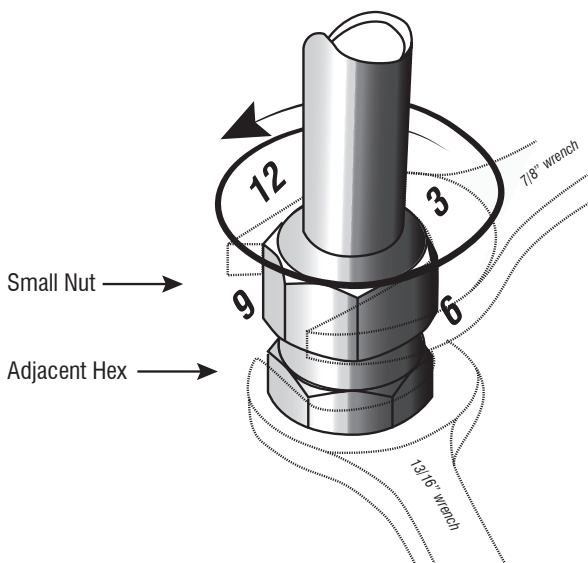

Start Up

Packing Gland Assembly

With one hand supporting the meter, slide the probe up through the packing Gland Assembly until the internal stop makes contact. Close the Valve Shut-off handle by turning the lever 90° clockwise to isolate the sensor within the chamber of the Packing Gland Assembly. Then slightly tighten the compression fitting to keep a seal in the chamber.

Fig. 2.5: Isolating the Sensor in Packing Gland Assembly Chamber

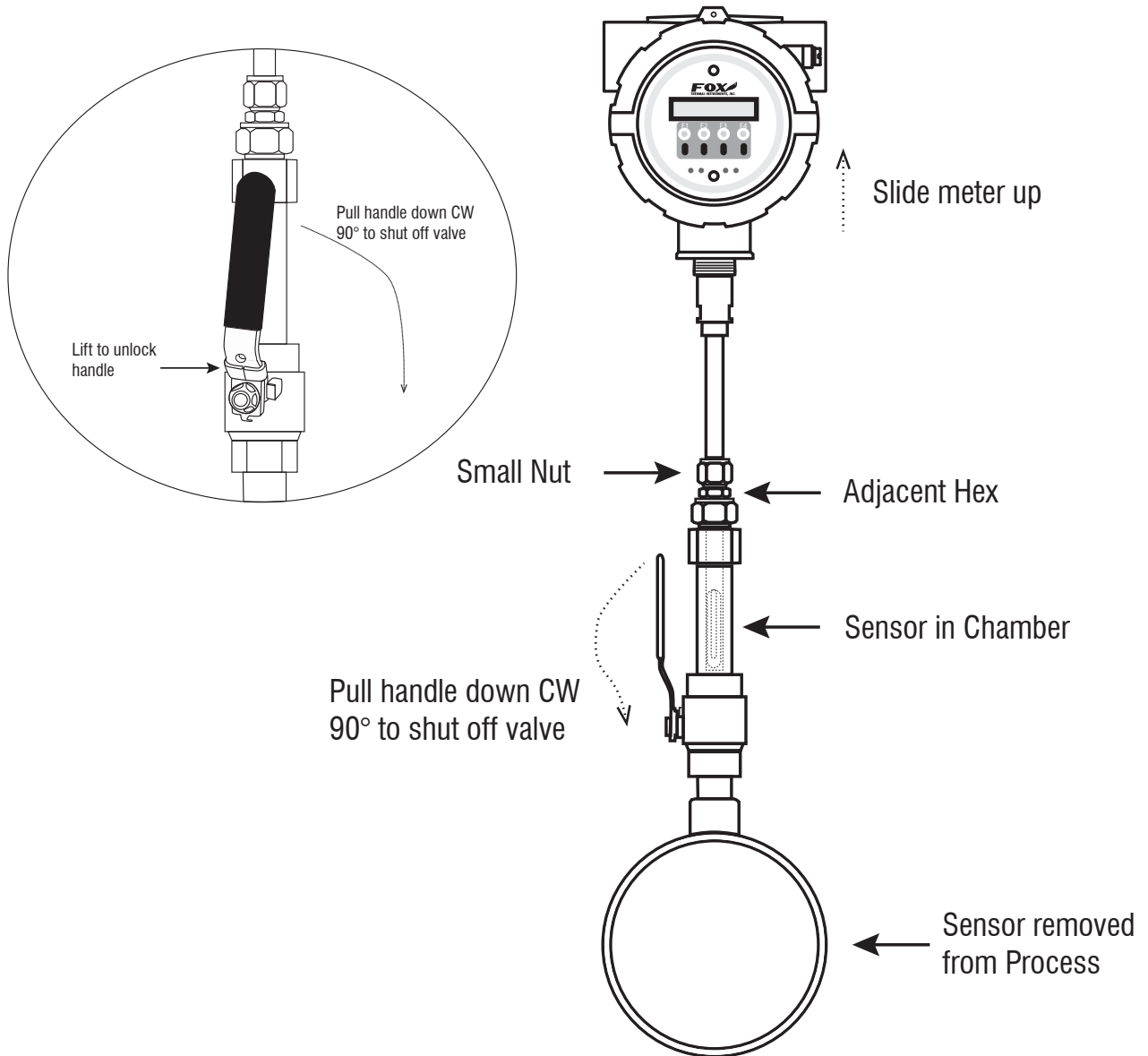

Start Up

Packing Gland Assembly

Now that the sensor is isolated in the chamber of the Packing Gland Assembly, the FT3 meter is ready to either perform the Zero CAL-CHECK™ test or set the Field baseline for future tests.

When the meter has completed the test, be sure to open the shut-off valve, slide the meter downward until the ferrule rests in the fittings, and tighten the small nut of the fittings in order to seal the probe in the stream again.

Check to be sure the meter has returned to normal operation.

Setting Field Baseline

Starting the Field Baseline Set

After the meter has been installed and wired correctly (see the Fox FT3 Instruction Manual that came with the meter), power on the meter. The meter should default to display #1. Press "F1" to program the meter. Press **Yes (F1)** to set Parameters and you will be prompted to enter the password. Use a Level 2 password (9111). The display will show:

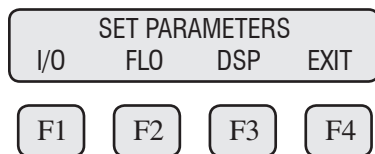

Press **FLO (F2)** to go to the Flow Parameter 1 Menu.

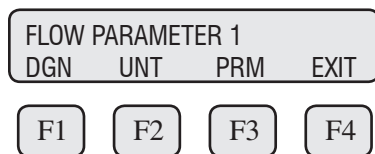

Press **DGN (F1)** to go to the Diagnostic Test Menu.

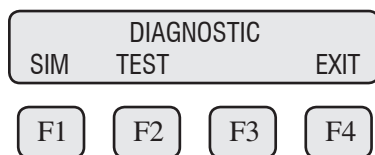

Press **TST (F2)** to get to the Diagnostic Test Sub-Menu.

Start Up

Setting Field
Baseline

DIAGNOSTIC			
CALV	ZRO	EXIT	
F1	F2	F3	F4

Choose **ZRO (F2)** for Zero CAL-CHECK™.

ZERO CHK MENU			
PIP	BTL	EXIT	
F1	F2	F3	F4

Choose **PIP (F1)** for in-situ Zero CAL-CHECK™.

ZERO PIPE TEST			
VER	SET	PRM	EXIT
F1	F2	F3	F4

To set the field baseline, choose **SET (F2)**.

SET ZRO Ref?			
YES			NO
F1	F2	F3	F4

Choose **YES (F1)** to set the field baseline.

Process Zero and Stable?			
			YES
F1	F2	F3	F4



Note: At this point, you must make sure that there is a no flow condition in the pipe (see "Techniques for Achieving Zero Flow - In the Pipe" on p. 8). Also be sure that the meter will be stable for the duration of the setting process.

Start Up

Setting Field Baseline

If there is no flow and the meter is stable, press **YES (F4)**. The display will show:

Setting ZRO ref	
ZR=x.xxxxx	T=xx
F1	F2
F3	F4

As the meter is setting the field baseline, the meter will display the reference value for the Zero baseline (ZR=xx.xxxx) and a countdown timer (T=xx) to approximate the time until the completion of the set.

Depending on the meter configuration, the set may take between 5-15 minutes to complete.

Note: Do not interrupt the set by touching the meter or changing conditions in the pipe.

At the conclusion of the set, the display will show:

Ref=x.xxxx	OK
F1	F2
F3	F4

Press **OK (F4)** to return to the Zero CAL-CHECK™ menu.

The meter may now perform Zero CAL-CHECK™ tests at the Field Baseline at any time.



Operation: CAL-V™

CAL-V™

Performing the CAL-V™ Calibration Validation Test

This menu allows the user to confirm the calibration of the FT3 by verifying the functionality of the sensor and sensor signal processing circuitry. During the CAL-V™ calibration validation test, the microprocessor adjusts current to the sensor elements and determines the resulting electrical characteristics. These site characteristics are compared with the data that was collected at the factory during the original meter calibration. Matching data within established tolerances confirms the meter is accurate. This test can be performed under no flow or normal flow conditions. The test takes up to four minutes to complete. At the conclusion of the test, a Pass or Fail message will be displayed. Press **F4** at the conclusion of the test to return to normal measuring mode or to terminate the test.

Press **FLO (F2)** from the main menu. The display will show:

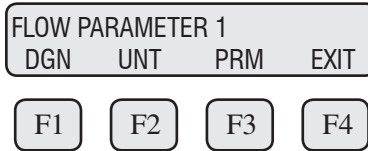

Press **DGN (F1)**. The display will show:

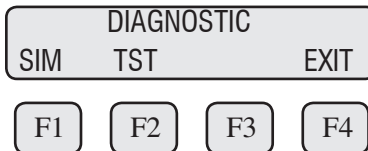

Press **TST (F2)**. The display will show:

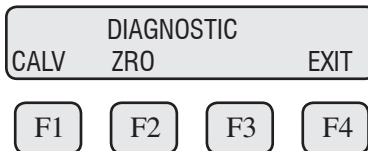

Press **CALV (F1)** to perform the CAL-V™ verification test.

Note: The FT3 will stop measuring flow when performing this test. Press **EXIT (F4)** to exit if you do not wish to continue.



Operation: CAL-V™

CAL-V™

To select what the flow output will do during CAL-V™, choose from these options:

Go To Zero: Flow output will be zero during the test (ie 4mA)

Hold Value: Flow will hold last value during the test

Flo:Go to zero
 NXT EXIT OK

F1 F2 F3 F4

Select the option using **NXT (F1)** and then press **OK (F4)**.

Take Control
 off-line EXIT OK

F1 F2 F3 F4



WARNING: If you are using closed loop control, the system needs to be taken off-line during the test.

Press **OK (F4)** to start CAL-V™. CAL-V™ test screen:

Verifying CAL-V
 Cal = 12.7 T=123

F1 F2 F3 F4

This test will take up to 4 minutes (less time if there is flow) and will show the Cal value changing as the power to the sensor is adjusted. The T=xxx is a count down



Caution:

- The CAL-V™ test is valid for checking the calibration accuracy of flow meters installed in the applications for which it was calibrated including the gas/gas mixture, calibration range and pipe size shown on the calibration certificate.
- For applications with temperature exceeding 250°F (121°C), CAL-V™ test results may vary.
- Periodic inspection for damage and cleaning of the sensor elements is required.

Operation: Zero CAL-CHECK™

CAL-V™

timer indicating how much time is left to finish the test. A “Please Wait” message will be flashing on and off on line 2 during this test.

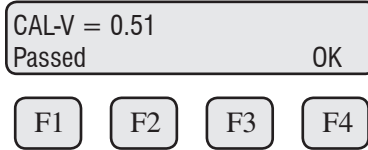

Upon test completion, the final CAL-V™ value will be displayed along with a Pass/Fail message.

Zero CAL-CHECK™

Performing the Zero CAL-CHECK™ Calibration Validation Test

The Zero CAL-CHECK™ test is a companion test to CAL-V™. Unlike CAL-V™, which may be performed in the pipe and at process conditions, Zero CAL-CHECK™ must be performed at zero flow to ensure a valid test result. This test is used to confirm that the flow meter still retains its original NIST-traceable calibration at zero flow and that the sensor is free of film or residue that may affect readings. The test takes less than 5 minutes to complete. At the conclusion of the test, a Pass or Fail message will be displayed. Press **F4** at the conclusion of the test to return to normal measuring mode or to terminate the test.

Press **FLO (F2)** from the main menu. The display will show:

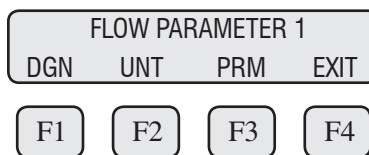

Press **DGN (F1)**. The display will show:

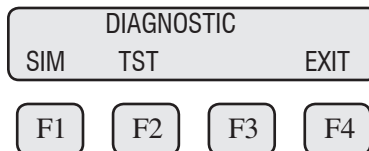

Press **TST (F2)**. The display will show:

OPERATION

Operation: Zero CAL-CHECK™

Zero CAL-CHECK™

DIAGNOSTIC			
CALV	ZRO	EXIT	
F1	F2	F3	F4

Press **ZRO (F2)** to choose the type of Zero CAL-CHECK™ test. If performing the test in the pipe, a "no flow" condition must be created. If performing out of the pipe, the meter must be removed and the sensor protected by a bottle.

ZERO CHK MENU			
PIP	BTL	EXIT	
F1	F2	F3	F4

Zero CAL-CHECK™ - **Performing the Zero CAL-CHECK™ - In the Pipe**

In-situ (In the Pipe)

Press **PIP (F1)** to choose to perform the test **in the pipe**. The display will show:

ZERO PIPE TEST			
VER	SET	PRM	EXIT
F1	F2	F3	F4

Press **VER (F1)** key to verify the Zero CAL-CHECK™ .

VERIFY ZRO?			
YES			NO
F1	F2	F3	F4

Press **YES (F1)** key to verify the Zero CAL-CHECK™ .

Process Zero and			
Stable			YES
F1	F2	F3	F4



WARNING: If you are using "Pipe" test, you must verify that there is a no flow

Operation: Zero CAL-CHECK™

Zero CAL-CHECK™ - In Pipe

condition before proceeding. If you are performing the test in a bottle, be sure to isolate the sensor in a bottle - any air movement (even from a fan) can result in a false "fail" result.

Once process is stable, press **YES (F4)** key to begin the Zero CAL-CHECK™.

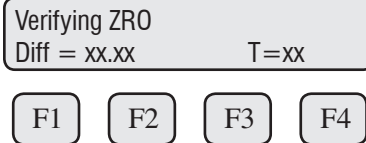

This test will take less than 5 minutes. The T=xx is a count down timer indicating how much time is left to finish the test.



Upon test completion, the final percentage value will be displayed along with a Pass/Fail message.

Zero CAL-CHECK™ - Out of Pipe

Performing the Zero CAL-CHECK™ - Out of Pipe

Remove the meter from the pipe and isolate in an area that will allow the test to go undisturbed (see Note below).

Press **FLO (F2)** from the main menu. The display will show:



NOTE: For best results:

1. Use the factory-supplied PVC sensor protector shipped with the meter (see Fig. 2.1 on p. 9).
2. Place the meter upside-down on a flat, solid surface before starting the test.
3. Do not allow the meter to get jostled - make sure the meter is stable and the sensor completely isolated.

Operation: Zero CAL-CHECK™

Zero CAL-CHECK™ -
Out of Pipe

FLOW PARAMETER 1			
DGN	UNT	PRM	EXIT
F1	F2	F3	F4

Press **DGN (F1)**.

The display will show:

DIAGNOSTIC			
SIM	TST	EXIT	
F1	F2	F3	F4

Press **TST (F2)**. The display will show:

DIAGNOSTIC			
CALV	ZRO	EXIT	
F1	F2	F3	F4

Press **ZRO (F2)** to choose the type of Zero CAL-CHECK™ test.

ZERO CHK MENU			
PIP	BTL	EXIT	
F1	F2	F3	F4

Press **BTL (F2)** to choose to perform the test out of the pipe. The display will show:

ZERO BTL TEST			
VER	EXIT		
F1	F2	F3	F4

Press **VER (F1)** key to verify the Zero CAL-CHECK™.

Operation: Zero CAL-CHECK™

Zero CAL-CHECK™ -
Out of Pipe

VERIFY ZRO?			
YES	NO		
F1	F2	F3	F4

Press **YES (F1)** key to verify the Zero CAL-CHECK™.

Process Zero and Stable?			
	YES		
F1	F2	F3	F4

WARNING: You must verify that there is a no flow condition before proceeding. Be sure to isolate the sensor completely - any air movement (even from a fan) can result in a false "Fail" result.

Once process is stable, press **YES (F4)** key to begin the Zero CAL-CHECK™.

Verifying ZRO			
Diff = xx.xx	T=xx		
F1	F2	F3	F4

This test will take less than 5 minutes. The T=xx is a count down timer indicating how much time is left to finish the test.

Diff=x.xxx % Passed			
	OK		
F1	F2	F3	F4

Upon test completion, the final value will be displayed along with a Pass/Fail message.

OPERATION



Troubleshooting: Calibration Validation



Troubleshooting CAL-V™

Troubleshooting CAL-V™

If the FT3 Meter fails a CAL-V™ Calibration Validation test, the meter must be returned to the factory for evaluation. See the "Returning Your Meter" section in the Appendix of the FT3 Instruction Manual or visit our website at <http://www.foxthermalinstruments.com/rma-guide.php> for information on how to return the meter.

Troubleshooting Zero CAL-CHECK™

Troubleshooting Zero CAL-CHECK™

If the FT3 Meter fails a Zero CAL-CHECK™ Calibration Validation test, there are a few reasons that could be the cause:

1. The sensor may be dirty
 - Try cleaning the sensor and try the test again
 - If the meter fails again, move to #2

2. The sensor may not be properly covered/isolated
 - Out of Pipe:
 - Wind currents (fans in room included) could be affecting the sensor
 - For best results, be sure to use the factory-supplied PVC sensor cover (see Fig. 2.1 on Page 9)
 - If the factory-supplied PVC sensor cover is unavailable, use a clean dry plastic beverage bottle
 - In Pipe:
 - If using the Packing Gland Assembly, be sure that the Shut-off valve has been closed
 - Make sure that there is a "no flow" or zero flow condition on the meter's sensor
 - Try the test again
 - If the meter fails again, move to #3

3. The meter may not have stabilized properly
 - Make sure the meter is not being affected by vibrations or other movement
 - Allow the meter to stabilize without being moved or touched for 15 minutes
 - Try the test again
 - If the meter fails again, contact Fox Technical Assistance at 831-384-4300

Definitions

Glossary of Terms
and Definitions



CAL	Calibration
Diff	Difference
DN	Down
DSP	Display
I/O	Input / Output
NIST	National Institute of Standards and Technology
PC	Personal Computer
PRM	Parameters
PSW	Password
SIM	Simulation

Index

Index

Achieving Zero Flow

In Pipe, p. 8

Out of Pipe, p. 8

Calibration, p. 4

Calibration Validation, p. 4

CAL-V™

Introduction, p. 6

Start Up, p. 8

Performing CAL-V™, p. 16

Baseline

Factory Baseline, p. 9

Field Baseline, p. 9

Setting Field Baseline, p. 13

Packing Gland Assembly, p. 10

Troubleshooting

CAL-V™, Page 23

Zero CAL-CHECK™, Page 23

Zero CAL-CHECK™

Introduction, p. 7

Start Up, p. 8

Performing Zero CAL-CHECK™

In the Pipe, p. 19

Out of Pipe, p. 20



Information



Caution



Wiring



Definition of Terms



Troubleshooting Tips