

FLUKE®

**TiR2, TiR3, TiR4,
Ti40, Ti45, Ti50, Ti55**
IR FlexCam Thermal Imagers

Users Manual

January 2007, Rev. 1, 8/07

©2007 Fluke Corporation, All rights reserved.
All product names are trademarks of their respective companies.

LIMITED WARRANTY AND LIMITATION OF LIABILITY

Each Fluke product is warranted to be free from defects in material and workmanship under normal use and service. The warranty period is two years and begins on the date of shipment. Parts, product repairs, and services are warranted for 90 days. This warranty extends only to the original buyer or end-user customer of a Fluke authorized reseller, and does not apply to fuses, disposable batteries, or to any product which, in Fluke's opinion, has been misused, altered, neglected, contaminated, or damaged by accident or abnormal conditions of operation or handling. Fluke warrants that software will operate substantially in accordance with its functional specifications for 90 days and that it has been properly recorded on non-defective media. Fluke does not warrant that software will be error free or operate without interruption.

Fluke authorized resellers shall extend this warranty on new and unused products to end-user customers only but have no authority to extend a greater or different warranty on behalf of Fluke. Warranty support is available only if product is purchased through a Fluke authorized sales outlet or Buyer has paid the applicable international price. Fluke reserves the right to invoice Buyer for importation costs of repair/replacement parts when product purchased in one country is submitted for repair in another country.

Fluke's warranty obligation is limited, at Fluke's option, to refund of the purchase price, free of charge repair, or replacement of a defective product which is returned to a Fluke authorized service center within the warranty period.

To obtain warranty service, contact your nearest Fluke authorized service center to obtain return authorization information, then send the product to that service center, with a description of the difficulty, postage and insurance prepaid (FOB Destination). Fluke assumes no risk for damage in transit. Following warranty repair, the product will be returned to Buyer, transportation prepaid (FOB Destination). If Fluke determines that failure was caused by neglect, misuse, contamination, alteration, accident, or abnormal condition of operation or handling, including overvoltage failures caused by use outside the product's specified rating, or normal wear and tear of mechanical components, Fluke will provide an estimate of repair costs and obtain authorization before commencing the work. Following repair, the product will be returned to the Buyer transportation prepaid and the Buyer will be billed for the repair and return transportation charges (FOB Shipping Point).

THIS WARRANTY IS BUYER'S SOLE AND EXCLUSIVE REMEDY AND IS IN LIEU OF ALL OTHER WARRANTIES, EXPRESS OR IMPLIED, INCLUDING BUT NOT LIMITED TO ANY IMPLIED WARRANTY OF MERCHANTABILITY OR FITNESS FOR A PARTICULAR PURPOSE. FLUKE SHALL NOT BE LIABLE FOR ANY SPECIAL, INDIRECT, INCIDENTAL OR CONSEQUENTIAL DAMAGES OR LOSSES, INCLUDING LOSS OF DATA, ARISING FROM ANY CAUSE OR THEORY.

Since some countries or states do not allow limitation of the term of an implied warranty, or exclusion or limitation of incidental or consequential damages, the limitations and exclusions of this warranty may not apply to every buyer. If any provision of this Warranty is held invalid or unenforceable by a court or other decision-maker of competent jurisdiction, such holding will not affect the validity or enforceability of any other provision.

Fluke Corporation
P.O. Box 9090
Everett, WA 98206-9090
U.S.A.

Fluke Europe B.V.
P.O. Box 1186
5602 BD Eindhoven
The Netherlands

Table of Contents

Chapter	Title	Page
1	Introduction	1-1
	Introduction	1-1
	Contacting Fluke.....	1-2
	Safety Information	1-2
	Standard Accessories.....	1-4
	Charge and Insert Battery	1-6
	Power Camera On.....	1-7
	Insert Memory Card.....	1-8
	Focus.....	1-8
	Set Temperature Level and Span	1-9
	Set IR-Fusion® Blend Level.....	1-9
	Capturing an Image.....	1-10
	SmartView Software for Your PC	1-11
2	Camera Overview	2-1
	Introduction	2-1
	Camera Parts.....	2-2
	Camera Display Screen.....	2-6
	Programming Function Buttons.....	2-10
	Using Display Screen Menus.....	2-12
	Inserting and Removing Memory Card.....	2-13
3	Basic Operation.....	3-1
	Acquiring and Reviewing Images.....	3-1
	Scan Target.....	3-1
	Pause/Save Image	3-1
	View Saved Image.....	3-2
	Delete Saved Image	3-2
	Electronic Zoom	3-3
	Saved Image Information.....	3-4
4	Analyzing and Enhancing Images	4-1
	Setting Emissivity and Background Temperature.....	4-1
	Fixed Image Function.....	4-2
	Changing Color Palettes	4-2

Setting Temperature Level and Span.....	4-3
Manual Level and Span.....	4-3
Automatic Level and Span.....	4-4
Arbitrary Fixed Temperature Level and Span.....	4-4
Using Palette Saturation Colors.....	4-5
Using Display Screen Temperature Markers.....	4-7
Annotations.....	4-9
Adding Annotations to Saved Images.....	4-9
Creating Annotations Lists in SmartView.....	4-12
5 Visible Light Camera Module (VLCM).....	5-1
Enabling/Disabling Visible Light Camera Module.....	5-1
Using Image Alignment.....	5-1
Focusing.....	5-2
Adjusting IR-VL IR-Fusion® Blend Level.....	5-3
Using Full Screen or Picture-in-Picture View.....	5-4
Adjusting Brightness and Color Controls.....	5-4
Using Torch Control.....	5-5
Using Visible Light Flash.....	5-5
Recording Visible Light Images.....	5-6
Using Laser Pointer.....	5-7
Using Thumbnail Browser.....	5-7
Using Color Alarms.....	5-8
Using Menu to Adjust Color Alarm Ranges.....	5-8
Using Palette Bar to Adjust Color Alarm Ranges.....	5-9
6 Camera Setup.....	6-1
Adjusting Display Screen Brightness.....	6-1
Hiding Display Screen Task Bar.....	6-2
Hiding Display Screen Color Palette.....	6-2
Setting Temperature Units.....	6-3
Setting Temperature Calibration Range.....	6-3
Changing Lens Selection.....	6-3
Setting Date and Time.....	6-4
Changing the Language.....	6-6
Saving and Reloading Camera Settings.....	6-6
Naming Image Files.....	6-7
Changing Image File Name Prefix.....	6-8
Resetting Image File Name Sequence Number.....	6-9
Selecting Video Output Options.....	6-9
7 Advanced Operation.....	7-1
Enhancing the Image.....	7-1
Using Auto Capture.....	7-1
Using User-Defined Display Screen Temperature Markers.....	7-4
Using Internal Recalibration.....	7-7
8 Camera Care.....	8-1
Cleaning the IR Lens, VLCM, Display Screen, and Body.....	8-1
Using Other Lenses.....	8-2

Viewing Camera and Battery Information	8-2
Charging the Batteries	8-3
Recalibrating the Batteries	8-4
Conserving Battery Power	8-5

Appendices

A Glossary	A-1
B Troubleshooting	B-1
C Emissivity Values	C-1
D Camera Specifications and Dimensions	D-1
E Resources and References	E-1
F Camera Default Settings	F-1

List of Tables

Table	Title	Page
1-1.	Standard Accessories	1-6
2-1.	Camera Parts--Descriptions	2-4
2-2.	Display Screen--Descriptions	2-8
2-3.	Programmable Functions	2-10
4-1.	Standard Saturation Colors	4-6
8-1.	Remaining Battery Charge Indicators	8-3
8-2.	Battery Charging Status	8-4
B-1.	Troubleshooting Tips	B-1
C-1.	Emmissivity Values of Common Materials	C-1
D-1.	TiR2, Ti45 and Ti40 Specifications	D-1
D-2.	TiR3, TiR4, Ti55 and Ti50 Specifications	D-7
F-1.	Default Settings, TiR2, Ti45 and Ti40 Models	F-1
F-2.	Default Settings, TiR3, TiR4, Ti55 and Ti50 Models	F-7

TiR2, TiR3, TiR4, Ti40, Ti45, Ti50, Ti55

Users Manual

List of Figures

Figure	Title	Page
1-1.	Standard Accessories	1-5
1-2.	Inserting the Battery.....	1-7
1-3.	Turning the Power On and Off	1-7
1-4.	Inserting a Memory Card	1-8
1-5.	Focusing the Camera	1-8
1-6.	Setting the Level and Span	1-9
1-7.	Setting the IR-Fusion® Blend Level.....	1-10
1-8.	Capturing an Image.....	1-11
2-1.	Camera Back View	2-3
2-2.	Camera Front and Top View.....	2-3
2-3.	Camera Bottom View	2-3
2-4.	Camera Display Screen--Example 1	2-6
2-5.	Camera Display Screen--Example 2	2-7
2-6.	Camera Display Screen--Example 3	2-7
2-7.	Inserting and Removing a Memory Card.....	2-13
5-1.	Aligning the 20-mm Lens	5-2
B-1.	Serial/Part Number and Laser Certification Location.....	B-4
D-1.	Camera Dimensions	D-13
D-2.	Camera Dimensions - Height and Width	D-13

TiR2, TiR3, TiR4, Ti40, Ti45, Ti50, Ti55

Users Manual

Chapter 1

Introduction

Introduction

Thank you for choosing the IR FlexCam[®] portable infrared camera (referred to hereafter as the “Camera”). This award-winning Camera offers some of the most advanced, yet most intuitive, fully-radiometric solutions available. The visible light camera module (VLCM) and IR-Fusion[®] functions make it easier than ever to manage and analyze images captured with this system and improve reporting abilities. The unique control image and IR-Fusion[®] technology enables you to combine visible light images—like a normal digital camera—and infrared images together to create a single image with greatly enhanced detail. This is especially helpful in low contrast scenes where the temperature differential is minimal and the infrared image appears to be all one color.

The IR FlexCam is available in 7 models. The TiR2, Ti40 and Ti45 cameras use a detector with 160 x 120 resolution. The TiR3, TiR4, Ti50 and Ti55 cameras use a detector with 320 x 240 resolution. Refer to Appendix D for specific features available on your camera.

Your Camera is powerful and easy to use in a wide range of applications including:

Predictive Maintenance

- Electrical Systems—Identify circuit overloads before they happen.
- Mechanical Systems—Reduce downtime and prevent failures.
- Utilities—Monitor substations, transmission lines, etc. efficiently and accurately.

Building Science

- Roofing—Detect and isolate water saturation quickly and efficiently.
- Building Envelope—Perform commercial and residential infrared energy audits.

- Moisture Detection—Get to the source of moisture and mold growth.
- Restoration—Evaluate remediation work to make sure area is completely dry.

Research and Development

- Visualize and quantify generated heat patterns to improve products and the processes used to create them.

Process Monitoring

- Monitor and observe temperatures of processes in real-time.

To quickly take advantage of the many functions your Camera offers, we recommend that you carefully read this manual. It is designed to familiarize you with the most important aspects of your camera and guide you in using the features of this system. This manual provides instruction on how to capture high quality images; however, thermography is a sophisticated field often requiring special training that is not covered in this manual. If you would like information on thermography training, contact Fluke Corporation .

Contacting Fluke

To contact Fluke, call:

1-800-760-4523 in USA

1-800-363-5853 in Canada

+31-402-675-200 in Europe

+81-3-3434-0181 in Japan

+65-738-5655 in Singapore

+1-425-446-6888 from anywhere in the world

Or, visit Fluke's Web site at www.fluke.com

To register your product, visit register.fluke.com

Safety Information

Use your Camera only as specified in this manual.

A **⚠ Warning** identifies hazardous conditions and actions that could cause bodily harm or death.

A **⚠ Caution** identifies conditions and actions that could damage the camera or cause permanent loss of data.

⚠ Caution

- **To avoid damaging your Camera, treat it with care as you would any type of precision equipment.**
- **Your infrared camera is a precision instrument that uses a sensitive infrared (IR) detector. Pointing your camera towards highly-intense energy sources—including devices that emit laser radiation and reflections from these devices—may adversely affect camera accuracy and may harm or permanently damage your camera’s IR detector.**
- **Your camera was calibrated prior to shipping. We recommend that you have your camera checked for proper calibration every two years. Some ISO 9000 programs require more frequent checks for certification. Contact Fluke for details.**
- **Your camera requires three minutes to warm up before accurate measurements are available.**

⚠⚠ Warning

- **Your camera contains a Class 2 laser pointer. See diagram in Appendix B for laser aperture location.**
- **To avoid eye damage, do not point laser directly at eye or indirectly off reflective surfaces.**
- **Use of controls or adjustments or performance or procedures other than those specified herein may result in hazardous laser radiation exposure.**
- **Do not use camera in a manner not specified in this manual or the protection provided by the equipment may be impaired.**



This camera contains a lithium battery.

Do not mix with the solid waste stream. Spent batteries should be disposed of by a qualified recycler or hazardous materials handler.

Contact your authorized Fluke Service Center for recycling information.

Standard Accessories

If any of the standard accessories shown in Figure 1-1 and described in Table 1-1 are missing or damaged, contact a Fluke customer service representative.

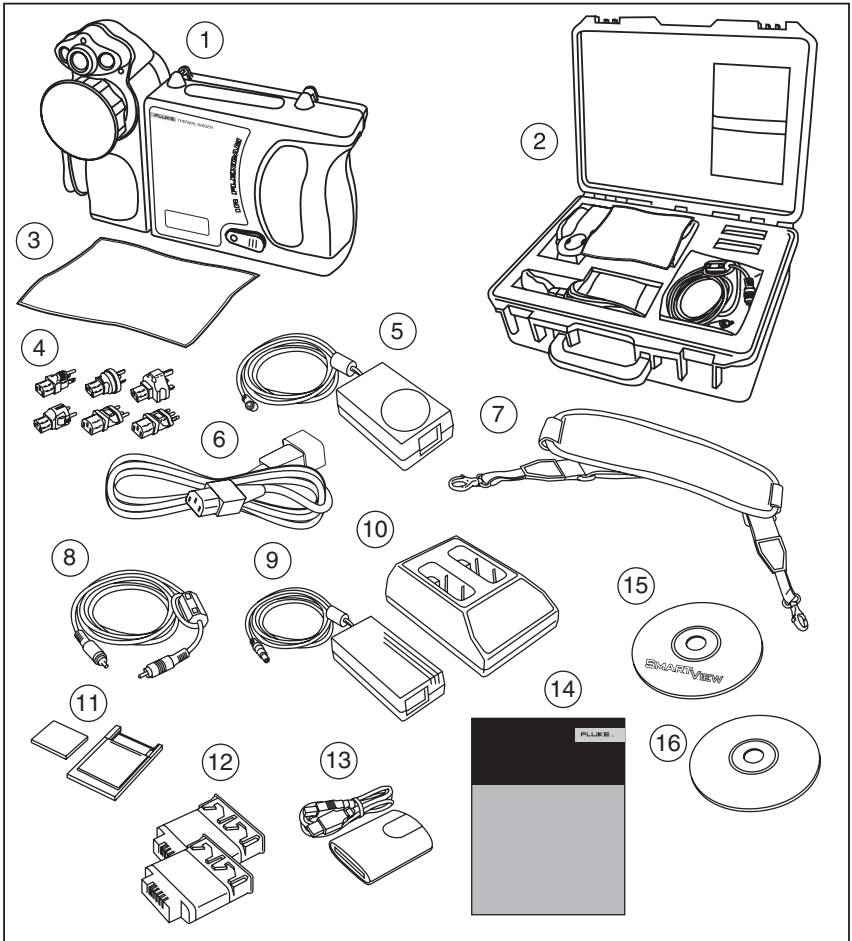

Figure 1-1. Standard Accessories

ei001.eps

Table 1-1. Standard Accessories

Number	Description
①	Portable Infrared Camera with Lens Cap
②	Camera Carrying Case
③	LCD Cleaning Cloth
④	AC adapters (2)
⑤	Auxiliary AC Power Supply (TiR2, TiR4, Ti45 and Ti55 only)
⑥	AC Patch Cord
⑦	Neck Strap
⑧	Video Cable
⑨	AC Power Supply
⑩	Battery Charger
⑪	Compact Flash Memory Card with PCMCIA Adapter
⑫	Two Rechargeable Batteries
⑬	Compact Flash Memory Card Reader with USB Adapter
⑭	Getting Started Guide
⑮	SmartView® Software CD (includes SmartView Users Manual)
⑯	FlexCam Documentation CD (Users Manuals)

Charge and Insert Battery

Charge the batteries for 3 hours before use. Use only the rechargeable batteries supplied. A battery is fully charged when the green LED light on the charger remains solid.

Insert the charged battery into the slot on the bottom of the camera as shown in Figure 1-2.

Note

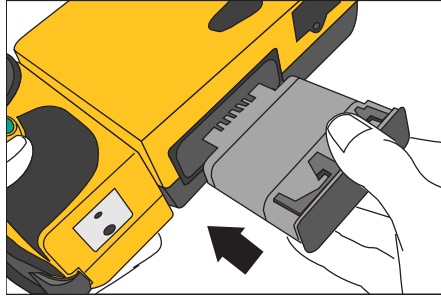

You may use the auxiliary AC power supply to connect the camera to a working AC outlet until at least one of the batteries is charged.



eii002.eps

Figure 1-2. Inserting the Battery

Power Camera On

With a charged battery inserted, or AC power supply connected, press  as shown in Figure 1-3.  lights up green, and the start-up screen appears after approximately 10 seconds.

Note

After powering on your camera, the camera requires a boot up and warm up period of approximately 30 seconds in order to maintain a crisp, clear, real-time image. Three minutes after powering on the camera, the temperature measurement accuracy will be within the specification requirements.

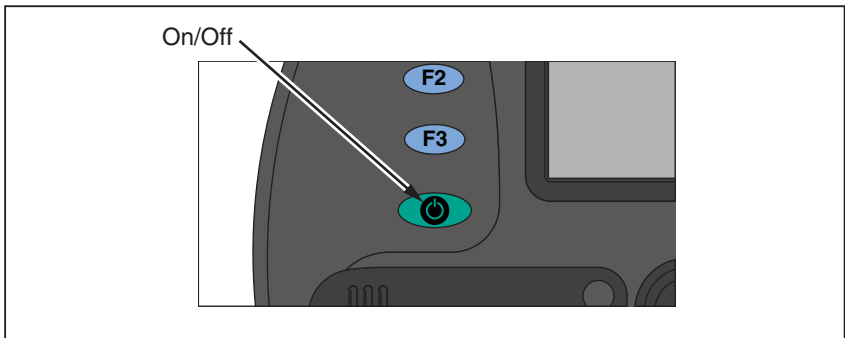

eii003.eps

Figure 1-3. Turning the Power On and Off

Insert Memory Card

1. Pull cover up and rotate as shown in Figure 1-4.
2. Insert the Compact Flash memory card into the slot with the card's connection end pointed at the camera and the label with MB size facing the back of the camera.
3. Look for the "Compact Flash Card inserted" message on the camera display screen.
4. Close the cover.

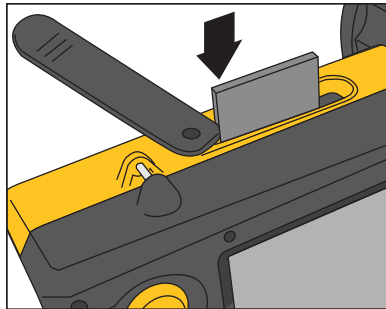

Figure 1-4. Inserting a Memory Card

eii004.eps

Focus

Remove the lens cap, point the lens at the target, and manually rotate the lens with your finger, as shown in Figure 1-5, until the image is in focus.

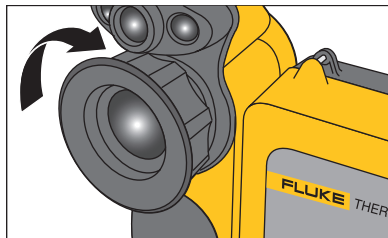



Figure 1-5. Focusing the Camera

eii005.eps

Set Temperature Level and Span

1. Press  as shown in Figure 1-6 to automatically set the camera's temperature level and span.
2. Press  again as needed to properly scale the image.

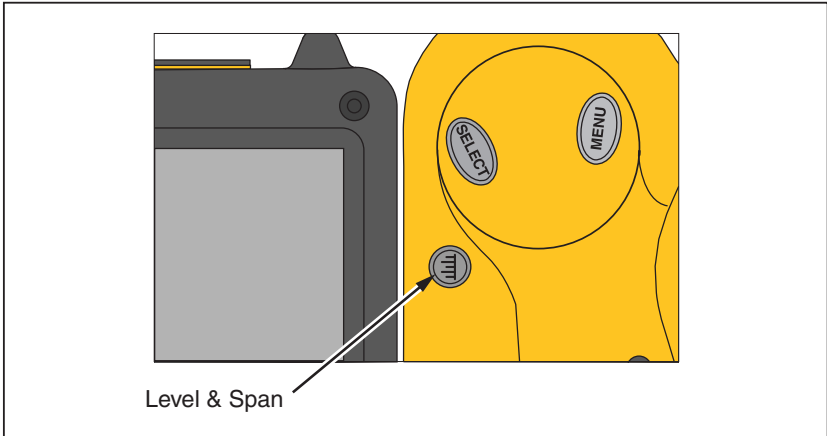





Figure 1-6. Setting the Level and Span

eil006.eps

Set IR-Fusion® Blend Level

Note

IR-Fusion® blending is disabled with optional 10 and 54-mm lenses.

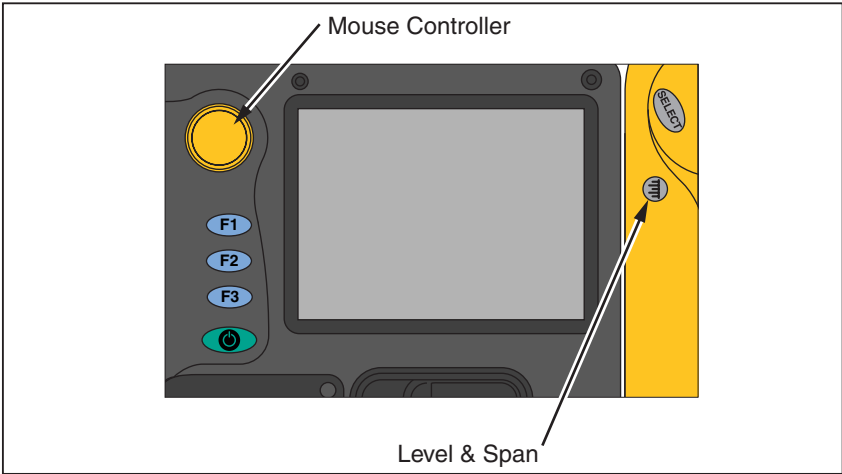

1. Press and hold  until the IR-Fusion® blend level dialog box appears on the display screen.
2. While continuing to press , use the mouse controller shown in Figure 1-7 to slide the IR-Fusion® blend level bar in the dialog box to the desired setting.
3. Tap the **trigger** button () to retain settings.



eii007.eps

Figure 1-7. Setting the IR-Fusion® Blend Level

Capturing an Image

1. Tap  once (shown in Figure 1-8) to pause the live image.
2. Review the image and camera settings.
3. Press and hold  for 2 seconds to capture (save) the image. The image file name appears in the upper left-hand corner of the display screen indicating the image is saved on the memory card.

Note

The memory card must be inserted into the camera to save and store images.

4. Tap  to return to scan target mode.

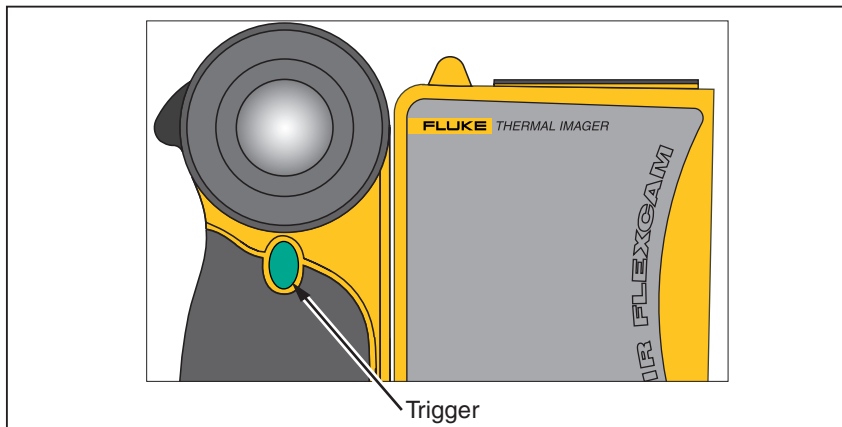

eii008.eps

Figure 1-8. Capturing an Image

SmartView Software for Your PC

Your system includes a CD containing SmartView® software that you install on your personal computer. SmartView, together with your Camera, enables you to:

- Transfer thermographic images to a computer and efficiently manage them
- Optimize and analyze your infrared and visible light control images
- Create and print detailed, professional reports containing important image data

SmartView image analysis software is compatible with any personal computer running Microsoft Windows 2000/XP/Vista (32 bit). This software is provided on the SmartView CD-ROM disk included with your camera.

To install SmartView software on your computer:

1. Start your computer and close any open applications.
2. Insert the CD-ROM disk containing the SmartView software in the CD-ROM drive.
If the SmartView CD does not start automatically, use Windows explorer to locate the file named "setup.exe" on the CD-ROM. Start the CD by double-clicking the **setup.exe** file.
3. Follow the on-screen instructions to complete the installation.

Chapter 2

Camera Overview

Introduction

Your Camera is a compact, lightweight system that offers a generous five-inch display module you can position for optimal viewing. You can also rotate the lens module to easily capture target images on ceilings, hidden above high objects, under low obstacles, or in other hard-to-reach places. In addition, you can position the camera for comfortable desktop image analysis and can mount the system on a standard tripod to continuously monitor a single location.

Although your Camera is a sophisticated imaging system with many advanced functions, it is easy to operate using buttons, mouse-controlled menu options, or a combination of both.

The visible light camera module (VLCM) adds a 1.3 mega pixel visible light sensor that improves your ability to identify and analyze thermal anomalies and to provide visible light control images for your reports.

Camera Parts

Camera features and controls are shown in Figures 2-1, 2-2, and 2-3 and described in Table 2-1.

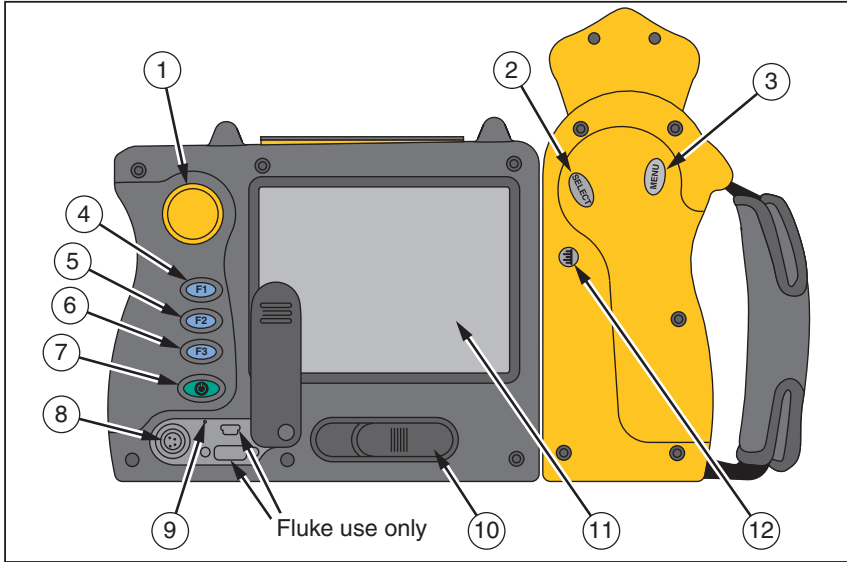

Figure 2-1. Camera Back View

eii009.eps

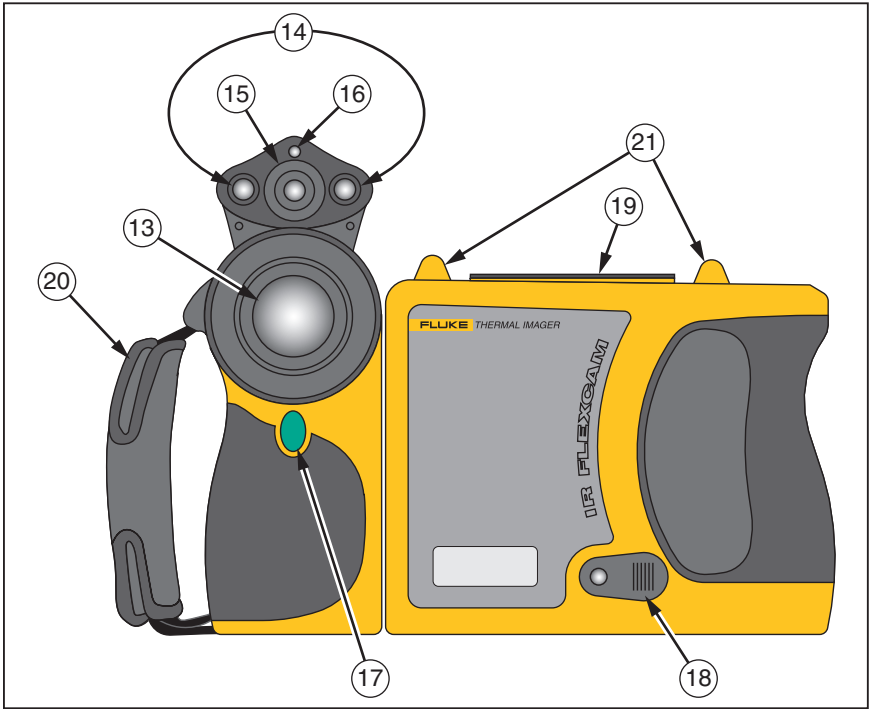

Figure 2-2. Camera Front and Top View

eii010.eps

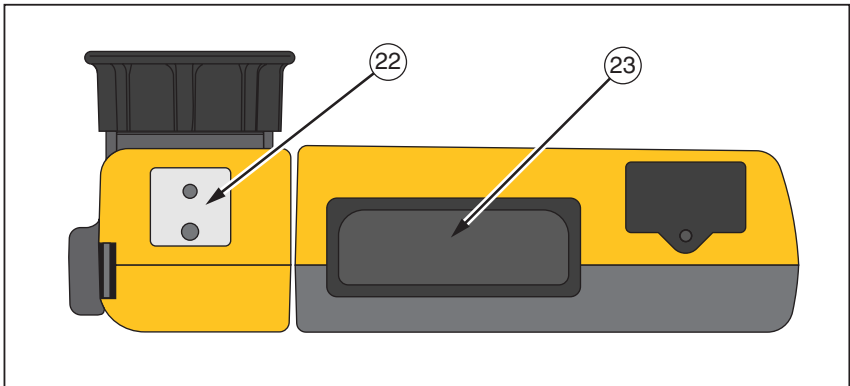

Figure 2-3. Camera Bottom View

eii011.eps

Table 2-1. Camera Parts – Descriptions









Item	Description
①	Mouse controller – Used to control the pointer position in images and text menus.
②	 select button – Performs mouse click, or “enter” function, for the pointer.
③	 Menu button – Used to access display screen menus. Note: Tap  once and a popup menu appears.
④	 Programmable function button – Can be programmed to perform different menu functions, see <i>Programming Function Buttons</i> later in this Chapter.
⑤	 Programmable function button – Can be programmed to perform different menu functions, see <i>Programming Function Buttons</i> later in this Chapter.
⑥	 Programmable function button – Can be programmed to perform different menu functions, see <i>Programming Function Buttons</i> later in this Chapter.
⑦	 Power on or off button – Used to power camera on and off and to place the camera in a low-power standby mode to conserve battery power. Solid green = power is on; Blinking green = standby mode enabled.
⑧	Auxiliary power port – Connection port for AC to DC power adapter.
⑨	Reset – Hidden switch to reset camera. Can be accessed with a paper clip. See, “Appendix B – Troubleshooting”.
⑩	Battery latch – Used to remove battery.
⑪	Liquid Crystal Display (LCD) screen – Sunlight-readable color display for viewing images and accessing camera menu functions.
⑫	 LEVEL & SPAN button – Used to rescale the color palette to the maximum and minimum temperatures in current image and to adjust IR IR-Fusion® level.
⑬	Infrared lens – Germanium lens with manual focus.

Table 2-1. Camera Parts--Descriptions (cont.)

Item	Description
⑭	Torch/Flash – When enabled, the torch illuminates darker work areas. When enabled, the flash lights the target object during image capture for better-quality visible light images. The torch and flash can be enabled at the same time.
⑮	Visible light lens – Captures visible light control images.
⑯	Laser – Used to point out the object you are aiming the camera towards.
⑰	 Trigger button – Used to pause and/or save an image frame. Also used to accept a setting change (i.e., OK click), close a menu page, and to return to scan target mode.
⑱	Video port – RCA video jack used to connect camera to a TV or video monitor.
⑲	CompactFlash memory card slot – Ejection button and slot for CompactFlash memory card.
⑳	Hand strap – Adjustable strap for added stability when capturing images.
㉑	Neck strap mount – Pins for attaching neck and/or shoulder strap.
㉒	Tripod mount – Standard 1/4-20 threaded hole for mounting camera on tripod.
㉓	Battery – Fluke 7-volt lithium-ion battery for primary power.

Camera Display Screen

Display screen features and controls are shown in Figures 2-4, 2-5, and 2-6 and described in Table 2-2.

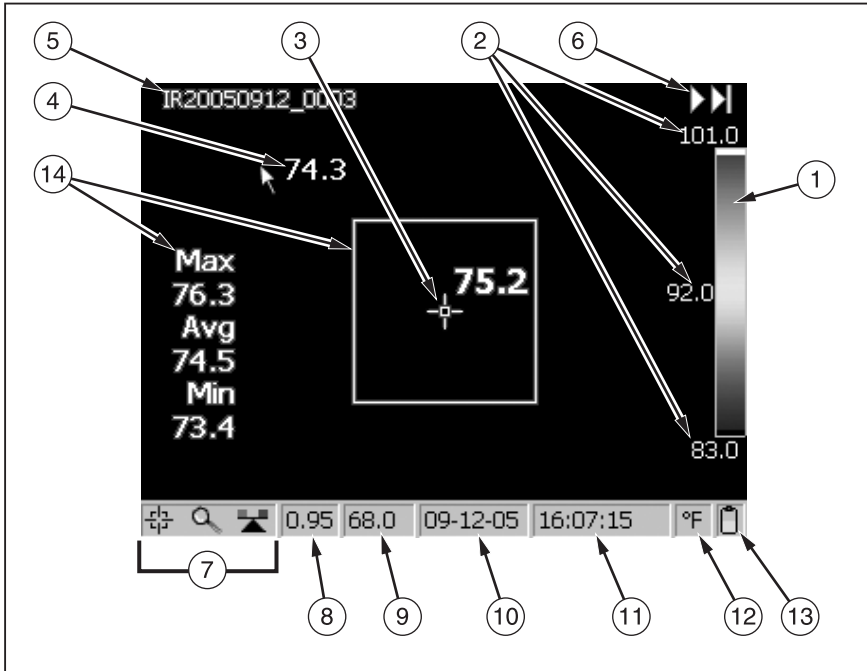

Figure 2-4. Camera Display Screen – Example 1

eii012.eps

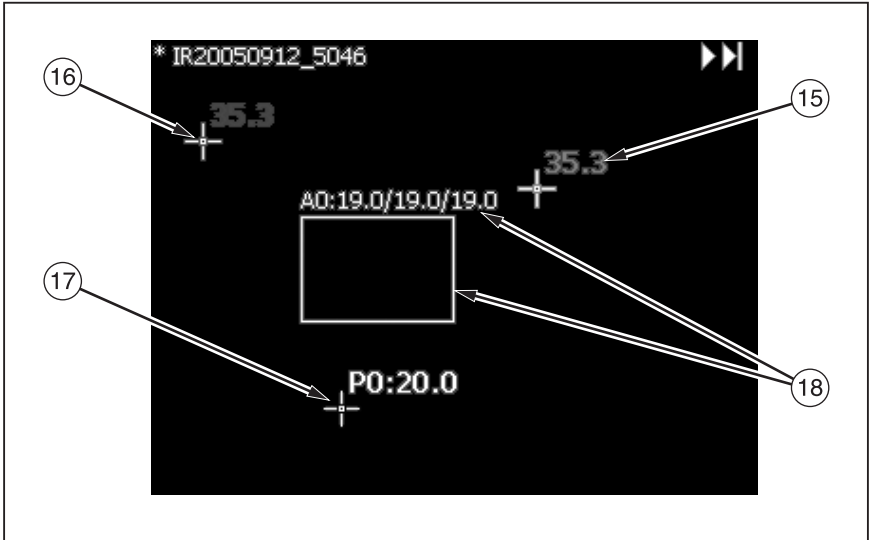

Figure 2-5. Camera Display Screen – Example 2

eii013.eps

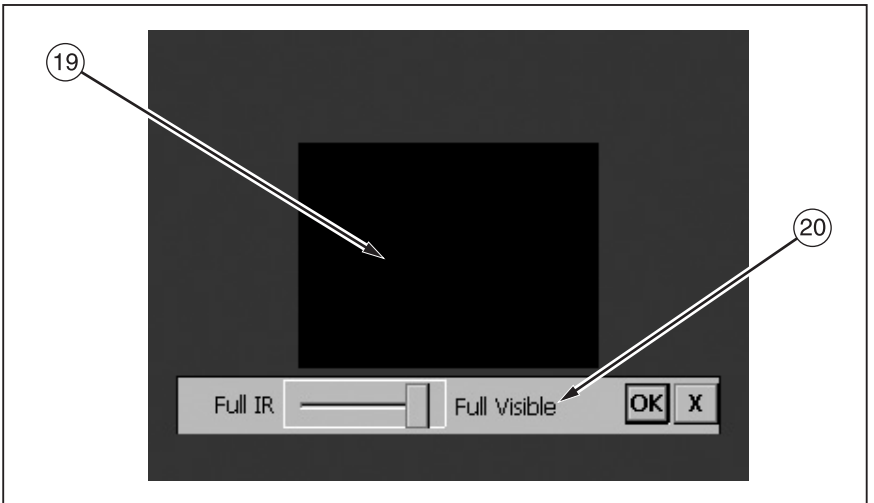

Figure 2-6. Camera Display Screen – Example 3

eii014.eps

Table 2-2. Display Screen – Descriptions

Item	Description
①	Color palette – Palette used in displayed image; click to change color palette options.
②	Level and Span – Maximum, center, and minimum temperatures of the color palette. Click temperatures to change limits of a fixed temperature range.
③	Center point temperature – Average temperature of the center-most group of four pixels.
④	Mouse pointer and temperature – Temperature at the location of the mouse pointer.
⑤	Image name – Image name created from an assignable prefix, the date image was taken, and a sequencing number. Appears only when viewing saved images.
⑥	Browse image arrows – Appear when Browse Image function is enabled. Click to scroll to the next or the previous image.
⑦	Programmable button icons – Icons for the three programmable buttons: (F1), (F2), and (F3). Click icon to change button function.
⑧	Emissivity —Used by camera to calculate target temperatures and location; click number to change the emissivity value.
⑨	Background temperature – Used by camera to calculate target temperatures and location; click number to change background temperature.
⑩	Date – Current date; click to change date.
⑪	Time – Current 24-hour time; click to change time.
⑫	Temperature units – Used to display camera temperature units; click to change the temperature units.
⑬	Power source – Icon indicating either AC power or battery level; click to identify remaining time available from current battery charge.

Table 2-2. Display Screen – Descriptions (cont.)

Item	Description
⑭	Center box with temperatures – Center 50 by 50 pixel box with the maximum, average, and minimum temperatures in the box (when enabled).
⑮	Hot cursor temperature – Temperature and location of the hottest temperature in the image; always in red (when enabled).
⑯	Cold cursor temperature – Temperature and location of the coldest temperature in the image; always in blue (when enabled).
⑰	Analysis point – Temperature of marker point in the image. You can add up to three marker points (when enabled).
⑱	Analysis area – Min., avg., and max. temperatures of the marker area in the image. You can add up to three marker areas (when enabled).
⑲	Picture-in-picture (PIP) – The fused, or blended, infrared/visible light image appears in the center quarter of the display screen and the visible light image appears in the rest of the display screen (when enabled).
⑳	IR-Fusion® blend level dialog box – Used to change the IR-Fusion® blend level from full infrared (IR) to full visible light (VL) or some combination in between. Disabled when using optional 10 and 54-mm lenses.

Programming Function Buttons

You can assign any of the functions described in Table 2-3 to any one of three programmable buttons: (F1), (F2), (F3) (see Appendix F for a list of default settings). See programming instructions on the next page.

Table 2-3. Programmable Functions















Item	Description
	Centerpoint/Centerbox – Used to cycle the centerpoint on, then centerpoint and centerbox on, then the centerpoint and centerbox both off.
	Zoom – Used to quickly cycle between 2x, 4x, 8x zoom, and normal display settings (zoom options vary by camera model; see Appendix D).
	Brightness – Used to quickly cycle through the display screen brightness settings: “Dim,” “Normal,” and “Bright.” Each time you press the function button, the next setting takes affect.
	Annotation – Used to quickly access the image annotation editor (available on TiR2, TiR4, Ti45 and Ti55 models only).
	Browse Images – Used to immediately recall the last saved or last viewed image.
	Browse Thumbnails – Used to quickly browse thumbnails of images stored on the CompactFlash memory card.
	Palette Visible – Used to quickly cycle the color palette bar on or off the display screen.
	Marker Toolbar Visible – Used to show or hide the marker toolbar for adding extra visible marker points or areas to the image and displaying temperatures near them.
	Torch – Used to quickly switch the LED light on or off. When on, light shines continuously to brighten up dark work areas; light automatically times out after 60 seconds.

Table 2-3. Programmable Functions (cont.)

Item	Description
	Laser – Used to help you correlate what is on the camera display screen with what you are looking at. The laser spot is visible in the control image and can be a valuable reference point for later image review.
	Start Sequence – Used to quickly start the Auto Capture sequence. (Auto Capture is available on TiR2, TiR4, Ti45 and Ti55 models only.)
	Stop Sequence – Used to quickly stop the Auto Capture image capture sequence. (Auto Capture is available on TiR2, TiR4, Ti45 and Ti55 models only.)
	Image Enhancement – Used to quickly cycle through the image enhancement settings: “Off,” “Normal,” “Medium,” and “High.” Each time you press the function button, the next setting takes affect.
	Picture-in-Picture – Used to quickly switch between full screen view and picture-in-picture view.
	Recalibrate – Used to manually trigger an internal calibration adjustment.

To program buttons **F1**, **F2**, and/or **F3**:

1. Use the mouse controller to position the pointer over the function icon on the display screen task bar (**F1**, **F2**, **F3**) you wish to program.
2. Tap **SELECT**. A popup menu with list of programmable tasks appears.
3. Position the pointer over the desired task and select.
4. Repeat Steps 1-3.



Using Display Screen Menus



Your camera is user-friendly and easy to operate and mirrors the way you use a personal computer. With a mouse controller and select button, you can select task bar items on the camera display screen and access and navigate through on-screen menus. In many cases, you can perform the same task either of two ways: by clicking on a display screen task bar item and/or opening a display screen menu to reveal additional options.

To select task bar items:

1. Use the mouse controller to position the pointer over the task bar item you wish to choose.
2. Tap  to select the desired item.
3. Follow the steps indicated in the section of this manual that corresponds to the selected task bar item.

To use the display screen menu options:

1. Tap . The first level popup menu appears:
 - Camera Info
 - Model Features (including refresh rate, features supported, languages)
 - Calibration Information (for example, lens type)
 - Revision (including OS build, DSP version, software version)
 - Camera Settings
 - Browse Images
 - Image Settings
 - Annotate Image
 - Start Sequence
 - Save Image
2. Use the mouse controller to position the pointer over the menu item you wish to choose.
3. Tap  to select the desired menu item.

4. Use the mouse controller and  to position the pointer and then select desired option from the tabs displayed.
5. Use the mouse controller and button to select the functions you want within the tab.
6. Tap  to accept setting change and return to scan target mode.

Inserting and Removing Memory Card

Your Camera comes with a removable, reusable CompactFlash memory card capable of storing hundreds of images. Inserting and removing a memory card is shown in Figure 2-7.

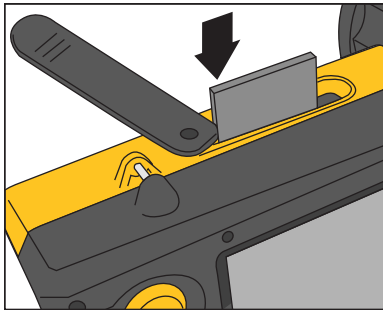

eii004.eps

Figure 2-7. Inserting and Removing a Memory Card

Note

The card must be inserted into the camera to save and store images. Use only SanDisk-brand CompactFlash memory cards with a 2003 or newer copyright date. Do not use other memory card brands.

⚠ Caution

To avoid loss of images in the event of a technical problem with either the Camera or the memory card, be sure to regularly transfer the images you save on the CompactFlash memory card to a computer hard drive and/or other back-up storage device (e.g., CD-R disc).

⚠ Caution

To avoid damaging the memory card or your camera, be sure to insert the card properly. The card can be inserted only one way; forcing it may damage your camera.

To insert a memory card:

1. Lift memory card slot cover.
2. Insert the SanDisk-brand CompactFlash memory card into the slot with the card's connection end pointed at the camera and the label with MB size facing the back of the camera.

Note

If the camera is powered on, the message, "Compact Flash Card inserted" is displayed.

To remove a memory card:

Note

Camera can be on or off when removing a memory card.

⚠ Caution

To prevent data loss or corruption, do not remove the memory card while saving an image.

1. Lift memory card slot cover.
2. Firmly press the memory card ejection button. The card partially slides out of the slot.
3. Remove the memory card from the slot and close the cover.

Chapter 3



Basic Operation

Acquiring and Reviewing Images



Your Camera has three operating modes: scan target, pause/save, and view/delete images.

Scan Target

To scan target area of interest:

1. Press  to power on the camera.
2. Remove lens cap and point the lens at the target area.
3. Focus and view the target area on the display screen.
4. Tap  to set the camera's temperature level and span; tap  again as needed to quickly bring the target area into view.
5. Move the camera or lens module as necessary to view various scenes.

Pause/Save Image

To pause and then save a target area image, follow the Scan Target procedure, then quickly tap the trigger () button. The word "Paused" appears in the upper left corner of the display, and the live target area image is paused enabling you to analyze the image and determine if it is acceptable enough to save. If not, quickly tap  again to return to scan target mode. If image is acceptable, you can save it for future reference.







To save an image for future reference, make sure CompactFlash memory card is inserted (see Chapter 2) and follow the procedures under Scan Target. When an area of interest is visible on the display screen, press and hold  until the hour glass is displayed (approximately 2-3 seconds). The image is now saved and stored on the CompactFlash memory card. See "Naming Image File"s in Chapter 6.

The image name is displayed in the upper left corner of the display screen.

Tap  to return to scan target mode.







View Saved Image

To view images saved on the memory card:





1. Make sure memory card is inserted (see Chapter 2), then tap .
2. Use the **mouse** controller to position the pointer over Browse Images on the popup menu and tap .
3. Position the pointer over the thumbnail view of the image you want to open, and double-click  to open.
If the image you want is not on the first page, position the pointer over the right/left arrows at the bottom of the display screen and tap  as many times as needed to scroll to the page you want, then follow Steps 3-4.
4. Tap  to close the open image and return to scan target mode.
5. Tap  to accept setting change and return to scan target mode.

Delete Saved Image

To delete images saved on the memory card one at a time:

1. Make sure memory card is inserted (see Chapter 2), then tap .
2. Use the mouse controller to position the pointer over Browse Images on the popup menu and tap .
3. Position the pointer over the thumbnail view of the image you want to delete; the image is highlighted. Tap .
4. Position the pointer over the Delete button at the bottom of the display screen, tap . A new dialog box appears; select **Yes** to delete the image, **No** to keep the image, or **Cancel** to cancel the operation and return to the thumbnail screen.
If the image you want to delete is not on the first page, position the pointer over the right/left arrows at the bottom of the display screen and tap  as many times as needed to scroll to the page you want, then follow Steps 3-5.
5. Tap  to close the thumbnail screen and return to scan target mode.





To delete all images saved on the memory card at the same time:

1. Tap .
2. Use the mouse controller to position the pointer over Camera Settings on the popup menu.
3. Tap .
4. Position the pointer over the Files tab and tap .
5. Position the pointer over Delete all images and tap .
6. Select Yes (if you do not want to delete all images, select No or Cancel).
7. Tap  to return to scan target mode.

Electronic Zoom

From normal view, you can zoom to up to 8x (depending on the camera model; see camera specifications in Appendix D), which correspondingly enlarges the image.









To activate the electronic zoom feature:

1. Tap .
2. Use the mouse controller to position the pointer over Image Settings in the popup menu and tap .
3. Position the pointer over the Display tab and tap .
4. Position the pointer over the Zoom Image up/down arrows and tap  as needed to select zoom setting.

Saved Image Information

Opening the Info tab within the Image Settings menu window enables you to view a variety of information about a saved image, including: the name of the camera manufacturer, camera model number, lens focal length and f-number, lens model and serial number, and camera calibration date of the camera used to capture the image. This window/tab also contains the capture date and time for the selected saved image, as well as software versions used to manage the camera operation (OCA) and to perform image data processing (DSP).

To view a saved image's information:

1. Make sure memory card is inserted (see Chapter 2), then tap .
2. Use the mouse controller to position the pointer over **Browse Images** on the popup menu and tap .
3. Position the pointer over the thumbnail view of the image you want to open and double-click  to open.
If the image you want is not on the first page, position the pointer over the right/left arrows at the bottom of the display screen and tap  as many times as needed to scroll to the page you want, then follow Steps 3-7.
4. On the open image, tap .
5. Use the mouse controller to position the pointer over Image Settings on the popup menu and tap .
6. Position the pointer over the **Info** tab and tap .
7. Tap  to return to scan target mode.

Chapter 4



Analyzing and Enhancing Images

Setting Emissivity and Background Temperature



Setting your camera with correct emissivity and background temperature values is critical to making accurate temperature measurements.

Emissivity values on your camera and saved images are adjustable between 0.01 and 1.00 with increments of 0.01. This value, along with the background temperature and target radiation measured by the camera, is used to calculate target temperatures. Use the table in Appendix C, which lists the emissivity values of some common materials, as a guide to setting correct emissivity values.

To set the emissivity value for an image in the camera:

1. Use the mouse controller to position the pointer over the emissivity value on the task bar and tap . (See Chapter 2 for emissivity value location on the task bar.)
2. Use the up/down mouse action to raise or lower the value.
3. Tap  to accept setting change and return to the open image.
4. Tap  again to return to scan target mode.





To set the background temperature for an image in the camera:

1. Use the mouse controller to position the pointer over the background temperature value on the task bar and tap . (See Chapter 2 for background temperature value location on the task bar.)
2. Navigate up/down using the mouse controller to raise or lower the value.
3. Tap  button to accept setting change and return to the open image.
4. Tap  again to return to scan target mode.

Fixed Image Function

You can also set the emissivity and background temperature values by opening the Image Settings menu and clicking the Emissivity tab. From here, you can enable or disable the Fixed Image function. When this function is enabled, the palette minimum and maximum are adjusted as you change the emissivity, and the image appearance remains the same. When this mode is disabled, the palette minimum and maximum stay fixed, while the color rendering in the image changes accordingly.

To enable/disable the Fixed Image function:

1. Tap .
2. Use the mouse controller to position the pointer over **Image Settings** on the popup menu and tap .
3. Position the pointer over the **Emissivity** tab and tap .
4. Position the pointer over the **Fixed Image** box; tap  to add or remove a check mark. A check mark indicates the function is enabled.
5. Tap  to accept setting change and return to scan target mode.



Changing Color Palettes



Although all of your camera's color palettes can be used with any image, you may find that some color palettes work better than others for analyzing images depending on the situation.

You can change the color palette prior to capturing images and can change the color palette of images already saved on the memory card.

Two methods are available to change the color palette. Use the MOUSE controller to position the pointer over the color palette on the display screen and repeatedly press  to cycle through the 8 color palette options.

Or, use the menu system as follows:

1. Tap .
2. Use the mouse controller to position the pointer over Image Settings on the popup menu and tap .
3. Position the pointer over the **Palette** tab and tap .

4. Position the pointer over the **Palette** down arrow and tap  to reveal the pull down menu.
5. Position the pointer over desired color palette option and tap .
6. Tap  to accept setting change and return to scan target mode.

Setting Temperature Level and Span

The color palette is available to help you visualize the relation between temperature and color. Setting the span to the narrowest range possible provides the highest quality images.

When using the manual or automatic level and span function, if the center box function is enabled, the temperature updates are done based on the temperatures in the box, not the entire image. Using this feature, you can exclude an area in the image that is very hot or very cold but of little interest.

Manual Level and Span

When you press the LEVEL & SPAN button, your camera takes the current coldest and hottest temperatures from the scene and sets the palette range minimum and maximum limits so that everything in the scene is scaled between the minimum and maximum temperature if the target temperatures are within the camera's currently selected calibration temperature range. If the target temperatures are outside the currently selected calibration temperature range, the target is displayed in the saturation color for the current color palette (see *Using Palette Saturation Colors* later in this chapter).

Note







Be sure the temperature calibration range is set properly. See Setting the Temperature Calibration Range in Chapter 6). If you have enabled the center box marker (see Chapter 4), the color palette is adjusted based on the minimum and maximum temperatures in the center box, not those in the rest of the image.

To manually adjust the color palette temperature span, tap  as needed. Be sure the "Manual" function is enabled (refer to the procedure under *Automatic Level and Span*).

Automatic Level and Span

When you enable the automatic level and span function, the color palette temperatures are regularly updated to the current maximum and minimum temperatures in the image at a time interval you set (from 1/4 second to 10 seconds).

To enable automatic adjustments of the color palette temperature span:

1. Tap .
2. Use the mouse controller to position the pointer over Image Settings on the popup menu and tap .
3. Position the pointer over the **Palette** tab and tap .
4. Position the pointer over the **Adjustment Interval** down arrow, tap .
5. Use the mouse controller to scroll to the interval you want, and tap . Select **Manual**, rather than an interval, to enable the Manual function.
6. Tap  to accept setting change and return to scan target mode.

Arbitrary Fixed Temperature Level and Span

This feature allows you to adjust the level and span “on the fly,” while scanning targets of special interest and creating high contrast in the temperature ranges of those targets.

Note

Be sure the temperature calibration range is set properly. See “Setting the Temperature Calibration Range” in Chapter 6. If you have enabled the center box marker (see Chapter 4), the color palette is adjusted based on the minimum and maximum temperatures in the center box, not those in the rest of the image.







To set the level and span to an arbitrary fixed temperature span:

1. With the color palette showing on the display screen, highlight any one of the three palette temperature values (minimum, maximum, center point).
 - If you highlight the minimum or maximum temperature, use the up/down mouse action to change palette range (span). The center point (level) temperature also changes accordingly.

- If you highlight the center point (level) temperature, use the up/down mouse action to move the center point temperature accordingly, while keeping the range (span) constant. Use the left/right mouse action to change the palette range (span), leaving the center point (level) unchanged.
2. Tap  button to select to accept setting change and return to scan target mode.

You can also the level and span by using the menu system.

To set the level and span using the menu system

1. Tap .
2. Use the mouse controller to position the pointer over Image Settings on the popup menu and tap .
3. Position the pointer over the Palette tab and tap .
4. Position the pointer over the Adjustment Interval down arrow and tap .
5. Use the mouse controller to scroll to “Manual” and tap .
6. Position the pointer over either:
 - The Palette Range maximum temperature right/left arrows (repeat to change minimum temperature).
 - or
 - The Palette Range center point temperature (repeat to change the span width temperature).
7. Use the mouse controller to scroll to the temperature settings you want.
8. Tap  to select to accept setting change and return to scan target mode.

Using Palette Saturation Colors

The palette colors of your Camera are mapped to temperature measurements. When you set the color palette level and span, the full color range is used to display the image. This same temperature color mapping is maintained until you set the level and span again.

After setting the level and span, if the camera measures a temperature greater than the palette maximum temperature and/or a temperature lower than the palette minimum temperature, the image pixels with these temperature

extremes are displayed at the ends of the color palette. These pixels are called saturation colors. The standard saturation colors, described in Table 4-1, appear on the ends of the color palette bar and enable you to quickly see when temperatures are outside of the current range.







Table 4-1. Standard Saturation Colors

Color Palette	Standard High Temperature Saturation Color	Standard Low Temperature Saturation Color
Grayscale	Red	Blue
Grayscale Inverted	Red	Blue
Blue-red	White	Black
High-contrast	Blue-green	Dark Brown
Hot Metal	White	Black
Ironbow	Green	Tan
Amber	Red	Blue
Amber Inverted	Red	Blue

Note

With saturation colors OFF, the temperature extremes are displayed using the next-to-extreme colors in each palette.

To change, enable, or disable the saturation colors function:

1. Tap .
2. Use the mouse controller to position the pointer over Image Settings on the popup menu and tap .
3. Position the pointer over the Palette tab and tap .
4. Position the pointer over the Saturation Colors down arrow, then tap .
5. Use the mouse controller to scroll to the setting you want (Off, Standard, White/Black, Red/Blue), and tap .
6. Tap  to accept setting change and return to scan target mode.

Using Display Screen Temperature Markers

You can annotate images with various types of markers to help you interpret or analyze images. For example, you can highlight particular areas of interest in an image or highlight critical objects whose minimum, maximum, or average temperatures must be in a particular range.

Use the following basic marker options:

- Four standard spot temperatures: hot, cold, and center points each marked with a crosshair and the mouse pointer location, marked by the tip of the pointer.
- Maximum, minimum, and average temperatures for the center box.

You can enable these markers to appear on the display screen in scan target mode and/or on a saved image you open. With the mouse pointer marker enabled, you can move the pointer around the display screen to reveal the spot temperatures at any place on the image.

Note



To add advanced markers, see Chapter 7, User-Defined Temperature Markers.



Movable points and boxes and automatic hot and cold point detection functions are available on TiR2, TiR4, Ti45 and Ti55 models only.

The pointer may change orientation as it approaches the edge of the display screen.



“Unchecking” the mouse temperature removes the pointer temperature digits only; the pointer itself still appears on the display screen.

To enable/disable spot temperature marker functions from either scan target mode or from an open image:



1. Tap .
2. Use the mouse controller to position the pointer over **Image Settings** on the popup menu and tap .
3. Position the pointer over the **Display** tab and tap .

4. Position pointer over one of the temperatures you want to appear in the image (Center Point, Center Box, Hot Cursor, Cold Cursor) and tap . A check mark indicates the function is enabled.
5. Repeat Step 4 as needed to choose additional temperature reading options and/or to “uncheck” options you do not want to appear on the image. In scan target mode, you can also select Onscreen Logo. A check mark indicates the Fluke logo will appear on the display screen in scan target mode.
6. Tap  to accept setting change and return to scan target mode or to the open image. From an open image, tap  again to return to scan target mode.



To cycle the center point and center box temperature readings on and off from either scan target mode or from an open image:

1. Enable Center Point/Center Box functions following the procedures to enable/disable spot temperature markers under “Using Display Screen Temperature Markers”.
2. Assign the Center Point/Center Box function to a programmable button (see Chapter 2).
3. Tap , , or  as needed to cycle Center Point on, then Center Point and Center Box on, then Center Point and Center Box both off.

To hide or rename the Center Point, Center Box, and/or Hot or Cold cursors from either scan target mode or from an open image:

1. Use the mouse controller to position the mouse pointer over the desired marker; tap .
2. Tap ; a pop up menu appears. Use the mouse controller to position the pointer over the desired option: **Hide** or **Rename**.
 - If you select hide, the marker is hidden from the display screen.
 - If you select rename, the Edit Marker Name keyboard appears.

Enter a new marker name using the mouse controller to position the pointer over the appropriate letter and/or function, then press . Repeat as needed.

3. Tap  to accept the setting change and return to scan image mode or to an open image. From an open image, tap  again to return to scan target mode.

Annotations

Note

This feature is available on TiR2, TiR4, Ti45 and Ti55 models only.





Adding Annotations to Saved Images

Your Camera enables you to add notes, or annotations, to your infrared images. An annotations file named “notations.txt” is located in the camera memory. If you store an annotations file on the memory card, your camera recognizes the annotations file on the memory card first. The “notations.txt” file contains a predefined list of available annotations and annotation categories.



An annotation is a textual description that can be attached to an image. You can use annotations to store extra information with an image such as where the image was captured, what equipment is represented in the image, and who captured the image. All annotations must be a member of an annotation category. An annotation category is a grouping of similar annotations. For example, the annotation category “Equipment” may contain the annotation items “Fuse,” “Breaker,” and “Disconnect.”

When you insert the memory card into your Camera, the annotation file tells it what annotations can be applied to an image captured with the camera. You can add the categories and annotations to saved images.











To add an annotation to a saved image:



1. Tap .
2. Use the mouse controller to position the pointer over Browse Images on the popup menu.
3. Tap  to select and open image thumbnails.
4. Position the pointer over the right or left arrow key to scroll to the page containing the image you want to annotate; position pointer over the image and double click  to open.
5. In the open image, tap , then select **Annotate Image** from the popup menu.
6. Position the pointer over the annotation category you want to select on the left side of the annotation editor window and tap . The available

annotation items for the selected category appear on the right side of the annotation editor window.

7. Position the pointer over the box next to the annotation item you want to select and tap . Repeat as needed to select additional annotation items.
8. Repeat Steps 6-7 as needed to select additional annotation categories.
9. Tap  to accept setting change and return to the open image. An annotation icon appears in the upper part of the image.
10. Tap  once more to return to scan target mode.

To delete, change, or add a new annotation category to a saved image:









1. Open the image you want, then tap  and select **Annotate Image** from the popup menu.
2. Position the pointer over the annotation category you want to change or delete on the left side of the annotation editor window and tap .
3. Tap .
 - To delete, position the pointer over **Delete Category**, then tap . The category is deleted.
 - To change, position the pointer over **Change Category Name**, then tap . A keyboard window opens.
 - Position the pointer over the current category name and double click  to highlight the name. Click “Del” on the keyboard to delete.
 - Enter the new name by positioning the pointer over the appropriate letter, then tapping . Repeat as needed.
 - Tap  to accept setting change and return to the annotation editor.
 - To add a new category, position the pointer over either the **New Single-Select Category** or **New Multi-Select Category**, then tap . A keyboard window opens.
 - Enter the new category name by positioning the pointer over the appropriate letter, then tapping . Repeat as needed.
 - Tap  to accept setting change and return to the annotation editor. The new name appears on the left side.

4. Tap  to return to the open image; tap  again to return to scan target mode.





To add a new annotation item to a saved image:

Note

Multi-Select annotations (meaning you may select more than one at a time) have a check box next to the item name; single-select annotations (meaning you may select only one at a time) have a radio button (circle) next to the item name.

1. Open the image you want, then tap  and select **Annotate Image** from the popup menu.
2. Position the pointer over the annotation category to which you want to add the new item and tap .
3. Position the pointer on the right side of the annotation editor and tap .
4. Position the pointer over **Add New Item**, then tap . A keyboard window opens.
5. Enter the new annotation item by positioning the pointer over the appropriate letter, then tapping . Repeat as needed.
6. Tap  to accept setting change and return to the annotation editor..
7. Repeat Steps 3-6 as needed to select additional annotation items for the selected category.
8. Tap  to accept setting change and return to the open image.
9. Tap  once more to return to scan target mode.

To set the annotation function to start automatically when saving a new image:

1. Tap .
2. Use the mouse controller to position the pointer over **Camera Settings** on the popup menu.
3. Position the pointer over the **Files** tab and tap .
4. Position the pointer over the “**Auto-Start Notation Wizard When Saving New Image**” box and tap . A check mark appears in the box indicating the feature is enabled.
5. Tap  to accept setting change and return to scan target mode.

Creating Annotations Lists in SmartView







In addition to managing your annotations using the annotation editor in the camera, you can change the predefined list and create your own annotations categories and items using the SmartView annotations editor (see the SmartView software CD that came with your Camera). After you install the SmartView software onto your computer (see Chapter 1), refer to the software's online Help menu for instructions on how to create and/or edit annotations lists.

Chapter 5

Visible Light Camera Module (VLCM)

Enabling/Disabling Visible Light Camera Module

To enable/disable the visible light camera module:

1. Tap .
2. Use the mouse controller to position the pointer over Camera Settings on the popup menu and tap .
3. Position the pointer over the **VLCM** tab and tap .
You may need to position the pointer over the right or left arrow and tap  to scroll to the **VLCM** tab.
4. Position the pointer over the **Enable Visible Light Camera** box; tap  to add or remove a check mark. A check mark indicates the function is enabled.
5. Tap  to accept setting change and return to scan target mode.

Using Image Alignment

Image alignment is an automatic adjustment that occurs as you focus the infrared camera lens. This feature is only available with the 20-mm lens. The visible light image and the infrared image are lined up based on the focusing distance of the infrared lens so that they may be combined for viewing and analysis. The visible light image and the infrared image are lined up for distances greater than 50 cm (approximately 2 ft).

Image alignment is disabled when using the optional 10 and 54-mm lenses. To ensure proper image alignment with the standard 20-mm lens, the lens must be aligned correctly when you install it on the camera. Correct alignment is achieved by installing the lens such that the white alignment marking on the lens lines up with the corresponding mark on the camera housing as shown in Figure 5-1.

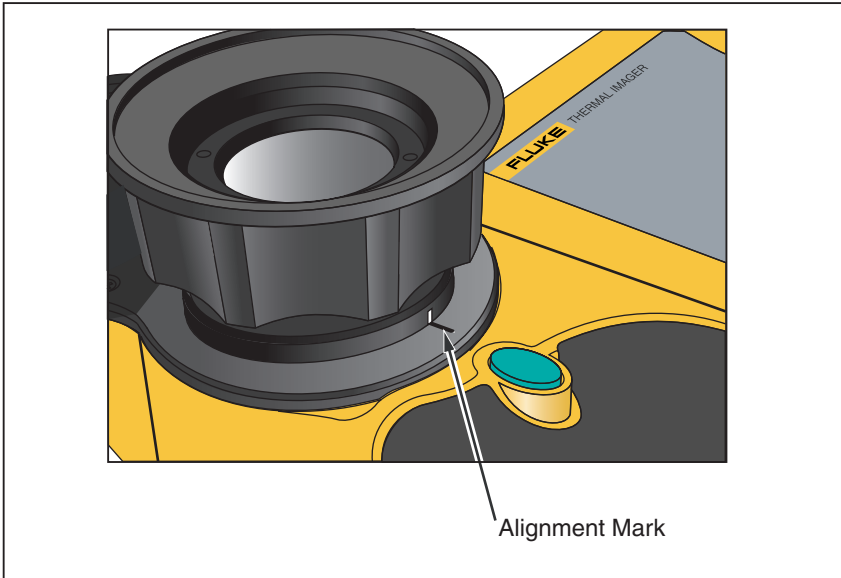

Figure 5-1. Aligning the 20-mm Lens

eil021.eps

Focusing

Prior to capturing images using the visible light module and IR-Fusion®, it is important to make sure the target object is in focus. As you rotate the infrared (IR) lens to focus the camera, if the IR blend is less than 50%, the IR-Fusion® blend level changes to 50% infrared and 50% visible light (VL). Once you have the target object in focus and stop rotating the IR lens, the IR-Fusion® level returns to your setting. You can focus the infrared portion of the image only; the focus of the VL portion is set at the factory.

To focus the camera, remove the IR lens cap, point the lens at the target, and manually rotate the infrared lens with your finger. Focus by aligning the edges of the IR and VL images.





Adjusting IR-VL IR-Fusion® Blend Level

Note







This feature is disabled with optional 10 and 54-mm lenses.

You can change the IR-Fusion® blend level from full infrared (IR) to full visible light (VL) or some combination in between. When the IR-Fusion® blend level is set to full IR, 100% of the image is IR. When the IR-Fusion® blend level is set to full VL, 100% of the image is VL. When the IR-Fusion® blend level is set somewhere in the middle of full IR and full VL, an appropriate amount of the image is IR and an appropriate amount is VL, thus displaying a fused—or blended—image.

To adjust the IR-VL Fusion blend level using the level & span button and mouse controller:

1. Press and hold  until the IR-Fusion® level dialog box appears near the bottom of the screen.
2. While continuing to hold , move the mouse controller left or right to desired setting, or use  to position the pointer over the Full IR or Full VL text to quickly move to 100% infrared or 100% visible light respectively.
3. Tap  to accept setting change and return to scan target mode.

To adjust the IR-VL IR-Fusion® blend level from the popup menu:

1. Tap .
2. Use the mouse controller to position the pointer over **Camera Settings** in the popup menu and tap .
3. Position the pointer over the **VLCM** tab and tap .
You may need to position the pointer over the right or left arrow on the tab bar and tap  to scroll to the VLCM tab.
4. Position the pointer over the **Full IR/Full Visible** bar; press and hold  and then move the mouse controller left or right to desired setting.
5. Tap  to accept setting change and return to scan target mode.



Using Full Screen or Picture-in-Picture View



In the full screen view, the infrared (IR) target object image takes up the entire display screen using the IR-Fusion® blend setting you have selected. For example, if the IR-Fusion® blend setting is Full IR, then the infrared image is displayed. If the IR-Fusion® blend setting is Full Visible, then the visible light (VL) image is displayed. If the IR-Fusion® blend setting is somewhere in between, this image blend is displayed. Temperature values are available on all areas of the display screen. The centerpoint, centerbox, and hot and cold points are available in full screen view, and user-defined point and box markers are fully editable in this view.

In the picture-in-picture view, the fused, or blended, infrared/visible light image appears in a rectangle in the center quarter of the display screen. The visible light image appears in the rest of the display screen. The centerpoint, centerbox, and hot and cold points are available in the picture-in-picture view. User-defined point and box markers are fully editable in this view.

Temperature readings are available only within the infrared image area. The visible light image field of view is larger than the infrared field of view, thus enabling the infrared picture to fit inside the visible light picture (picture-in-picture).

To choose full screen or picture-in-picture view:







1. Tap .
2. Use the mouse controller to position the pointer over **Camera Settings** on the popup menu and tap .
3. Position the pointer over either the **Full Screen** or Picture-in-Picture radio button as desired.
4. Tap  to accept setting change and return to scan target mode.

Or, assign the Picture-in-Picture function to a programmable button (see Chapter 2). Then, to cycle between full screen and picture-in-picture views, tap , , or  as needed.

Adjusting Brightness and Color Controls

Use the brightness and color controls to adjust the visible light image according to your personal preference.

To enable high brightness and/or vivid color:



1. Tap .
2. Use the mouse controller to position the pointer over Camera Settings on the popup menu and tap .
3. Position the pointer over the **VLCM** tab and tap .
You may need to position the pointer over the right or left arrow and tap  to scroll to the **VLCM** tab.
4. Position the pointer over the **High Brightness** box; tap  to add or remove a check mark. A check mark indicates the function is enabled.
5. Position the pointer over the **Vivid Color** box; tap  to add or remove a check mark. A check mark indicates the function is enabled.
6. Tap  to accept setting change and return to scan target mode.

Using Torch Control

When working in darker areas, you can enable the torch function to provide better lighting. If the flash is not enabled, but the torch function is, the torch remains on during image capture. The torch operates at approximately 50% power continuously; the flash operates at full power the instant the image is captured.

Note

The torch can be enabled at the same time the flash is enabled. If both functions are enabled, the torch operates continuously, while the flash comes on during the image capture. The torch enabled function times out after 60 seconds. Limit torch use to save battery power.

Assign the Torch function to a programmable button (see Chapter 2). Then, to cycle between torch on and torch off, tap , , or  as needed.







Using Visible Light Flash

When working in darker areas, you can enable the flash function to light the target object and capture better-quality visible light images. When the flash is enabled, it operates with one burst of light when an image is captured (the moment the image is paused).

Note

The flash can be enabled at the same time the torch is enabled. If both functions are enabled, the torch operates continuously, while the flash comes on during the image capture. The torch function times out after 60 seconds, and it can also be turned off by pressing the assigned function button again. The flash does not time out.

To enable the flash:

1. Tap .
2. Use the mouse controller to position the pointer over **Camera Settings** on the popup menu and tap .
3. Position the pointer over the **VLCM** tab and tap . You may need to position the pointer over the right or left arrow and tap  to scroll to the **VLCM** tab.
4. Position the pointer over the **Flash Enabled** box; tap  to add or remove a check mark. A check mark indicates the function is enabled.
5. Tap  to accept setting change and return to scan target mode.

Recording Visible Light Images







With the visible light camera module, you can simultaneously save both an infrared image and the corresponding visible light control image. However, you may not want to save the visible light image along with every infrared image you capture; a visible light image captured with the infrared image takes up much more space on the CompactFlash memory card. You can enable or disable the record control image function as needed.

With this function enabled, both the visible light and the infrared images are captured. You can view the images using the Full IR or Full Visible settings or blended in between. With the record control image function disabled, only the infrared image is saved.

Note

The setting to either record or not record control images is governed by the setting to enable or disable the visible light camera module (VLCM). The VLCM must be enabled to capture a visible light control image; see Enabling/Disabling Visible Light Camera Module earlier in this Chapter).

To enable the record control image function:



1. Tap .
2. Use the mouse controller to position the pointer over Camera Settings on the popup menu and tap .
3. Position the pointer over the **VLCM** tab and tap . You may need to position the pointer over the right or left arrow and tap  to scroll to the **VLCM** tab.
4. Position the pointer over the **Enable Visible Light Camera** box; tap  to add or remove a check mark. A check mark indicates the function is enabled.
5. Tap  to accept setting change and return to scan target mode.

Using Laser Pointer

Warning

 **To avoid injury, use your camera's Class 2 laser pointer only as instructed.**

Use the laser function to help you point out the object you are aiming the camera towards. For example, use the laser to show a colleague where a problem is physically located. Using appropriate IR-Fusion® blend levels and color palette settings allows the red laser dot to be in the visible light image only.

Assign the Laser function to a programmable button (see Chapter 2). Then, press and hold , , or  to use the laser; release when finished. An icon appears on the display screen to indicate the laser is activated.

Using Thumbnail Browser

Assign the Thumbnail Browser function to a programmable button (see Chapter 2).

Use the radio buttons on the thumbnail browser window to switch between IR-only, fused, and VL-only image thumbnail displays. Selecting one of these views does not change the image file; fused images are rendered according to the blend level setting for each image file.

Using Color Alarms

Note

This feature is not available on the TiR3 or Ti50.

The color alarm function allows you to highlight target object areas of thermal interest by selectively fusing the visible light image with portions of the infrared image. For example, you can specify a temperature range. Then, any target object temperatures either inside or outside of the range, depending on what you set, are highlighted in the infrared color that corresponds to that temperature (based on the color palette settings).

You can choose to highlight temperatures either inside or outside of the range specified. You can also choose to highlight only temperatures above or below a threshold setting.





Color alarm thresholds and range limits can be adjusted using the display screen menu.



Note

Color alarms work in both full screen and picture-in-picture view. With the onscreen alarm disabled, the entire infrared image is blended with the visible light image according to the IR-Fusion® blend setting and palette selection. The IR-Fusion® blend setting should include some IR (i.e., not full VL) so that the color alarm is visible on the display screen, provided objects in the scene meet the color alarm criteria.



Using Menu to Adjust Color Alarm Ranges

To enable/disable onscreen alarm:





1. Tap .
2. Use the mouse controller to position the pointer over Image Settings on the popup menu and tap .
3. Position the pointer over the **Color Alarms** tab and tap . You may need to position the pointer over the right or left arrow and tap  to scroll to the Color Alarms tab.

4. Position the pointer over the **Enable Onscreen Alarm** box; tap  to add or remove a check mark. A check mark indicates the function is enabled.
5. Tap  to accept setting change and return to scan target mode.

To set color alarms for temperatures either inside or outside of the specified temperature range:

6. Follow steps 1-4.
7. Position the pointer over the “Temperatures Are Inside Specified Range” checkbox; tap . A check mark indicates that temperatures within the range will be used.
8. If you have selected “Alarm Outside Range,” position the pointer over the Max or Min box as desired; tap  to add or remove a check mark. A check mark indicates the function is enabled.
If you selected “Temperatures are Inside Specified Range,” you cannot change the Max or Min check boxes.
9. Continue to Step 10 to set the alarm temperature range, or go to Step 12 if finished.



To set color alarm temperature range (maximum and minimum temperatures):

10. Follow steps 1-4.
11. You can increase or decrease values rapidly to get near the value you want:
 - Position the pointer over either the **Max** or **Min** temperature value; tap ; the box becomes highlighted. Use the mouse controller up/down action to quickly adjust the value in large increments. Tap  again to enter the selected value.
 - Increase or decrease values slowly one digit at a time to hit the exact value you want, position the mouse pointer over the value’s corresponding right/left arrows, then tap  as needed until you reach value you want.
12. Tap  to accept setting change and return to scan target mode.

Using Palette Bar to Adjust Color Alarm Ranges

If you have enabled color alarms, the color alarm temperature limits are indicated next to the color palette on the display screen.

To adjust the color alarm temperature limits from the color palette:

1. Position the pointer over the color alarm temperature limit you want to change, then tap  to highlight the value.
2. Use the mouse controller up/down action to change the value.
3. When you reach the desired temperature, tap  to accept setting change and return to scan target mode.

Chapter 6

Camera Setup





Adjusting Display Screen Brightness

You can adjust the display screen brightness for better viewing options in various lighting conditions.

Note

For maximum battery life, use the dimmest setting possible that still enables you to clearly see the display screen images.

To adjust the display screen brightness and high brightness timeout time:





1. Tap .
2. Use the mouse controller to position the pointer over **Camera Settings** on the popup menu and tap .
3. Position the pointer over the **Power** tab and tap .
4. Position the pointer over the Display Brightness down arrow and select. Then position the pointer over the desired brightness level from the pull down menu and select.
5. If you select “bright,” you can also select a “high brightness timeout” time: Position the pointer over the **High Brightness Timeout** down arrow and select the time you wish.
6. Tap  to accept setting change and return to scan target mode.

You can also assign the Brightness function to a programmable button (see Chapter 2). Then, tap the programmable button as needed to adjust the display screen brightness.

Hiding Display Screen Task Bar

For more image viewing area, you can hide the display screen task bar. Specifically, you can set the task bar to automatically disappear within 3 seconds when the mouse pointer is moved off the bottom row of the camera display screen or if the pointer remains stationary on the task bar (above the bottom row) for 4 seconds.

To enable the Auto-Hide Task Bar function:

1. Tap .
2. Use the mouse controller to position the pointer over **Image Settings** on the popup menu.
3. Tap .
4. Position the pointer over the **Display** tab and tap .
5. Position the pointer over the **Auto-Hide Task Bar** box and tap . A check mark indicates function is enabled.
6. Tap  to accept setting change and return to scan target mode.



To make the task bar reappear while the Auto-Hide function is enabled, use the mouse controller to position the pointer on the bottom row of the display screen. As long as the pointer remains on the bottom row of the display screen, the task bar stays on, even if the Auto-Hide Task Bar function is enabled.



To hide the task bar while the Auto-Hide function is enabled, use the mouse controller to move the pointer off the bottom row of the camera display screen.

Hiding Display Screen Color Palette

For more image viewing area, you can hide the display screen color palette.

To hide the color palette:

1. Tap .
2. Use the mouse controller to position the pointer over **Image Settings** on the popup menu.
3. Tap .
4. Position the pointer over the **Display** tab and tap .

5. Position the pointer over the **Temperature Scale** box and tap . A check mark indicates function is enabled.
6. Tap  to accept setting change and return to scan target mode.

Setting Temperature Units

To set or change temperature units to Celsius, Fahrenheit, or Kelvin:

1. Use the mouse controller to position the pointer over the temperature unit mark (°F, °K, °C) on the task bar and tap .
2. Repeat until the desired unit is selected.





Setting Temperature Calibration Range

You can change the temperature calibration range as needed: the narrower the range the better the image quality, which enables you to see smaller temperature variances. The wider the range the lower the image quality; however, you are able to see a greater range of temperature variances.

To set the temperature calibration range:

Note

Calibration range cannot be changed on a paused or saved image. Be sure to select the correct calibration range prior to pausing or saving an image. See Appendix D to determine the calibrated temperature ranges available for your camera model.





1. Tap .
2. Use the mouse controller to position the pointer over **Camera Settings** on the popup menu and tap .
3. Position the pointer over the **Lens** tab and tap .
4. Position the pointer over the calibration range radio button you want and tap .
5. Tap  to accept setting change and return to scan target mode.

Changing Lens Selection

To change the lens selection to match the installed lens:

Note





Lens selection cannot be changed on a paused or saved image. Be sure to select the correct lens prior to pausing or saving an image.

1. Tap .
2. Use the mouse controller to position the pointer over **Camera Settings** on the popup menu and tap .
3. Position the pointer over the **Lens** tab and tap .
4. Position the pointer over the **Lens** down arrow and select, then position the pointer over the appropriate lens from the pull down menu and select.
5. Tap  to accept setting change and return to scan target mode.

Setting Date and Time





Your Camera has an internal calendar and clock. The calendar is used in naming saved images. The date and time are recorded within an image when the image is saved (see Chapter 3).

To change the date:





1. Use the mouse controller to position the pointer over the date field on the task bar.
2. Tap .
3. Position the pointer over the **Date** down arrow and select. A monthly calendar appears.
 - To change the month and day:
 - Position the pointer over the left/right arrows and tap  as needed to scroll one month at a time until you reach the month you want.
 - Position pointer over the desired day and tap .
 - To change the year:
 - Position the pointer over the year and tap .
 - Position the pointer over the up/down arrows and tap  as needed to scroll one year at a time until you reach the year you want.

4. Tap  to accept setting change and return to scan target mode.





To change the time:

1. Use the mouse controller to position the pointer over the time field on the task bar.
2. Tap .
3. Position pointer over the Time field you are changing (hour, minute, or second if available) and tap .
4. Position the pointer over the up or down arrow next to the time field and tap  repeatedly to scroll to the desired time.
5. Repeat Steps 3-4 to change other fields.
6. Tap  to accept setting change and return to scan target mode.

To change the date format:





1. Use the mouse controller to position the pointer over the date field on the task bar.
2. Tap .
3. Position the pointer over the Locale tab and tap .
4. Position the pointer over the Date down arrow and select.
5. Position pointer over either the up or down arrow and tap  as needed to scroll to the desired date format.
6. Position pointer over the desired format and tap .
7. Tap  to accept setting change and return to scan target mode.

To change the time format:

1. Use the mouse controller to position the pointer over the time field on the task bar.
2. Tap .
3. Position the pointer over the **Locale** tab and tap .
4. Position the pointer over the time down arrow and select.
5. Position pointer over the desired format and tap .
6. Tap  to accept setting change and return to scan target mode.

Changing the Language





To change the language setting:

1. Tap .
2. Use the mouse controller to position the pointer over **Camera Settings** on the popup menu.
3. Tap  to select.
4. Position the pointer over the **Locale** tab and tap  to select.
5. Use the mouse controller and  to choose the desired language setting from the **Language** pull down menu.
6. Tap  to accept setting change and return to scan target mode.

Saving and Reloading Camera Settings





You can save your current camera settings to a Compact Flash card (recommended if using a shared camera to access your custom settings on multiple cameras) or to the camera's internal memory (recommended if there is only one user). When you power on your Camera, settings such as the color palette, temperature units, programmed function buttons, etc., that you previously saved are loaded from the memory card into the camera operating memory. If you are not using a memory card or if the memory card has no stored settings, camera factory settings are loaded first followed by any internal camera settings you previously saved. Internal camera settings override the factory settings. Visible light camera module (VLCM) settings are saved and loaded just as other settings are.

To save current camera settings to the camera's internal memory or to a Compact Flash card:





1. Tap .
2. Use the mouse controller to position the pointer over **Camera Settings** on the popup menu.
3. Tap .
4. Position the pointer over the **Save** tab and tap .
5. Position the pointer over either **Compact Flash** or **Internal** in the Save Settings To row and tap .

6. Tap  to accept setting change and return to scan target mode.

To reload camera settings from the memory card or to load camera settings from a different card without powering off the camera:

1. Tap .
2. Use the mouse controller to position the pointer over **Camera Settings** on the popup menu.
3. Tap .
4. Position the pointer over the Save tab and tap .
5. Position the pointer over Compact Flash in the Load Settings From row and tap .
6. Tap  to accept setting change and return to scan target mode.

To restore factory settings:

1. Tap .
2. Use the mouse controller to position the pointer over **Camera Settings** on the popup menu.
3. Tap .
4. Position the pointer over the Save tab and tap .
5. Position the pointer over Restore Factory Settings and tap .
6. Tap  to accept setting change and return to scan target mode.

Naming Image Files

When you save an image, its name is added to the upper left corner of the image display.

An image name looks like this: IR00020060515_0001







- IR is prefix (The prefix assigned to the image is based on the prefix last assigned and stored in the camera settings.)
- 20060515 is the eight-digit date
- 0001 is the four-digit sequencing number

Changing Image File Name Prefix

To change the prefix used in the saved image name:

Note

This change affects only new images saved to the memory card and does change the prefix of previously saved images.





1. Tap .
2. Use the mouse controller to position the pointer over **Camera Settings** on the popup menu.
3. Tap .
4. Position the pointer over the **Files** tab and tap .
5. Position the pointer over **Edit** and tap  to open the Prefix Editor.
6. Select and click on up to five alphanumeric characters one at a time. Tap  to accept setting change and return to Camera Settings window.
7. Tap  again to return to scan target mode.

Resetting Image File Name Sequence Number

To change the file sequence number used in the saved image name:

Note

If a file sequence number you want to use for image B is already used for image A, the camera automatically selects the lowest possible sequence number for image B and does not override, or delete, image A.

1. Tap .
2. Use the mouse controller to position the pointer over **Camera Settings** on the popup menu.
3. Tap .
4. Position the pointer over the **Files** tab and tap .
5. Position the pointer over **Reset** and tap  to reset the sequence numbers back to 0000.
6. Tap  to accept setting change and return to scan target mode.

Selecting Video Output Options

Using the video port and video cable, you can display the live, paused, or saved images on a TV, video projector, or video monitor. You can also record images on a video recorder.



Video output can be set to NTSC, PAL, or disabled.

Note

Disable the video output function when not in use to save battery power.

To select NTSC or PAL signal and enable/disable video output:

1. Plug the video cable (the end with the cylindrical noise suppressor) into the camera video port; plug the other end of the cable into the TV, projector, monitor, or video recorder.
2. Tap  on the camera.

3. Use the mouse controller to position the pointer over **Camera Settings** on the popup menu.
4. Tap .
5. Position the pointer over the Locale tab and tap .
6. Position the pointer over either the PAL or NTSC video signal radio button and select. The black circle indicates setting is enabled.
7. Position the pointer over the **Power** tab and select.
8. Position the pointer over the **Video Output Enabled** button and select. A check mark indicates function is enabled. When not in use, disable this function to conserve battery power.
9. Tap  to accept setting change and return to scan target mode.

Chapter 7

Advanced Operation





Enhancing the Image

You can use the image enhancement function to improve image clarity in live scan targets and images saved while this function is enabled. Image quality improves with each increase in image enhancement; however, response times are increased accordingly, for example, images set to “Normal” image enhancement refresh a screen at a faster update rate than images set to “High.”

Note

Higher settings are more likely to show blurring on moving targets. Image enhancement cannot be applied to images after they are paused or saved. To use image enhancement, be sure to enable the function prior to scanning target areas and saving images.

To adjust the image enhancement level:

1. Tap .
2. Use the mouse controller to position the pointer over Image Settings on the popup menu and tap .
3. Position the pointer over “None,” “Normal,” “Medium,” or “High” and tap .
4. Tap  to accept setting change and return to scan target mode.

Using Auto Capture

Note

This feature is available on TiR2, TiR4, Ti45 and Ti55 models only.

With the Auto Capture function, you can record a sequence of one or more images by specifying the number of images to be captured and the time

interval between images. Use the Auto Capture function to scan multiple target areas and quickly save the images.

Note





Actual number of saved images depends on the capacity of your memory card.

You can set the Auto Capture sequence to be either manually or temperature triggered. When manually triggered, the camera begins capturing images immediately after you activate the function. Or, you can choose a single camera temperature measurement point (such as the hot and cold cursors, center point, mouse point, and up to three user-defined points) or the minimum, maximum, or average temperatures of any of the area markers (center box plus up to three user-defined areas) to trigger the image capturing sequence.







Note

When using the Auto Capture function with the visible light camera module (VLCM), the rate at which images are captured is slowed considerably if you include visible light images. Turning off the VLCM will keep the rate of images captured at approximately one image per 1 to 2 seconds for 160 x 120 cameras and one image per 2 to 3 seconds for 320 x 240 cameras. When the VLCM is enabled, the rate of images captured is approximately seven seconds.

To manually trigger the Auto Capture function:

1. Tap .
2. Use the mouse controller to position the pointer over Image Settings on the popup menu and tap .
3. Position the pointer over the PIC tab and tap .
4. Position the pointer over the right or left arrows next to **Max Images** to set the number of images you want to capture in the sequence.
5. Position the pointer over the right or left arrows next to Interval (sec) to set the number of seconds between images.
6. Position pointer over the **Manual** radio button and select.
7. Tap  to accept setting change and return to scan target mode.

To trigger the Auto Capture function using a temperature setting:

1. Tap , then use the mouse controller to position the pointer over Image Settings on the popup menu.
2. Tap .
3. Position the pointer over the Auto Capture PIC tab and tap .
4. Position the pointer over the right or left arrows next to Max Images and tap and hold  as needed to set the number of images you want to capture in the sequence.
Click **Check Space** to see how many more images you can fit on the memory card.
5. Position the pointer over the right or left arrows next to Interval (sec) and press and hold  as needed to set the number of seconds between images.
6. Position the pointer over the **Temperature** radio button and select.
7. Select the measurement point from the pull-down menu (Mouse, CenterPoint, CenterBox, Hot cursor, Cold cursor, and user-defined points and areas from pull-down list; for areas, select from Min. Avg., Max.).
8. Select the Over or Under radio button.
9. Use the right/left arrows to set the temperature trigger point.
10. Select the “Save all images after trigger” box if you want to save all images after the initial trigger, or, leave the box unchecked to save only images that meet the trigger criteria. (When the “Save all images after trigger” box is checked, an image is captured after each time interval following the initial trigger, even if the temperature condition changes. If the box is unchecked, images are captured after each time interval only when the specified temperature condition is true.)
11. Tap  to accept setting change and return to scan target mode.

Using User-Defined Display Screen Temperature Markers

Note

This feature is available on TiR2, TiR4, Ti45 and Ti55 models only.



In addition to basic display screen temperature markers (see Chapter 4), the IR-FlexCam offers the following advanced marker options available in scan target mode and/or on a saved image you open:

- Up to three user-defined spot temperatures each marked with a crosshair.
- Up to three user-defined area markers each indicated by a custom-sized box.





To enable the user-defined spot temperature and area markers:

1. Assign the Marker toolbar visible function to a programmable button (see Chapter 2).
2. From scan target mode or from an open image, tap the programmable button; the Marker toolbar appears in the upper left corner of the display screen.





To add spot temperature markers to the display screen from either scan target mode or from an open image:

1. Use the mouse controller to position the pointer over the crosshair icon in the Marker toolbar.
2. Tap .
3. Use the mouse controller to position the mouse crosshair over the image spot desired.
4. Tap  to place a spot temperature marker. The marker name, followed by the temperature of that spot appears on the display screen.
5. Repeat Steps 3-4 to add up to two additional spot temperature markers.
6. Select the rectangle icon from the Marker toolbar to add area markers (see the next set of procedures), or tap the programmable button to close the Marker toolbar and return either to scan target mode or to the open image. From an open image, tap  again to return to scan target mode.

To add area markers to the display screen from either scan target mode or from an open image:







1. Use the mouse controller to position the pointer over the rectangle icon in the Marker toolbar.
2. Tap .
3. Use the mouse controller to move the pointer to the image area desired.
4. Tap  to place the starting point, then use the mouse controller up/down/left/right action to drag the rectangle marker over the desired area. Continue moving the mouse controller as needed to create the desired rectangle size and shape.
5. Tap  to complete the area marker; the marker name, followed by the minimum, average, and maximum temperatures of that area, appear on the display screen.
6. Repeat Steps 3-5 to add up to two additional area markers.
7. Select the crosshair icon from the Marker toolbar to add spot temperature markers (see the procedures earlier in this Chapter), or tap the programmable button to close the Marker toolbar and return either to scan target mode or to the open image. From an open image, tap  again to return to scan target mode.

To change the emissivity or background temperature value of spot temperature and/or area markers from either scan target mode or from an open image:

1. Use the mouse controller to position the pointer over either the crosshair or rectangle icon in the Marker toolbar; tap .
2. Use the mouse controller to position the pointer over the up/down arrows in the Marker toolbar; tap  as necessary to scroll to the desired spot temperature or area marker name.
3. Use the mouse controller to position the pointer over the emissivity value (left box next to the up/down arrows) or the background temperature value (right box next to the X close window button); tap .
4. Use the mouse controller to adjust the value up or down as desired; tap .
5. Repeat Steps 1-4 as needed.

6. Tap the programmable button to close the Marker toolbar and return either to scan target mode or to the open image. From an open image, tap  again to return to scan target mode.

To remove, rename, or annotate spot temperature and/or area markers from either scan target mode or from a open image:

1. Use the mouse controller to position the mouse crosshair/pointer over either the crosshair or the rectangle icon; tap .
2. Use the mouse controller to position the pointer over either the spot marker point or area marker point you want to remove. The mouse crosshair can be positioned anywhere on or near the spot marker; for area markers, the mouse pointer tip must be touching the area marker.
3. Tap ; a pop up menu appears. Use the mouse controller to position the pointer over the desired option: Remove, Rename, or Annotate.
 - If you select remove, the marker is removed from the display screen.
 - If you select rename, the Edit Marker Name keyboard appears.
 - Enter a new marker name using the mouse controller to position the pointer over the appropriate letter and/or function, then press . Repeat as needed.
 - If you select Annotate, the Annotations editor appears.
 - Use the mouse controller to position the pointer over the desired annotations (see Chapter 4) and press .
4. Tap  to accept the setting change and return to scan image mode or to the open image. From an open image, tap  again to return to scan target mode.

To move point and area markers:

1. Use the mouse controller to position the mouse pointer over the label text for a marker. The pointer arrow changes to a “pointing hand.”
2. Press and hold  while using the mouse controller to “drag” the marker to a new location.

To resize area markers:

1. Use the mouse controller to position the mouse pointer over an area edge or corner. The pointer arrow changes to a “pointing hand.”
2. Press  while using the mouse controller to adjust the size of the area marker as desired.

Using Internal Recalibration

Your Camera has an internal calibration feature that automatically adjusts the camera electronics as needed to maintain a high quality image even when the camera senses a significant change in either internal temperature or temperature at the target object. During an internal calibration, you may hear a faint “double click” sound from the camera and see the word “Calibrating” appear on the display screen. The image is frozen for approximately 1-2 seconds during the calibration process.

You may also want to manually trigger an internal calibration to adjust for changing environmental conditions, for example, you move from an extremely cold environment to a hot environment (see *Programming Function Buttons* in Chapter 2).

Chapter 8

Camera Care

Cleaning the IR Lens, VLCM, Display Screen, and Body

For optimal performance, your Camera should be treated with care and gently cleaned as needed. You should always take great care whenever you touch the lens or display screen. The lens elements are made from Germanium crystal and easily can shatter or be scratched and chipped, and the liquid crystal display (LCD) screen is sensitive to excess pressure. To protect your Camera, replace the lens cap and store the camera in the case when you are not using the camera.

⚠Caution

To avoid damaging your camera, use compressed air to remove large particles and dust prior to using a cloth.

To clean the IR lens and the VLCM lenses and windows:

- Lightly rub the lens with a soft cotton cloth slightly moistened (not dripping) with a non-abrasive solution marked for lens cleaning or a mild, diluted dish soap solution (never use solvents).

To clean the display screen:

- Lightly rub the display screen with a clean computer monitor cleaning cloth.

To clean the camera body:

- Lightly rub the camera body with a clean, slightly damp cloth. Dampen the cloth in a solution of water and a small amount of mild soap if needed.

Using Other Lenses

Your Camera comes standard with an f 0.8 20-mm focal length lens, which is appropriate for most applications. The lens is made of Germanium crystal and is antireflection coated for high transmission in the 8 to 14 micron wavelength band. Two additional lenses are available: a wide angle f 0.8 10.5-mm focal length lens to capture larger targets at short distances and a narrow angle f 1.0 54-mm focal length lens to capture small targets at long distances.





When you change lenses, you must change the lens selection setting accordingly as described in Chapter 6. Ensure proper alignment when connecting the standard 20-mm lens. See Chapter 5, *Using Image Alignment* for more information.

For more information on ordering additional lenses or other accessories, visit www.fluke.com.

Viewing Camera and Battery Information





The Info tab within the Camera Info window contains a list of key features such as IR refresh rate, IR image size (in pixels), zoom capabilities, IR-Fusion® capabilities, camera serial number, software versions, lens descriptions of each lens used (if more than one), calibration range, number of image files on the memory card, and the used and free space on the memory card.

To view the Info tab information:

1. Tap .
2. Use the mouse controller to position the pointer over **Camera Info** on the popup menu and tap .
3. Position the pointer over the Info tab and tap .
4. Position the pointer over the up/down arrows to scroll and see additional details.
5. Tap  to return to scan target mode.

The Battery tab within the Camera Info window shows the power source, remaining battery charge level, and battery manufacturer, serial number, and number of discharge cycles.

To view the Battery tab information:

1. Tap .
2. Use the mouse controller to position the pointer over **Camera Info** on the popup menu and tap .
3. Position the pointer over the Battery tab and tap .
4. Tap  to return to scan target mode.

Charging the Batteries

Your Camera comes with a battery charger that works with 100 to 240 V AC input voltage and 50 or 60 Hz input frequency. The charger has a recalibration feature to maintain correct capacity monitoring. When using battery power, a battery symbol appears in the far right side of the camera display screen task bar. The remaining charge capacity is indicated as shown in Table 8-1.

Table 8-1. Remaining Battery Charge Indicators

Indicator	Battery Power Remaining
Green	25% to 100%
Yellow	Less than 25%
Flashing/Solid Red	Approximately 5 minutes until camera powers off.

Use the mouse controller to position the pointer over the battery icon. Press  to obtain an estimate of the remaining battery charge and camera runtime.

To charge camera batteries:

Note

Charge at least one battery for 3 hours before use. Two batteries charge sequentially. The second battery remains in standby mode until the first battery is charged.

1. Connect battery charger AC power supply to a power outlet. An outlet adapter may be necessary outside of the United States.
2. Connect the power supply to the dual-bay battery charger.
3. Insert one battery into one of the battery charger bays; insert the second battery—if available—into the second charger bay.

The LED indicator in front of each bay indicates the charging status as shown in Table 8-2.

Table 8-2. Battery Charging Status

LED Indicator	Charging Status
Off	No battery detected
Green Flashing	Fast charging
Green Solid	Fully charged
Yellow Flashing	Recalibrating
Yellow/Green	Recalibrated
Yellow Solid	Standby
Red Flashing	Error

Recalibrating the Batteries

You should recalibrate your camera batteries periodically to maintain the accuracy of the battery gauge. If a battery requires recalibration, a warning popup window appears on the camera display screen when you power on your camera.

Note



Recalibration may take up to 16 hours. You can charge a battery in the right charging bay while recalibrating a battery in the left bay.



To recalibrate a battery:

1. Insert the battery into the left bay of the battery charger.
2. Press the recalibrate button on the front of the charger.

Conserving Battery Power







To conserve battery power (when the camera is running on battery power, not AC power), the display screen automatically powers off and the system goes into standby mode when the system has been idle for 5 minutes (you can change this time). The camera automatically powers off when the system has been in standby for 10 minutes (you can change this time). You can manually switch to standby mode as well.

To manually switch from full power to standby mode, tap  once.  flashes green.







To switch from standby mode to full power, tap  once again.  remains solid green.

To power on or off, press and hold  for 4 seconds.  remains solid green when power on; no light when power off.

To change the standby timeout time:

1. Tap .
2. Use the mouse controller to position the pointer over Camera Settings on the popup menu.
3. Tap .
4. Position the pointer over the Power tab and tap .
5. Position the pointer over the Standby Timeout down arrow and press .
6. Position the pointer over the time you want and press .
7. Tap  to accept setting change and return to scan target mode.

To change the standby to off timeout time:

1. Tap .
2. Use the mouse controller to position the pointer over **Camera Settings** on the popup menu.
3. Tap .
4. Position the pointer over the Power tab and tap .
5. Position the pointer over the Standby To Off Timeout down arrow and press .
6. Position the pointer over the time you want and press .
7. Tap  to accept setting change and return to scan target mode.

Appendices

Appendix	Title	Page
A	Glossary	A-1
B	Troubleshooting	B-1
C	Emissivity Values	C-1
D	Camera Specifications and Dimensions.....	D-1
E	Resources and References	E-1
F	Camera Default Settings	F-1

TiR2, TiR3, TiR4, Ti40, Ti45, Ti50, Ti55

Users Manual

Appendix A

Glossary

Background Temperature

The temperature of the surroundings, as seen by the target object. In practical terms, this is often considered to be the ambient or room temperature. When outdoors, this can be a very difficult value to estimate, due to the effects of very hot (the sun) and cold (clear sky) objects. By paying careful attention to the location of and direction from which an object is photographed, the effects of very hot and cold objects in the background can often be minimized.

Blackbody

A blackbody is a theoretically ideal radiator and absorber of energy at all electromagnetic wavelengths, i.e., a completely non-reflective object. The term comes from the fact that a cold blackbody appears visually black.

Color Palette

Color representation of the temperatures (temperature scale) in a displayed image.

Electro Static Discharge (ESD) event

A single-event, rapid transfer of electrostatic charge between two objects, usually resulting when two objects at different potentials come into direct contact with each other. ESD can also occur when a high electrostatic field develops between two objects in close proximity.

Emissivity

The ratio of the actual emitted radiance to that of an ideal blackbody at the same temperature. In practical terms, this means that objects with lower emissivity will be more affected by background radiation.

FAT or FAT16 file format

Stands for File Allocation Tables. Most computer operating systems store computer files by dividing the file into smaller pieces and storing those pieces in separate clusters of a hard disk, floppy disk, or Compact Flash memory card. The FAT file system allows an operating system to keep track of the location and sequence of each piece of a file, and also allows the operating system to identify which clusters are unassigned and available for new files. When a computer user wants to read a file, the FAT file system also reassembles each piece of the file into one unit for viewing.

Infrared Spectrum

The portion of the electromagnetic spectrum immediately adjacent to visible light; approximately from 0.7 μ m to microwave.

Infrared Camera

Electronics, lens, and detector combinations that give the user an image, that can be viewed or recorded, of energy in the infrared spectrum.

Infrared, Thermal

The portion of the infrared spectrum from which the majority of heat energy is recorded. This portion of the electromagnetic spectrum is defined as 3 μ m to microwave. However, the majority of infrared imaging occurs between 3 μ m and 14 μ m.

Isotherm

In general scientific terminology, an isotherm is set of lines on a thermogram that marks points that are of the same temperature.

Level

The center value of the color palette (temperature scale).

NTSC

The National Television Standards Committee (NTSC) sets the analog television standard for the United States; this format itself is also informally called “NTSC.” While a standard for the United States, NTSC format has been adopted in other countries as well, including Korea and Japan.

PAL

Phase Alternating Line is the analogue video format used in television transmission in most of Europe—except France, Bulgaria, Russia, Yugoslavia, and some other countries in Eastern Europe, where SECAM is used—Australia and some Asian, African, and South American countries.

Palette Temperatures

Maximum, center, and minimum temperatures (temperature scale) of the color palette.

Radiometric

The ability to measure thermal energy—or temperature—and display it back to the camera user.

Reflected energy

Any energy that does not radiate directly from the target object.

Saturation Colors

The ends of the color palette used to display temperature extremes, for example., a temperature greater than the palette maximum temperature and/or a temperature lower than the palette minimum temperature.

Span

The temperature range across which the color palette (temperature scale) is mapped.

Target

An object being thermally photographed.

Temperature Scale – The temperatures represented by the color palette (palette temperatures).

Thermography – The use of infrared thermography whereby temperatures of a wide variety of targets can be measured remotely and without contact. This is accomplished by measuring the infrared energy radiating from the surface of the target and converting this measurement to an equivalent surface temperature.

Thermogram – An infrared image.

Appendix B

Troubleshooting

For troubleshooting help, see the tips in Table B-1.

Table B-1. Troubleshooting Tips

Symptom	Possible Reason	Possible Solution
Camera will not power on.	The battery is not inserted.	Insert a charged battery.
	The battery is not charged.	Charge the battery. See Chapter 8.
	An improper Compact Flash memory card is inserted.	Use SanDisk-brand Compact Flash memory card with a 2003 or newer copyright date. ⚠ Caution To avoid problems saving images, do not use other memory card brands.



Table B-1. Troubleshooting Tips (cont.)

Symptom	Possible Reason	Possible Solution
<p>Camera will not power on.</p>	<p>The Compact Flash memory card is corrupt.</p>	<p>Reformat* the memory card: Insert the Compact Flash card into a memory card reader installed on your computer. Use “Windows Explorer” or “My Computer” to view the memory card drive location. Right click on the drive and select the FAT or FAT16 file format.</p> <p style="text-align: center;">⚠ Caution</p> <p>To prevent image data loss, do not use FAT32 format. Do not change any other settings.</p> <p style="text-align: center;">⚠ Caution</p> <p>To prevent image data loss, be sure to transfer the images saved on the Compact Flash card to a computer hard drive and/or other back up storage device (e.g., CD-R disc) before reformatting the memory card. Reformatting the memory card will erase all images stored on the card.</p>
	<p>An electrostatic discharge (ESD) event has taken place.</p>	<p>Use a paperclip to press reset. See Chapter 2.</p>
<p>Camera will not save an image.</p>	<p>A Compact Flash memory card is not inserted or an unauthorized card is inserted.</p>	<p>Insert only a SanDisk-brand Compact Flash memory card with a 2003 or newer copyright date.</p> <p style="text-align: center;">⚠ Caution</p> <p>To prevent image saving errors, do not use other memory card brands.</p>

Table B-1. Troubleshooting Tips (cont.)

Symptom	Possible Reason	Possible Solution
Camera will not save an image.	The Compact Flash memory card is full.	Insert new SanDisk-brand Compact Flash memory card, delete unnecessary images from the card (see Chapter 3), or transfer the images saved on the card to a computer hard drive and/or other back up storage device (e.g., CD-R disc).
The approximate sign (~) appears in front of a temperature reading.	The temperature reading is outside the selected calibration range and the accuracy may not be within the specified accuracy of the camera.	Change the temperature calibration range; See <i>Setting Temperature Calibration Range</i> , in Chapter 6.
Visible light and IR images are not properly aligned.	Incorrect focus, optional lenses, or 20-mm lens not properly aligned.	Image alignment is disabled with 10 and 54-mm lenses. Adjust the alignment after the images are downloaded to the SmartView software. Align the 20-mm lens such that the white alignment marking on the lens lines up with the corresponding mark on the camera housing as shown in Figure 5-1.

If you are unable to solve the problem using the possible solutions in the Troubleshooting table:

Reboot the camera by pressing  to power off the camera, then pressing  again to power on the camera.

If this still does not correct the issue:

Contact Fluke as described in Chapter 1.

Before You Contact Us

To better assist you and to minimize your call time, please have the following information ready to share with a customer service representative before contacting Fluke Corporation:

- OCA Version, DSP Version, and MSP Version
You will find this information in the Camera Info menu, Info tab (see Chapter 8).
- Serial Number and Part Number (twist lens module, then see label on the side of the camera body as shown in Figure B-1).

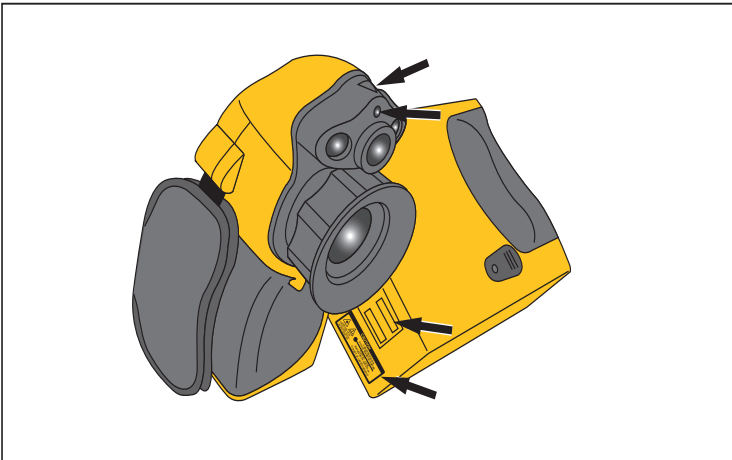

eii015.eps

Figure B-1. Serial/Part Number and Laser Certification Location

Appendix C

Emissivity Values

Use the emissivity values shown in Table C-1 as a guide to properly setting the emissivity value on your Camera.

Table C-1. Emissivity Values of Common Materials

Material	Temperature (°C)	Emissivity
Aluminum, polished	0	0.05
Aluminum, rough surface	0	0.07
Aluminum, strongly oxidized	0	0.25
Asbestos board	0	0.96
Asbestos fabric	0	0.78
Asbestos paper	0	0.94
Asbestos slate	0	0.96
Brass, dull, tarnished	0	0.22
Brass, polished	0	0.03
Brick, common	0	0.85
Brick, glazed, rough	0	0.85
Brick, refractory, rough	0	0.94
Bronze, porous, rough	0	0.55
Bronze, polished	0	0.10

Table C-1. Emissivity Values of Common Materials (cont.)

Material	Temperature (°C)	Emissivity
Carbon, purified	0	0.80
Cast iron, rough casting	0	0.81
Cast iron, polished	0	0.21
Charcoal, powdered	0	0.96
Chromium, polished	0	0.10
Clay, fired	0	0.91
Concrete	0	0.54
Copper, polished, annealed	0-17	0.01-0.02
Copper, commercial burnished	0	0.07
Copper, oxidized	0	0.65
Copper, oxidized to black	0	0.88
Electrical tape, black plastic	0	0.95
Enamel	27	0.90
Formica	0	0.93
Frozen soil	0	0.93
Glass	0	0.92
Glass, frosted	0	0.96
Gold, polished	0	0.02
Ice	0	0.97
Iron, hot rolled	0	0.77
Iron, oxidized	0	0.74

Table C-1. Emissivity Values of Common Materials (cont.)

Material	Temperature (°C)	Emissivity
Iron, sheet galvanized, burnished	0	0.23
Iron, sheet, galvanized, oxidized	0	0.28
Iron, shiny, etched	0	0.16
Iron, wrought, polished	0	0.28
Lacquer, Bakelite	0	0.93
Lacquer, black, dull	0	0.97
Lacquer, black, shiny	0	0.87
Lacquer, white	0	0.87
Lampblack	0	0.96
Lead, gray	0	0.28
Lead, oxidized	0	0.63
Lead, red, powdered	0	0.93
Lead, shiny	0	0.08
Mercury, pure	0	0.10
Nickel, on cast iron	0	0.05
Nickel, pure polished	0	0.05
Paint, silver finish	25	0.31
Paint, oil, average	0	0.94
Paper, black, shiny	0	0.90
Paper, black, dull	0	0.94
Paper, white	0	0.90
Platinum, pure, polished	0	0.08
Porcelain, glazed	0	0.92

Table C-1. Emissivity Values of Common Materials (cont.)

Material	Temperature (°C)	Emissivity
Quartz	0	0.93
Rubber	0	0.93
Shellac, black, dull	0	0.91
Shellac, black, shiny	0	0.82
Snow	0	0.80
Steel, galvanized	0	0.28
Steel, oxidized strongly	0	0.88
Steel, rolled freshly	0	0.24
Steel, rough surface	0	0.96
Steel, rusty red	0	0.69
Steel, sheet, nickel-plated	0	0.11
Steel, sheet, rolled	0	0.56
Tar paper	0	0.92
Tin, burnished	0	0.05
Tungsten	0	0.05
Water	0	0.98
Zinc, sheet	0	0.20

Appendix D

Camera Specifications and Dimensions

Table D-1 lists the technical specifications for the TiR2, Ti45 and Ti40 models.

Table D-1. TiR2, Ti45 and Ti40 Specifications

Model Name	Ti45 and TiR2	Ti40
Imaging Performance		
Detector	160 x 120 Focal Plane Array (FPA), vanadium oxide (VOX) uncooled microbolometer.	
Refresh Rate	Cameras have either 7.5 Hz or 30 Hz refresh rate. Use the Camera Info screen to determine the refresh rate for your specific camera.	
Spectral Band	8 μm to 14 μm	
Thermal Sensitivity	$\leq 0.080^{\circ}\text{C}$ at 30°C (80 mK)	$\leq 0.090^{\circ}\text{C}$ at 30°C (90 mK)
Focusing	Single Finger Manual Focus	
Electronic	2x	None

Table D-1. TiR2, Ti45 and Ti40 Specifications (cont.)

Model Name	Ti45 and TiR2	Ti40
Zoom		
Digital Image Enhancement	Automatic Full-time Enhanced	
Display and Image Storage		
Digital Display	5 in. high-res, 320 x 240, sunlight readable color LCD	
On-screen Indicators	Indicate status of battery, target emissivity, background temp., temp. unit (C/F/K), date, and time	
Palettes	8 unique color palettes available	
Storage Medium	Compact Flash Card (stores hundreds of images)	
File Formats Supported	14 bit measurement data included. Exportable JPEG, BMP, TIF, PNG using SmartView desktop software	
Image Controls	Level, Span, Auto Adjust (continuous/manual)	
Image Browsing	Full-screen and thumbnail	
Enhanced Text Annotation	User definable, automatically included in reports	n/a
Programmable Image Capture	Automatically capture thermal images (program)	n/a
Standard Optics		
20mm f/0.8 Germanium	Field of View 23° Horizontal x 17° Vertical (optional lenses available)	
Spatial Resolution (IFOV)	2.6 mrad IFOV, 0.15 m minimum focus	

Table D-1. TiR2, Ti45 and Ti40 Specifications (cont.)

Model Name	Ti45 and TiR2	Ti40
Temperature Measurement		
Calibrated Temp. Ranges	Range 1 = -20 °C to 100 °C (-4°F to 212°F) Range 2, 3, and 4 are not available on the TiR2 Range 2 = -20 °C to 350 °C (-4 °F to 662 °F) Range 3 = 250 °C to 600 °C (482°F to 1112°F) Range 4 = 500 °C to 1200 °C (932 °F to 2192 °F) (option)	Range 1 = -20 °C to 100 °C (-4°F to 212°F) Range 2 = -20 °C to 350 °C (-4 °F to 662 °F)
Accuracy	±2 °C or ± 2 %	
Measurement Modes	Movable points & boxes Centerpoint Cursor temp. Center box (area min/max, average) Automatic hot and cold point detection Color alarm	Centerpoint Cursor temp. Center box (area min/max, average)
Emissivity Correction	Based on user input. Variable from 0.01 to 1.0 (0.01 increments)	
Power		
Battery Type	Li-Ion Smart Battery, rechargeable, field-replaceable	

Table D-1. TiR2, Ti45 and Ti40 Specifications (cont.)

Model Name	Ti45 and TiR2	Ti40
Battery Operating Time	3 hours continuous operation	
Battery Charging	2-bay intelligent charger powered via AC outlet or optional 12 V from car	
AC Operation	AC adapter 110/220 V ac, 50/60 Hz	Option
Power Saving	Automatic shutdown and standby modes (user specified)	
Interfaces		
Video Output	RS170 EIA/NTSC or CCIR/PAL composite video	
Physical Characteristics		
Weight	4.4 lbs including battery	
Size	71 mm x 262 mm x 196 mm (2.8 in x 10.5 in x 7.7 in)	
Tripod Mounting	¼ in – 20 UNC	
Environmental		
Operating Temp.	-10 °C to +50 °C (14 °F to 122 °F)	
Storage Temp.	-40 °C to +70 °C (-40 °F to 158 °F)	
Humidity	Operating and storage 10 % to 95 %, non-condensing	
Shock/Vibration	25G, IEC 68-2-29 / 3G, IEC 68-2-6	
Encapsulation	IP54, IEC 60529	
Transit Drop	MIL-STD-810F, Method 516.5, Procedure IV	
Agency Approvals	CE Approved (EN61326 Standard)	

Table D-1. TiR2, Ti45 and Ti40 Specifications (cont.)

Model Name	Ti45 and TiR2	Ti40
Warranty		
Two years and begins on date of shipment.		
Standard Equipment		
	IR Camera with 20-mm f/0.8 lens	
	Compact Flash Card	
	USB Card Reader	
	SmartView™ Software	
	Shoulder Strap	
	2 Rechargeable Batteries	
	Premium Carrying Case	
	Battery Charger	
	User Manual	
	Video Cable	
	PCMCIA Adapter	
	AC Adapter	
Optional Equipment		
	Power Cable for 12 V from car to charger	
	Extra Batteries	
	Sun Shield	
	54-mm Tele-photo Lens (9 °H x 6 °V)	
	10.5-mm Lens (42 °H x 32 °V)	

Table D-1. TiR2, Ti45 and Ti40 Specifications (cont.)

Model Name	Ti45 and TiR2	Ti40
	Extended temperature range 500 °C to 1200 °C (932 °F to 2192 °F) with 20mm lens	AC Adapter
Visible Light Camera		
Pixels	1.3 M	
Active Pixels	1280 H x 1024 V	
Field of View	56° H x 46° V	
Sensitivity	1 lux	
Focus Distance	50 cm to infinity	
Exposure	Auto	
Integrated Flash	Manual or default for high quality visible light images	
Torch Light Mode	For enhanced video imaging in dark areas	
IR-Fusion® Modes	<ul style="list-style-type: none"> • Full screen IR image blended with visible image • Picture-in-picture blended with visible image • Alarm mode 	

Table D-2 lists the technical specifications for the TiR3, TiR4, Ti55 and Ti50 models.

Table D-2. TiR3, TiR4, Ti55 and Ti50 Specifications

Model Name	Ti55 and TiR4	Ti50 and TiR3
Imaging Performance		
Detector	320 x 240 Focal Plane Array (FPA), vanadium oxide (VOX) uncooled microbolometer.	
Refresh Rate	Cameras have either 7.5 Hz or 60 Hz refresh rate. Use the Camera Info screen to determine the refresh rate for your specific camera.	
Spectral Band	8 μm to 14 μm	
Thermal Sensitivity	≤ 0.050 $^{\circ}\text{C}$ at 30 $^{\circ}\text{C}$ (50 mK)	≤ 0.070 $^{\circ}\text{C}$ at 30 $^{\circ}\text{C}$ (70 mK)
Focusing	Single Finger Manual Focus	
Electronic Zoom	2x, 4x, 8x (2x, 4x when IR-Fusion® enabled)	2x
Digital Image Enhancement	Automatic Full-time Enhanced	
Display and Image Storage		
Digital Display	5 in high-resolution, 320 x 240, sunlight readable color LCD	

Table D-2. TiR3, TiR4, Ti55 and Ti50 Specifications (cont.)

Model Name	Ti55 and TiR4	Ti50 and TiR3
On-screen Indicators	Indicate status of battery, target emissivity, background temperature, temperature unit (C/F/K), date, and time	
Palettes	8 unique color palettes available	
Storage Medium	Compact Flash Card (stores hundreds of images)	
File Formats Supported	14-bit measurement data included. Exportable JPEG, BMP, TIF, PNG using SmartView desktop software	
Image Controls	Level, Span, Auto Adjust (continuous/manual)	
Image Browsing	Full-screen and thumbnail	
Enhanced Text Annotation	User definable, automatically included in reports	n/a
Programmable Image Capture	Program camera to automatically capture thermal images	n/a
Standard Optics		
20mm f/0.8 Germanium	Field of view—23 ° Horizontal x 17 ° Vertical (optional lenses available)	
Spatial Resolution (IFOV)	1.3 mrad IFOV, 0.15 m minimum focus	

Table D-2. TiR3, TiR4, Ti55 and Ti50 Specifications (cont.)

Model Name	Ti55 and TiR4	Ti50 and TiR3
Temperature Measurement		
Calibrated Temperature Ranges	Range 1 = -20 °C to 100 °C (-4 °F to 212 °F) Range 2 and 3 are not available on the the TiR4 Range 2 = -20 °C to 350 °C (-4°F to 662°F) Range 3 = 250 °C to 600 °C (482 °F to 1112 °F)	Range 1 = -20 °C to 100 °C (-4 °F to 212 °F) Range 2 is not available on the TiR3 Range 2 = -20 °C to 350 °C (-4 °F to 662 °F)
Accuracy	±2 °C or ±2 %	
Measurement Modes	Movable points & boxes Centerpoint Cursor temp. Center box (area min/max, average) Automatic hot and cold point detection Color alarm	Centerpoint Cursor temp. Center box (area min/max, average)
Emissivity Correction	Based on user input. Variable from 0.01 to 1.0 (0.01 increments)	
Power		
Battery Type	Li-Ion Smart Battery, rechargeable, field-replaceable	
Battery Oper. Time	3 hours continuous operation	

Table D-2. TiR3, TiR4, Ti55 and Ti50 Specifications (cont.)

Model Name	Ti55 and TiR4	Ti50 and TiR3
Battery Charging	2-bay intelligent charger powered via AC outlet or optional 12v from car	
AC Operation	AC adapter 110/220 V ac, 50/60 Hz	Option
Power Saving	Automatic shutdown and standby modes (user specified)	
Interfaces		
Video Output	RS170 EIA/NTSC or CCIR/PAL composite video	
Physical Characteristics		
Weight	4.4 lbs including battery	
Size	71mm x 262mm x 196mm (2.8 in x 10.5 in x 7.7 in)	
Tripod Mounting	1/4 in – 20 UNC	
Environmental		
Operating Temperature	-10 °C to +50 °C (14 °F to 122 °F)	
Storage Temperature	-40 °C to +70 °C (-40 °F to 158 °F)	
Humidity	Operating and storage 10 % to 95 %, non-condensing	
Shock/ Vibration	25G, IEC 68-2-29 / 3G, IEC 68-2-6	
Encapsulation	IP54, IEC 60529	

Table D-2. TiR3, TiR4, Ti55 and Ti50 Specifications (cont.)

Model Name	Ti55 and TiR4	Ti50 and TiR3
Transit Drop	MIL-STD-810F, Method 516.5, Procedure IV	
Agency Approvals	CE Approved (EN61326 Standard)	
Warranty		
Two years and begins on date of shipment.		
Standard Equipment		
	IR Camera with 20-mm f/0.8 lens	
	Compact Flash Card	
	USB Card Reader	
	SmartView™ Software	
	Shoulder Strap	
	2 Rechargeable Batteries	
	Premium Carrying Case	
	Battery Charger	
	User Manual	
	Video Cable	
	PCMCIA Adapter	
	AC Adapter	
Optional Equipment		
	Power Cable for 12 V from car to charger	
	Extra Batteries	

Table D-2. Ti R3, TiR4, Ti55 and Ti50 Specifications (cont.)

Model Name	Ti55 and TiR4	Ti50 and TiR3
	Sun Shield	
	54-mm Tele-photo Lens (9 °H x 6 °V)	
	10.5-mm Lens (42 °H x 32 °V)	
		AC Adapter
Visible Light Camera		
Pixels	1.3 M	
Active Pixels	1280 H x 1024 V	
Field of View	56° H x 46° V	
Sensitivity	1 lux	
Focus Distance	50 cm to infinity	
Exposure	Auto	
Integrated Flash	Manual or default for high quality visible light images	
Torch Light Mode	For enhanced video imaging in dark areas	
IR-Fusion® Modes	<ul style="list-style-type: none"> • Full screen IR image blended with visible image • Picture-in-picture blended with visible image • Alarm mode 	

Camera dimensions are shown in Figures D-1 and D-2.

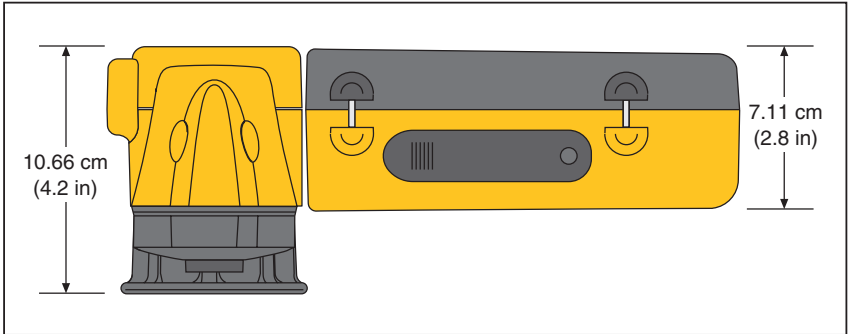

Figure D-1. Camera Dimensions

eii019.eps

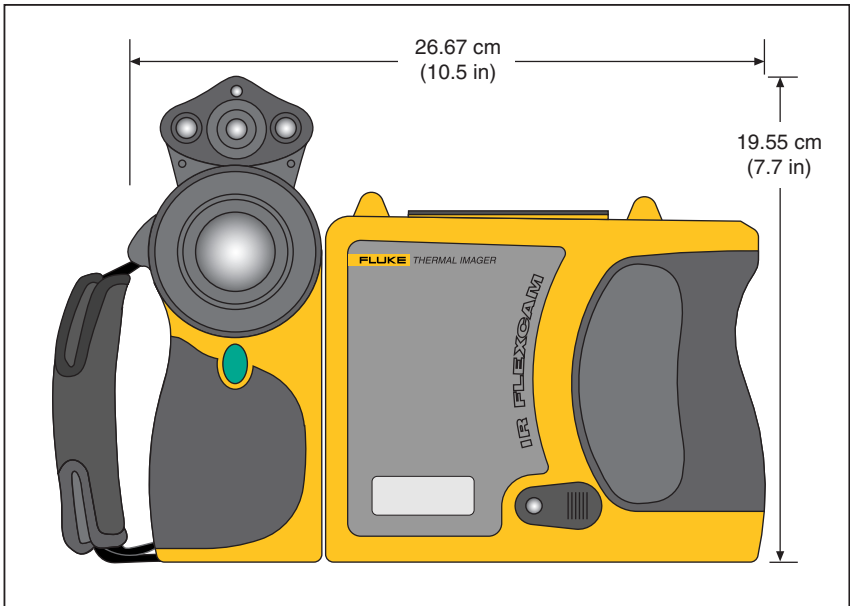

Figure D-2. Camera Dimensions - Height and Width

eii020.eps

Appendix E

Resources and References

Level 1 Thermography

One good way to begin learning the skills required to become a successful thermographer is to take a Level 1 thermography class.

Level 1 Training Overview

- In a Level I class, participants will:
- Learn to think thermally
- Learn about basic heat transfer theory
- Discover how to successfully use an infrared detector (camera)
- Find out how to inspect electrical and mechanical equipment
- Learn how to analyze building and roof systems using an infrared sensor
- Successfully capture images as well as document findings and write reports
- Learn professional tips on marketing thermography to internal or external customers

Setting Up Your Infrared Program

An effective, sustainable thermography program requires more than just an infrared camera. It requires the right camera used by qualified professionals able to consistently provide high-quality data.

Let Fluke Corporation assist you in developing a successful thermography program. For more information on thermography training and/or setting up your infrared program, contact us at www.fluke.com.

Appendix F

Camera Default Settings

Table F-1 shows the default settings for the TiR2, Ti45 and Ti40 models.

Table F-1. Default Settings, TiR2, Ti45 and Ti40 Models

Setting	Ti45 and TiR2	Ti40
Camera Info		
Info	Reference Only	
Battery	Reference Only	
Camera Settings		
Calendar		
Date	Current	
Time	Current	
Lens	20-mm/F.8 (initial from factory, subsequent settings are last user-setting even on “reset to factory defaults”)	
Calibration Range	-4 °F to 212 °F (initial from factory, subsequent settings are last user-setting even on “reset to factory defaults”)	
Power		
Display Brightness	Normal	

TiR2, TiR3, TiR4, Ti40, Ti45, Ti50, Ti55*Users Manual***Table F-1. Default Settings, TiR2, Ti45 and Ti40 Models (cont.)**

Setting	Ti45 and TiR2	Ti40
High Brightness Timeout	30 seconds	
Standby Time Out	5 min	
Standby to Off Time	10 min	
Video Output	Off	
Files		
File Prefix	IR	
File Sequence	0	
Auto-Start Notation Wizard	Disabled	n/a
Locale		
Temp. Units	F	
Language	English	
Video Signal	NTSC	

Table F-1. Default Settings, TiR2, Ti45 and Ti40 Models (cont.)

Setting	Ti45 and TiR2	Ti40
Decimal Symbol	Period	
Date	MM-dd-yy	
Time	HH:mm:ss	
Mouse		
Mouse Sensitivity	Fast	
Fast Value Changes	Disabled	
Save	Reference Only	
Browse Images	Reference Only	
VLCM		
Enable VLCM	Enabled	
IR-Fusion® Level	100% IR	
Full Screen/PIP	PIP	
Flash Enabled	Disabled	
High Brightness	Enabled	
Vivid Color	Enabled	

Table F-1. Default Settings, TiR2, Ti45 and Ti40 Models (cont.)

Setting	Ti45 and TiR2	Ti40
Image Settings		
Display		
Center Point	Disabled	
Center Box	Disabled	
Hot Cursor	Disabled	n/a
Cold Cursor	Disabled	n/a
Temp. Scale	Enabled	
Auto-Hide Task Bar	Disabled	
Onscreen Logo	Disabled	
Mouse Temp	Enabled	
Zoom Image	1x	
Image Enhancement	Normal	
Emissivity		
Emissivity	0.95	

Table F-1. Default Settings, TiR2, Ti45 and Ti40 Models (cont.)

Setting	Ti45 and TiR2	Ti40
Back-ground Temp	68 °F	
...Fixed Image	Disabled	
Image Settings		
Color Palette		
Color Palette	Blue-Red	
Saturation Colors	Standard	
Automatic Adjustment	Disabled	
PIC		
Max. Images	1	n/a
Interval	1sec	n/a
Trigger	Manual	n/a
Markers	Reference Only	n/a

Table F-1. Default Settings, TiR2, Ti45 and Ti40 Models (cont.)

Setting	Ti45 and TiR2	Ti40
Color Alarms		
Enable Onscreen Alarm	Disabled	Disabled
Temps. Are Inside Specified Range	TRUE	n/a
Max	Calibration range maximum	n/a
Min	Calibration range maximum	n/a
Annotate Images	Reference Only	Disabled
Programmable Buttons		
F1	Centerpoint/box	
F2	PIP	
F3	Laser	

Table F-2 shows the default settings for the TiR3, TiR4, Ti55 and Ti50 models.

Table F-2. Default Settings, TiR3, TiR4, Ti55 and Ti50 Models

Setting	Ti55 and TiR4	Ti50 and TiR3	
Camera Info			
Info	Reference Only		
Battery	Reference Only		
Camera Settings			
Calendar			
Date	Current		
Time	Current		
Lens	20mm/F.8 (initial from factory, subsequent settings are last user-setting even on “reset to factory defaults”)		
Calibration Range	-20 °C to 100 °C (-4 °F to 212 °F) Initial from factory, subsequent settings are last user-setting even on “reset to factory defaults”)		
Power			
Display Brightness	Normal		
High Brightness Timeout	30 seconds		
Standby Time Out	5 min		
Standby to Off Time	10 min		

TiR2, TiR3, TiR4, Ti40, Ti45, Ti50, Ti55*Users Manual***Table F-2. Default Settings, TiR3, TiR4, Ti55 and Ti50 Models (cont.)**

Setting	Ti55 and TiR4	Ti50 and TiR3
Video Output	Off	
Files		
File Prefix	IR	
File Sequence	0	
Auto-Start Notation Wizard	Disabled	n/a
Locale		
Temp. Units	F	
Language	English	
Video Signal	NTSC	
Decimal Symbol	Period	
Date	MM-dd-yy	
Time	HH:mm:ss	
Mouse		
Mouse Sensitivity	Fast	
Fast Value Changes	Disabled	
Save	Reference Only	
Browse Images	Reference Only	

Table F-2. Default Settings, TiR3, TiR4, Ti55 and Ti50 Models (cont.)

Setting	Ti55 and TiR4	Ti50 and TiR3
IR-Fusion®		
Enable IR-Fusion®	Enabled	
IR-Fusion® Level	100% IR	
Full Screen/PIP	PIP	
Flash Enabled	Disabled	
High Brightness	Enabled	
Vivid Color	Enabled	
Image Settings		
Display		
Center Point	Disabled	
Center Box	Disabled	
Hot Cursor	Disabled	n/a
Cold Cursor	Disabled	n/a
Temp. Scale	Enabled	
Auto-Hide Task Bar	Disabled	
Onscreen Logo	Disabled	

Table F-2. Default Settings, TiR3, TiR4, Ti55 and Ti50 Models (cont.)

Setting	Ti55 and TiR4	Ti50 and TiR3
Image Settings		
Mouse Temp	Enabled	
Zoom Image	1x	
Image Enhancement	Off	
Emissivity		
Emissivity	0.95	
Background Temp	68 °F	
Fixed Image	Disabled	
Color Palette		
Color Palette	Blue-Red	
Saturation Colors	Standard	
Automatic Adjustment	Disabled	

Table F-2. Default Settings, TiR3, TiR4, Ti55 and Ti50 Models (cont.)

Setting	Ti55 and TiR4	Ti50 and TiR3
PIC		
Max. Images	1	n/a
Interval	1sec	n/a
Trigger	Manual	n/a
Markers	Reference Only	n/a
Color Alarms		
Enable Onscreen Alarm	Disabled	
Temps. Are Inside Specified Range	TRUE	
Max	Calibration range maximum	
Min	Calibration range minimum	
Annotate Images	Reference Only	Disabled
Programmable Buttons		
F1	Centerpoint/box	
F2	PIP	
F3	Laser	

—A—

- analysis area, 2-9
- analysis point, 2-9
- annotations, 2-10, 4-9
 - add new annotation item, 4-11
 - adding to saved images, 4-9
 - auto-annotate, 4-11
 - auto-annotation function, 4-11
 - delete, change, or add new category, 4-10
 - smartview annotations lists, 4-12
- area markers. *See* user-defined display screen temperature markers
- auxiliary power port. *See* camera overview

—B—

- background temperature, 2-8, 4-1
 - fixed image function, 4-2
 - setting, 4-1
- batteries
 - camera and battery info, 8-2
 - charging, 8-3
 - conserving power, 8-5
 - disposal, 1-4
 - inserting, 1-6
 - recalibrating, 8-4
- brightness, 2-10, 6-1
- brightness and color controls, 5-4
- browse image arrows, 2-8
- browse images, 2-10, 3-1
- browse thumbnails, 2-10, 5-7

—C—

- calibration range. *See* temperature calibration range
- camera and battery information
 - view battery info, 8-3
 - view camera info, 8-2
- camera overview
 - camera parts, 2-2
 - parts descriptions, 2-4
- camera settings
 - restore factory settings, 6-7
 - save and reload, 6-6
- capture image, 1-10, *See* save image mode and saving images
- center box temperatures, 2-9
- centerpoint temperature, 2-8
- centerpoint/centerbox, 2-10
- charging batteries, 8-4
- cleaning
 - camera body, 8-1
 - display screen, 8-1
 - lenses, 8-1
- cold cursor temperature, 2-9
- color alarms, 5-8
- color controls, 5-4
- color palette, 4-2, *See*
 - adjust temperature span, 4-3
 - changing, 4-2
 - hiding, 6-2
- compactflash memory card
 - inserting, 1-8, 2-14
 - removing, 2-14
- conserving battery power, 8-5
- customer service, B-3

—D—

date, 2-8
 changing, 6-4
 changing format, 6-5
display screen, 2-6
 adjusting brightness, 6-1
 descriptions, 2-8
 hiding color palette, 6-2
 hiding task bar, 6-2
 temperature markers, 4-7
 user-defined temperature markers, 7-4
DSP version, B-4, *See* camera and battery information

—E—

electronic zoom, 2-10, 3-3
emissivity, 2-8
 fixed image function, 4-2
 setting value, 4-1

—F—

factory settings. *See* default settings
file naming. *See* naming image files
fixed image function
 disabling, 4-2
 enabling, 4-2
flash, 5-5
 enable, 5-5

focus, 1-8, 5-2
full screen view, 2-11, 5-4
fusion blend level, 5-3
 adjusting, 5-3
 dialog box, 2-9

—G—

glossary, A-1

—H—

hot cursor temperature, 2-9

—I—

image
 browse image, 3-1
 browse thumbnails, 5-7

 file naming, 6-7
 pause, 3-1
 save, 3-1
image alignment, 5-1
image enhancement, 2-11, 7-1
 adjusting level, 7-1
image name, 2-8
infrared lens. *See* camera overview
infrared program
 setting up, E-1
internal recalibration, 7-7
inventory checklist, 1-4

—L—

laser pointer, 2-11, 5-7
 safety information, 1-3
lens
 changing selection, 6-3
 using other lenses, 8-2
level. *See* level and span
level and span, 1-9, 2-8, 4-3
 setting arbitrary fixed temperature, 4-4
 setting temperature, auto, 4-4
 setting temperature, manual, 4-3
level and span button. *See* camera overview

—M—

marker toolbar, 2-10, *See* display screen, user-defined temperature markers
memory card. *See* compactflash memory card
menus, 2-12
 display screen options, 2-12
model number. *See* camera and battery information
mouse pointer and temperature, 2-8
MSP version, B-4, *See* camera and battery information

—N—

naming image files, 6-7
 changing name prefix, 6-7
 resetting name sequence number, 6-9
notes. *See* annotations

—O—

OCA version, B-4, *See* camera and battery information
 off button. *See* camera overview
 on button. *See* camera overview
 onscreen logo, 4-7

—P—

palette saturation colors, 4-5
 enabling/disabling, 4-6
 palette visible, 2-10
 part number, B-4
 pause image mode, 3-1
 PIC. *See* programmable image capture
 picture-in-picture view, 2-9, 2-11, 5-4
 power source indicator, 2-8
 power switch. *See* camera overview
 programmable functions, 2-10
 programmable image capture (PIC), 7-1
 manual trigger, 7-2
 start sequence, 2-11
 stop sequence, 2-11
 temperature trigger, 7-2

—R—

record sequence of several images. *See*
 programmable image capture
 recording control images, 5-6
 reset switch. *See* camera overview

—S—

safety information, 1-2
 saturation colors. *See* palette saturation colors
 save image mode
 delete all saved images, 3-3
 delete saved image, 3-2
 view saved image, 3-2
 view saved image info, 3-4
 scan target mode, 3-1
 sequence number. *See* naming image files
 serial number, B-4, *See* camera and battery information
 smartview software, 1-11, 4-12

span. *See* level and span
 spot temperatures. *See* display screen, user-defined temperature markers, *See* display screen, temperature markers
 standby mode, 8-5
 start sequence, 2-11, *See* programmable image capture
 stop sequence, 2-11, *See* programmable image capture

—T—

temperature calibration range, 6-3
 setting, 6-3
 temperature markers. *See* display screen, temperature markers
 temperature units, 2-8
 setting, 6-3
 thumbnail browser, 5-7
 time, 2-8
 changing, 6-5
 changing format, 6-5
 torch control, 2-10, 5-5
 training
 thermography, E-1
 trigger button, 2-5
 troubleshooting, B-1

—U—

unpacking, 1-4
 user-defined temperature markers. *See* display screen, user-defined temperature markers

—V—

video output
 enable/disable, 6-9
 select NTSC or PAL, 6-9
 video port. *See* camera overview
 visible light camera module (VLCM), 2-1
 enabling/disabling, 5-1
 visible light flash, 5-5
 visible light lens. *See* camera overview
 vivid color. *See* brightness and color controls

—Z—

zoom. See electronic zoom