

## Checking ground electrode impedance for commercial, industrial and residential buildings

### Application Note

Most facilities have grounded electrical systems, so that in the event of a lightning strike or utility overvoltage, current will find a safe path to earth. A ground electrode provides the contact between the electrical system and the earth. To ensure a reliable connection to earth, electrical codes, engineering standards, and local standards often specify a minimum impedance for the ground electrode. The International Electrical Testing Association specifies ground electrode testing every three years for a system in good condition with average up-time requirements. This application note explains earth/ground principles and safety in more depth and then describes the principle testing methods: 3 and 4 pole Fall-of-Potential testing, selective testing, stakeless testing and 2 pole testing.

#### Why Ground?

The US National Electrical Code (NEC) gives two principle reasons for grounding a facility.

- Stabilize the voltage to earth during normal operation.
- Limit the voltage rise created by lightning, line surges or unintentional contact with higher-voltage lines.

Current will always find and travel the least-resistance path back to its source, be that a utility transformer, a transformer within the facility or a generator. Lightning, meanwhile, will always find a way to get to the earth.

In the event of a lightning strike on utility lines or anywhere in the vicinity of a building, a low-impedance ground electrode will help carry the energy into the earth. The grounding and bonding

systems connect the earth near the building with the electrical system and building steel. In a lightning strike, the facility will be at approximately the same potential. By keeping the potential gradient low, damage is minimized.

If a medium voltage utility line (over 1000 V) comes in contact with a low voltage line, a drastic overvoltage could occur for nearby facilities. A low impedance electrode will help limit the voltage increase at the facility. A low impedance ground can also provide a return path for utility-generated transients. Figure 1 shows a grounding system for a commercial building.

#### Ground Electrode Impedance

The impedance from the grounding electrode to the earth varies depending on two factors: the resistivity of the surrounding earth and the structure of the electrode.

Resistivity is a property of any material and it defines the material's ability to conduct current. The resistivity of earth is complicated, because it:

- Depends on composition of the soil (e.g. clay, gravel and sand)
- Can vary even over small distances due to the mix of different materials
- Depends on mineral (e.g. salt) content
- Varies with compression and can vary with time due to settling
- Changes with temperature, freezing (and thus time of year). Resistivity increases with decreasing temperature.
- Can be affected by buried metal tanks, pipes, re-bar, etc.
- Varies with depth

Since resistivity may decrease with depth, one way to reduce earth impedance is to drive an electrode deeper. Using an array of rods, a conductive ring or a grid are other common ways of increasing the effective area of an electrode. Multiple rods

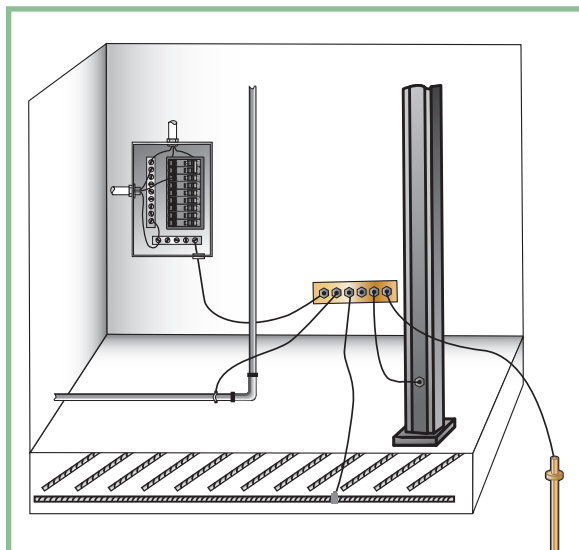

Figure 1: A grounding system combining reinforcing steel and a rod electrode

should be outside of each other's "areas of influence" to be most effective (see Figure 2). The rule of thumb is to separate the elements by more than their length. For example: 8-foot rods should be spaced more than 8 feet apart to be most effective.

The NEC specifies 25 ohms as an acceptable limit for electrode impedance. The IEEE Standard 142 Recommended Practice for Grounding of Industrial and Commercial Power Systems ("Green Book") suggests a resistance between the main grounding electrode and earth of 1 to 5 ohms for large commercial or industrial systems.

Local authorities including the authority having jurisdiction (AHJ) and plant managers are responsible for determining acceptable limits for ground electrode impedance.

Note: Power distribution systems deliver alternating current and ground testers use alternating current for testing. So, you'd think we would talk about impedance, not resistance. However, at power line frequencies, the resistive component of the earth impedance is usually much bigger than the reactive component, so you will see the terms impedance and resistance used almost interchangeably.

### How do ground impedance testers work?

There are two types of ground impedance testers. Three and four point ground testers and clamp-on ground testers. Both types apply a voltage on the electrode and measure the resulting current.

A three or four-pole ground tester combines a current source and voltage measurement in a "lunch box" or multimeter-style package. They use multiple stakes and/or clamps.

Ground testers have the following characteristics:

- AC test current. Earth does not conduct dc very well.
- Test frequency that is close to, but distinguishable from the power frequency and its harmonics. This prevents stray currents from interfering with ground impedance measurements.
- Separate source and measure leads to compensate for the long leads used in this measurement.
- Input filtering designed to pick up its own signal and screen out all others.

Clamp-on ground testers resemble a large clamp meter. But they are very different because clamp-on ground testers have both a source transformer and a measurement transformer. The source transformer imposes a voltage on the loop under test and the measurement transformer measures the resulting current. The clamp-on ground tester uses advanced filtering to recognize its own signal and screen out all others.

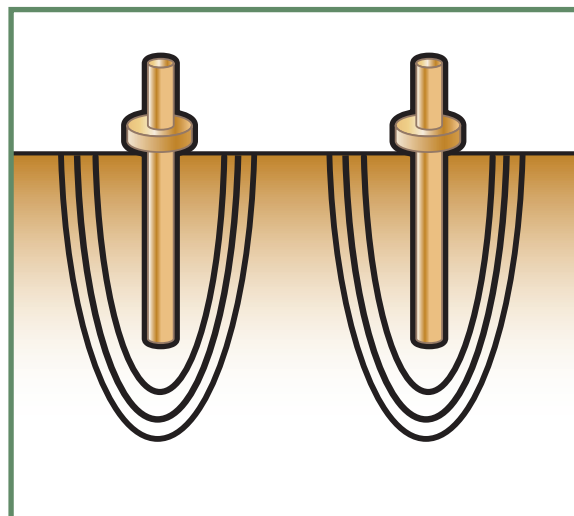

Figure 2: Ground electrodes have "areas of influence" that surround them

### Ground Testing Safety

Always use insulated gloves, eye protection and other appropriate personal protective equipment when making connections. It is not safe to assume that a ground electrode has zero voltage or zero amps, for reasons given below.

To perform a basic ground test (called Fall-of-Potential) on an electrode, **the electrode must be disconnected from the building.** New selective methods allow accurate testing with the electrode still connected. See "Selective Measurements."

A ground fault in the system might cause significant current to flow through the ground conductor. You should use a clamp meter to check for current before performing any impedance testing. If you measure above 1 amp you should investigate the source of the current before proceeding.

If you must disconnect an electrode from an electrical system, try to do so during a maintenance shutdown when you can de-energize the system. Otherwise, consider temporarily connecting a backup electrode to the electrical system during your test.

Never disconnect a ground electrode if there is a chance of lightning.

A ground fault in the vicinity can cause voltage rises in the earth. The source of the ground fault may not even be in the facility you are testing, but could cause voltage between the test electrodes. This can be especially dangerous near utility substations or transmission lines where significant ground currents can occur. (Testing grounding systems of transmission towers or substations requires the use of special "Live Earth" procedures and is not covered in this app note.)

Ground impedance testers use much higher energy than your standard multimeter. They can output up to 250 mA. Make sure everyone in the area of the test is aware of this and warn them not to touch the probes with the instrument activated.

## Checking Connection Resistance Leading Up to the Electrode

Before testing the electrode, start by checking its connection to the facility bonding system. Most Fall-of-Potential testers have the ability to measure 2-pole, low ohms and are perfect for the job. You should see less than 1 ohm:

- At the main bonding jumper
- Between the main bonding jumper and the ground electrode conductor
- Between the ground electrode conductor and the ground electrode
- Along any other intermediate connection between the main bonding jumper and the ground electrode

## The Fall-of-Potential Method

The Fall-of-Potential method is the “traditional” method for testing electrode resistance. The procedure is specified in the IEEE-81 standard “Guide for Measuring Earth Resistivity, Ground Impedance and Earth Surface Potentials of a Ground System.” In it’s basic form, it works well for small electrode systems like one or two ground rods. We will also describe the Tagg Slope Technique which can help you draw accurate conclusions about larger systems.

Remember: for this method, the ground electrode must be disconnected from the building electrical service.

### How it works

The Fall-of-Potential method connects to the earth at three places. It is often called the “three-pole method.” You may want to use a fourth lead for precise measurements on low-impedance electrodes, but for our initial discussions we will consider three leads.

The connections are made to:

- E/C1 – the ground electrode being tested
- S/P2 – A voltage (potential) measurement stake driven into the earth some distance away from the electrode. Sometimes called the potential auxiliary electrode
- H/C2 – A current stake driven into the earth a further distance away. Sometimes called the current auxiliary electrode

Figure 3 shows this schematically and Figure 4 shows the three connections made using a typical ground tester.

The ground tester injects an alternating current into the earth between the electrode under test (E) and the current stake (C2). The ground tester measures the voltage drop between the P2 stake and E. It then uses ohms law to calculate the resistance between P2 and E.

To perform the test you position the C2 stake at some distance from the electrode under test. Then, keeping the C2 stake fixed, you move the P2 stake along the line between E and C2, measuring the impedance along the way.

The tricky part comes in determining where to drive the stakes to get a true reading of the resistance between the electrode and the earth. At what point does the dirt surrounding the electrode stop being a contributor of resistance and become the vast earth? Remember that we are not interested in the resistance between the electrode and our stakes. We are trying to measure the resistance that a fault current would see as it passes through the mass of the earth.

The current probe generates a voltage between itself and the electrode under test. Close to the electrode, the voltage is low and becomes zero when the P stake and electrode are in contact.

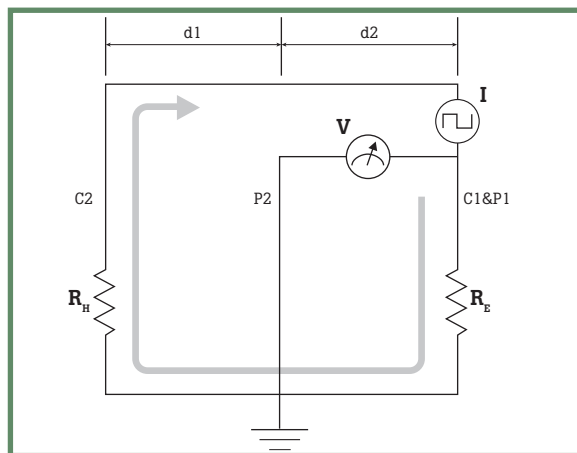

Figure 3: 3-point measurement

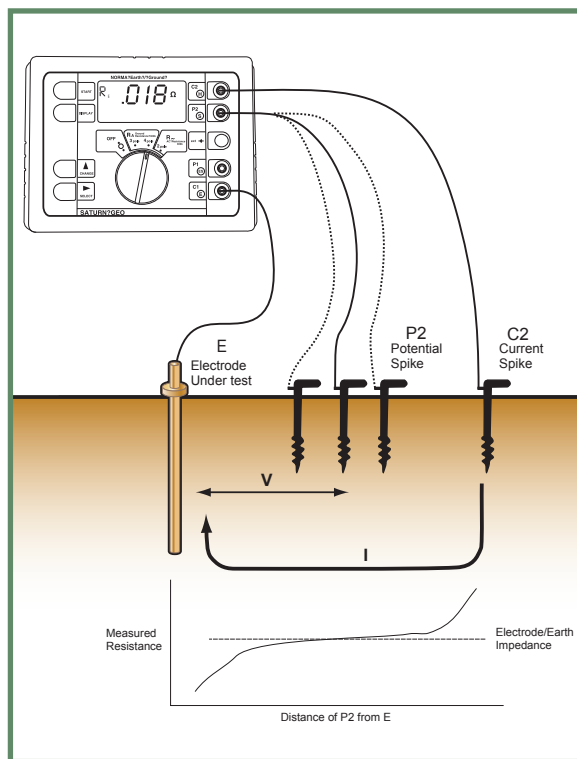

Figure 4: A plot of measured impedances versus position of the potential stake allows us to see the earth impedance

## Measurement Tips

- Bring a good, long tape measure.
- Finding the horizontal part of the curve will require at least 5, but more likely 7 or 9 measurements.
- It's a good idea to take three of your resistance readings with the P2 stake at 20 %, 40 % and 60 % of the distance between E and C2. This will allow you to use the Tagg Slope Technique.
- When placing the stakes make sure the current stake, the potential stake and the electrode under test form a straight line.
- If you get a very high impedance measurement or over-range, try pouring some water around the test stakes to improve their contact to earth. This isn't cheating since our intention is not to measure the resistance of our stakes, but to measure the resistance of the electrode.
- Keep the potential and current leads separated to avoid signal coupling between the two.
- At a new construction site, you may want to take multiple sets of measurements. Resistance may drop over time as the earth settles

Close to the electrode, the potential probe is said to be within the influence of the electrode. Close to the current probe the voltage is almost the full voltage output by the tester. But somewhere in the middle, something interesting happens.

As we move from the influence of the electrodes and into the mass of the earth, the test current no longer causes significant change in potential. If you plot a series of measurements, moving the potential stake away from the electrode under test, and towards the current stake you will notice a flattening of the curve. An ideal curve is shown in Figure 3 (see previous page). **The flattest part of the curve is where we read the earth resistance.** In reality, the curve never goes entirely flat but reaches a very gentle slope where changes in resistance are small.

The extent of the influence of the electrode depends on its depth and its area. Deeper electrodes require that the current stake be driven farther away (see Table 1). For large ground rings, grids or arrays the influence of the electrode may extend for hundreds of feet. Table 2 gives suggested starting points for current and potential stake placement.

Because of the possibility of interaction between an electrode rings, grids or arrays, and the measurement stakes you should not take shortcuts – plot the Fall-of-Potential graph to be sure you are getting accurate results.

In testing a bonded array of electrodes the combined resistance of the array will be less than the lowest reading you measure for any individual electrode. If, for example, you have two 8-foot rods spaced more than 8 feet apart you can be confident that the combined resistance will be substantially less for the combined system.

The three-wire measurement will deliver good results if you use a short C1 lead, or if you don't mind having a fraction of an ohm of lead resistance in your reading. For ground resistance measurements over 10 ohms, the effect of the resistance of the C1 lead will be small. But for very precise measurements, especially at low resistances, a four-wire tester allows you add a fourth lead to eliminate the contribution of the C1 lead. By running a separate potential lead (P1) to the electrode under test you can take the drop along the C1 current lead out of the measurement.

**Table 1: Approximate Distance to Auxiliary Stakes using the 62 % Rule (in feet)**

Depth of Electrode under Test (E)	Distance from E to Potential Stake (P2)	Distance from E to Current Stake (C2)
6	50	82
8	62	100
20	81	131
30	100	161

**Table 2: Approximate Distance to Auxiliary Stakes for Electrode Arrays (in feet)**

Widest Dimension (Diagonal, diameter or Straight-line) of Electrode Array under Test (E)	Distance from E to Potential Stake (P2)	Distance from E to Current Stake (C2)
65	100	165
80	165	265
100	230	330
165	330	560
230	430	655

### The 62 % Rule

You may be able to use a shortcut if your test meets the following criteria:

- You are testing a simple electrode (not a large grid or plate)
- You can place the current stake 100 feet or more from the electrode under test
- The soil is uniform

Under these conditions you can place the current stake 100 feet or more from the electrode under test. Place the potential stake at 62 % of the distance between the current stake and the electrode under test and take a measurement. As a check, take two more measurements: one with the potential probe 3 feet closer to the electrode under test, and one 3 feet farther away (see Figure 5). If you are on the flat portion of the fall-of-potential curve then the readings should be roughly the same and you can record the first reading as your resistance.

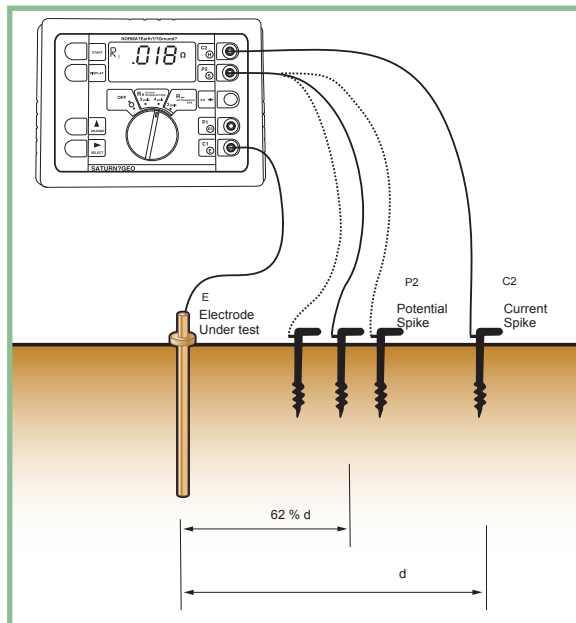

Figure 5: Stake positions for the 62 % rule.

### The Tagg Slope Technique

Large electrodes or grounding systems require some special consideration. If you've plotted resistance readings for nine different P2 locations and there is no clear flattening on your graph, then the Tagg Slope Technique (also called the slope method) can help establish the earth impedance. Figure 6 shows an example dataset for which there is no obvious flat section. This curve is characteristic of a test in which the current and potential probes never get outside the influence of the electrode under test. There can be a number of reasons for a curve like this:

- For electrode systems that cover large areas it may be difficult to place stakes far enough away
- You may not be able to place the C1 stake at the center of the electrode
- The area you have to place stakes may be limited

If you have resistance readings at the 20 %, 40 % and 60 % points between E and C2, then you can apply the procedure to the data you've already taken.

Calculate the slope coefficient ( $\mu$ ) using three resistance measurements from 20 %, 40 % and 60 % of the distance from the electrode under test to the C2 current stake.

$$\mu = \frac{(R_{60\%} - R_{40\%})}{(R_{40\%} - R_{20\%})}$$

Then go to the table in the back of this application note and look up the P2/C2 ratio that corresponds to your  $\mu$ . This will tell you where to look on your graph to ascertain the earth resistance. For the sample data in Figure 6:

$$\mu = \frac{(6.8 - 5.8)}{(5.8 - 4.4)} = 0.71$$

If we go to the table, for  $\mu = 0.71$  the corresponding P2/C2 percentage is 59.6 %. So the approximate earth resistance would be measured at (59.6 % X 300 feet), or at 178 feet. This is very close to our 60 % point at 180 feet, where we read 6.8 ohms. So it would be safe to say the earth resistance for the electrode under test is roughly 7 ohms.

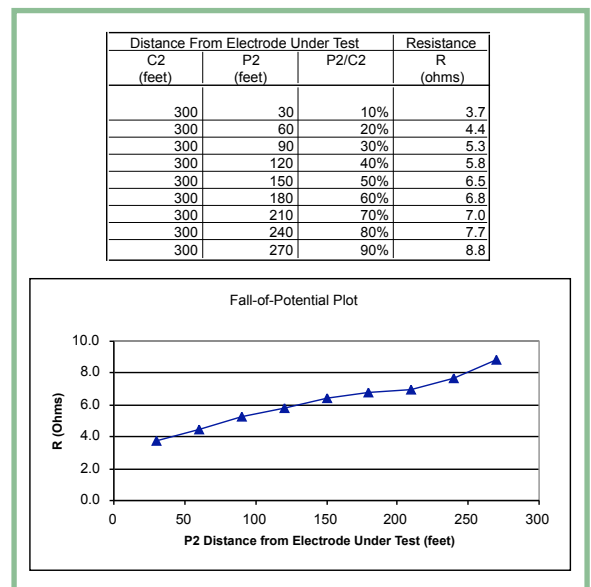

Figure 6: Earth impedance can be found from this curve by using the Tagg Slope Technique

### The Selective Method

The Selective Method is a variation of the Fall-of-Potential method, available on high-end ground testers like the Fluke 1625. Testers with this capability can measure the ground impedance of a specific ground electrode without disconnecting it from an array or from a structure's distribution system. This means you don't have to wait for a shutdown to test or risk the safety hazards of disconnecting the electrode from a live system.

The same rules for current stake and potential stake placement apply as with Fall-of-Potential. If the conditions are met for the 62 % rule (see previous page) then it can help reduce the number of measurements. Otherwise it's a good idea to build a complete Fall-of-Potential plot. You can use the Tagg Slope Technique if your curve does not flatten out.

Both the Fall-of-Potential method and the Selective Method use stakes to inject current and measure voltage drop. The big difference is that selective testing can accurately measure the test current in the electrode under test.

The utility neutral, building steel and ground electrode are all bonded and grounded. When you inject a current into this system of parallel ground connections the current will divide. In a traditional Fall-of-Potential test you have no way of knowing how much current is flowing

between any particular electrode and the C2 current stake. Selective testing uses an integrated, high sensitivity clamp-on current transformer to measure the test current in the electrode under test. Figure 8 shows how the current transformer fits into the test circuit. The selective ground tester digitally filters the current measurement to minimize the effects of stray currents. Being able to accurately measure the current in the electrode under test effectively isolates the electrode and allows us to test it without disconnecting it from the system or from other electrodes.

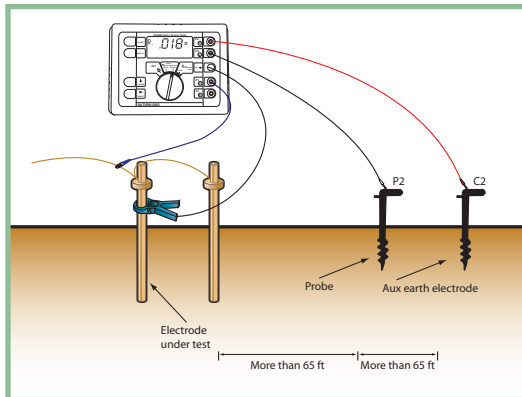

Figure 7: Connections for selective ground electrode measurement

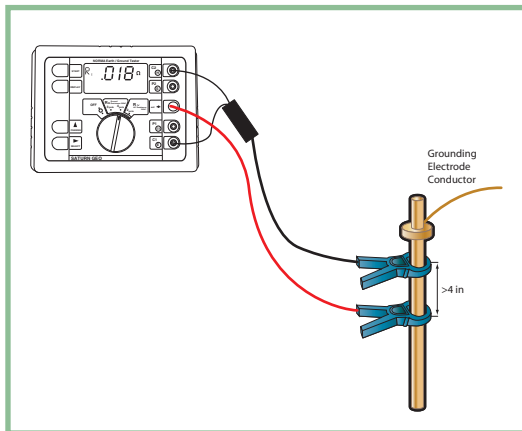

Figure 9: Connecting the Saturn GEO X for a stakeless measurement

### Stakeless or Clamp-on Method

The "stakeless" or "clamp-on" method allows you to measure the impedance of a series loop of ground electrodes. The test is simple and it may be performed on an electrode that is connected to a working electric service.

To make the measurement the tester uses a special transformer to generate a voltage on the ground conductor at a unique test frequency. It uses a second transformer to distinguish the test frequency and measure the resulting current through the circuit.

This method is available in some Fall-of-Potential testers (like the Fluke 1625) or in a single clamp on unit. Figure 9 shows the connection of the source and measure clamps of the Fluke 1625.

Figure 10 (see next page) shows the equivalent test circuit for the stakeless method. When you test a building ground electrode using this method, you are actually testing a loop including:

- Electrode under test
- Ground electrode conductor
- The main bonding jumper
- The service neutral
- Utility neutral-to-ground bond
- Utility ground conductors (between poles)
- Utility pole grounds

Because this method uses the service as part of the circuit, it may be used only after the service has been completely wired, that is, it cannot be used prior to hook-up to the utility. In this method the clamp checks the continuity of the interconnections of all of the components above. An abnormally high reading or an open circuit indication on the instrument points to a poor connection between two or more of the aforementioned critical components.

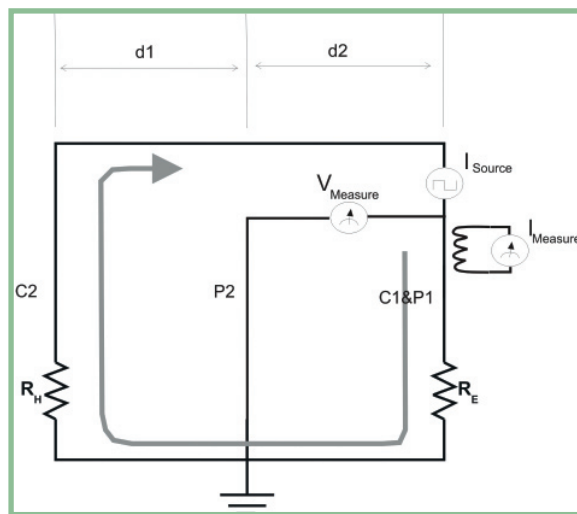

Figure 8: Connections for selective Electrode Impedance Measurement

This method requires a low-impedance path in parallel with the electrode under test. The ground electrode of most facilities is in parallel with numerous utility ground electrodes. These electrodes can be pole electrodes, pole butt plates or un-insulated neutral conductors. The impedance of the utility ground electrodes usually combines into a very low impedance.

Let's take an example. Say you have 40 pole electrodes of roughly 20 Ω each, and these electrodes are connected together by a low-impedance ground wire from pole to pole. The equivalent resistance of the 40 electrodes in parallel is:

$$R_{eq} = \frac{1}{40 \times 1/20\Omega} = 1/2\Omega$$

Since half an ohm is small compared to the resistance we expect for our electrode under test, we can assume that most of the measured resistance is due to the earth resistance of the electrode under test. There are some potential pitfalls for this method:

- If you measure in the wrong place in the system, you might get a hard-wired loop resistance, for example on a ground ring or on a bonded lightning protection system. If you were intending to read earth resistance, measuring the conductive loop would give unexpectedly low resistance readings.
- You may get low readings due to the interaction of two very close, bonded electrodes, like buried conduit, water pipes, etc.
- The quality of the measurement depends on the availability of parallel paths. If a building is solely supplied by a generator or transformer that has only a single electrode, the assumption of multiple paths won't work and the measurement will indicate the earth resistance of both electrodes. This method will not measure earth resistance.
- A problem with the utility grounding system might interfere with readings.

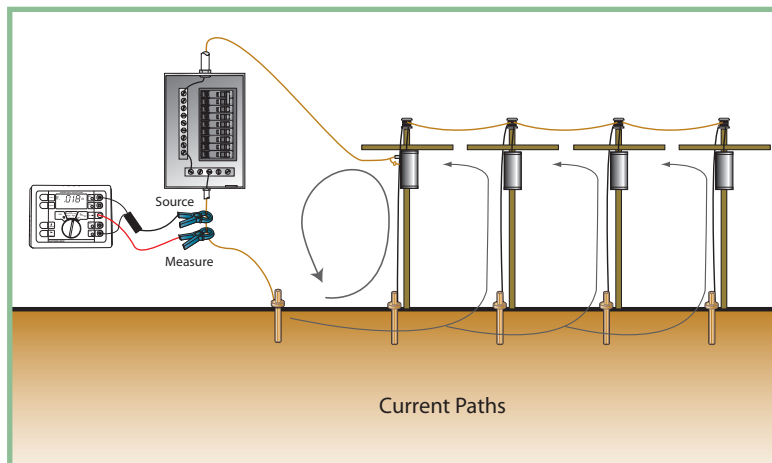

Figure 10: Test current paths in the stakeless method

In general, if you get readings below 1 ohm, double-check to make sure you are not measuring a hard-wired conductive loop instead of the earth resistance.

### Two-pole Method

The two-pole method uses an “auxiliary electrode” such as a water pipe. Figure 11 shows the connections. The tester measures the combined earth resistance of the electrode

under test, the earth resistance of the auxiliary electrode, and the resistance of the measurement leads. The assumption is that the earth resistance of the auxiliary electrode is very low, which would probably be true for metal pipe without plastic segments or insulated joints.

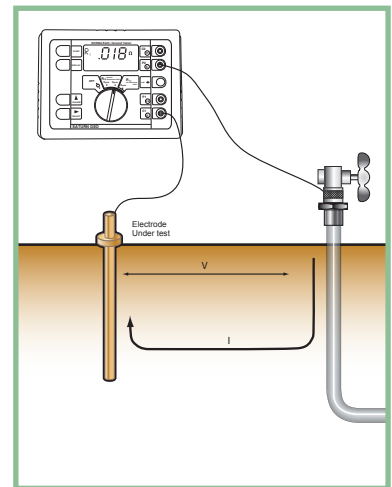

Figure 11: Equivalent circuit for two-point measurement

The effect of the measurement leads may be removed by measuring with the leads shorted together and subtracting this reading from the final measurement.

Although it's convenient, be very careful using the two-pole method:

- A water pipe may have PVC components, which could greatly increase its earth resistance. In this case the two-point method would give an excessively high reading.
- The auxiliary electrode may not be outside the influence of the electrode under test. In this case the reading might be lower than reality.

Because of the unknowns involved in this technique, it is recommended only when the grounding system and auxiliary electrode are well known.

Summary of Ground Electrode Test Methods		
	Advantages	Drawbacks
Fall-of-Potential	<ul style="list-style-type: none"> <li>Widely accepted</li> <li>When you see the characteristic curve you know you've got a good measurement.</li> </ul>	<ul style="list-style-type: none"> <li>You have to disconnect the ground</li> <li>The stakes may not be easy to drive</li> <li>There may not be space around the ground electrode to drive the stakes</li> </ul>
Selective Method	<ul style="list-style-type: none"> <li>Don't have to disconnect electrode</li> <li>Widely accepted</li> <li>When you see the characteristic curve you know you've got a good measurement.</li> </ul>	<ul style="list-style-type: none"> <li>The stakes may not be easy to drive</li> <li>There may not be space around the ground electrode to drive the stakes</li> </ul>
Stakeless Method	<ul style="list-style-type: none"> <li>Convenience</li> </ul>	<ul style="list-style-type: none"> <li>Assumes a low-impedance parallel path</li> <li>Possible to get very low readings by mistakenly measuring on a hard-wired loop</li> </ul>
Two-pole Method	<ul style="list-style-type: none"> <li>Convenience</li> </ul>	<ul style="list-style-type: none"> <li>Impossible to judge the integrity of the "auxiliary electrode."</li> <li>Can't be sure you are outside the area of influence</li> </ul>

**Table for the Tagg Slope Technique (for 2 decimal places)**

$\mu$	P2/C2	$\mu$	P2/C2	$\mu$	P2/C2	$\mu$	P2/C2	$\mu$	P2/C2
	%		%		%		%		%
0.40	64.3	0.65	60.6	0.90	56.2	1.15	50.7	1.40	43.1
0.41	64.2	0.66	60.4	0.91	56.0	1.16	50.4	1.41	42.7
0.42	64.0	0.67	60.2	0.92	55.8	1.17	50.2	1.42	42.3
0.43	63.9	0.68	60.1	0.93	55.6	1.18	49.9	1.43	41.8
0.44	63.7	0.69	59.9	0.94	55.4	1.19	49.7	1.44	41.4
0.45	63.6	0.70	59.7	0.95	55.2	1.20	49.4	1.45	41.0
0.46	63.5	0.71	59.6	0.96	55.0	1.21	49.1	1.46	40.6
0.47	63.3	0.72	59.4	0.97	54.8	1.22	48.8	1.47	40.1
0.48	63.2	0.73	59.2	0.98	54.6	1.23	48.6	1.48	39.7
0.49	63.0	0.74	59.1	0.99	54.4	1.24	48.3	1.49	39.3
0.50	62.9	0.75	58.9	1.00	54.2	1.25	48.0	1.50	38.9
0.51	62.7	0.76	58.7	1.01	53.9	1.26	47.7	1.51	38.4
0.52	62.6	0.77	58.5	1.02	53.7	1.27	47.4	1.52	37.9
0.53	62.4	0.78	58.4	1.03	53.5	1.28	47.1	1.53	37.4
0.54	62.3	0.79	58.2	1.04	53.3	1.29	46.8	1.54	36.9
0.55	62.1	0.80	58.0	1.05	53.1	1.30	46.5	1.55	36.4
0.56	62.0	0.81	57.9	1.06	52.8	1.31	46.2	1.56	35.8
0.57	61.8	0.82	57.7	1.07	52.6	1.32	45.8	1.57	35.2
0.58	61.7	0.83	57.5	1.08	52.4	1.33	45.5	1.58	34.7
0.59	61.5	0.84	57.3	1.09	52.2	1.34	45.2	1.59	34.1
0.60	61.4	0.85	57.1	1.10	51.9	1.35	44.8		
0.61	61.2	0.86	56.9	1.11	51.7	1.36	44.5		
0.62	61.0	0.87	56.7	1.12	51.4	1.37	44.1		
0.63	60.9	0.88	56.6	1.13	51.2	1.38	43.8		
0.64	60.7	0.89	56.4	1.14	50.9	1.39	43.4		

**Fluke.** Keeping your world up and running.®

**Fluke Corporation**  
PO Box 9090, Everett, WA USA 98206

**Fluke Europe B.V.**  
PO Box 1186, 5602 BD  
Eindhoven, The Netherlands

**For more information call:**  
In the U.S.A. (800) 443-5853 or  
Fax (425) 446-5116  
In Europe/M-East/Africa +31 (0) 40 2675 200 or  
Fax +31 (0) 40 2675 222  
In Canada (800)-36-FLUKE or  
Fax (905) 890-6866  
From other countries +1 (425) 446-5500 or  
Fax +1 (425) 446-5116  
Web access: <http://www.fluke.com>

©2005-2007 Fluke Corporation. All rights reserved.  
Specifications subject to change without notice.  
Printed in U.S.A. 3/2007 2550440 A-EN-N Rev C