



DeltaSpan™

General Purpose Water Small Bore or Wastewater Pressure Level Transmitter LD34 and LD35 Series Manual



LD34 Series Shown

LD35 Series Shown

Flowline, Inc.
10500 Humbolt Street
Los Alamitos, CA 90720
Tel: (562) 598-3015
Fax: (562) 431-8507
www.flowline.com

The DeltaSpan™ LD34 Series General Purpose Water Small Bore or LD35 Series General Purpose Wastewater Level Transmitters are manufactured for years of trouble free service. The pressure transmitter measures the height of liquid above the position in the tank referenced to atmospheric pressure. Lightning and surge protection (not guaranteed or covered by standard warranty) is included standard to stand up in harsh applications. The transmitters are vented for barometric pressure compensation. Vent is covered with a maintenance-free filter preventing particulate or water droplets from entering the transmitter. For extra protection against humidity we offer the LD90-3000 desiccant filter that can be attached to the vent tube.

Applications

- LD34 Series
 - Ballast tanks; Ground water monitoring; Surface water monitoring; Dewatering; Down hole; Remediation and other environmental monitoring applications.
- LD35 Series
 - Sewage lift stations, industrial slurries, industrial sumps, landfill leach ate, reservoirs, sludge pits, oil tanks, etc. reservoirs, sludge pits, oil tanks, etc.

Table of Contents

Specifications: 3

Dimensions..... 4

Safety Precautions: 5

Components:..... 6

Getting Started..... 7

 How to convert Pressure into Liquid Height?..... 7

 How does Specific Gravity affect pressure transmitters? 8

 How to select the correct pressure transmitter? 9

 How to configure a panel meter when a pressure transmitter is used?..... 10

Electrical Installation..... 11

Wiring 12

 Wiring to a Loop Powered Display:..... 12

 Wiring to a Generic PLC: 12

 Wiring to the DataView™ LI55 Series Level Controller:..... 12

 Wiring to the Commander™ LI90 Series Multi-Tank Level Controller:..... 12

 Wiring to the DataPoint™ LC52 Series Level Controller: 13

 Wiring to a DataLoop™ LI25 Series Level Indicator without the Backlight: 13

 Wiring to a DataLoop™ LI25 Series Level Indicator with the Backlight: 13

Installation 14

 Interference 14

 Termination..... 14

Maintenance 15

 Testing the transmitter 15

Warranty 16

Service:	Compatible liquids
Wetted Materials:	Sensor: 316 SS Cable: Polyurethane or ETFE Seals: Fluoroelastomer Diaphragm: PTFE coated FKM fluoroelastomer (LD35 series only) Label: Polyethylene polyamide
Accuracy:	±0.25% of full scale
Temperature Limit:	-4 to 176°F (-20 to 80°C)
Compensated Temperature Limits:	LD34 series: 0 to 158°F (-18 to 70°C) LD35 series: 32 to 140°F (0 to 60°C)
Thermal Effect:	LD34 series: ±0.45% FS TEB LD35 series: ±0.0075%/°F (±0.0135%/°C)
Pressure Limit:	2X full scale
Power Requirement:	10 to 33 VDC
Output Signal:	4 to 20 mA DC, 2-wire
Response Time:	< 50 ms
Max. Loop Resistance:	1000 ohms @ 30 VDC
Electrical Connections:	Wire pigtail
Cable Length:	- __01/-__11: 40' (12.2 m) - __21/-__31: 60' (18.3 m)
Mounting Connection:	Suspended below point being monitored
Electrical Protection:	Surge/lightning protected per EN61000-4-5, Class 5
Sensor Weight:	LD34 Series: Sensor: 0.235 lb (0.107 kg) LD35 Series: Sensor: 0.3 lb (0.136 kg) All: Cable: 0.037lb (0.009 kg) per foot
Classification:	General Purpose
Compliance:	CE

Technology: A sealed pressure transmitter is placed near or on the bottom of the tank. A stainless steel pressure diaphragm within the pressure transmitter is exposed on one side to the application liquid. The other side is exposed to the reference pressure via a small ventilation tube located inside of the Polyurethane cable. A difference in pressure between liquid and reference pressures will slightly deflect the diaphragm. The deflection of the diaphragm is measured by a built-in microprocessor that provides greater linearity correction over common thermal compensation methods. A 4-20 mA current signal proportional the height of the liquid is generated from the microprocessor.

LD34 Series

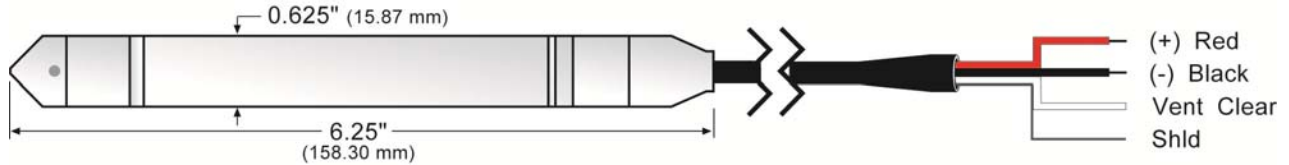

LD35 Series

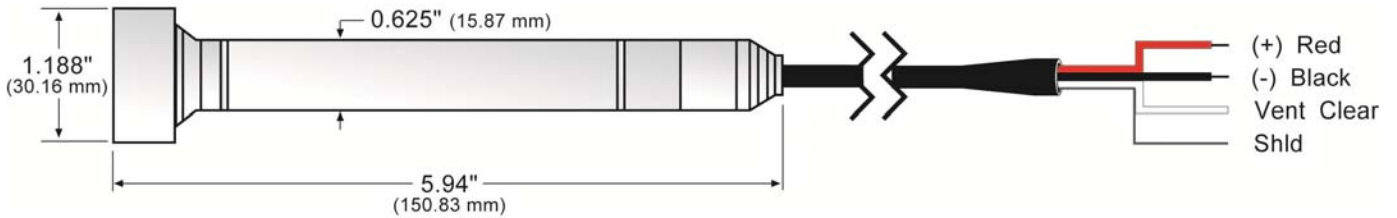

Material Compatibility

- The LD34 / LD35 series is made of 316 Stainless Steel (316 SS) with a cable of Polyurethane or Ethylene Tetrafluoroethylene (ETFE). **The LD35 series has a PTFE coated FKM fluoroelastomer face.**
- Make sure that the switch is compatible with the application liquids. To determine the chemical compatibility between the sensor and its application liquids, refer to the Compass Corrosion Guide, available from Compass Publications (858-589-9636).

Optional Desiccant Filter (LD90-3000): For extra protection against humidity we offer the LD90-3000 desiccant filter that can be attached to the vent tube.

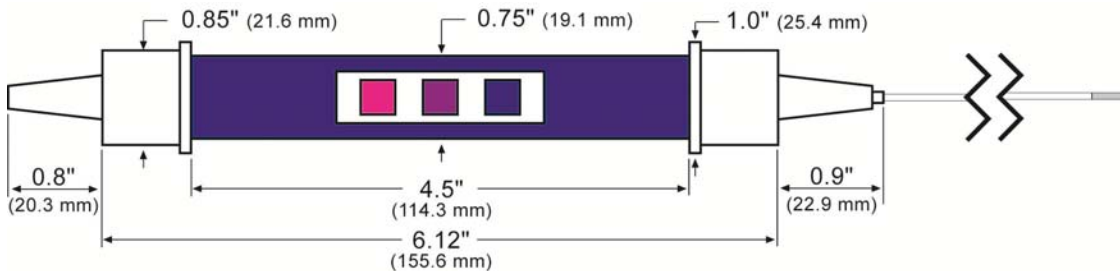

- ⚠ **About this Manual:** PLEASE READ THE ENTIRE MANUAL PRIOR TO INSTALLING OR USING THIS PRODUCT. This manual includes information on all versions of the DeltaSpan™ Series Pressure Level Transmitter from Flowline; series LD34-S___ and LD35-S___. Please refer to the part number located on the transmitter label to verify the exact model which you have purchased.
- ⚠ **User's Responsibility for Safety:** Flowline manufactures a wide range of liquid level sensors and technologies. While each of these technologies are designed to operate in a wide variety of applications, it is the user's responsibility to select a technology that is appropriate for the application, install it properly, perform tests of the installed system, and maintain all components. The failure to do so could result in property damage or serious injury.
- ⚠ **Proper Installation and Handling:** Only properly-trained staff should install and/or repair this product. Use a proper sealant with all installations. Always check for leaks prior to system start-up.
- ⚠ **Wiring and Electrical:** **CAUTION:** Do not exceed specified supply voltage rating of 33 VDC. Permanent damage not covered by warranty will result. This device is not designed for 120 or 240 volt AC operation. Use only on 10 to 33 VDC.
- ⚠ **Temperature and Pressure:** The LD34 and LD35 series are designed for use in application temperatures from -20° to 80°C (-4° to 176°F). Both series are designed for use at pressures up to 2 x the full span.
- ⚠ **Material Compatibility:** Both series are made of 316 Stainless Steel (316 SS) with a cable of Polyurethane or Ethylene Tetrafluoroethylene (ETFE). The LD35 series has a sensor face of PTFE coated FKM fluoroelastomer. Make sure that the model which you have selected is chemically compatible with the application liquids.
- ⚠ **Flammable, Explosive and Hazardous Applications:** **DO NOT USE THE DELTASPAN™ LD34 or LD35 SERIES LEVEL TRANSMITTER IN HAZARDOUS LOCATIONS.**
- ⚠ **Make a Fail-Safe System:** Design a fail-safe system that accommodates the possibility of transmitter failure or battery power loss. In critical applications, Flowline recommends the use of redundant backup systems and alarms in addition to the primary system.

DeltaSpan™ is offered in different models, based upon pressure rating and cable material. Depending on the model purchased, you may or may not have been shipped all the components shown below.

• **DeltaSpan™ Submersible (LD34 Series)**

Part Number	Maximum Pressure	Range in Water Column	Cable Length	Cable Material
LD34-S101	5.0 psi	11.54 ft wc (3.52 m wc)	40' (12.2 m)	Polyurethane
LD34-S111	6.5 psi	15.0 ft wc (4.6 m wc)	40' (12.2 m)	
LD34-S121	8.6 psi	20.0 ft wc (6.1 m wc)	40' (18.3 m)	
LD34-S131	13.0 psi	30.0 ft wc (9.1 m wc)	40' (18.3 m)	
LD34-S141	21.6 psi	50.0 ft wc (15.2 m wc)	70' (12.2 m)	
LD34-S151	43.3 psi	100.0 ft wc (30.5 m wc)	120' (12.2 m)	

• **DeltaSpan™ Waste Water (LD35 Series)**

Part Number	Maximum Pressure	Range in Water Column	Cable Length	Cable Material
LD35-S101	5.0 psi	11.55 ft wc (3.5 m wc)	40' (12.2 m)	Polyurethane
LD35-S111	6.5 psi	15.0 ft wc (4.6 m wc)		
LD35-S121	8.6 psi	20.0 ft wc (6.1 m wc)		
LD35-S131	13.0 psi	30.0 ft wc (9.1 m wc)		
LD35-S201	5.0 psi	11.55 ft wc (3.5 m wc)	40' (12.2 m)	ETFE
LD35-S211	6.5 psi	15.0 ft wc (4.6 m wc)		
LD35-S221	8.6 psi	20.0 ft wc (6.1 m wc)		
LD35-S231	13.0 psi	30.0 ft wc (9.1 m wc)		

• **Quick Start Guide**

• **Vent Filter**

- Located on the end of the Vent Tube
- If the application requires the vent tube to be cut to length, then remove the vent filter and place on the end of the new end of the vent tube.

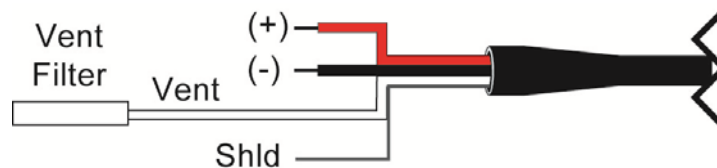

• **Desiccant Filter (Optional)**

- For extra protection against humidity we offer the LD90-3000 desiccant filter that can be attached to the vent tube.

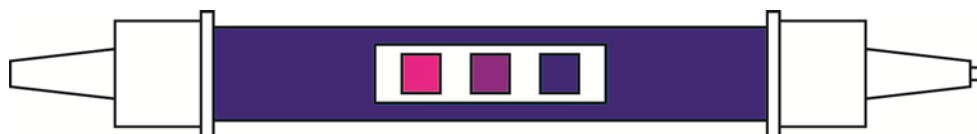

Pressure transmitters are designed to be submersed within the application fluid. The transmitters can either rest along the bottom of the tank or be suspended at any desired level within the tank. Please note that the physical location of the level transmitter will indicate the lowest level of measurement within the tank. For example: mounting the transmitter 1 foot from the bottom of the tank, then the lowest reading of liquid will be 1 foot from the bottom.

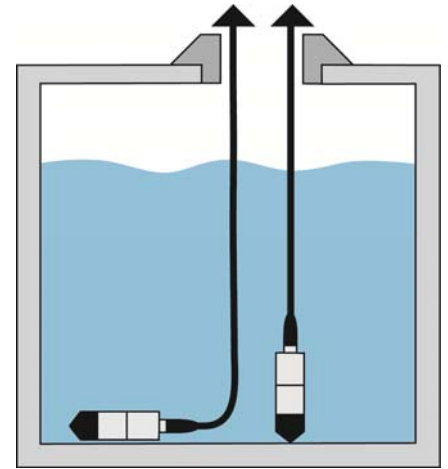

How to convert Pressure into Liquid Height?

Pressure transmitters are all describe by the pressure range and not by liquid height. To convert pressure to **liquid height**, use the following ratio:

$$1 \text{ psi} = 2.31 \text{ feet of water}$$

or

$$1 \text{ psi} = 0.704 \text{ meters of water}$$

- Therefore, a **15 psi** transmitter will have a **liquid height = 34.65 feet (10.56 m)**:

$$15 \text{ psi} \times 2.31' / \text{psi} = 34.65'$$

or

$$15 \text{ psi} \times 0.704 \text{ m/psi} = 10.56 \text{ m}$$

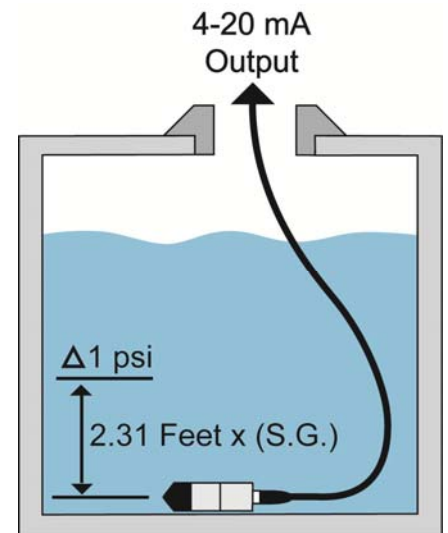

With the above ratio, you can always find the liquid height or water column (wc) of any pressure transmitter.

How does Specific Gravity affect pressure transmitters?

The Specific Gravity (SG) of a liquid will not change the pressure of the transmitter, but will affect how the transmitter reads the liquid height. Remember, liquids with a SG < 1.0 are lighter than water and liquids with a SG > 1.0 are heavier than water.

- Water has a SG = 1.0.
- A SG < 1.0 requires more liquid (a taller water column) to equal the same pressure as with water.
- A SG > 1.0 requires less liquid (shorter water column) to equal the same pressure as with water.

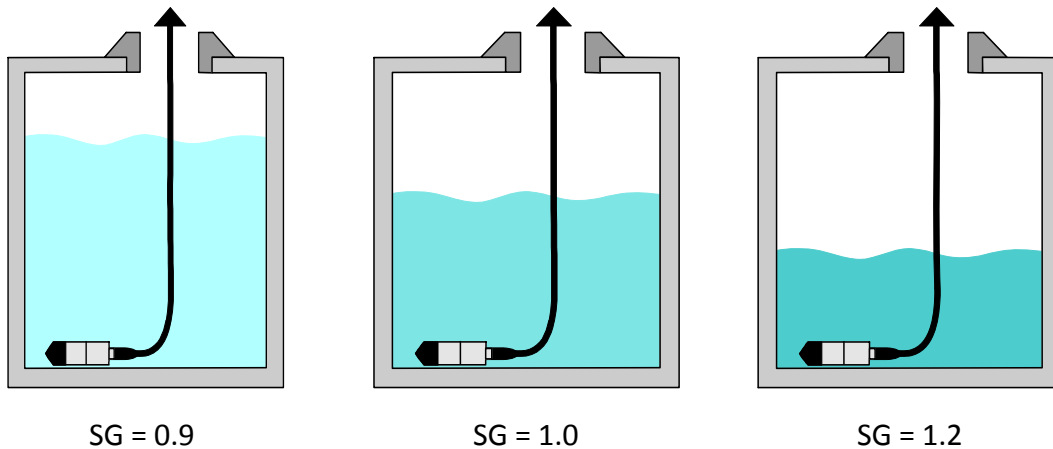

To calculate the **Maximum Liquid Height** of a sensor, use the following formula:

$$\text{Maximum Liquid Height (feet)} = (\text{Pressure Range} \times 2.31) / \text{SG}$$

$$\text{Maximum Liquid Height (meters)} = (\text{Pressure Range} \times 0.704) / \text{SG}$$

Example: **15 psi** transmitter installed in a liquid with a **SG=0.9** will have a

$$\text{Maximum Liquid Height} = 38.5 \text{ feet (11.73 m)} \text{ or } [(15 \text{ psi} \times 2.31' / \text{psi}) / 0.9 = 38.5']$$

Note: The above formula will always provide the **Maximum Liquid Height** for any pressure transmitter.

Example: Compare the **Maximum Liquid Height** of a liquid with a SG = 0.9 to one with a SG = 1.0.

- SG = 0.9: a 15 psi transmitter will have a **Maximum Liquid Height = 38.5' (11.73 m)**
- SG = 1.0: a 15 psi transmitter will have a **Maximum Liquid Height = 34.65' (10.56 m)**

A change in SG of 0.1 will increase the **Maximum Liquid Height** of a transmitter by **3.83' (1.2 m)**. Thus, when the Specific Gravity is less than 1.0, the **Maximum Liquid Height** of the transmitter will increase.

The reverse is true by increasing the Specific Gravity. With a SG = 1.2, the **Maximum Liquid Height = 28.88' (8.80 m)** with a 15 psi transmitter

$$\text{Maximum Liquid Height (28.88')} = (\text{Pressure Range (15 psi)} \times 2.31) / \text{SG (1.2)}$$

Compare to a liquid with a SG = 1.0, the Maximum Liquid Height will decrease by 5.77' (1.8 m). When the Specific Gravity is greater than 1.0, the **Maximum Liquid Height** of the transmitter will decrease.

Note: Identifying the correct specific gravity for the fluid is critical in understanding the operational range of the pressure transmitter.

How to select the correct pressure transmitter?

The objective is to select a sensor with an operational range that will cover the entire application span. If the liquid height of the tank is above the sensor's **Maximum Liquid Height**, then the sensor will not be able to read a full tank level. Compare the tank's **Pressure @ Full** against the sensor's pressure range to select a sensor.

To calculate the tank's **Pressure @ Full**, use the following formula:

$$\text{Pressure @ Full} = [\text{Height @ Full Tank (feet)} \times \text{SG}] / 2.31 \text{ (feet/psi)}$$

$$\text{Pressure @ Full} = [\text{Height @ Full Tank (meters)} \times \text{SG}] / 0.704 \text{ (m/psi)}$$

To select the correct pressure transmitter, follow the steps below:

- Measure the Height @ Full Tank (in feet or meters).
- Determine the SG for the liquid (if the customer does not know, check the MSDS sheet).
- Use the formula above to calculate the **Pressure @ Full**.
 - a. Example: A 40' tank with a liquid media SG of 0.9 has a **Pressure @ Full** of 15.58 psi.
 - b. $[(40' \times 0.9) / 2.31' / \text{psi}] = 15.58 \text{ psi}$**
- Select a pressure transmitter with a pressure greater than or equal to the **Pressure @ Full**.
 - a. In the example above for a 40' tall tank with a SG=0.9, you need a pressure range greater than or equal to 15.58 psi.
 - b. Using a sensor with a pressure range of 20 psi provides a Maximum Liquid Height of 51.33', which will read the entire range of the 40' tall tank.
 - c. Using a sensor with a pressure range of 15 psi provides a Maximum Liquid Height of 38.50', which is short by 1.5'.
 - i. This means that the sensor will output 20 mA at 38.5' of liquid and the top 1.5' of liquid will not be measured.

How to configure a panel meter when a pressure transmitter is used?

This method works with the LI55 series, LI25 Series, LI10 Series and LI50 Series. These panel meters are configured using the SCALE function. The SCALE function typically has four settings. These settings are as follows:

Settings	Default	Represents	Typical Setting
Input 1	04.000	Input current @ Empty	04.000 (mA)
Display 1 (Empty)	04.000	Display value @ Empty	Empty value
Input 2	20.000	Input current @ Full	20.000
Display 2 (Full)	20.000	Display value @ Full	Full Value (mA)

Remember, pressure transmitters are configured so 0 psi = 4 mA and the maximum psi = 20 mA. Most pressure transmitter applications will not use the full range of the transmitter and requires you to proportionally scale the current output of the pressure transmitter. Therefore, a full tank will typically have a current less than 20 mA. The goal in configuring the panel meter is to calculate the current when the tank is full. To do this, use the following formula:

$$(Full\ Tank\ Height / Maximum\ Liquid\ Height) \times 16 + 4 = Current\ at\ Full$$

Example: A 40 foot tank with a SG = 0.9 will have a maximum pressure of 15.58 psi. A 20 psi sensor is selected for use. The **Maximum Liquid Height = (20 psi x 2.31'/psi) / 0.9 = 51.33 feet**. Using the above formula, the **Current at Full = [(40 feet / 51.33 feet) x 16 + 4] = 16.468 mA**.

The **Current at Full** will be used as the Input 2 value. This means that when the display reads a current equal to **Current at Full**, it will display the Full value (Display 2 value). The panel meter will be configured as follows:

Settings	Configured
Input 1	04.000
Display 1	Empty
Input 2	16.468
Display 2	Full

Note: The values for empty and full represent what the display will show when the tank is either Empty or Full. Empty and Full must be the same units (example: Gallons, Inches, percent).

- The default for the Input 1 is 4 mA and typically will never be changed.
- Typically, the Empty setting will be what is in the tank when it is empty (example: 000.0 Gallons, 000.0 inches, 000.0 feet etc.).
- The Full setting will be what is in the tank when it is full (example: 500.0 Gallons, 120.0 inches, 10.0 feet, etc.).

Wire Length - The maximum length of wire connecting the transmitter and receiver is a function of wire size and receiver resistance. Wiring should not contribute more than 10% of the receiver resistance to total loop resistance. For extremely long runs (over 1000 feet), choose receivers with higher resistance to minimize the size and cost of connecting leads. Where wiring length is less than 100 feet, wire as small as 22 AWG can be used.

Wiring - An external power supply delivering 13-30 VDC for the LD31 and LD32 series with minimum current capability of 40 mA DC (per transmitter) is required to power the control loop. See Fig. A for connection of the power supply, transmitter and receiver. The range of appropriate receiver load resistance (RL) for the DC power supply voltage available is expressed by the formula:

$$RL_{max} = (V_{sup} - 10V) / 20 \text{ mA DC}$$

Shielded cable is recommended for control loop wiring. Use the Red wire as the (+) and the Black wire as the (-).

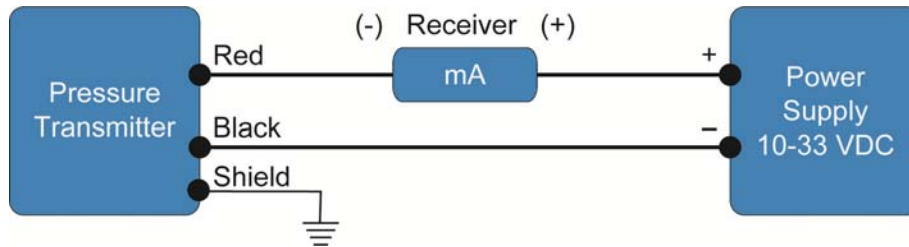
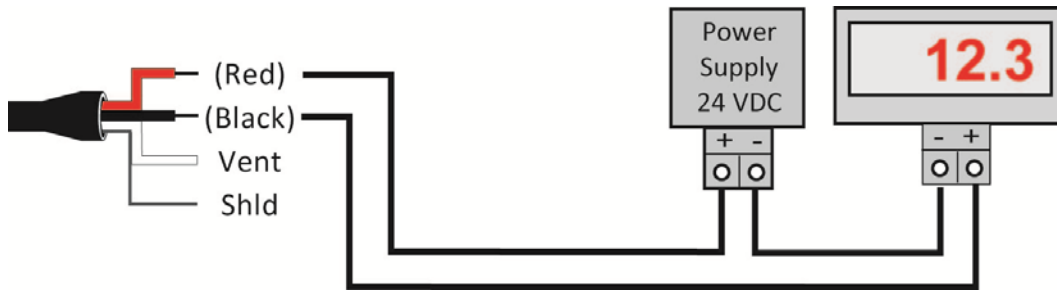

Fig. A

Black Wire is negative (-) and Red Wire is positive (+).

Wiring to a Loop Powered Display:



Wiring to a Generic PLC:

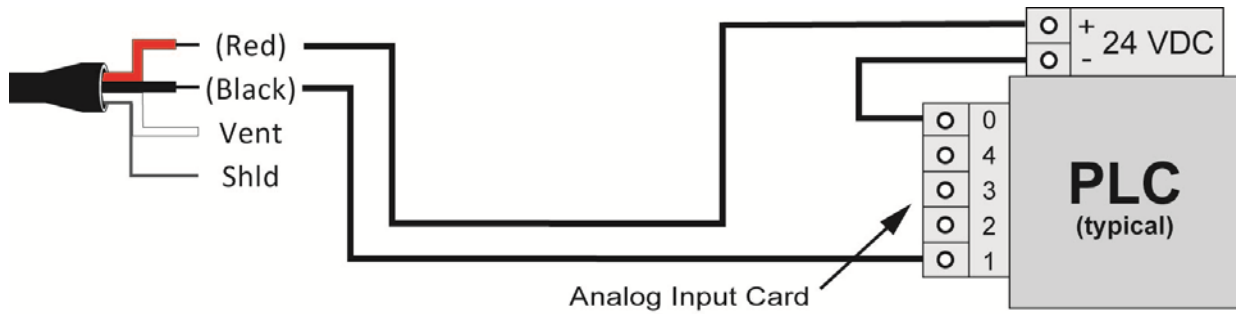

Wiring to the DataView™ LI55 Series Level Controller:

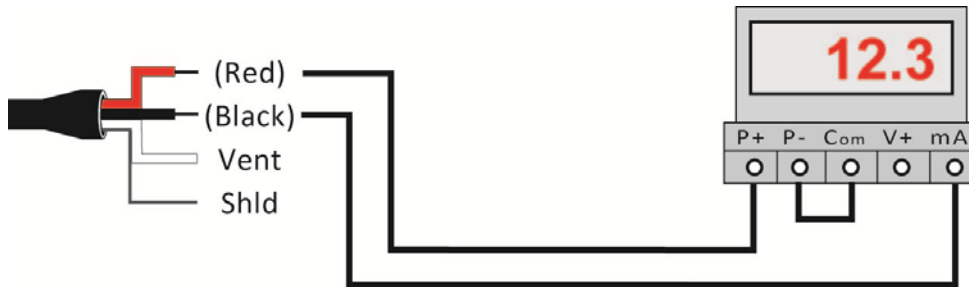

Wiring to the Commander™ LI90 Series Multi-Tank Level Controller:

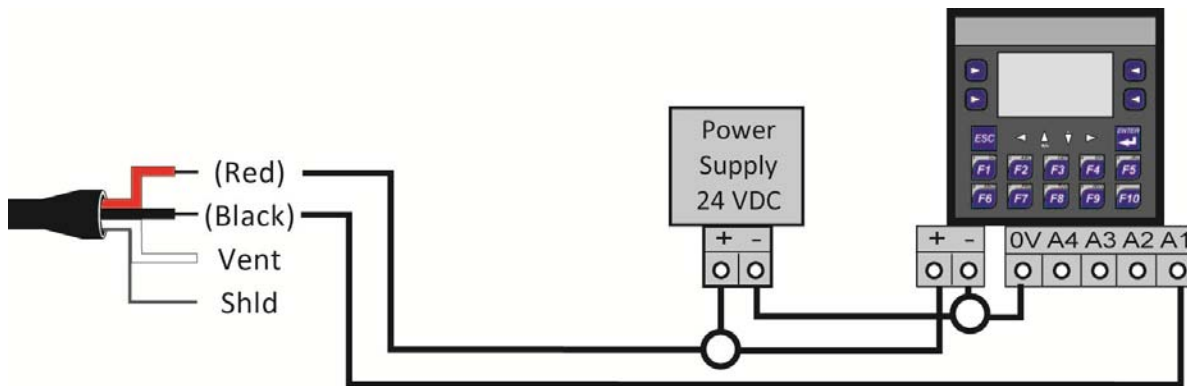

Wiring to the DataPoint™ LC52 Series Level Controller:

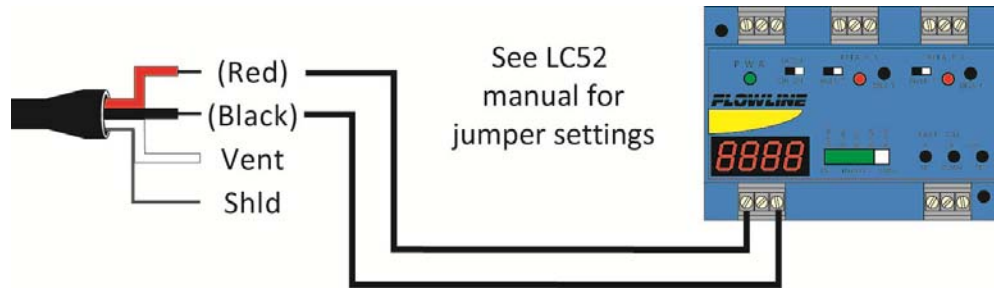

JWA mode (Factory Setting)

Wiring to a DataLoop™ LI25 Series Level Indicator without the Backlight:

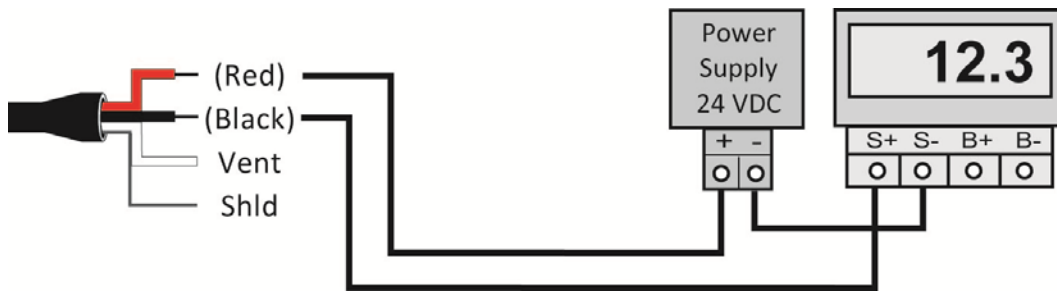

(Note: the LI25 series without backlight will have an added 2 VDC voltage drop)

Wiring to a DataLoop™ LI25 Series Level Indicator with the Backlight:

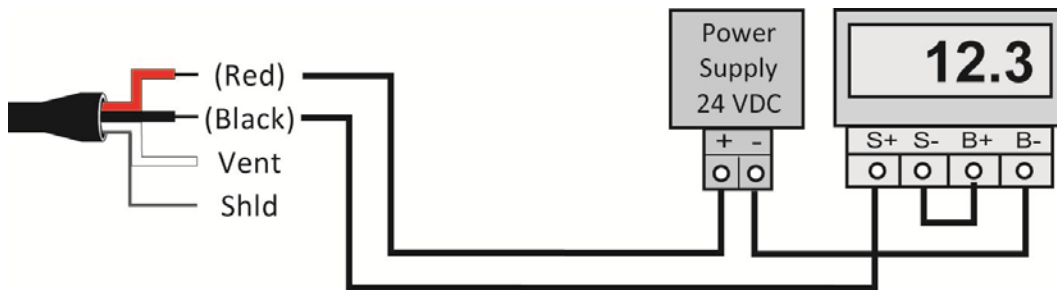

(Note: the LI25 series without backlight will have an added 5.7 VDC voltage drop)

The LD34 / LD35 series are designed to operate while submerged in the actual application liquid. Avoid installing the level transmitter along the bottom of the tank as materials such as sludge will build up and coat/cover the transmitter. This also includes any debris that will settle along the bottom of the tank. In these applications, it is best to suspend the transmitter above the highest level of sludge/debris that will occur.

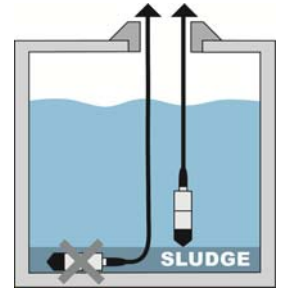

- 1. Location:** Select a location where the temperature of the transmitter will be between 0 and 176°F (-18 to 80°C). Distance from the receiver is limited only by total loop resistance.
- 2. Position:** The transmitter is not position sensitive. However all standard models are originally calibrated with the unit in a position with the pressure connection downward. Although they can be used at other angles, for best accuracy it is recommended that units be installed in the position calibrated at the factory.
- 3. Mounting:** The transmitter can be mounted via several methods. It can be suspended from the electrical cable, or it can be placed resting on the bottom of the tank in either horizontal or vertical orientation.

Interference: The DeltaSpan™ is designed to operate under the surface of the liquid in the tank. Avoid installations where other tank requirements will cause the transmitter to move or swing. For example: a mixer blade could cause the level transmitter to whip around within the tank. An alternative would be to move the transmitter to a more stable section of the tank or to install the LD34/LD35 series inside a still well/drop tube. The still well/drop pipe will minimize the effects created by the mixer.

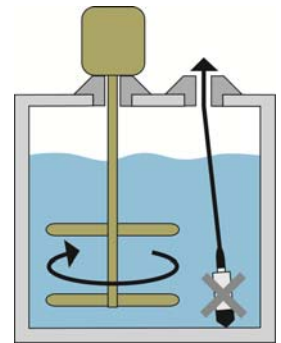

Termination: The cable for the DeltaSpan™ is typically terminated at a junction box located on top of the tank. Since the vent tube is contained within the cable, the pressure within the junction box must always be the same as the reference (typically atmospheric) pressure for the liquid. The inside of the junction box must be clean, dry and free of moisture. Add the optional pressure fitting (LD90-_001) to complete the package. The LD90-_001 features a 2" NPT thread for mounting and a liquid tight connector to seal the cable interface.

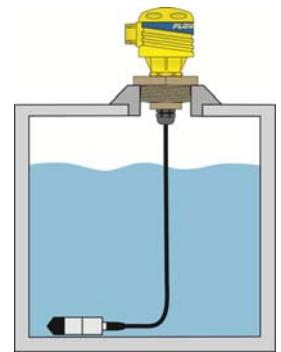

Note: Use caution when sealing the cable at the top of the tank. The ventilation tube must be open and free to allow air to flow back to the pressure diaphragm. Avoid blocking the ventilation tube by compressing the cable. Always keep the cable termination clean, dry and free of moisture and prevent liquid from entering the vent tube.

Note: A vent Filter is provided on the end of the vent tube. If the application requires the vent tube to be cut to length, then remove the vent filter and place on the end of the new end of the vent tube.

Note: For extra protection against high humidity environments, Flowline offers the LD90-3000 desiccant filter that can be attached to the vent tube.

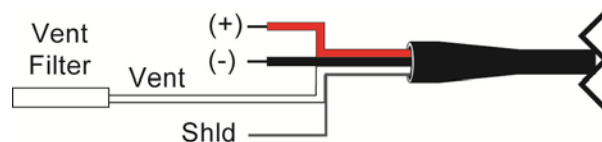

After final installation of the pressure transmitter and its companion receiver, no routine maintenance is required. A periodic check of system calibration is suggested. The pressure transmitters are not field repairable and should be returned if repair is needed (field repair should not be attempted and may void warranty). Be sure to include a brief description of the problem plus any relevant application notes. Contact customer service to receive a return goods authorization number before shipping.

Maintenance should consist of inspection to see that the transmitter is free from debris and not coated with any substance, which would prevent liquid from freely entering and leaving the transmitter. If this occurs, the transmitter should be cleaned.

Testing the transmitter:

- First, verify that the sensor is wired correctly.
- Next, check if the power supply is providing the required power.
- Finally confirm that the loop resistance is not exceeding the sensor's specification.

If transmitter is not functioning properly, isolate the transmitter from the system and wire as shown below. **Be sure to remove the sensor from the classified area when performing this test.** Multimeter should read 4 mA with the transmitter out of liquid.

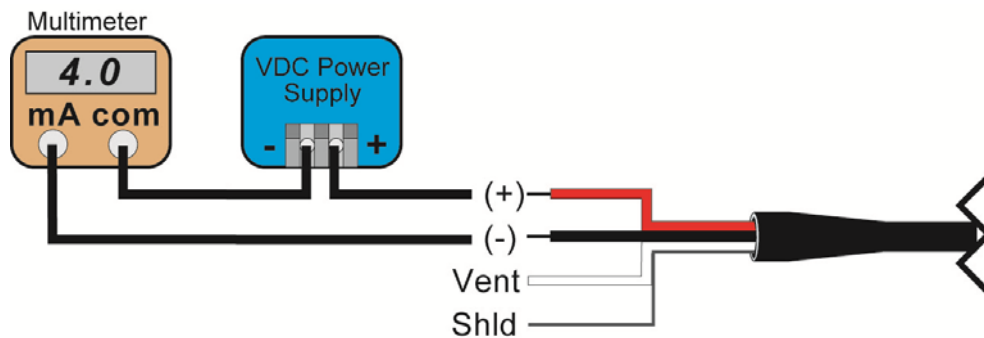

Warranty

Flowline warrants to the original purchaser of its products that such products will be free from defects in material and workmanship under normal use and service in accordance with instructions furnished by Flowline for a period of two years from the date of manufacture of such products. Flowline's obligation under this warranty is solely and exclusively limited to the repair or replacement, at Flowline's option, of the products or components, which Flowline's examination determines to its satisfaction to be defective in material or workmanship within the warranty period. Flowline must be notified pursuant to the instructions below of any claim under this warranty within thirty (30) days of any claimed lack of conformity of the product. Any product repaired under this warranty will be warranted only for the remainder of the original warranty period. Any product provided as a replacement under this warranty will be warranted for the full two years from the date of manufacture.

Returns

Products cannot be returned to Flowline without Flowline's prior authorization. To return a product that is thought to be defective, go to www.flowline.com, and submit a customer return (MRA) request form and follow the instructions therein. All warranty and non-warranty product returns to Flowline must be shipped prepaid and insured. Flowline will not be responsible for any products lost or damaged in shipment.

Limitations

This warranty does not apply to products which: 1) are beyond the warranty period or are products for which the original purchaser does not follow the warranty procedures outlined above; 2) have been subjected to electrical, mechanical or chemical damage due to improper, accidental or negligent use; 3) have been modified or altered; 4) anyone other than service personnel authorized by Flowline have attempted to repair; 5) have been involved in accidents or natural disasters; or 6) are damaged during return shipment to Flowline. Flowline reserves the right to unilaterally waive this warranty and dispose of any product returned to Flowline where: 1) there is evidence of a potentially hazardous material present with the product; or 2) the product has remained unclaimed at Flowline for more than 30 days after Flowline has dutifully requested disposition. This warranty contains the sole express warranty made by Flowline in connection with its products. ALL IMPLIED WARRANTIES, INCLUDING WITHOUT LIMITATION, THE WARRANTIES OF MERCHANTABILITY AND FITNESS FOR A PARTICULAR PURPOSE, ARE EXPRESSLY DISCLAIMED. The remedies of repair or replacement as stated above are the exclusive remedies for the breach of this warranty. IN NO EVENT SHALL FLOWLINE BE LIABLE FOR ANY INCIDENTAL OR CONSEQUENTIAL DAMAGES OF ANY KIND INCLUDING PERSONAL OR REAL PROPERTY OR FOR INJURY TO ANY PERSON. THIS WARRANTY CONSTITUTES THE FINAL, COMPLETE AND EXCLUSIVE STATEMENT OF WARRANTY TERMS AND NO PERSON IS AUTHORIZED TO MAKE ANY OTHER WARRANTIES OR REPRESENTATIONS ON BEHALF OF FLOWLINE. This warranty will be interpreted pursuant to the laws of the State of California. If any portion of this warranty is held to be invalid or unenforceable for any reason, such finding will not invalidate any other provision of this warranty.

For complete product documentation, video training, and technical support, go to www.flowline.com.

For phone support, call 562-598-3015 from 8am to 5pm PST, Mon - Fri.

(Please make sure you have the Part and Serial number available.)