

Inverter Support Software  
**FRENIC Loader 3.3**

**(FRENIC-Mini(C1S/C2S)/Eco/Multi/Ace/MEGA/HF)**

**Instruction Manual**

Copyright © 2008-2014 Fuji Electric Co., Ltd.

No part of this publication may be reproduced or copied without prior written permission from Fuji Electric Co., Ltd.

Microsoft and Windows are registered trademarks of Microsoft Corporation in the United States. All other products and company names mentioned in this manual are trademarks or registered trademarks of their respective holders.

The information contained herein is subject to change without prior notice for improvement.

# Preface

This manual provides all the information on Fuji's inverter support software FRENIC Loader and the related communications protocols and devices supporting its operations.

Read this manual carefully for correct use of FRENIC Loader.



This manual does not contain information on the inverter itself and RS-485 communication. Read the inverter user's manual, instruction manual, and RS-485 communication user's manual in conjunction with this manual.

Incorrect handling may prevent Loader from operating correctly, shorten the inverter service life, or cause problems.

## ■ Safety Precautions

Read this manual thoroughly before proceeding with installation, connections (wiring), or operation. Ensure you have sound knowledge of the device and software and have familiarized yourself with all safety information and precautions before proceeding to operate the inverter via FRENIC Loader.

Safety precautions are classified into the following two categories in this manual.

 <b>WARNING</b>	Failure to heed the information indicated by this symbol may result in death or serious injury.
 <b>CAUTION</b>	Failure to heed the information indicated by this symbol may result in minor or light injury and/or substantial property damage.

### Wiring and Connection of Cables

 <b>WARNING</b>
<ul style="list-style-type: none"><li>• Be sure to turn off the power to the inverters and related devices before making RS-485 connection. <b>Risk of electric shock if this warning is not heeded.</b></li></ul>

 <b>CAUTION</b>
<ul style="list-style-type: none"><li>• When connecting an RS-485 communications cable to the RJ-45 connector on the inverter or communication card, be sure to check the pin assignment of the device to be connected. For details, refer to Chapter 1, Section 1.2.3.2 "Pin assignment for RS-485 port (RJ-45 connector)." <b>An accident or mechanical failure could occur if this warning is not heeded.</b></li></ul>

### Operation

 <b>WARNING</b>
<ul style="list-style-type: none"><li>• Resetting an alarm with a run command being ON will cause the inverter to run the motor unexpectedly. <b>An accident or injury could occur.</b></li></ul>

## **WARNING**

- If Loader or OS freezes or is forced to quit when Loader is operating the inverter(s) from the Test run window, the connected inverter(s) cannot be stopped from Loader. If it happens, perform any of the following operations to stop the inverter(s).
  - 1) Prepare a separate emergency stop switch and use it to stop the inverter.
  - 2) Turn off the power to the inverter.
  - 3) Turn off the external run command at the inverter side and switch the command source from "Via communications line" to "From inverter" by doing one of the following:
    - Turn off the terminal which the **LE** command is assigned to.
    - Set function code y99 data (Link support function) to "0" using the keypad.
    - Set function code H30 data (Link function) to "0" using the keypad.
- When operating the inverter(s) from the Test run window, never disconnect the RS-485 communications cable, USB cable, or keypad. Doing so makes it impossible to stop the inverter(s) from Loader. It is dangerous.

**An accident or injury could occur if this warning is not heeded.**



# Contents

Preface .....	i
■ Safety Precautions .....	i
Contents .....	iii
<b>Chapter 1 Before Using FRENIC Loader</b>	
1.1 Overview.....	1-1
1.1.1 Features.....	1-1
1.1.2 Loader functions .....	1-1
1.1.3 Warranty .....	1-2
1.2 Connecting Inverters to a PC.....	1-3
1.2.1 Connection.....	1-3
1.2.2 Configuring a USB network.....	1-4
1.2.2.1 Example of networking.....	1-4
1.2.3 Configuring an RS-485 communications network .....	1-5
1.2.3.1 Example of networking.....	1-5
1.2.3.2 Pin assignment for RS-485 port (RJ-45 connector) .....	1-6
[ 1 ] Communication port 1.....	1-6
[ 2 ] Communication port 2 (FRENIC-Ace only) .....	1-7
1.2.3.3 Communications support devices for RS-485 communication .....	1-8
[ 1 ] Communications level converters .....	1-8
[ 2 ] Requirements for the cable.....	1-9
[ 3 ] Branch adapter for multi-drop .....	1-9
1.2.3.4 Noise suppression .....	1-9
1.3 Installation .....	1-10
1.3.1 Installation of FRENIC Loader 3.x .....	1-10
[ 1 ] Windows 7/Windows Vista.....	1-11
[ 2 ] Windows XP/Windows 2000.....	1-14
1.3.2 Installation of USB driver .....	1-17
1.3.2.1 Installing the USB driver .....	1-17
[ 1 ] Windows 7 .....	1-17
[ 2 ] Windows Vista .....	1-21
[ 3 ] Windows XP .....	1-25
[ 4 ] Windows 2000 .....	1-27
1.3.2.2 Checking the installation of the USB driver .....	1-30
1.3.3 Uninstallation of FRENIC Loader 3.x.....	1-31
1.3.3.1 Before uninstallation (Quitting Loader and Message Manager) .....	1-31
[ 1 ] Windows 7 .....	1-31
[ 2 ] Windows Vista/Windows XP/Windows 2000.....	1-32
1.3.3.2 Uninstalling Loader .....	1-32
[ 1 ] From Start menu Windows 7/Windows Vista .....	1-32
[ 2 ] From Start menu Windows XP/Windows 2000 .....	1-34
[ 3 ] From setup icon Windows 7/Windows Vista .....	1-35
[ 4 ] From Setup icon Windows XP/Windows 2000.....	1-37
1.4 Configuring the Settings for Inverter(s) and Loader.....	1-39
1.4.1 Configuring communication-related function codes in the inverter(s) .....	1-39
[ 1 ] Communication port 1.....	1-39
[ 2 ] Communication port 2.....	1-39
1.4.2 Checking the COM port on the PC (when using a communications level converter) .....	1-40
1.4.3 Configuring Loader .....	1-41
1.4.3.1 Configuring communications parameters.....	1-43
[ 1 ] For connection to USB port (FRENIC-MEGA/HF/Mini(C2S)/Ace only).....	1-44
[ 2 ] For connection to RS-485 port.....	1-46

1.4.3.2	Configuring connection settings .....	1-48
[ 1 ]	For connection to USB port (FRENIC-MEGA/HF/Mini(C2S)/Ace only) .....	1-48
[ 2 ]	For connection to RS-485 port .....	1-50
1.4.3.3	Communication log file .....	1-51

## Chapter 2 Functions of FRENIC Loader

2.1	Top Window of FRENIC Loader 3.x .....	2-1
2.2	File .....	2-2
2.2.1	New .....	2-2
2.2.2	Open .....	2-2
2.2.3	Print setup .....	2-3
2.2.4	Exit .....	2-3
2.3	Menu .....	2-4
2.3.1	Function code setting .....	2-4
2.3.1.1	Function code edit .....	2-5
[ 1 ]	Reading function code data stored in the inverter .....	2-6
[ 2 ]	Changing the function code data .....	2-8
[ 3 ]	Writing function code data into the inverter from Loader .....	2-9
[ 4 ]	Notes in writing function code data into inverters whose rated power inputs or capacities are different from each other .....	2-10
[ 5 ]	Saving function code data into the PC .....	2-11
[ 6 ]	Initializing the function code data stored in the inverter .....	2-12
[ 7 ]	Printing the function code data list .....	2-13
[ 8 ]	Displaying user-selected function codes only (User definition) .....	2-14
[ 9 ]	Searching for a character string in function code names .....	2-16
2.3.1.2	Auto-tuning .....	2-17
2.3.1.3	Comparison .....	2-18
2.3.1.4	File information .....	2-19
[ 1 ]	Changing the region .....	2-20
[ 2 ]	Changing the input power supply voltage .....	2-20
[ 3 ]	Changing the inverter capacity .....	2-20
[ 4 ]	Changing the current definition file .....	2-21
2.3.1.5	Function code (customizable logic) setting .....	2-23
[ 1 ]	Function code edit .....	2-24
[ 2 ]	Comparison .....	2-25
[ 3 ]	File information .....	2-25
2.3.2	Operation monitor .....	2-26
2.3.2.1	I/O monitor (for control terminal input/output signal status of the inverter) .....	2-26
2.3.2.2	System monitor (for current setup info and maintenance info of inverter) .....	2-26
2.3.2.3	Alarm monitor .....	2-27
2.3.2.4	Meter display (Showing the inverter running states) .....	2-28
[ 1 ]	Changing data to be displayed on meters .....	2-28
[ 2 ]	Changing the advanced settings for analog meters .....	2-30
2.3.2.5	Saving data in CSV format (on operation status monitors) .....	2-31
2.3.3	Multi-monitor (for the running status of more than one inverter) .....	2-32
[ 1 ]	Adding/deleting the monitor items to be listed .....	2-32
2.3.4	Test-running .....	2-34
2.3.4.1	Setting up the inverter and running the motor from Loader .....	2-35
2.3.4.2	Monitoring the inverter operation from Loader .....	2-38
2.3.4.3	Recovering Loader whose Test run window cannot monitor inverter status .....	2-39
2.3.5	Trace (Showing the inverter operation status in waveforms) .....	2-41
2.3.5.1	Starting/stopping monitoring .....	2-42
2.3.5.2	Saving trace data .....	2-43
2.3.5.3	Making a copy of the waveform monitor .....	2-44
2.3.5.4	Sub-panes .....	2-45
[ 1 ]	Cursor .....	2-45
[ 2 ]	Graph Position adjustment .....	2-46

2.3.5.5	Advanced waveform settings .....	2-47
[ 1 ]	Channel configuration .....	2-47
[ 2 ]	Ch1 to Ch4 (Analog channels) .....	2-47
[ 3 ]	Ch1 to Ch8 (Digital channels) .....	2-51
[ 4 ]	Channel check .....	2-53
[ 5 ]	Other settings .....	2-53
2.3.5.6	Optimizing Y-axis of the graph .....	2-57
2.3.6	Quick access menu .....	2-58
2.3.7	Option .....	2-58
2.4	View .....	2-59
2.4.1	Toolbar .....	2-59
2.4.2	Status bar .....	2-59
2.5	Window .....	2-60
2.5.1	Cascade windows .....	2-60
2.5.2	Tile windows .....	2-60
2.5.3	Tile windows vertically .....	2-61
2.5.4	Arrange icons .....	2-61
2.6	Help .....	2-62
2.6.1	About FRENIC Loader .....	2-62

### Chapter 3 Reference Information

3.1	Troubleshooting .....	3-1
3.2	Frequently asked questions (FAQ) .....	3-3
3.2.1	Cannot communicate with inverter (Failed to get inverter information) .....	3-3
3.2.1.1	Message Manager not installed correctly .....	3-3
[ 1 ]	Windows 7 .....	3-3
[ 2 ]	Windows Vista/ Windows XP/ Windows 2000 .....	3-3
3.2.1.2	USB driver not installed correctly (for FRENIC-MEGA/HF/Mini(C2S)/Ace) .....	3-4
[ 1 ]	Windows 7 .....	3-4
[ 2 ]	Windows Vista .....	3-5
[ 3 ]	Windows XP .....	3-8
[ 4 ]	Windows 2000 .....	3-8
3.2.1.3	USB driver installed correctly (for FRENIC-MEGA/HF/Mini(C2S)/Ace) .....	3-9
[ 1 ]	Windows 7 .....	3-9
[ 2 ]	Windows Vista/Windows XP/Windows 2000 .....	3-9
3.2.1.4	USB communication impossible after the PC has gone standby or to sleep) .....	3-10
[ 1 ]	Windows 7 .....	3-10
[ 2 ]	Windows Vista/Windows XP/Windows 2000 .....	3-10
3.2.1.5	If "1:loader protocol" is set in both function code y10 and y20 "RS-485 setting (protocol selection)" .....	3-10
3.2.2	Cannot read or write function code data from/to the inverter .....	3-11
3.2.3	Cannot open saved files (The specified file did not exist) .....	3-13
3.2.3.1	How to open the function code data saved without the specified files. ....	3-13
3.2.3.2	How to open the function code data saved by the previous version 1.1.0.0 .....	3-14
3.2.4	Cannot find saved files (Windows 7/Windows Vista) .....	3-15
3.2.5	Notes on updating Loader .....	3-16
3.3	Specifications of FRENIC Loader 3.x .....	3-18



---

# Chapter 1

## Before Using FRENIC Loader

This chapter gives an overview of the inverter support software FRENIC Loader and provisions for its installation and operation.



## 1.1 Overview

### 1.1.1 Features

- Loader enables a PC to support remote operation of inverters either individually or collectively via the RS-485 port or the USB port on the inverters.
- Simplified operation of Loader allows you to easily run/stop the motor, monitor operation status of the inverter, and to manage and set the function code data for the inverter.
- Real-time trace allows you to monitor operation status of the inverters real-time in a graph chart format with data lists, and to save the monitored result in a file that is useful to analyze operation of a system configured with inverters.

### 1.1.2 Loader functions

The table below provides an overview of the Loader functions.

Function		Overview	
Function code settings	Function code edit	Displaying Function codes	Shows the function codes by category--all, in groups (F, E, C, etc.), those whose data settings differ from factory defaults, those selected by the user to show, communications codes, results of comparison, or searching result of the function codes.  The function code files listed and edited in the Function code edit window are one of the following: - Newly created. - Read data set in the inverter. - Read data stored in the PC.
		Writing the changed data	Edits the function code data read from the inverter and overwrites new function code data to the inverter.
		Writing data changed from factory defaults	Overwrites only the function code data changed from those set in the inverter as factory defaults.
		Writing all	Overwrites all data to the inverter unconditionally.
		Help (information on function codes)	Shows the meaning of function code data for each code.
		Saving data	Saves the function code data currently listed in the file.
		Printing data	Prints a list of function codes.
		Initialization	Initializes all function code data set in the inverter(s) managed by Loader or currently being edited by Loader.
	Auto-tuning	Obtains motor parameters (%R1, %X, no-load current, etc.) and save them in the inverter.	
	Comparison	Compares the editing code data with those saved in the selected file or set in the selected inverter.	
File information	Displays and modifies information such as model and comments related to the file used to save the function code data.		
Operation Status Monitor	I/O monitor	Indicates the I/O terminal status of the selected inverter.	
	System monitor	Indicates the inverter ROM version, maintenance information, etc.	
	Alarm monitor	Indicates the inverter status during alarm mode.	
	Meter display	Indicates the inverter running status in analog meter format.	
Multi-monitor	Lists the operation status of inverter(s).		
Test run	Enables the user to run/stop the inverter or set the frequency command and the terminal assignment, and shows the output frequency, drive current and status of programmable I/O terminals.		
Real-time trace	Shows the running status of inverters graphically in real-time.		
Historical trace	Shows the running status records saved in the inverters graphically.		

---

### 1.1.3 Warranty

Limited Warranty	In no event will Fuji Electric Co., Ltd. be held liable for any damage (including, but not limited to lost profit, suspension or interruption of operations, loss of operational data or other monetary loss) whatsoever resulting from the use of the software or malfunction of the same or from information contained in this document.
---------------------	--



## 1.2 Connecting Inverters to a PC

### 1.2.1 Connection

The table below lists the connection methods available for connecting inverters to a PC.

PC : Inverters	On PC	On inverter	Connection
1 : 1	USB	USB	Using a USB cable
	USB	RS-485	Via a USB–RS-485 converter
	COM port (RS-232C)	RS-485	Via an RS-232C–RS-485 converter
1 : n	USB	RS-485	Via an RS-232C–RS-485 converter When using an RJ-45 connector, use a branch adapter for multi-drop connection for each of the 2nd and the subsequent inverters.
	COM port (RS-232C)	RS-485	Via an RS-232C–RS-485 converter When using an RJ-45 connector, use a branch adapter for multi-drop connection for each of the 2nd and the subsequent inverters.

- Note**
- (1) For details about the RS-232C–RS-485 converter and USB–RS-485 converter, refer to Section 1.2.3.3, [ 1 ] "Communications level converters."
  - (2) For LAN cables with an RJ-45 connector, refer to Section 1.2.3.3, [ 2 ] "Requirements for the cable."
  - (3) For details about branch adapters for multi-drop connection, refer to Section 1.2.3.3 [ 3 ] "Branch adapter for multi-drop connection."
  - (4) To use the RJ-45 connector on the inverter for RS-485 communication, it is necessary to remove the keypad.
  - (5) To minimize the effects of noise, separate the signal lines from the power lines. Refer to Section 1.2.3.4 "Noise suppression."
  - (6) The inverter cannot be concurrently shared by the Loader-running PC and other host equipment (e.g., PLC). To use Loader, therefore, be sure to disconnect the cables of other host equipment from the RS-485 port on the inverter.
  - (7) For multi-drop connection of inverters, assign different station addresses to each of the inverters connected.

### WARNING

- Be sure to turn off the power to the inverters and related devices before making RS-485 connection.  
**Risk of electric shock if this warning is not heeded.**

### CAUTION

- When connecting an RS-485 communications cable to the RJ-45 connector on the inverter or communication card, be sure to check the pin assignment of the device to be connected. For details, refer to Chapter 1, Section 1.2.3.2 "Pin assignment for RS-485 port (RJ-45 connector)."  
**An accident or mechanical failure could occur if this warning is not heeded.**

## 1.2.2 Configuring a USB network

### 1.2.2.1 Example of networking

To configure a USB network connecting the inverter and a Loader-running PC, use a commercially available USB cable (mini B connector). (See  below.)

#### Connection using the USB connector

For connection using the USB connector, refer to Section 1.4.3.1 "Setting up communications parameters."

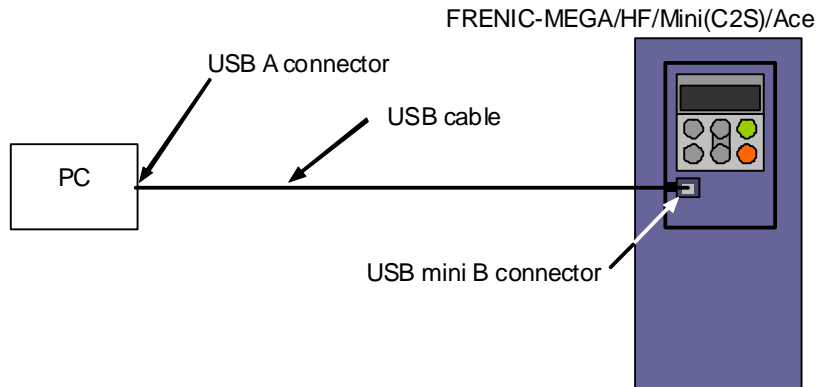



Figure 1.1 USB Network Using a USB Cable (mini B)

Table 1.1 Specifications of USB Network

Specifications	USB 1.1 compliant
Transmission speed	12M bps
Wiring length	Max. 5 m
Connector	USB mini B connector
Power supply	When connected to the inverter: Self-powered When connected to the keypad: Bus-powered

 **Note** When connecting the inverter to a PC via the USB port, be sure to connect them, one to one. Do not use a USB hub.

## 1.2.3 Configuring an RS-485 communications network

### 1.2.3.1 Example of networking

To configure an RS-485 communications network connecting inverters and a Loader-running PC, use a LAN cable having an RJ-45 connector at both ends. Refer to Section 1.2.3.3, [ 2 ] "Requirements for the cable." (See  below.)

#### Multi-drop network using the RJ-45 connector

For multi-drop connection of inverters, use a branch adapter(s) for multi-drop connection and RS-485 communications network as shown below. For connection via the RS-485 port, refer to Section 1.4.3.1 "Setting up communications parameters."

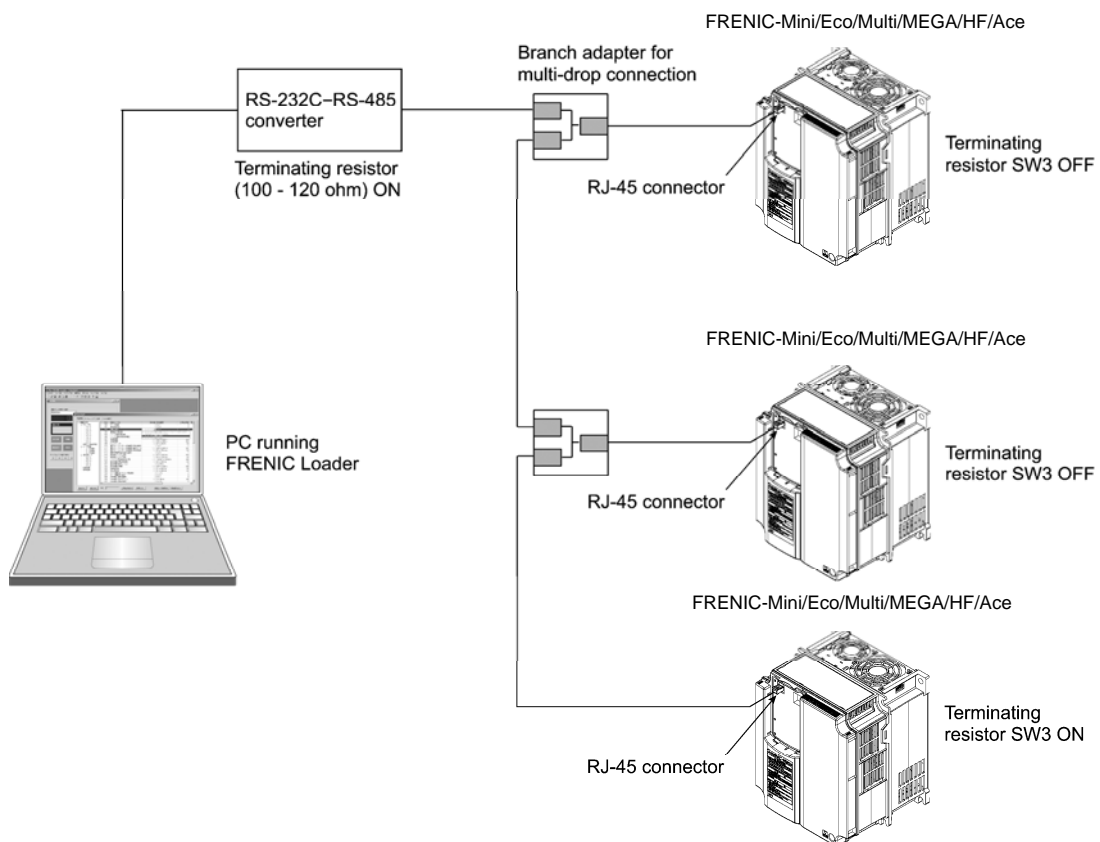

Figure 1.2 RS-485 Multi-drop Network using RJ-45 Connectors



- The RJ-45 connector on the inverter has pins to which the keypad power is assigned for remote keypad operation. Do not use these pins when connecting any other equipment to the RJ-45 connector. (See Figure 1.3 on the next page.)
- When selecting communications support devices that protect parts on the printed circuit boards of inverters from damage or malfunction due to external electrical noise or to keep the network in high noise immunity level, carefully read through the descriptions in Section 1.2.3.3 "Communications support devices for RS-485 communication."
- The maximum cable length on the RS-485 communications network is 500 m.

### 1.2.3.2 Pin assignment for RS-485 port (RJ-45 connector)

There are two communication ports of RJ45 connector.

Communication port 1: Keypad loading slot

Communication port 2: Terminal stand loading slot (only FRENIC-Ace)

#### [ 1 ] Communication port 1

For ease of connection to a standard RS-232C–RS-485 converter, the inverter's RS-485 port is designed to be compliant with the standard 4 pairs signal line pin assignment for the RJ-45 connector, where a pair of signal lines DX- and DX+ are assigned to #4 and #5 pins as shown in Figure 1.3.

**Note** The power feed lines to the keypad occupy #1, #2, #7 and #8 pins. Do not use these pins when connecting equipment other than the keypad to this port.

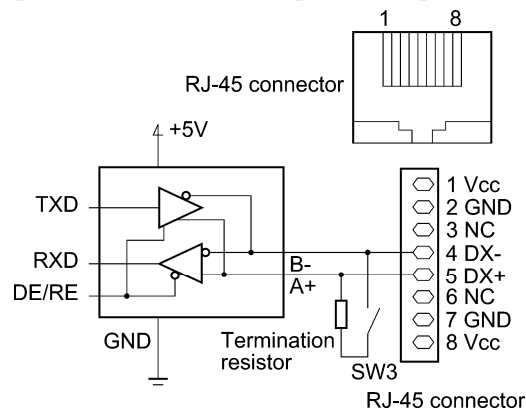

Figure 1.3 Standard RS-485 Port and RJ-45 Connector of the communication port 1 Pin Assignment

Table 1.2 RJ-45 of the communication port 1 Pin Assignments on the FRENIC Series of Inverters

Pin #	Assignment	Remarks
1	Vcc (+5 V)	Using these pins may cause a short-circuit between the Vcc and GND lines.
2	GND	
3	NC	No connection.
4	DX-	A pair of RS-485 communications lines
5	DX+	
6	NC	No connection.
7	GND	Using these pins may cause a short-circuit between the Vcc and GND lines.
8	Vcc (+5 V)	

[ 2 ] Communication port 2 (FRENIC-Ace only)

This communication port is not available in FRENIC-Ace “-C” model.

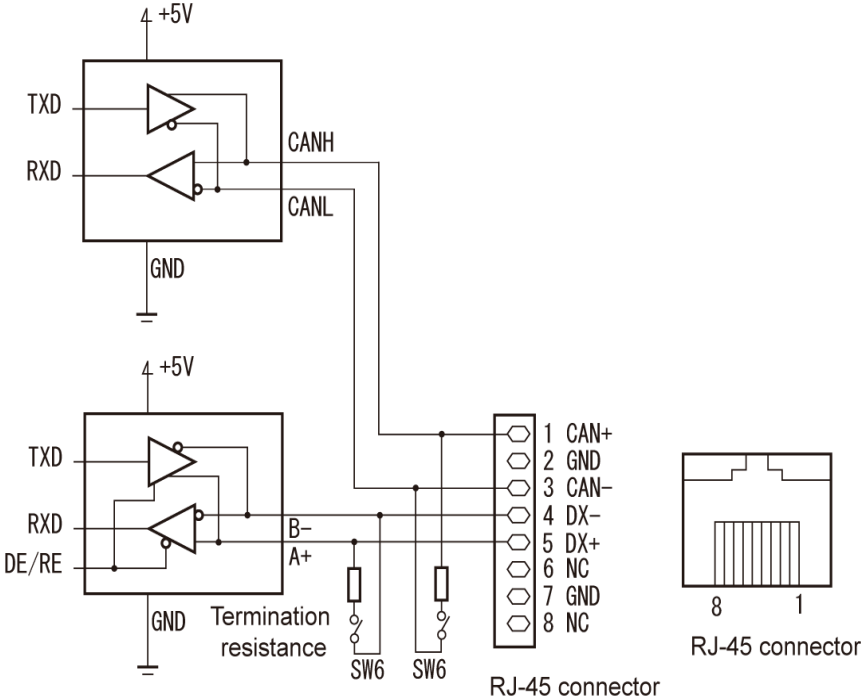

Figure 1.3 Standard RS-485 Port and RJ-45 Connector of the communication port 2 Pin Assignment

Table 1.3 RJ-45 of the communication port 2 Pin Assignments on the FRENIC Series of Inverters

Pin #	Assignment	Remarks
1	CAN+	For the CAN communication data (+) terminals (It is not used in a loader.)
2	GND	
3	CAN-	For the CAN communication data (-) terminals (It is not used in a loader.)
4	DX-	A pair of RS-485 communications lines
5	DX+	
6	NC	No connection.
7	GND	
8	NC	No connection.

### 1.2.3.3 Communications support devices for RS-485 communication

This section describes the devices required for connecting the inverter to a PC having no RS-485 port or for connecting two or more inverters in multi-drop network.

#### [ 1 ] Communications level converters

Usually PCs are not equipped with an RS-485 port but with an RS-232C port. To connect inverters to a PC, therefore, you need an RS-232C–RS-485 converter or a USB–RS-485 converter\*. To run Loader correctly, use a converter satisfying the requirements given below.

\* The USB–RS-485 converter should be a product that is compatible with the conventional COM port by emulation of a virtual COM port device driver.

#### Requirements for recommended communications level converters

Send/receive switching:	Auto-switching by monitoring of send/receive data status at the PC (RS-232C)
Electric isolation:	Electrically isolated from the RS-485 port
Fail-safe:	Fail-safe facility*
Other requirements:	Superior noise immunity

\* The fail-safe facility refers to a feature that ensures the RS-485 receiver's output at "High" (logical value = 0) even if the RS-485 receiver's input is opened or short-circuited or all the RS-485 drivers are inactive. Refer to Figure 1.4.

#### Recommended converters

System Sacom Corporation (Japan) : KS-485PTI (RS-232C–RS-485 converter)  
 : USB-485I RJ45-T4P (USB–RS-485 converter)

#### Send/receive switching system

The RS-485 communications system of the inverter acts in half-duplex mode (2-wire) so the converter must feature a send/receive switching circuitry. Generally, the switching system may be either one of the following.

- (1) Auto-switching by monitoring of send/receive data
- (2) Switching by RS-232C control signal of RTS or DTR (hardware flow control system)

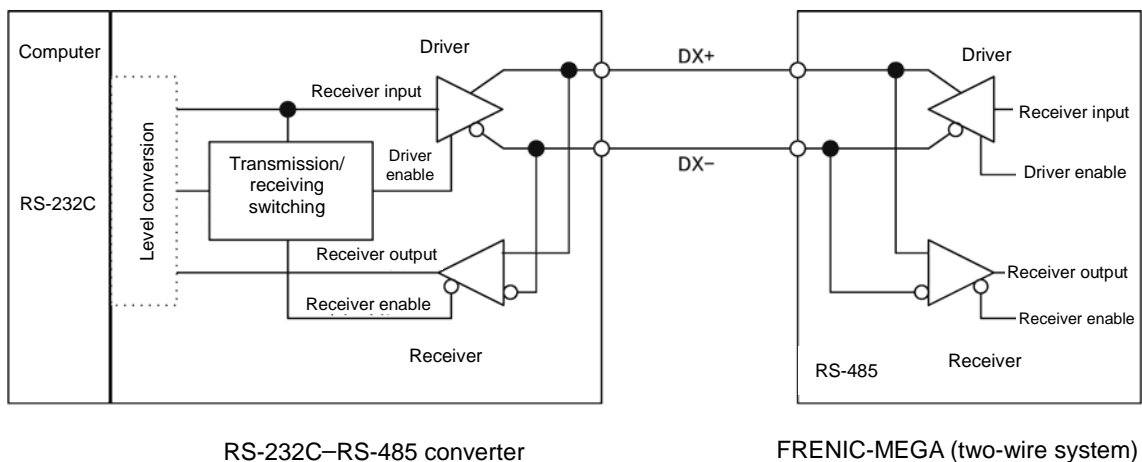

Figure 1.4 Communications Level Conversion

[ 2 ] Requirements for the cable

Use a standard 10BASE-T/100BASE-TX LAN cable (US ANSI/TIA/EIA-568A category 5 compliant, straight type).

Note The RJ-45 connector (COM port 1) has power source pins (pins 1, 2, 7 and 8) exclusively assigned to keypads. When connecting other devices to the RJ-45 connector, take care not to use those pins. Using them will cause a short-circuit hazard. Use pins 4 and 5 only.

[ 3 ] Branch adapter for multi-drop

An RS-485 communications networks for the inverters utilizes 2-wire 10BASE-T LAN cables fitted with an RJ-45 connector at both ends. To connect those inverters to the network in multi-drop mode, use branch adapters for multi-drop.

Recommended branch adapter SK Koki (Japan): MS8-BA-JJJ

1.2.3.4 Noise suppression

Depending on the operating environment, instruments may malfunction due to the noise generated by the inverter. Possible measures to prevent such malfunction are: separating the wiring, use of shielded cable, isolating the power supply, and adding an inductance component. Show below is an example of adding an inductance component.

Refer to the RS-485 Communication User's Manual, Chapter 2, Section 2.2.4 "Noise suppression" for details.

Adding inductance components

To suppress or eliminate noise for keeping the network in high noise immunity level, insert inductance components such as choke coils in series in the signal circuit, or pass the RS-485 communications cable through a ferrite core ring or wind it around by 2 or 3 turns as shown below to keep the impedance of the signal lines high.

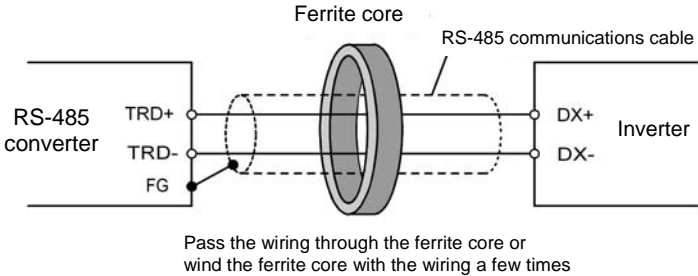

Figure 1.5 Adding an Inductance Component

---

## 1.3 Installation

### 1.3.1 Installation of FRENIC Loader 3.x

#### Before installation

Before installing Loader, check your PC, following the table below.

Check items	Requirements
Windows OS	Microsoft Windows 2000, XP, Vista (32-bit or 64-bit), or 7 (32-bit or 64-bit)
Hard disk space	Free space of approx. 9 MB or more
Other applications	Terminate all the applications being in execution.
Earlier version of Loader	If any earlier versions of Loader and Message Manager have been installed on your PC, uninstall both of them.

Download the "FRENIC Loader3\_x V7xxx x with MM Setup.exe" file from the Fuji Electric website or get it in any media. Then copy it into an appropriate folder (e.g., C:\Documents and Settings\User\My Documents\FRN\_Loader in this manual).

**Note** Installing the "FRENIC Loader3\_x V7xxx x with MM Setup.exe" installs both Loader software and Message Manager that manages communication at a time. No separate installation of Message Manager "MsgMgr Setup.exe" is required.

**Note** The loader software may fail to set up with inadequate named folder which the software is copied.  
If the setup fails, the software file is recommended to create and copy to temporary folder like as "C:\Temp\". (e.g. C:\temp\FRENIC Loader3\_x V7xxx J with MM Setup.exe)  
After the setup is succeeded to finish, you can remove the temporary folder.



## Installing Loader

### [ 1 ] Windows 7/Windows Vista

Follow the wizard and install Loader as shown below.

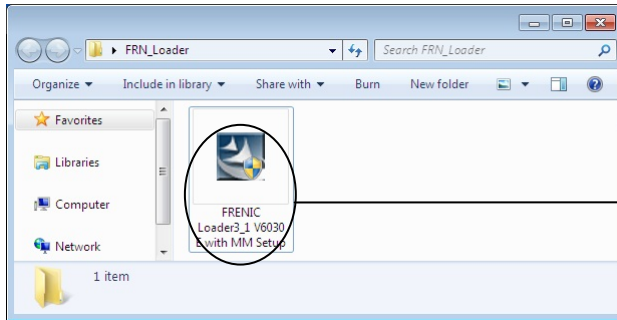

Double-click the FRENIC Loader3\_x V7xxx E with MM Setup.exe icon. The exe automatically starts the installation wizard.

#### Windows 7

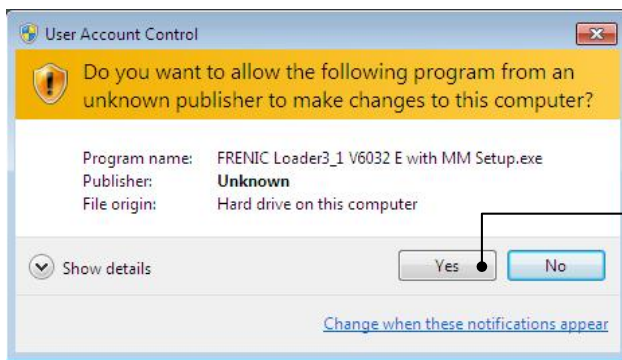

To continue, click **Yes**.

#### Windows Vista

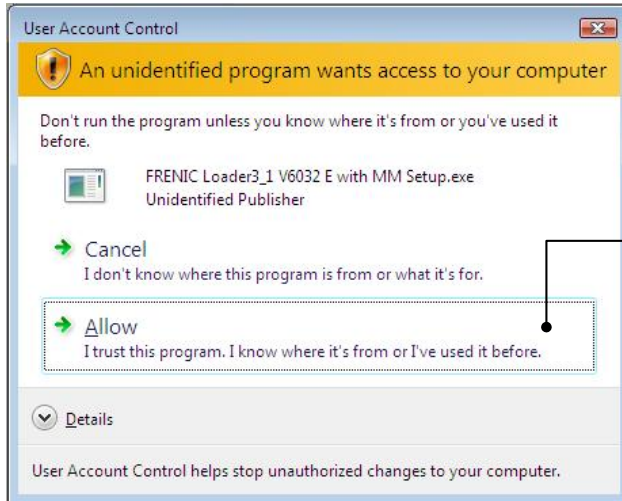

To continue, click **Allow**.

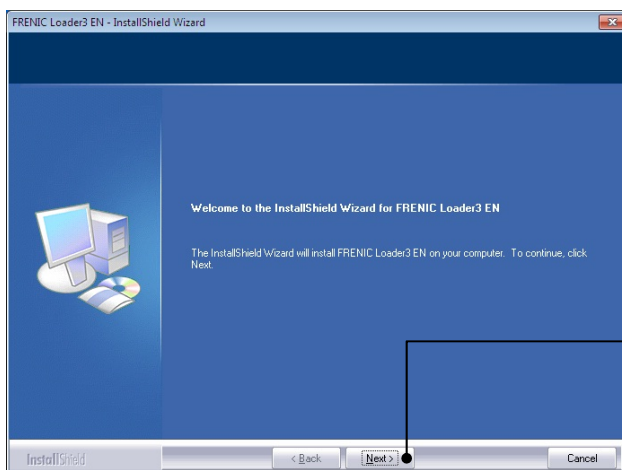

To continue, click **Next**.

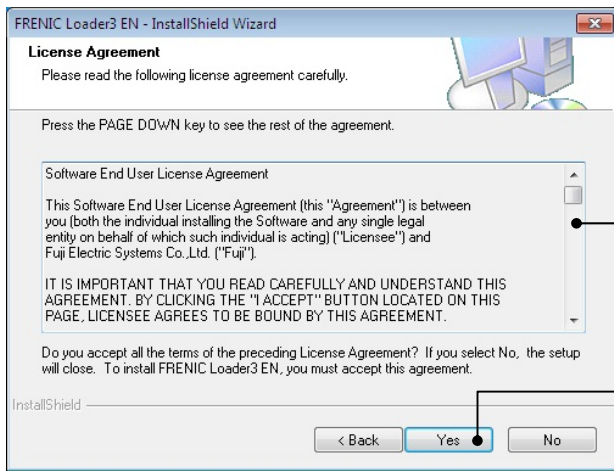

Carefully read the license agreement.  
To view the entire contents of the agreement, scroll the screen up and down using the Page Up/Down keys or the scroll bar.

If you agree, click **Yes** to proceed.

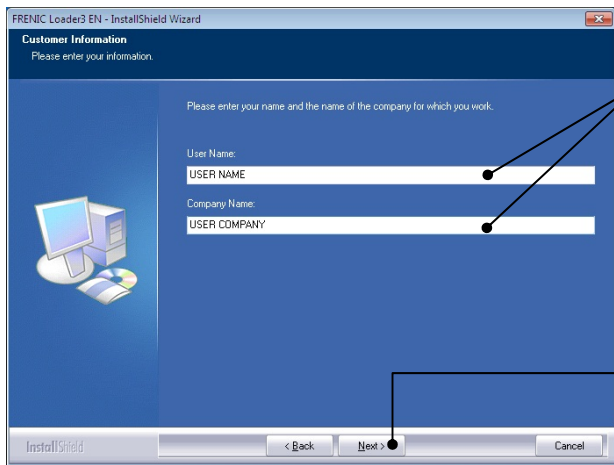

Enter your user name and company name.

After entry, click **Next** to proceed.

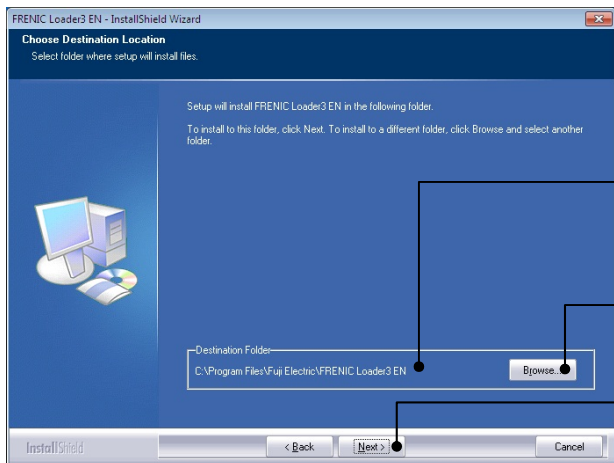

Select the destination folder to install. A default folder has appeared.

To select a different folder, click **Browse...**

Click **Next** to proceed.

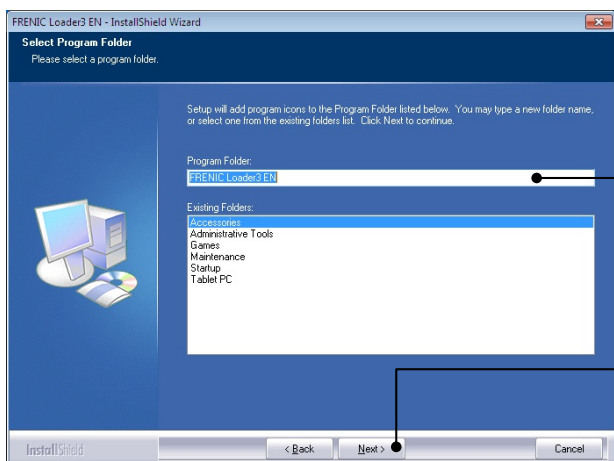

Select the start menu folder that the shortcut to FRENIC Loader is to be added to.

You can select one from existing folders in the list or create a new one.

After entry, click **Next** to proceed.

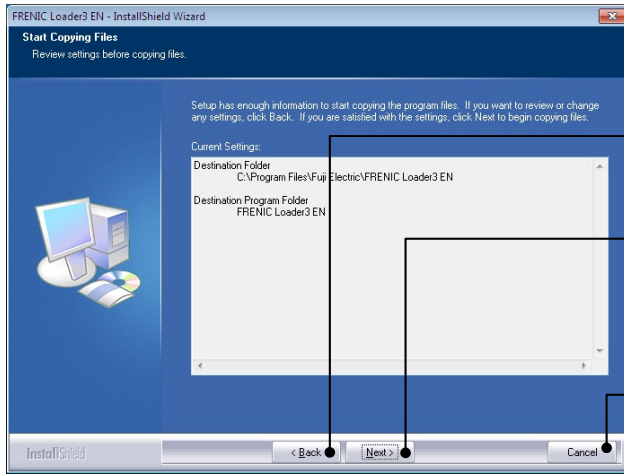

The screen confirming your selection appears.

If you want to change the selection, click **Back** to return to the previous screen.

If OK, click **Next** to proceed.

To abort the installation, click **Cancel**.

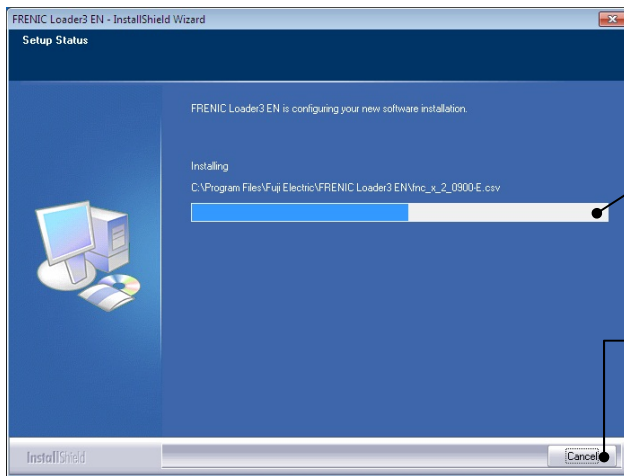

The installation progress bar appears.

To abort the installation, click **Cancel**.

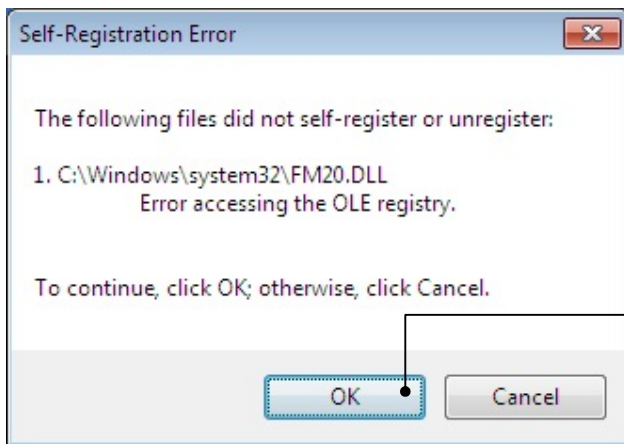

To continue, click **OK**.

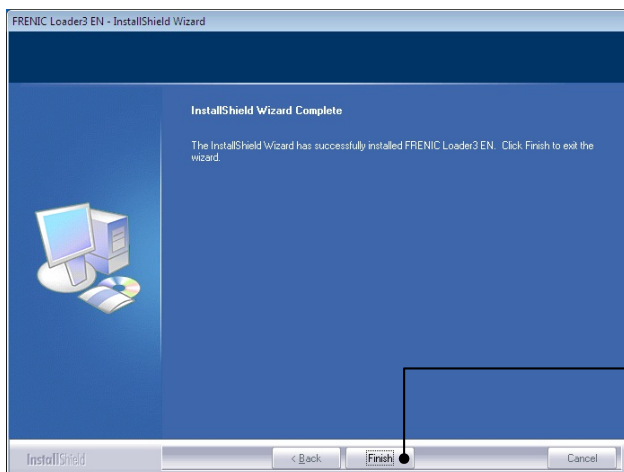

Upon completion of the installation, the screen at left appears.

To exit the installation wizard and return to Windows, click **Finish**.

## [ 2 ] Windows XP/Windows 2000

Follow the wizard and install Loader as shown below.

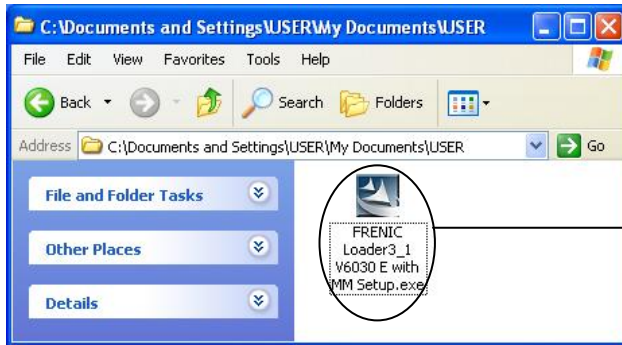

Double-click the FRENIC Loader3\_x V7xxx E with MM Setup.exe icon. The exe automatically starts the installation wizard.

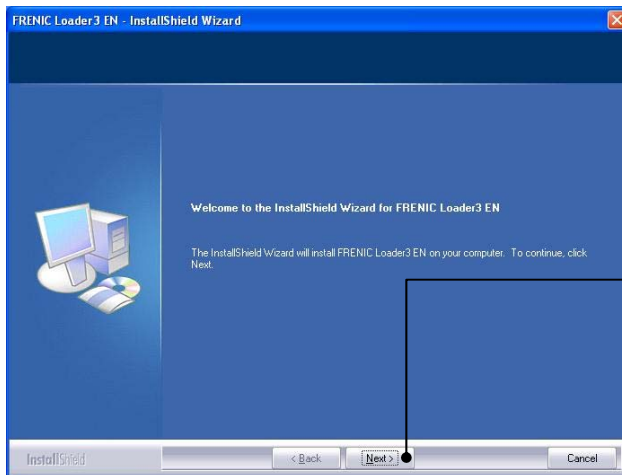

To continue, click **Next**.

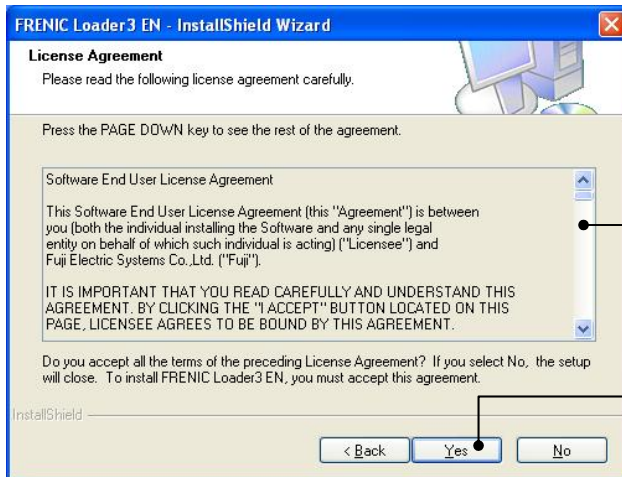

Carefully read the license agreement.

To view the entire contents of the agreement, scroll the screen up and down using the Page Up/Down keys or the scroll bar.

If you agree, click **Yes** to proceed.

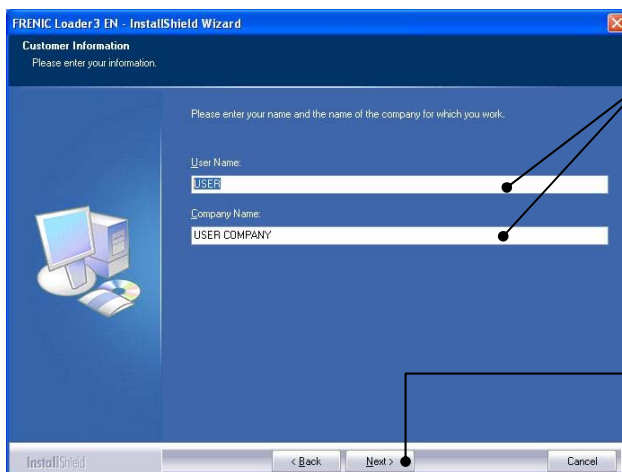

Enter your user name and company name.

After entry, click **Next** to proceed.

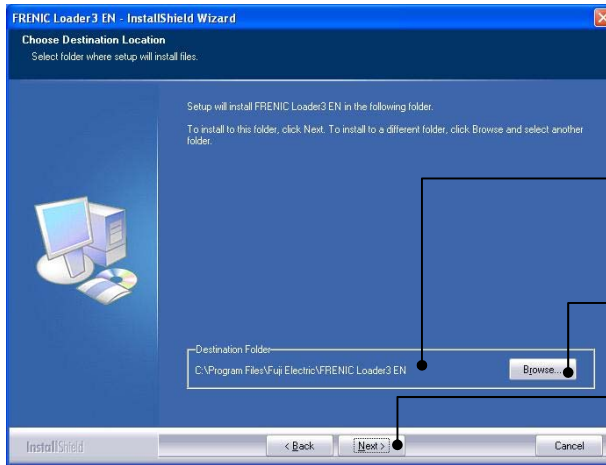

- Select the destination folder to install. A default folder has appeared.
- To select a different folder, click **Browse...**
- Click **Next** to proceed.

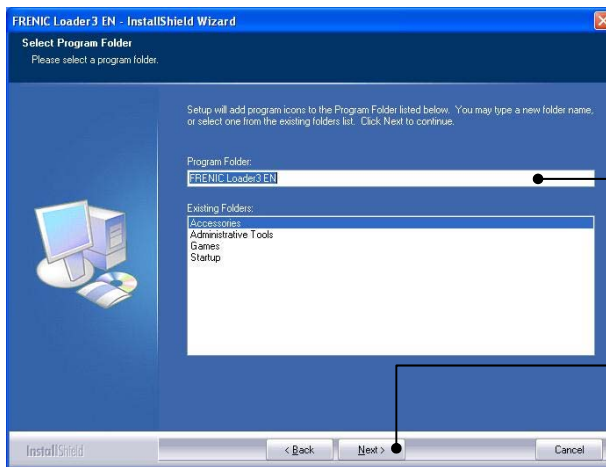

- Select the start menu folder that the shortcut to FRENIC Loader is to be added to. You can select one from existing folders in the list or create a new one.
- After entry, click **Next** to proceed.

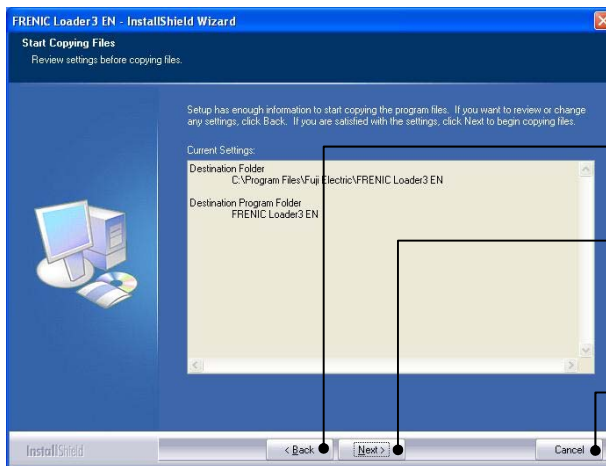

- The screen confirming your selection appears.
- If you want to change the selection, click **Back** to return to the previous screen.
- If OK, click **Next** to proceed.
- To abort the installation, click **Cancel**.

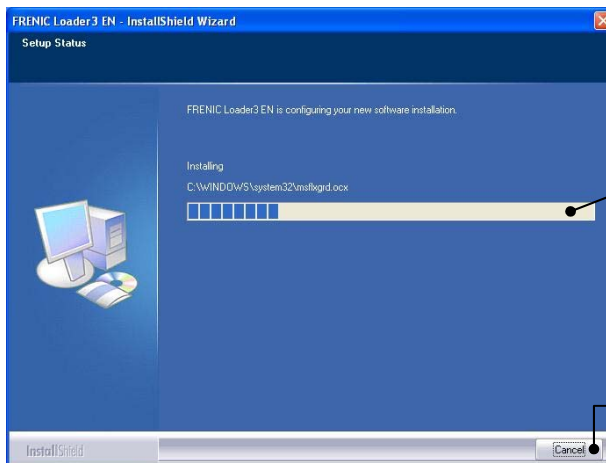

- The installation progress bar appears.
- To abort the installation, click **Cancel**.

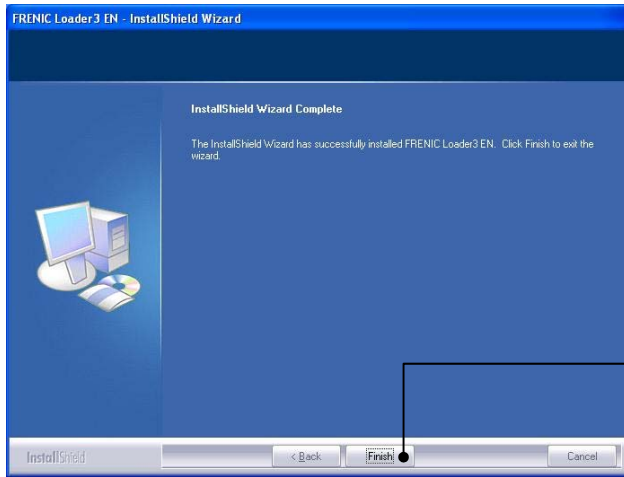

Upon completion of the installation, the screen at left appears.

To exit the installation wizard and return to Windows, click **Finish**.



## 1.3.2 Installation of USB driver

Using the USB interface for accessing the inverter(s) requires installing the USB driver to your PC. The driver installation is required only once at the first use of the USB interface.

**Note** If the USB driver has not been installed correctly, no communication via the USB interface is possible.

### 1.3.2.1 Installing the USB driver

First of all, connect the USB connector (A) on the PC and the USB connector (mini B) on the inverter's keypad with each other using a USB cable.

**Note** Before installation of the USB driver, install Loader and Message Manager. Refer to Section 1.3.1 "Installation of FRENIC Loader 3.x" for details.

#### [ 1 ] Windows 7

When the OS finds a USB device of the Loader, it displays the following.

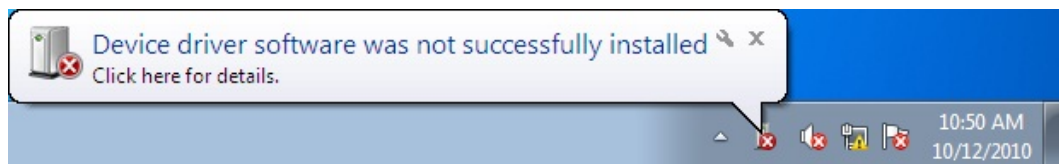

The system-supplied driver setup wizard does not run automatically. Install the USB driver as shown below.

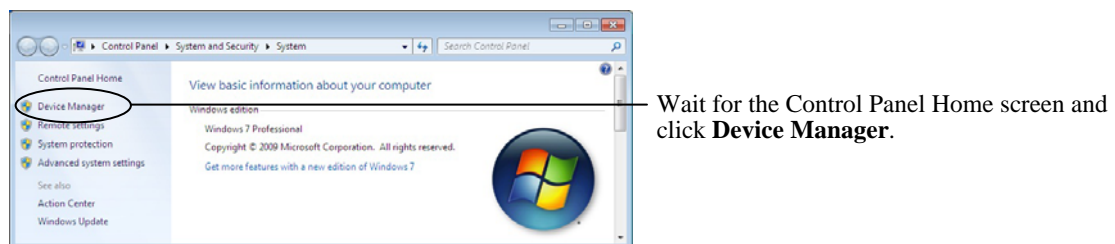
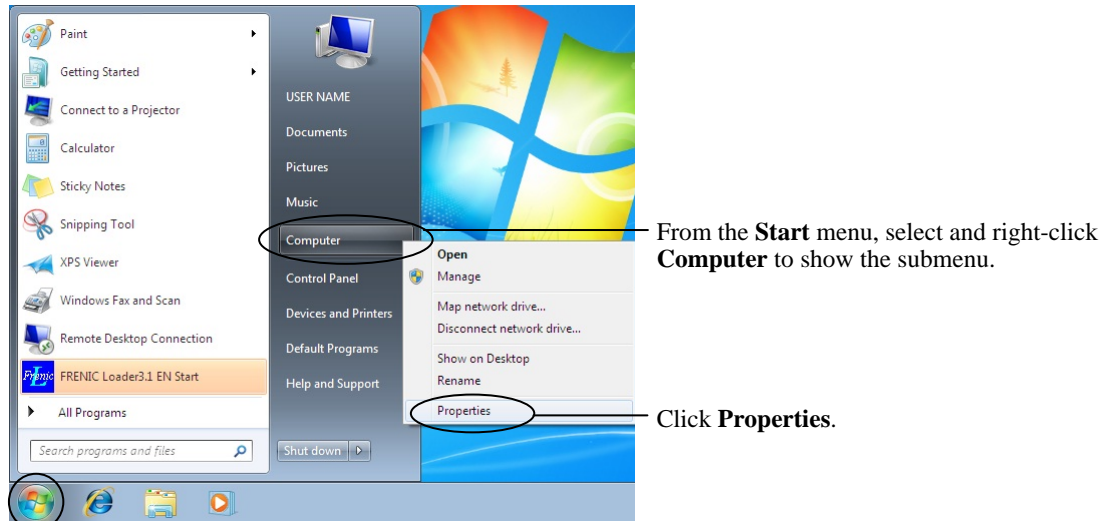

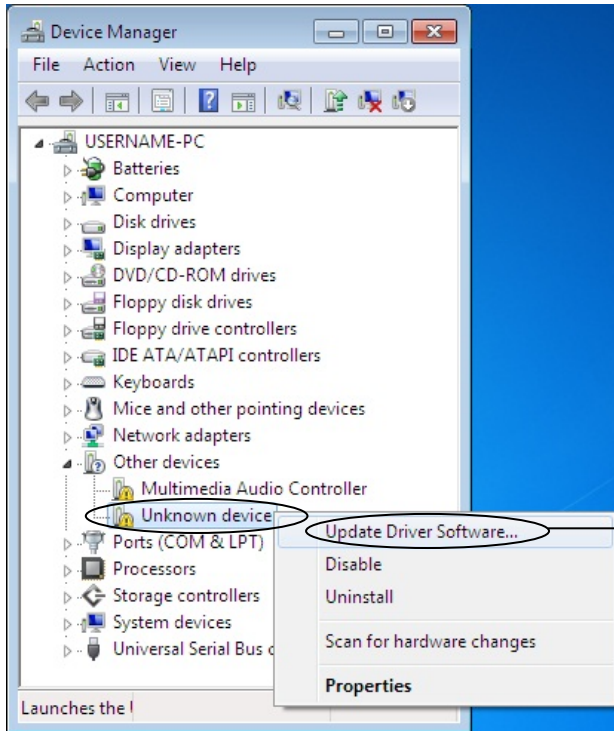

On the **Device Manager** window, right-click **Unknown device** to show the drop-down list.

Click **Update Driver Software....**

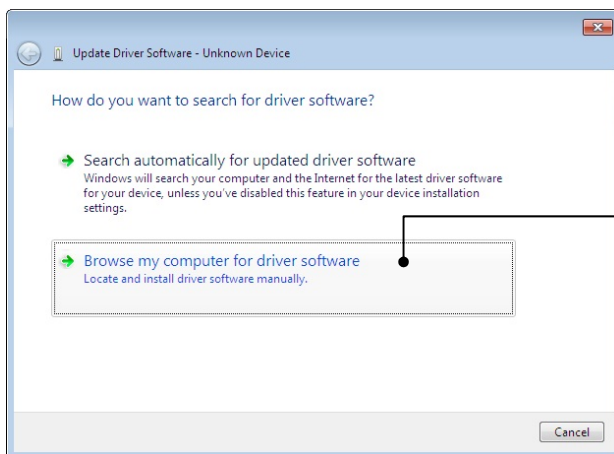

Click **Browse my computer for driver software.**

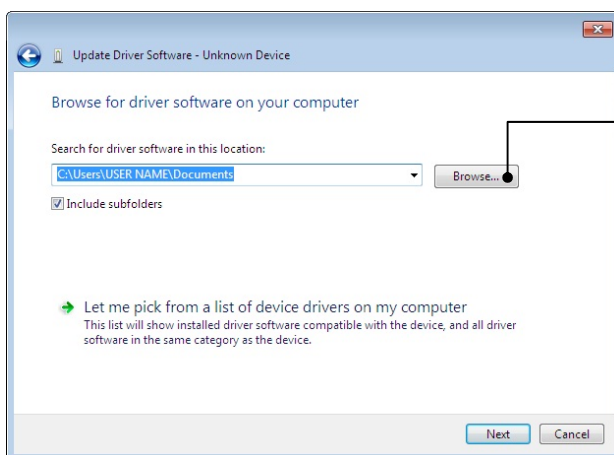

Click **Browse....**



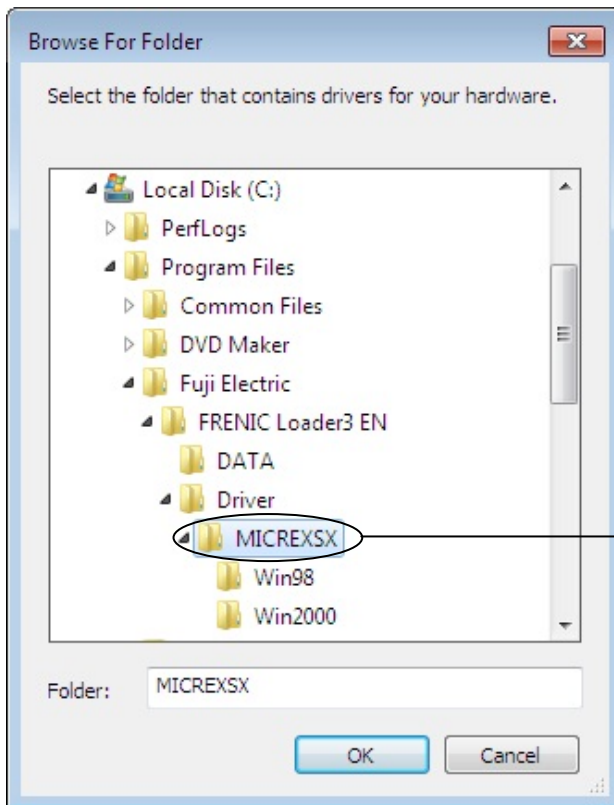

In the folder in which FRENIC Loader has been installed, select \Driver\MICREXSX and then click **OK**.

The default folder is C drive when the OS, 32-bit

C:\Program Files\Fuji Electric\FRENIC Loader3 EN\Driver\ MICREXSX

64-bit

C:\Program Files(x86)\Fuji Electric\FRENIC Loader3 EN\Driver\ MICREXSX

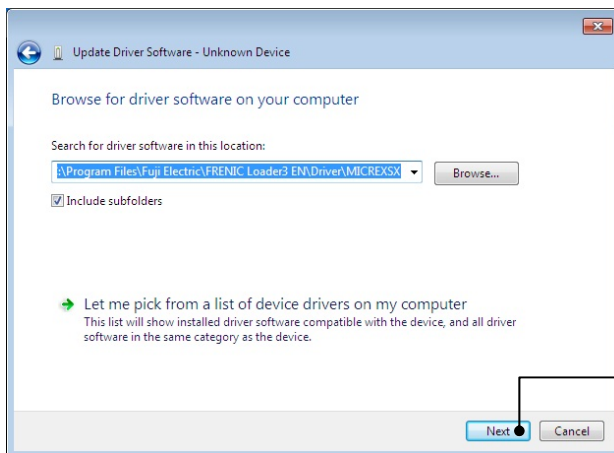

To continue, click **Next**.

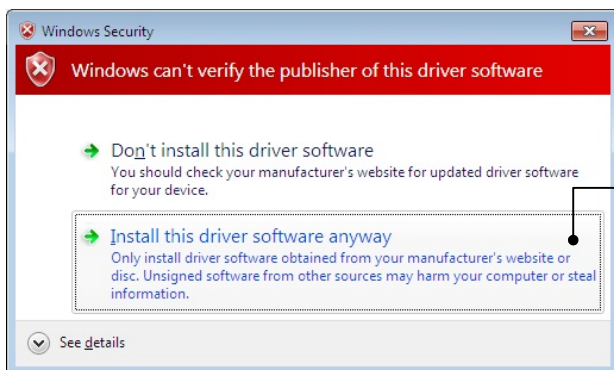

Click **Install this driver software anyway**.

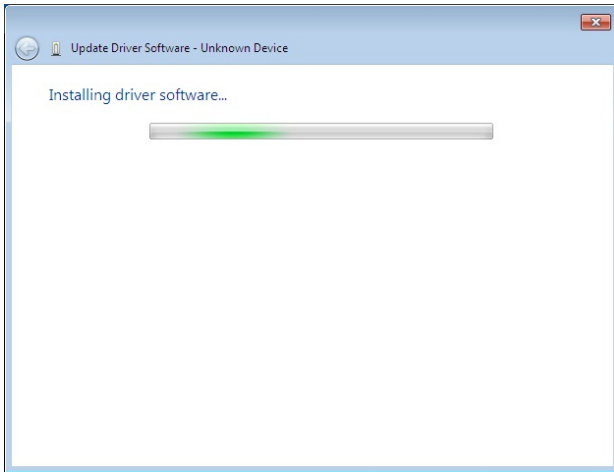

Installation starts.

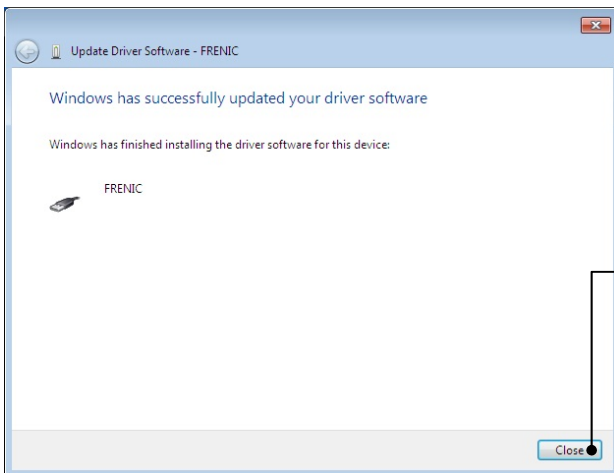

Upon completion of the installation, the screen at left appears.

To exit the installation wizard and return to Windows, click **Close**.

## [ 2 ] Windows Vista

When the OS finds a USB device of the Loader, it displays the following. Follow the wizard and install Loader as shown below.



Click **Locate and install driver software**.

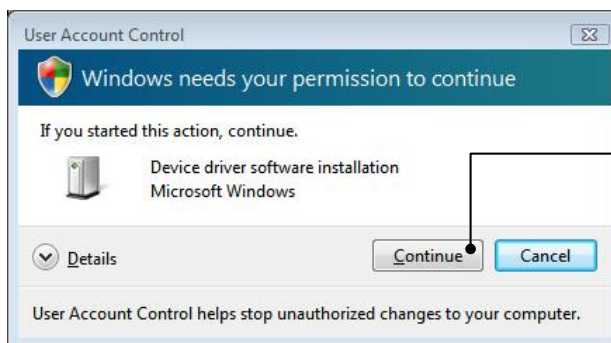

Click **Continue** to proceed.

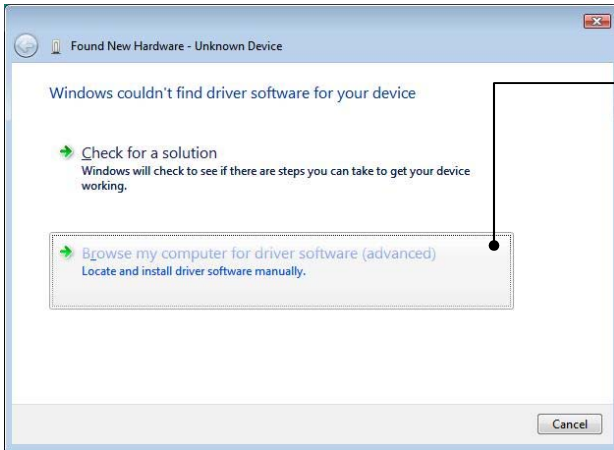

Click **Browse my computer for driver software (advanced)**.

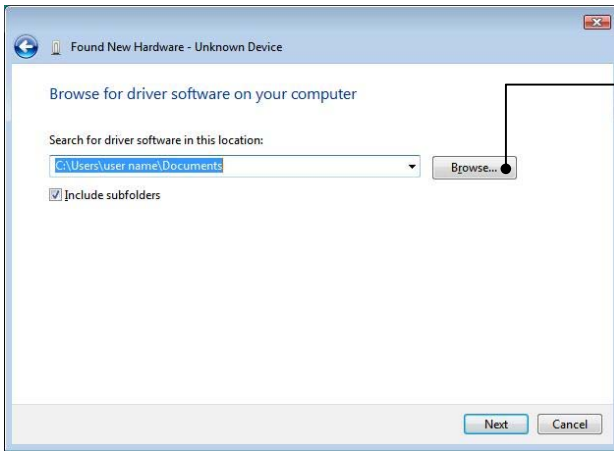

Click **Browse....**

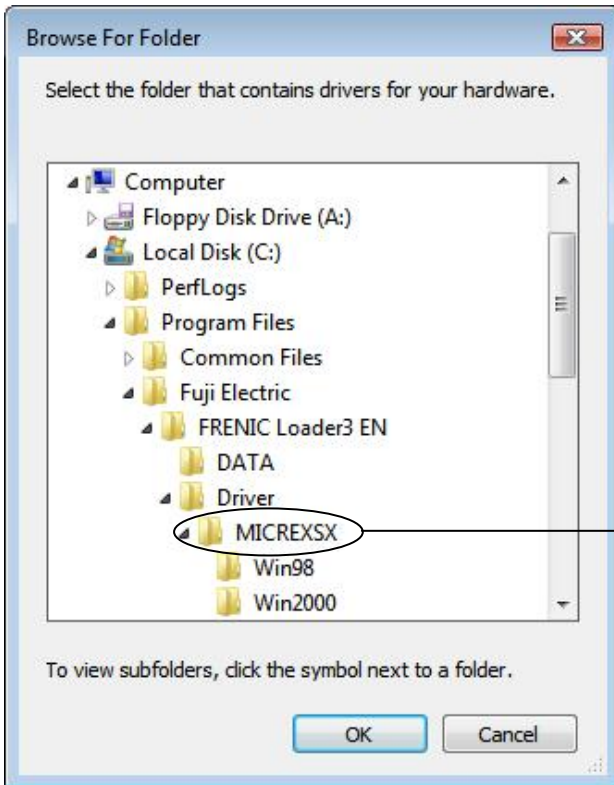

In the folder in which FRENIC Loader has been installed, select \Driver\MICREXSX and then click **OK**.

The default folder is C drive when the OS, 32-bit

C:\Program Files\Fuji Electric\FRENIC Loader3 EN\Driver\ MICREXSX

64-bit

C:\Program Files(x86)\Fuji Electric\FRENIC Loader3 EN\Driver\ MICREXSX

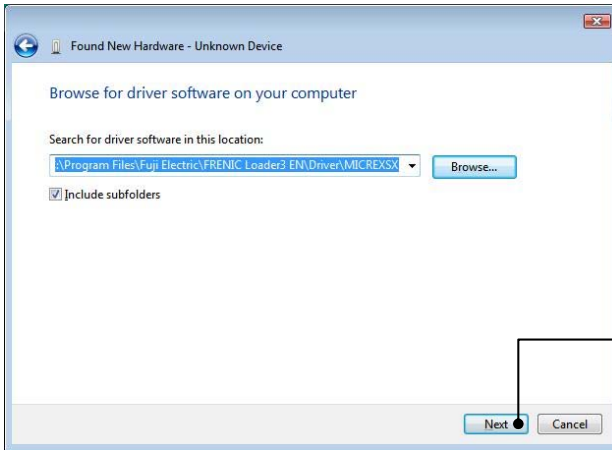

To continue, click **Next**.

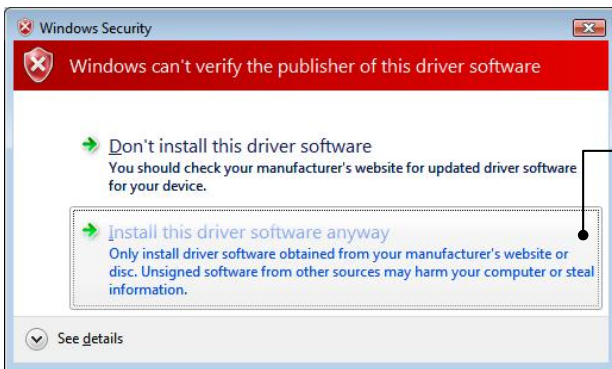

Click **Install this driver software anyway**.

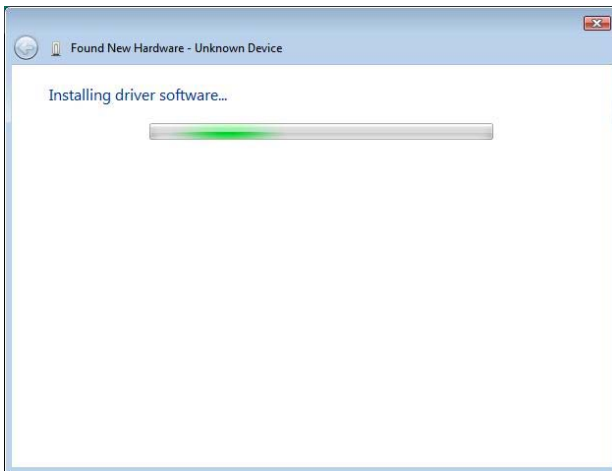

Installation starts.

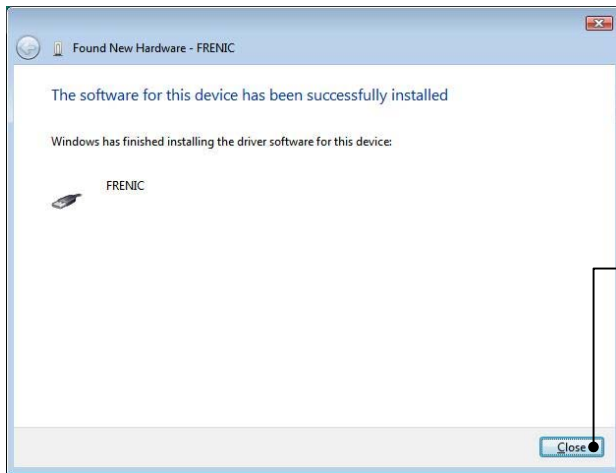

Upon completion of the installation, the screen at left appears.

To exit the installation wizard and return to Windows, click **Close**.

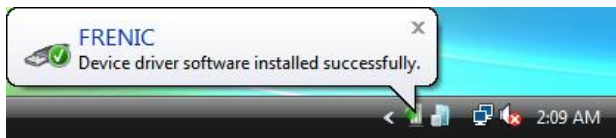

This message appears when the USB driver has been successfully installed.

### [ 3 ] Windows XP

When the OS finds a USB device of the Loader, it displays the following. Follow the wizard and install Loader as shown below.



Wait for this screen to appear, select **Yes, now and every time I connect a device**, then click **Next**.

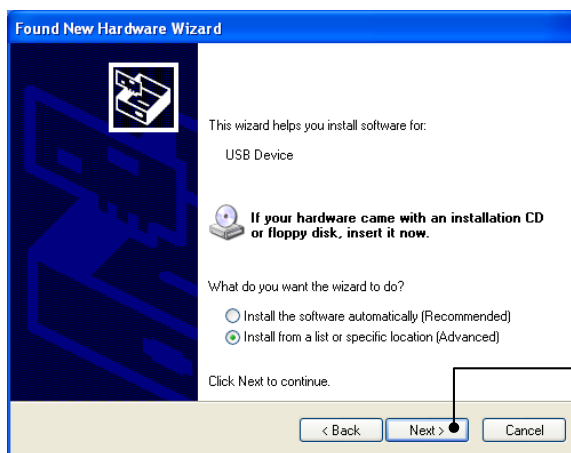

Select **Install from a list or specific location (Advanced)**, then click **Next**.

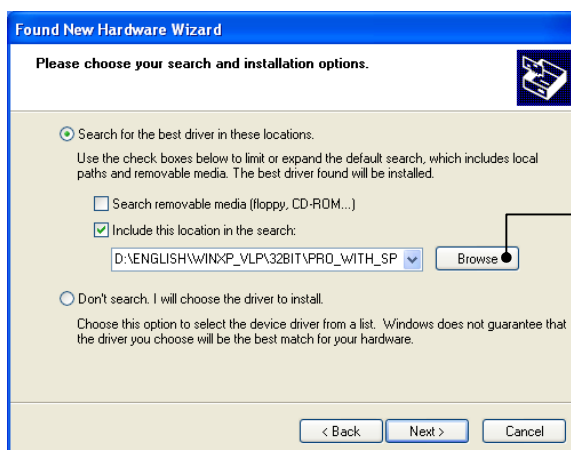

Select **Search for the best driver in these locations** and the **Include this location in the search** check box, then click **Browse....**



In the folder in which FRENIC Loader has been installed, select \Driver\MICREXSX and then click **OK**.

The default folder is C:\Program Files\Fuji Electric\FRENIC Loader3 EN\Driver\MICREXSX when the OS drive is C.

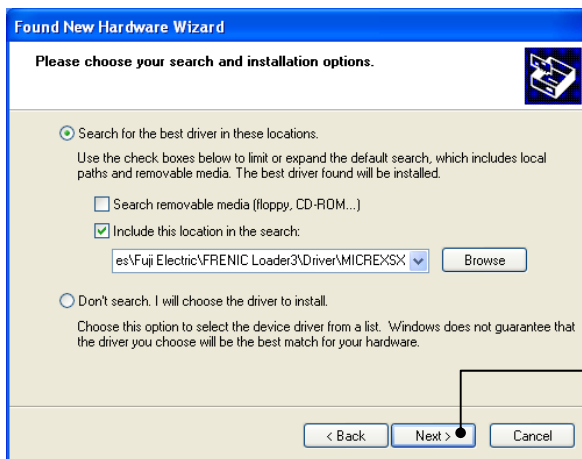

Click **Next**.

Installation starts.

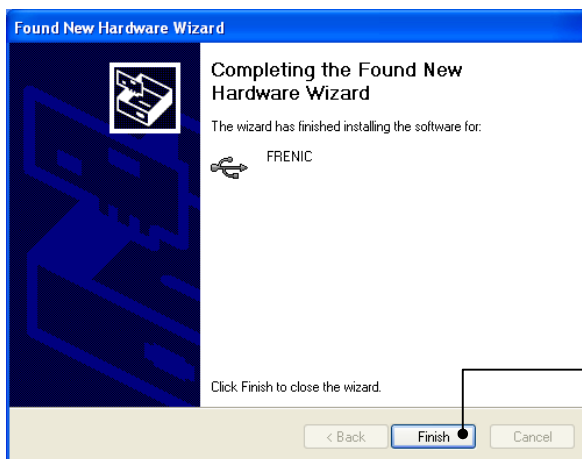

Upon completion of the installation, the screen at left appears.

To exit the installation wizard and return to Windows, click **Finish**.



## [ 4 ] Windows 2000

When the OS finds a USB device of the Loader, it displays the following. Follow the wizard and install Loader as shown below.

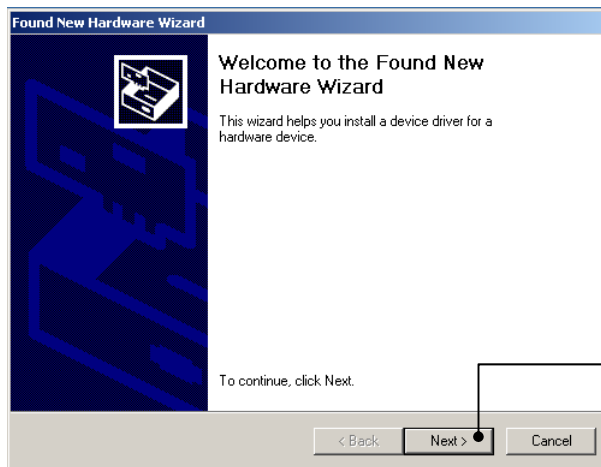

Wait for this screen to appear and then click **Next**.

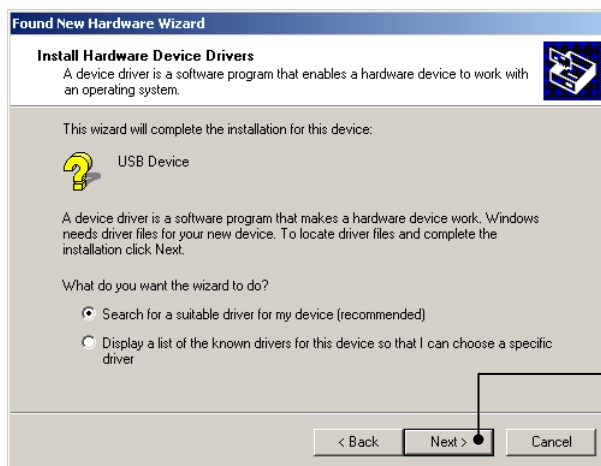

Select **Search for a suitable driver for my device (recommended)**, then click **Next**.

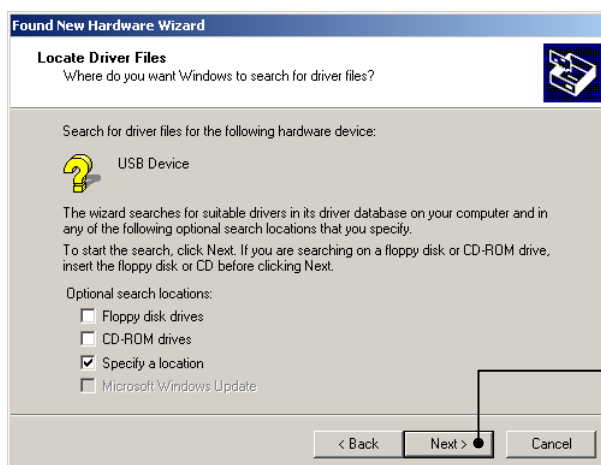

Select the **Specify a location** check box, then click **Next**.



Click **Browse...**

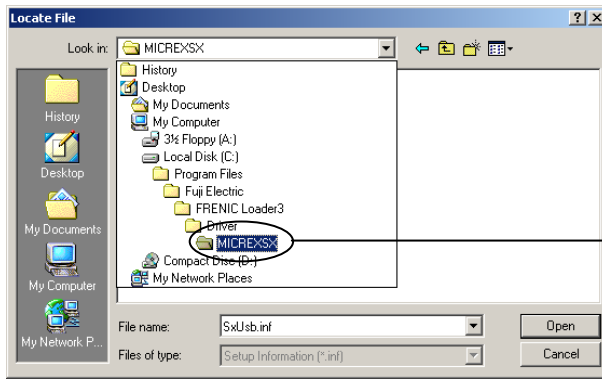

In the folder in which FRENIC Loader has been installed, select \Driver\MICREXSX and then click **OK**.

The default folder is C:\Program Files\Fuji Electric\FRENIC Loader3 EN\Driver\MICREXSX if Windows is installed in drive C.

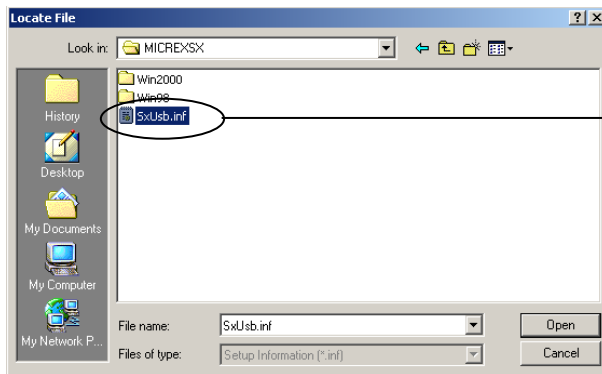

Select **SxUsb.inf** and then click **Open**.

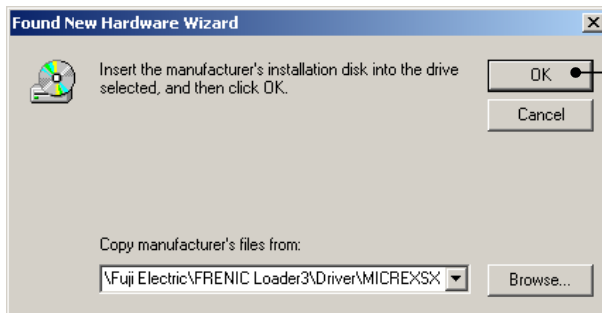

Click **OK**.



Click **Next**.

Installation starts.

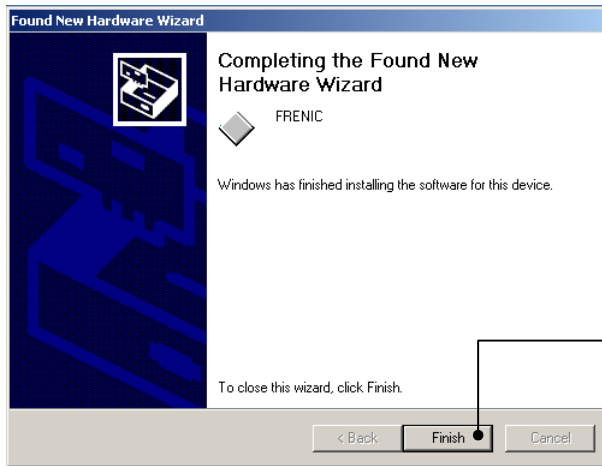

Upon completion of the installation, the screen at left appears.

To exit the installation wizard and return to Windows, click **Finish**.

### 1.3.2.2 Checking the installation of the USB driver

To check whether the USB driver has been installed correctly, open Device Manager. If **FRENIC** is added to the sub-tree of Loader USB device, the driver has been installed correctly.

Installation finished successfully

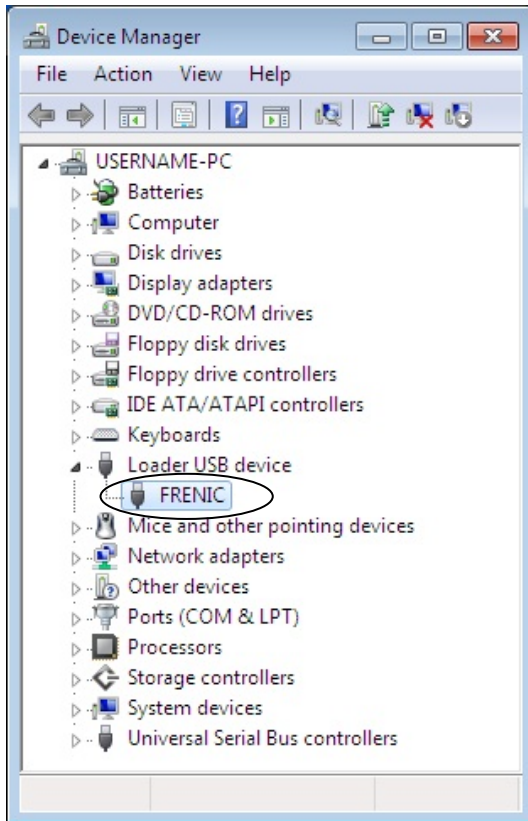

Installation failed

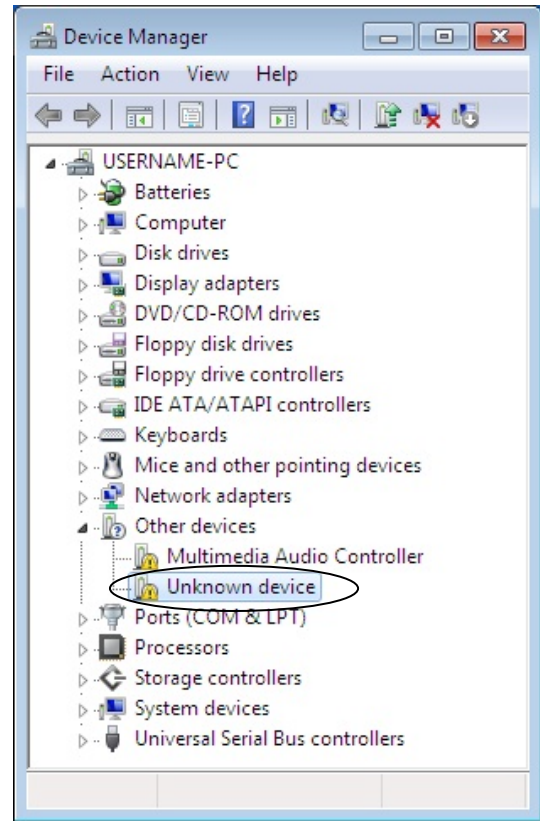

### 1.3.3 Uninstallation of FRENIC Loader 3.x

#### 1.3.3.1 Before uninstallation (Quitting Loader and Message Manager)

Before uninstalling Loader, be sure to quit both Loader and Message Manager.

##### Note Quitting Message Manager

Message Manager is software that manages communication between the PC and inverters. To make sure that Message Manager has quitted, check that no Message Manager icon is displayed in the task tray. If the icon is displayed, right-click it to quit Message Manager. If doing so cannot quit it, shut down or log off Windows.

Once you uninstall Loader when Message Manager is running, a new version of Loader installed after that cannot run properly, that is, it may no longer be able to recognize inverters. If this happens, first delete the folder (including its contents) named Fuji Electric Shared in the file path as shown below, and then reinstall Loader.

C:\Program Files\Common Files\Fuji Electric Shared

(In the file path shown above, "C" represents the drive letter of the partition or hard disk where Windows is installed. If Windows is installed on a different drive in your system, replace "C" with the letter corresponding to that drive.)

#### Quitting Message Manager

##### [ 1 ] Windows 7



Click this to display the hidden icons as shown below.

Right-click this icon to display **Exit MessageManager**, then click it. The confirmation window appears. Click **Yes** to quit Message Manager.

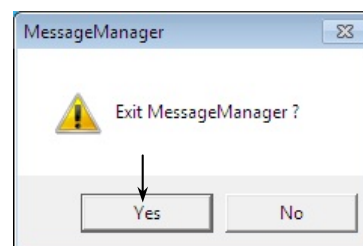

## [ 2 ] Windows Vista/Windows XP/Windows 2000

Right-click the Message Manager icon to display **Exit MessageManager**, then click it. The confirmation window appears. Click **Yes** to quit Message Manager.

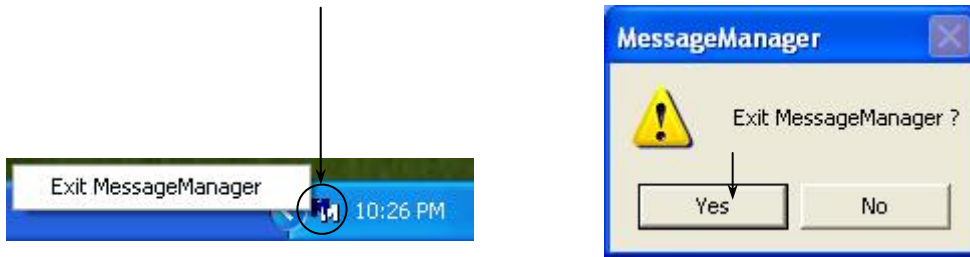

### 1.3.3.2 Uninstalling Loader

#### [ 1 ] From Start menu Windows 7/Windows Vista

- (1) From the **Start** menu, select **All Programs | FRENIC Loader3 EN | FRENIC Loader3.x EN Uninstall**.

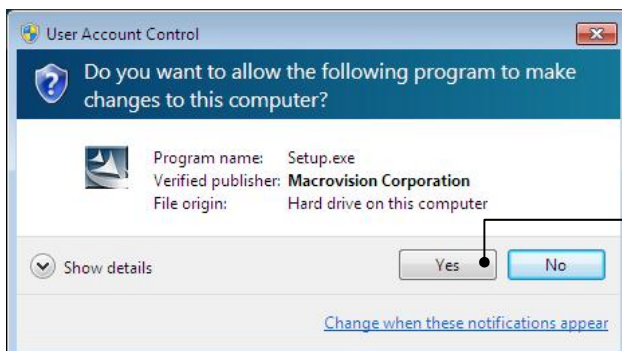
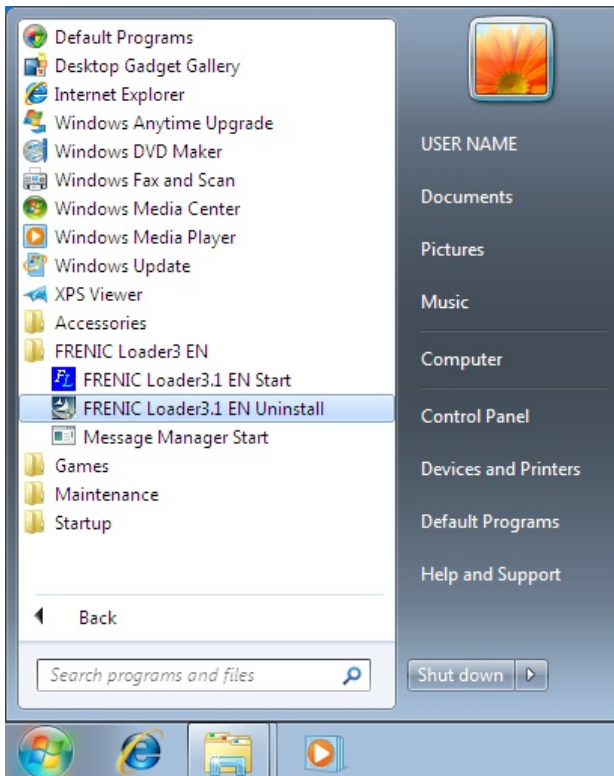

The confirmation screen at left appears.

Click **Yes**.

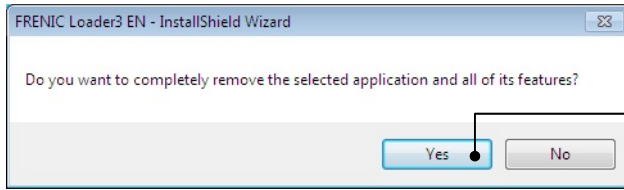

The confirmation screen at left appears.

To continue the uninstallation procedure, click **Yes**.

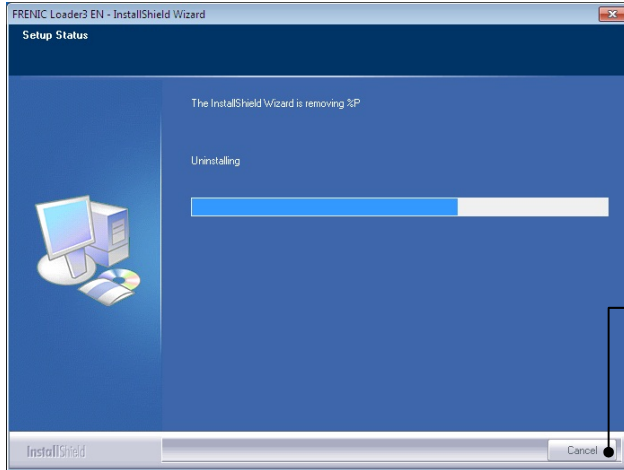

The uninstallation progress bar appears.

To abort the uninstallation, click **Cancel**.

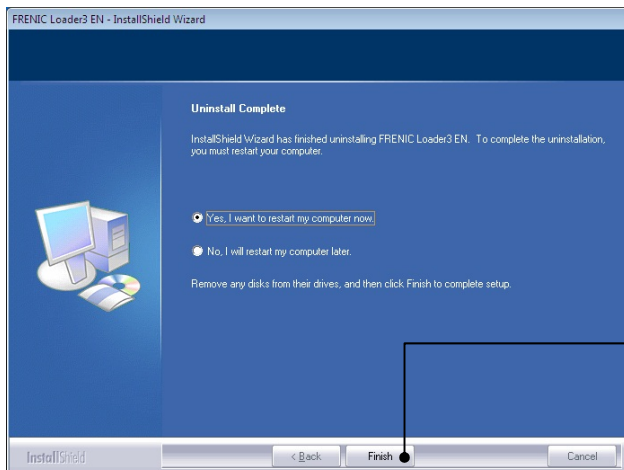

Upon completion of the uninstallation, the screen at left appears.

Select **Yes, I want to restart my computer now.** and then click **Finish**.

## [ 2 ] From Start menu Windows XP/Windows 2000

From the **Start** menu, select **All Programs** | **FRENIC Loader3 EN** | **FRENIC Loader3.x EN Uninstall**.



The uninstallation confirmation screen appears as shown left. To proceed and uninstall Loader, click **Yes**.

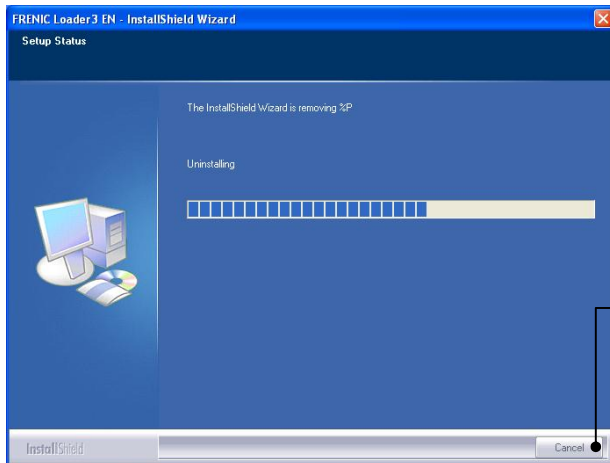

The uninstallation progress bar appears.

To abort the uninstallation, click **Cancel**.

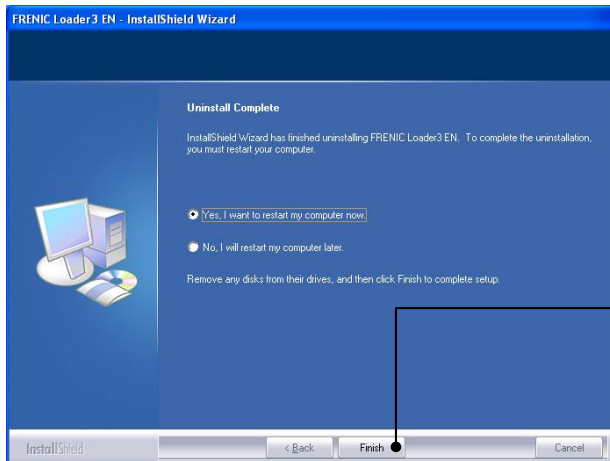

Upon completion of the uninstallation, the screen at left appears.

Select **Yes, I want to restart my computer now.** and then click **Finish**.



### [ 3 ] From setup icon Windows 7/Windows Vista

If uninstalling from the Start menu cannot start and the Problem with Shortcut dialog appears as shown below, uninstall Loader from the setup icon "FRENIC Loader3\_x V7xxx E with MM Setup."

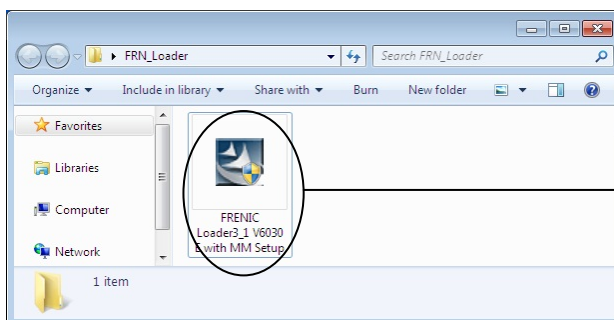

Double-click the FRENIC Loader3\_x V7xxx E with MM Setup icon. The exe automatically starts the installation wizard.

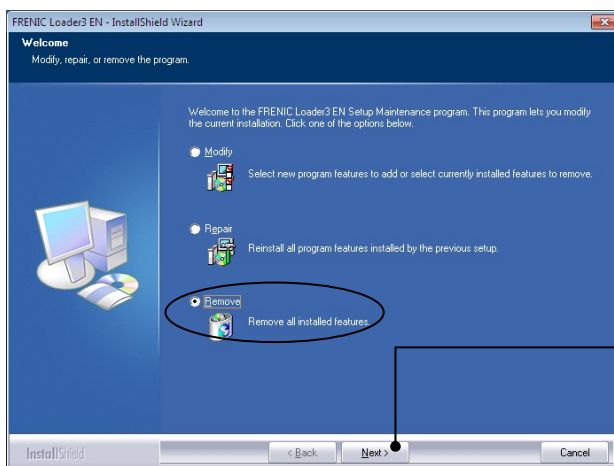

Select **Remove** and click **Next**.

#### Windows 7

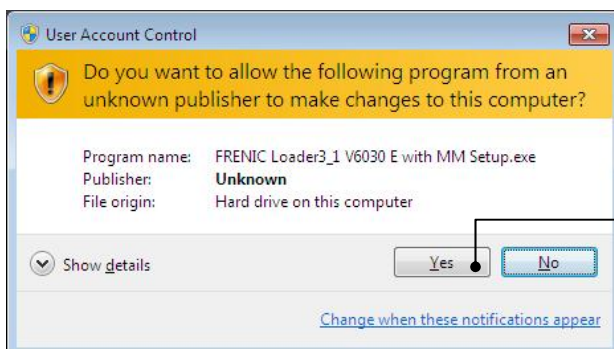

Click **Yes**.

## Windows Vista

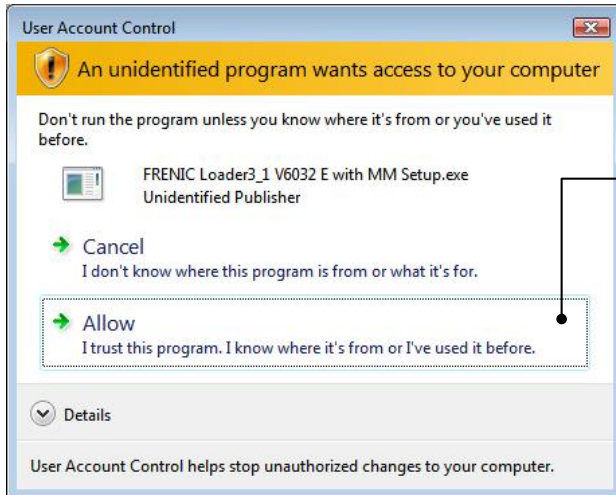

Click **Allow**.

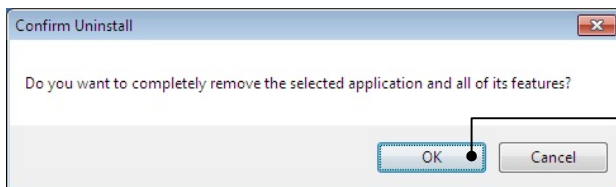

The confirmation screen at left appears.

Click **OK**.

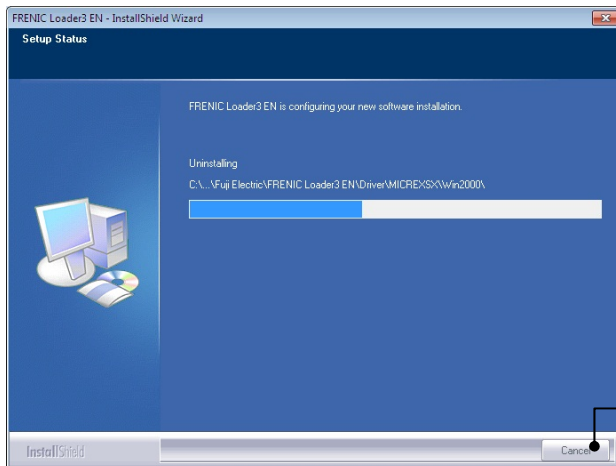

The uninstallation progress bar appears

To abort the uninstallation, click **Cancel**.

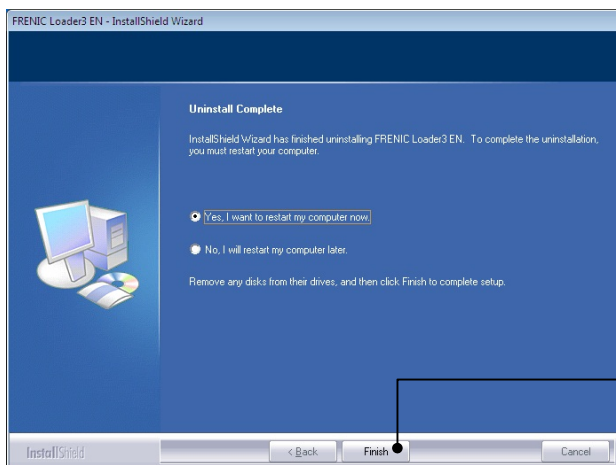

Upon completion of the uninstallation, the screen at left appears.

Select **Yes, I want to restart may computer now.** and then click **Finish**.

#### [ 4 ] From Setup icon Windows XP/Windows 2000

If uninstalling from the Start menu cannot start and the Problem with Shortcut dialog appears as shown below, uninstall Loader from the setup icon "FRENIC Loader3\_x V7xxx E with MM Setup.exe."

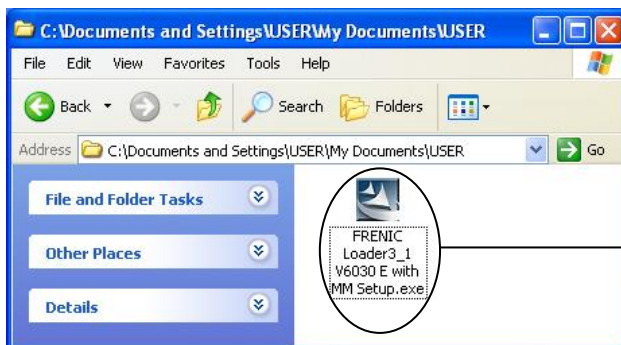
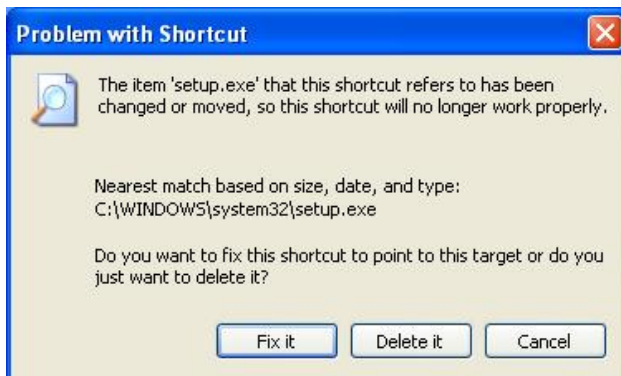

Double-click the FRENIC Loader3\_x V7xxx E with MM Setup icon. The exe automatically starts the installation wizard.

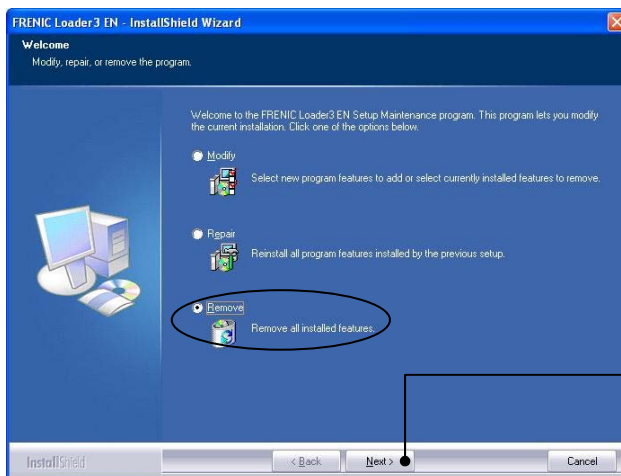

Select **Remove** and click **Next**.

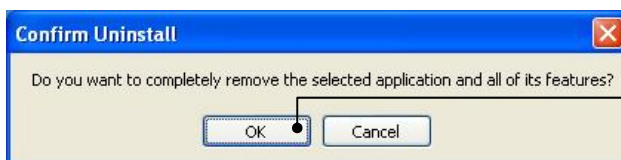

The confirmation screen at left appears.

Click **OK**.

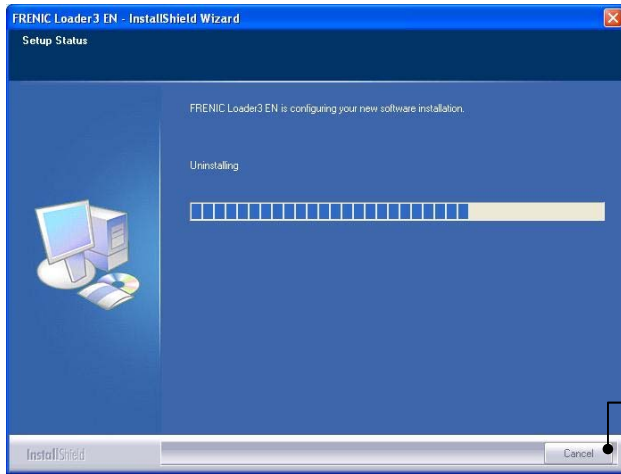

The uninstallation progress bar appears.

To abort the uninstallation, click **Cancel**.

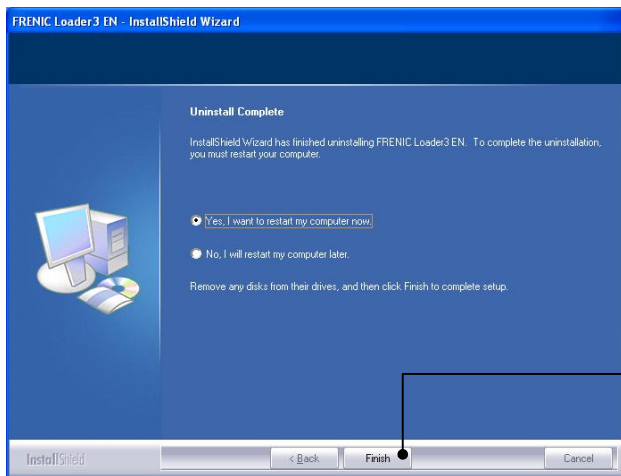

Upon completion of the uninstallation, the screen at left appears.

Select **Yes, I want to restart my computer now.** and then click **Finish**.

## 1.4 Configuring the Settings for Inverter(s) and Loader

This section describes the inverter and Loader settings to be configured before the use of Loader.

### 1.4.1 Configuring communication-related function codes in the inverter(s)

#### [ 1 ] Communication port 1

The table below lists inverter's function codes related to Loader. Configure those codes before connecting Loader to the inverter.

Function code	Name	Setting range	Factory default
y01	RS-485 Communication 1 (Station address)	1 to 255	1
y04	(Baud rate)	0: 2400 bps 1: 4800 bps 2: 9600 bps 3: 19200 bps 4: 38400 bps	3
y10	(Protocol)	0: Modbus RTU protocol <b>1: FRENIC Loader protocol (SX protocol)</b> 2: Fuji general-purpose inverter protocol	1

y01: Station address Set the y01 data to the same value as the RS-485 No. setting made in Loader's Device connection list (see Section 1.4.3.2 , [ 2 ]).

y04: Baud rate Set the y04 data to the same value as the baud rate setting made in Loader's Communication Setting window (see Section 1.4.3.1, [ 2 ]).

y10: Protocol Set the y10 data to "1" (FRENIC Loader protocol).

#### [ 2 ] Communication port 2

The table below lists inverter's function codes related to Loader. Configure those codes before connecting Loader to the inverter.

Function code	Name	Setting range	Factory default
Y11	RS-485 Communication 1 (Station address)	1 to 255	1
Y14	(Baud rate)	0: 2400 bps 1: 4800 bps 2: 9600 bps 3: 19200 bps 4: 38400 bps	3
Y20	(Protocol)	0: Modbus RTU protocol <b>1: FRENIC Loader protocol (SX protocol)</b> 2: Fuji general-purpose inverter protocol	0

y11: Station address Set the y11 data to the same value as the RS-485 No. setting made in Loader's Device connection list (see Section 1.4.3.2 , [ 2 ]).

y14: Baud rate Set the y14 data to the same value as the baud rate setting made in Loader's Communication Setting window (see Section 1.4.3.1, [ 2 ]).

y20: Protocol Set the y20 data to "1" (FRENIC Loader protocol).

---

## 1.4.2 Checking the COM port on the PC (when using a communications level converter)

Loader running on the PC uses the RS-232C communications port (COM) to interface with inverters.

When an **RS-232C–RS-485 converter** is connected to the PC, check what COM port number (COM#) on the PC is assigned to the RS-232C–RS-485 converter.

To use the USB interface, select a **USB–RS-485 converter** that functions as a virtual RS-232C communications port (COM). When a USB–RS-485 converter is connected, Windows automatically assigns a free COM port on the PC to the converter. To check the assignment, follow the procedure below.

### Windows 7/Windows Vista

From the **Start** menu, select **Control Panel | Hardware and Sound | Device Manager**.

### Windows XP/Windows 2000

From the **Start** menu, select **Control Panel | System | Hardware | Device Manager**.

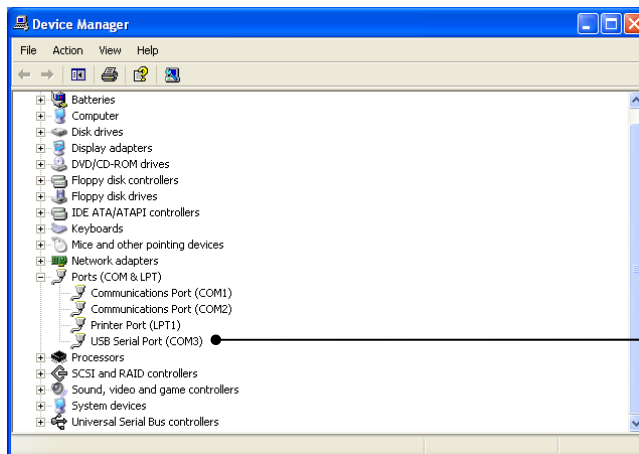

Click  preceding **Ports (COM & LPT)** to show details.

Check the number "n" in **USB Serial Port (COMn)**.

This example shows that **COM3** is assigned to the **USB Serial Port**.

### 1.4.3 Configuring Loader

When Loader has been installed on your PC, selecting **All Programs | FRENIC Loader3 EN | FRENIC Loader3.x EN Start** from the **Start** menu starts Loader.

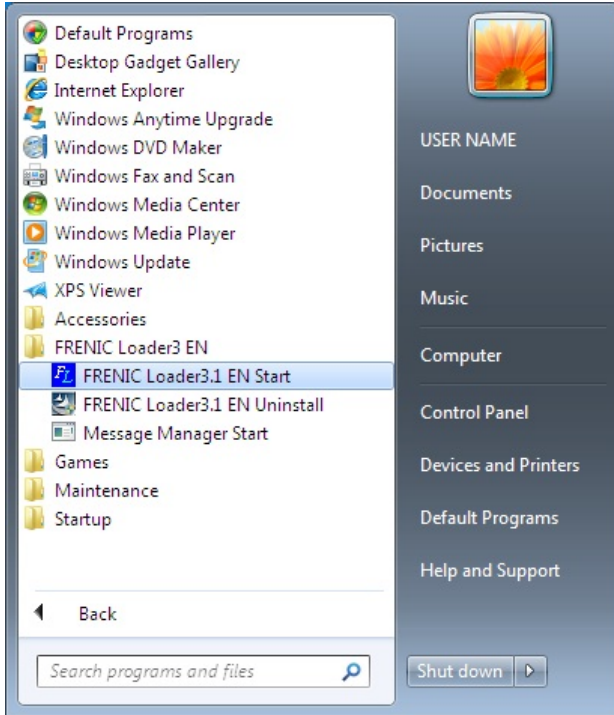



If Loader starts, the **Quick Access Menu** first appears as shown below.

This menu contains the 10 quick-start icons for the programs contained in Loader. To start a program, simply click the corresponding icon. Details of the programs are described in Chapter 2.

When using Loader for the first time or after having changed the supporting inverter(s), you need to configure the operating environment by setting up the communications parameters (**Com. Set.**) and the interface with the inverter(s) (**Connect**).

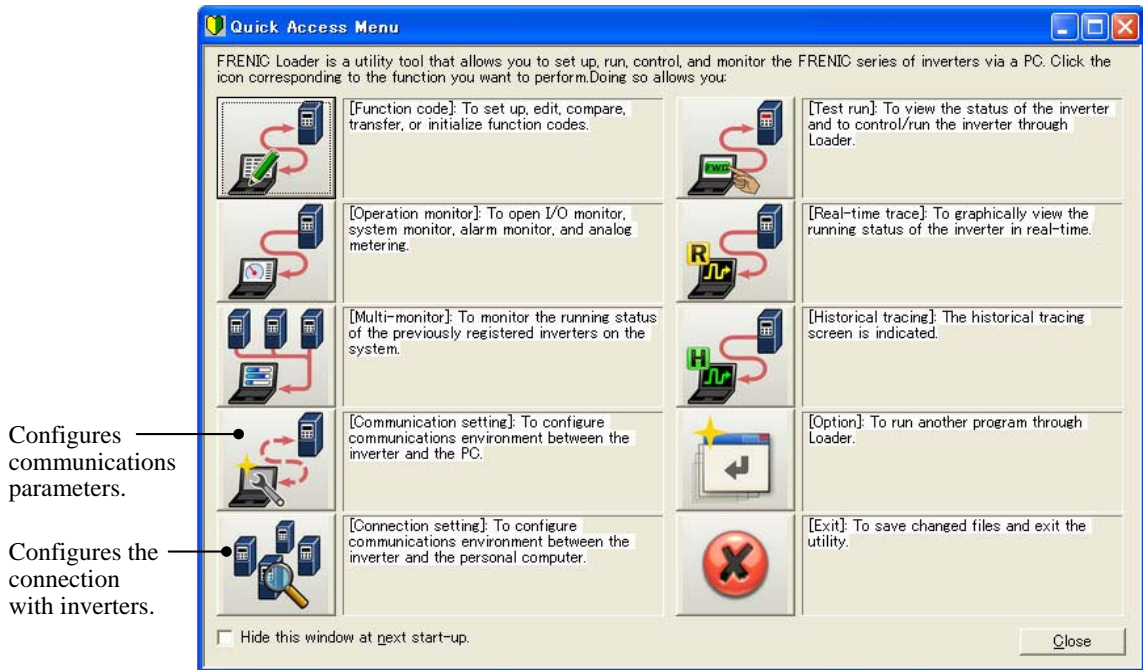
Click either the **Com. Set.** or **Connect** icon to open the **Communication Setting** dialog or **Device connection list** window, respectively.



**Note** If the Quick Access Menu is not displayed, click the  icon on the toolbar (shown below) at the bottom of the Loader top window to open the menu.



**Note** • If **USB: Data in keypad** has been selected in the **Communication Setting** window (see Section 1.4.3.1), [Multi-monitor], [Real-time trace], or [Historical tracing] cannot be selected.



### 1.4.3.1 Configuring communications parameters

Clicking the **Com. Set.** icon in the left row of the **Quick Access Menu** calls up the **Communication Setting** window (shown below) which provides a choice of ports (USB and RS-485), target memory to access (inverter memory and keypad memory), and communications conditions.

The **Communication Setting** window can also be called up from the menu bar on the Loader top window (shown in Section 2.1) by selecting **Setup | Communication Setup...**

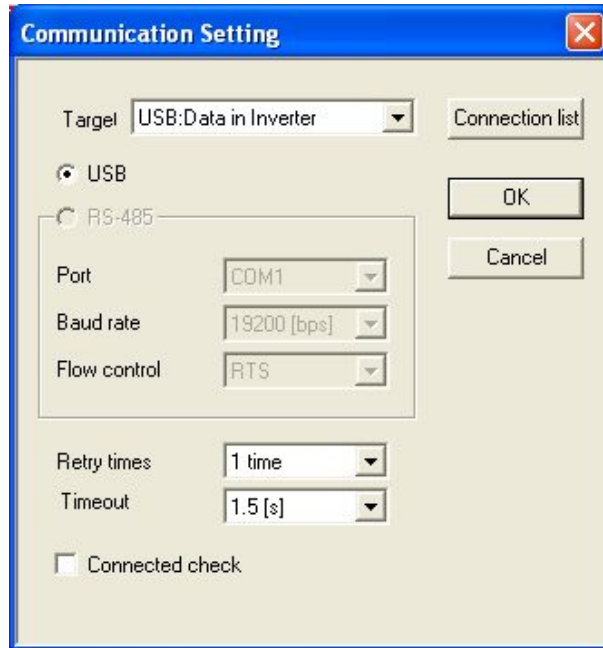

#### About "Target"

The inverter holds various data in its memory to control itself.

The keypad itself has also a memory that can be used to back up the data held in the inverter memory.

Loader can access data in both of the inverter memory and keypad memory as shown below.

The **Target** combo box provides a choice of three combinations of a port and target memory to access.

The following three combinations are provided in the **Target** combo box.

- **USB: Data in inverter** (FRENIC-MEGA/HF/Mini(C2S)/Ace only)  
Selecting this combination uses the USB port and accesses function code, running status monitor, real-time trace, and other data to be used in the inverter memory.
- **USB: Data in keypad** (FRENIC-MEGA/HF/Mini(C2S) only)  
Selecting this combination uses the USB port and accesses function code, running status monitor, and other data held in the keypad memory.
- **RS-485: Data in inverter**  
Selecting this combination uses the RS-485 port and accesses function code, running status monitor, real-time trace, and other data to be used in the inverter memory.

#### Ports and Target Memory to Access

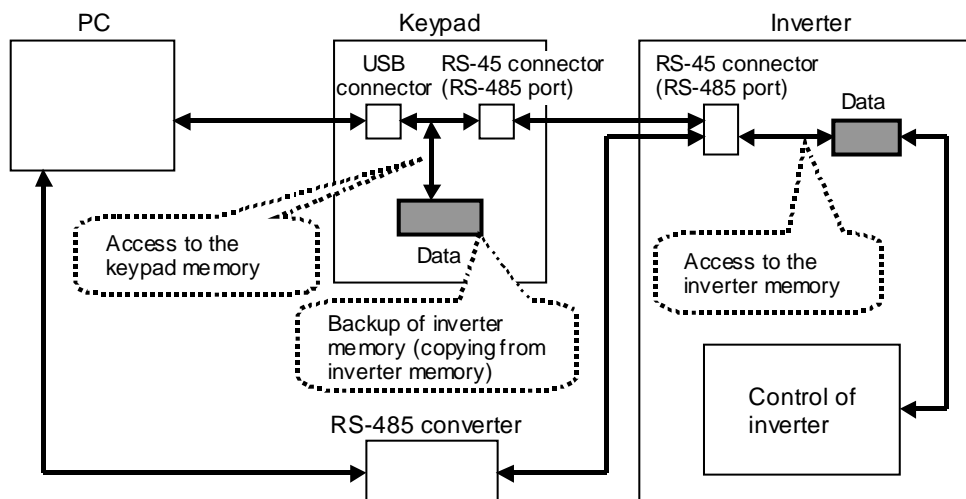

## [ 1 ] For connection to USB port (FRENIC-MEGA/HF/Mini(C2S)/Ace only)

### ■ Target

Select the desired combination of the port and memory to access.

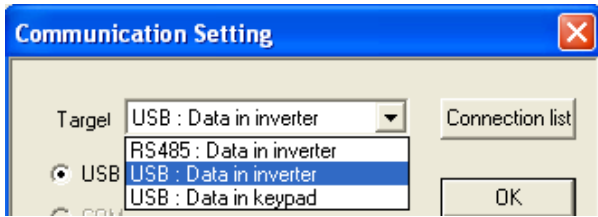

### - USB: Data in inverter

Select this choice to connect the PC to the USB port and access data in the inverter memory.

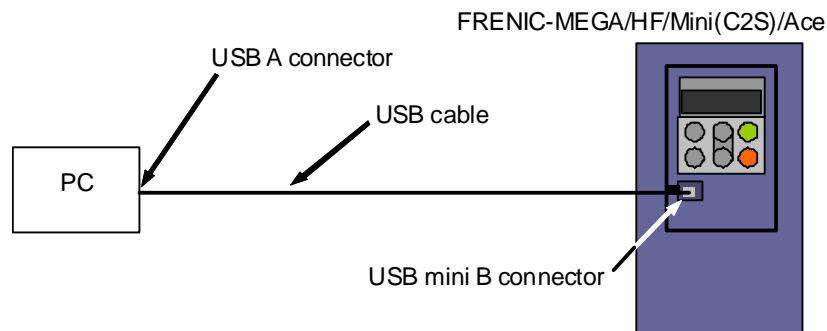

### - USB: Data in keypad

Select this choice to connect the PC to the USB port and access data in the keypad memory.

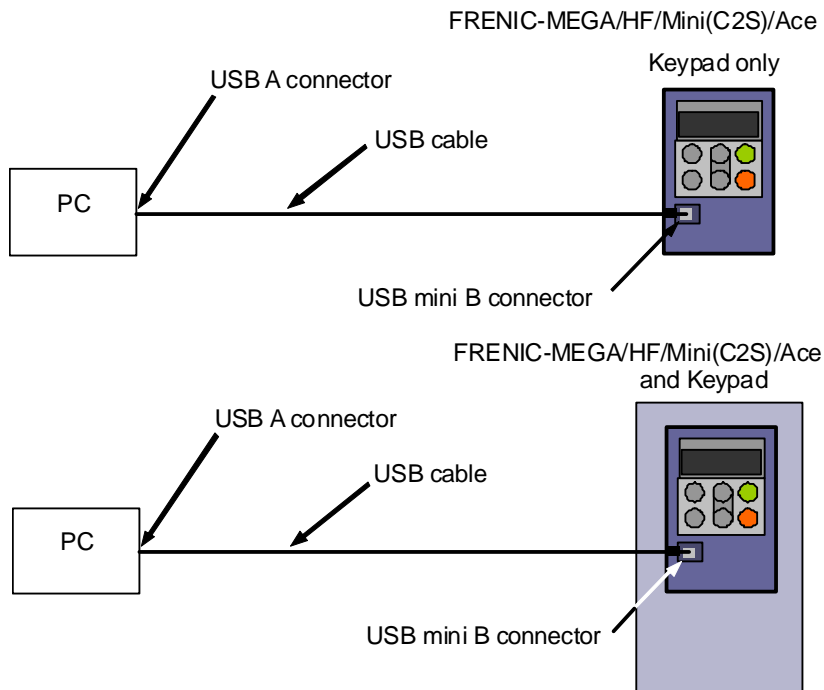

- Note**
- Selecting **USB: Data in keypad** in the **Communication Setting** window disables [Multi-monitor], [Real-time trace], and [Historical tracing].
  - When dealing with data via USB connection by "Data in the Keypad", the firmware version of TP-E1U is required to be 1600 or later in FRENIC-Ace series.
  - To edit the function code relating to customizable logics, select [E2S Custom] button from "New" menu and open the editing window (Only available for FRENIC-Ace).

## ■ USB

Selecting "USB: Data in inverter" or "USB: Data in keypad" in the **Target** combo box automatically selects the USB radio button.

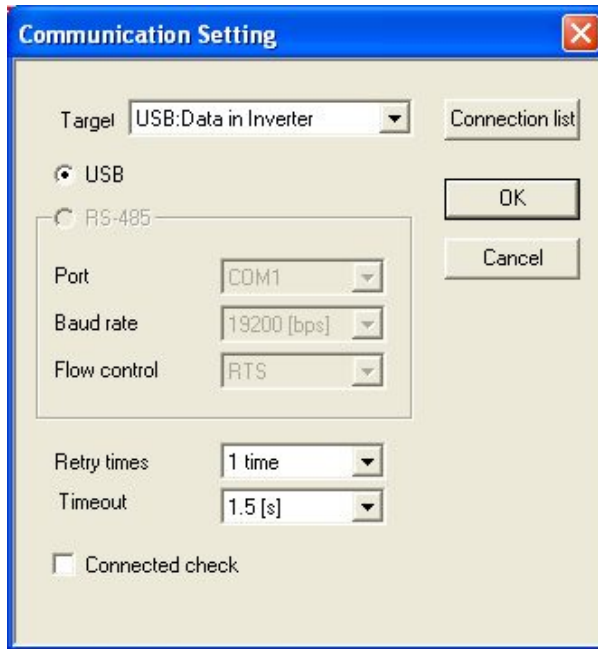

### Retry times

Select the number of times for retry upon failure of a transmission. If a large number is selected, the feasibility of successful transmission may be high.

Note that, however, it may take a long time to show failure of the transmission after retrying.

The recommended setting is one or more.

### Timeout

If Loader receives no response from the inverter within the time specified in this box, the communications error dialog automatically opens.

The shorter the timeout setting, the faster the dialog will open. Setting a too short timeout, however, may result in a false transmission error due to the long internal processing time of the inverter although the transmission itself is successful.

The recommended setting is 1.5 seconds.

After completion of data entry, check the settings again and click **OK** to exit the communications setting operation.

### Port

### Baud rate

### Flow control

When **USB** is selected, these settings are invalid.

### Connected check

This feature always monitors the communications status between Loader and inverter(s) registered by the Device connection list and displays the status on the status bar of the Loader top window.

Select the check box to enable this feature.

If Loader cannot communicate with the registered inverter due to a wire break, for example, the response time becomes very long.

## [ 2 ] For connection to RS-485 port

### ■ Target

Select the desired combination of the port and memory to access.

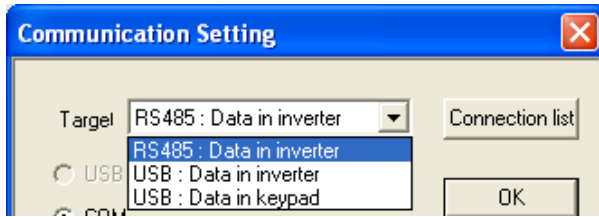

### - RS-485: Data in inverter

Select this choice to use the RJ-45 connector (RS-485 port) on the inverter via an RS-232C–RS-485 or USB–RS-485 converter and access data in the inverter memory.

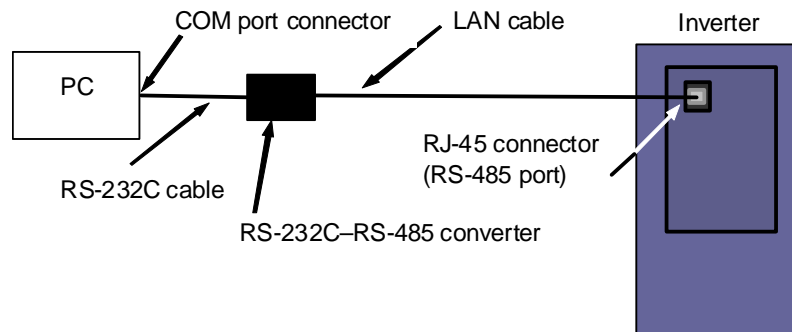
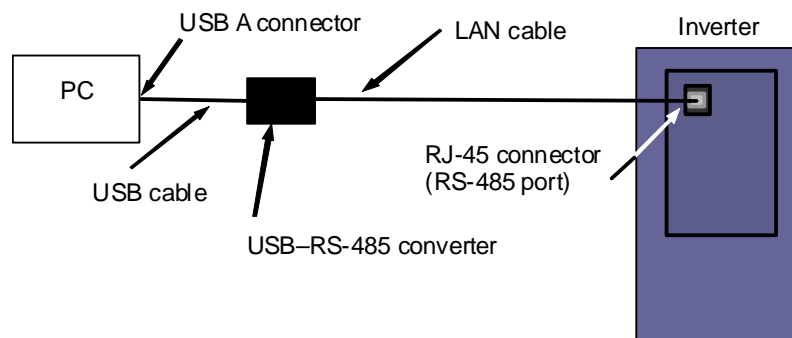

**Note** To connect the PC to the RJ-45 connector (RS-485 port) on the inverter, remove the keypad from the inverter.

## ■ RS-485

Selecting "RS-485: Data in inverter" in the **Target** combo box automatically selects the RS-485 radio button.

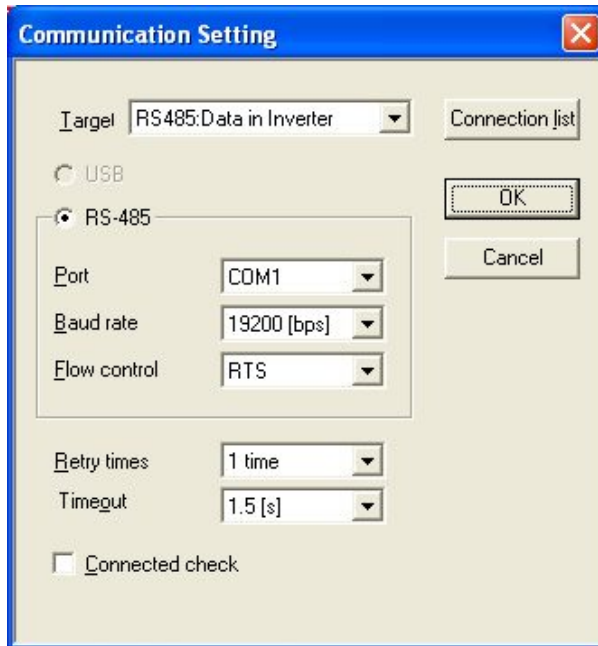

### Retry times

Select the number of times for retry upon failure of a transmission. If a large number is selected, the feasibility of successful transmission may be high.

Note that, however, it may take a long time to show failure of the transmission after retrying.

The recommended setting is one or more.

### Timeout

If Loader receives no response from the inverter within the time specified in this box, the communications error dialog automatically opens.

The shorter the timeout setting, the faster the dialog will open. Setting a too short timeout, however, may result in a false transmission error due to the long internal processing time of the inverter although the transmission itself is successful.

If Loader is managing a single inverter, the recommended setting is 1.5 seconds; if it is managing two or more inverters, the setting is "1.5 x number of inverters."

### Port

Select the PC's COM port to which the RS-232C–RS-485 converter is connected. (See Section 1.4.2 "Checking the COM port on the PC.")

### Baud rate

The rate should be identical to that of the inverter. The recommended rate is 19200 bps. If the transmission between the PC and inverter is erratic due to noise or other factors, however, you will need to slow down the rate.

### Flow control

As Loader does not support flow control, no setting is required. Flow control refers to a system using the RS-232C hardware control signal to switch send/receive of RS-485 signals. Refer to Section 1.2.3.3, "[ 1 ] Communications level converters" for details.

### Connected check

This feature always monitors the communications status between Loader and inverter(s) registered by the Device connection list and displays the status on the status bar of the Loader top window.

Select the check box to enable this feature.

If Loader cannot communicate with any one of registered inverters due to a wire break, for example, the response time becomes very long. If it happens, remove such an inverter from the Device connection list, referring to Section 1.4.3.2.

After completion of data entry, check the settings again and click **OK** to exit the communications setting operation.

### 1.4.3.2 Configuring connection settings

Clicking the **Connect** icon in the left row of the **Quick Access Menu** calls up the **Device connection list** window (shown below) which provides information on equipment (such as inverters and keypad) available.

The **Device connection list** window can also be called up from the menu bar on the Loader top window (shown in Section 2.1) by selecting **Setup | Connection Setup...**

#### [ 1 ] For connection to USB port (FRENIC-MEGA/HF/Mini(C2S)/Ace only)

##### When "USB: Data in inverter" is selected

Only a single line appears as shown below. After making sure that the equipment name and RS-485 No. (station address) are correct, click the **Browse** button to monitor the current communications link status. If they are not correct, double-click the row (or use the **Advance...** button) to call up the **Advanced** dialog shown below and modify the contents.

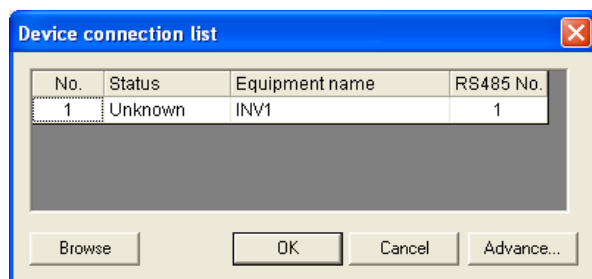

##### **Browse**

Clicking this button checks whether a link between Loader and the inverter is established. The result appears in the Status column.

##### Status column

- Unknown: The communications status has been unknown.
- Connecting: The communications link has been established.
- Disconnected: The communications link has not yet been established.

##### **Advance...**

Clicking the row to be modified and clicking this **Advance** button calls up the **Advanced** dialog shown at the right.

Clicking the **OK** button returns to the **Device connection list** window.

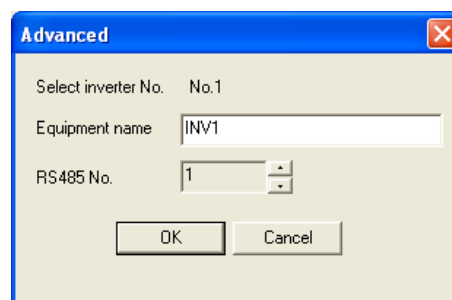

After completion of data entry, check the settings again and click **OK** to exit the device connection operation.

 **Note** The **RS-485 No.** (station address) should be the same as the data of function code y01.

**When "USB: Data in keypad" is selected**

Only a single line appears as shown below. After making sure that the equipment name and KP No. are correct, click the **Browse** button to monitor the current communications link status. If they are not correct, double-click the row (or use the **Advance...** button) to call up the **Advanced** dialog shown below and modify the contents.

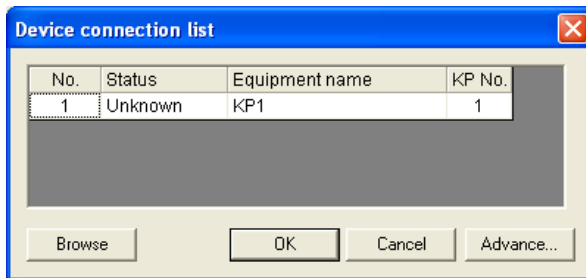
**Browse**

Clicking this button checks whether a link between Loader and the keypad is established. The result appears in the Status column.

**Status column**

- Unknown: The communications status has been unknown.
- Connecting: The communications link has been established.
- Disconnected: The communications link has not yet been established.

**Advance...**

Clicking the row to be modified and clicking this **Advance** button calls up the **Advanced** dialog shown at the right.

Clicking the **OK** button returns to the **Device connection list** window.

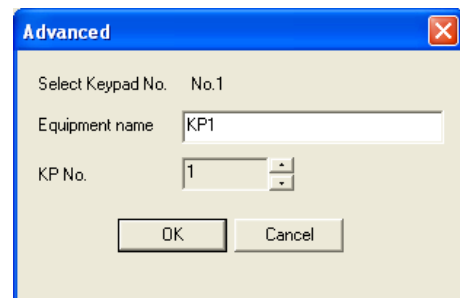

After completion of data entry, check the settings again and click **OK** to exit the device connection operation.

**Note** The **KP No.** should be set to "1." Do not specify any other number.

## [ 2 ] For connection to RS-485 port

### When "RS-485: Data in inverter" is selected

The **Device connection list** window shows the inverters available for RS-485 communication.

Double-clicking (or use the **Advance...** button) the row where the inverter to be modified or added is listed calls up **Advanced** dialog shown below.

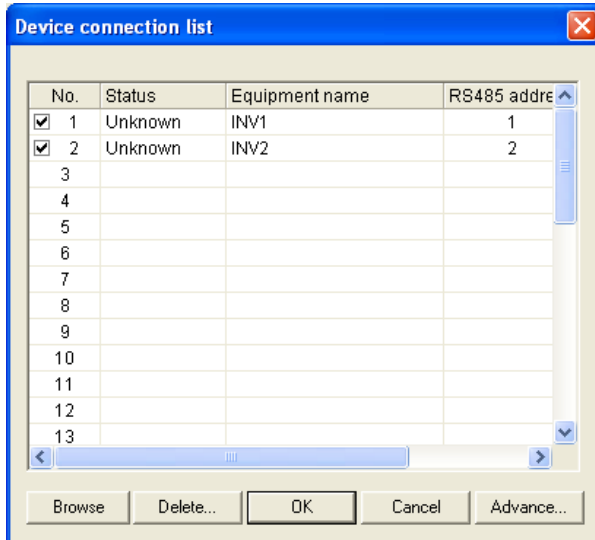

### **Selection of inverters to be monitored**

To make an inverter enable to be monitored, put a check mark (✓) in the box located at the left end column of the list.

The following buttons allow you to perform advanced settings.

### **Delete**

Clicking the row to be deleted and clicking this **Delete** button deletes the inverter listed in that row. Use this for the inverter(s) that has been disconnected from Loader.

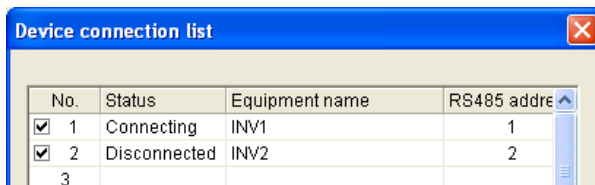

### **Browse**

Clicking this button checks whether a link between Loader and the inverter(s) (marked with ✓) is established. The result appears in the Status column.

### Status column

- Unknown: The communications status has been unknown.
- Connecting: The communications link has been established.
- Disconnected: The communications link has not yet been established.

### **Advance...**

Clicking the row to be modified or added and clicking this **Advance** button calls up the **Advanced** dialog shown at the right.

Fill in the **Equipment name** and **RS-485 address** (station address) boxes in the dialog and click **OK**. To cancel your entry or selection, click **Cancel**.

Clicking the **OK** button returns to the **Device connection list** window.

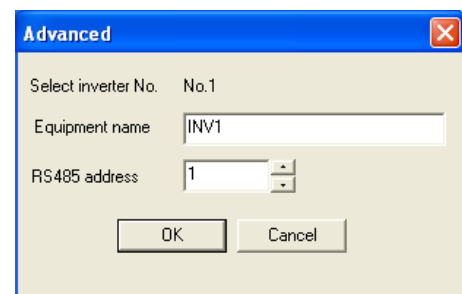

After completion of data entry, check the settings again and click **OK** to exit the device connection operation.



### 1.4.3.3 Communication log file

Communication log file "SLOADER.TXT" is stored in the loader installed folder.

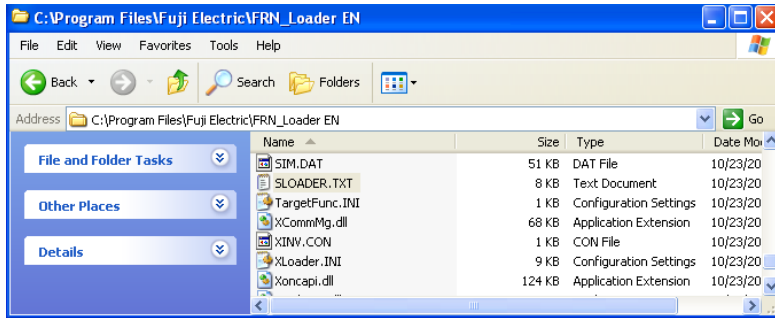



---

## **Chapter 2**

# **Functions of FRENIC Loader**

This chapter contains descriptions of typical functions of FRENIC Loader 3.x.



## 2.1 Top Window of FRENIC Loader 3.x

When Loader starts, first the top window shown below appears which normally contains **Quick Access Menu** (shown on page 1-23). (In the example below, the **Quick Access Menu** is omitted.)

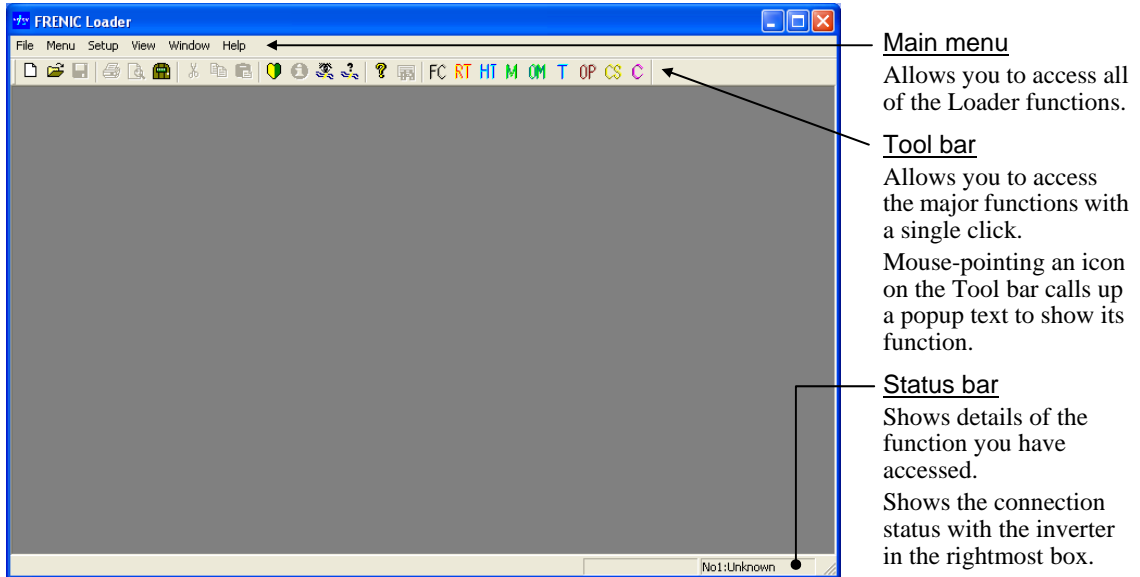

### Main menu

The main menu contains six commands. **File**, **Menu**, **Setup**, **View** and **Help** are active even if there is nothing displayed in the window. **Window** will be active only when any window is opened. These commands except **Setup** are detailed in Sections 2.2 through 2.6. For details about **Setup**, see Sections 1.4.3.1 and 1.4.3.2.

### Tool bar

Using the tool bar easily accesses frequently used functions. To open a function code file stored in the PC from the toolbar, for example, just click the  icon, while two actions--**Menu** | **Open**--are required to open the file from the main menu.

### Status bar

The status bar shows the running status of Loader at all times. Also, to find out what an icon or menu means, simply place the mouse cursor over it and a text explaining it will pop up in the left part of the status bar.

When **Connected check** (shown in Section 1.4.3) is selected, the box at the right end of the status bar shows the connection status with inverters at all times.

## 2.2 File

This section describes main commands contained in the **File** menu.

### 2.2.1 New

Creates a new file of function code data.

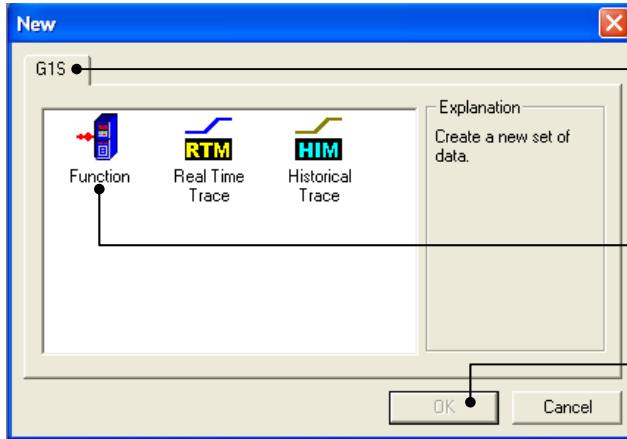

**Selection tab for the inverter model**

Shows the model number of available inverters.

FRENIC-MEGA: G1S

**Icon for a file to be created**

Shows the icon for a new function code data file.

**OK**

Executes selection. (This button becomes active if any file is selected.)

Selecting **File | New** opens a function code data file that Loader has by default, in the function code edit list format. You can edit the function code data even if the communications link between Loader and inverter is not established.

### 2.2.2 Open

Reads out the selected one of the existing data files (e.g., function code data, real-time trace data, historical trace data) saved in the PC and opens the edit window.

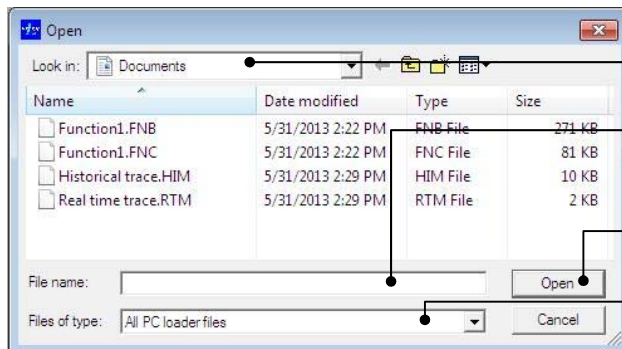

**Look in**

Selects folder location of the file.

**File name**

Shows the name of selected file. You can also type a new file name.

**Open**

Opens the file selected.

**Files of type**

Selects the file type (extension). To show all the files, select **All PC loader files**.

#### File extensions

\*.FNB: Function code data file (Customized logic)

\*.FNC: Function code data file

\*.HIM: Historical trace data file

\*.RTM: Real-time trace data file



**Note** Do not select the connection setting item "USB:Data in Keypad" at reading the trace data (HIM / RTM) file.

### 2.2.3 Print setup

Specifies the available printer, paper size, print orientation and other features needed to print the data.

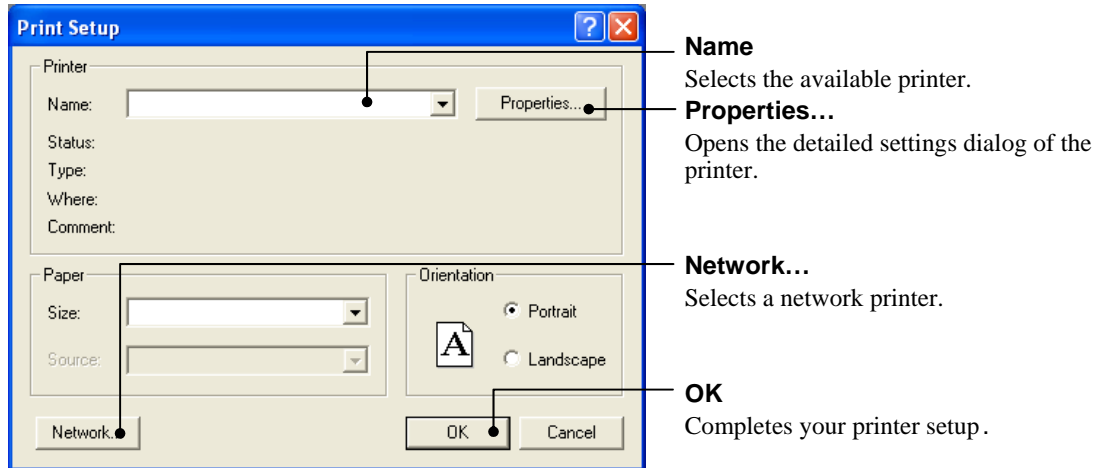

### 2.2.4 Exit

Exits Loader.

## 2.3 Menu

This menu provides the following commands:

- Trace (Section 2.3.5)
- Multi-monitor (Section 2.3.3)
- Operation monitor (Section 2.3.2)
- Function code setting (Section 2.3.1)
- Test-run (Section 2.3.4)
- Quick access menu (Section 2.3.6)
- Options (Section 2.3.7)

### 2.3.1 Function code setting

Selecting **Menu | Function code setting** calls up the **Editing data** window (shown below) where you select the target data--New file, File saved in the PC, or File configured in the inverter.

Selecting the target data and clicking **OK** opens the target function code data file that has the four tabs--**Function code edit**, **Auto-tuning**, **Comparison**, and **File Information** as shown on the next page.

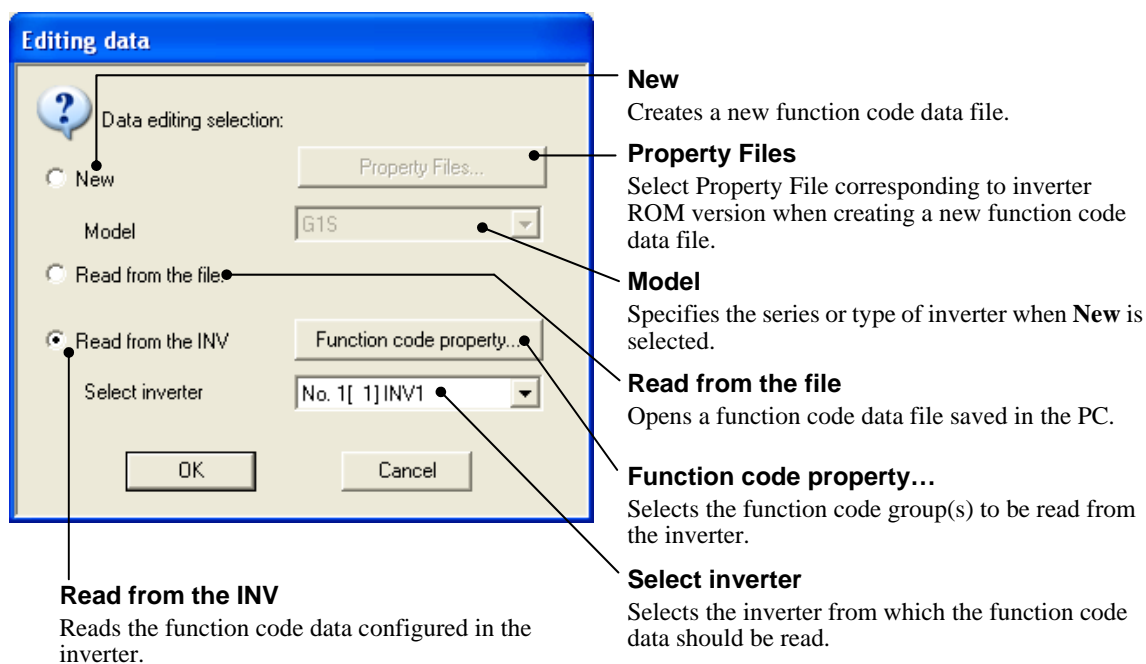

Selecting **New** in the above window opens a function code data file that Loader has by default, in the function code edit list format. You can edit the function code data even if the communications link between Loader and inverter is not established.

**Note** To edit the function code relating to customizable logics, select [E2S Custom] button from "New" menu and open the editing window.



### 2.3.1.1 Function code edit

In the **Function code edit** window showing the function code data, its setting range, and other attributes, you can edit the function codes. Descriptions for button and combo-box functions in the window are given below.

Code group: Lists function codes by group.

Change from factory defaults: Lists function codes whose data has been changed from factory defaults. (Except communications-related codes)

Contents of change (in red): Lists edited function codes not yet written into an inverter.

User definition: Lists function codes defined by the user.

Code for communication: Lists function codes used for communication.

Comparison result: Lists only comparison results with function codes stored in the inverter or saved in Loader.

Search result: Lists only search results commanded by **Edit | Search**.

Setting value  
Select function code data listed in the drop-down menu in the edit window.

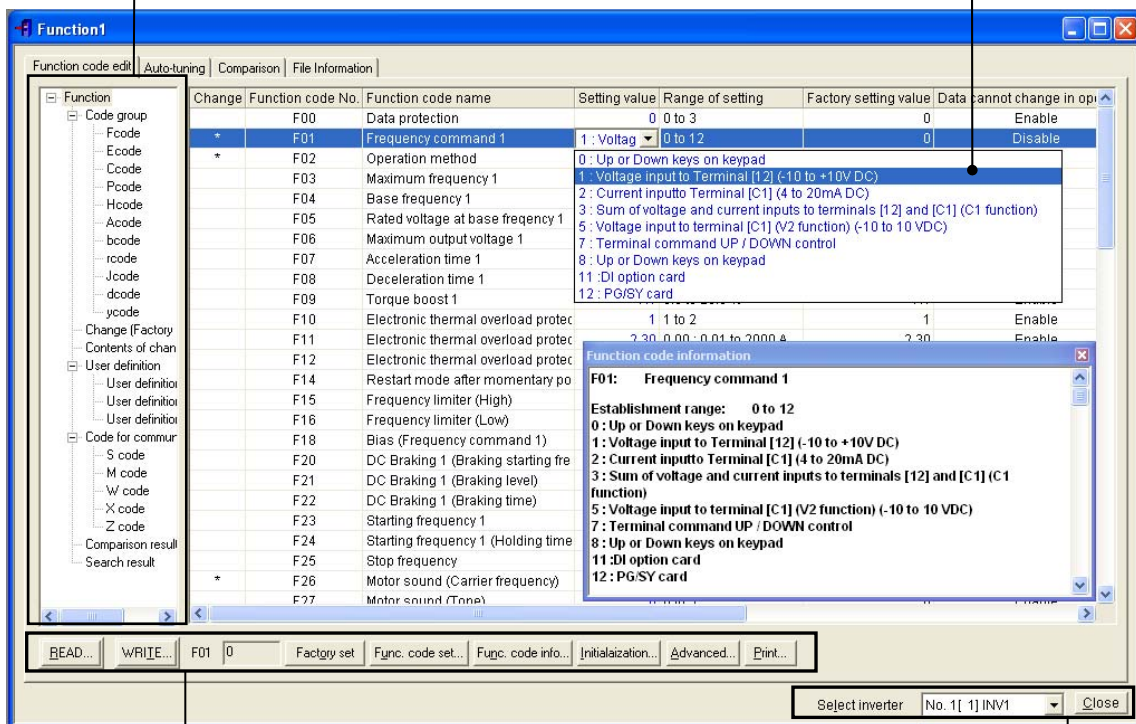

**READ...**: Reads the data from the inverter selected in **Select inverter**.

**WRITE...**: Writes data saved in Loader into the inverter selected in **Select inverter**.

**Factory set**: Reverts the data of the selected function code to the factory default.

**Func. code set...**: Shows the data of the selected function code in the edit window.

**Func. code info...**: Shows information of the selected function code in the window.

**Initialization...**: Initializes all function code data in the inverter selected at **Select inverter**.

**Advanced...**: Calls up the Advanced setting dialog for **Display items...**, **Function code attribute**, and **Print setting...**.

**Print...**: Prints function codes selected in the hierarchy tree in the left pane.

**Select inverter**: Select the inverter to which the data is to be sent.

**Close**: Closes the Function code edit window.

---

## [ 1 ] Reading function code data stored in the inverter

### To read out function code data from an inverter first time after Loader starts

In the **Editing data** dialog (shown below) called up by selecting **Menu | Function code setting**, select **Read from the INV** and click **OK**.

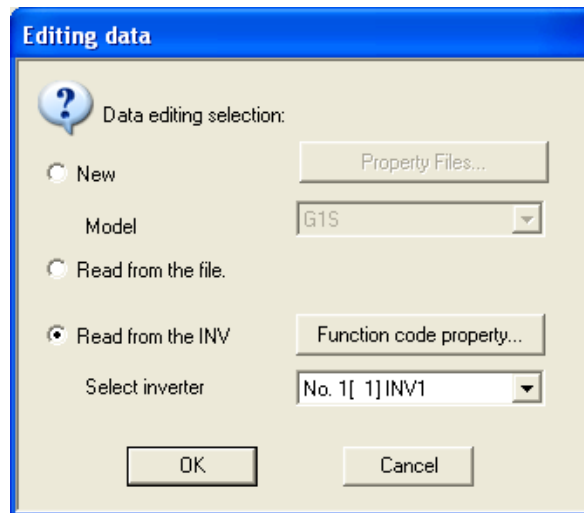

### To update the function code data already read from the inverter

Click the **READ...** button at the bottom of the **Function code edit** window to call up the dialog below. Clicking **OK** starts reading the function code data from the inverter.

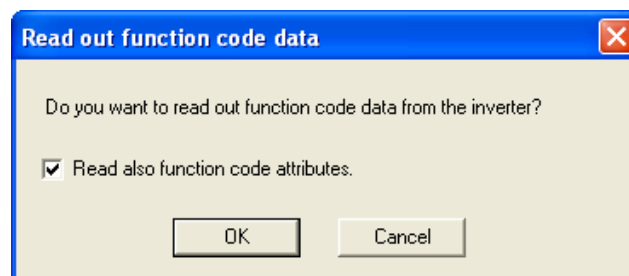

 **Note** Data reading command is not accepted when the selected inverter model is different from the target model.

### To read out the function code together with its attribute

If you place the ✓ mark in the head-box of **Read also function code attributes** in the dialog above, Loader reads the function code data altogether its default setting, minimum value, maximum value and other attributes from the inverter.

To specify what is the function code group you want to read the function code attributes, first call up the **Advanced...** dialog shown below by clicking **Advanced...** at the bottom of the **Function code edit** window. Then click **Func. code attributes...** in the dialog to open the **Function code property** dialog.

Place the ✓ mark(s) in the head-box(es) of the function code(s) you want to read the code(s) with its attribute(s). To do so for all function codes, place the ✓ mark in the head-box of **All function codes**.

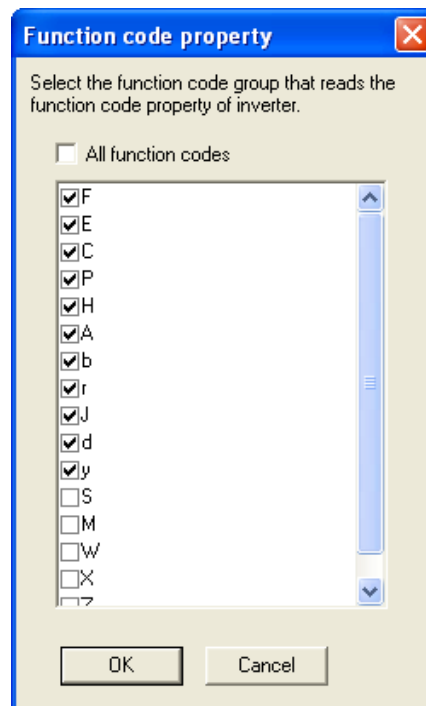
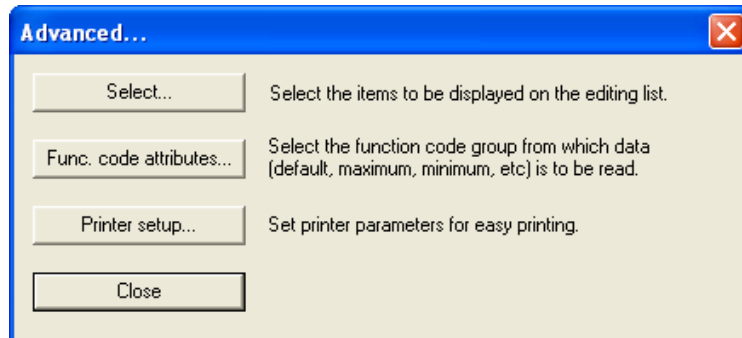

## [ 2 ] Changing the function code data

The function code data change procedure differs depending upon the property of function codes, as shown below.

- (1) For function codes whose data is a numeric value such as frequency, time, or voltage, double-click the Range of setting column of the listed function code. The Range of setting dialog will appear. Enter a numeric value directly or select it by clicking the list box handles in the dialog.

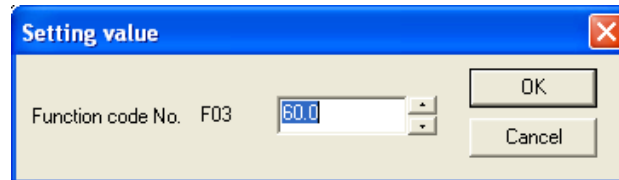

- (2) For function codes whose data specifies the inverter function -- for example, F00 (1: Protect data)/01 (1: Frequency setting by voltage input)/02 (0: Run/stop by keypad), click the Setting value column of the listed function code. A combo-box will appear. Click ▼ to show the data you can select in the dropdown menu.

Setting value	Range of setting	Factory setting value	Data cannot change i
0	0 to 3	0	Enable
1 : Voltag ▼	0 to 12	0	Disable
0 : Up or Down keys on keypad 1 : Voltage input to Terminal [12] (-10 to +10V DC) 2 : Current input to Terminal [C1] (4 to 20mA DC) 3 : Sum of voltage and current inputs to terminals [12] and [C1] (C1 function) 5 : Voltage input to terminal [C1] (V2 function) (-10 to 10 VDC) 7 : Terminal command UP / DOWN control 8 : Up or Down keys on keypad 11 : DI option card 12 : PG/SY card			

- (3) In the **Function code edit** window, clicking the **Func. Code info.** button or double-clicking the function code name on the function code row calls up a popup text below, which gives you more detail information of the function code. Furthermore, just clicking another row switches contents of the text for the new function code while this text is shown.

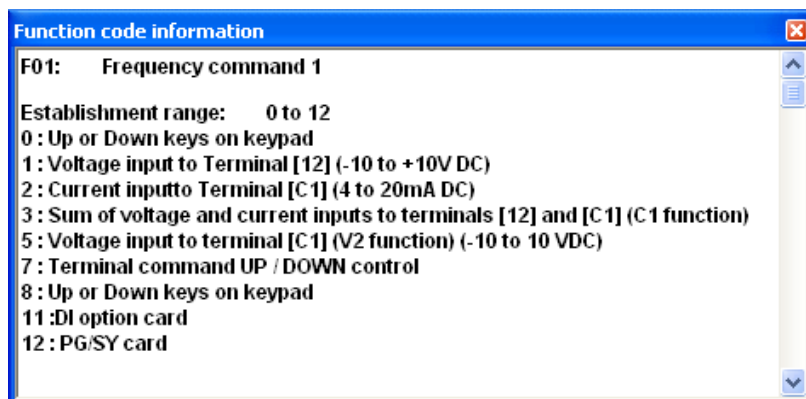

**Note** Selected data that has not been written into the inverter is shown in red on the list.

**Note** If the selected data differs from the factory default, it will be marked with an asterisk (\*) in the first column of the list.

### [ 3 ] Writing function code data into the inverter from Loader

Click the **WRITE...** button at the bottom of the **Function code edit** window to call up the following window. Follow the instructions on the window.

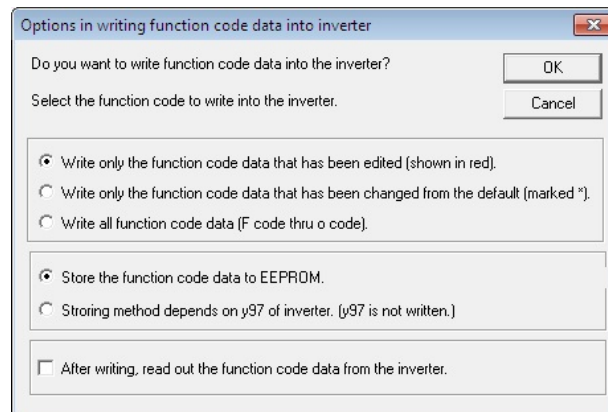

**Note** Data writing command is not accepted when the selected inverter model is different from the target model.

**Note** Function code data not written into the inverter successfully is displayed in pink. The possible causes of the failure are listed below.

- Attempting to write to function codes not allowed to be changed during running
- Attempting to write to read-only function codes
- Attempting to write to function codes that cannot be written via the communications link
- Editing via the communications link not allowed (e.g., writing S codes when H30 = 0)

- Note**
- In case 'Store the function code data to EEPROM', after writing function code data, the settings are stored to EEPROM in the inverter. At the condition that y97 is written, y97 setting is also stored in EEPROM.
  - In case 'Storing method depends on y97 of inverter', after writing function code data, it is determined depending on y97 of inverter whether store the data to EEPROM. Regardless of the writing method, y97 setting is not written.
  - At the model in which y97 does not exist, the function code data settings are stored to EEPROM.

#### [ 4 ] Notes in writing function code data into inverters whose rated power inputs or capacities are different from each other

**Note** It is impossible for the inverters whose rated power inputs are different each other to write the identical data of function code with the data-copy attribute of "1." Further, also impossible for the inverters whose rated power inputs or capacities are different each other to write the identical data of function code with the data-copy attribute is "2."

For function codes with the data-copy attribute is "0" the identical data set is written into any inverters unconditionally.

##### Data copy attributes

Numeric in Data Copy column	Description
0	Writes the copied data into the inverter unconditionally.
1	Does not write the data into the inverter whose rated input differs from original one's.
2	Does not write the data into the inverter whose rated input or rated capacity differs from original one's.

Example:

Change	Function code No.	Function code name	Setting value	Data Copy
	F00	Data protection	0	0
	F01	Frequency command 1	0	0
	F02	Operation method	2	0
	F03	Maximum frequency 1	60.0	0
	F04	Base frequency 1	50.0	0
	F05	Rated voltage at base frequency 1	200	1
	F06	Maximum output voltage 1	200	1
	F07	Acceleration time 1	6.00	0
	F08	Deceleration time 1	6.00	0
	F09	Torque boost 1	4.9	0
	F10	Electronic thermal overload protec	1	0
	F11	Electronic thermal overload protec	22.50	2
	F12	Electronic thermal overload protec	5.0	0

## [ 5 ] Saving function code data into the PC

To save the function code data listed in the Loader window or dialog into the PC's file, select **File | Save** or **File | Save As...**

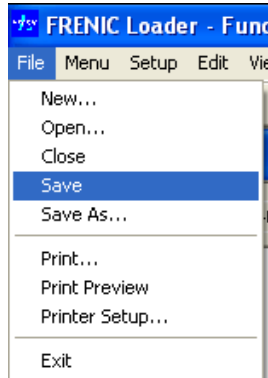

At the time of first data saving, even selecting **File | Save** calls up the **Save As...** dialog shown below. Select a folder in the **Save In** box and type a filename in the **File name** box, and then click the **Save** button.

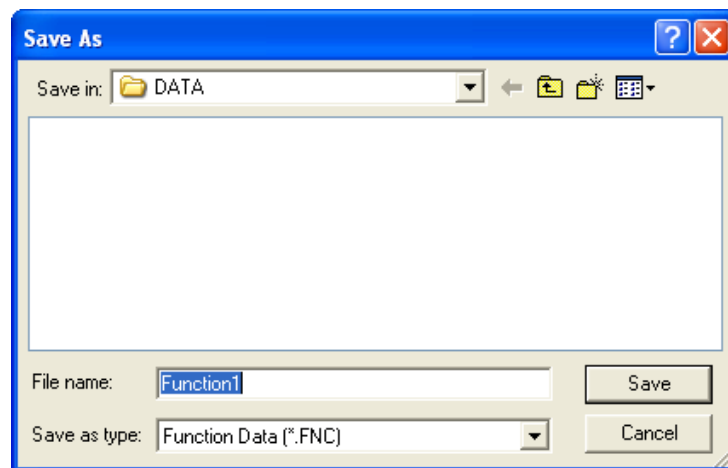

In addition to the folder selection and filename entry as above, in order to change the file type (filename extension), click the arrow next to **Save as type** to show the pull-down list, then click the desired type as shown below.

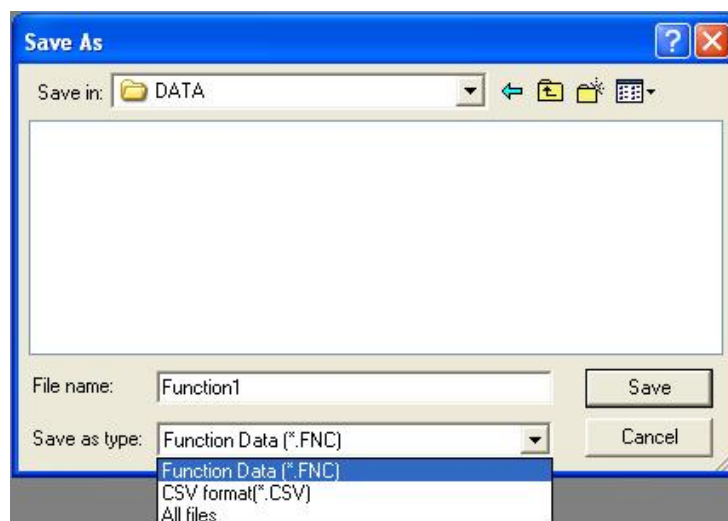

- \*.FNC: File format exclusive to Loader. This can be opened only by the general-purpose inverter loader.
- \*.CSV: Comma-separated values format. This can be opened by Microsoft Excel and others, but cannot be opened by the general-purpose inverter loader.

## [ 6 ] Initializing the function code data stored in the inverter

To initialize the function code data stored in the inverter currently selected, click the **Initialization...** button at the bottom of the **Function code edit** window. The **Function code initialization** dialog appears as shown below. Click  in the Function code combo box, select the target code, and click **OK**.

Refer to manual for details.

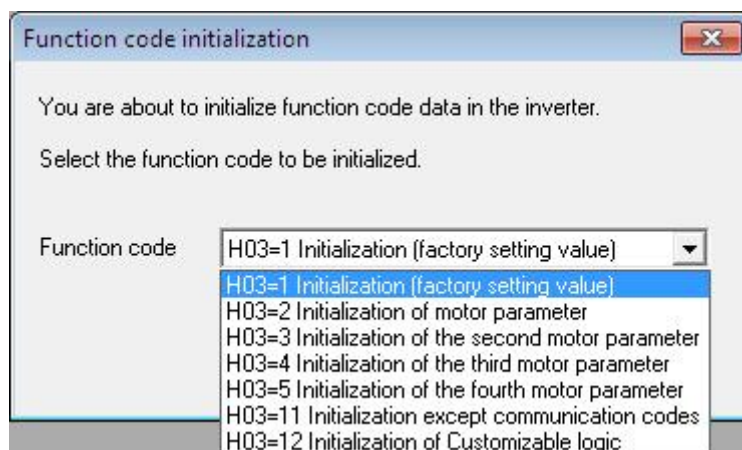

Select	To
H03 = 1 Initialization (factory setting value)	Initialize all function codes to factory defaults.
H03 = 2 Initialization of motor 1 parameters	Initialize P codes to factory defaults, except P02 (Rated capacity) and P99 (Motor 1 selection).
H03 = 3 Initialization of motor 2 parameters	Initialize A codes to factory defaults, except A16 (Rated capacity) and A39 (Motor 2 selection).
H03 = 4 Initialization of motor 3 parameters	Initialize b codes to factory defaults, except b16 (Rated capacity) and b39 (Motor 3 selection).
H03 = 5 Initialization of motor 4 parameters	Initialize r codes to factory defaults, except r16 (Rated capacity) and r39 (Motor 4 selection).
H03 =11 Initialization except communication codes	Limited initialization (initialization other than communications function codes): Communication can be continued after initialization. (Only Ace)
H03 =12 Initialization of Customizable logic	Limited initialization (initialization of customizable logic function U codes only) (Only Ace)



## [ 7 ] Printing the function code data list

Click **Function** or **Code group** in the hierarchy tree in the left pane of the **Function code edit** window to show function code/code group of F, E, C, ....

To print a function code list, select **File | Print...** in the main menu of Loader top window or click the **Print** button at the bottom of the **Function code edit** window. The **Print** dialog shown below appears.

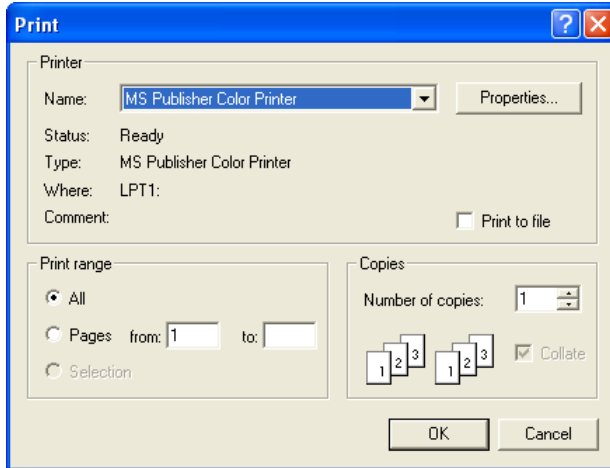

Specify the printer to use, the print range and the number of copies, and then click **OK**.

To check or reconfigure the printer shown in the **Name** combo box, click **Properties....**

### To quick-print

To print only the function codes (F. No.) and their setting data out of the items listed in the **Function code edit** window, click the **Advance...** button at the bottom of the window to call up the **Advanced...** dialog shown below.

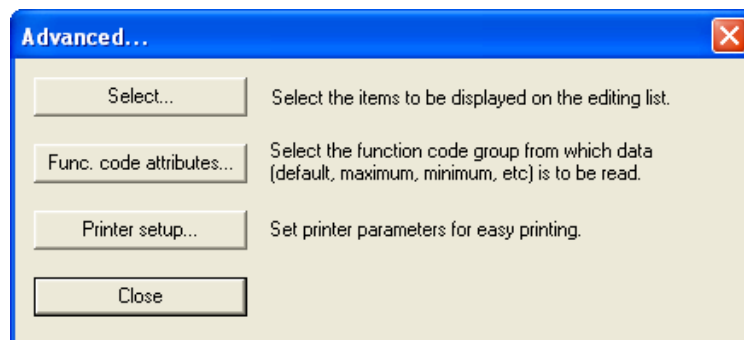

Click **Printer setup...** to call up the **Print setting** window shown below.

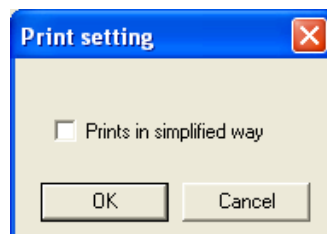

In the window shown above, place the  mark at **Prints in simplified way** and click **OK**. Note that this action only specifies a print format and does not start printing.

### Print preview

To preview what to print before actual printing, select **File | Print preview** in the Loader main menu.

## [ 8 ] Displaying user-selected function codes only (User definition)

In the **Function code edit** window, select the desired function code and right-click on it to show the user definition menu as shown below. Left-click on the desired user definition group (1, 2, or 3), and the function code is registered as an item of the selected user-definition group.

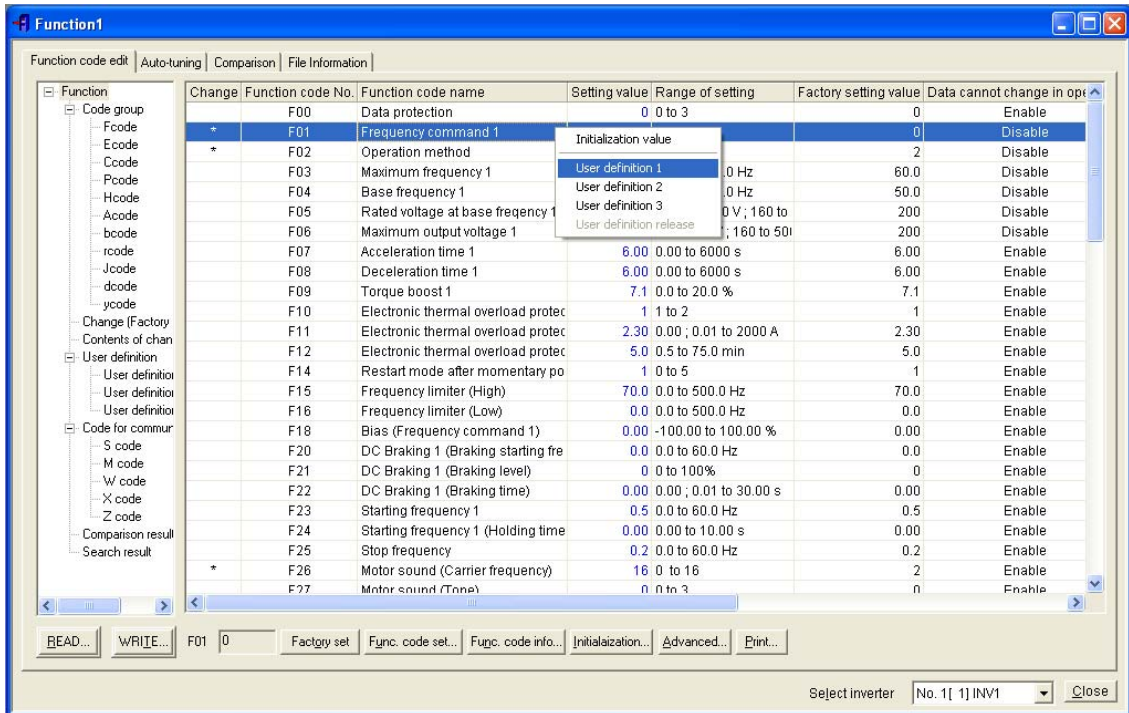

In the hierarchy tree in the left pane of the **Function code edit** window, click any of **User definition 1** to **3**, and the function codes that have been registered appear.

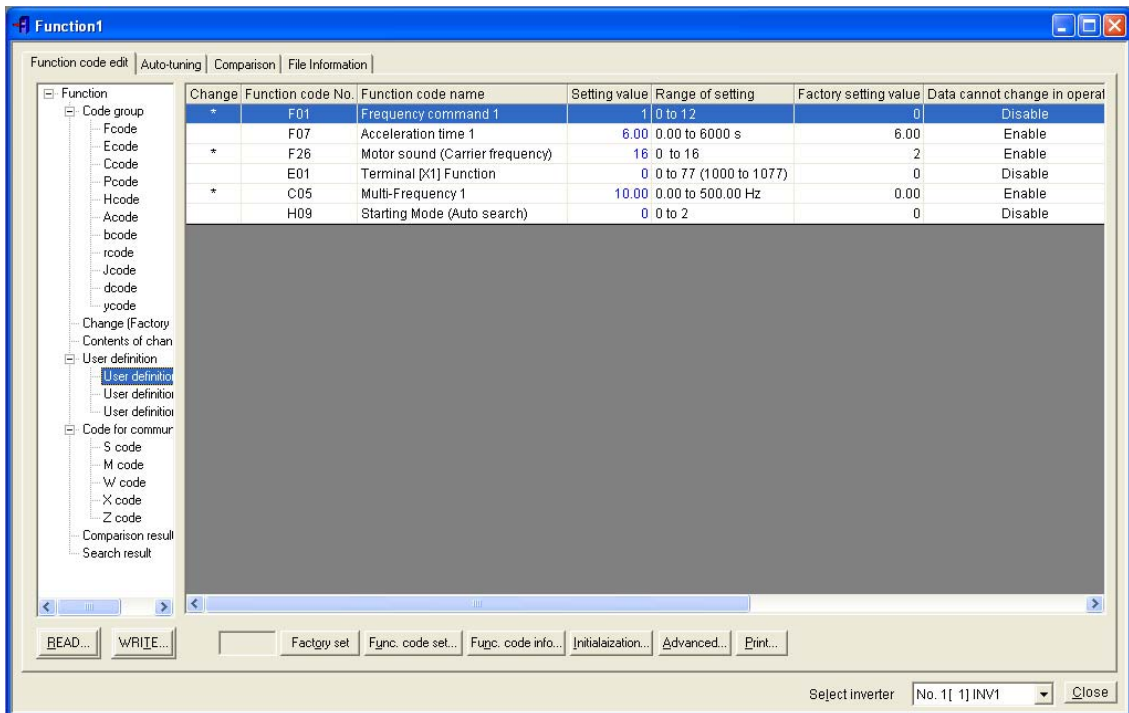

To deregister a function code from a user definition group (1, 2, or 3), select the target function code and right-click on it to show the user definition menu as shown below. Left-click on the **User definition release**, and the function code is deregistered from the function code group.

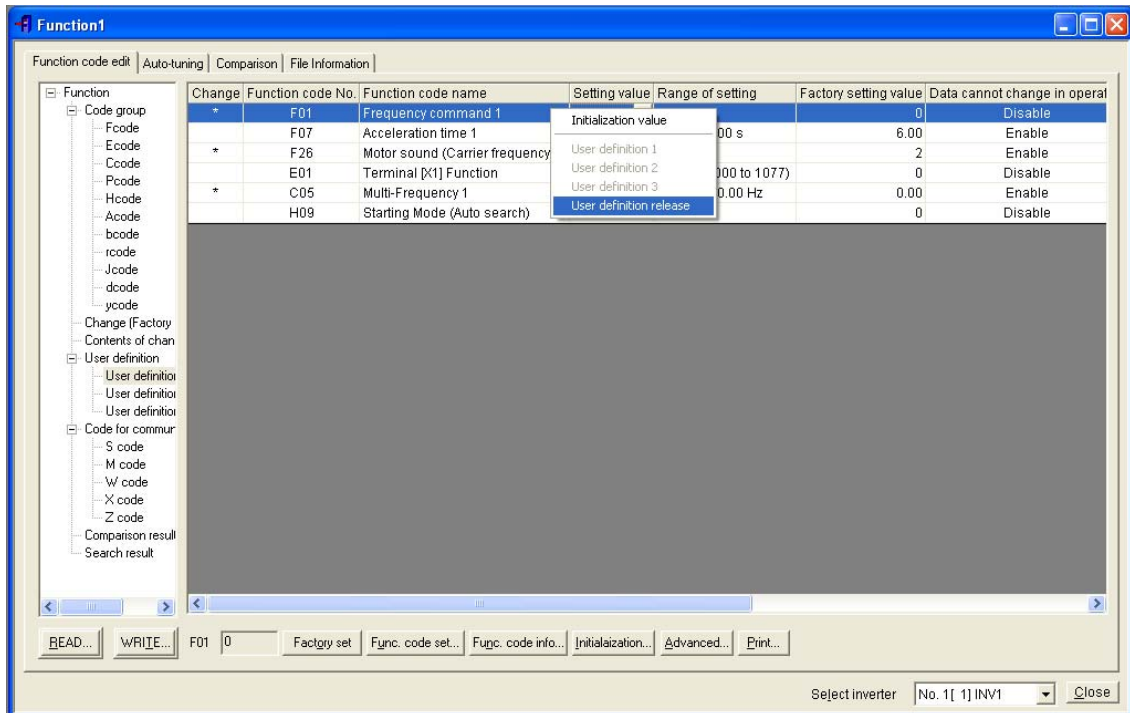

## [ 9 ] Searching for a character string in function code names

When the **Function code edit** window is displayed, select **Edit | Search** from the main menu. The **Search** dialog shown below appears.

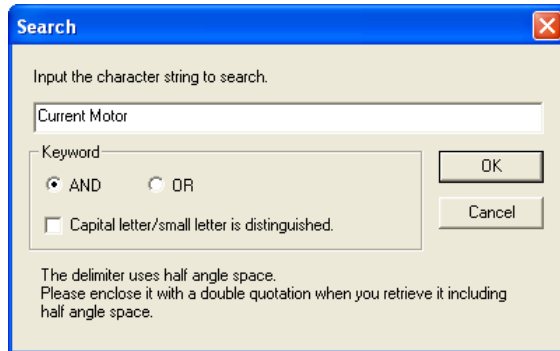

In the **Input the character string to search** box, enter a string (keyword) you want to search for, e.g., frequency, current, and voltage. In the example shown at the left, "current" is entered. Then click **OK**.

If function codes including the keyword are found, Loader automatically switches to **Search result** in the hierarchy tree in the left pane and lists function codes whose names contain the keyword in the right pane.

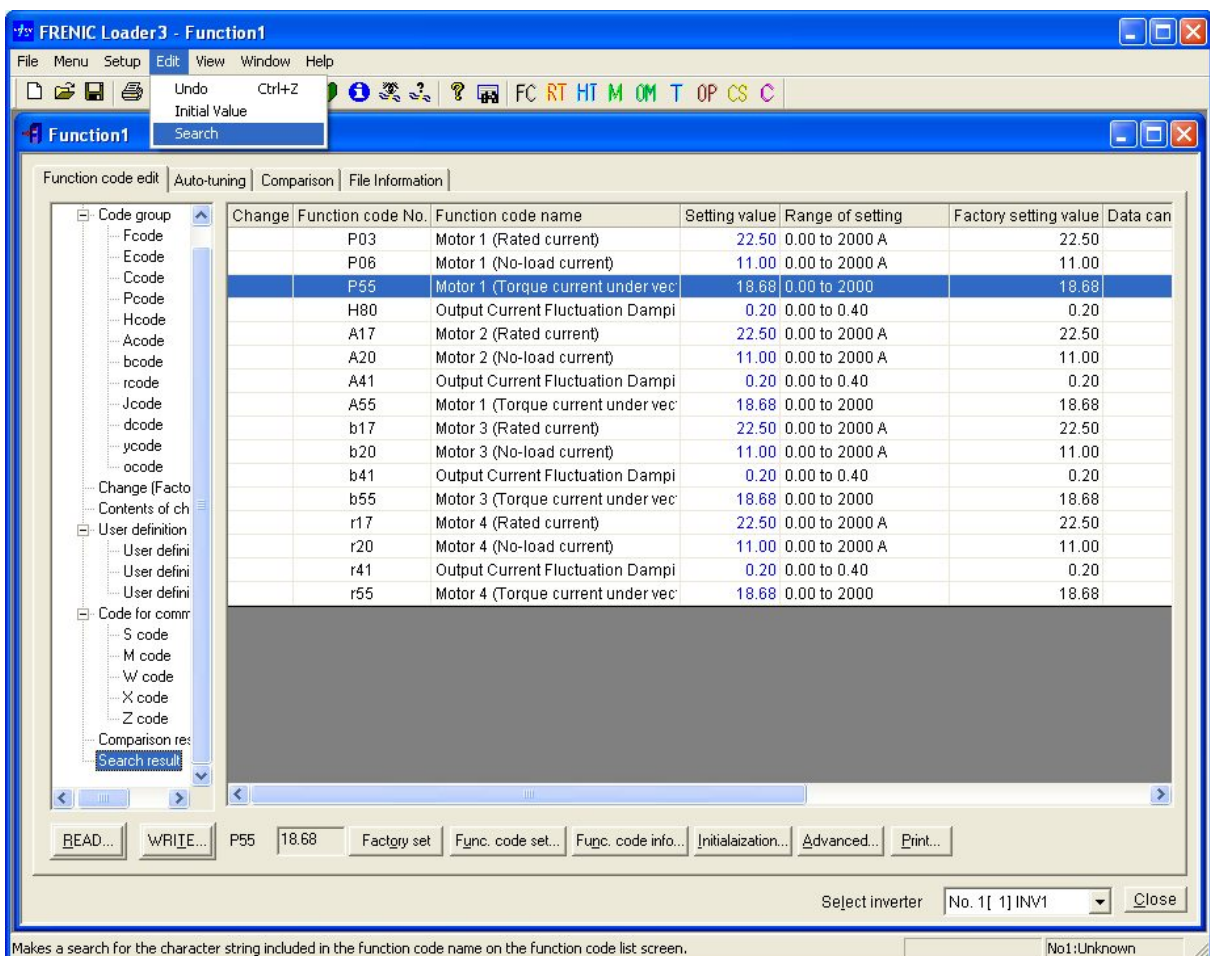

- **Note** Target fields for search include all items such as Change, Function code No., Function code name, Range of setting, etc. They also include items hidden by **Advanced | Display items**.
- The content of **Func. code info...** are not included in target fields for search.

### 2.3.1.2 Auto-tuning

Selecting the **Auto-tuning** tab displays the window shown below.

Auto-tuning automatically measures motor parameters for motors 1 to 4 and saves them as data of the corresponding function codes, using function codes P04 (Motor 1, Auto-tuning), A18 (Motor 2, Auto-tuning), b18 (Motor 3, Auto-tuning), and r18 (Motor 4, Auto-tuning).

**Selecting Motor**

Select any of motors M1 to M4 whose parameters are to be auto-tuned. (See below for details.)

**Selecting motor tuning options**

Select the motor parameter to be auto-tuned.

**Processing status**

This shows the current status of auto-tuning in progress.

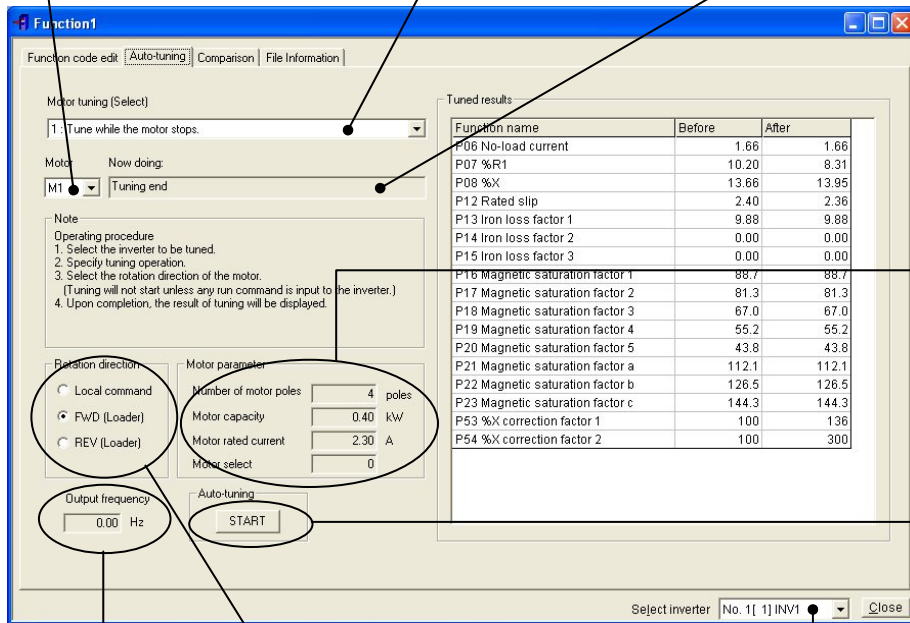

**Motor parameters**

This shows the motor parameters stored in the target inverter.

**Auto-tuning control**

Start the auto-tuning.

**Output frequency**

This shows the current output frequency of the inverter.

**Rotation direction**

Select the rotation direction of the motor. (See below for details.)

**Select inverter**

Select the target inverter to auto-tune the motor.

Motor tuning (Select) of FRENIC-MEGA is shown below. Other than FRENIC-MEGA, please refer to User Manual of the inverter.

**Motor tuning (Select)**

- 0: Disable
- 1: Tune while the motor stops (Tune %R1, %X, and rated slip frequency.)
- 2: Tune while the motor is rotating under V/f control (Tune %R1, %X, rated slip frequency, no-load current, magnetic saturation factors 1 to 5, and magnetic saturation extension factors "a" to "c.")
- 3: Tune while the motor is rotating under vector control (Tune %R1, %X, rated slip frequency, no-load current, magnetic saturation factors 1 to 5, and magnetic saturation extension factors "a" to "c." Available only when the vector control is enabled.)

**Rotation direction**

- Local command: Follow the external terminal command **FWD** or **REV**. (Available only when F02 = 1 (External digital signal input).)
- FWD (Loader): Run the motor forward. (Available only when Loader can run the inverter.)
- REV (Loader): Run the motor reverse. (Available only when Loader can run the inverter.)



- Selecting FWD or REV forces you to choose "2" or "3" for the frequency/run command in Test-running. (See Section 2.3.4 "Test-running.")
- Auto-tuning tab is not displayed with FRENIC-Mini.



### 2.3.1.3 Comparison

To compare the function code data currently being edited with those configured in the selected inverter or with those saved in the specified file, click the **Comparison** tab in the **Function code edit** window.

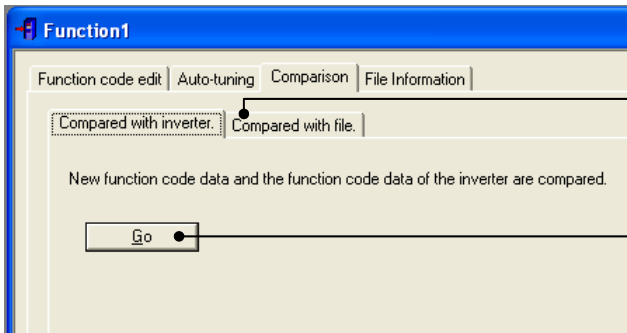

Compared with inverter

Compares the function code data being edited on Loader with those configured in the inverter.

**Go**

Runs the comparing program.

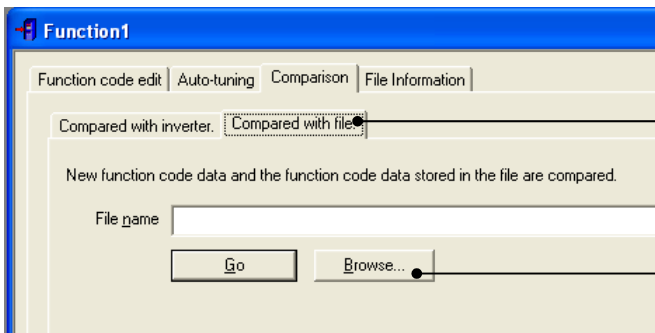

Compared with file

Compares the function code data being edited on Loader with those stored in the file on the PC.

**Browse...**

Browses the directory of the file.

Before stating comparison, click ▼ of the **Select inverter** combo-box at the bottom of the Function code edit window to show all inverters available in the dropdown menu, and select one.

Loader lists the comparison result, which includes only those function code data that differ each other, in the **Comparison** window shown below.

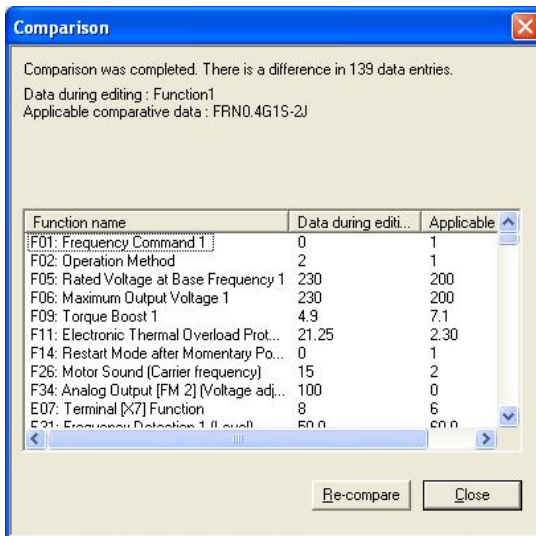

How to update the comparison result

To update the comparison result when this window is displayed, click **Re-compare**.

Even after the above **Comparison** window is closed, selecting **Comparison result** in the hierarchy tree in the **Function code edit** window shows the comparison result as shown below.

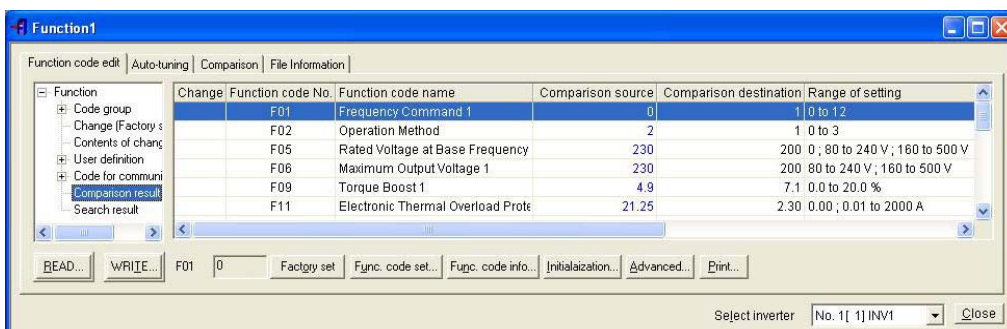

### 2.3.1.4 File information

Click the **File information** tab in the **Function code edit** window displays information that affects function code data. In this window, you can arbitrarily change **Region spec.**, **Voltage**, **Capacity**, and **Current definition file**.

- If **Read from the INV** is selected in the **Editing data** window, this **File information** window shows the inverter's data.
- If **New** is selected in the **Editing data** window, this window shows default data for the inverter type.

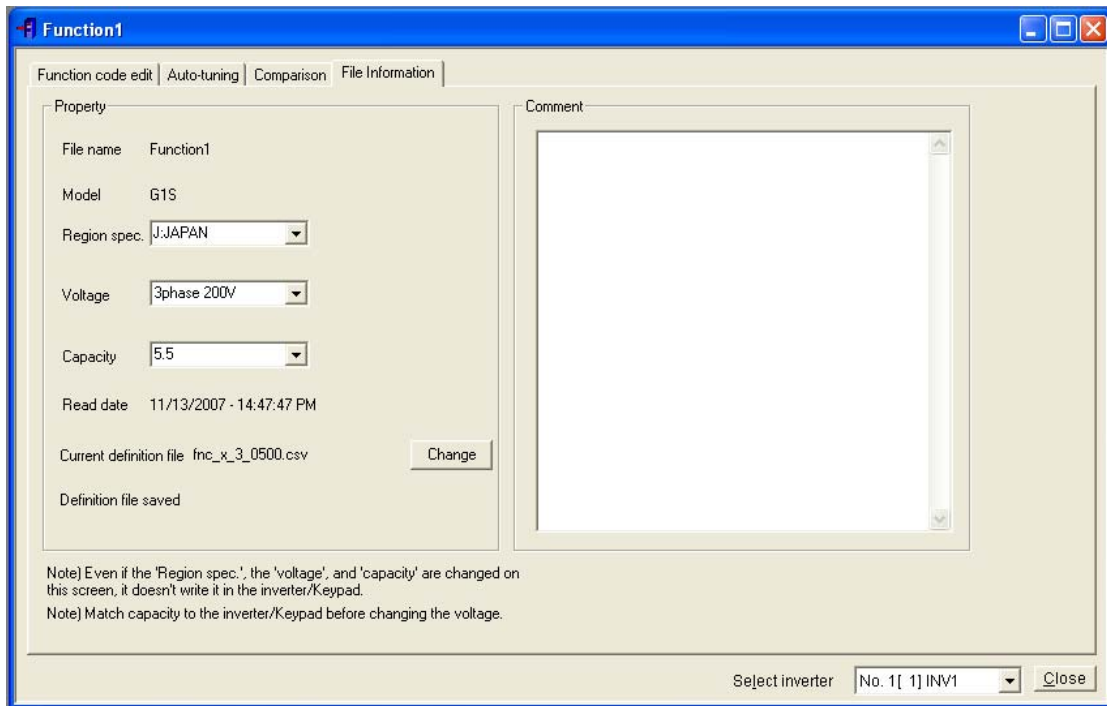

TYPE: Type of inverter (e.g.: In the case of FRENIC-MEGA.

The example below is different from the format of the actual product type.)

**FRN5.5G1S-2E**

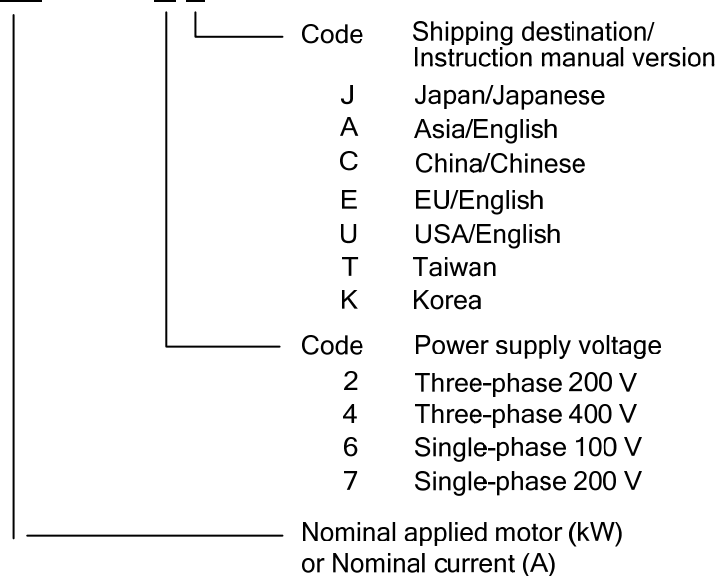

**Note** 'S' of "G1S" is fixed display (example above) since the FRENIC-loader can not identify the model with built-in EMC filter or the model without one.

## [ 1 ] Changing the region

You can change the region (shipping destination) of the inverter whose function code data is currently listed in the **Function code edit** window. Changing the region automatically modifies the factory default, minimum, and maximum values of function codes to the values suited for the region.

For details of function codes whose data differs depending on the region, refer to the inverter's instruction manual prepared for each region.

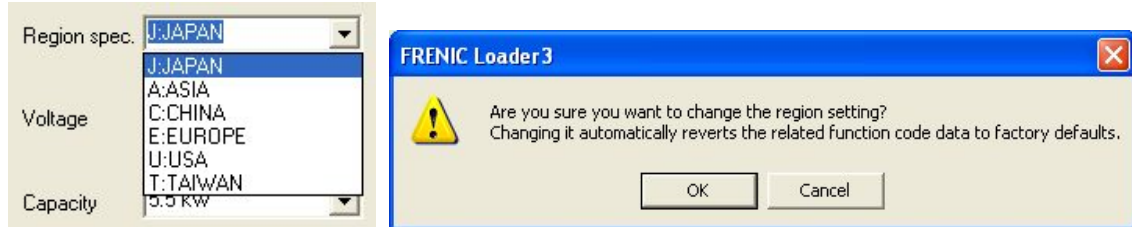

- Note**
- As shown in the dialog box above, changing the region initializes all function code data—even those that have been changed from the factory defaults. Save the current data before changing the region, if necessary.
  - Do not select the item "-" which indicates to the unsupported region.

## [ 2 ] Changing the input power supply voltage

You can change the input power supply voltage of the inverter whose function code data is currently listed in the **Function code edit** window.

Changing the voltage automatically modifies the factory default, minimum, and maximum values of function codes whose data copy attribute is "1" accordingly.

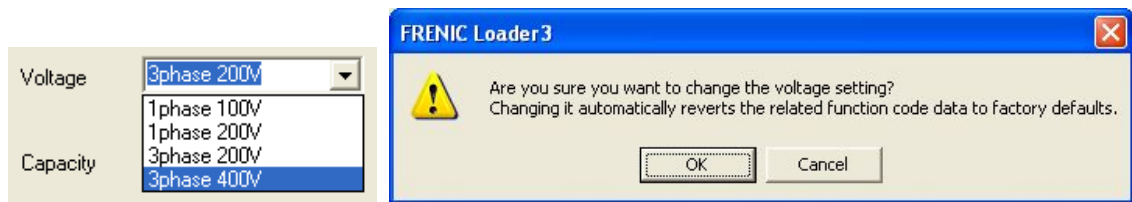

- Note**
- As shown in the dialog box above, changing the voltage initializes all function code data that depend on the voltage. Save the current data before changing the voltage, if necessary.

## [ 3 ] Changing the inverter capacity

You can change the capacity of the inverter whose function code data is currently listed in the **Function code edit** window.

Changing the capacity automatically modifies the factory default, minimum, and maximum values of function codes whose data copy attribute is "2" accordingly.

(Some models are displayed with a nominal current value in parentheses for its own capacity. e.g., 11 kW (0022))

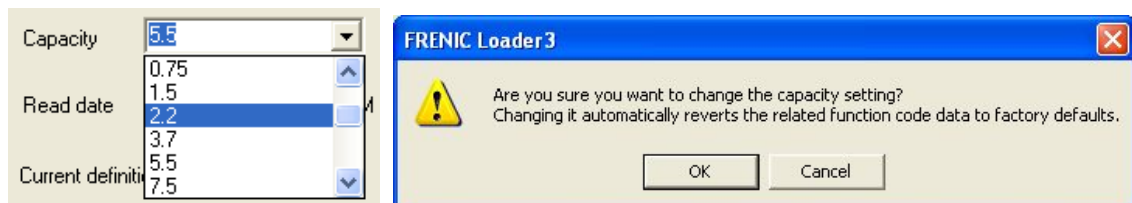

- Note**
- As shown in the dialog box above, changing the capacity initializes all of the capacity-related function code data. Save the current data before changing the capacity, if necessary.



### [ 4 ] Changing the current definition file

The **Current definition file** indicates the name of the definition file corresponding to the inverter ROM version.

- If **Read from the INV** is selected in the **Editing data** window, Loader automatically selects the definition file corresponding to the inverter ROM version.
- If **New** is selected in the **Editing data** window, Loader automatically selects the latest definition file.
- If **Read from the file** is selected in the **Editing data** window, Loader selects the definition file last automatically saved.

Definition file name (FRENIC-MEGA)

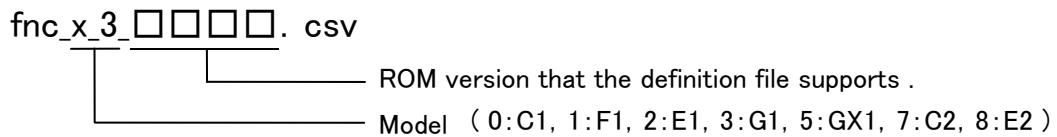

To read or write function code data from/to the inverter, It is necessary to perform as follows relation between a definition file and an inverter ROM version.

Definition file	Inverter ROM version
fnc_x_3_0000o.csv	0000 to 0499
fnc_x_3_0500e_EN.csv	0500 to 0999
fnc_x_3_1000a_EN.csv	1000 to 1999
fnc_x_3_2000_EN.csv	2000 to 2999
fnc_x_3_3000a_EN.csv	3000 to 3599
fnc_x_3_3600_EN.csv	3600 or 3799
fnc_x_3_3800_EN.csv	3800 or later

**Note** If the ROM version of the current definition file and that of the inverter do not match, Loader cannot read or write function code data from/to the inverter.

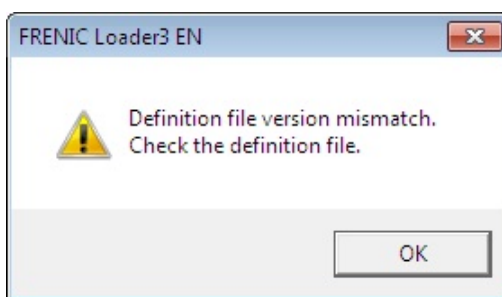

To check the inverter ROM version, select **Operation Monitor | System Monitor** from the **Quick Access Menu**. On the System Monitor window, see the Main control CPU field in the ROM Ver. area.

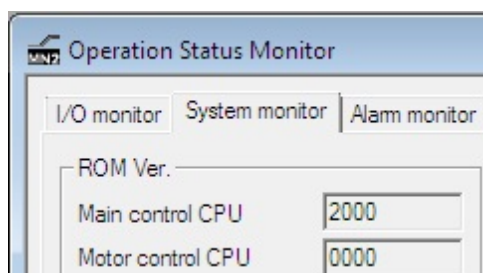

This screen shows that the ROM version of the connected inverter is 2000.

To change the current definition file, click **Change**. In the Open window, select the desired definition file that supports the inverter's ROM version.

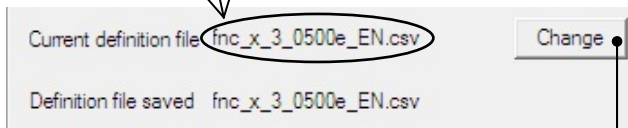
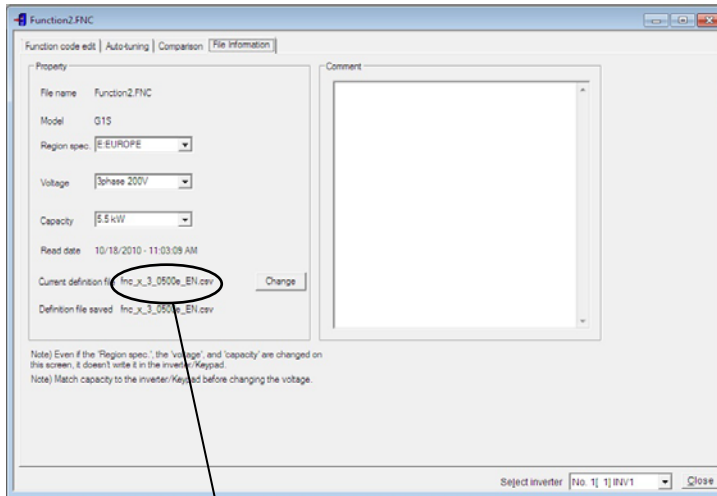

The current definition file supports the inverter ROM version 0500 to 0999. It is necessary, therefore, to change the file to the one that supports version 2000 or later.

Click **Change** to display the Open window as shown below.

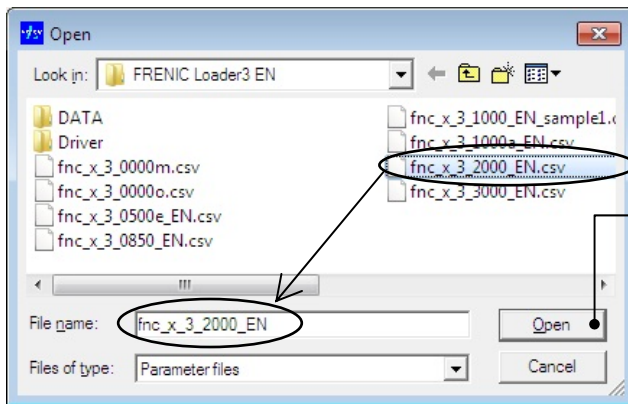

Select the definition file "fnc\_x\_3\_2000\_EN.csv" that supports the inverter ROM version 2000, then click **Open**.

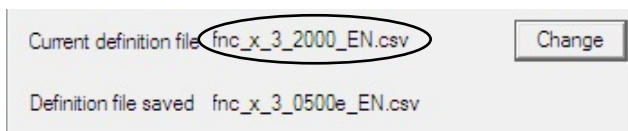

Check that the current definition file is "fnc\_x\_3\_2000\_EN.csv."

**Note** On the function code information list (shown on page 2-8), function code data that has been changed but not yet written into the inverter is shown in red. Changing the current definition file as described above cannot preserve the red display so that such function code data turns blue.

Changing the current definition file also clears entries in the Comment area.

### 2.3.1.5 Function code (customizable logic) setting

Only FRENIC-Ace series supports this function.

**Note** To edit the function code relating to customizable logics, select **[E2S Custom]** button from "New" menu and open the editing window.

There are two kind of way to open edit window.



The window is opened by **[Function code]** of the above-mentioned easy menu, or **FC** **[Functions]** of a menu bar.  
Please select **New** and **[E2S Custom]** as a inverter model.

**New**  
Creates a new function code data file.

**Model**  
Please select the type of **[E2S Custom]** as an object model.

The window is opened by selecting **File | New**, or **[New window]** of a menu bar. **[E2S Custom]** of the selection tab should be selected as a inverter model.

## [ 1 ] Function code edit

Please refer to Chapter 2.3.1.1, when you perform the reading, change, and the writing of a function code.

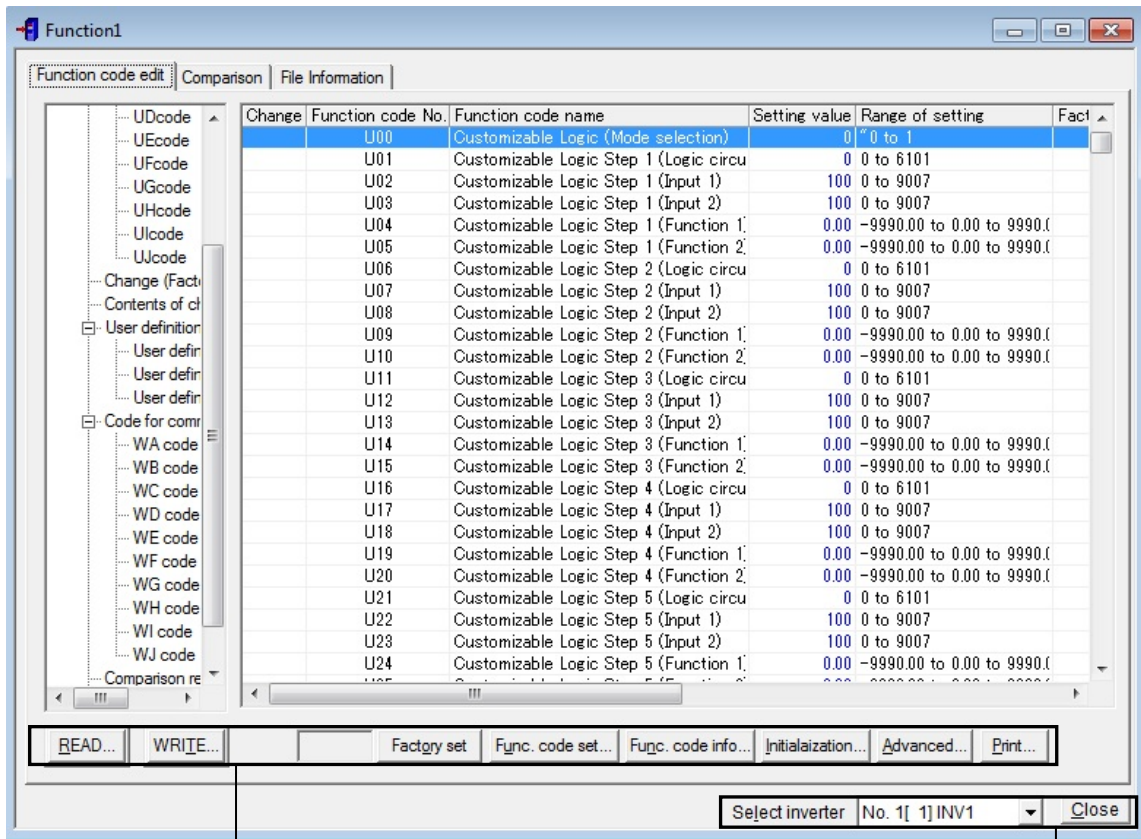

**READ...:** Reads the data from the inverter selected in **Select inverter**.

**WRITE...:** Writes data saved in Loader into the inverter selected in **Select inverter**.

**Factory set:** Reverts the data of the selected function code to the factory default.

**Func. code set...:** Shows the data of the selected function code in the edit window.

**Func. code info...:** Shows information of the selected function code in the window.

**Initialization...:** Initializes all function code data in the inverter selected at **Select inverter**.

**Advanced...:** Calls up the Advanced setting dialog for **Display items...**, **Function code attribute**, and **Print setting...**

**Print...:** Prints function codes selected in the hierarchy tree in the left pane.

**Select inverter:** Select the inverter to which the data is to be sent.

**Close:** Closes the Function code edit window.

### Note Notes for editing the function codes relating to the customizable logic

Edit not the function codes Us(U01 to U70) but UAs(UA00 to UA69).

The function codes Us are automatically copied to UAs in the inverter.

FRENIC-Loader writes to the function order. The function codes UAs are written after Us. So the function codes Us are overwritten by UAs in the inverter.

Monitor function code [WA] to [WJ] are not displayed, if the communication setting is selected to "USB: Data in keypad".

## [ 2 ] Comparison

The function code setting data under present edit can be compared with the data saved at the file, or the setting data of the inverter selected with the [object inverter].

For details, please refer to Chapter 2.3.1.3.

## [ 3 ] File information

Information, including "**Region spec**", "**Voltage**", "**Capacity**", "**Current definition file**", etc., is displayed on file information.

For details, please refer to Chapter 2.3.1.4.

## 2.3.2 Operation monitor

Selecting **Menu | Operation monitor** calls up the **Operation Status Monitor** window (shown below) which monitors the running status of the inverter.

### 2.3.2.1 I/O monitor (for control terminal input/output signal status of the inverter)

The **I/O monitor** allows you to monitor the ON/OFF states of the programmable terminals--digital inputs, transistor outputs and relay contact outputs of the selected inverter.

**CSV Save** — Saves the I/O monitor data in CSV format.

**Select inverter** — Selects the inverter to be monitored.

### 2.3.2.2 System monitor (for current setup info and maintenance info of inverter)

The **System monitor** allows you to check the inverter ROM version, inverter type, current setup information, and maintenance information of the selected inverter.

**CSV Save** — Saves the system monitor data in CSV format.

**Select inverter** — Selects the inverter to be monitored.

### 2.3.2.3 Alarm monitor

The **Alarm monitor** shows the alarm status of the selected inverter. In this window, you can check the content of the current alarm and the various running information recorded when the alarm has occurred.

Select the running info recorded when an alarm has occurred

Selects the running information recorded when the alarm selected from the last 4 alarms has occurred in the inverter.

**Alarm reset...**  
Resets the alarm that currently occurs.

**ALM history initialization...**  
Initializes the alarm history in the selected inverter.

**Print...**  
Prints data recorded when the alarm has occurred.

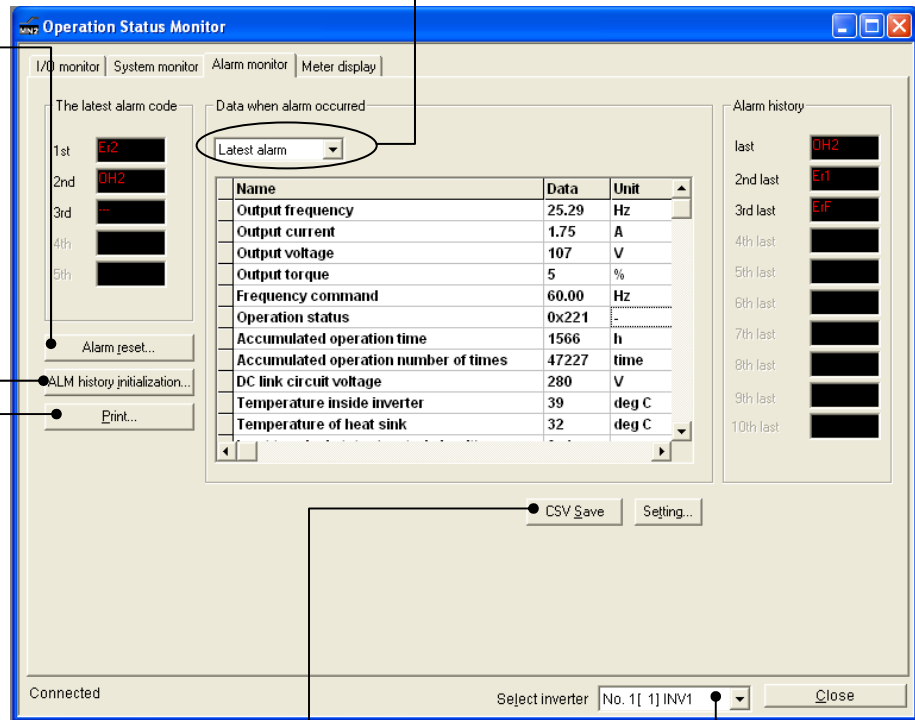

**Select inverter**  
Selects the inverter to be monitored.

**CSV Save**  
Saves the alarm data in CSV format.

**⚠ WARNING**

- Resetting an alarm with a run command being ON will cause the inverter to run the motor unexpectedly.

**An accident or injury could occur.**

### 2.3.2.4 Meter display (Showing the inverter running states)

The **Meter display** shows analog data including inverter's output frequency on the analog meters as shown below. The hollow pointers indicate the peak values if the Peak-hold is checked.

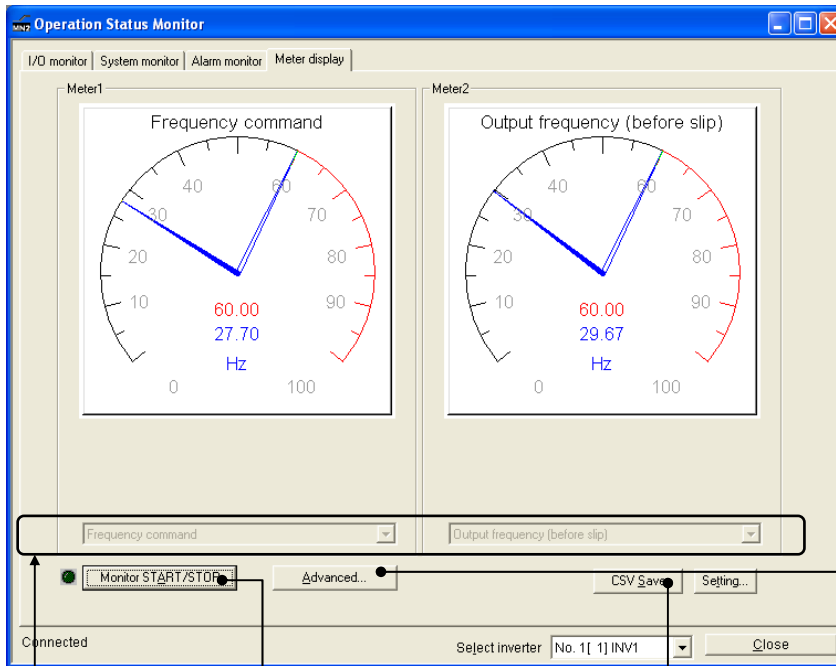

**Select data to be shown**

Selects data to be displayed on the analog meters from the combo boxes.

**Monitor START/STOP**

Starts or stops monitoring the inverters

**CSV Save**

Saves the displayed data in CSV format.

**Advanced...**

Specifies details of the data format to be shown on the meters for maximum, minimum, decimal points, etc.

### [ 1 ] Changing data to be displayed on meters

Click the  button in each of the combo boxes provided at the bottom of meter panes, select an item listed there. The table below lists data on the analog meter.

Inverter information	Mini (C1S)	Mini (C2S)	Eco	Multi	Ace	MEGA	HF
Frequency command	Y	Y	Y	Y	Y	Y	Y
Output frequency (before slip compensation)	Y	Y	Y	Y	Y	Y	Y
Output frequency (after slip compensation)	Y	Y	N	Y	Y	Y	N
Output current	Y	Y	Y	Y	Y	Y	Y
Output voltage	Y	Y	Y	Y	Y	Y	Y
Output torque	N	N	Y	Y	Y	Y	N
Motor speed (Rotation speed)	N	N	Y	Y	Y	Y	Y
Load shaft speed	Y	Y	Y	Y	Y	Y	Y
Line speed	Y	Y	N	Y	Y	Y	Y
PID command	Y	Y	Y	Y	Y	Y	N
PID feedback value	Y	Y	Y	Y	Y	Y	N
PID output value	N	Y	Y	Y	Y	Y	N
DC link bus voltage	Y	Y	Y	Y	Y	Y	Y
Input power	Y	Y	Y	Y	Y	Y	N
Load factor	N	N	Y	Y	Y	Y	N
Motor output power	N	N	Y	Y	Y	Y	N
Motor temperature	N	N	N	N	Y	Y	N

Y: Available, N: Not available



Inverter information	Mini (C1S)	Mini (C2S)	Eco	Multi	Ace	MEGA	HF
Temperature inside inverter	N	N	Y	N	Y	Y	Y
Heat sink temperature	Y	Y	Y	Y	Y	Y	Y
Input voltage on terminal [I2]	Y	Y	Y	Y	Y	Y	Y
Input current on terminal [C1]	Y	Y	Y	Y	Y	Y	Y
Input voltage on terminal [V2]	N	N	Y	Y	Y	Y	Y
Analog input monitor	N	N	Y	Y	Y	Y	N
Output voltage on terminal [FMA]	Y	Y	Y	Y	N	Y	N
Output current on terminal [FMA]	N	N	Y	Y	N	Y	N
Output voltage on terminal [FMP]	N	N	Y	N	N	Y	N
Output pulse rate on terminal [FMP]	N	N	Y	Y	N	Y	N
Output voltage on terminal [FM1]	N	N	N	N	Y	N	Y
Output current on terminal [FM1]	N	N	N	N	Y	N	Y
Output voltage on terminal [FM2]	N	N	M	N	Y (-C only)	N	Y
Output pulse rate on terminal [FM2]	N	N	N	N	Y (-C only)	N	Y
PG pulse rate (A/B phase signal from reference PG)	N	N	N	Y	Y	Y	N
PG pulse rate (Z phase signal from reference PG)	N	N	N	Y	Y	Y	N
PG pulse rate (A/B phase signal from slave PG)	N	N	N	Y	Y	Y	N
PG pulse rate (Z phase signal from slave PG)	N	N	N	Y	Y	Y	N
Pulse input monitor on terminal [X7] or [X5] (X7:MEGA, X5:Ace)	N	N	N	N	Y	Y	N
Detected speed	N	N	N	N	Y	Y	N
Torque command	N	N	N	N	Y	Y	N
Torque current command	N	N	N	N	Y	Y	N
Torque current	N	N	N	N	Y	Y	N
Positional deviation in synchronous operation	N	N	N	N	Y	Y	N

Y: Available, N: Not available



**Note** Selected item may be invalid according to the inverter model or version. Please check that the item is valid or not in the inverter manual.

## [ 2 ] Changing the advanced settings for analog meters

Click **Advanced** in the analog meter pane to call up the dialog below.

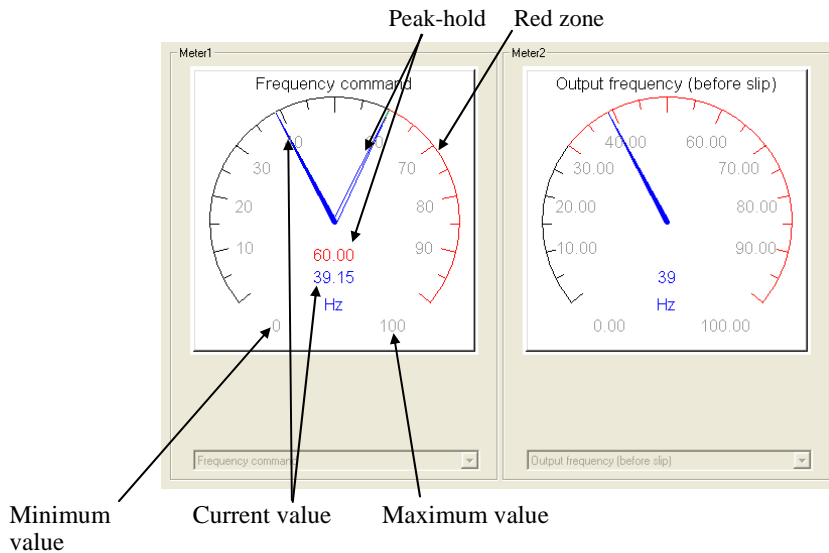
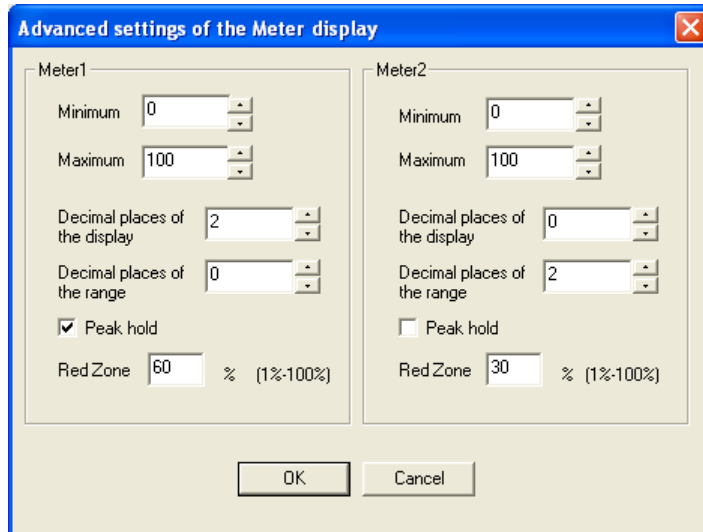

- **Minimum value:** Specify the minimum value at the low end point of the meter scale.
- **Maximum value:** Specify the maximum value at the high end point of the meter scale.
- **Decimal places of the display:** Specify the number of decimal places for the current and peak-hold display. (Digital display precision)
- **Decimal places of the range:** Specify the number of decimal places for the analog meter dial.
- **Peak-hold:** Enable/disable the peak-hold that makes the meter hold the measured peak value.
- **Red zone:** Specify the red colored scale ratio to the meter full scale.

### 2.3.2.5 Saving data in CSV format (on operation status monitors)

Clicking the **CSV Save** button on each operation status monitor saves the currently monitored data in CSV format.

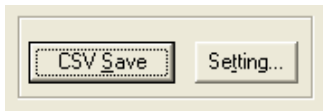

Clicking the **CSV Save** button creates a CSV file automatically in the directory as shown below for each monitor item.

Example: I/O monitor data

C:\Program Files\Fuji Electric\FRENIC Loader3 EN\DATA\IO monitor.csv

After specifying the directory to save the CSV file, click the **Setting...** button.

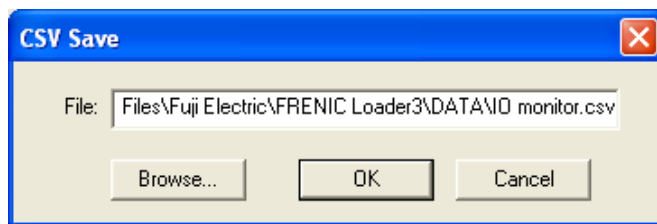

To save the data into any other folder, click **Browse** and select a desired folder.

Given below are sample files saved in CSV format for each monitor item.

#### I/O monitor

	A	B	C	D	E	F	G	H	
1	Date	Select inverter	X1	Value	Normally	X2	Value	Normally	X3
2	11/14/2007 13:56	No. 1[ 1] INV1	Select multi-freq. [SS1]	OFF	Open	Select multi-freq. [SS2]	OFF	Open	Se
3	11/14/2007 14:01	No. 1[ 1] INV1	Select multi-freq. [SS1]	ON	Open	Select multi-freq. [SS2]	ON	Open	Se
4	11/14/2007 14:02	No. 1[ 1] INV1	Select multi-freq. [SS1]	ON	Open	Select multi-freq. [SS2]	OFF	Open	Se

#### System monitor

	A	B	C	D	E	F	G	H	I
1	Date	Select inverter	Main control CPU	Motor control CPU	KEYPAD	Option 1	Option 2	Option 3	Option 4
2	11/14/2007 14:14	No. 1[ 1] INV1	500	0	1300	0	0	0	
3	11/14/2007 14:14	No. 1[ 1] INV1	500	0	1300	0	0	0	

#### Alarm monitor

	A	B	C	D	E	F	G	H	I	J	K
1	Date	Select inverter	1st	2nd	3rd	4th	5th	Data when alarm occurred	Output frequency	Unit	Output c
2	11/14/2007 14:22	No. 1[ 1] INV1	Er2	OH2	---			Latest alarm	25.29	Hz	
3	11/14/2007 14:22	No. 1[ 1] INV1	Er2	OH2	---			Last alarm	25.29	Hz	
4	11/14/2007 14:22	No. 1[ 1] INV1	Er2	OH2	---			2nd last alarm	0	Hz	
5	11/14/2007 14:22	No. 1[ 1] INV1	Er2	OH2	---			3rd last alarm	25.29	Hz	

#### Meter display

	A	B	C	D	E	F	G	H
1	Date	Select inverter	Meter1	Value	Unit	Maximum value	Unit	Meter2
2	11/14/2007 14:34	No. 1[ 1] INV1	Frequency command	38.78	Hz	38.78	Hz	Output frequency (before slip)
3	11/14/2007 14:34	No. 1[ 1] INV1	Frequency command	29.81	Hz	60	Hz	Output frequency (before slip)

### 2.3.3 Multi-monitor (for the running status of more than one inverter)

Selecting **Menu | Multi-monitor** calls up the **Multi-monitor** window (shown below) which lists the running status of more than one inverter on the network.

No.	Equipment name	RS485 address	Inverter model name	Capacity	Operation status	Frequency command	Unit
1	INV1	1	G1S 3phase 200V	0.4	FWD	38.84	38.84
2	INV2	2	G1S 3phase 200V	0.4	STOP	9.17	9.17
3							
4							
5							
6							
7							
8							
9							
10							
11							
12							
13							
14							
15							
16							
17							
18							
19							
20							

**Status monitor items**

Lists status monitor items for inverters listed in the equipment name column.

**Selection...**

Adds or deletes status monitor items.

#### [ 1 ] Adding/deleting the monitor items to be listed

Click the **Selection...** button to call up the following window that lists monitor items available.

To add an item to be listed in the table, place a check mark (✓) in the box at the left of that item.

Click the box again to remove the ✓ mark.

After completion of your selection, click **OK**.

Any items without a ✓ mark will not be shown in the **Multi-monitor** window.

The table below lists the monitor items available.

Monitor items	Mini (C1S)	Mini (C2S)	Eco	Multi	Ace	MEGA	HF
Equipment name	Y	Y	Y	Y	Y	Y	Y
RS-485 address	Y	Y	Y	Y	Y	Y	Y
Inverter model name (Inverter type)	Y	Y	Y	Y	Y	Y	Y
Capacity	Y	Y	Y	Y	Y	Y	Y
Operation status	Y	Y	Y	Y	Y	Y	Y
Brake signal	N	N	Y	Y	Y	Y	Y
Latest alarm information	Y	Y	Y	Y	Y	Y	Y
Frequency command	Y	Y	Y	Y	Y	Y	Y
Output frequency (before slip compensation)	Y	Y	Y	Y	Y	Y	Y
Output frequency (after slip compensation)	Y	Y	N	Y	Y	Y	N
Output current	Y	Y	Y	Y	Y	Y	Y
Output voltage	Y	Y	Y	Y	Y	Y	Y
Motor speed (Rotation speed)	N	N	Y	Y	Y	Y	Y
Load shaft speed	Y	Y	Y	Y	Y	Y	Y
Line speed	Y	Y	N	Y	Y	Y	Y
PID command	Y	Y	Y	Y	Y	Y	N
PID feedback value	Y	Y	Y	Y	Y	Y	N
PID output value	N	Y	Y	Y	Y	Y	N
Torque command	N	N	N	N	Y	Y	N
Output torque	N	N	Y	Y	Y	Y	N
Torque current command	N	N	N	N	Y	Y	N
Torque current	N	N	N	N	Y	Y	N
DC link bus voltage	Y	Y	Y	Y	Y	Y	Y
Input power	Y	Y	Y	Y	Y	Y	N

Y: Available, N: Not available



Selected item may be invalid according to the inverter model or version. Please check that the item is valid or not in the inverter manual.

## 2.3.4 Test-running

Selecting **Menu | Test-running** calls up the **Test run** window (shown below) which allows you to test-run the motor in the forward or reverse direction while monitoring the running status of the selected inverter.

### Select monitor item

Select what is to be displayed (e.g., output frequency or current) here using the pull-down menu.

### Frequency reference

Enter or select the frequency command to write it into the inverter. Click **Apply** to make it effective.

### I/O terminal status

Shows the status of the programmable, digital I/O terminals of the inverter.

### Operation status

Shows FWD, REV, STOP and alarm codes.

### Operation buttons (See the table below.)\*

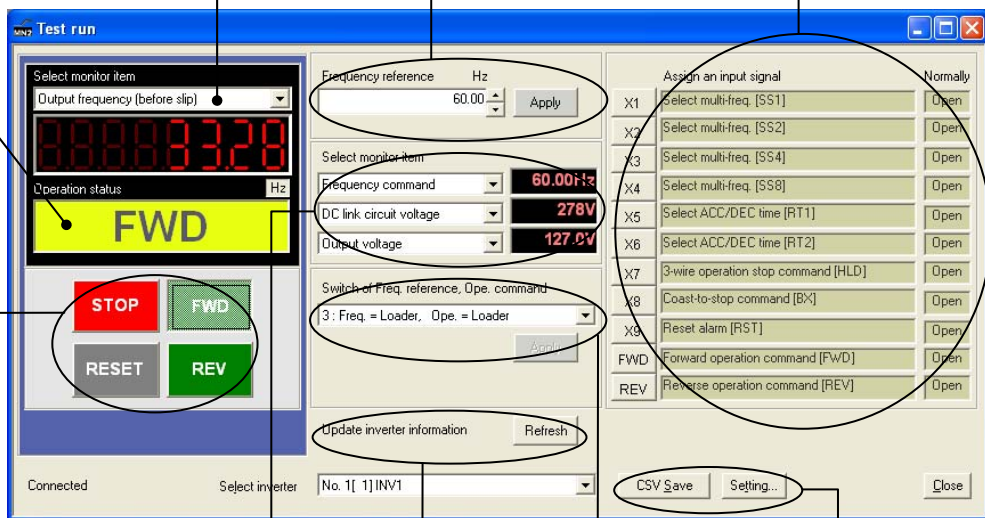

### Select monitor item

Select the operation status information to be monitored in real-time.

### Update inverter information

Click the **Refresh** button to refresh the contents of this window to show the latest inverter status.

### Switching of frequency and run command sources

Select the frequency and run command sources and click **Apply**.

### CSV Save

Use these buttons to save the displayed data in CSV format. (For details, see Section 2.3.2.5.)

\* The details of the operation buttons are described in the table below.

Button	Use to
<b>STOP</b>	Stop the motor.
<b>FWD</b>	Run the motor forward. (The indented appearance of the button indicates that the button is active and the motor is running.)
<b>REV</b>	Run the motor reverse. (The indented appearance of the button indicates that the button is active and the motor is running.)
<b>RESET</b>	Reset all alarm information saved in the selected inverter.

To proceed test-running, select an inverter by clicking the ▼ mark in the **Select inverter** combo box.

When the **Test run** window is first opened, the **Switch of freq. command, Ope. command** is set at [0: Freq. = Inverter, Ope. = Inverter] so that you cannot modify the frequency command or run/stop the inverter per Loader. The operation buttons **STOP/REV/STOP** (except **RESET**) and input signal assignment buttons for [X1] to [X9], [FWD] and [REV] are disabled. These buttons are enabled only when the [Ope. = Loader] is specified.

The monitors in this window display the running status of the selected inverter.



Never change the selected inverter when the motor is running; doing so loses the means for stopping the motor. For safety, first stop the inverter operation, change the selected inverter, and then start running the newly selected inverter. To test-run two or more inverters concurrently, open the **Test run** windows for individual inverters.

### 2.3.4.1 Setting up the inverter and running the motor from Loader

Click ▾ of the **Switch of freq. command, Ope. command** combo box and select any of [1: Freq. = Loader, Ope. = Inverter], [2: Freq. = Inverter, Ope. = Loader] and [3: Freq. = Loader, Ope. = Loader] depending upon the commands to be issued from Loader. See the table below for details.

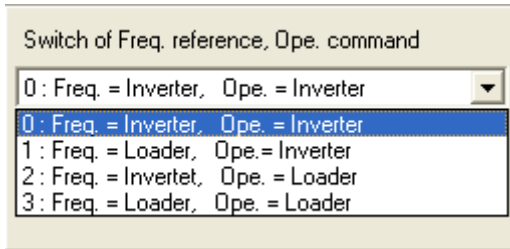

Commands to be issued from Loader	Setting in the <b>Switch of freq. command, Ope. command</b> combo box	<b>Frequency reference</b> box	Operation buttons ( <b>STOP</b> , <b>FWD</b> and <b>REV</b> )	Input signal assignment buttons for [X1] to [X9], [FWD] and [REV]
None	[0: Freq. = Inverter, Ope. = Inverter] (Factory defaults)	Disabled	Disabled	Disabled
Frequency command	[1: Freq. = Loader, Ope. = Inverter]	Enabled	Disabled	Disabled
Run command	[2: Freq. = Inverter, Ope. = Loader]	Disabled	Enabled	Enabled
Frequency command and run command	[3: Freq. = Loader, Ope. = Loader]	Enabled	Enabled	Enabled

Given below is a sample procedure for issuing both frequency and run commands from Loader.

- (1) Select [3: Freq. = Loader, Ope. = Loader] in the **Switch of freq. command and Ope. command** combo box and click **Apply**.

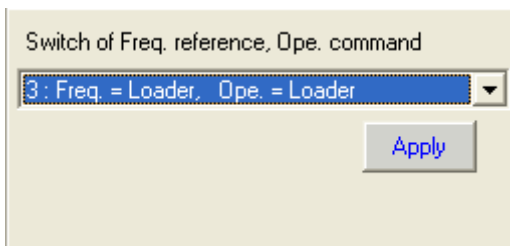

- (2) All of the **Frequency reference** combo box, operation buttons **STOP**, **FWD** and **REV** (except **RESET**), and input signal assignment buttons for [X1] to [X9], [FWD] and [REV] become enabled.
- (3) Enter a desired frequency in the **Frequency command** combo box and click **Apply**.  
To run the motor in the forward direction, click **FWD**; to run it in the reverse direction, click **REV**. To stop the motor, click **STOP**.

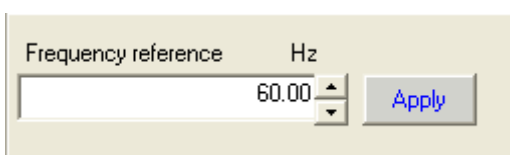

**Relationship between the setting in Switch of freq. command, Ope. command combo box and function code H30 data**

The setting selected in the **Switch of freq. command, Ope. command** combo box in the **Test run** window may be affected by the function code H30 data. The relationship between those settings for each of the frequency and run commands is shown below.

**< Signal flow of frequency command >**

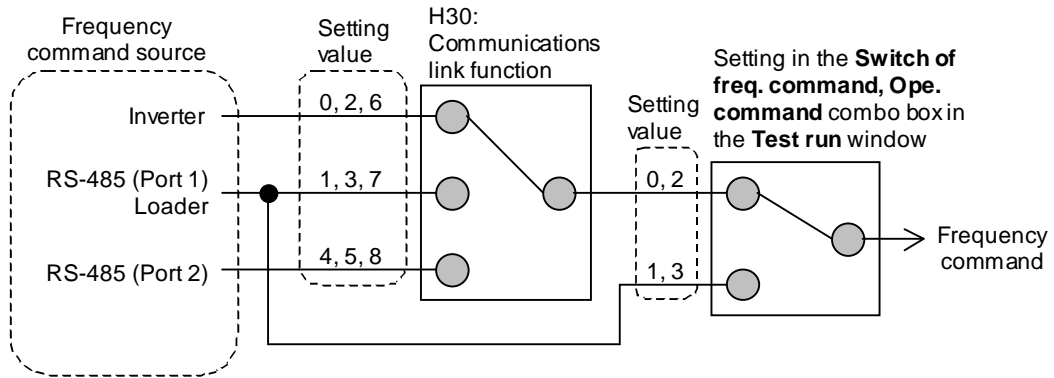

If the setting selected in the **Switch of freq. command, Ope. command** combo box is "0" or "2," the frequency command is determined by the H30 data; if it is "1" or "3," the frequency command from Loader is always effective.

Data for H30 (Communications link function)	Setting in the <b>Switch of freq. command, Ope. command</b> combo box	Frequency command source	
0: Frequency command = F01/C30, Run command = F02 2: Frequency command = F01/C30, Run command = RS-485 (Port 1) 6: Frequency command = F01/C30, Run command = RS-485 (Port 2)	[0: Freq. = Inverter, Ope. = Inverter] [2: Freq. = Inverter, Ope. = Loader]	Inverter	
1: Frequency command = RS-485 (Port 1), Run command = F02 3: Frequency command = RS-485 (Port 1), Run command = RS-485 (Port 1) 7: Frequency command = RS-485 (Port 1), Run command = RS-485 (Port 2)		Loader	
4: Frequency command = RS-485 (Port 2), Run command = F02 5: Frequency command = RS-485 (Port 2), Run command = RS-485 (Port 1) 8: Frequency command = RS-485 (Port 2), Run command = RS-485 (Port 2)		RS-485 communications link (Port 2)	
Not applicable		[1: Freq. = Loader, Ope. = Inverter] [3: Freq. = Loader, Ope. = Loader]	Loader



< Signal flow of run command >

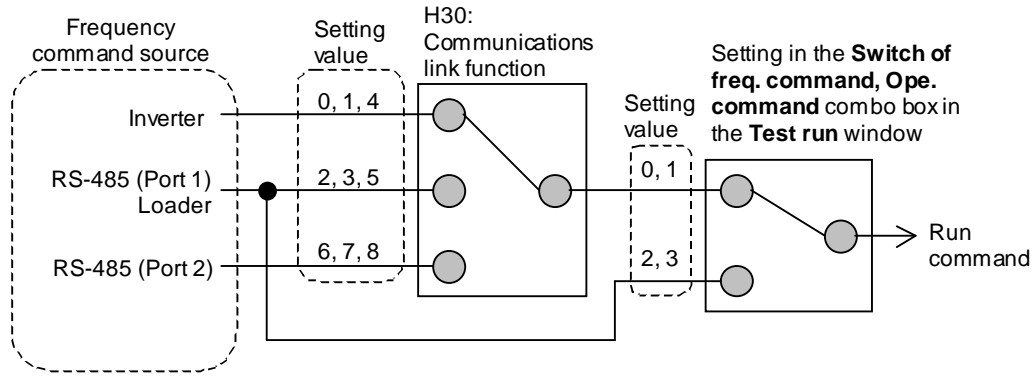

If the setting selected in the **Switch of freq. command, Ope. command** combo box is "0" or "1," the run command is determined by the H30 data; if it is "2" or "3," the run command from Loader is always effective.

Data for H30 (Communications link function)	Setting in the <b>Switch of freq. command, Ope. command</b> combo box	Run command source
0: Frequency command = F01/C30, Run command = F02 1: Frequency command = RS-485 (Port 1), Run command = F02 4: Frequency command = RS-485 (Port 2), Run command = F02		Inverter
2: Frequency command = F01/C30, Run command = RS-485 (Port 1) 3: Frequency command = RS-485 (Port 1), Run command = RS-485 (Port 1) 5: Frequency command = RS-485 (Port 2), Run command = RS-485 (Port 1)	[0: Freq. = Inverter, Ope. = Inverter] [1: Freq. = Loader, Ope. = Inverter]	Loader
6: Frequency command = F01/C30, Run command = RS-485 (Port 2) 7: Frequency command = RS-485 (Port 1), Run command =RS-485 (Port 2) 8: Frequency command = RS-485 (Port 2), Run command =RS-485 (Port 2)		RS-485 communications link (Port 2)
Not applicable	[2: Freq. = Inverter, Ope. = Loader] [3: Freq. = Loader, Ope. = Loader]	Loader

## 2.3.4.2 Monitoring the inverter operation from Loader

Loader always monitors the running status of the inverter(s) in the **Test run** window. The monitor items listed in the dropdown menu of the **Select monitor item** combo box in the monitor pane can be selected by clicking the  mark in the combo box, which are shown in the table below. Furthermore for important items, Loader displays the monitoring data in the enlarged format on the display box above the running status monitor box.

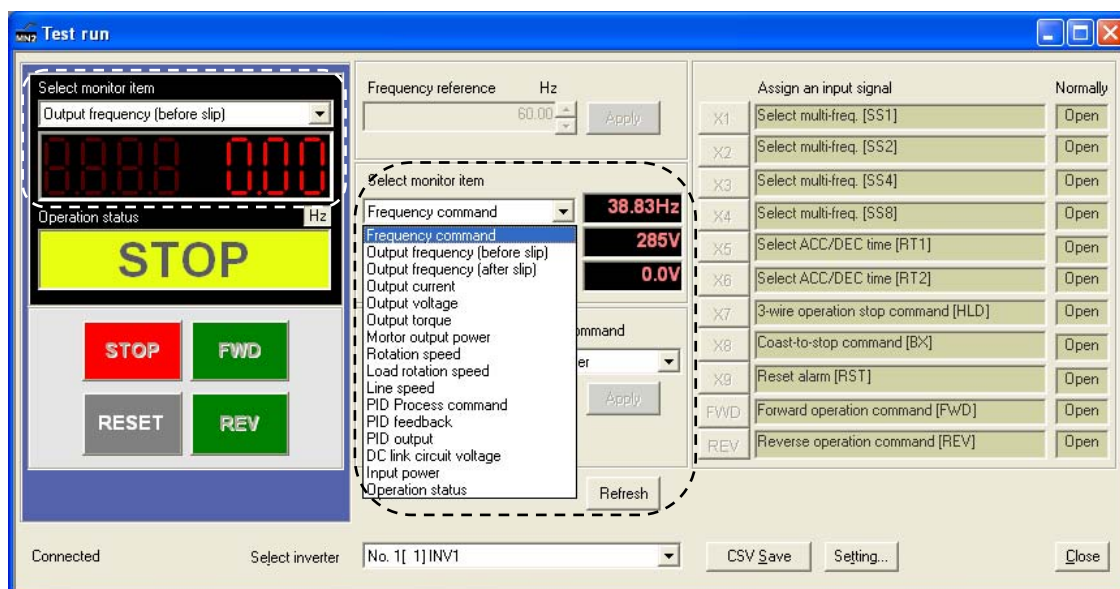

The table below lists the monitor items that can be displayed.

Inverter information	Mini (C1S)	Mini (C2S)	Eco	Multi	Ace	MEGA	HF
Frequency command	Y	Y	Y	Y	Y	Y	Y
Output frequency (before slip compensation)	Y	Y	Y	Y	Y	Y	Y
Output frequency (after slip compensation)	Y	Y	N	Y	Y	Y	N
Output current	Y	Y	Y	Y	Y	Y	Y
Output voltage	Y	Y	Y	Y	Y	Y	Y
Output torque	N	N	Y	Y	Y	Y	N
Motor speed (Rotation speed)	N	N	Y	Y	Y	Y	Y
Load shaft speed (Load rotation speed)	Y	Y	Y	Y	Y	Y	Y
Line speed	Y	Y	N	Y	Y	Y	Y
PID process command	Y	Y	Y	Y	Y	Y	N
PID feedback value	Y	Y	Y	Y	Y	Y	N
PID output value	N	Y	Y	Y	Y	Y	N
DC link bus voltage	Y	Y	Y	Y	Y	Y	Y
Input power	Y	Y	Y	Y	Y	Y	N
Motor output power	N	N	Y	Y	Y	Y	N
Operation status	Y	Y	Y	Y	Y	Y	Y

Y: Available, N: Not available



Selected item may be invalid according to the inverter model or version. Please check that the item is valid or not in the inverter manual.

### 2.3.4.3 Recovering Loader whose Test run window cannot monitor inverter status

When a communications error occurs between Loader and the inverter(s) so that the communications error dialog pops up, clicking the **Cancel** button on the dialog can recover Loader from the error state; however, Loader cannot automatically relink the inverter(s).

In this case, to recover Loader operation, call up the **Device connection list** window (see Section 1.4.3.2), click **Browse**, and check the current communications state.

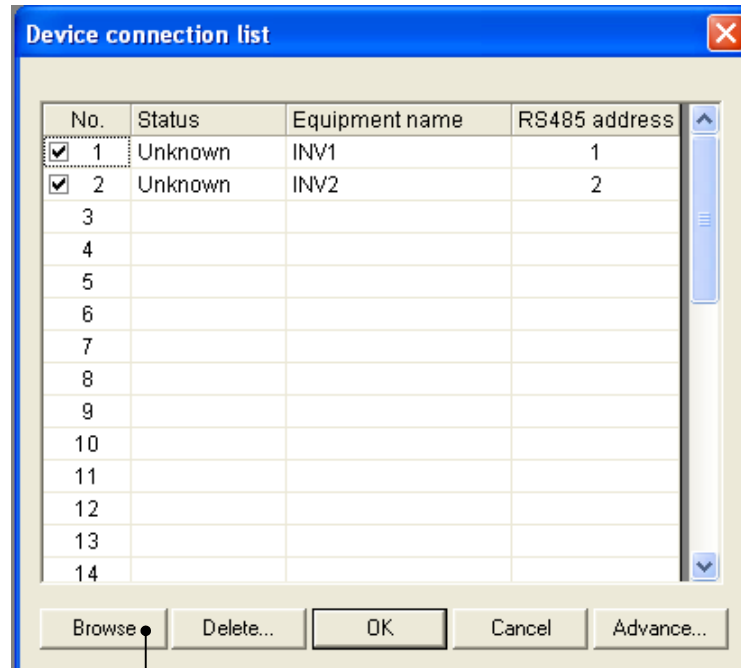

Click **Browse**.

If the status is "Connected" as shown below, Loader relinks the inverter (INV1) and restarts monitoring the inverter, making the **Test run** window reflect the running status.

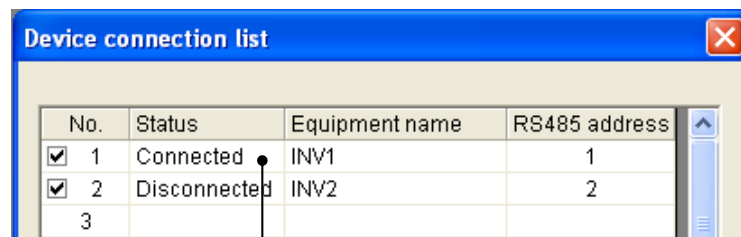

Check that the status is "Connected."

---

## ⚠ WARNING

- Resetting an alarm with a run command being ON will cause the inverter to run the motor unexpectedly.

**An accident or injury could occur.**

- If Loader or OS freezes or is forced to quit when Loader is operating the inverter(s) from the Test run window, the connected inverter(s) cannot be stopped from Loader. If it happens, perform any of the following operations to stop the inverter(s). (See **IMPORTANT!** below.)
  - 1) Prepare a separate emergency stop switch and use it to stop the inverter.
  - 2) Turn off the power to the inverter.
  - 3) Turn off the external run command at the inverter side and switch the command source from "Via communications line" to "From inverter" by doing one of the following:
    - Turn off the terminal which the **LE** command is assigned to.
    - Set function code y99 data (Link support function) to "0" using the keypad.
    - Set function code H30 data (Link function) to "0" using the keypad.
- When operating the inverter(s) from the Test run window, never disconnect the RS-485 communications cable, USB cable, or keypad. Doing so makes it impossible to stop the inverter(s) from Loader. It is dangerous.

**An accident or injury could occur if this warning is not heeded.**

### **IMPORTANT!**

Even after the inverter is stopped by one of the operations described above, it still retains the data of the communications-related function codes--S05 (frequency command), S06 (run command) and y99 (link support).

With those function code data being retained, attempting to run the inverter may run the motor unexpectedly. For your safety, reset the data of those function codes (S05, S06, and y99) to "0" using the following procedure before restarting operation.

- 1) Turn the power to the inverter off. After making sure that the inverter completely stops, turn the power on again.
- 2) Set the y99 data to "0" using the keypad on the inverter. After that, restart Loader, call up the **Function code edit** window, and set the S05 and S06 data to "0".

### 2.3.5 Trace (Showing the inverter operation status in waveforms)

Selecting **Menu | Trace** calls up the **Real time trace** window (shown below) which provides the following two types of trace functions.

- Real-time trace: Suitable for monitoring for long hours  
(Continuous waveform capturing capability: Max. 15,360 samples/channel)
- Historical trace: Suitable for monitoring short-period samples  
(Waveform capturing capability: Max. 500 samples/channel)

**Note** Historical trace corresponds only to MEGA ,HF and Ace.

Each trace function can simultaneously monitor the inverter operation status with a total of eight channels (maximum of four channels of analog data and maximum of eight channels of digital data) in seamless waveform format.

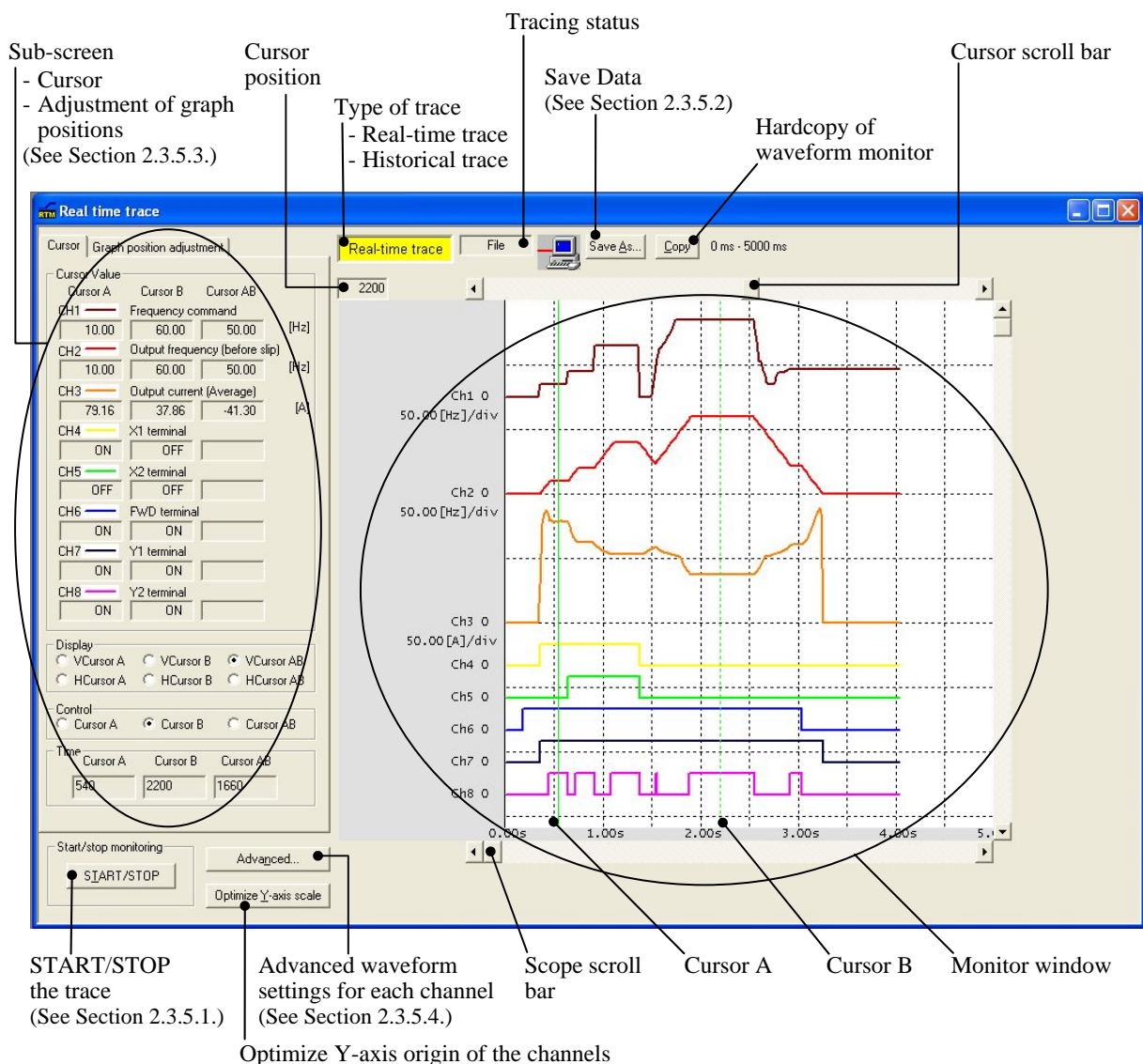

**Note** While tracing is in progress, the following cannot be changed.

- RS-485 station address
- Advanced waveform settings

Resizing the trace window automatically changes the waveform monitor window size.

**2.3.5.1 Starting/stopping monitoring**

To start monitoring each trace, click the **START/STOP** button at the bottom left of the screen. To stop it, click the button again.

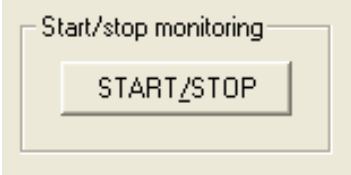

Upon start of monitoring, the "Type of trace" box (Real-time trace or Historical trace) at the top center of the screen flashes.



The "Tracing status" box at the top center of the screen also changes as shown below.

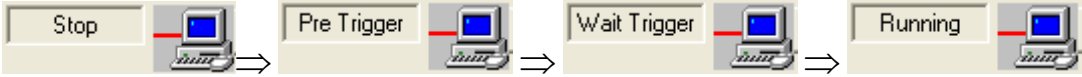

Tracing status display	Meaning
Stop	Tracing stopped.
Pre Trigger	In tracing. Loader is loading data preceding the trigger point. Note: In this state, Loader does not detect a trigger.
Wait Trigger	In tracing. Loader is waiting for a trigger to be detected.
Running	In tracing. Loader has detected a trigger and displayed the data on the screen.

### 2.3.5.2 Saving trace data

To save trace data, click the **Save As...** button at the top of the screen or select **File | Save As...**

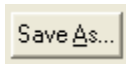

At the time of first data saving, even selecting **File | Save** calls up the **Save As...** dialog shown below. Select a folder in the **Save In** box, select a file type in the **Save as type** box, type a filename in the **File name** box, and then click the **Save** button.

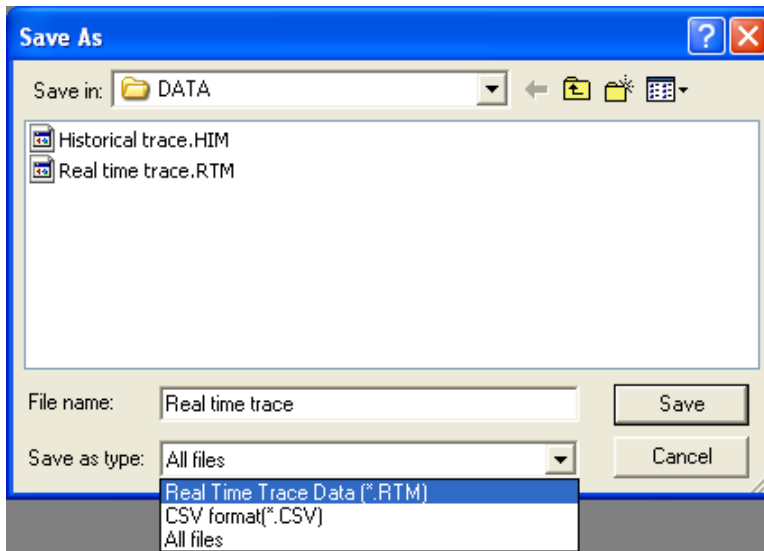

The real-time trace data is saved as an \*.RTM file, and the historical trace data, as an \*.HIM file. To save data in comma-separated format (\*.CSV), select \*.CSV in **Save as type**.

**Note** If data is saved in comma-separated format (\*.CSV), Loader no longer loads it.

It is possible to open the trace data file by selecting **File | Open** on the Loader top window (see Section 2.2.2 "Open") and analyze the data at an arbitrary sampling point with the screen scroll bar and the cursor.

**Note** If tracing operation has not been finished successfully due to communication break, etc., the trace data cannot be saved even if the waveform data displays on the screen.

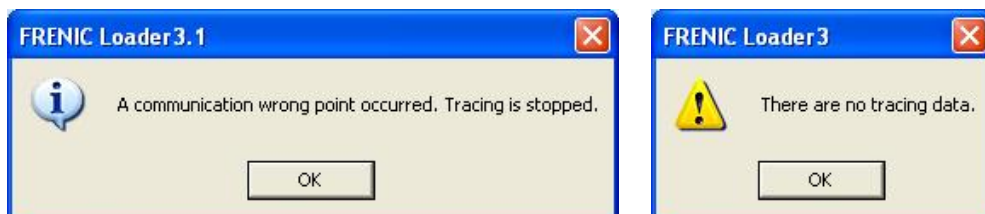

### 2.3.5.3 Making a copy of the waveform monitor

To make a copy of the waveform monitor, click **Copy** at the top of the screen. The graph only is copied to Clipboard. Paste it to desired documents.

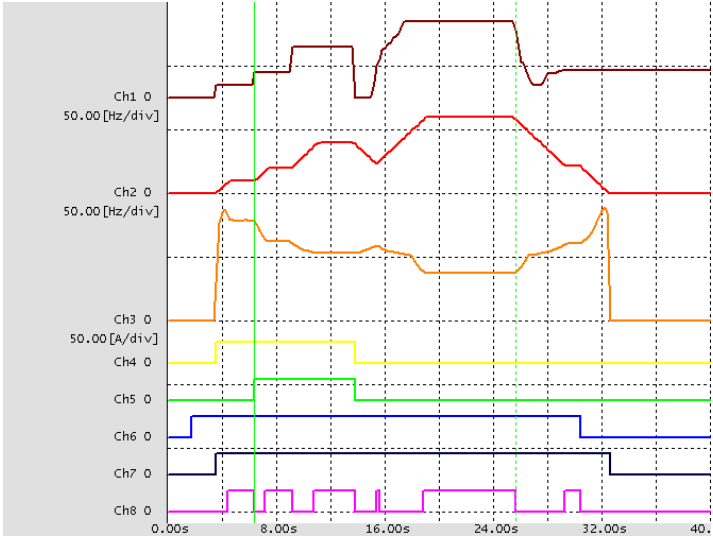



### 2.3.5.4 Sub-panes

#### [ 1 ] Cursor

Each box in this pane shows the measured numerical data or ON/OFF state at the point where each cursor lies.

Displays the monitored value at the point where each cursor lies, on the waveform-traced channel.

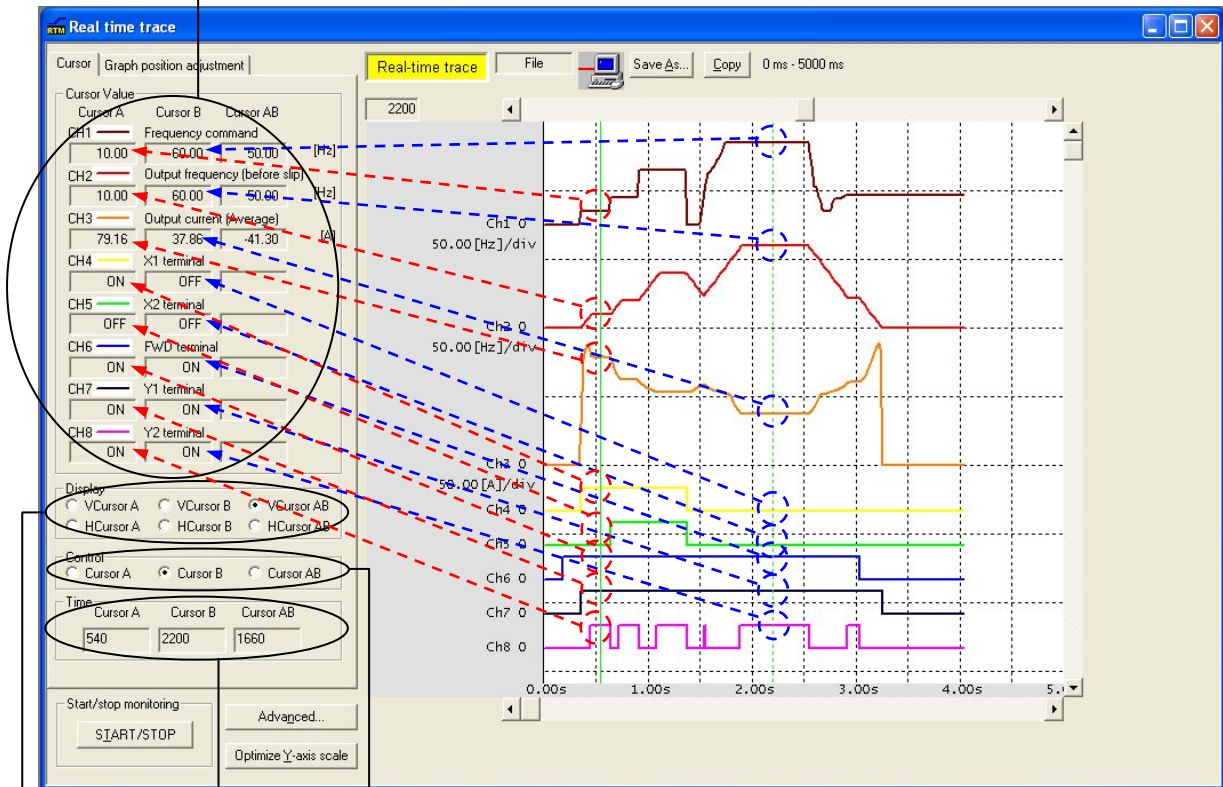

Selects a cursor type to display.

Selects a cursor to move.

Displays the time at the point where the cursor lies on the graph.

Use the scroll bar and move the opened trace screen to the sampling time frame to be analyzed, and click a point on the trace line to place the cursor here. The cursor moves to the sampling point (time) nearest to the clicked point. The trace data on the cursor on all channels will be shown in the corresponding boxes in the cursor pane.

It is possible to move the cursor by dragging the cursor scroll bar or the cursor itself. During tracing in progress, however, both the waveform monitor and cursor cannot be moved.

---

## [ 2 ] Graph Position adjustment

Use this pane to position the graphs in each monitor channel.

Cursor Graph position adjustment

Select Channel CH-1

Position 90

Amplitude 1

Scale 100 / 1000

Reset positioning

Style line...

Timeframe per window 5s

Background color

### Select channel

Select a channel whose graph position is to be customized.

### Position

Customize the graph display position on the y-axis for the selected channel. The top of the waveform monitor window is regarded as zero (0). The grid lines are drawn at intervals of 60 dots.

### Amplitude

Set a multiplier to magnify the waveform amplitude on the selected channel.

### Scale

Specify the measuring scale for the selected monitor channel.

Full scale is at 1000. (This feature is only applicable to analog channels.)

### Reset positioning

Revert the Position, Amplitude and Scale settings to the factory defaults.

### Style line...

Specify the trace line style on the selected channel.

### Timeframe per window

Specify the timeframe per waveform monitor window in seconds.

### Background color

Select the background color of the waveform monitor.

### 2.3.5.5 Advanced waveform settings

#### [ 1 ] Channel configuration

This window allows you to configure the trace windows for the analog and digital channels. See [ 2 ] to [ 5 ] for details.

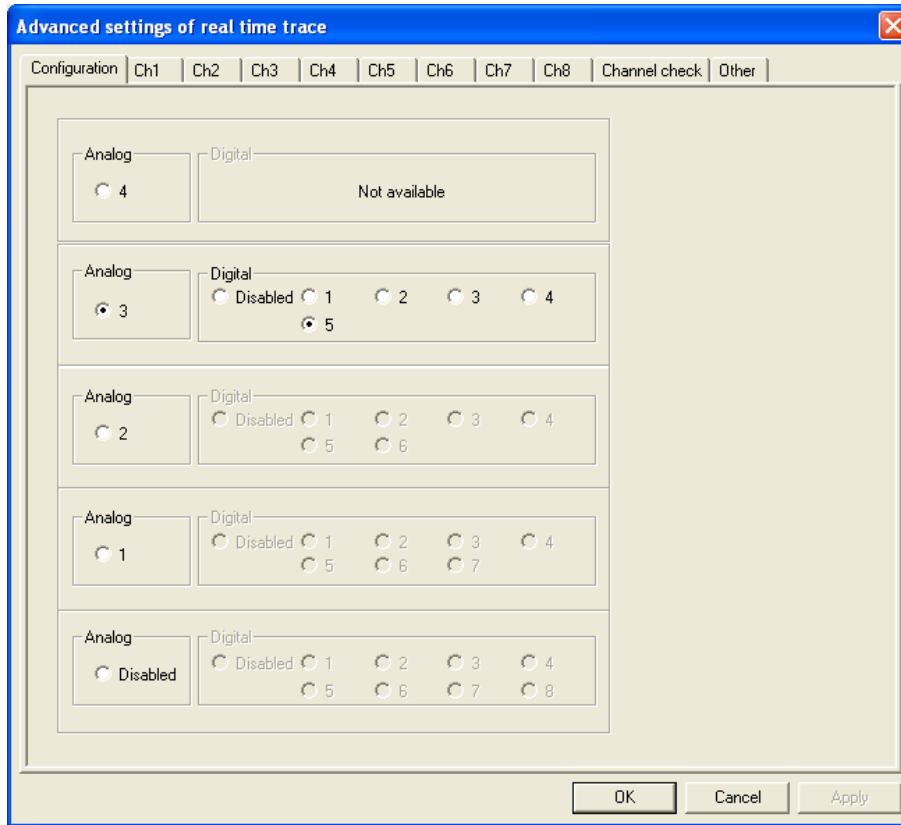

#### [ 2 ] Ch1 to Ch4 (Analog channels)

Selecting analog channels in the **configuration** window in [ 1 ] in this section and selecting any of **Ch1** to **Ch4** tabs displays the following window that is used for advanced setup of the analog channels.

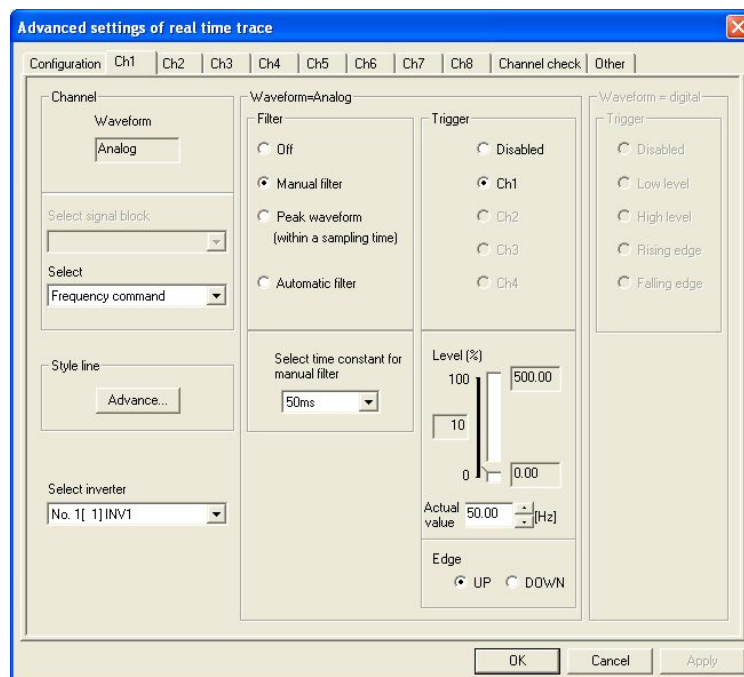

## Select inverter

Select the inverter number that has been registered in the connection setting.

 **Note** This item does not apply to the historical trace.  
Choose the inverter of the same model. The right waveform may be unable to be displayed if two or more models are intermingled.

## Channel

This box shows the channel type that has been selected in the **Configuration** window.

## Select (signal item)

Listed below are items that can be real-time traced for inverters.

Inverter information	Mini (C1S)	Mini (C2S)	Eco	Multi	Ace	MEGA	HF
Frequency command	Y	Y	Y	Y	Y	Y	Y
Output frequency (before slip compensation)	Y	Y	Y	Y	Y	Y	Y
Output frequency (after slip compensation)	Y	Y	N	Y	Y	Y	N
Output current (average)	Y	Y	Y	Y	Y	Y	Y
Output voltage	Y	Y	Y	Y	Y	Y	Y
Motor speed (Rotation speed)	N	N	Y	Y	Y	Y	Y
Load shaft speed (Load rotation speed)	Y	Y	Y	Y	Y	Y	Y
Line speed	Y	Y	N	Y	Y	Y	Y
Detected speed	N	N	N	N	Y	Y	N
PID command	Y	Y	Y	Y	Y	Y	N
PID feedback value	Y	Y	Y	Y	Y	Y	N
PID output value	N	Y	Y	Y	Y	Y	N
Torque command	N	N	N	N	Y	Y	N
Output torque	N	N	Y	Y	Y	Y	N
Torque current command	N	N	N	N	Y	Y	N
Torque current	N	N	N	N	Y	Y	N
Magnetic flux command	N	N	N	N	Y	Y	N
DC link bus voltage	Y	Y	Y	Y	Y	Y	Y
Input power	Y	Y	Y	Y	Y	Y	N
Accumulated electric power	N	N	Y	Y	Y	Y	N
Load factor	N	N	Y	Y	Y	Y	N
Motor temperature	N	N	N	N	N	Y	N
Temperature inside inverter	N	N	Y	N	Y	Y	Y
Heat sink temperature	Y	Y	Y	Y	Y	Y	Y
Output current	N	N	N	N	Y	Y	Y
Motor output power	N	N	Y	Y	Y	Y	N
Input voltage on terminal [I2]	Y	Y	Y	Y	Y	Y	Y
Input current on terminal [C1]	Y	Y	Y	Y	Y	Y	Y
Input voltage on terminal [V2]	N	N	Y	Y	Y	Y	Y
Position deviation in synchronous operation	N	N	N	N	Y	Y	N

Y: Available, N: Not available

 **Note** Selected item may be invalid according to the inverter model or version.  
Please check that the item is valid or not in the inverter manual..

## Filter

Specify the filter for each channel as shown below.

### Disabled

Select this option when using no filter.

### Manual filtering

Selecting this uses the low-pass filter (lpf) with a filter time constant arbitrarily specified.

#### Select time constant for manual filtering

Select the filter time constant from the following:

Historical trace: 5, 10, 20, 50, 100 ms

Real-time trace: 50, 100 ms

### Peak waveform (within a sampling time)

Selecting this displays the maximum monitored value in the sampling cycle.

### Automatic filtering

Selecting this performs anti-aliasing, corresponding to the sampling cycle.

Filter time constant = lpf with "sampling cycle x 3.2"

(Example) When the sampling time is set at 1 ms:

Filter time constant = 3.2 ms

## Trigger

Specify the trigger for each channel as shown below.

### Trigger

Select a channel for which the trigger is to be specified. For an analog channel, only one trigger can be specified.

### Level

Use the slide bar to specify the level in %.

Use the **Actual value** box to specify the data amount of monitor item selected for each channel.

### Edge

Select either the rising edge (↑) or trailing edge (↓) of the trigger.

**Note** To customize the filter or the trigger for real-time trace, it is necessary to select the "Use reserved communication commands" check box of the Communication command on the Others window called up by selecting **Advanced...** | **Others**.

---

## Style line

Clicking the **Advance...** button calls up the **Style line** dialog shown below.



In this dialog, you can style a trace line for each selected channel.

### Color

Click the **Color** box to call up the **Color** dialog shown below.

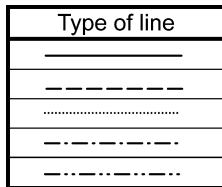

### Type of line

Select the desired type of a trace line using the pull-down menu.



### Thickness

Select the desired thickness of a trace line using the pull-down menu.

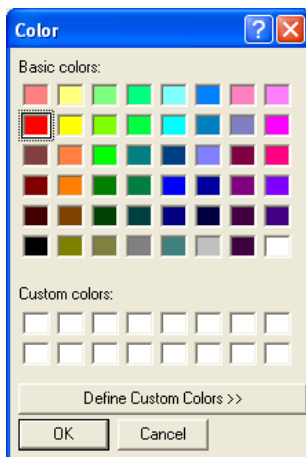

Select the desired color for a trace line and click **OK**.

### [ 3 ] Ch1 to Ch8 (Digital channels)

Selecting digital channels in the **configuration** window in [ 1 ] in this section and selecting any of **Ch1** to **Ch8** tabs displays the following window that is used for advanced setup of the digital channels.

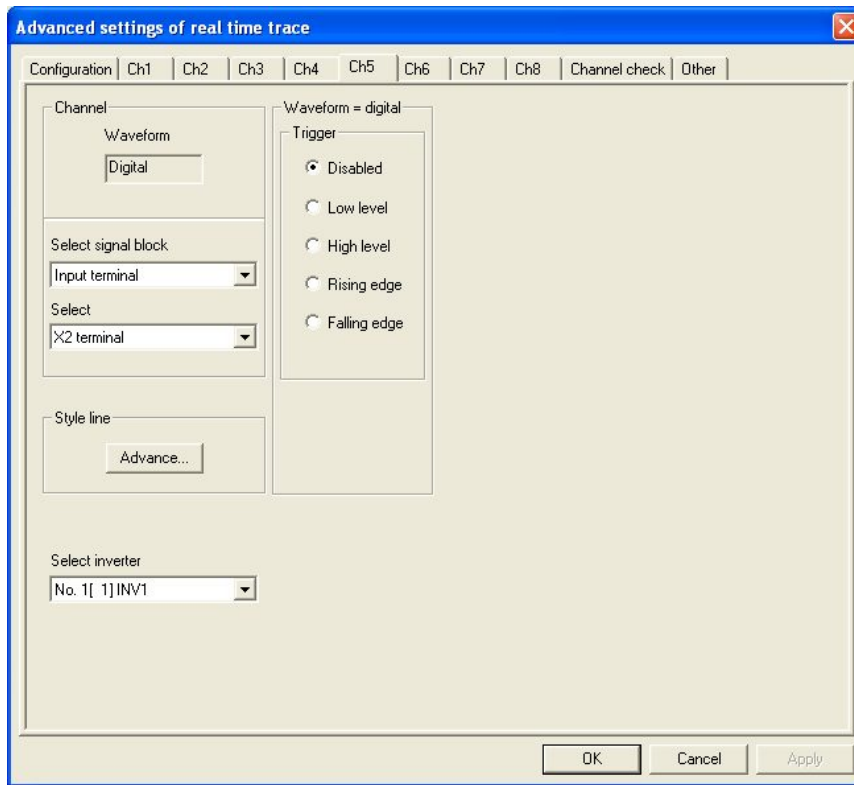

#### Subject inverter

Select the inverter number that has been registered in the connection setting.

**Note** This item does not apply to the historical trace.

#### Channel

This box shows the channel type that has been selected in the **Configuration** window.

#### Select signal block--Control signal input terminals

Listed below are items that can be real-time traced for inverters.

Signal input terminals	Mini (C1S)(C2S)	Eco	Multi	Ace	MEGA	HF
X1	Y	Y	Y	Y	Y	Y
X2	Y	Y	Y	Y	Y	Y
X3	Y	Y	Y	Y	Y	Y
X4	N	Y	Y	Y	Y	Y
X5	N	Y	Y	Y	Y	Y
X6	N	N	N	N	Y	Y
X7	N	N	N	N	Y	Y
X8	N	N	N	N	Y	N
X9	N	N	N	N	Y	N
EN	N	N	N	Y	Y	Y
FWD	Y	Y	Y	Y	Y	Y
REV	Y	Y	Y	Y	Y	Y

Y: Available, N: Not available

---

### Select (signal item)--Signal output terminals

Listed below are items that can be real-time traced for inverters.

Signal output terminals	Mini (C1S)(C2S)	Eco	Multi	Ace	MEGA	HF
Y1	Y	Y	Y	Y	Y	Y
Y2	N	Y	Y	Y	Y	Y
Y3	N	Y	N	N	Y	Y
Y4	N	N	N	N	Y	Y
Y5	N	Y	N	N	Y	Y
30A/B/C	Y	Y	Y	Y	Y	Y

Y: Available, N: Not available

 **Note** Selected item from input or output terminals may be invalid according to the inverter model or version. Please check that the item is valid or not in the inverter manual.

### Style line

Style a trace line in the same way as for analog signals. (Refer to "[ 2 ] Ch1 to Ch4 (Analog channels)" in this section.)

### Trigger

Specify the trigger for each channel as shown below.

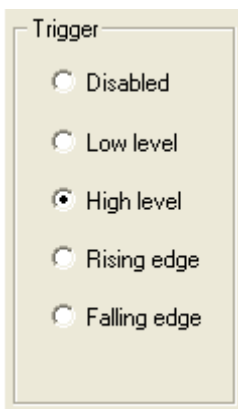

#### **Trigger**

Select Low level, High level, Rising edge (↑) or Falling edge (↓).

For a digital channel, specifying more than one trigger is possible.

Triggers can be ORed or ANDed in detection. (Refer to "[ 5 ] Other settings" in this section.)

 **Note** To customize the trigger for real-time trace, it is necessary to select the "Use reserved communication commands" check box of the Communication command on the Others window called up by selecting **Advanced... | Others**.



### [ 4 ] Channel check

Selecting the **Channel check** tab displays the following window that allows you to confirm your real-time trace channel setup. To make your setting effective, press **OK**; to cancel it, press **Cancel**.

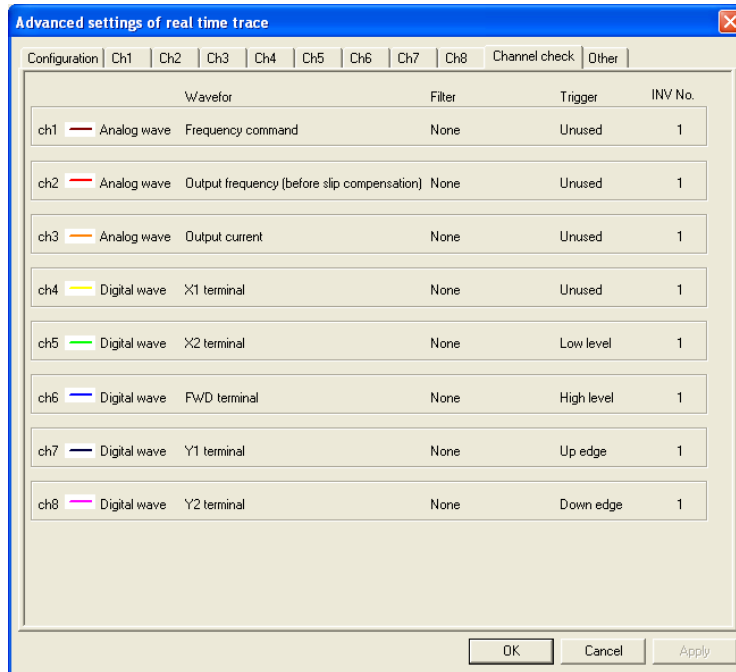

### [ 5 ] Other settings

Selecting the **Other** tab displays the following window that allows you to customize your real-time trace waveform configuration in details.

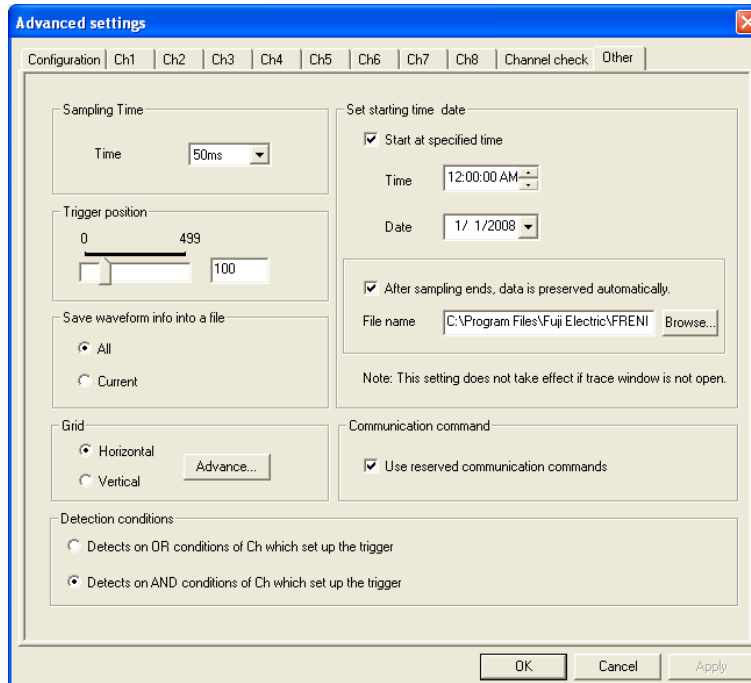

## Sampling time

Specify the sampling time, referring to the table below.

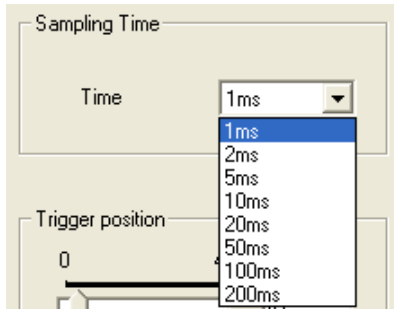

Sampling time	Real-time trace	Historical trace
1 ms	N	Y
2 ms	N	Y
5 ms	N	Y
10 ms	N	Y
20 ms	Y (Note)	Y
50 ms	Y	Y
100 ms	Y	Y
200 ms	Y	Y

Y: Available, N: Not available

**Note** When selecting 20 ms for real-time trace, select the RS-385 connection and 38400 bps; otherwise, the graph display may be intermissive.

## Trigger position

Specify the number of sampling points preceding the trigger point.

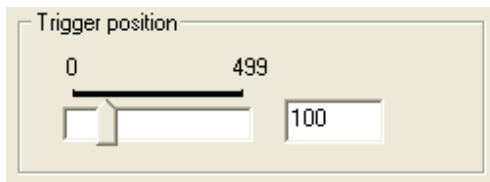

## Detection conditions

Specify the trigger detection conditions--"OR" or "AND."

Analog: Only one channel

Digital: Channels 1 to 8

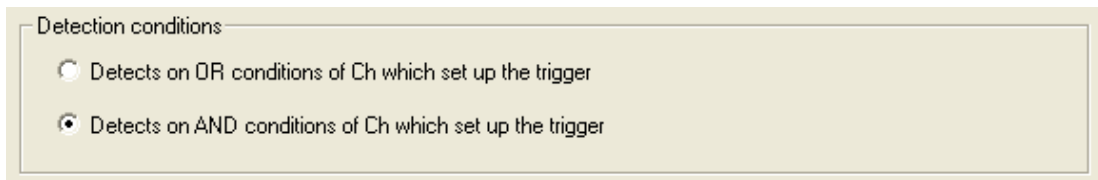

**Note** To customize the sampling time, trigger position, or trigger detection conditions for real-time trace, it is necessary to select the "Use reserved communication commands" check box of the Communication command on the Others window called up by selecting **Advanced... | Others**.

**Grid**

Clicking the **Advance...** button calls up the **Style line** dialog shown below.

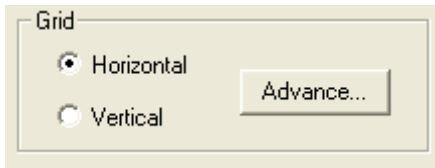

In this dialog, you can style a grid line for each selected channel.

**Color**

Click the **Color** box to call up the **Color** dialog shown below.

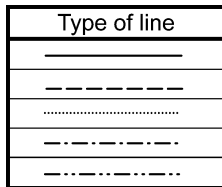

**Type of line**

Select the desired type of a grid line using the pull-down menu.



**Thickness**

Select the desired thickness of a grid line using the pull-down menu.



Select the desired color for a grid line and click **OK**.

---

### Save waveform info into a file

Specify the range of a waveform to be saved into a file.

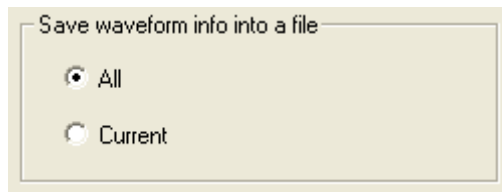

Save waveform info into a file

All

Current

### Set trace start date and time

Set the date and time to start tracing.

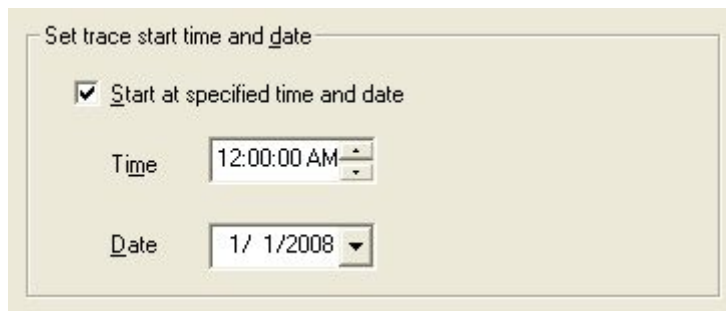

Set trace start time and date

Start at specified time and date

Time 12:00:00 AM

Date 1/ 1/2008

### Auto Save

Select this option to automatically save trace data.

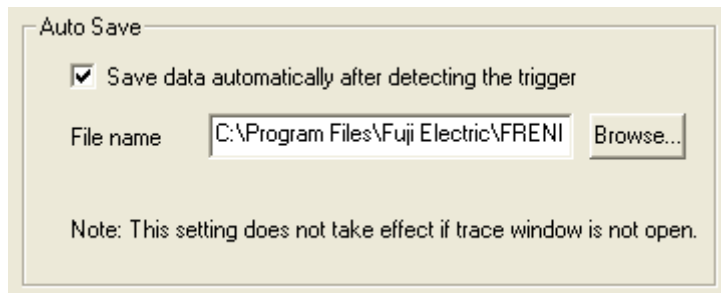

Auto Save

Save data automatically after detecting the trigger

File name C:\Program Files\Fuji Electric\FRENI Browse...

Note: This setting does not take effect if trace window is not open.

### Communication command

Select this option to use data saved in the inverter memory during real-time tracing.

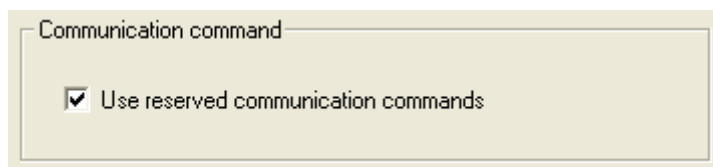

Communication command

Use reserved communication commands

- Note**
- Without selecting this option, the sampling time, trigger position, trigger detection conditions, trace start date and time, or auto save for real-time trace cannot be customized.
  - Historical trace does not support this option.
  - FRENIC-Mini (C1S) [FRN-C1S] /-Eco[FRN-F1S] /-Multi [FRN-E1S] do not support the selection of communication command.

### 2.3.5.6 Optimizing Y-axis of the graph

Clicking the **Y Cursor Adjust** button at the bottom of the screen automatically optimizes the position and measuring scale of the Y-axis for monitored data of each channel.



Before optimization

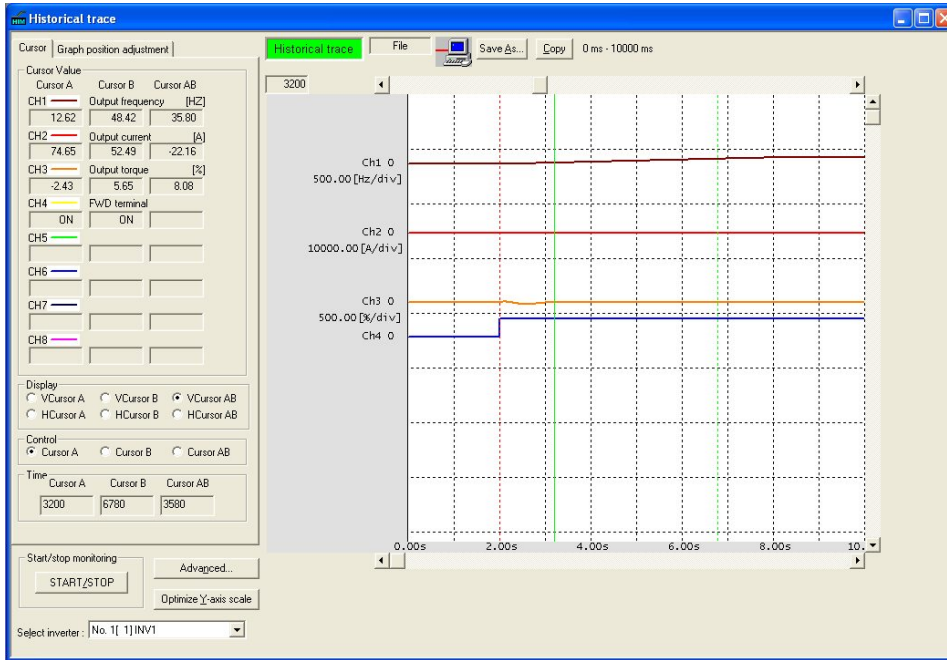

After optimization

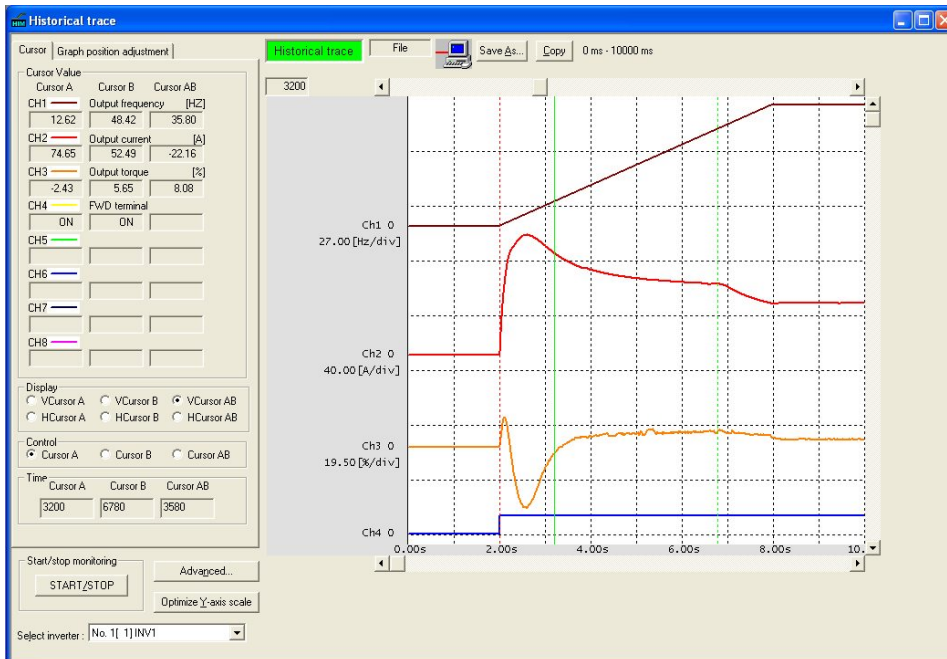

## 2.3.6 Quick access menu

The **Quick Access Menu** enables an access to any of the 10 most frequently used functions (programs) with a single click of the mouse.

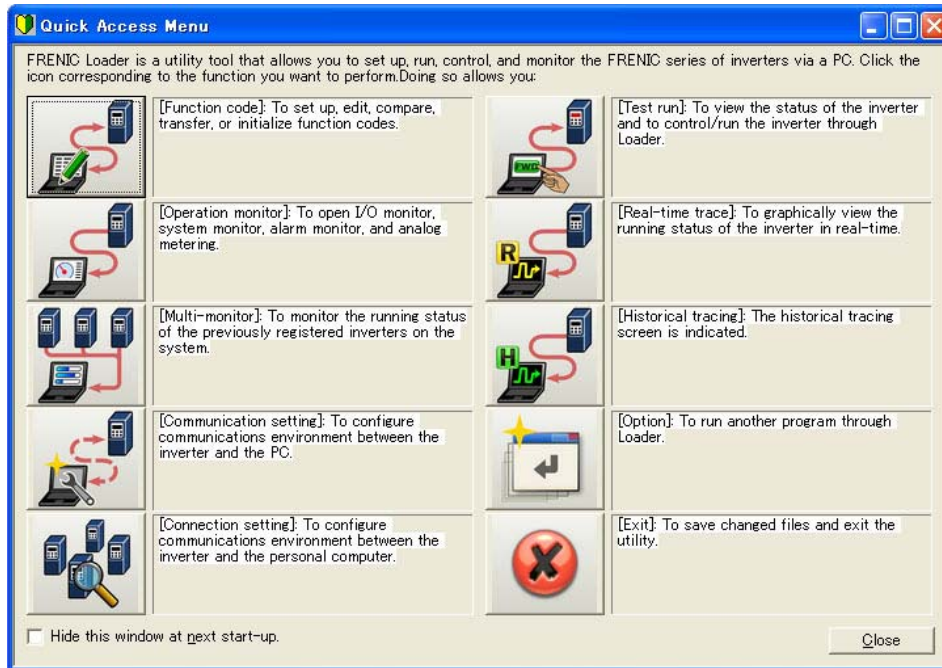

**Tip** When the **Quick Access Menu** is not displayed, click the  icon on the toolbar to call it up.



**Note** • If "USB: Data in keypad" has been selected in communications setting, the [Multi-monitor], [Real-time trace], or [Historical tracing] cannot be selected.

## 2.3.7 Option

Selecting **Menu | Option** calls up the **option** window (shown below) which is used to open a file or program related or unrelated to Loader.

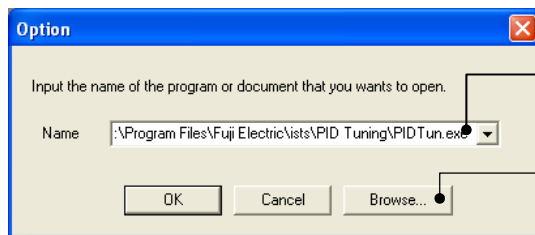

### Name

Enter or select the name of an object (a file or program) to be opened.

### Browse...

Open the dialog to browse for the location containing the file or program to be opened.

If you have typed in or chosen a file or a program name in the **Name** combo box, click **OK** to open it.

## 2.4 View

Selecting **View | Toolbar | Main** shows or hides the toolbar.

Selecting **View | Status Bar** shows or hides the status bar.

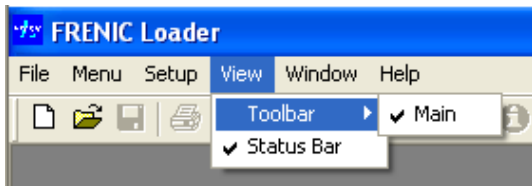

### 2.4.1 Toolbar

The toolbar, which is usually located at the top of the Loader window, contains program icons and allows you to access the desired function (program) with a single click.

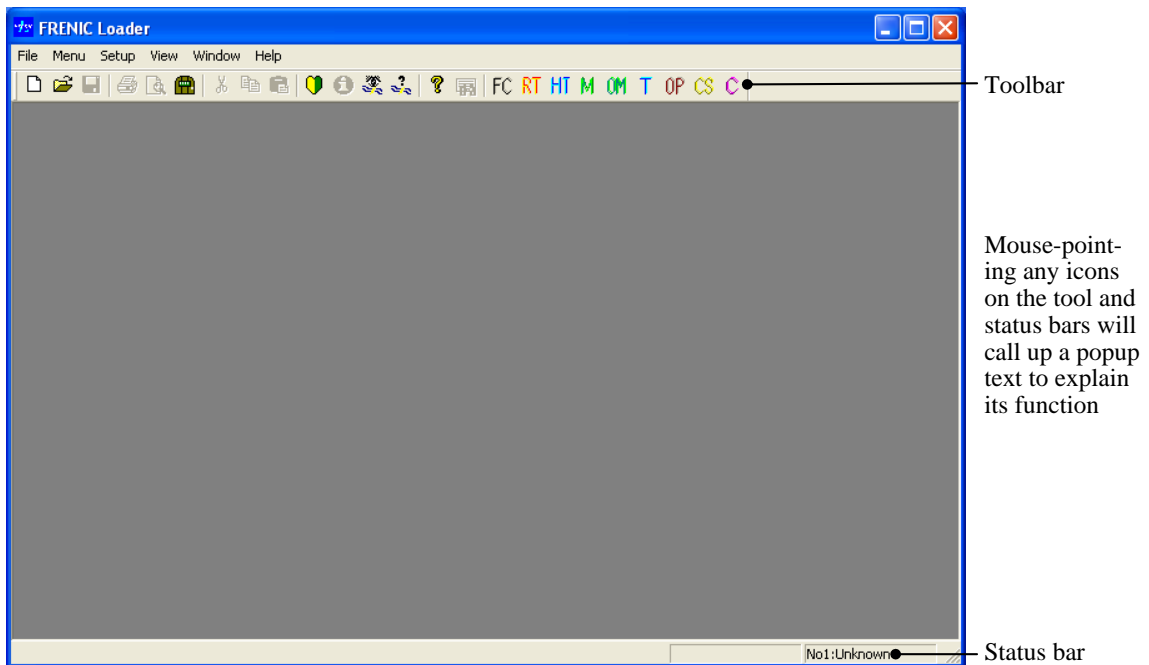

### 2.4.2 Status bar

The status bar, which is usually located at the bottom of the Loader window (as shown above), shows the running status of the currently selected inverter and the program execution status.

## 2.5 Window

Specify how to display the Loader windows on the Loader top window. This facility becomes active only if any window is opened on the top window.

### 2.5.1 Cascade windows

Selecting **Window | Cascade** arranges multiple windows, overlapping each other. You can call an inactive window up by clicking its title bar.

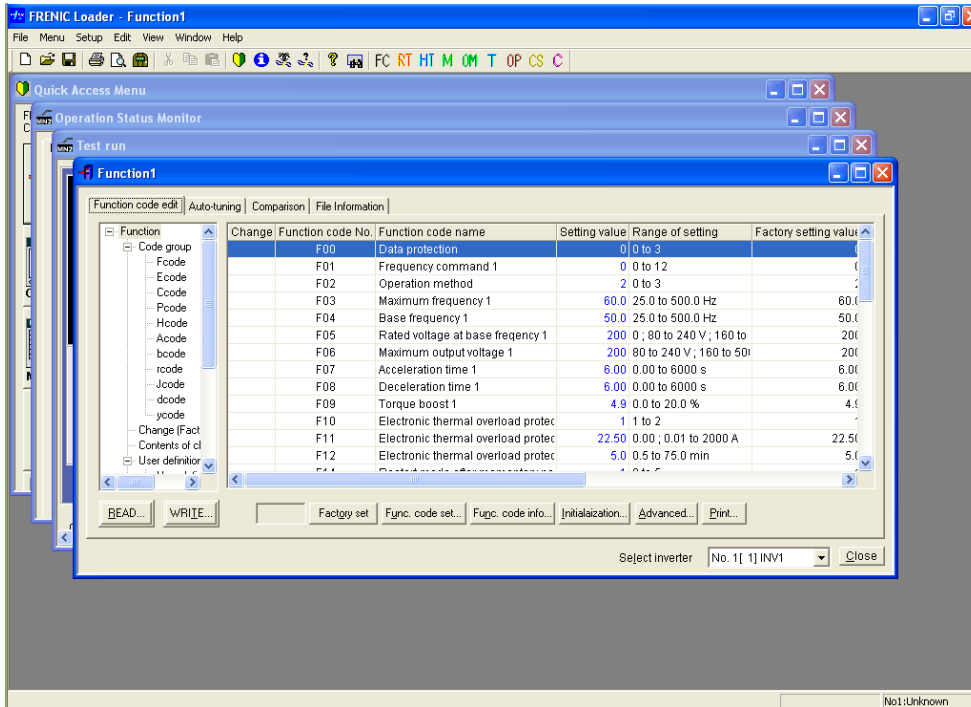

### 2.5.2 Tile windows

Selecting **Window | Tile** tiles multiple windows so that all windows are seen together.

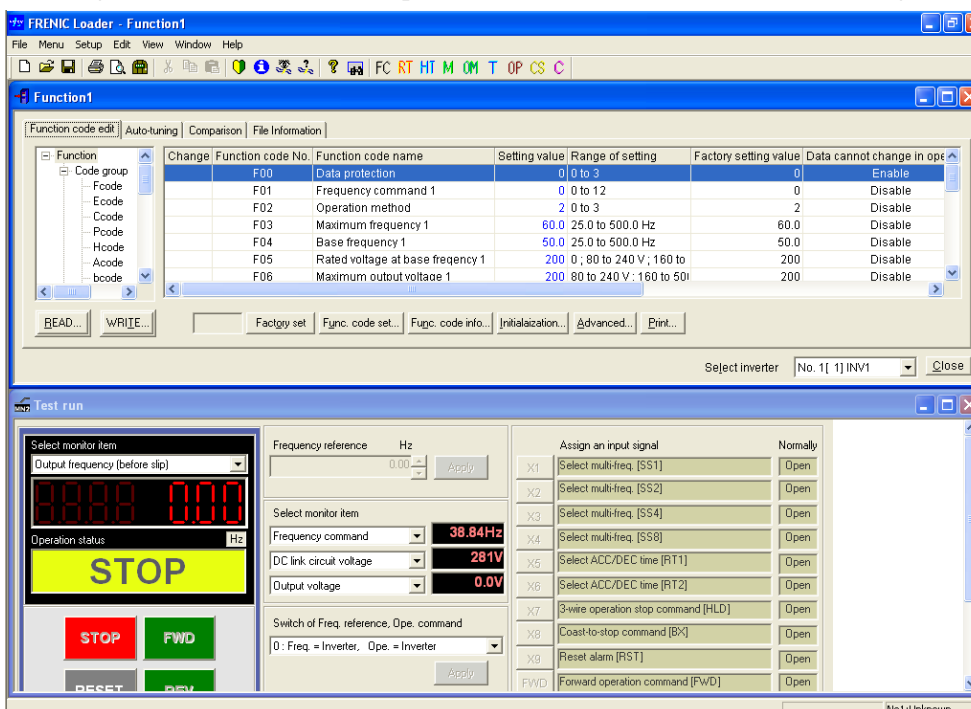



## 2.5.3 Tile windows vertically

Selecting **Window | Tile vertically** tiles multiple windows vertically.

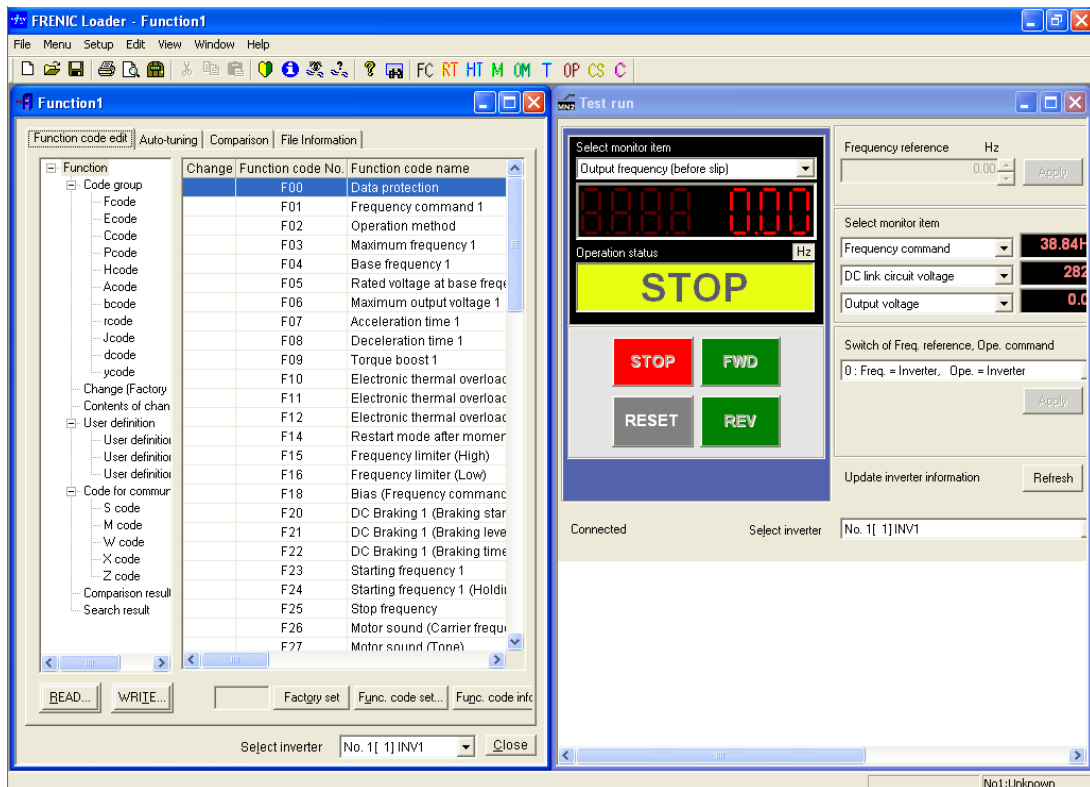

## 2.5.4 Arrange icons

Selecting **Window | Arrange Icons** arranges icons of the active windows or programs at the bottom of the Loader top window.

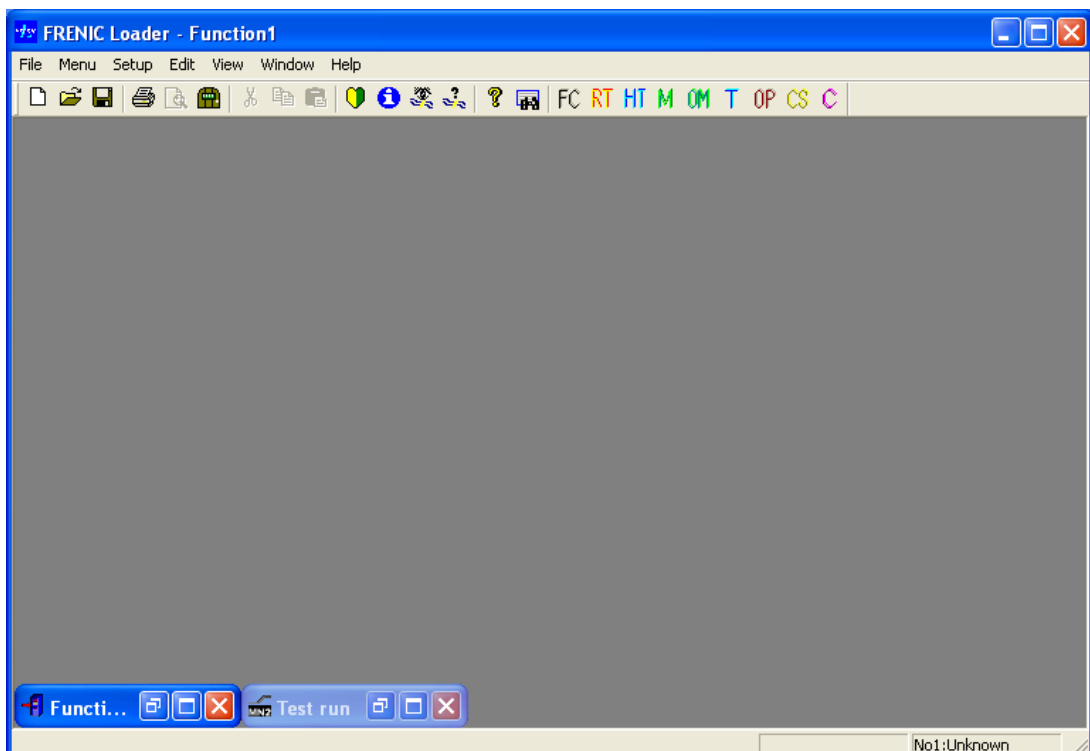

---

## 2.6 Help

### 2.6.1 About FRENIC Loader

Selecting **Help** | **About Loader** shows the FRENIC Loader version, copyright, and license information.



---

# **Chapter 3**

## **Reference Information**

This chapter contains troubleshooting and major specifications of FRENIC Loader 3.x.



## 3.1 Troubleshooting

If any problem occurs during Loader operations, follow the steps listed in the troubleshooting chart shown below.

For USB connection

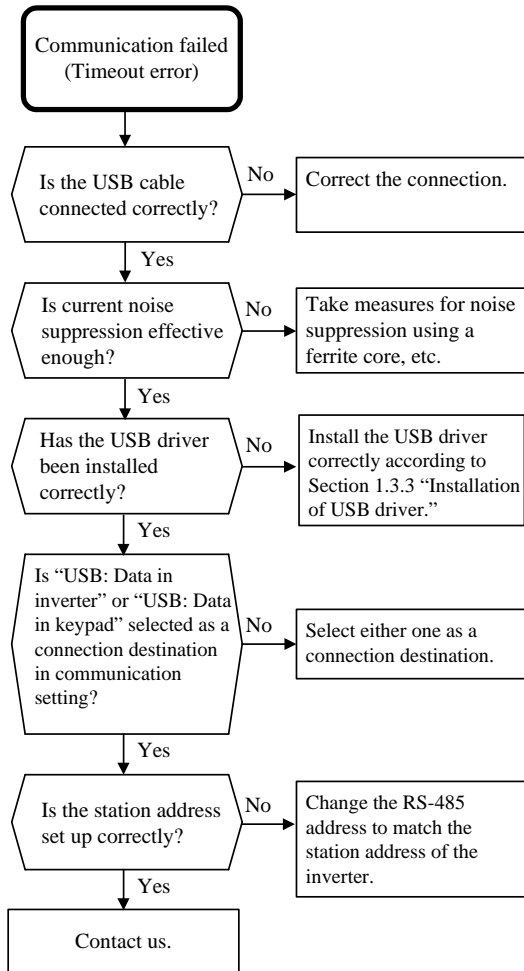

For RS-485 connection

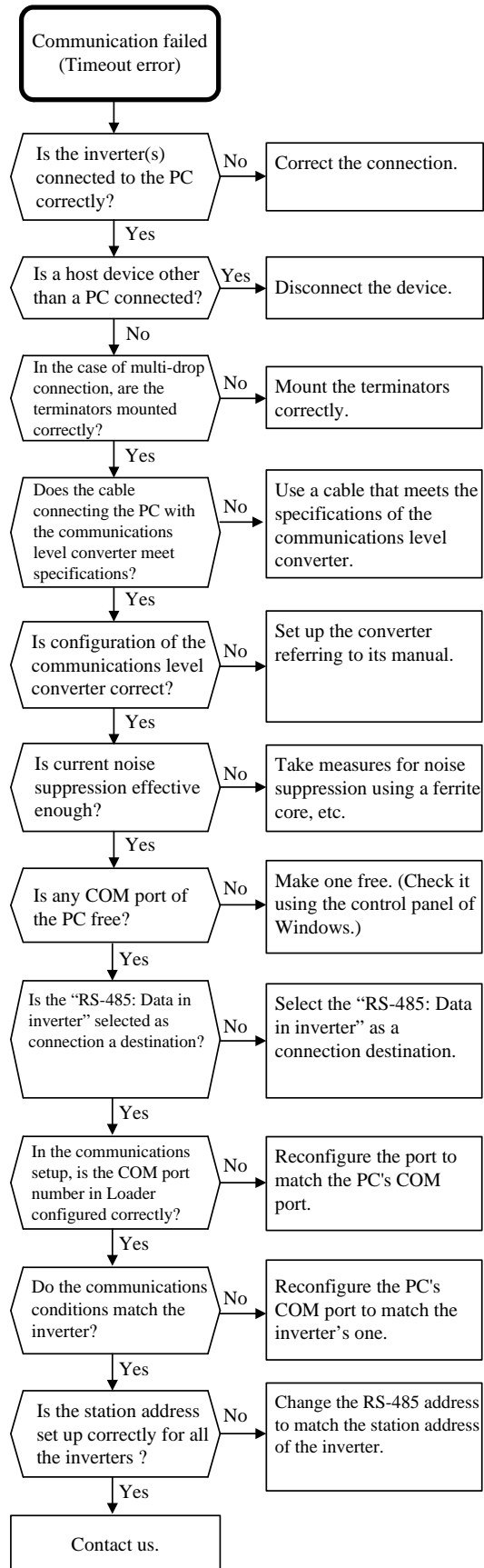

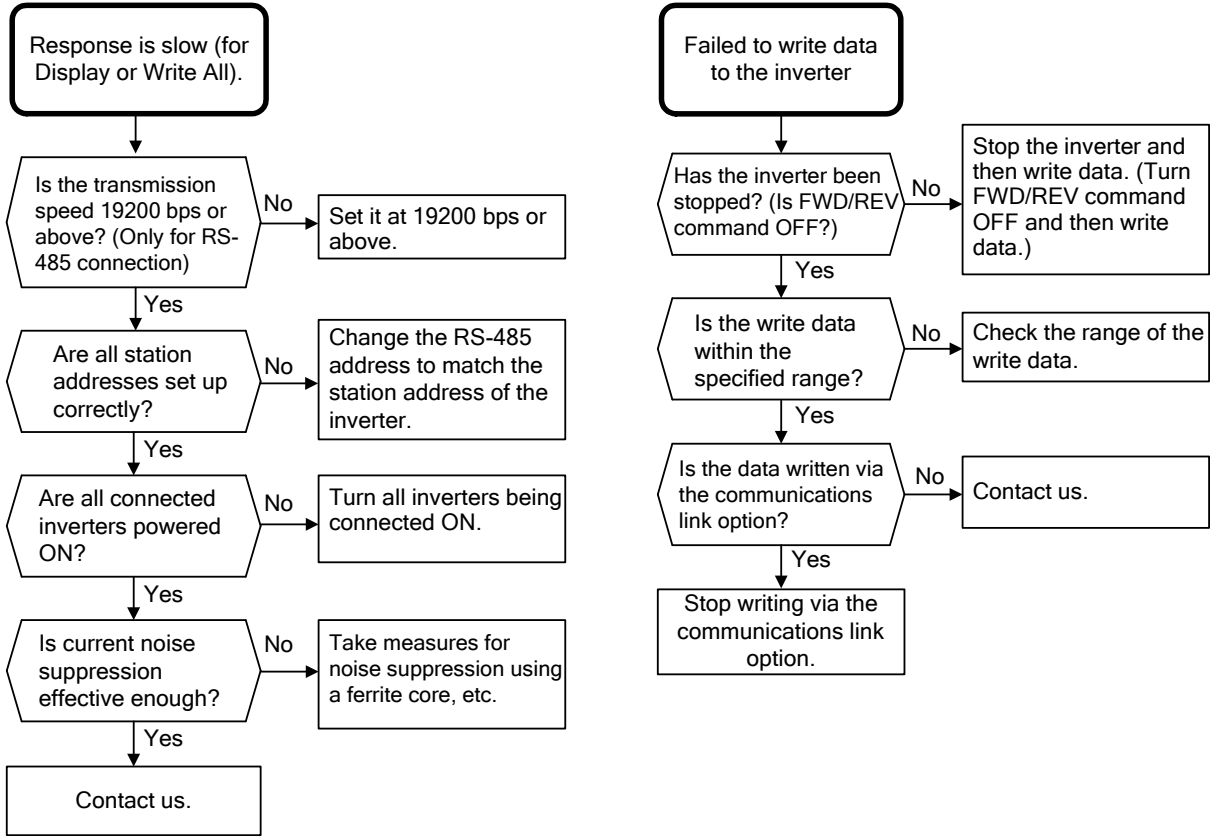

## 3.2 Frequently asked questions (FAQ)

### 3.2.1 Cannot communicate with inverter (Failed to get inverter information)

#### 3.2.1.1 Message Manager not installed correctly

Message Manager is software that manages communication between the PC and inverter.

If Message Manager has not been installed correctly, your PC cannot communicate with the inverter. The installation state can be checked in the task bar of Windows OS (see the Message Manager icon sample given below). If no Message Manager icon is displayed in the task bar, Message Manager has not been installed correctly.

Delete the folder (including its contents) named Fuji Electric Shared in the file path as shown below, and then **reinstall Loader**.

C:\Program Files\Common Files\Fuji Electric Shared

(In the file path shown above, "C" represents the drive letter of the partition or hard disk where Windows is installed. If Windows is installed on a different drive in your system, replace "C" with the letter corresponding to that drive.)

#### **Message Manager icon sample**

[ 1 ] Windows 7

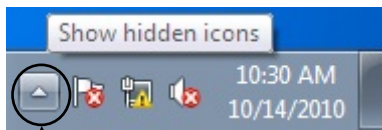

Click here to show the hidden icon.



[ 2 ] Windows Vista/ Windows XP/ Windows 2000

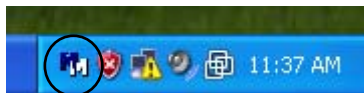

### 3.2.1.2 USB driver not installed correctly (for FRENIC-MEGA/HF/Mini(C2S)/Ace)

To communicate with the inverter via the USB connector provided on the FRENIC-MEGA/HF keypad, the USB driver (Loader USB device) should be installed.

If the USB driver has not been installed correctly, **Unknown device** appears as shown below.

Target models:

- > MEGA
- > HF
- > Mini (C2S) (Option:TP-E1U)
- > Ace(Option:TP-E1U)

Installation finished successfully

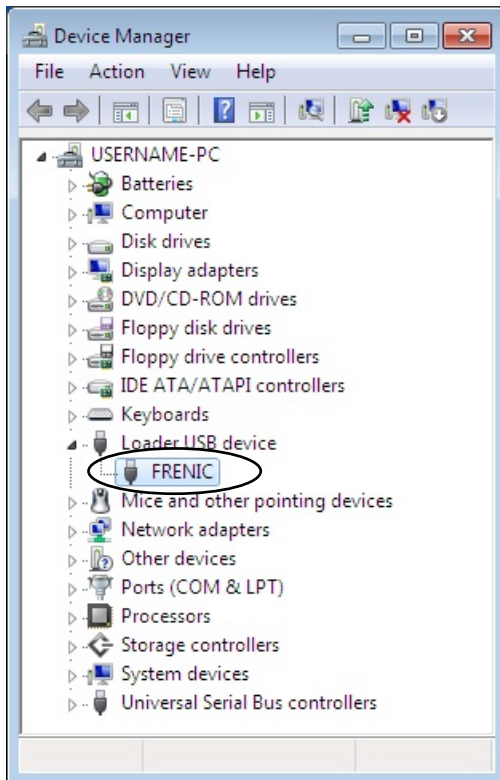

Installation failed

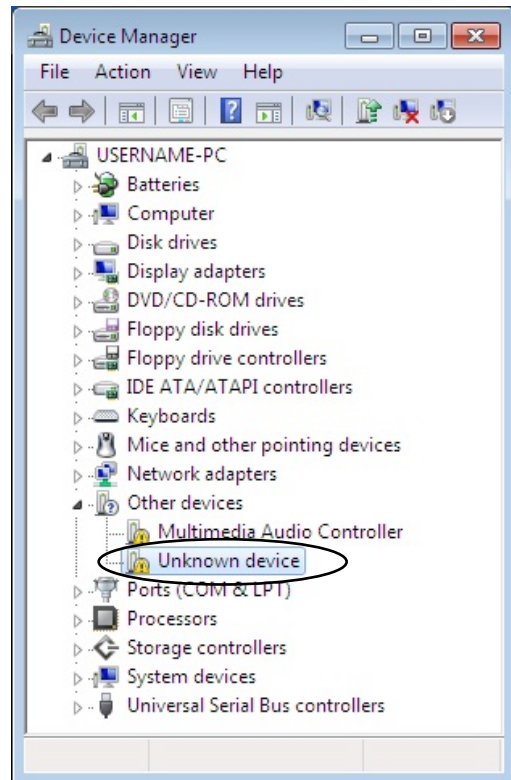

#### [ 1 ] Windows 7

Refer to Section 1.3.2.1 "Installing the USB driver, [ 1 ] Windows 7."



## [ 2 ] Windows Vista

Follow the wizard and install the USB driver as shown below.

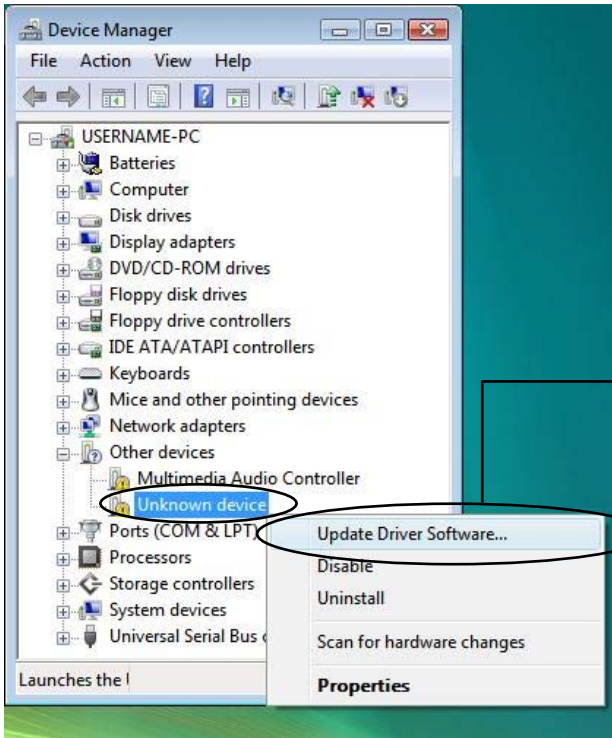

From the **Start** menu, select **Control Panel | Hardware and Sound | Device Manager** to open Device Manager as shown at left.

Right-click **Unknown device** to show the drop-down list.

Click **Update Driver Software...** to proceed.

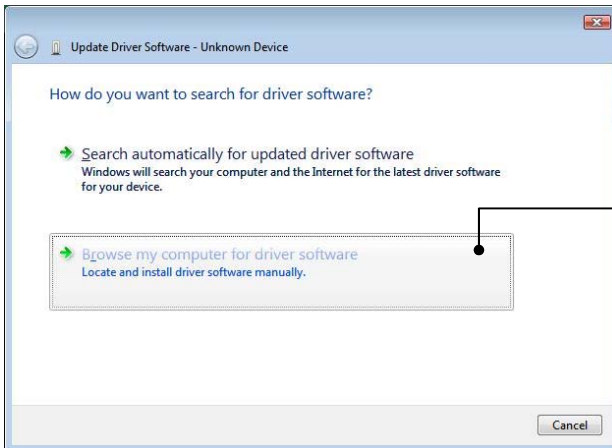

Click **Browse my computer for driver software.**

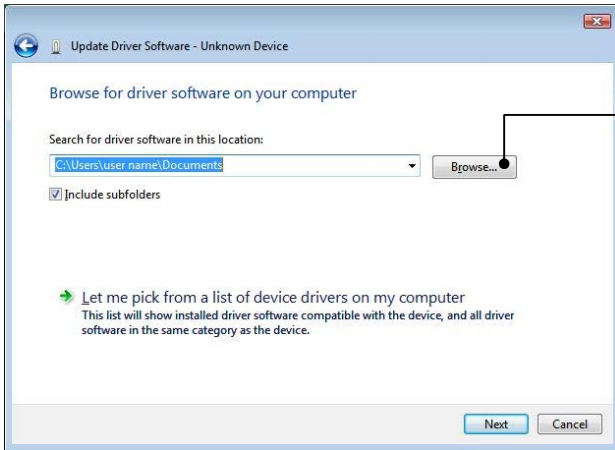

Click **Browse...**

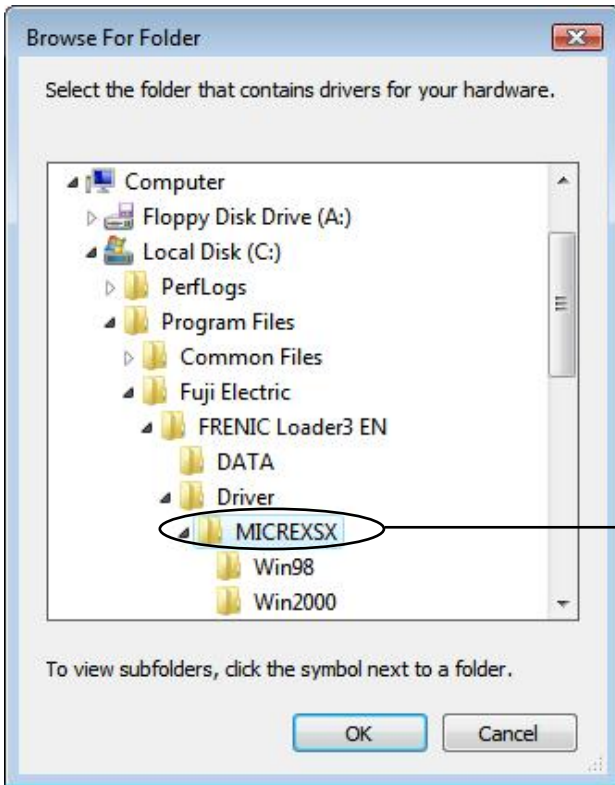

In the folder in which FRENIC Loader has been installed, select \Driver\MICREXSX and then click **OK**.

The default folder is C drive when the OS, 32-bit

C:\Program Files\Fuji Electric\FRENIC Loader3 EN\Driver\MICREXSX

64-bit

C:\Program Files(x86)\Fuji Electric\FRENIC Loader3 EN\Driver\MICREXSX

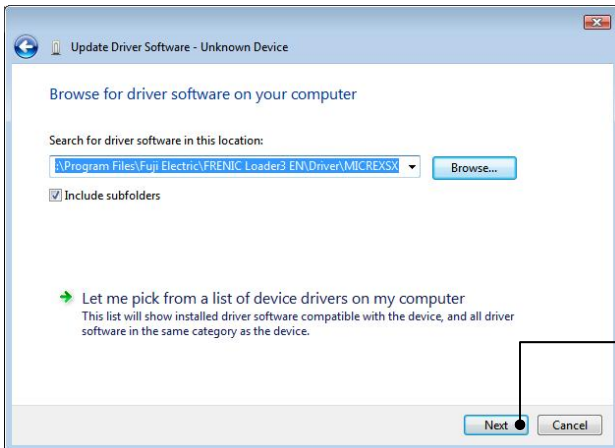

To continue, click **Next**.

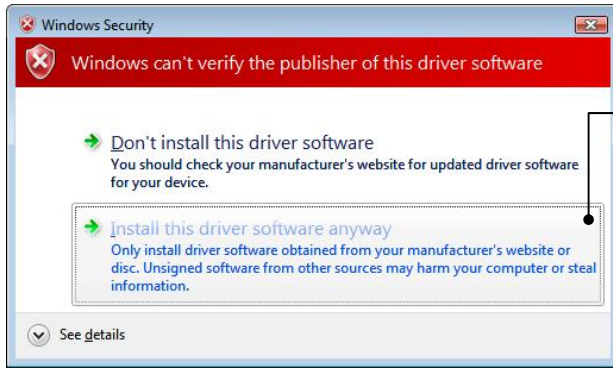

Click **Install this driver software anyway**.

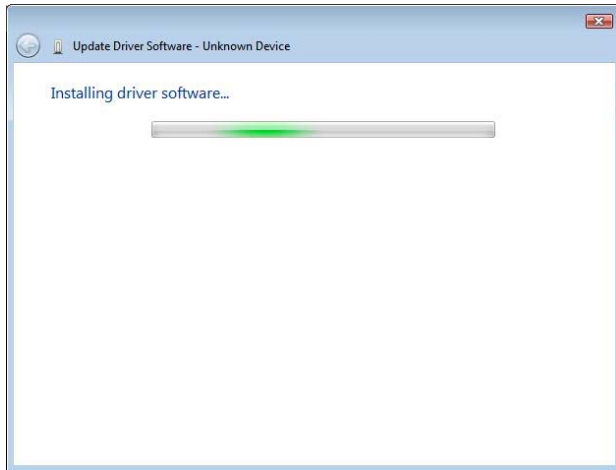

Installation starts.

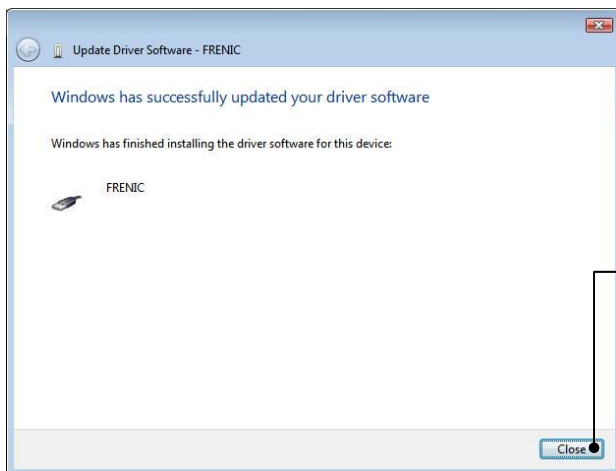

Upon completion of the installation, the screen at left appears.

To exit the installation wizard and return to Windows, click **Close**.

### [ 3 ] Windows XP

Follow the wizard and install the USB driver as shown below.

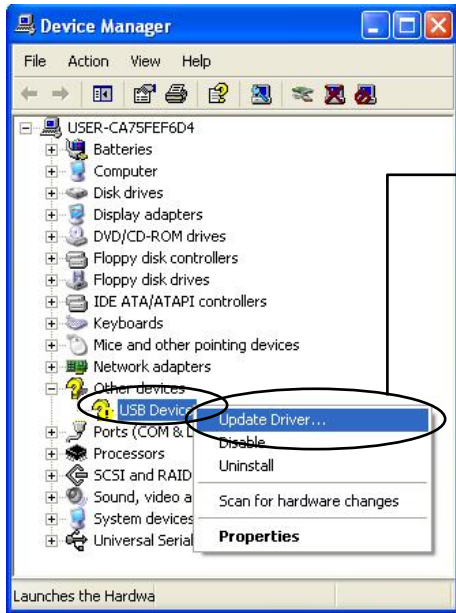

From the **Start** menu, select **Control Panel | System | Hardware | Device Manager** to open Device Manager as shown at left.

On the sub-tree of **Other devices**, right-click **USB Device** to show the drop-down list. Click **Update Driver...** to start the update wizard of the hardware. Install the USB driver, referring to Section 1.3.2.1 "Installing the USB driver."

### [ 4 ] Windows 2000

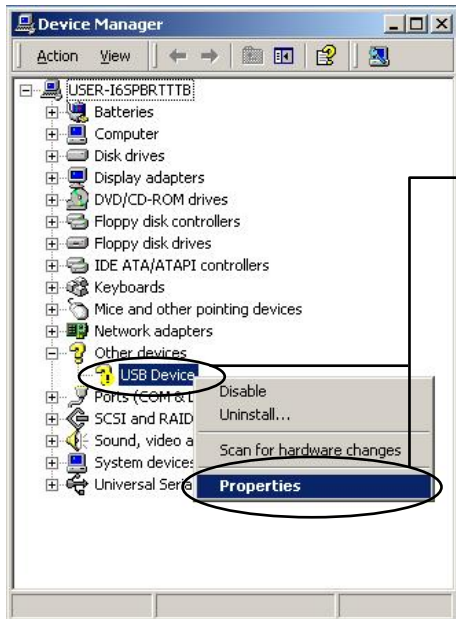

From the **Start** menu, select **Settings | Control Panel | System | Hardware | Device Manager** to open Device Manager as shown at left.

On the sub-tree of **Other devices**, right-click **USB Device** to show the drop-down list. Click **Properties**.

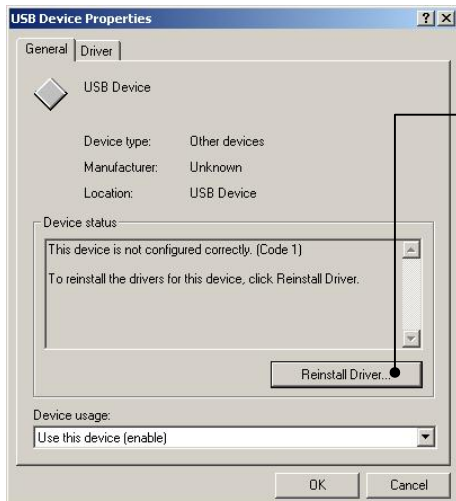

Click **Reinstall Driver...** to start the update wizard of the device driver. Install the USB driver, referring to Section 1.3.2.1 "Installing the USB driver."

### 3.2.1.3 USB driver installed correctly (for FRENIC-MEGA/HF/Mini(C2S)/Ace)

Target models:

- > MEGA
- > HF
- > Mini(C2S)(Option:TP-E1U)
- > Ace(Option:TP-E1U)

Although the USB driver has been installed correctly, Loader cannot communicate with the inverter. This problem is considered to be caused by installing the USB driver when Message Manager is running.

In this case, Message Manager is no longer able to recognize the USB driver, so it is necessary to quit both Loader and Message Manager and then start Loader again.

#### Quitting Message Manager

##### [ 1 ] Windows 7

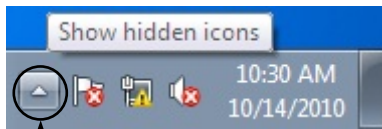

Click this to display the hidden icons as shown below.

Right-click this icon to display **Exit MessageManager**, then click it. The confirmation window appears. Click **Yes** to quit Message Manager.

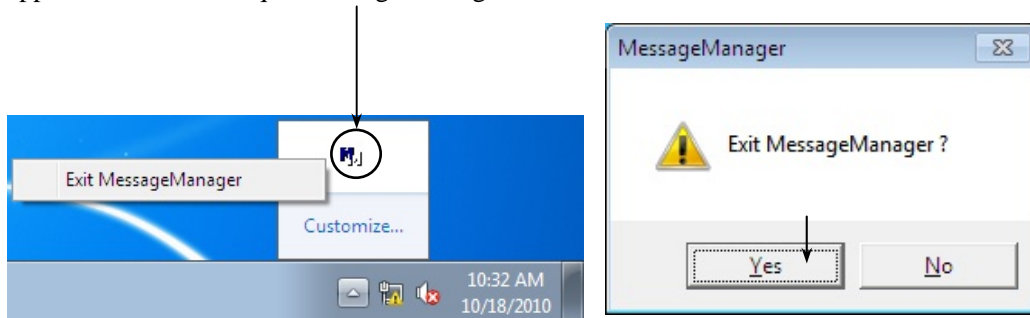

##### [ 2 ] Windows Vista/Windows XP/Windows 2000

Right-click the Message Manager icon to display **Exit MessageManager**, then click it. The confirmation window appears. Click **Yes** to quit Message Manager.

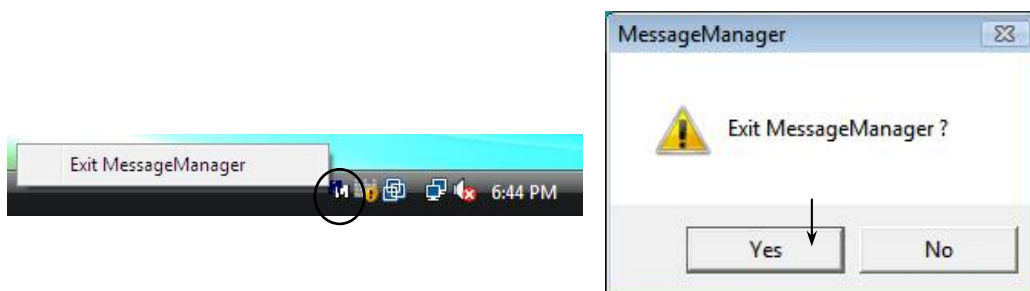

---

#### **3.2.1.4 USB communication impossible after the PC has gone standby or to sleep)**

If Windows 7 or Windows Vista goes standby or to sleep, Loader cannot recognize the USB driver so that it cannot communication with the inverter. Follow the instructions given below.

##### **[ 1 ] Windows 7**

**Turn the PC power OFF and ON, then restart Loader.**

**Note:** Unplugging and plugging the USB connector cannot enable the OS to recognize the USB driver again.

##### **[ 2 ] Windows Vista/Windows XP/Windows 2000**

**Unplug and plug the USB connector, then restart Loader.**

**Note:** Unplugging and plugging the USB connector enables the OS to recognize the USB driver again.

#### **3.2.1.5 If "1:loader protocol" is set in both function code y10 and y20 "RS-485 setting (protocol selection)"**

Target models:

- > MEGA(ROM version : 3900 or later)
- > Ace

If the function code y20 and y10 are set to the same value "1: SX protocol (protocol loader)", the priority of the connection is as follows.

**(RS-485 Ch1 < RS-485 Ch2 < USB)**

Ch of priority higher can be connected.

### 3.2.2 Cannot read or write function code data from/to the inverter

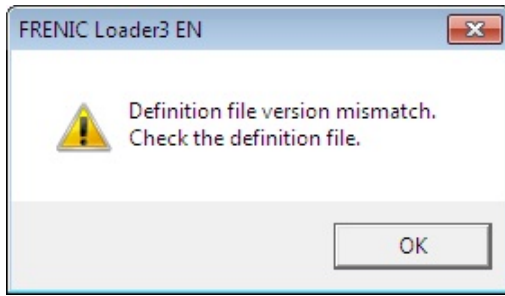

**Definition file** refers to a form describing information on function codes.

If the ROM version of the current definition file and that of the inverter do not match, Loader cannot read or write function code data from/to the inverter.

To read or write function code data from/to the inverter, it is necessary to perform as follows relation between a definition file and an inverter ROM version.

Example (FREINIC-MEGA)

Definition file	Inverter ROM version
fnc_x_3_0000o.csv	0000 to 0499
fnc_x_3_0500e_EN.csv	0500 to 0999
fnc_x_3_1000a_EN.csv	1000 to 1999
fnc_x_3_2000_EN.csv	2000 to 2999
fnc_x_3_3000a_EN.csv	3000 to 3599
fnc_x_3_3600_EN.csv	3600 or 3799
fnc_x_3_3800_EN.csv	3800 or later

To check the inverter ROM version, select **Operation Monitor | System Monitor** from the **Quick Access Menu**. On the System Monitor window, see the Main control CPU field in the ROM Ver. area.

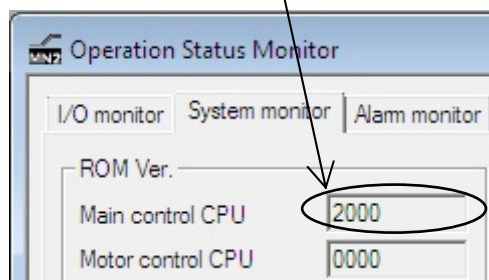
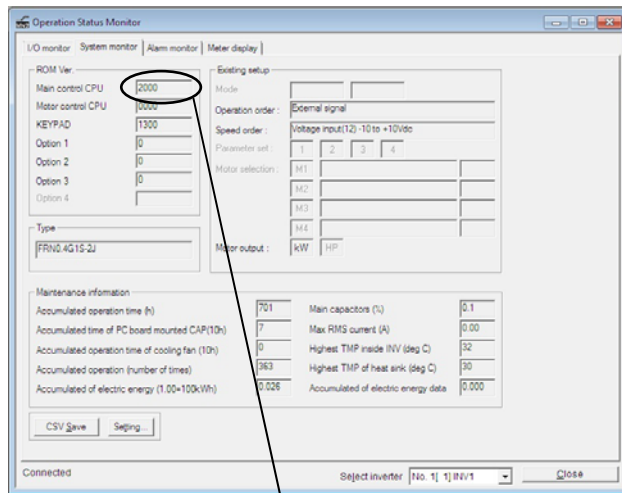

This screen shows that the ROM version of the connected inverter is 2000.



To change the current definition file, click **Change**. In the Open window, select the desired definition file that supports the inverter's ROM version.

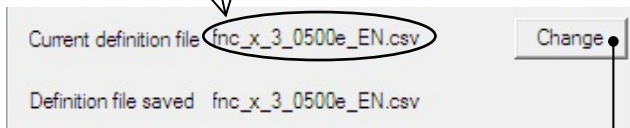
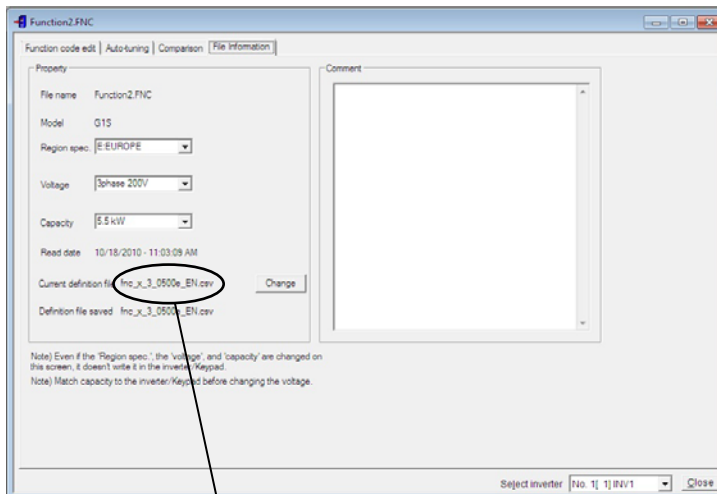

The current definition file supports the inverter ROM version 0500 to 0999. It is necessary, therefore, to change the file to the one that supports version 2000 or later.

Click **Change** to display the Open window as shown below.

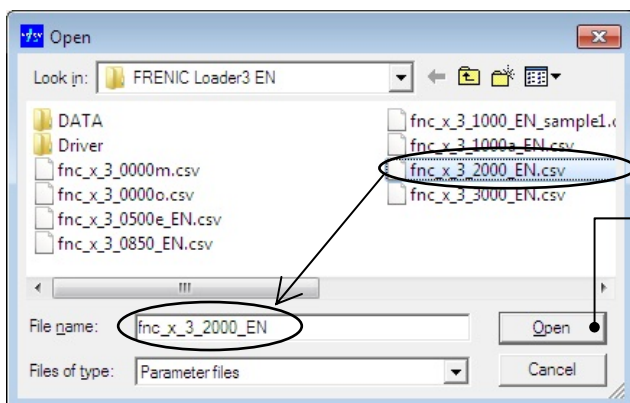

Select the definition file "fnc\_x\_3\_2000\_EN.csv" that supports the inverter ROM version 2000, then click **Open**.

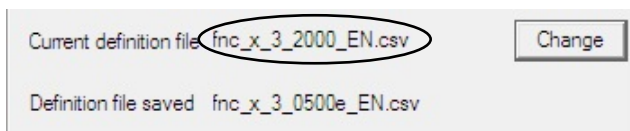

Check that the current definition file is "fnc\_x\_3\_2000\_EN.csv."

**Note** In the Open window above, the definition file to be changed is marked with red. After change, the newly selected file is marked with blue as shown above and the entries in the Comment area disappear.



### 3.2.3 Cannot open saved files (The specified file did not exist)

#### 3.2.3.1 How to open the function code data saved without the specified files.

If the function code data file(\*. fnc) which is saved by the newer loader is opened by previous loader, it may not be able to open and displayed the following message. How to open the function code data saved without the specified files.

Version 7.2.x.x. or earlier

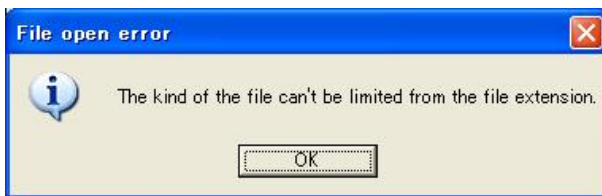
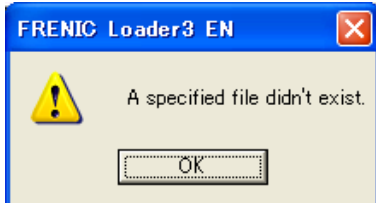

Version 7.3.x.x. or later

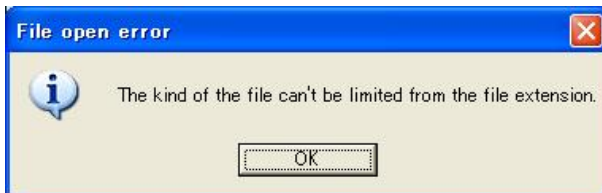

#### **Countermeasures**

Upgrade to the latest version.

### 3.2.3.2 How to open the function code data saved by the previous version

#### 1.1.0.0

When opening the function code data (\*. fnc) of FRENIC-Mini (C1S) saved by the version 1.1.0.0 of the loader, the following messages are displayed and it may be unable to open. It may not have opened since version 6.0.0.0.

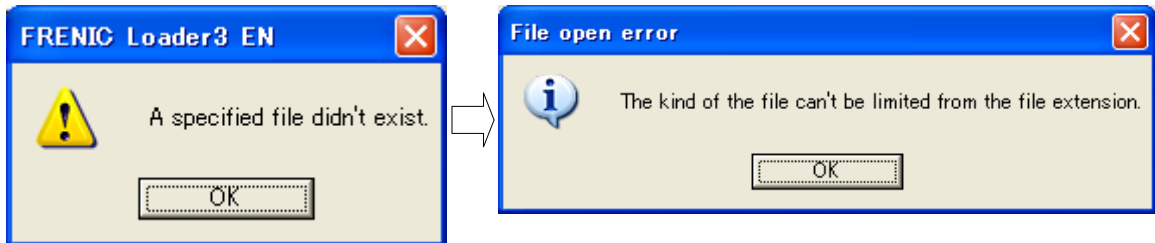

#### Deterrence method

Open the saved function code data (\*. fnc) of FRENIC-Mini (C1S) on a Notepad etc., and do the following work.

- 1) The saved function code data (\*. fnc) is copied, and a name is changed and saved.
- 2) The copied function code data (\*. fnc) is opened by text editors (Notepad etc.).
- 3) It checks that anything does not have description in the part enclosed with the following circle.

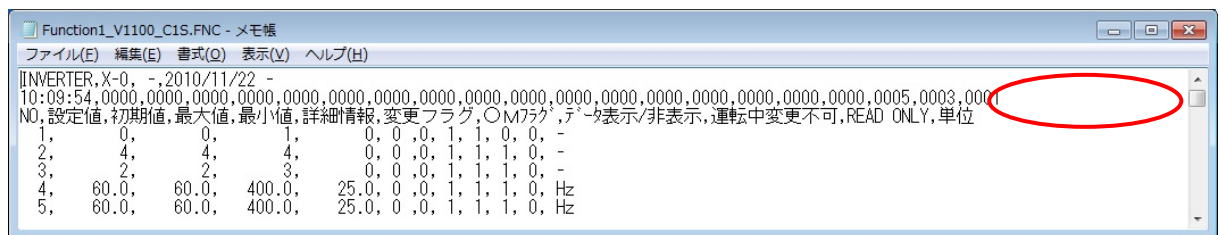

- 4) It is described as “, fnc\_x\_0\_0300.csv” in the part enclosed with the following circle.

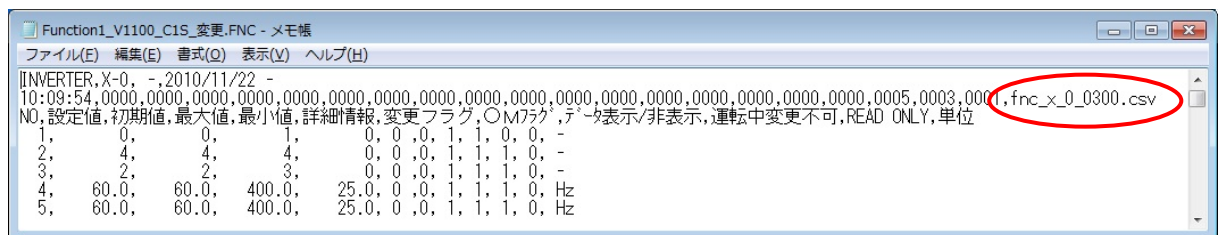

- 5) The function code data (\*. fnc) is saved.
- 6) The copied function code data (\*. fnc) is opened by the loader of a version (Ver 6.0.0.0 or later).

### 3.2.4 Cannot find saved files (Windows 7/Windows Vista)

In Windows 7/Windows Vista, Loader saves function code data and trace waveform data in the directory, C:\Program Files\Fuji Electric\FRENIC Loader3 EN\DATA. If you use Explorer or the like to check the content of the DATA folder in the directory, however, no saved files are found.

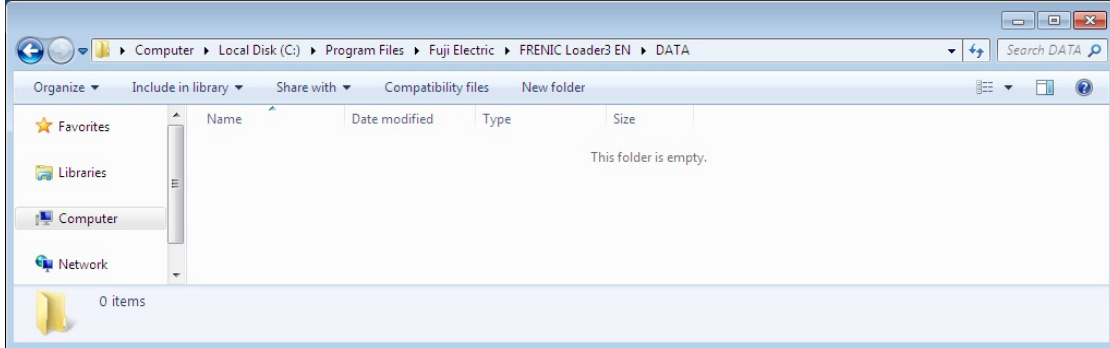

To find saved files, select **File | Open** and access the DATA file.

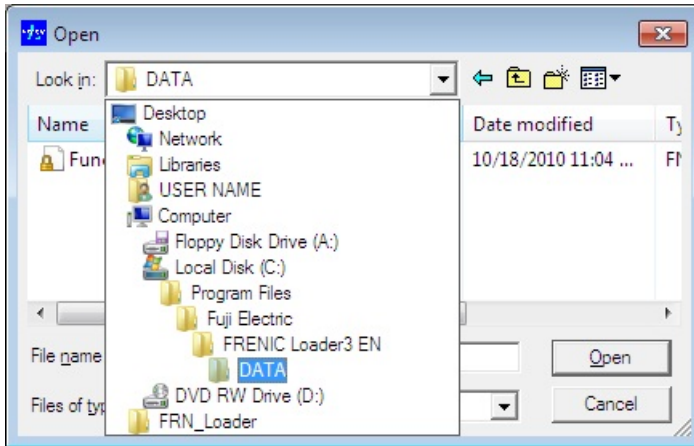

Saved files are stored in the following directory.

Computer\Local disk (C:)\Users(Log-in name)\AppData\Local\VirtualStore\Program Files\Fuji Electric\FRENIC Loader3 EN\DATA

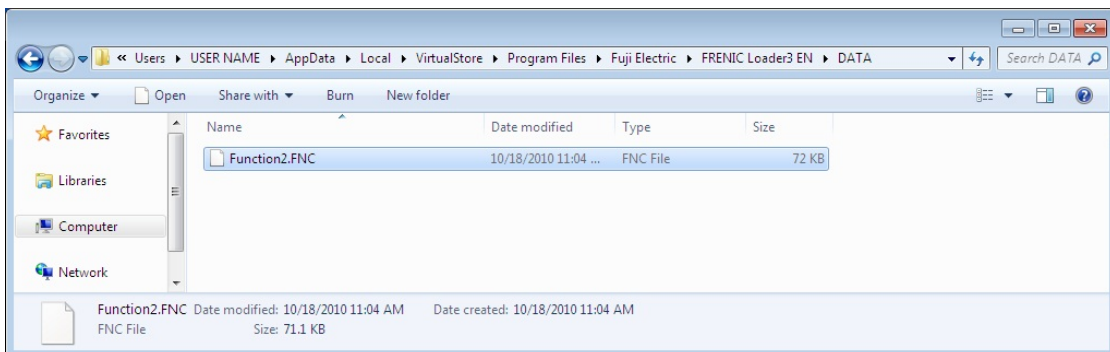

**Note:** The \AppData is usually hidden. To show it, refer to Section 3.1.1.4 "Notes on updating Loader," Showing the hidden \AppData folder.

### 3.2.5 Notes on updating Loader

To update Loader from old version to new version in Windows 7/Windows Vista, follow the procedure given below.

- (1) Uninstall the old version.
- (2) Delete the folder in the following directory.

Computer\Local disk (C:)\Users(Log-in name)\AppData\Local\VirtualStore\Program Files\Fuji Electric\FRENIC Loader3 EN\DATA

To show the AppData folder usually hidden, refer to Showing the hidden \AppData folder below.

- (3) Install a new version.

#### **Showing the hidden \AppData folder**

Show the hidden \AppData folder using the following procedure.

- 1) Open **Control Panel** and click **Appearance and Personalization**.

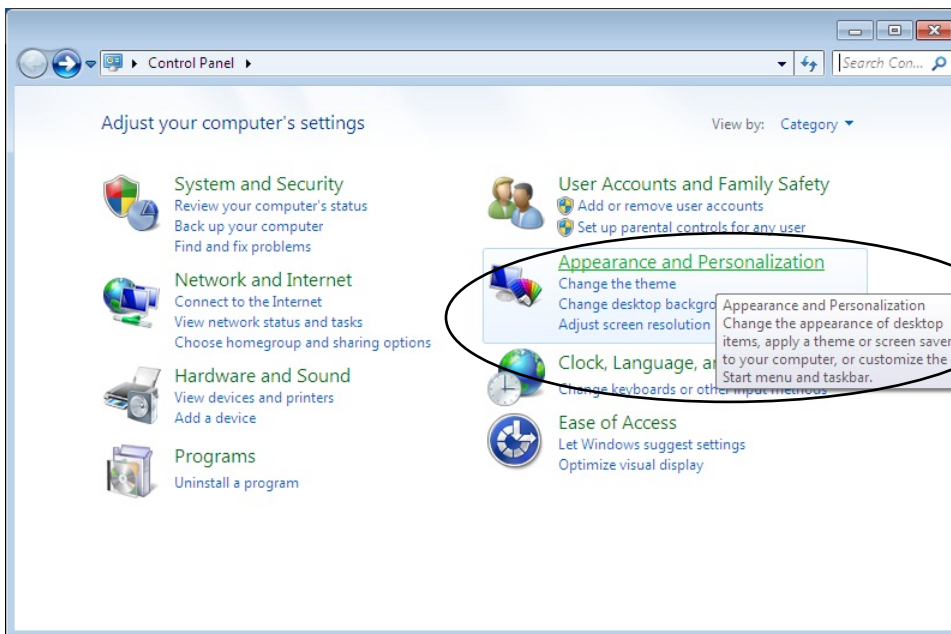

- 2) Click **Folder Options**.

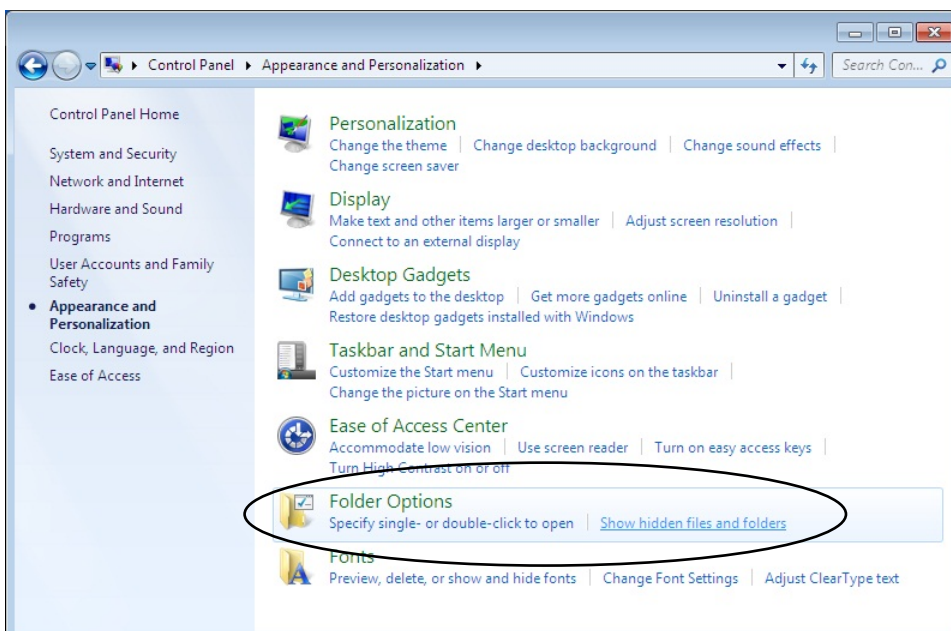

- 3) Select **View** | **Advanced settings** | **Hidden files and folders** | **Show hidden files, folder, and drives**, then click **OK**.

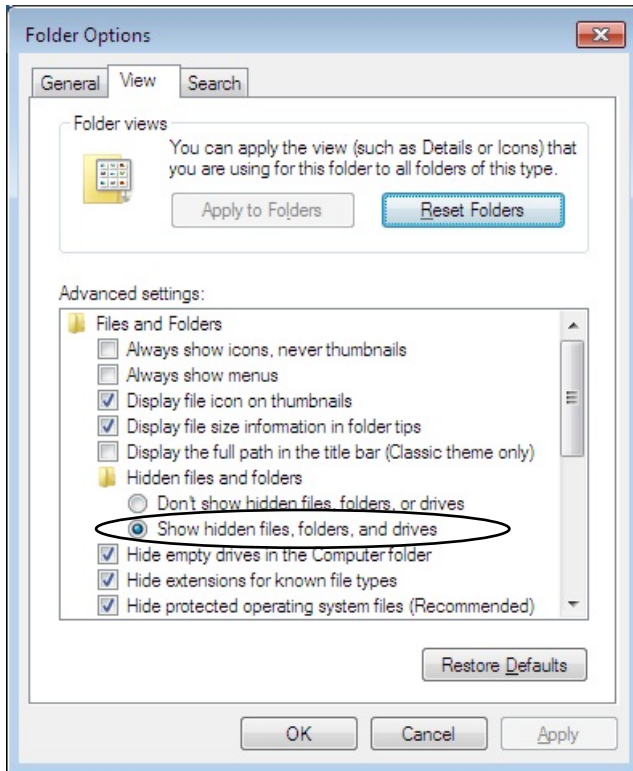

- 4) Delete the folder that is shown in the following directory.

Computer\Local disk (C:)\Users\<Log-in name>\AppData\Local\VirtualStore\Program Files\Fuji Electric\FRENIC Loader3 EN\DATA

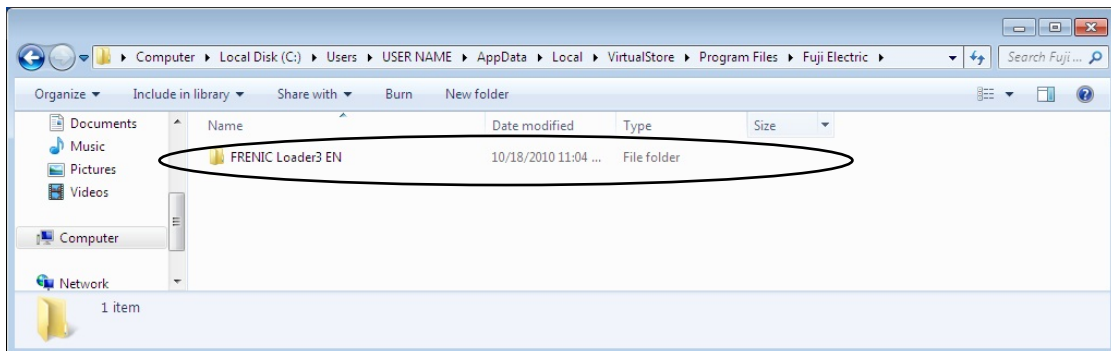

### 3.3 Specifications of FRENIC Loader 3.x

Listed below are the standard specifications of FRENIC Loader 3.x.

Item	Specifications	Remarks	
Name of software	FRENIC Loader 3.x		
Supported inverter	FRENIC-Mini/Eco/Multi/Ace/MEGA/HF	(See Note 1.)	
No. of supported inverters	For USB connection: Only one inverter For RS-485 connection: Up to 31 inverters		
Recommended cable	10BASE-T cable with RJ-45 connectors compliant with EIA568	For RS-485 connection	
Operating environment	CPU	Intel Pentium III 600 MHz or higher	(See Note 2.)
	OS	Microsoft Windows 2000 Microsoft Windows XP (SP2 or later) Microsoft Windows Vista Microsoft Windows 7	2000 and XP 32-bit version only.
	Memory	32 MB or more RAM	64 MB or more is recommended
	Hard disk	33.7 MB or more free space	
	COM port	RS-232C or USB	Conversion to RS-485 communications required to connect inverters
	Monitor resolution	800 × 600 or higher	XGA (1024 × 768)/16-bit color is recommended
Transmission requirements	COM port**	<b><u>COM1</u></b> to COM255	PC COM ports assigned to Loader*
	Transmission rates**	USB connection: Loader – keypad: Fixed at 12 Mbps Keypad – inverter: Fixed at 19200 bps  RS-485 connection: 38400, <b><u>19200</u></b> , 9600, 4800 and 2400 bps	19200 bps or more is recommended.
	Character length**	<b><u>8 bits</u></b>	Prefixed
	Stop bit length**	<b><u>1 bit</u></b>	Prefixed
	Parity**	<b><u>Even</u></b>	Prefixed
	No. of retries**	None or <b><u>1</u></b> to 10	No. of retry times before detecting communications error
	Timeout setting**	(100 ms, 300 ms, 500 ms), (1.0 s to <b><u>1.5 s</u></b> to 1.9 s, 2.0 to 9.0 s) or (10.0 to 60.0 s)	This setting should be longer than the response interval time specified by the function code y09.

**Bolded, underlined** values are factory defaults.

(Note 1) FRENIC Loader cannot be used with inverters that do not support SX protocol (Loader protocol).

With special order-made inverters, FRENIC Loader may not be able to display some function codes normally.

(Note 2) Use a PC with as high a performance as possible since some slower PCs may not refresh the **Operation Status Monitor** window and **Test run** window correctly.



**Inverter Support Software**  
**FRENIC Loader 3.3**

---

**Instruction Manual**

First Edition, October 2010

Fifth Edition, April 2014

Fuji Electric Co., Ltd.

---

The purpose of this manual is to provide an operation guide to FRENIC Loader for the FRENIC series of inverters. Please feel free to send your comments regarding any errors or omissions you may have found, or any suggestions you may have for generally improving the manual.

In no event will Fuji Electric Co., Ltd. be liable for any direct or indirect damage resulting from the application of the information in this manual.