

# Operating Instructions

## **Deltapilot S FMB70**

### Hydrostatic Level Measurement

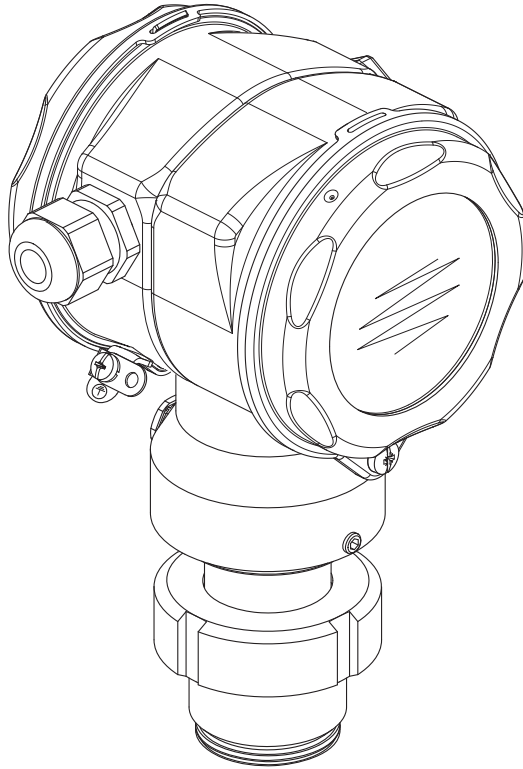

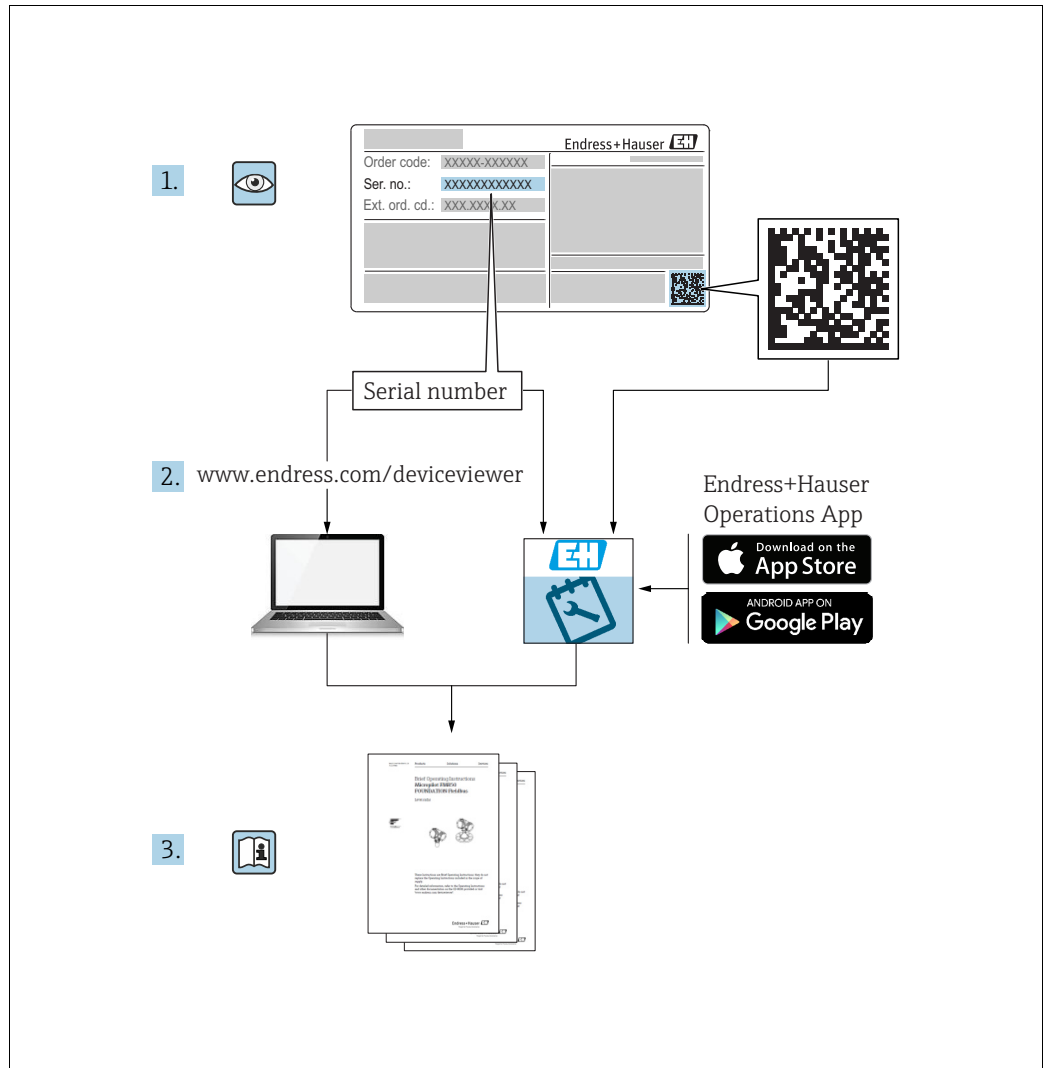

A0023555

Make sure the document is stored in a safe place such that it is always available when working on or with the device.

To avoid danger to individuals or the facility, read the "Basic safety instructions" section carefully, as well as all other safety instructions in the document that are specific to working procedures.

The manufacturer reserves the right to modify technical data without prior notice. Your Endress+Hauser Sales Center will supply you with current information and updates to these Instructions.

## Table of contents

<b>1</b>	<b>Document information</b>	<b>4</b>	7.6	Level measurement	55
1.1	Document function	4	7.7	Pressure measurement	59
1.2	Symbols used	4	7.8	Scaling the OUT parameter	61
1.3	Registered trademarks	5	7.9	Configuring event behavior in accordance with FOUNDATION Fieldbus Specification FF912 Field Diagnostic Profile	62
1.4	Terms and abbreviations	6			
1.5	Turn down calculation	7			
<b>2</b>	<b>Basic safety instructions</b>	<b>8</b>	<b>8</b>	<b>Maintenance</b>	<b>73</b>
2.1	Requirements concerning the staff	8	8.1	Exterior cleaning	73
2.2	Designated use	8			
2.3	Workplace safety	8	<b>9</b>	<b>Diagnostics and troubleshooting</b>	<b>74</b>
2.4	Operational safety	8	9.1	Troubleshooting	74
2.5	Hazardous area	9	9.2	Diagnostic information on local display	75
2.6	Product safety	9	9.3	Diagnostic event in the operating tool	76
<b>3</b>	<b>Identification</b>	<b>10</b>	9.4	Diagnostic messages in the DIAGNOSTIC Transducer Block (TRDDIAG)	77
3.1	Product identification	10	9.5	Overview of diagnostic events	80
3.2	Device designation	10	9.6	Response of outputs to errors	90
3.3	Scope of delivery	12	9.7	Confirming messages	91
3.4	CE mark, Declaration of Conformity	12	9.8	Repair	92
<b>4</b>	<b>Installation</b>	<b>13</b>	9.9	Repair of Ex-certified devices	92
4.1	Incoming acceptance and storage	13	9.10	Spare Parts	92
4.2	Installation conditions	13	9.11	Return	92
4.3	General installation instructions	13	9.12	Disposal	92
4.4	Installation instructions	13	9.13	Software history	93
4.5	Post-installation check	19	<b>10</b>	<b>Technical data</b>	<b>94</b>
<b>5</b>	<b>Wiring</b>	<b>20</b>		<b>Index</b>	<b>95</b>
5.1	Connecting the device	20			
5.2	Connecting the measuring unit	21			
5.3	Overvoltage protection (optional)	22			
5.4	Post-connection check	22			
<b>6</b>	<b>Operation</b>	<b>23</b>			
6.1	Onsite display (optional)	23			
6.2	Operating elements	25			
6.3	FOUNDATION Fieldbus interface	28			
6.4	Local operation – onsite display connected	40			
6.5	FieldCare	43			
6.6	HistoROM®/M-DAT (optional)	43			
6.7	Locking/unlocking operation	46			
6.8	Simulation	47			
6.9	Factory setting (reset)	47			
<b>7</b>	<b>Commissioning</b>	<b>50</b>			
7.1	Configuring messages	50			
7.2	Function check	50			
7.3	Commissioning via an FF configuration program	50			
7.4	Selecting the language and measuring mode	52			
7.5	Position adjustment	54			





# 1 Document information

## 1.1 Document function







These Operating Instructions contain all the information that is required in various phases of the life cycle of the device: from product identification, incoming acceptance and storage, to mounting, connection, operation and commissioning through to troubleshooting, maintenance and disposal.

## 1.2 Symbols used



### 1.2.1 Safety symbols

Symbol	Meaning
 A0011189-DE	<b>DANGER!</b> This symbol alerts you to a dangerous situation. Failure to avoid this situation will result in serious or fatal injury.
 A0011190-DE	<b>WARNING!</b> This symbol alerts you to a dangerous situation. Failure to avoid this situation can result in serious or fatal injury.
 A0011191-DE	<b>CAUTION!</b> This symbol alerts you to a dangerous situation. Failure to avoid this situation can result in minor or medium injury.
 A0011192-DE	<b>NOTICE!</b> This symbol contains information on procedures and other facts which do not result in personal injury.









### 1.2.2 Electrical symbols

Symbol	Meaning	Symbol	Meaning
	Direct current		Alternating current
	Direct current and alternating current		<b>Ground connection</b> A grounded terminal which, as far as the operator is concerned, is grounded via a grounding system.
	<b>Protective ground connection</b> A terminal which must be connected to ground prior to establishing any other connections.		<b>Equipotential connection</b> A connection that has to be connected to the plant grounding system: This may be a potential equalization line or a star grounding system depending on national or company codes of practice.

### 1.2.3 Tool symbols

Symbol	Meaning
 A0011221	Allen key
 A0011222	Hexagon wrench

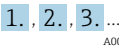
### 1.2.4 Symbols for certain types of information

Symbol	Meaning
 A0011182	<b>Permitted</b> Indicates procedures, processes or actions that are permitted.
 A0011184	<b>Forbidden</b> Indicates procedures, processes or actions that are forbidden.
 A0011193	<b>Tip</b> Indicates additional information.
 A0028658	Reference to documentation
 A0028659	Reference to page
 A0028660	Reference to graphic
 A0031595	Series of steps
 A0018343	Result of a sequence of actions
 A0028673	Visual inspection

### 1.2.5 Symbols in graphics

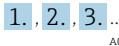
Symbol	Meaning
1, 2, 3, 4, ...	Item numbers
 A0031595	Series of steps
A, B, C, D, ...	Views

### 1.2.6 Symbols at the device

Symbol	Meaning
 A0019159	<b>Safety instructions</b> Observe the safety instructions contained in the associated Operating Instructions.

## 1.3 Registered trademarks

KALREZ, VITON, TEFLON  
Registered trademarks of E.I. Du Pont de Nemours & Co., Wilmington, USA

TRI-CLAMP  
Registered trademark of Ladish & Co., Inc., Kenosha, USA

FOUNDATION™ Fieldbus  
Registered trademark of the FieldComm Group, Austin, USA

GORE-TEX®  
Registered trademarks of W.L. Gore & Associates, Inc., USA

## 1.4 Terms and abbreviations

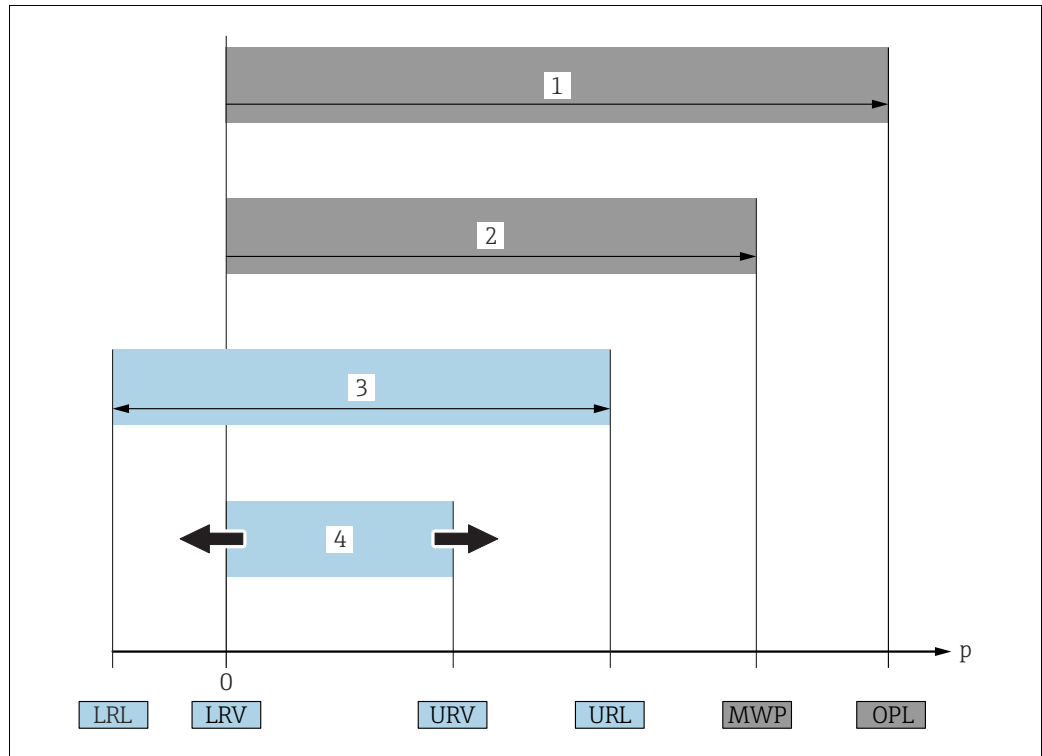

A0029505

Position	Term/Abbreviation	Explanation
1	OPL	The OPL (over pressure limit = sensor overload limit) for the sensors depends on the lowest-rated element, with regard to pressure, of the selected components, i.e. the process connection must be taken into consideration in addition to the measuring cell. Also observe pressure-temperature dependency. For the relevant standards and additional notes, see technical information. The OPL may be applied for a limited time period.
2	MWP	The MWP (maximum working pressure) for the sensors depends on the lowest-rated element, with regard to pressure, of the selected components, i.e. the process connection has to be taken into consideration in addition to the measuring cell. Also observe pressure-temperature dependency. For the relevant standards and additional notes, see technical information. The MWP may be applied for an unlimited time.
3	Maximum sensor measuring range	Range between LRL and URL This span is the maximum calibratable/adjustable measuring span.
4	Calibrated/Adjusted measuring span	Range between LRV and URV Factory setting: 0...URL Other calibrated spans can be ordered with customised settings.
p	-	Pressure
-	LRL	Lower range limit
-	URL	Upper range limit
-	LRV	Lower range value
-	URV	Upper range value
-	TD	Turn down

## 1.5 Turn down calculation

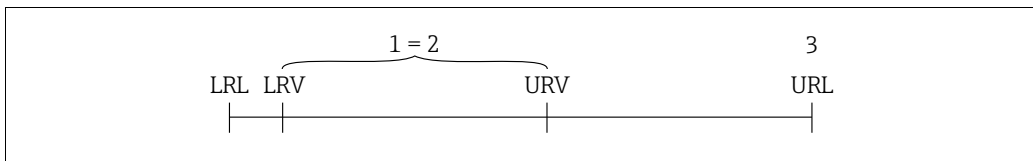

Fig. 1:

- 1 Calibrated/Adjusted measuring span
- 2 Zero-based span
- 3 Upper range limit

**Example**

- Sensor: 10 bar (150 psi)
- Upper range limit (URL) = 10 bar (150 psi)
- Lower range value (LRV) = 0 bar
- Upper range value (URV) = 5 bar (75 psi)
- Calibrated/Adjusted measuring span: 0...5 bar (0...75 psi)
- Lower range value (LRV) = 0 bar
- Upper range value (URV) = 5 bar (75 psi)

Turn down (TD):

$$TD = \frac{URL}{|URV - LRV|}$$

$$TD = \frac{10 \text{ bar (150 psi)}}{|5 \text{ bar (75 psi)} - 0 \text{ bar (0 psi)}|} = 2$$

In this example, the TD is thus 2:1.  
This span is based on the zero point.

## 2 Basic safety instructions

### 2.1 Requirements concerning the staff

The personnel for installation, commissioning, diagnostics and maintenance must fulfill the following requirements:

- Trained, qualified specialists: must have a relevant qualification for this specific function and task
- Are authorized by the plant owner/operator
- Are familiar with federal/national regulations
- Before beginning work, the specialist staff must have read and understood the instructions in the Operating Instructions and supplementary documentation as well as in the certificates (depending on the application)
- Following instructions and basic conditions

The operating personnel must fulfill the following requirements:

- Being instructed and authorized according to the requirements of the task by the facility's owner-operator
- Following the instructions in these Operating Instructions

### 2.2 Designated use

The Deltapilot S is a hydrostatic pressure transmitter for measuring level and pressure.

#### 2.2.1 Incorrect use

The manufacturer is not liable for damage caused by improper or non-designated use.

Verification for borderline cases:

For special fluids and fluids for cleaning, Endress+Hauser is glad to provide assistance in verifying the corrosion resistance of fluid-wetted materials, but does not accept any warranty or liability.

### 2.3 Workplace safety

For work on and with the device:

- Wear the required personal protective equipment according to federal/national regulations.
- Switch off the supply voltage before connecting the device.

### 2.4 Operational safety

Risk of injury!

- ▶ Operate the device in proper technical condition and fail-safe condition only.
- ▶ The operator is responsible for interference-free operation of the device.

#### Conversions to the device

Unauthorized modifications to the device are not permitted and can lead to unforeseeable dangers:

- ▶ If, despite this, modifications are required, consult with Endress+Hauser.

#### Repair

To ensure continued operational safety and reliability,

- ▶ Carry out repairs on the device only if they are expressly permitted.
- ▶ Observe federal/national regulations pertaining to repair of an electrical device.
- ▶ Use original spare parts and accessories from Endress+Hauser only.



## 2.5 Hazardous area

To eliminate a danger for persons or for the facility when the device is used in the hazardous area (e.g. explosion protection, pressure vessel safety):

- Based on the nameplate, check whether the ordered device is permitted for the intended use in the hazardous area.
- Observe the specifications in the separate supplementary documentation that is an integral part of these Instructions.

## 2.6 Product safety

This measuring device is designed in accordance with good engineering practice to meet state-of-the-art safety requirements, has been tested, and left the factory in a condition in which they are safe to operate. It fulfills general safety requirements and legal requirements. It also conforms to the EC directives listed in the device-specific EC declaration of conformity. Endress+Hauser confirms this fact by applying the CE mark.

## 3 Identification

### 3.1 Product identification

The following options are available for identification of the measuring device:

- Nameplate specifications
- Order code with breakdown of the device features on the delivery note
- Enter serial numbers from nameplates in W@M Device Viewer ([www.endress.com/deviceviewer](http://www.endress.com/deviceviewer)): All information about the measuring device is displayed.

For an overview of the technical documentation provided, enter the serial number from the nameplates in the W@M Device Viewer ([www.endress.com/deviceviewer](http://www.endress.com/deviceviewer)).

### 3.2 Device designation

#### 3.2.1 Nameplates

- The MWP (maximum working pressure) is specified on the nameplate. This value refers to a reference temperature of +20 °C (68°F) and may be applied to the device for an unlimited time. Observe temperature dependency of the MWP. The pressure values permitted at higher temperatures can be found in the standards EN 1092-1: 2001 Tab. 18 (With regard to their stability-temperature property, the materials 1.4435 and 1.4404 are grouped together under 13EO in EN 1092-1 Tab. 18. The chemical composition of the two materials can be identical.), ASME B 16.5a – 1998 Tab. 2-2.2 F316, ASME B 16.5a – 1998 Tab. 2.3.8 N10276, JIS B 2220.
- The test pressure corresponds to the over pressure limit (OPL) of the device = MWP x 1.5.
- The Pressure Equipment Directive (2014/68/EU) uses the abbreviation "PS". The abbreviation "PS" corresponds to the MWP (maximum working pressure) of the measuring device.

#### Aluminum housing (T14/T15)

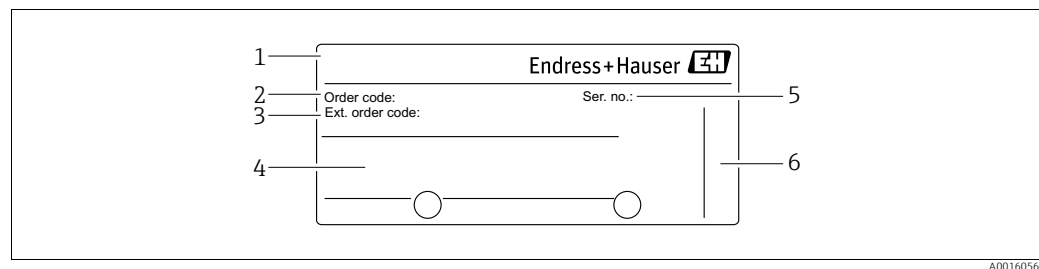
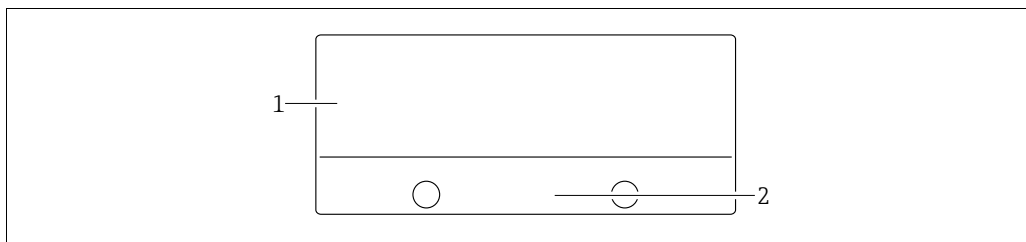

Fig. 2: Nameplate

- |   |                                    |
|---|------------------------------------|
| 1 | Device name                        |
| 2 | Order code (for re-orders)         |
| 3 | Extended order code (complete)     |
| 4 | Technical data                     |
| 5 | Serial number (for identification) |
| 6 | Address of manufacturer            |

Devices for use in hazardous areas are fitted with an additional nameplate.



A0021222

Fig. 3: Additional nameplate

- 1 Approval-specific information
- 2 Document number for safety instructions or drawing number

### Hygienic stainless steel housing (T17)

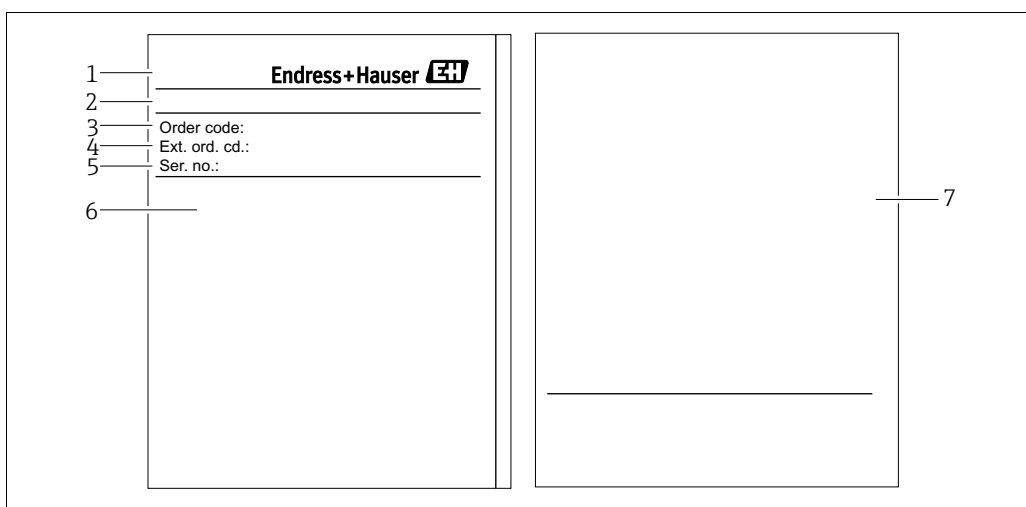

A0021552

Fig. 4: Nameplate

- 1 Device name
- 2 Address of manufacturer
- 3 Order code (for re-orders)
- 4 Extended order code (complete)
- 5 Serial number (for identification)
- 6 Technical data
- 7 Approval-specific information and document number for safety instructions or drawing number

### 3.2.2 Identifying the sensor type

See parameter "Sensor Meas.Type" in Operating Instruction BA00303P.

### 3.3 Scope of delivery

The scope of delivery comprises:

- Hydrostatic pressure sensor Deltapilot S
- For devices with the "HistoROM/M-DAT" option:  
CD-ROM with Endress+Hauser operating program
- Optional accessories

Documentation supplied:

- The Operating Instructions BA00372P and BA00303P are available via the Internet.  
→ See: [www.endress.com](http://www.endress.com) → Download.
- Brief Operating Instructions KA01026P
- Fold-out brochure KA00252P
- Final inspection report
- Additional safety instructions for Ex devices
- Optional: factory calibration form, test certificates

### 3.4 CE mark, Declaration of Conformity

The devices are designed to meet state-of-the-art safety requirements, have been tested and left the factory in a condition in which they are safe to operate. The devices comply with the applicable standards and regulations as listed in the EC Declaration of Conformity and thus comply with the statutory requirements of the EC Directives. Endress+Hauser confirms the conformity of the device by affixing to it the CE mark.

## 4 Installation

### 4.1 Incoming acceptance and storage

#### 4.1.1 Incoming acceptance

- Check the packaging and the contents for damage.
- Check the shipment, make sure nothing is missing and that the scope of supply matches your order.

#### 4.1.2 Transport

**▲ WARNING**

##### **Incorrect transportation**

Housing and diaphragm may become damaged, and there is a risk of injury!

- ▶ Transport the measuring device to the measuring point in its original packaging or by the process connection (with secure transport protection for the diaphragm).
- ▶ Follow the safety instructions and transport conditions for devices weighing more than 18 kg (39.6 lbs).

#### 4.1.3 Storage

The device must be stored in a dry, clean area and protected against impact (EN 837-2).

Storage temperature range:

- -40 to +90 °C (-40 to +194°F)
- Onsite display: -40 to +85°C (-40 to +185°F)
- Separate housing: -40 to +60°C (-40 to +140°F)

### 4.2 Installation conditions

#### 4.2.1 Dimensions

→ For dimensions, please refer to the Technical Information for Deltapilot S TI00416P, "Mechanical construction" section.

### 4.3 General installation instructions

- Devices with a G 1 1/2 thread:  
When screwing the device into the tank, the flat seal has to be positioned on the sealing surface of the process connection. To avoid additional strain on the process isolating diaphragm, the thread should never be sealed with hemp or similar materials.
- Devices with NPT threads:
  - Wrap Teflon tape around the thread to seal it.
  - Tighten the device at the hexagonal bolt only. Do not turn at the housing.
  - Do not overtighten the thread when screwing. Max. torque: 20 to 30 Nm (14.75 to 22.13 lbf ft)

### 4.4 Installation instructions

- Due to the orientation of the Deltapilot S, there may be a shift in the zero point, i.e. when the container is empty or partially full, the measured value does not display zero. You can correct this zero point shift using the "Zero" key on the electronic insert or externally on the device or via the onsite display. See →  25, Section 6.2.1 "Position of the operating

elements", → 26, Section 6.2.2 "Function of the operating elements – onsite display not connected" and → 54, Section 7.5 "Position adjustment".

- To ensure optimal readability of the onsite display, it is possible to rotate the housing up to 380°. See → 18, Section 4.4.5 "Rotating the housing".
- Endress+Hauser offers a mounting bracket for installations on pipes or walls. See → 16, Section 4.4.3 "Wall and pipe mounting (optional)".

#### 4.4.1 Installation instructions

##### NOTICE

##### Damage to the device!

If a heated Deltapilot S is cooled during the cleaning process (e.g. by cold water), a vacuum develops for a short time, whereby moisture can penetrate the sensor through the pressure compensation (1).

- ▶ If this is the case, mount the sensor with the pressure compensation (1) pointing downwards.

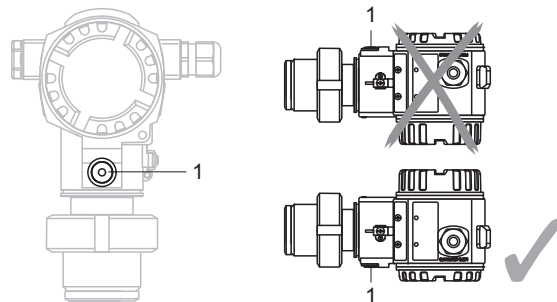

- Keep the pressure compensation and GORE-TEX® filter (1) free from contamination.
- Do not clean or touch the process isolating diaphragm with hard or pointed objects.
- The device must be installed as follows in order to comply with the cleanability requirements of the ASME-BPE (Part SD Cleanability):

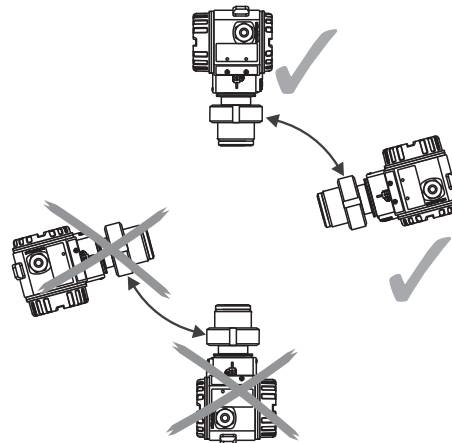

### Level measurement

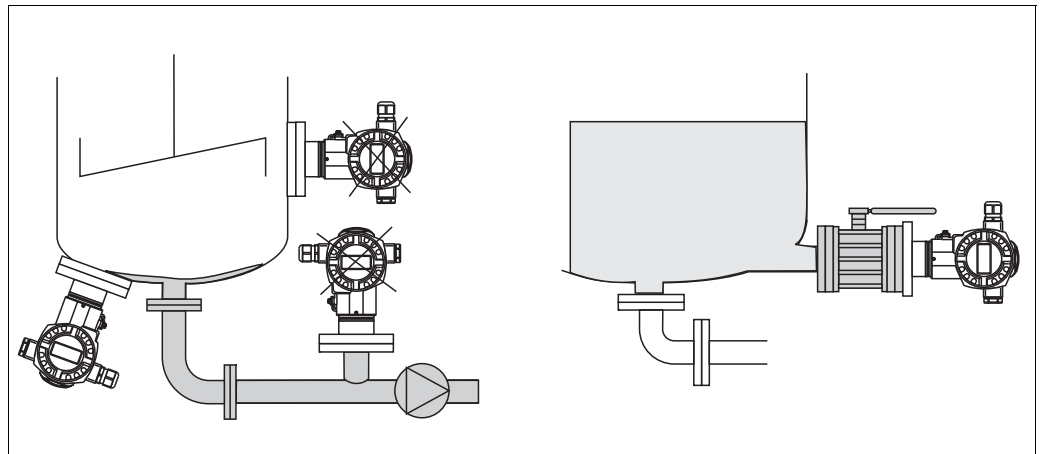

Fig. 5: Measuring arrangement for level

P01-PMP75xxx-11-xx-xx-xx-000

- Always install the device below the lowest measuring point.
- Do not install the device at the following positions:
  - in the filling curtain
  - in the tank outflow
  - in the suction area of a pump
  - or at a point in the tank that can be affected by pressure pulses from the agitator
- The calibration and functional test can be carried out more easily if you mount the device downstream of a shutoff device.
- Deltapilot S must be included in the insulation for media that can harden when cold.

### Pressure measurement in gases

- Mount Deltapilot S with shutoff device above the tapping point so that any condensate can flow into the process.

### Pressure measurement in steams

- Mount Deltapilot S with siphon above the tapping point.
- Fill the siphon with liquid before commissioning.  
The siphon reduces the temperature to almost the ambient temperature.

### Pressure measurement in liquids

- Mount Deltapilot S with the shutoff device below or at the same level as the tapping point.

### 4.4.2 Seal for flange mounting

**NOTICE**

**Corrupted measurement results.**

The seal is not allowed to press against the process isolating diaphragm as this could affect the measurement result.

- ▶ Ensure that the seal is not touching the process isolating diaphragm.

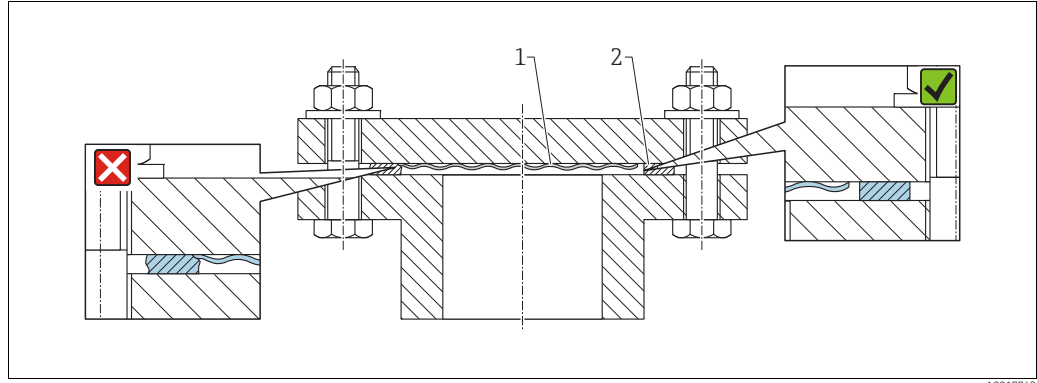
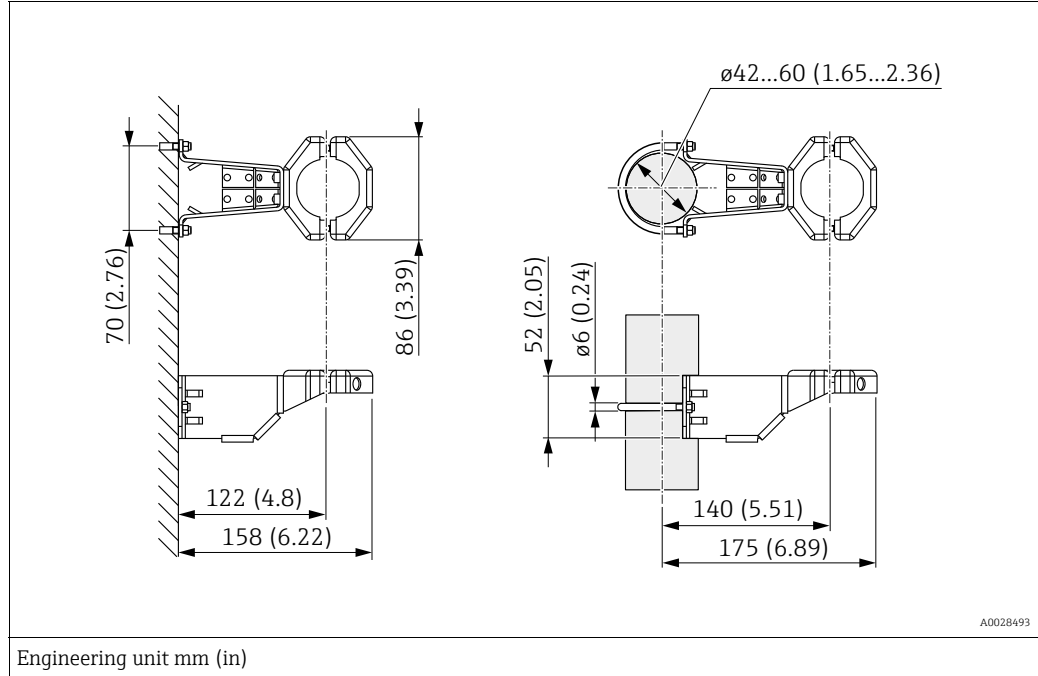

Fig. 6:  
1 Process isolating diaphragm  
2 Seal

### 4.4.3 Wall and pipe mounting (optional)

Endress+Hauser offers a mounting bracket for installation on pipes or walls (for pipe diameters from 1 ¼" to 2").



Please note the following when mounting:

- Devices with capillary tubes: mount capillaries with a bending radius  $\geq 100$  mm (3.94 in).
- When mounting on a pipe, tighten the nuts on the bracket uniformly with a torque of at least 5 Nm (3.69 lbs ft).



#### 4.4.4 Assembling and mounting the "separate housing" version

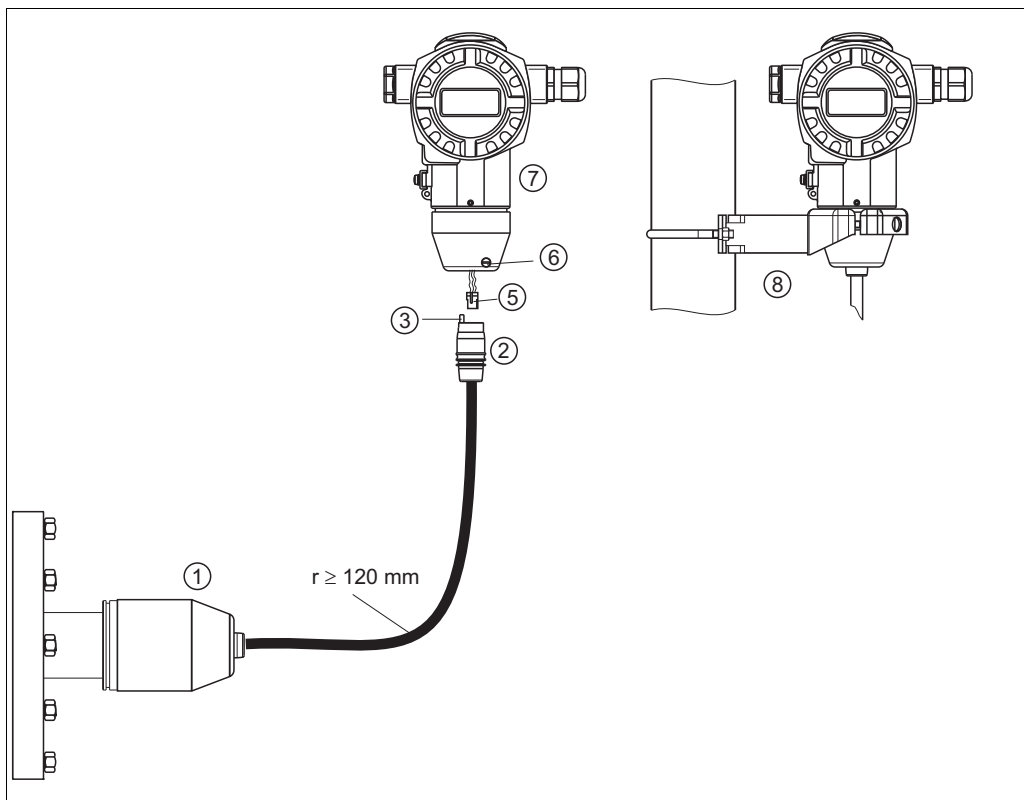

P01-FMB70xxx-11-xx-xx-xx-003

Fig. 7: "Separate housing" version

- 1 In the "separate housing" version, the sensor is supplied with the process connection and cable ready-fitted.
- 2 Cable with connection jack
- 3 Pressure compensation
- 5 Connector
- 6 Locking screw
- 7 Housing fitted with housing adapter, included
- 8 Mounting bracket suitable for wall and pipe mounting, included

#### Assembly and mounting

1. Plug the connector (item 5) into the corresponding connection jack of the cable (item 2).
2. Plug the cable into the housing adapter (item 7).
3. Tighten the locking screw (item 6).
4. Mount the housing on a wall or pipe using the mounting bracket (item 8).  
When mounting on a pipe, tighten the nuts on the bracket uniformly with a torque of at least 5 Nm (3.69 lbs ft).  
Mount the cable with a bending radius ( $r$ )  $\geq$  120 mm (4.72 in).

#### 4.4.5 Rotating the housing

The housing can be rotated up to 380° by loosening the Allen screw.

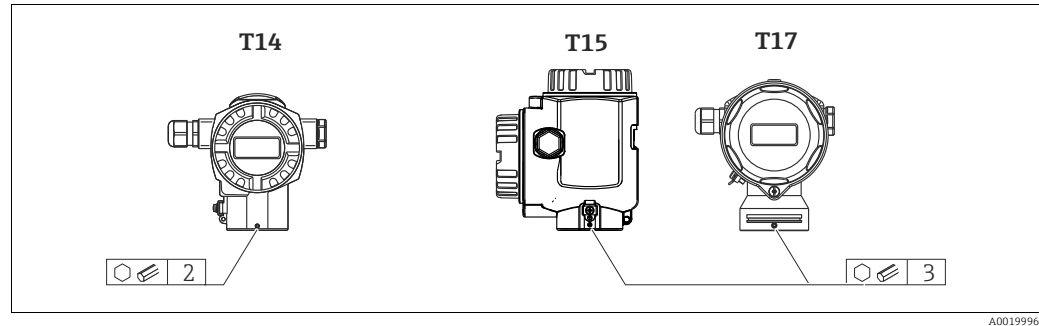

1. T14 housing: Loosen setscrew with a 2 mm (0.08 in) Allen key.  
T15 and T17 housing: Loosen setscrew with a 3 mm (0.12 in) Allen key.
2. Rotate housing (max. up to 380°).
3. Retighten setscrew with 1 Nm (0,74 lbf ft).

#### 4.4.6 Closing the housing cover

##### NOTICE

##### Devices with EPDM cover seal - transmitter leakiness!

Mineral-based, animal-based or vegetable-based lubricants cause the EPDM cover seal to swell and the transmitter to become leaky.

- ▶ The thread is coated at the factory and therefore does not require any lubrication.

##### NOTICE

##### The housing cover can no longer be closed.

Damaged thread!

- ▶ When closing the housing cover, please ensure that the thread of the cover and housing are free from dirt, e.g. sand. If you feel any resistance when closing the cover, check the thread on both again to ensure that they are free from dirt.

##### Close cover on a hygienic stainless steel housing (T17)

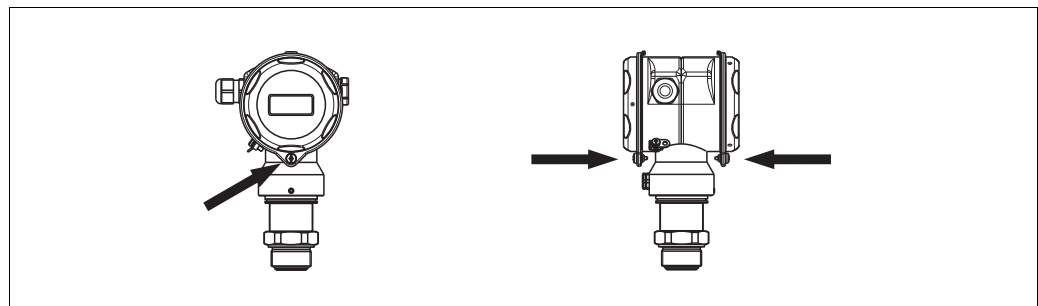

Fig. 8: Close cover

The covers for the terminal and electronics compartment are hooked into the casing and closed with a screw. These screws should be finger-tightened (2 Nm (1.48 lbf ft)) to the stop to ensure that the covers sit tightly.

#### **4.4.7 Mounting of the profile seal for universal process mounting adapter**

For details on mounting, see KA00096F/00/A3.

### **4.5 Post-installation check**

After installing the device, carry out the following checks:

- Are all screws firmly tightened?
- Are the housing covers screwed down tight?

## 5 Wiring

### 5.1 Connecting the device

#### ⚠ WARNING

##### Risk of electric shock!

If the operating voltage is  $> 35$  VDC: Dangerous contact voltage at terminals.

- In a wet environment, do not open the cover if voltage is present.

#### ⚠ WARNING

##### Limitation of electrical safety due to incorrect connection!

- Risk of electric shock and/or explosion in hazardous areas! In a wet environment, do not open the cover if voltage is present.
- When using the measuring device in hazardous areas, installation must comply with the corresponding national standards and regulations and the Safety Instructions or Installation or Control Drawings.
- Devices with integrated overvoltage protection must be grounded.
- Protective circuits against reverse polarity, HF influences and overvoltage peaks are installed.
- The supply voltage must match the power supply on the nameplate. (See also → 10, Section 3.2.1 "Nameplates".)
- Switch off the supply voltage before connecting the device.
- Remove the housing cover of the terminal compartment.
- Guide the cable through the gland. → 21, Section 5.2.4.
- Connect the device in accordance with the following diagram.
- Screw down the housing cover.
- Switch on the supply voltage.

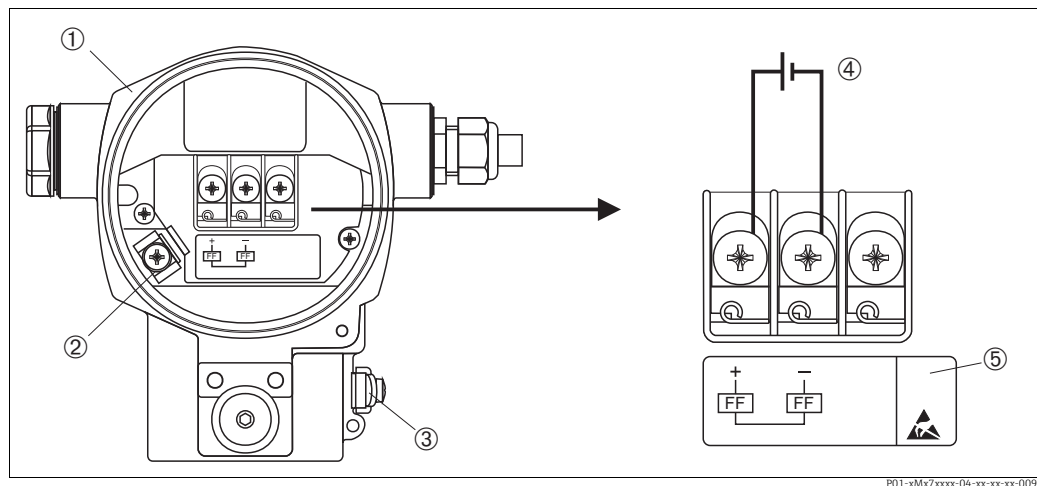
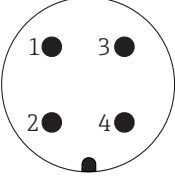

Fig. 9: Electrical connection of FOUNDATION Fieldbus  
→ Please refer also to Section 5.2.1 "Supply voltage", → 21.

- 1 Housing
- 2 Internal ground terminal
- 3 External ground terminal
- 4 Supply voltage, for version in non-hazardous area = 9 to 32 V DC
- 5 Devices with integrated overvoltage protection are labeled OVP (overvoltage protection) here.

### 5.1.1 Connecting devices with 7/8" plug

PIN assignment for 7/8" connector	PIN	Meaning
	PIN	Meaning
	1	Signal -
	2	Signal +
	3	Shield
	4	Not assigned

## 5.2 Connecting the measuring unit

For further information on the network structure and grounding and for further bus system components such as bus cables, see the relevant documentation, e.g. Operating Instructions BA00013S "FOUNDATION Fieldbus Overview" and the FOUNDATION Fieldbus Guideline.

### 5.2.1 Supply voltage

#### **▲ WARNING**

#### **Supply voltage might be connected!**

Risk of electric shock and/or explosion!

- ▶ When using the measuring device in hazardous areas, installation must comply with the corresponding national standards and regulations and the Safety Instructions or Installation or Control Drawings.
- ▶ All explosion protection data are given in separate documentation which is available upon request. The Ex documentation is supplied as standard with all devices approved for use in explosion hazardous areas.

Version for non-hazardous area: 9 to 32 V DC

### 5.2.2 Current consumption

15.5 mA ±1 mA, switch-on current corresponds to IEC 61158-2, Clause 21.

### 5.2.3 Terminals

- Supply voltage and internal ground terminal: 0.5 to 2.5 mm<sup>2</sup> (20 to 14 AWG)
- External ground terminal: 0.5 to 4 mm<sup>2</sup> (20 to 12 AWG)

### 5.2.4 Cable specification

- Use a twisted, shielded two-wire cable, preferably cable type A.
- Outer cable diameter: 5 to 9 mm (0.2 to 0.35 in)

For further information on the cable specifications, see Operating Instructions BA00013S "FOUNDATION Fieldbus Overview", FOUNDATION Fieldbus Guideline and IEC 61158-2 (MBP).

### 5.2.5 Grounding and shielding

Deltapilot S must be grounded, for example by means of the external ground terminal.

Different grounding and shielding installation methods are available for FOUNDATION Fieldbus networks such as:

- Isolated installation (see also IEC 61158-2)
- Installation with multiple grounding

- Capacitive installation

### 5.3 Overvoltage protection (optional)

#### **NOTICE**

#### **Device could be destroyed!**

Devices with integrated overvoltage protection must be earthed.

Devices showing version "M" in feature 100 "Additional options 1" or feature 110 "Additional options 2" in the order code are equipped with overvoltage protection (→ see also Technical Information TI00416P "Ordering information").

- Overvoltage protection:
  - Nominal functioning DC voltage: 600 V
  - Nominal discharge current: 10 kA
- Surge current check  $\hat{i} = 20$  kA as per DIN EN 60079-14: 8/20  $\mu$ s satisfied
- Arrester AC current check  $I = 10$  A satisfied

### 5.4 Post-connection check

Perform the following checks after completing electrical installation of the device:

- Does the supply voltage match the specifications on the nameplate?
- Is the device connected as per Section 5.1?
- Are all screws firmly tightened?
- Are the housing covers screwed down tight?

As soon as voltage is applied to the device, the green LED on the electronic insert lights up for a few seconds or the connected onsite display lights up.

## 6 Operation

Feature 20 "Output; operation" in the order code provides you with information on the operating options available to you.

Versions in the order code		Operation
P	FOUNDATION Fieldbus; external operation, LCD	Via onsite display and 1 key on the exterior of the device
Q	FOUNDATION Fieldbus; internal operation, LCD	Via onsite display and 1 key on the inside of the device
R	FOUNDATION Fieldbus; internal operation	Without onsite display, 1 key on the inside of the device

### 6.1 Onsite display (optional)

A 4-line liquid crystal display (LCD) is used for display and operation. The onsite display shows measured values, fault messages and notice messages.

The display of the device can be turned in 90° steps.

Depending on the orientation of the device, this makes it easy to operate the device and read the measured value.

Functions:

- 8-digit measured value display including sign and decimal point, unit display
- Bar graph as graphic display of the current pressure measured value in relation to the set pressure range in the Pressure Transducer Block. The pressure range is set by means of the SCALE\_IN parameter.
- Easy and complete menu guidance by dividing the parameters into several levels and groups
- Menu guidance
 

The onsite display is available in English. Needless to say, the device can also be operated in 6 languages (de, en, fr, es, jp, ch) via the DTM or EDD. The FieldCare program is an E+H DTM operating tool and can be acquired from [endress.com](http://endress.com).
- Each parameter has a 3-digit ID to aid navigation
- Option of configuring the display according to individual requirements and preferences, such as language, alternating display, contrast setting, display of other measured values such as sensor temperature
- Comprehensive diagnostic functions (fault and warning message, maximum indicator, etc.)
- Rapid and safe commissioning using Quick Setup menus

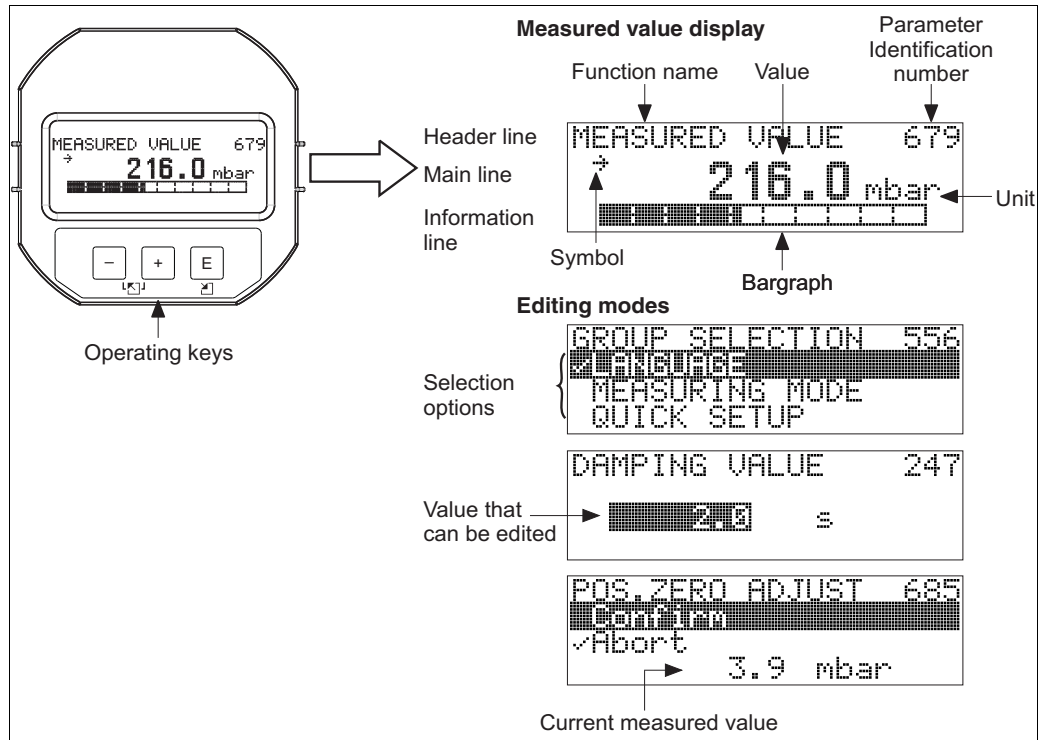

P01-xxxxxxx-07-zz-zz-en-011

The following table illustrates the symbols that can appear on the onsite display. Four symbols can occur at one time.

Symbol	Meaning
	<b>Alarm symbol</b> - Symbol flashing: warning, device continues measuring. - Symbol permanently lit: error, device does not continue measuring. <i>Note:</i> The alarm symbol may overlie the tendency symbol.
	<b>Lock symbol</b> The operation of the device is locked. Unlock device, → 46, Section 6.7 "Locking/unlocking operation".
	<b>Communication symbol</b> Data transfer via communication
	<b>Simulation symbol</b> Simulation mode is activated. DIP switch 2 for simulation is set to "On". See also Section 6.2.1 "Position of the operating elements" and → 47, Section 6.8 "Simulation"
	<b>Tendency symbol (increasing)</b> The primary value of the Pressure Transducer Block is increasing.
	<b>Tendency symbol (decreasing)</b> The primary value of the Pressure Transducer Block is decreasing.
	<b>Tendency symbol (constant)</b> The primary value of the Pressure Transducer Block has remained constant over the past few minutes.



## 6.2 Operating elements

### 6.2.1 Position of the operating elements

On the aluminum housing (T14/T15), the operating key is located either under the protective flap on the exterior of the device or inside on the electronic insert. In the case of the hygienic stainless steel housing (T17), the operating key is always inside on the electronic insert. In addition, there are three operating keys on the optional onsite display.

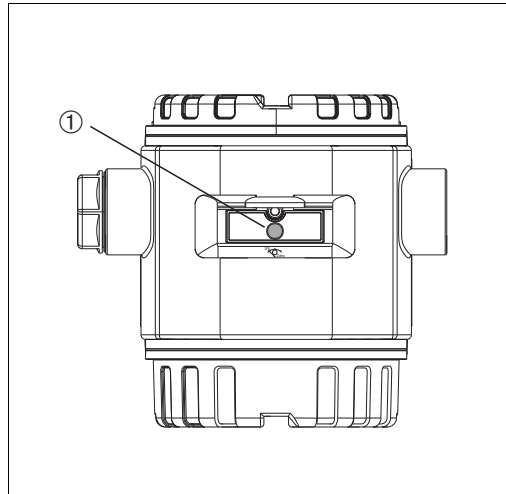

Fig. 10: External operating key, under the protective flap

- 1 Operating key for position adjustment (zero point correction) and total reset

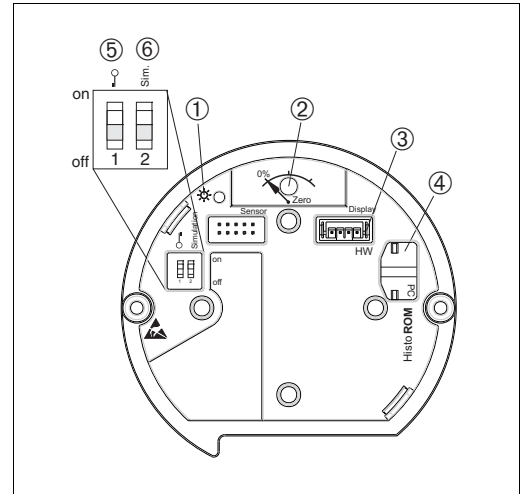
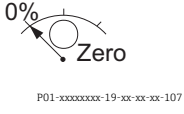
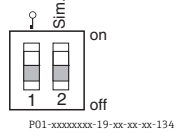

Fig. 11: Operating key and operating elements, internal

- 1 Green LED to indicate value is accepted
- 2 Operating key for position adjustment (zero point correction) and total reset
- 3 Slot for optional display
- 4 Slot for optional HistoROM®/M-DAT
- 5 DIP switch for locking/unlocking parameters relevant to the measured value
- 6 DIP switch for simulation mode

## 6.2.2 Function of the operating elements – onsite display not connected

Operating elements	Meaning
	<ul style="list-style-type: none"> <li>- Position adjustment (zero point correction): press key for at least 3 seconds. The LED on the electronic insert lights up briefly if the pressure applied has been accepted for position adjustment. → See also the following section "Performing position adjustment on site".</li> <li>- Total reset: press key for at least 12 seconds. The LED on the electronic insert lights up briefly if a reset is being carried out.</li> </ul>
	<ul style="list-style-type: none"> <li>- DIP switch 1: for locking/unlocking parameters relevant to the measured value. Factory setting: off (unlocked) See also → 46, Section 6.7 "Locking/unlocking operation".</li> <li>- DIP switch 2: for simulation mode Factory setting: off (simulation mode off) → See also → 47, Section 6.8 "Simulation"</li> </ul>











### Performing position adjustment on site

- Operation must be unlocked. See → 46, Section 6.7 "Locking/unlocking operation".
- The device is configured for the MEASURING MODE → level and LEVEL SELECTION → level easy pressure as standard.
  - Operation via FF configuration program: In the Pressure Transducer Block, change the measuring mode by means of the PRIMARY\_VALUE\_TYPE and LINEARIZATION parameters.
  - Operation via digital communication: change the measuring mode by means of the MEASURING MODE parameter.
  - You can change the measuring mode by means of the MEASURING MODE parameter. See → 52, Section 7.4 "Selecting the language and measuring mode".
- The pressure applied must be within the nominal pressure limits of the sensor. See information on the nameplate.

Perform position adjustment:

1. Pressure is present at device.
2. Press key for at least 3 seconds.
3. If the LED on the electronic insert lights up briefly, the pressure applied has been accepted for position adjustment.  
If the LED does not light up, the pressure applied was not accepted. Observe the input limits. For error messages see → 75, Section 9.2 "Diagnostic information on local display".

### 6.2.3 Function of the operating elements – onsite display connected

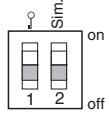
Key(s)	Meaning
	<ul style="list-style-type: none"> <li>– Navigate upwards in the picklist</li> <li>– Edit numerical values or characters within a function</li> </ul>
	<ul style="list-style-type: none"> <li>– Navigate downwards in the picklist</li> <li>– Edit numerical values or characters within a function</li> </ul>
	<ul style="list-style-type: none"> <li>– Confirm entry</li> <li>– Go to next item</li> </ul>
 and 	Contrast setting of onsite display: increase
 and 	Contrast setting of onsite display: reduce
 and 	<p>ESC functions:</p> <ul style="list-style-type: none"> <li>– Exit the editing mode without saving the altered value</li> <li>– You are in the menu within a function group: the first time you press the keys simultaneously, you go back one parameter in the function group. Every subsequent time you press the keys simultaneously, you go up one level in the menu.</li> <li>– You are in the menu on a selection level: every time you press the keys simultaneously, you go up one level in the menu.</li> </ul> <p><i>Note:</i> For the terms function group, level, selection level, →  40, Section 6.4.1</p>
 <p>P01-xxxxxxx-19-xx-xx-xx-134</p>	<ul style="list-style-type: none"> <li>– DIP switch 1: for locking/unlocking parameters relevant to the measured value. Factory setting: off (unlocked)</li> <li>– DIP switch 2: for the simulation mode. Factory setting: off (simulation mode off)</li> </ul>

## 6.3 FOUNDATION Fieldbus interface

### 6.3.1 System architecture

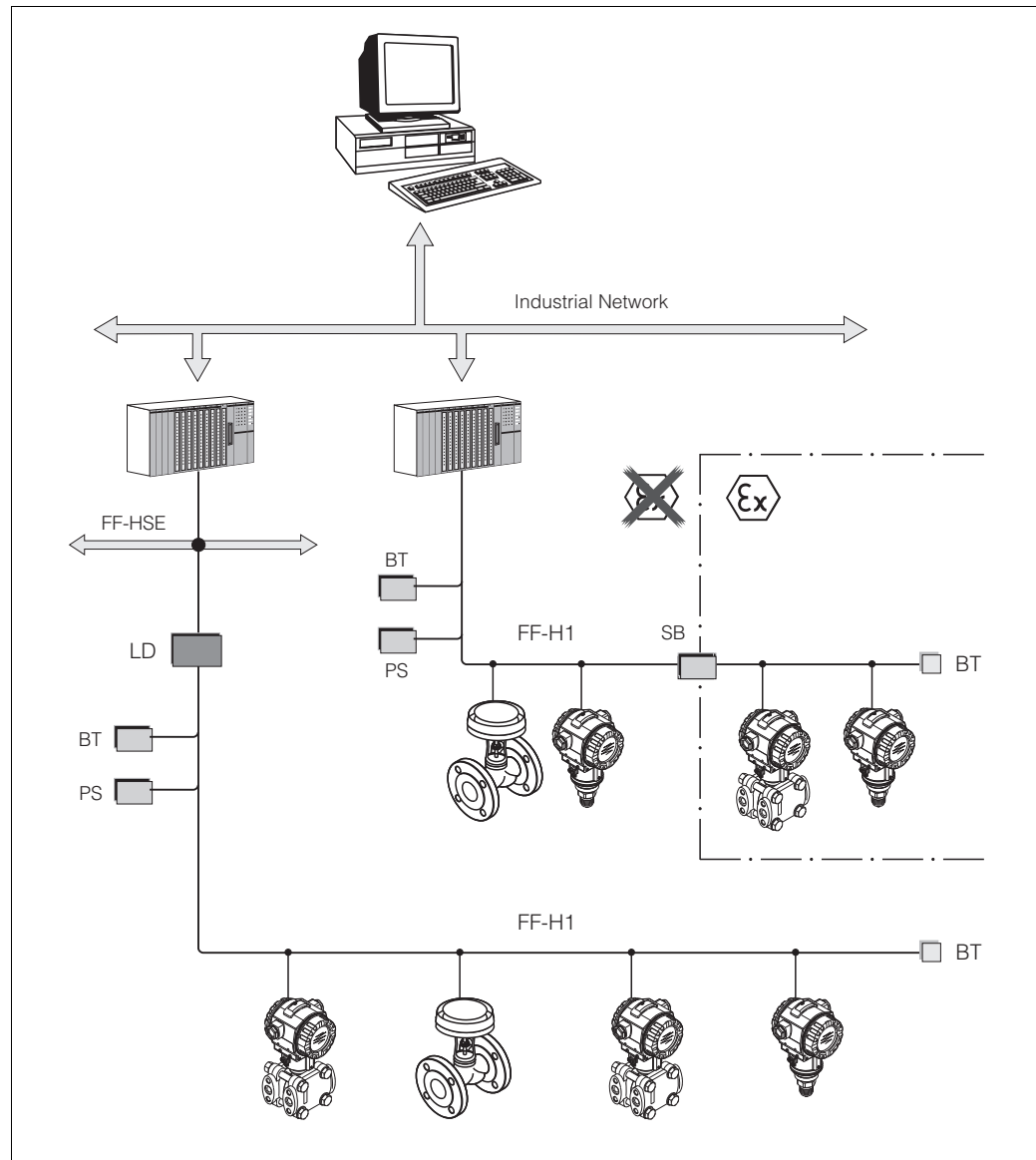

Fig. 12: FOUNDATION Fieldbus system architecture with associated components

FF-HSE: High Speed Ethernet, FF-H1: FOUNDATION Fieldbus-H1, LD: Linking Device FF-HSE/FF-H1, PS: bus power supply unit, SB: safety barrier, BT: bus terminator

The system can be connected in the following ways:

- A linking device makes the connection to higher-order fieldbus levels (e.g. High Speed Ethernet (HSE)) possible.
- An FF-H1 connecting card is needed for direct connection to a process control system.

Further information on FOUNDATION Fieldbus can be found in Operating Instructions BA00013S "FOUNDATION Fieldbus Overview, Installation and Commissioning Guidelines", the FOUNDATION Fieldbus Specification or on the Internet at "<http://www.fieldbus.org>".

### 6.3.2 Number of devices

- The Endress+Hauser Deltapilot S devices meet the requirements of the FISCO model.
- Due to the low current consumption, the following number of devices can be operated on one bus segment if installing to FISCO:
  - Up to 6 Deltapilot S for Ex ia, CSA and FM IS applications
  - Up to 24 Deltapilot S in all other applications, e.g. in non-hazardous areas, Ex nA etc.

The maximum number of measuring devices at one bus segment is defined by their current consumption, the performance of the bus coupler, and the required bus length.

### 6.3.3 Operation

You can obtain special configuration and operating programs from various manufacturers for the configuration, such as the FieldCare operating program from Endress+Hauser See → 43, Section 6.5 "FieldCare". These configuration programs make it possible to configure FF functions and all the device-specific parameters. The predefined function blocks allow uniform access to all the network and device data.

### 6.3.4 Network configuration

You require the following to configure a device and integrate it into an FF network:

- An FF configuration program
- The Cff file (Common File Format: \*.cff, \*.fhx)
- The device description (Device Description: \*.sym, \*.ffo, \*.sy5, \*.ff5)

Pre-defined standard DDs, which can be obtained from FOUNDATION Fieldbus, are available for the basic functions of measuring devices. You require the device-specific DD to be able to access all the functions.

The files for Deltapilot S can be acquired as follows:

- Internet Endress+Hauser: <http://www.de.endress.com> → Search for FOUNDATION Fieldbus
- Internet FOUNDATION Fieldbus: <http://www.fieldbus.org>
- On CD-ROM from Endress+Hauser, order number: 56003896

The device is integrated into the FF network as follows:

- Start the FF configuration program.
- Download the Cff and device description files (\*.ffo, \*.sym, \*.cff or \*.fhx files) to the system.
- Configure the interface, see Note.
- Configure the device for the measuring task and for the FF system.
- For more in-depth information on integrating the device into the FF system, see the description for the configuration software used.
- When integrating the field devices into the FF system, make sure you are using the right files. You can read out the required version by means of the DEV\_REV and DD\_REV parameters in the Resource Block.

### 6.3.5 Device identification and addressing

FOUNDATION Fieldbus identifies the device using its ID code and automatically assigns it a suitable field address. The identity code cannot be changed.

The device appears in the network display once you have started the FF configuration program and integrated the device into the network. The blocks available are displayed under the device name.

If the device description has not yet been loaded, the blocks report "Unknown" or "(UNK)".

Deltapilot S reports as follows:

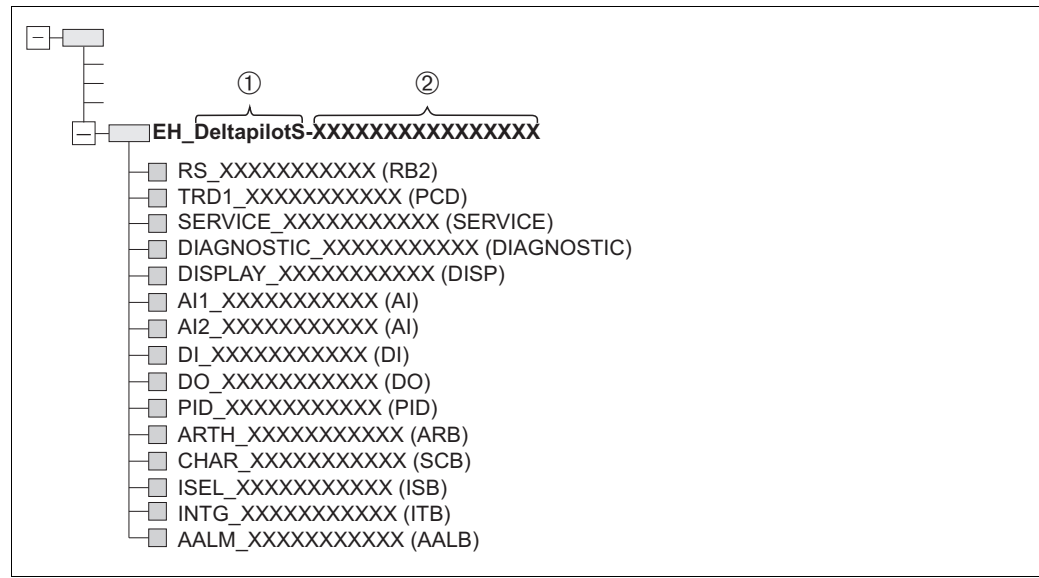

Fig. 13: Typical Deltapilot S display in a configuration program after the connection has been established.

- 1 Device name  
2 Serial number

### 6.3.6 Deltapilot S block model

With FOUNDATION Fieldbus, all the device parameters are categorized according to their functional properties and task and are generally assigned to three different blocks.

A FOUNDATION Fieldbus device has the following block types:

- A Resource Block (device block):  
This block contains all the device-specific features of the device.
- One or more Transducer Blocks  
A Transducer Block contains all the measuring and device-specific parameters of the device. The measuring principles, such as pressure or totalizers, are mapped in the Transducer Blocks.
- One or more function blocks:  
Function blocks contain the automation functions of the device. A distinction is made between different function blocks such as the Analog Input Block or Proportional Integral Differential Block (PID). Each of these function blocks is used to execute different application functions.

The function blocks can be connected by means of an FF configuration program, depending on the automation task. The device thus takes on simple control functions, thereby relieving the workload on the higher-order process control system.

Deltapilot S has the following blocks:

- Resource Block (device block)
- 4 Transducer Blocks
  - Pressure Transducer Block (TRD)
 

This Block supplies the output variables PRIMARY\_VALUE and SECONDARY\_VALUE. It contains all the parameters to configure the measuring device for the measuring task such as measuring mode selection, linearization function and unit selection.
  - Service Transducer Block
 

This Block supplies the output variables COUNTER\_P\_PMAX, PRESSURE\_1\_MAX\_RESETABLE and PRESSURE\_1\_AFTER\_DAMPING. It also includes all the counters for measuring range overshoot/undershoot for pressure and temperature, minimum and maximum measured values for pressure and temperature and the HistoROM function.
  - Display Transducer Block
 

This Block does not return any output variables. It contains all the parameters for configuring the onsite display such as DISPLAY\_CONTRAST.
  - Diagnostic Transducer Block
 

This Block does not return any output variables. It contains

    - the simulation function for the Pressure Transducer Block
    - parameters to configure the alarm response
    - parameters to set the user limits for pressure and temperature.
- 8 function blocks
  - 2 Analog Input Blocks (AI)
  - Discrete Input Block (DI)
  - Discrete Output Block (DO)
  - PID Block (PID)
  - Arithmetic Block (ARB)
  - Signal Characterizer Block (SCB)
  - Input Selector Block (ISB)
  - Analog Alarm Block (AALB)
  - Integrator Block (IT)

In addition to the pre-instanced blocks already mentioned, the following blocks can also be instanced:

- 3 Analog Input Blocks (AI)
- 1 Discrete Output Block (DO)
- 1 PID Block (PID)
- 1 Arithmetic Block (ARB)
- 1 Signal Characterizer Block (SCB)
- 1 Input Selector Block (ISB)
- 1 Analog Alarm Block (AALB)
- 1 Integrator Block (IT)

A total of 20 blocks can be instanced in Deltapilot S altogether, including the blocks already instanced. For instancing blocks, see the appropriate Operating Instructions of the configuration program used.

Endress+Hauser Guideline BA00062S.

The guideline provides an overview of the standard function blocks that are described in FOUNDATION Fieldbus Specifications FF 890 - 894.

It is designed to help operators use the blocks implemented in the Endress+Hauser field devices.

**Block configuration when device is delivered**

The block model shown below illustrates the block configuration when the device is delivered.

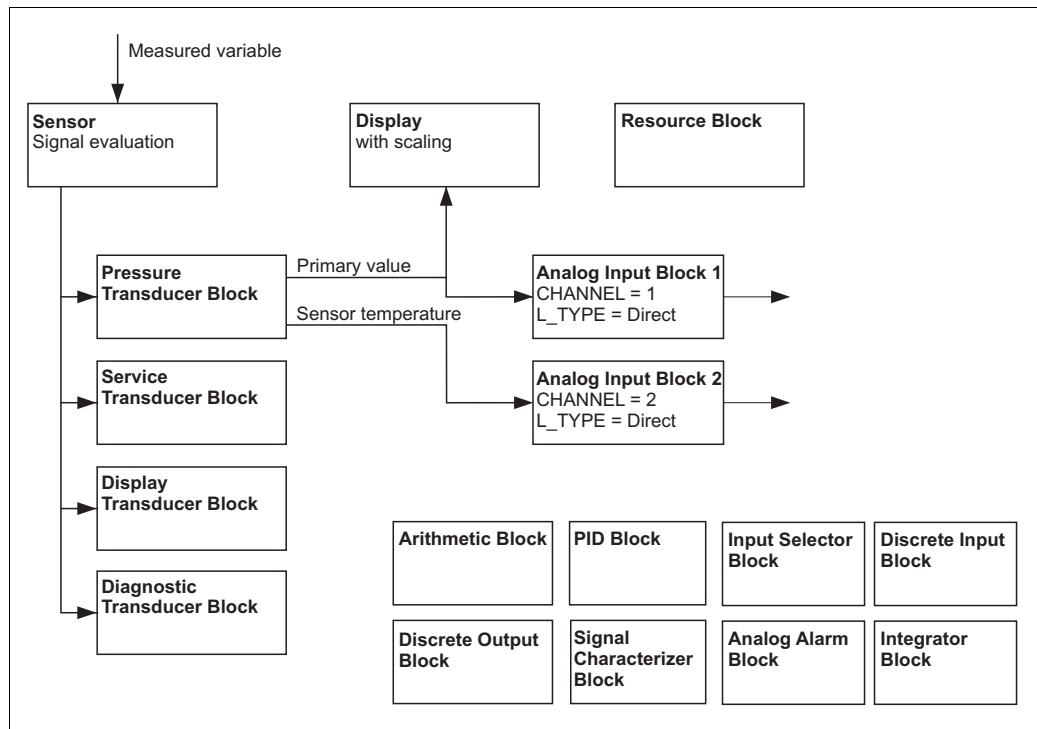

P01-PMx7xxxx-02-xx-xx-en-006

Fig. 14: Block configuration when device is delivered

The Pressure Transducer Block supplies the Primary Value and the sensor temperature (secondary value). The Primary Value and Secondary Value are each transferred to an Analog Input Block by means of the CHANNEL parameter (→ see also the following section). The Discrete Output, Discrete Input, PID, Arithmetic, Signal Characterizer, Input Selector, Integrator and Analog Alarm Block are not connected in the as-delivered configuration.

**⚠ CAUTION**

**Note Dependencies when setting parameters!**

- ▶ Please note that the links between the blocks are deleted and the FF parameters are reset to the default values following a reset by means of the RESTART parameter in the Resource Block, "Default" option.



### 6.3.7 Assignment of Transducer Blocks (CHANNEL)

#### Settings for the Analog Input Block

Process variable	Transducer Block	Parameter name	CHANNEL parameter in the Analog Input Block
Primary Value, a pressure or level value depending on the measuring mode <sup>1)</sup>	Pressure Transducer Block	PRIMARY_VALUE	1
Secondary Value (sensor temperature) <sup>2)</sup>		MEASURED_TEMPERATURE/TEMP. SENSOR	2
Pressure after damping	Service Transducer Block	PRESSURE_1_AFTER_DAMPING/PRESSURE	3
Maximum measured pressure		PRESSURE_1_MAX_RE STABLE/MAX. MEAS. PRESS.	4
Overshoot counter for maximum set user limit for pressure		COUNTER: P > Pmax	5

- 1) Factory setting for Analog Input Block 1
- 2) Factory setting for Analog Input Block 2

#### Settings for the Discrete Output Block

Process variable	Transducer Block	Parameter name	CHANNEL parameter in the Discrete Output Block
Overshoot counter for maximum set user limit for pressure <sup>1)</sup>	Service Transducer Block	COUNTER: P > Pmax	1

- 1) Factory setting

**Discrete Input Block settings**

Alarm conditions	Transducer Block	Parameter name	Parameter CHANNEL, Discrete Input Block
General device error	Diagnostic Transducer Block	DIAGNOSTIC_CODE	1
Configuration error			2
Sensor overpressure			3
Sensor underpressure			4
Sensor overtemperature			5
Sensor undertemperature			6
Process isolating diaphragm broken			7
Electronic overtemperature			8
Electronic undertemperature			9
Temperature transmitter override			10
Pressure transmitter override			11
Pmin PROCESS underrun			12
Pmax PROCESS overrun			13
Tmin PROCESS underrun			14
Tmax PROCESS overrun			15

### 6.3.8 Index tables of Endress+Hauser parameters

The following tables list the manufacturer-specific device parameters for the Resource Block, the Transducer Blocks and the Analog Input Blocks. For the FF parameters, see either the FF specification or Operating Instructions BA00303P "Description of Device Functions, Cerabar S/Deltabar S/Deltapilot S". These parameters are not displayed in the block view in FieldCare (exception: Analog Input Blocks).

#### General explanatory remarks

Data type

- DS: data structure, contains data types such as Unsigned8, Octet String etc.
- Bit enumerated
- Float: IEEE 754 format
- Visible String: ASCII coded
- Unsigned:
  - Unsigned8: value range = 0 to 255
  - Unsigned16: value range = 0 to 65535

Storage Class

- D: dynamic parameter
- N: nonvolatile parameter
- S: static parameter

If this is a write parameter, the MODE\_BLK column indicates the block mode in which the parameter can be written. Some parameters can only be written in the OOS block mode. The "Reset codes" column indicates which reset codes reset the parameter.

#### Resource Block

Parameter name, option "Symbolic name"	Parameter name, option "Label"	Index	Data type	Size (Byte)	Storage Class	Read	Write	MODE_BLK	Reset codes
ENP_VERSION	ENP version	44	Visible String	16	S	x			
DEVICE_TAG	Device tag	45	Visible String	32	S	x	x <sup>1)</sup>	AUTO, OOS	
SERIAL_NUMBER	Serial number	46	Visible String	16	S	x	x <sup>1)</sup>	AUTO, OOS	
ORDER_CODE	Order code	47	Visible String	32	S	x	x <sup>1)</sup>	AUTO, OOS	
FIRMWARE_VERSION	Firmware version	48	Visible String	16	S	x			
SW_LOCK	Insert PIN no.	49	Unsigned16	2	S	x	x	AUTO, OOS	7864, 333
STATUS_LOCKING	Status locking	50	Unsigned16	2	D	x			
HARDWARE_REVISION	Hardware rev.	74	Visible String	16	S	x			
FF_COMM_VERSION	FF comm. version	75	Visible String	16	S	x			
BLOCK_ERR_DESC_1	Block Error desc.	76	Bit enumerated	4	D	x			
DEVICE_DIALOG	Device dialog	77	Unsigned8	1	D	x			
ELECTRONIC_SERIAL_NUMBER	Electr. serial no.	78	Visible String	16	S	x			
PROCESS_CONNECTION_TYPE	Proc. conn. type	79	Unsigned16	2	S	x	x	AUTO, OOS	7864, 333
MAT_PROC_CONN_POS	Mat. proc. conn. +	80	Unsigned16	2	S	x	x	AUTO, OOS	7864, 333
MAT_PROC_CONN_NEG	Mat. proc. conn. -	81	Unsigned16	2	S	x	x	AUTO, OOS	7864, 333
SEAL_TYPE	Seal type	82	Unsigned16	2	S	x	x	AUTO, OOS	7864, 333
SCI_OCTET_STRING	SCI_OCTET_STR	83	Visible String	40	S	x	x	AUTO, OOS	
MS_RESOURCE_DIRECTORY	RESOURCE DIRECTORY	84	Unsigned16	20x2	S	x			

1) Can be written with service code

## Pressure Transducer Block

Parameter name, option "Symbolic name"	Parameter name, option "Label"	Index	Data type	Size (Byte)	Storage Class	Read	Write	MODE_BLK	Reset codes
MEASURED_TEMPERATURE	Temperature	32	DS-65	5	D	x			
MEASURED_TEMPERATURE_UNIT	Temp. eng. unit	33	Unsigned16	2	S	x	x	OOS	
DEVICE_DIALOG	Device dialog	34	Unsigned8	1	D	x			
SW_LOCK	Insert PIN no.	35	Unsigned16	2	S	x	x	AUTO, OOS, MAN	7864, 333
STATUS_LOCKING	Status locking	36	Unsigned16	2	D	x			
LINEARIZATION	Linearization	37	Unsigned8	2	S	x	x	OOS	7864, 333
SCALE_IN	Scale In	38	DS-68	11	S	x	x	OOS	7864, 333
SCALE_OUT	Scale Out	39	DS-68	11	S	x	x	OOS	7864, 333
DAMPING_VALUE	Damping value	40	Float	4	S	x	x	OOS	7864, 333
ZERO_POSITION_ADJUST	Pos. zero adjust	41	Unsigned8	1	D	x	x	OOS	
POSITION_INPUT_VALUE	Pos. input value	42	Float	4	S	x	x	OOS	7864, 333, 2509
CALIBRATION_OFFSET	Calib. offset	43	Float	4	S	x	x	OOS	7864, 333, 2509
CUSTOMER_UNIT_PRESSURE	Customer unit P	44	Visible String	8	S	x	x	AUTO, OOS, MAN	7864
CUSTOMER_FACTOR_UNIT_PRESS	Cust. unit. fact. P	45	Float	4	S	x	x	OOS	7864
LOW_TRIM_MEASURED	Lo trim measured	46	Float	4	S	x			2509
HIGH_TRIM_MEASURED	Hi trim measured	47	Float	4	S	x			2509
LEVEL_MODE	Level mode	48	Unsigned8	1	S	x	x	OOS	7864, 333
LINEAR_MEASURAND	Lin. measurand	49	Unsigned8	1	S	x	x	OOS	7864, 333
LINEARIZED_MEASURAND	Lin. measurand	50	Unsigned8	1	S	x	x	OOS	7864, 333
COMBINED_MEASURAND	Comb. measurand	51	Unsigned8	1	S	x	x	OOS	7864, 333
DENSITY_UNIT	Density unit	52	Unsigned16	2	S	x	x	OOS	7864, 333
HEIGHT_UNIT	Height unit	53	Unsigned16	2	S	x	x	OOS	7864, 333
CUSTOMER_HEIGHT_UNIT	Customer unit H	54	Visible String	8	S	x	x	AUTO, OOS, MAN	7864
CUSTOMER_UNIT_FACTOR_HEIGHT	Cust. unit. fact. H	55	Float	4	S	x	x	OOS	7864
VOLUME_UNIT	Unit volume	56	Unsigned16	2	S	x	x	OOS	7864, 333
CUSTOMER_UNIT_VOLUME	Customer unit V	57	Visible String	8	S	x	x	AUTO, OOS, MAN	7864
CUSTOMER_UNIT_FACTOR_VOLUME	Cust. unit. fact. V	58	Float	4	S	x	x	OOS	7864
MASS_UNIT	Unit mass	59	Unsigned16	2	S	x	x	OOS	7864, 333
CUSTOMER_UNIT_MASS	Customer unit M	60	Visible String	8	S	x	x	AUTO, OOS, MAN	7864
CUSTOMER_UNIT_FACTOR_MASS	Cust. unit. fact. M	61	Float	8	S	x	x	OOS	7864
CALIBRATION_MODE	Calibration mode	62	Unsigned8	1	S	x	x	OOS	7864, 333
ADJUST_DENSITY	Adjust density	63	Float	4	S	x	x	OOS	7864, 333
ZERO_POSITION	Zero position	64	Float	4	S	x	x	OOS	7864, 333
EMPTY_CALIBRATION	Empty calib. level easy	65	Float	4	S	x	x	OOS	7864, 333
FULL_CALIBRATION	Full calib. level easy	66	Float	4	S	x	x	OOS	7864, 333
TANK_VOLUME	Tank volume	67	Float	4	S	x	x	OOS	7864, 333
TANK_HEIGHT	Tank height	68	Float	4	S	x	x	OOS	7864, 333
HUNDRED_PERCENT_VALUE	100% point	69	Float	4	S	x	x	OOS	7864, 333
LEVEL_MIN	Level Min.	70	Float	4	S	x	x	OOS	7864, 333
LEVEL_MAX	Level Max.	71	Float	4	S	x	x	OOS	7864, 333
PROCESS_DENSITY	Process density	72	Float	4	S	x	x	OOS	7864, 333
LINEARIZATION_TABLE_SELECTION	Table selection	73	Unsigned8	1	S	x	x	AUTO, OOS, MAN	7864, 333
LINEARIZATION_EDIT_MODE	Edit table	74	Unsigned8	1	S	x	x	AUTO, OOS, MAN	7864
LINEARIZATION_TABLE_PRE_EDIT	Editor table	75	Unsigned8	1	D	x	x	AUTO, OOS, MAN	
LINEARIZATION_TABLE_INDEX	Line numb:	76	Unsigned8	1	D	x	x	AUTO, OOS, MAN	
LINEARIZATION_TABLE_X_VALUE	X-value:	77	Float	4	S	x	x	AUTO, OOS, MAN	7864
LINEARIZATION_TABLE_Y_VALUE	Y-value:	78	Float	4	S	x	x	AUTO, OOS, MAN	7864
LINEARIZATION_TABLE_POST_EDIT	Table editor	79	Unsigned8	1	D	x	x	OOS	
LINEARIZATION_TABLE_POST_VIEW	Measuring table	80	Unsigned8	1	D	x	x	AUTO, OOS, MAN	
LEVEL_TANK_DESCRIPTION	Tank description	81	Visible String	32	S	x	x	AUTO, OOS, MAN	7864
SENSOR_PRESSURE	Sensor pressure	82	Float	4	D	x			
PRESSURE	Pressure	83	Float	4	D	x			
LEVEL_BEFORE_LINEARISATION	Level before lin	84	Float	4	D	x			

Parameter name, option "Symbolic name"	Parameter name, option "Label"	Index	Data type	Size (Byte)	Storage Class	Read	Write	MODE_BLK	Reset codes
SENSOR_MEAS_TYPE	Sensor meas. type	85	Unsigned16	2	D	x			
LEVEL_SELECTION	Level mode	86	Unsigned8	1	S	x	x	OOS	7864, 333
HEIGHT_UNIT_EASY	Height unit	87	Unsigned16	2	S	x	x	OOS	
OUTPUT_UNIT_EASY	Output unit	88	Unsigned16	2	S	x	x	OOS	
CALIBRATION_MODE_EASY	Calibration mode level easy	89	Unsigned8	1	S	x	x	OOS	7864, 333
DENSITY_UNIT_EASY	Density unit level easy	90	Unsigned16	2	S	x	x	OOS	
ADJUST_DENSITY_EASY	Adjust density level easy	91	Float	4	S	x	x	OOS	7864, 333
EMPTY_HEIGHT_EASY	Full calib. level easy	92	Float	4	S	x	x	OOS	7864, 333
FULL_HEIGHT_EASY	Full calib. level easy	93	Float	4	S	x	x	OOS	7864, 333
PROCESS_DENSITY_EASY	Process density level easy	94	Float	4	D	x	x	OOS	7864, 333
MEASURED_LEVEL_EASY	Meas. level easy	95	Float	4	D	x			
FULL_CALIBRATION_EASY	Full calib. level easy	96	Float	4	S	x	x	OOS	7864, 333
EMPTY_CALIBRATION_EASY	Full calib. level easy	97	Float	4	S	x	x	OOS	7864, 333
FULL_PRESSURE_EASY	Full pressure	98	Float	4	S	x	x	OOS	7864, 333
EMPTY_PRESSURE_EASY	Empty pressure	99	Float	4	S	x	x	OOS	7864, 333

### Service Transducer Block

Parameter name, option "Symbolic name"	Parameter name, option "Label"	Index	Data type	Size (Byte)	Storage Class	Read	Write	MODE_BLK	Reset codes
DEVICE_DIALOG	Device dialog	11	Unsigned8	1	D	x			
SW_LOCK	Insert PIN no.	12	Unsigned16	2	S	x	x	AUTO, OOS, MAN	7864, 333
STATUS_LOCKING	Status locking	13	Unsigned16	2	D	x			
CONFIGURATION_COUNTER	Config recorder	14	Unsigned16	2	S	x			
ELECTRONICS_TEMPERATURE	Pcb temperature	15	Float	4	D	x			
ELECTRONICS_TEMP_LOW_LIMIT	Allowed min. temp	16	Float	4	S	x			
ELECTRONICS_TEMP_HIGH_LIMIT	Allowed max temp	17	Float	4	S	x			
PMAX_PROC_CONN	Pmax PROC. CONN.	18	Float	4	S	x	x	AUTO, OOS, MAN	
SENSOR_MEAS_TYPE	Sensor meas. type	19	Unsigned16	2	S	x			
SENSOR_MIN_ABSOLUTE_LIMIT	Pmin sensor. damage	20	Float	4	S	x			
SENSOR_MAX_ABSOLUTE_LIMIT	Pmax sensor. damage	21	Float	4	S	x			
SENSOR_TEMP_LOW_LIMIT	Tmin sensor	22	Float	4	S	x			
SENSOR_TEMP_HIGH_LIMIT	Tmax sensor	23	Float	4	S	x			
SENSOR_HARDWARE_REV	Sens. H/ware rev.	24	Unsigned8	1	S	x			
COUNTER_P_MAX	Counter: P > Pmax	25	DS-65	5	D	x			
MAX_MEASURED_PRESSURE	Max. meas. press.	26	DS-65	5	D	x			
COUNTER_PMIN	Counter: P < Pmin	27	Unsigned16	2	D	x			
MIN_MEASURED_PRESSURE	Min. meas. press.	28	Float	4	D	x			
COUNTER_TMAX	Counter: T > Tmax	29	Unsigned16	2	D	x			
MAX_MEASURED_TEMP	Max. meas. temp.	30	Float	4	D	x			
COUNTER_TMIN	Counter: T < Tmin	31	Unsigned16	2	D	x			
MIN_MEASURED_TEMP	Min. meas. temp.	32	Float	4	D	x			
ELECTRONIC_OVER_TEMP_COUNTER	Pcb count: T > Tmax	33	Unsigned16	2	D	x			
ELECTRONIC_OVER_TEMPERATURE	Pcb max. temp	34	Float	4	D	x			
ELECTRONIC_UNDER_TEMP_COUNTER	Pcb count: T < Tmin	35	Unsigned16	2	D	x			
ELECTRONIC_UNDER_TEMPERATURE	PCB min. temp.	36	Float	4	D	x			
RESET_PEAK_HOLD	Reset peakhold	37	Unsigned8	1	D	x	x	AUTO, OOS, MAN	
PRESSURE	Pressure	38	DS-65	5	D	x			
CORRECTED_PRESSURE	Corrected press.	39	Float	4	D	x			
MEASURED_VALUE_TREND	Meas. val. trend	40	Unsigned8	1	D	x			
MAX_TURNDOWN	Max. turndown	41	Float	4	S	x	x <sup>1)</sup>		
SENSOR_CHANGES	Sensor changes	42	Unsigned16	2	S	x	x <sup>1)</sup>		
PRESSURE_PEAK_HOLD_STEP	P. peakhold step	43	Float	4	S	x	x <sup>1)</sup>		
TEMP_PEAK_HOLD_STEP	T. peakhold step	44	Float	4	S	x	x <sup>1)</sup>		
ACCELERATION_OF_GRAVITY	Acc. of gravity	45	Float	4	S	x	x <sup>1)</sup>	OOS	
HISTOROM_SAVING_CYCLE_TIME	Hist. saving cycl	47	Unsigned8	1	S	x	x <sup>1)</sup>		
HISTOROM_AVAILABLE	Historom avail.	48	Unsigned8	1	S	x			
DOWNLOAD_SELECTION	Download select.	49	Unsigned8	1	D	x	x	AUTO, OOS, MAN	
HISTOROM_CONTROL	Historom control	50	Unsigned8	1	D	x	x		
PRESSURE_UNIT	Cal. unit	51	Unsigned16	2	S	x			
TEMPERATURE_UNIT	Temp. eng. unit	52	Unsigned16	2	S	x			
INPUT_PRESSURE_INVERSION	Inp.press invers	53	Unsigned8	1	S	x	x <sup>1)</sup>	OOS	

1) Can be written with service code

### Display Transducer Block

Parameter name, option "Symbolic name"	Parameter name, option "Label"	Index	Data type	Size (Byte)	Storage Class	Read	Write	BLK_MODE	Reset codes
DEVICE_DIALOG	Device dialog	10	Unsigned8	1	D	x			
DISPLAY_MAINLINE_CONTENT	Main line cont.	11	Unsigned8	1	S	x	x	AUTO, OOS, MAN	7864
DISPLAY_MAINLINE_FORMAT	Main data format	12	Unsigned8	1	S	x	x	AUTO, OOS, MAN	7864
DISPLAY_ALTERNATING_VALUES	Alternate data	13	Unsigned8	1	S	x	x	AUTO, OOS, MAN	7864
DISPLAY_CONTRAST	Display contrast	14	Unsigned8	1	S	x	x	AUTO, OOS, MAN	7864
DISPLAY_LANGUAGE	Language	15	Unsigned8	1	S	x	x	AUTO, OOS, MAN	7864
SIL_DIGITS_TEST_STRING	Digits set	16	Visible String	16	D	x			

### Diagnostic Transducer Block

Parameter name, option "Symbolic name"	Parameter name, option "Label"	Index	Data type	Size (Byte)	Storage Class	Read	Write	BLK_MODE	Reset codes
DEVICE_DIALOG	Device dialog	10	Unsigned8	1	D	x			
SW_LOCK	Insert PIN no.	11	Unsigned16	2	S	x	x	AUTO, OOS, MAN	7864, 333
STATUS_LOCKING	Status locking	12	Unsigned16	2	D	x			
SIMULATION_MODE	Simulation	13	Unsigned8	1	D	x	x	OOS	
SCALE_OUT_UNITS_INDEX	Units index	14	Unsigned16	2	S	x			
SIMULATED_VALUE	Simulated value	15	Float	4	D	x	x	AUTO, OOS, MAN	
SIMULATION_ERROR_NUMBER	Sim. error no.	16	Unsigned16	2	D	x	x	AUTO, OOS, MAN	
ALARM_STATUS	-	17	Unsigned16	2	D	x			
ALARM_STATUS_WITH_CATEGORY	Alarm status info	18	Unsigned16	2	D	x			
LAST_DIAGNOSTIC_CODE	-	19	Unsigned16	2	D	x			
LAST_DIAGNOSTIC_CODE_WITH_CATEGORY	Last diag. code info	20	Unsigned16	2	D	x			
ACKNOWLEDGE_ALARM_MODE	Ack. alarm mode	21	Unsigned8	1	S	x	x	AUTO, OOS, MAN	7864
ACKNOWLEDGE_ALARM	Ack. alarm	22	Unsigned8	1	D	x	x	AUTO, OOS, MAN	
RESET_ALL_ALARMS	Reset all alarms	23	Unsigned8	1	D	x	x	AUTO, OOS, MAN	
ERROR_NUMBER	Error no.	24	Unsigned16	2	D	x	x	AUTO, OOS, MAN	
SELECT_ALARM_TYPE	Select alarm type	25	Unsigned8	1	D	x	x	AUTO, OOS, MAN	
ALARM_DELAY	Alarm delay	26	Float	4	S	x	x	AUTO, OOS, MAN	7864
ALARM_DISPLAY_TIME	Alarm displ. time	27	Float	4	S	x	x	AUTO, OOS, MAN	7864
PRESSURE_UNIT	Cal. unit	28	Unsigned16	2	S	x			7864, 333
PMIN_ALARM_WINDOW	Pmin alarm window	29	Float	4	S	x	x	AUTO, OOS, MAN	7864
PMAX_ALARM_WINDOW	Pmax alarm window	30	Float	4	S	x	x	AUTO, OOS, MAN	7864
TEMPERATURE_UNIT	Temp. eng. unit	31	Unsigned16	2	S	x			7864, 333
TMIN_ALARM_WINDOW	Tmin. alarm window	32	Float	4	S	x	x	AUTO, OOS, MAN	7864
TMAX_ALARM_WINDOW	Tmax. alarm window	33	Float	4	S	x	x	AUTO, OOS, MAN	7864
ENTER_RESET_CODE	Enter reset code	34	Unsigned16	2	D	x	x	AUTO, OOS, MAN	
OPERATING_HOURS	Operating hours	35	Unsigned32	4	D	x			
STATUS_HISTORY	Alarm history	36	Visible String	18	D	x			
HIGHEST_CATEGORY	-	37	Unsigned8	1	D	x			
FF912_CONFIG_AREA	FF912ConfigArea	38	DS271	30	S	x	x	AUTO, OOS, MAN	7864
FF912_STATUS_SELECT1	Status Select Event 115	39	Enumerated	1	S	x	x	AUTO, OOS, MAN	7864
FF912_STATUS_SELECT2	Status Select Event 120	40	Enumerated	1	S	x	x	AUTO, OOS, MAN	7864
FF912_STATUS_SELECT3	Status Select Event 715	41	Enumerated	1	S	x	x	AUTO, OOS, MAN	7864

Parameter name, option "Symbolic name"	Parameter name, option "Label"	Index	Data type	Size (Byte)	Storage Class	Read	Write	BLK_MODE	Reset codes
FF912_STATUS_SELECT4	Status Select Event 717	42	Enumerated	1	S	x	x	AUTO, OOS, MAN	7864
FF912_STATUS_SELECT5	Status Select Event 718	43	Enumerated	1	S	x	x	AUTO, OOS, MAN	7864
FF912_STATUS_SELECT6	Status Select Event 720	44	Enumerated	1	S	x	x	AUTO, OOS, MAN	7864
FF912_STATUS_SELECT7	Status Select Event 726	45	Enumerated	1	S	x	x	AUTO, OOS, MAN	7864
FF912_STATUS_SELECT8	Status Select Event 727	46	Enumerated	1	S	x	x	AUTO, OOS, MAN	7864
FF912_STATUS_SELECT9	Status Select Event 730	47	Enumerated	1	S	x	x	AUTO, OOS, MAN	7864
FF912_STATUS_SELECT10	Status Select Event 731	48	Enumerated	1	S	x	x	AUTO, OOS, MAN	7864
FF912_STATUS_SELECT11	Status Select Event 732	49	Enumerated	1	S	x	x	AUTO, OOS, MAN	7864
FF912_STATUS_SELECT12	Status Select Event 733	50	Enumerated	1	S	x	x	AUTO, OOS, MAN	7864
FF912_STATUS_SELECT13	Status Select Event 740	51	Enumerated	1	S	x	x	AUTO, OOS, MAN	7864

### Analog Input Blocks

Parameter name, option "Symbolic name"	Parameter name, option "Label"	Index	Data type	Size (Byte)	Storage Class	Read	Write	BLK_MODE	Reset codes
FSAFE_TYPE	Fsafe_Type	37	Unsigned8	1	S	x	x	OOS, MAN	
FSAFE_VALUE	Fsafe_Value	38	Float	4	S	x	x	AUTO, OOS, MAN	
HIHI_ALM_OUT_D	High high alarm output discrete	39	DS66	2	D	x	x	AUTO, OOS, MAN	
HI_ALM_OUT_D	High alarm output discrete	40	DS66	2	D	x	x	AUTO, OOS, MAN	
LO_ALM_OUT_D	Low alarm output discrete	41	DS66	2	D	x	x	AUTO, OOS, MAN	
LOLO_ALM_OUT_D	Low low alarm output discrete	42	DS66	2	D	x	x	AUTO, OOS, MAN	
ALARM_MODE	Select alarm mode	43	Unsigned8	1	S	x	x	AUTO, OOS, MAN	
ALARM_OUT_D	Alarm output discrete	44	DS66	2	D	x	x	AUTO, OOS, MAN	
BLOCK_ERR_DESC_1	Block error description	45	Unsigned32	4	D	x		AUTO, OOS, MAN	

### 6.3.9 Methods

The FOUNDATION Fieldbus Specification includes the use of methods to make device operation easier. A method is a sequence of interactive steps to be carried out in the specified order so as to configure certain device functions.

The following methods are available for Deltapilot S:

- Restart (Resource Block)
- Troubleshooting information, Config. Error No, Alarm Table (Diagnostic Block)
- HistoROM (Service Block)
- Sensor Trim (TRD Block)

For further information on accessing methods, see the description of the FF configuration program used.

## 6.4 Local operation – onsite display connected

If the onsite display is connected, the three operating keys are used to navigate through the operating menu, → 27, Section 6.2.3 "Function of the operating elements – onsite display connected".

### 6.4.1 Menu structure

The menu is split into four levels. The three upper levels are used to navigate while you use the lowest level to enter numerical values, and select and save options.

The structure of the MEASURING MENU depends on the measuring mode selected, e.g. if "Pressure" is selected as the measuring mode, only the functions needed for this measuring mode are displayed.

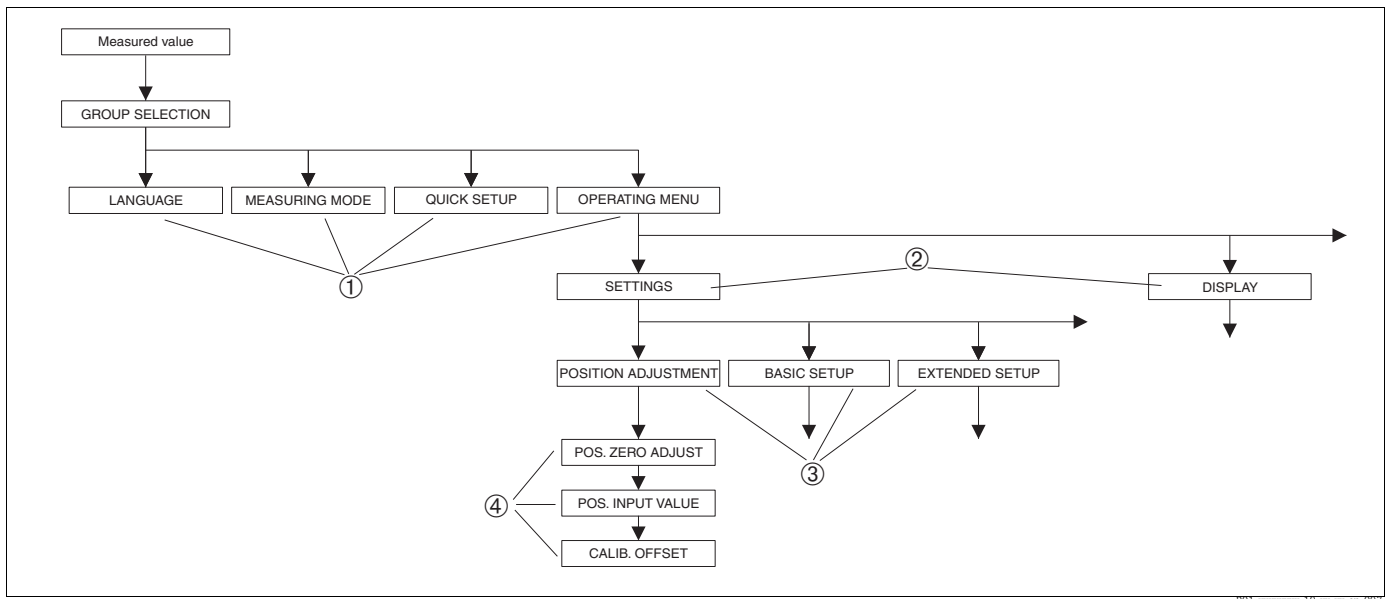

Fig. 15: Menu structure

- 1 1st selection level
- 2 2nd selection level
- 3 Function groups
- 4 Parameters

The MEASURING MODE parameter is only displayed via the onsite display on the 1st selection level. In FieldCare, the LANGUAGE parameter is displayed in the DISPLAY group and the parameters for configuring the measuring mode are displayed in the Measuring Mode menu.



### 6.4.2 Selecting an option

Example: Selecting the "Pressure" measuring mode.

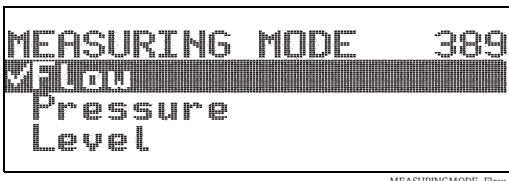
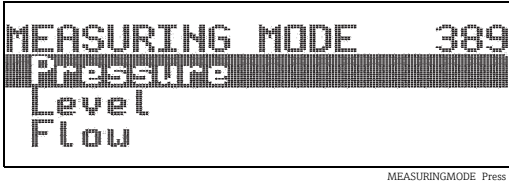
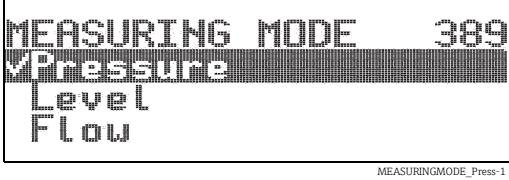
Onsite display	Operation
 <p>MEASURING MODE 389 3 Pressure Level Flow</p> <p><small>MEASURINGMODE_Flow</small></p>	<p>"Level" has been selected as the measuring mode. The option currently active is indicated by a 3 in front of the menu text.</p>
 <p>MEASURING MODE 389 Pressure Level Flow</p> <p><small>MEASURINGMODE_Press</small></p>	<p>Use "+" or "-" to select "Pressure" as the operating mode.</p>
 <p>MEASURING MODE 389 3 Pressure Level Flow</p> <p><small>MEASURINGMODE_Press-1</small></p>	<ol style="list-style-type: none"> <li>1. Press "E" to confirm your choice. The option currently active is indicated by a 3 in front of the menu text. (The "Pressure" measuring mode is selected.)</li> <li>2. Go to the next menu item with "E".</li> </ol>

### 6.4.3 Editing a value

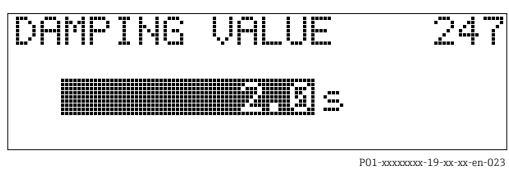
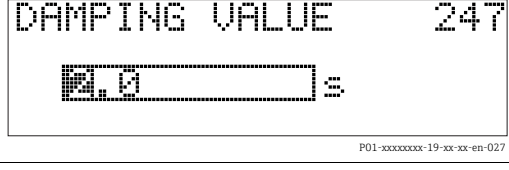
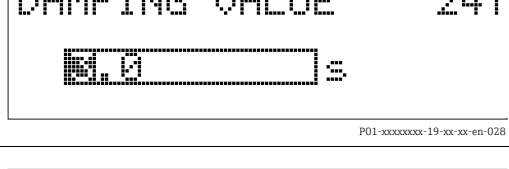
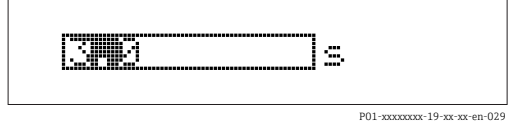

Example: changing the DAMPING VALUE function from 2.0 s to 30.0 s. See also → [27](#), Section 6.2.3 "Function of the operating elements – onsite display connected".

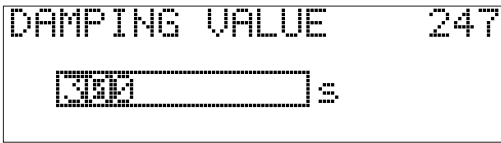
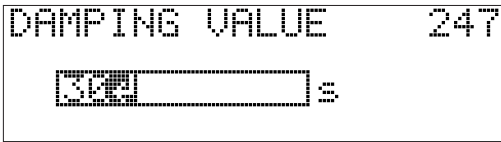
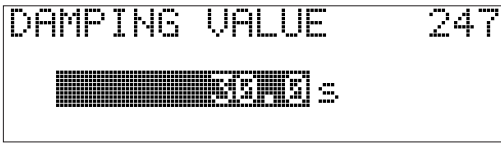
Onsite display	Operation
 <p>DAMPING VALUE 247 2.0 : s</p> <p><small>P01-xxxxxxxx-19-xx-xx-en-023</small></p>	<p>The onsite display indicates the parameter to be modified. The value highlighted in black can be modified. The unit "s" is prespecified and cannot be changed.</p>
 <p>DAMPING VALUE 247 2.0 : s</p> <p><small>P01-xxxxxxxx-19-xx-xx-en-027</small></p>	<ol style="list-style-type: none"> <li>1. Press "+" or "-" to enter the editing mode.</li> <li>2. The first digit is highlighted in black.</li> </ol>
 <p>DAMPING VALUE 247 2.0 : s</p> <p><small>P01-xxxxxxxx-19-xx-xx-en-028</small></p>	<ol style="list-style-type: none"> <li>1. Use the "+" key to change the digit "2" to "3".</li> <li>2. Press the "E" key to confirm "3". The cursor goes to the next position (highlighted in black).</li> </ol>
 <p>DAMPING VALUE 247 3.0 : s</p> <p><small>P01-xxxxxxxx-19-xx-xx-en-029</small></p>	<p>The decimal point is highlighted in black. This means you can now edit this digit.</p>

Onsite display	Operation
 <p>P01-xxxxxxxx-19-xx-xx-en-030</p>	<ol style="list-style-type: none"> <li>1. Press "+" or "-" until "0" is displayed.</li> <li>2. Press the "E" key to confirm "0". The cursor goes to the next position. <b>0</b> is displayed and highlighted in black. → See next graphic.</li> </ol>
 <p>P01-xxxxxxxx-19-xx-xx-en-031</p>	<p>Press "E" to save the new value and exit the editing mode. → See next graphic.</p>
 <p>P01-xxxxxxxx-19-xx-xx-en-032</p>	<p>The new value for the damping is 30.0 s.</p> <ul style="list-style-type: none"> <li>- Go to the next parameter with "E".</li> <li>- Press "+" or "-" to go back to the editing mode.</li> </ul>

### 6.4.4 Accepting pressure present at device as value

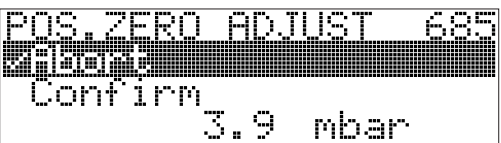
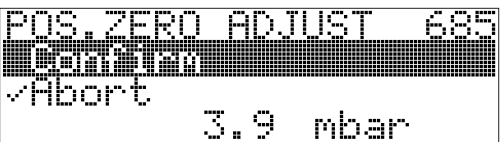
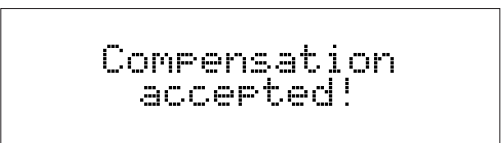
Example: performing position adjustment.

Onsite display	Operation
 <p>P01-xxxxxxxx-19-xx-xx-en-158</p>	<p>The bottom line on the onsite display displays the pressure present, 3.9 mbar in this example.</p>
 <p>P01-xxxxxxxx-19-xx-xx-en-159</p>	<p>Use "+" or "-" to switch to the "Confirm" option. The active option is highlighted in black.</p>
 <p>P01-xxxxxxxx-19-xx-xx-en-037</p>	<p>Using the "E" key, assign the value (3.9 mbar) to the POS. ZERO ADJUST parameter. The device confirms the adjustment and goes back to the parameter, here POS. ZERO ADJUST (see next graphic).</p>
 <p>P01-xxxxxxxx-19-xx-xx-en-160</p>	<p>Go to the next parameter with "E".</p>

## 6.5 FieldCare

FieldCare is Endress+Hauser's plant asset management tool based on FDT technology. You can use FieldCare to configure all Endress+Hauser devices as well as third-party devices which support the FDT standard. Hardware and software requirements you can find on the internet: [www.endress.com](http://www.endress.com) → select your country → Search: FieldCare → FieldCare<sup>®</sup> Technical Data.

FieldCare supports the following functions:

- Configuration of transmitters in offline and online mode
- Loading and saving device data (upload/download)
- HistoROM<sup>®</sup>/M-DAT analysis
- Documentation of the measuring point

Connection options:

- Service interface with Commubox FXA291 and ToF adapter FXA291 (USB).
- In the "Level Standard" measuring mode, the configuration data that were loaded with FDT upload cannot be written again (FDT download). These data are only used to document the measuring point.
- For further information, see → [www.endress.com](http://www.endress.com)

## 6.6 HistoROM<sup>®</sup>/M-DAT (optional)

### NOTICE

#### Device could be destroyed!

Detach HistoROM<sup>®</sup>/M-DAT from the electronic insert or attach it to the insert in a deenergized state only.

HistoROM<sup>®</sup>/M-DAT is a memory module, which is attached to the electronic insert and fulfils the following functions:

- Back-up copy of configuration data
- Copying configuration data of a transmitter into another transmitter
- Cyclic recording of pressure and sensor-temperature measured values
- Recording diverse events, such as alarms, configuration changes, counters for measuring range undershooting and exceeding for pressure and temperature, exceeding and undershooting the user limits for pressure and temperature, etc.
- The HistoROM<sup>®</sup>/M-DAT can be retrofitted at any time (Order No.: 52027785).
- To analyze and evaluate the data and events saved in the HistoROM<sup>®</sup>/M-DAT, you require the Endress+Hauser FieldCare operating program. A CD with the operating program and documentation is provided for devices that were ordered with the "HistoROM<sup>®</sup>/M-DAT" option. See also → [43](#), Section 6.5 "FieldCare". It is also possible to copy configuration data from one transmitter to another transmitter with an FF configuration program.
- The HistoROM data and the data in the device are analyzed once a HistoROM<sup>®</sup>/M-DAT is attached to the electronic insert and power is reestablished to the device. During the analysis, the messages "W702, HistoROM data not consistent" and "W706, Configuration in HistoROM and device not identical" can occur. For remedial measures, → [75](#), Section 9.2 "Diagnostic information on local display".

## 6.6.1 Copying configuration data

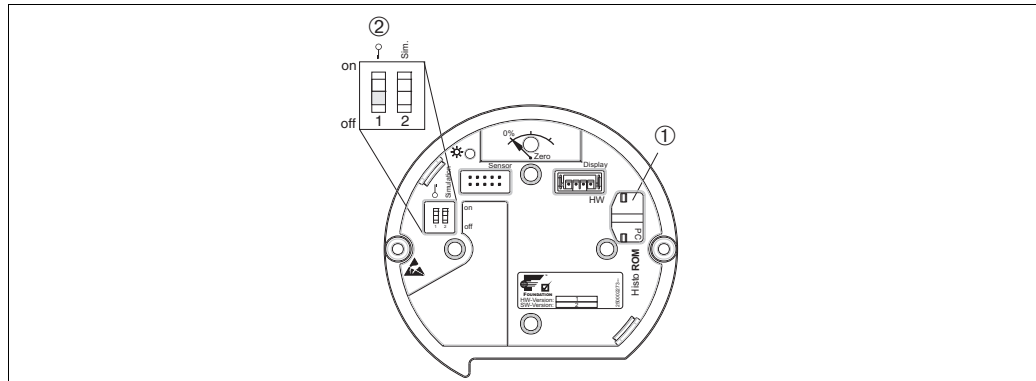

Electronic insert with optional HistoROM<sup>®</sup>/M-DAT memory module

- 1 Optional HistoROM<sup>®</sup>/M-DAT
- 2 To copy configuration data from the HistoROM<sup>®</sup>/M-DAT to a device or from a device to a HistoROM<sup>®</sup>/M-DAT module, operation must be unlocked (DIP switch 1, position "Off", parameter INSERT PIN No = 100). Please refer also to → 46, Section 6.7 "Locking/unlocking operation".

### Local operation via onsite display (optional) or remote operation

#### Copying configuration data from a device to a HistoROM<sup>®</sup>/M-DAT:

Operation must be unlocked.

1. Disconnect the device from the supply voltage.
2. Remove the protection cap, attach the HistoROM<sup>®</sup>/M-DAT to the electronic insert.
3. Reestablish supply voltage to the device.
4. The option selected for the DOWNLOAD SELECT. parameter (OPERATION menu) does not affect uploading from the device to the HistoROM.
5. Operation via an FF configuration program: using the DAT\_HANDLING/ HistoROM CONTROL parameter in the Service Transducer Block, select the "Device → HistoROM" option for the data transfer direction.  
 Operation via FieldCare: using the HistoROM CONTROL parameter, select the "Device → HistoROM" option for the data transfer direction. (Menu path: OPERATING MENU → OPERATION)  
 Using the DOWNLOAD SELECT. parameter (OPERATION menu), select which parameters should be overwritten.  
 The following parameters are overwritten depending on the option selected:
  - **Configuration copy:**  
 All the parameters apart from the TRANSMITTER SERIAL NO., DEVICE DESIGNATION and the parameters of the POSITION ADJUSTMENT and PROCESS CONNECTION group.
  - **Device replacement:**  
 All the parameters apart from the TRANSMITTER SERIAL NO., DEVICE DESIGNATION and the parameters of the POSITION ADJUSTMENT and PROCESS CONNECTION group.
  - **Electronics replace:**  
 All parameters apart from the parameters of the POSITION ADJUSTMENT group  
 Factory setting: Configuration copy
6. Using the HistoROM CONTROL parameter, select the "Device → HistoROM" option for the data transfer direction.
7. Wait approx. 40 seconds. Configuration data are uploaded from the device to the HistoROM<sup>®</sup>/M-DAT. The device is not restarted.
8. Disconnect the device from the supply voltage again.
9. Detach the memory module.

10. Reestablish supply voltage to the device.

**Copying configuration data from a HistoROM<sup>®</sup>/M-DAT to a device:**

Operation must be unlocked.

1. Disconnect the device from the supply voltage.
2. Attach the HistoROM<sup>®</sup>/M-DAT to the electronic insert. Configuration data from another device are stored in the HistoROM<sup>®</sup>/M-DAT.
3. Reestablish supply voltage to the device.
4. Operation via an FF configuration program: using the DAT\_HANDLING/ HistoROM CONTROL parameter in the Service Transducer Block, select the "HistoROM → Device" option for the data transfer direction.

Operation via FieldCare: using the HistoROM CONTROL parameter, select the "HistoROM → Device" option for the data transfer direction (menu path: OPERATING MENU → OPERATION).

Using the DOWNLOAD SELECT. parameter (OPERATION menu), select which parameters should be overwritten.

The following parameters are overwritten depending on the option selected:

– **Configuration copy (factory setting)**

all parameters except DEVICE SERIAL No., DEVICE DESIGN, PD-TAG, DESCRIPTION, DEVICE ID, DEVICE ADDRESS and the parameters in the POSITION ADJUSTMENT, PROCESS CONNECTION, SENSOR TRIM and SENSOR DATA group.

– **Device replacement**

all parameters except DEVICE SERIAL No., DEVICE ID, DEVICE DESIGN and the parameters in the POSITION ADJUSTMENT, PROCESS CONNECTION, SENSOR TRIM and SENSOR DATA group.

– **Electronics replace**

all parameters except the parameters in the SENSOR DATA group.

Factory setting: Configuration copy

5. Operation via an FF configuration program: using the DAT\_HANDLING/ HistoROM CONTROL parameter in the Service Transducer Block, select the "HistoROM → Device" option for the data transfer direction.  
Operation via FieldCare: using the HistoROM CONTROL parameter, select the "HistoROM → Device" option for the data transfer direction. (Menu path: OPERATING MENU → OPERATION).
6. Using the HistoROM CONTROL parameter (OPERATION menu), select the "HistoROM → Device" option for the data transfer direction.
7. Wait approx. 40 seconds. Configuration data are loaded from the HistoROM<sup>®</sup>/M-DAT to the device. The device is restarted.
8. Before removing the HistoROM<sup>®</sup>/M-DAT again from the electronic insert, disconnect the device from the supply voltage.

## 6.7 Locking/unlocking operation

Once you have entered all the parameters, you can lock your entries against unauthorized and undesired access.

The operation can be locked/unlocked in the following ways:

- Via a DIP switch on the electronic insert, locally on the display.
- Via communication e.g. FieldCare.

The -symbol on the onsite display indicates that operation is locked. Parameters which refer to how the display appears, e.g. LANGUAGE and DISPLAY CONTRAST, can still be altered.

- If operation is locked by means of the DIP switch, you can only unlock operation again by means of the DIP switch. If operation is locked by means of remote operation e.g. FieldCare, you can only unlock operation again by means of remote operation.

The table provides an overview of the locking functions:

Locking via	View/read parameter	Modify/write via <sup>1)</sup>		Unlocking via		
		Onsite display	Remote operation	DIP-Switch	Onsite display	Remote operation
DIP-Switch	yes	no	no	yes	no	no
Onsite display	yes	no	no	no	yes	yes
Remote operation	yes	no	no	no	yes	yes

1) Parameters which refer to how the display appears, e.g. LANGUAGE and DISPLAY CONTRAST can still be altered.

### 6.7.1 Locking/unlocking operation locally via DIP switch

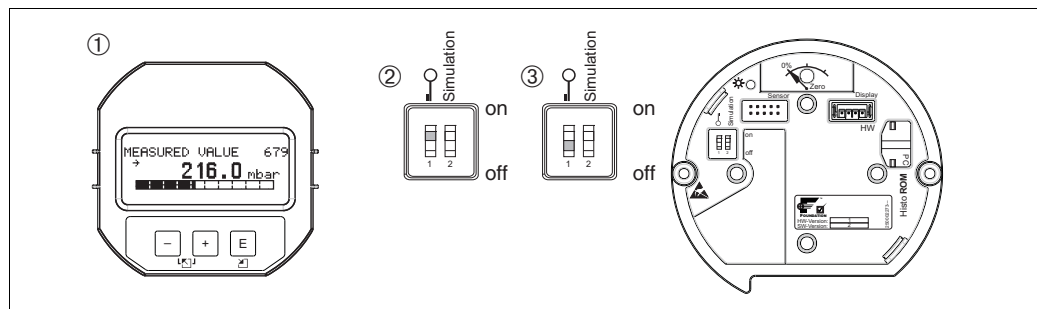

Fig. 16: "Hardware locking" DIP switch position on the electronic insert

- 1 If necessary, remove onsite display (optional)
- 2 DIP switch is set to "On": operation is locked.
- 3 DIP switch is set to "Off": operation is unlocked (operation possible)

### 6.7.2 Locking/unlocking operation via remote operation

	Description
Locking operation	<ol style="list-style-type: none"> <li>1. Operation via FF configuration program: select SWLOCK parameter in the Resource Block. Operation via FieldCare: select INSERT PIN No. parameter. Menu path: OPERATING MENU → OPERATION → INSERT PIN No.</li> <li>2. To lock operation, enter "0" for the parameter.</li> </ol>
Unlocking operation	<ol style="list-style-type: none"> <li>1. Operation via FF configuration program: select SWLOCK parameter in the Resource Block. Operation via FieldCare: select INSERT PIN No. parameter.</li> <li>2. To unlock operation, enter "100" for the parameter.</li> </ol>

## 6.8 Simulation

The function of the Analog Input Block, such as input and output scaling, can be simulated as follows:

1. Set the "Simulation" DIP switch on the electronic insert to "On".
2. In the Analog Input Block, select the "Active" option by means of the SIMULATION parameter, ENABLE\_DISABLE element.
3. Set the Analog Input Block to the AUTO block mode.
4. Enter the value and status for the SIMULATION\_VALUE and SIMULATION\_STATUS elements. During the simulation, the output value and status of the Pressure Transducer Block are replaced by the simulated value and status. The OUT parameter shows the result.
5. End simulation (SIMULATION parameter, ENABLE\_DISABLE element, "Disabled" option).

You can check your adjustment for the transmitter by means of the SIMULATION\_MODE and SIMULATION\_VALUE parameters in the Diagnostic Transducer Block. → See Operating Instructions BA303 "Description of Device Functions Cerabar S/Deltabar S, Deltapilot S", SIMULATION\_MODE and SIMULATION\_VALUE parameter descriptions.

## 6.9 Factory setting (reset)

- Total reset: Press zero-key for at least 12 seconds. The LED on the electronic insert lights up briefly if a reset is being carried out.
- By entering a certain code, you can completely, or partially, reset the entries for the parameters to the factory settings. (→ For the factory settings, see Operating Instructions BA00303P "Cerabar S/Deltabar S/Deltapilot S, Description of Device Functions"). Enter the code by means of the ENTER RESET CODE parameter (OPERATION menu). There are various reset codes for the device. The following table illustrates which parameters are reset by the particular reset codes. Operation has to be unlocked to be able to perform a reset (→ 46, Section 6.7).
- Any customer-specific configuration carried out by the factory is not affected by a reset (customer-specific configuration remains). If, after a reset, you wish the parameters to be reset to the factory settings, please contact Endress+Hauser Service.
- The OUT Value may have to be rescaled after resetting with code 7864. See also → 61, Section 7.8 "Scaling the OUT parameter".

### 6.9.1 Performing reset via an FF configuration program

If operating via an FF configuration program, enter the code by means of the RESET\_INPUT\_VALUE/ENTER RESET CODE parameter in the Diagnostic Transducer Block. The index tables on → 35 ff. indicate which parameters are reset by the particular reset code.

- The RESET FF parameter gives you the option of deleting links between function blocks and resetting FF parameters to default values and manufacturer-specific parameters to the factory setting. → See also Operating Instructions BA00303P, RESTART parameter description.

## 6.9.2 Performing reset via the FieldCare operating program

If operating via FieldCare, enter the code via the ENTER RESET CODE parameter (menu path: OPERATING MENU → OPERATION).

The following table illustrates which parameters are reset by the particular reset codes.

Reset code	Description and effect <sup>1)</sup>
7864	<p><b>Total reset</b></p> <ul style="list-style-type: none"> <li>- This reset resets the following parameters: <ul style="list-style-type: none"> <li>- POSITION ADJUSTMENT function group</li> <li>- BASIC SETUP function group</li> <li>- EXTENDED SETUP function group</li> <li>- LINEARIZATION function group (an existing linearization table is deleted)</li> <li>- OUTPUT group</li> <li>- INFO function group, TAG_DESC parameter</li> <li>- MESSAGES function group</li> <li>- All configurable messages ("Error" type) are set to "Warning".</li> </ul> </li> <li>See also → 75, Section 9.2 "Diagnostic information on local display" and → 90, Section 9.6 "Response of outputs to errors".</li> <li>- USER LIMITS function group</li> <li>- Any simulation which may be running is ended.</li> <li>- The device is restarted.</li> </ul>
333	<p><b>User reset</b></p> <ul style="list-style-type: none"> <li>- This reset resets the following parameters: <ul style="list-style-type: none"> <li>- POSITION ADJUSTMENT function group</li> <li>- BASIC SETUP function group, apart from customer-specific units</li> <li>- EXTENDED SETUP function group</li> <li>- OUTPUT group</li> </ul> </li> <li>- Any simulation which may be running is ended.</li> <li>- The device is restarted.</li> </ul>
2710	<p><b>Reset Level measuring mode</b></p> <ul style="list-style-type: none"> <li>- Depending on the settings for the LEVEL MODE, LIN MEASURAND, LIND MEASURAND or COMB. MEASURAND parameters, the parameters needed for this measuring task will be reset.</li> <li>- Any simulation which may be running is ended.</li> <li>- The device is restarted.</li> </ul> <p>Example LEVEL MODE = linear and LIN. MEASURAND = level</p> <ul style="list-style-type: none"> <li>■ HEIGHT UNIT = m</li> <li>■ CALIBRATION MODE = wet</li> <li>■ EMPTY CALIB. = 0</li> <li>■ FULL CALIB. = sensor end value converted to mH<sub>2</sub>O, e.g. for a 500 mbar (7.5 psi) sensor : 50.99 mH<sub>2</sub>O</li> </ul>
2509	<p><b>Sensor adaption reset</b></p> <ul style="list-style-type: none"> <li>- This reset resets the upper and lower sensor calibration limit and the value for position adjustment.</li> <li>- POSITION ADJUSTMENT function group</li> <li>- PRESSURE_1_LOWER_CAL/LO_TRIM_MEASURED and PRESSURE_1_HIGHER_TRIM_MEASURED/HI_TRIM_MEASURED parameters</li> <li>These parameters are not available by means of the FieldCare operating program.</li> <li>- Any simulation which may be running is ended.</li> <li>- The device is restarted.</li> </ul>
1846	<p><b>Display reset</b></p> <ul style="list-style-type: none"> <li>- This reset resets all parameters which have to do with how the display appears (DISPLAY group).</li> <li>- Any simulation which may be running is ended.</li> <li>- The device is restarted.</li> </ul>
8888	<p><b>HistoROM reset</b></p> <p>The measured value and event buffers are deleted. During the reset, the HistoROM has to be attached to the electronic insert.</p>



Reset code	Description and effect <sup>1)</sup>
62	<b>PowerUp reset (warm start)</b> <ul style="list-style-type: none"><li>- This reset resets all the parameters in the RAM. Data are read back anew from the EEPROM (processor is initialized again).</li><li>- Any simulation which may be running is ended.</li><li>- The device is restarted.</li></ul>

- 1) The table uses the group and parameter names as they appear in Field Care. See → 35, Section 6.3.8 "Index tables of Endress+Hauser parameters" for the assignment of the FieldCare parameter names and the FF configuration program.

## 7 Commissioning

The device is configured for the level measuring mode as standard. The measuring range and the unit in which the measured value is transmitted correspond to the specifications on the nameplate.

### **⚠ WARNING**

#### **Exceeding the maximum allowable working pressure!**

Risk of injury due to bursting of parts! Warning messages are generated if pressure is too high.

- ▶ If a pressure greater than the maximum permitted pressure is present at the device, the messages "E115 Sensor overpressure" and "E727 Sensor pressure error - overrange" are output in succession! Use the device only within the sensor range limits

### **NOTICE**

#### **Shortfall of the allowable working pressure!**

Output of messages if pressure is too low.

- ▶ If a pressure smaller than the minimum permitted pressure is present at the device, the messages "E120 Sensor low pressure" and "E727 Sensor pressure error - overrange" are output in succession! Use the device only within the sensor range limits

### 7.1 Configuring messages

- The messages E727, E115 and E120 are "Error"-type messages and can be configured as a "Warning" or an "Alarm". The factory setting for these messages is "Warning". This setting prevents the BAD status from being transmitted in applications (e.g. cascade measurement) where the user is aware of the risk of the sensor range being overshot.
- We recommend setting messages E727, E115 and E120 to "Alarm" in the following instances:
  - It is not necessary to violate the sensor range for the measuring application.
  - A position adjustment must be carried out that has to correct a large measured error as a result of the orientation of the device.

### 7.2 Function check

Carry out a post-installation and a post-connection check as per the checklist before commissioning the device.

- "Post-installation check" checklist → see Section 4.5
- "Post-connection check" checklist → see Section 5.4

### 7.3 Commissioning via an FF configuration program

- The device is configured for the Pressure measuring mode as standard. The measuring range and the unit in which the measured value is transmitted, as well as the digital output value of the Analog Input Block OUT, correspond to the data on the nameplate. Following a reset with code 7864, the OUT parameter may have to be rescaled (see also → [61](#), Section 7.8 "Scaling the OUT parameter").
  - The standard order configuration is illustrated on → [30](#), Section 6.3.6 "Deltapilot S block model".
1. Switch on the device.
  2. Note the DEVICE\_ID. See also → [30](#), Section 6.3.5 "Device identification and addressing" and → [10](#), Section 3.2.1 "Nameplates" for the device serial number.
  3. Open the configuration program.
  4. Load Cff and device description files into the host system or the configuration program. Make sure you are using the right system files.

5. Identify the device using the `DEVICE_ID` (→ see Point 2). Assign the desired tag name to the device by means of the `PD_TAG` parameter.

### Configuring the Resource Block

1. Open the Resource Block.
2. If necessary, disable the lock for device operation. See → [46](#), Section 6.7 "Locking/unlocking operation". Operating is unlocked as standard.
3. If necessary, change the block name. Factory setting: `RS_452B481007-xxxxxxxxxxx`
4. If necessary, assign a description to the block by means of the `TAG_DESC` parameter.
5. If necessary, change other parameters as per the requirements.

### Configuring the Transducer Blocks

Deltapilot S has the following Transducer Blocks:

- Pressure Transducer Block
- Service Transducer Block
- Display Transducer Block
- Diagnostic Transducer Block

The explanation that follows is an example for the Pressure Transducer Block.

1. If necessary, change the block name. Factory setting: `RS_452B481007-xxxxxxxxxxx`
2. Set the block mode to OOS using the `MODE_BLK` parameter, TARGET element.
3. Configure the device in accordance with the measuring task. → See also these Operating Instructions Section 7.4 to Section 7.8.
4. Set the block mode to Auto using the `MODE_BLK` parameter, TARGET element.

The block mode must be set to "Auto" for the Pressure and Service Transducer Block for the measuring device to function correctly.

### Configuring the Analog Input Blocks

Deltapilot S has 2 Analog Input Blocks that can be assigned as required to the various process variables.

1. If necessary, change the block name. Factory setting: `RS_452B481007-xxxxxxxxxxx`
2. Set the block mode to OOS using the `MODE_BLK` parameter, TARGET element.
3. Use the `CHANNEL` parameter to select the process variable which should be used as the input value for the Analog Input Block. The following settings are possible:
  - `CHANNEL = 1`: Primary value, a pressure or level value depending on the measuring mode selected
  - `CHANNEL = 2`: Secondary value, here the sensor temperature
 Factory setting:
  - Analog Input Block 1: `CHANNEL = 1`: Primary Value (pressure measured value)
  - Analog Input Block 2: `CHANNEL = 2`: Secondary Value (sensor temperature)
4. Use the `XD_SCALE` parameter to select the desired unit and the block input range for the process variable. See also → [61](#), Section 7.8 "Scaling the OUT parameter". Make sure that the unit selected suits the process variable selected. If the process variable does not suit the unit, the `BLOCK_ERROR` parameter reports "Block Configuration Error" and the block mode cannot be set to "Auto".
5. Use the `L_TYPE` parameter to select the type of linearization for the input variable (factory setting: Direct). Make sure that the settings for the `XD_SCALE` and `OUT_SCALE` parameters are the same for the "Direct" linearization type. If the process values and units do not match, the `BLOCK_ERROR` parameter reports "Block Configuration Error" and the block mode cannot be set to "Auto".

6. Enter the alarm and critical alarm messages by means of the HI\_HI\_LIM, HI\_LIM, LO\_LIM and LO\_LO\_LIM parameters. The limit values entered have to be within the value range specified for the OUT\_SCALE parameter.
7. Specify the alarm priorities by means of the HI\_HI\_PRI, HI\_PRI, LO\_LO\_PRI and LO\_PRI parameters. Reporting to the field host system only takes place with alarms with a priority greater than 2.
8. Set the block mode to Auto using the MODE\_BLK parameter, TARGET element. For this purpose, the Resource Block must also be set to the "Auto" block mode.

#### **Additional configuration**

1. Depending on the control or automation task, configure additional function blocks and output blocks. → See also Operating Instructions BA00303P "Description of Device Functions Cerabar S/Deltabar S/Deltapilot S".
2. Link the function blocks and output blocks.
3. After specifying the active LAS, download all the data and parameters to the field device.

## **7.4 Selecting the language and measuring mode**

### **7.4.1 Local operation**

The MEASURING MODE parameter is on the 1st selection level.  
Section 6.4.1 "Menu structure".

The following measuring modes are available:

- Pressure
- Level

## 7.4.2 Selecting the language and measuring mode by means of the FieldCare operating program

### Measuring mode, selection

**▲ WARNING**

**Changing the measuring mode affects the span (URV)!**

This situation can result in product overflow.

- ▶ If the measuring mode is changed, the span setting (URV) must be verified in the "CALIBRATION" → "BASIC SETUP" operating menu and, if necessary, reconfigured!

The parameters for setting the measuring mode are displayed in the FieldCare "Measuring mode" menu:

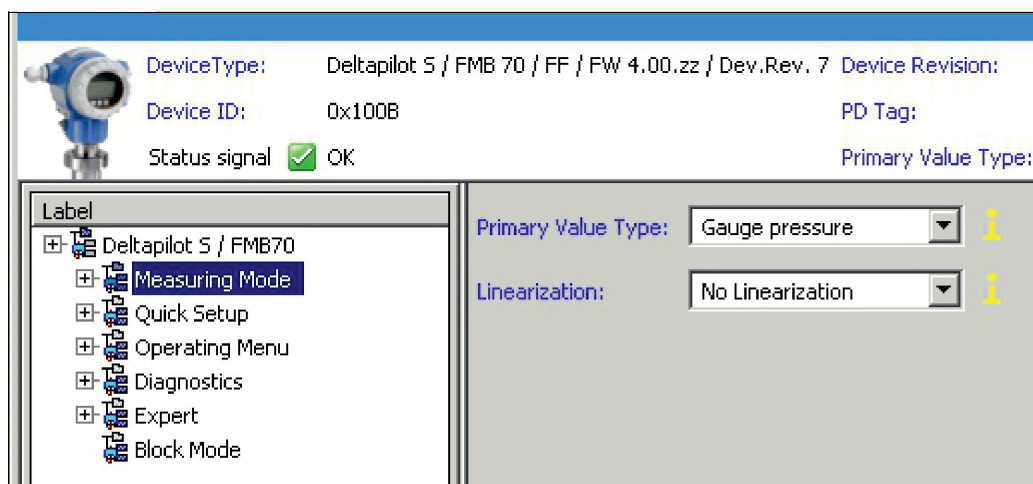

Fig. 17: "Measuring mode" menu

The following measuring mode settings are available:

Primary Value Type	Linearization	Level selection
Pressure	None	-
Level, mass, volume	None	Level Easy Pressure
Level, mass, volume	None	Level Easy Height
Level, mass, volume, tank content in %	None	Level Standard
Level, mass, volume, tank content in %	Level linearized	Level Standard
Level, mass, volume, tank content in %	Level combined	Level Standard

### Language, selection

Select the menu language for FieldCare using the "Language Button" in the configuration window. Select the menu language for the FieldCare frame by means of the "Extra" menu → "Options" → "Display" → "Language".

The following languages are available:

- Deutsch
- English
- Français
- Español
- Chinese
- Japanese

## 7.5 Position adjustment

Due to the orientation of the device, there may be a shift in the measured value, i.e. when the container is empty or partly filled, the measured value parameter does not display zero. There are two options to choose from when performing position adjustment.

- Onsite display menu path: GROUP SELECTION → OPERATING MENU → SETTINGS → POSITION ADJUSTMENT
- FieldCare menu path: OPERATING MENU → SETTINGS → POSITION ADJUSTMENT

### 7.5.1 Performing position adjustment via the onsite display or FieldCare

The parameters listed in the following table can be found in the POSITION ADJUSTMENT group (menu path: OPERATING MENU → SETTINGS → POSITION ADJUSTMENT).

Parameter name	Description
POS. ZERO ADJUST Entry	<p>Position adjustment – the pressure difference between zero (set point) and the measured pressure need not be known.</p> <p><b>Example:</b></p> <ul style="list-style-type: none"> <li>– MEASURED VALUE = 2.2 mbar (0.032 psi)</li> <li>– Correct the MEASURED VALUE via the POS. ZERO ADJUST parameter with the "Confirm" option. This means that you are assigning the value 0.0 to the pressure present.</li> <li>– MEASURED VALUE (after pos. zero adjust) = 0.0 mbar</li> </ul> <p>The CALIB. OFFSET parameter displays the resulting pressure difference (offset) by which the MEASURED VALUE was corrected.</p> <p><b>Factory setting:</b> 0.0</p>
POS. INPUT VALUE Input	<p>Position adjustment – the pressure difference between zero (set point) and the measured pressure need not be known. To correct the pressure difference, you need a reference measurement value (e. g. from a reference device).</p> <p><b>Example:</b></p> <ul style="list-style-type: none"> <li>– MEASURED VALUE = 0.5 mbar (0.0073 psi)</li> <li>– For the POS. INPUT VALUE parameter, specify the desired set point for the MEASURED VALUE, e.g. 2.0 mbar (0.029 psi). (The following applies: <math>\text{MEASURED VALUE}_{\text{new}} = \text{POS. INPUT VALUE}</math>)</li> <li>– MEASURED VALUE (after entry for POS. INPUT VALUE) = 2.0 mbar (0.029 psi)</li> <li>– The CALIB. OFFSET parameter displays the resulting pressure difference (offset) by which the MEASURED VALUE was corrected. The following applies: <math>\text{CALIB. OFFSET} = \text{MEASURED VALUE}_{\text{old}} - \text{POS. INPUT VALUE}</math>, here: <math>\text{CALIB. OFFSET} = 0.5 \text{ mbar (0.0073 psi)} - 2.0 \text{ mbar (0.029 psi)} = -1.5 \text{ mbar (0.022 psi)}</math>)</li> </ul> <p><b>Factory setting:</b> 0.0</p>
CALIB. OFFSET Entry	<p>Position adjustment – the pressure difference between zero (set point) and the measured pressure is known. (A reference pressure is not present at the device.)</p> <p><b>Example:</b></p> <ul style="list-style-type: none"> <li>– MEASURED VALUE = 2.2 mbar (0.032 psi)</li> <li>– Via the CALIB. OFFSET parameter, enter the value by which the MEASURED VALUE should be corrected. To correct the MEASURED VALUE to 0.0 mbar, you must enter the value 2.2 here. (The following applies: <math>\text{MEASURED VALUE}_{\text{new}} = \text{MEASURED VALUE}_{\text{old}} - \text{CALIB. OFFSET}</math>)</li> <li>– MEASURED VALUE (after entry for calib. offset) = 0.0 mbar</li> </ul> <p><b>Factory setting:</b> 0.0</p>

## 7.6 Level measurement

### 7.6.1 Information on level measurement

- A Quick Setup menu is available for each of the measuring modes Pressure and Level which guides you through the most important basic functions. → For the "Level" Quick Setup menu, see →  57.
- Furthermore, three level modes are available for the level measurement, namely "Level easy pressure", "Level easy height" and "Level standard". For the "Level standard" level mode, you can choose between the "Linear", "Pressure linearized" and "Height linearized" level types. The table in the "Overview of level measurement" section that follows provides you with an overview of the various measuring tasks.
  - With regard to the "Level easy pressure" and "Level easy height" level modes, the values entered are not tested as extensively as in the "Level standard" level mode. In the "Level easy pressure" and "Level easy height" level modes, the values entered for EMPTY CALIBRATION/FULL CALIBRATION, EMPTY PRESSURE/FULL PRESSURE and EMPTY HEIGHT/FULL HEIGHT have to be at least 1 % apart. If the values are too close together, the value is rejected and the system outputs a message. Other limit values are not checked, i.e. for the device to be able to perform correct measurement, the values entered have to suit the sensor and the measuring task.
  - The "Level easy pressure" and "Level easy height" level modes comprise fewer parameters than the "Level standard" mode and are used to quickly and easily configure a level application.
  - Customer-specific units of level, volume and mass, or a linearization table, can only be entered in the "Level standard" level mode.
- For a detailed description of the parameters and configuration examples, see Operating Instructions BA00303P "Cerabar S/Deltabar S/Deltapilot S, Description of Device Functions".

#### **WARNING**

#### **Changing the measuring mode affects the span (URV)!**

This situation can result in product overflow.

- ▶ If the measuring mode is changed, the span setting (URV) must be verified in the "CALIBRATION" → "BASIC SETUP" operating menu and, if necessary, reconfigured!

## 7.6.2 Overview of level measurement

Measuring task	LEVEL SELECTION/ LEVEL MODE	Measured variable selection	Description	Comment	Measured value display
The measured variable is in direct proportion to the measured pressure. Calibration takes place by entering two pressure-level pairs.	LEVEL SELECTION: Level easy pressure	Via the OUTPUT UNIT parameter: %, level, volume or mass units.	<ul style="list-style-type: none"> <li>- Calibration with reference pressure – wet calibration, see Operating Instructions BA00303P.</li> <li>- Calibration without reference pressure – dry calibration, see Operating Instructions BA00303P.</li> </ul>	<ul style="list-style-type: none"> <li>- Incorrect entries are possible</li> <li>- Customer-specific units are not possible</li> </ul>	The measured value display and the LEVEL BEFORE LIN. parameter show the measured value.
The measured variable is in direct proportion to the measured pressure. Calibration takes place by entering the density and two height-level pairs.	LEVEL SELECTION: Level easy height	Via the OUTPUT UNIT parameter: %, level, volume or mass units.	<ul style="list-style-type: none"> <li>- Calibration with reference pressure – wet calibration, see Operating Instructions BA00303P.</li> <li>- Calibration without reference pressure – dry calibration, see Operating Instructions BA00303P.</li> </ul>	<ul style="list-style-type: none"> <li>- Incorrect entries are possible</li> <li>- Customer-specific units are not possible</li> </ul>	The measured value display and the LEVEL BEFORE LIN. parameter show the measured value.
The measured variable is in direct proportion to the measured pressure.	LEVEL SELECTION: Level standard/ LEVEL MODE: Linear	Via the LINEAR MEASURAND parameter: <ul style="list-style-type: none"> <li>- % (level)</li> <li>- Level</li> <li>- Volume</li> <li>- Mass</li> </ul>	<ul style="list-style-type: none"> <li>- Calibration with reference pressure – wet calibration, see Operating Instructions BA00303P.</li> <li>- Calibration without reference pressure – dry calibration, see Operating Instructions BA00303P.</li> </ul>	<ul style="list-style-type: none"> <li>- Incorrect entries are denied by the device</li> <li>- Customer-specific units of level, volume and mass are possible</li> </ul>	The measured value display and the LEVEL BEFORE LIN. parameter show the measured value.
The measured variable is not in direct proportion to the measured pressure as is the case with tanks with a conical outlet, for example. A linearization table has to be entered for the calibration.	LEVEL SELECTION: level standard/ LEVEL MODE: pressure linearized	Via the LIND. MEASURAND parameter: <ul style="list-style-type: none"> <li>- Pressure + %</li> <li>- Pressure + volume</li> <li>- Pressure + mass</li> </ul>	<ul style="list-style-type: none"> <li>- Calibration with reference pressure: semiautomatic entry of linearization table, see Operating Instructions BA00303P.</li> <li>- Calibration without reference pressure: manual entry of linearization table, see Operating Instructions BA00303P.</li> </ul>	<ul style="list-style-type: none"> <li>- Incorrect entries are denied by the device</li> <li>- Customer-specific units of level, volume and mass are possible</li> </ul>	The measured value display and the TANK CONTENT parameter display the measured value.
<ul style="list-style-type: none"> <li>- Two measured variables are required or</li> <li>- the tank shape is given with value pairs, e.g. height and volume.</li> </ul> <p>The 1st measured variable % height or height must be in direct proportion to the measured pressure. The 2nd measured variable volume, mass or % must not be in direct proportion to the measured pressure. A linearization table has to be entered for the 2nd measured variable. The 2nd measured variable is assigned to the 1st measured variable by means of this table.</p>	LEVEL SELECTION: Level standard/ LEVEL MODE: Height linearized	Via the COMB. MEASURAND parameter: <ul style="list-style-type: none"> <li>- Height + volume</li> <li>- Height + mass</li> <li>- Height + %</li> <li>- %-height + volume</li> <li>- %-height + mass</li> <li>- %-height + %</li> </ul>	<ul style="list-style-type: none"> <li>- Calibration with reference pressure: wet calibration and semiautomatic entry of linearization table, see Operating Instructions BA00303P.</li> <li>- Calibration without reference pressure: dry calibration and manual entry of linearization table, see Operating Instructions BA00303P.</li> </ul>	<ul style="list-style-type: none"> <li>- Incorrect entries are denied by the device</li> <li>- Customer-specific units of level, volume and mass are possible</li> </ul>	<p>The measured value display and the TANK CONTENT parameter display the 2nd measured value (volume, mass or %).</p> <p>The LEVEL BEFORE LIN parameter displays the 1st measured value (%-height or height).</p>



### 7.6.3 Quick Setup menu for the Level measuring mode

- Some parameters are only displayed if other parameters are appropriately configured. For example, the EMPTY CALIBRATION parameter is only displayed in the following instances:
  - LEVEL SELECTION "Level easy pressure" and CALIBRATION MODE "Wet"
  - LEVEL SELECTION "Level standard", LEVEL MODE "Linear" and CALIBRATION MODE "Wet"
 The LEVEL MODE and CALIBRATION MODE parameters are in the BASIC SETUP function group.
- The following parameters are set to the following values at the factory:
  - LEVEL SELECTION: Level easy pressure
  - CALIBRATION MODE: Wet
  - OUTPUT UNIT or LIN. MEASURAND: %
  - EMPTY CALIBRATION: 0.0
  - FULL CALIBRATION: 100.0
- The Quick Setup is suitable for easy and quick commissioning. If you want to make more complex settings like changing the unit from "%" to "m", the calibration must be performed via the BASIC SETUP group. → See Operating Instructions BA00303P.

**▲ WARNING**

**Changing the measuring mode affects the span (URV)!**

This situation can result in product overflow.

- ▶ If the measuring mode is changed, the span setting (URV) must be verified in the "CALIBRATION" → "BASIC SETUP" operating menu and, if necessary, reconfigured!

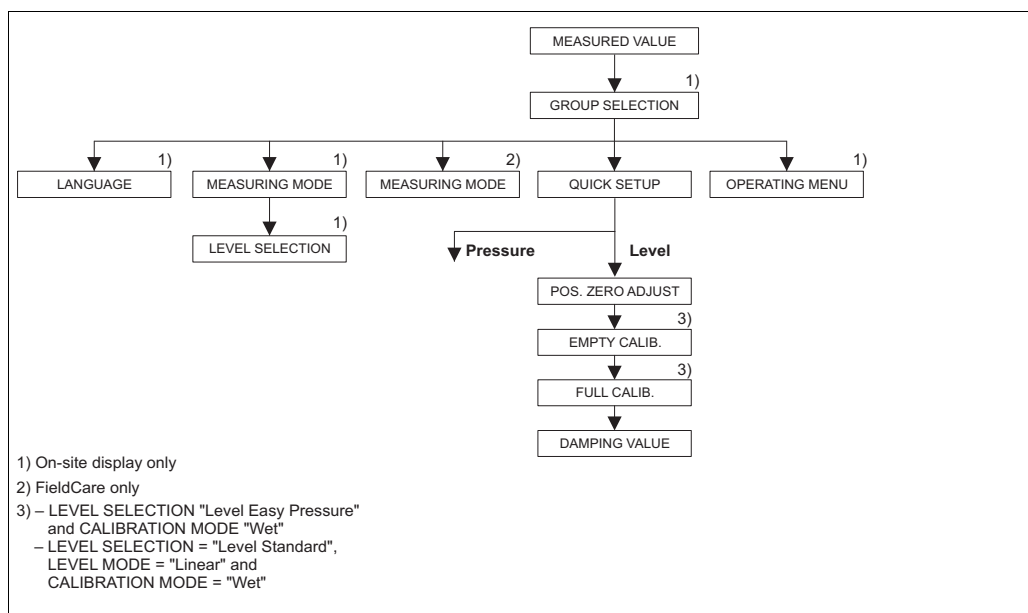

Fig. 18: Quick Setup menu for the "Level" measuring mode"

Local operation	FieldCare
<b>Measured value display</b> Switch from the measured value display to the GROUP SELECTION with F.	<b>Measured value display</b> Select QUICK SETUP menu.
<b>GROUP SELECTION</b> Select the MEASURING MODE.	<b>Measuring Mode</b> Select the Primary Value Type parameter.
MEASURING MODE Select "Level".	<b>Primary Value Type</b> Select "Level" option.
LEVEL SELECTION Select the level mode. For an overview, see → 56.	Level Selection Select the level mode. For an overview, see → 56.

Local operation	FieldCare
<b>GROUP SELECTION</b> Select QUICK SETUP menu.	
<b>POS. ZERO ADJUST</b> Due to orientation of the device, there may be a shift in the measured value. You correct the MEASURED VALUE via the POS. ZERO ADJUST parameter with the "Confirm" option, i.e. you assign the value 0.0 to the pressure present.	<b>POS. ZERO ADJUST</b> Due to orientation of the device, there may be a shift in the measured value. You correct the MEASURED VALUE via the POS. ZERO ADJUST parameter with the "Confirm" option, i.e. you assign the value 0.0 to the pressure present.
<b>EMPTY CALIB. <sup>1)</sup></b> Enter level value for the lower calibration point. For this parameter, enter a level value which is assigned to the pressure present at the device.	<b>EMPTY CALIBRATION <sup>1)</sup></b> Enter level value for the lower calibration point. For this parameter, enter a level value which is assigned to the pressure present at the device.
<b>FULL CALIBRATION <sup>1)</sup></b> Enter level value for the upper calibration point. For this parameter, enter a level value which is assigned to the pressure present at the device.	<b>FULL CALIBRATION <sup>1)</sup></b> Enter level value for the upper calibration point. For this parameter, enter a level value which is assigned to the pressure present at the device.
<b>DAMPING VALUE</b> Enter damping time (time constant $\tau$ ). The damping affects the speed at which all subsequent elements, such as the onsite display, measured value and OUT Value of the Analog Input Block react to a change in the pressure.	<b>DAMPING VALUE</b> Enter damping time (time constant $\tau$ ). The damping affects the speed at which all subsequent elements, such as the onsite display, measured value and OUT Value of the Analog Input Block react to a change in the pressure.

- 1)    - LEVEL SELECTION "Level easy pressure" and CALIBRATION MODE "Wet"  
       - LEVEL SELECTION "Level standard", LEVEL MODE "Linear" and CALIBRATION MODE "Wet"

For onsite operation, see also → [27](#), Section 6.2.3 "Function of the operating elements – onsite display connected" and → [40](#), Section 6.4 "Local operation – onsite display connected".

## 7.7 Pressure measurement

### 7.7.1 Information on pressure measurement

- A Quick Setup menu is available for each of the measuring modes Pressure and Level which guides you through the most important basic functions. With the setting in the MEASURING MODE parameter, you specify which Quick Setup menu should be displayed. See also Section 7.4 "Selecting the language and measuring mode".
- For a detailed description of the parameters, see Operating Instructions BA00303P "Cerabar S/Deltabar S/Deltapilot S, Description of Device Functions"
  - FF: Table, Pressure Transducer Block
  - FieldCare: Table, POSITION ADJUSTMENT
  - FieldCare: Table, BASIC SETUP
  - FieldCare: Table, EXTENDED SETUP

**▲ WARNING**

**Changing the measuring mode affects the span (URV)!**

This situation can result in product overflow.

- ▶ If the measuring mode is changed, the span setting (URV) must be verified in the "CALIBRATION" → "BASIC SETUP" operating menu and, if necessary, reconfigured!

### 7.7.2 Quick Setup menu for the Pressure measuring mode

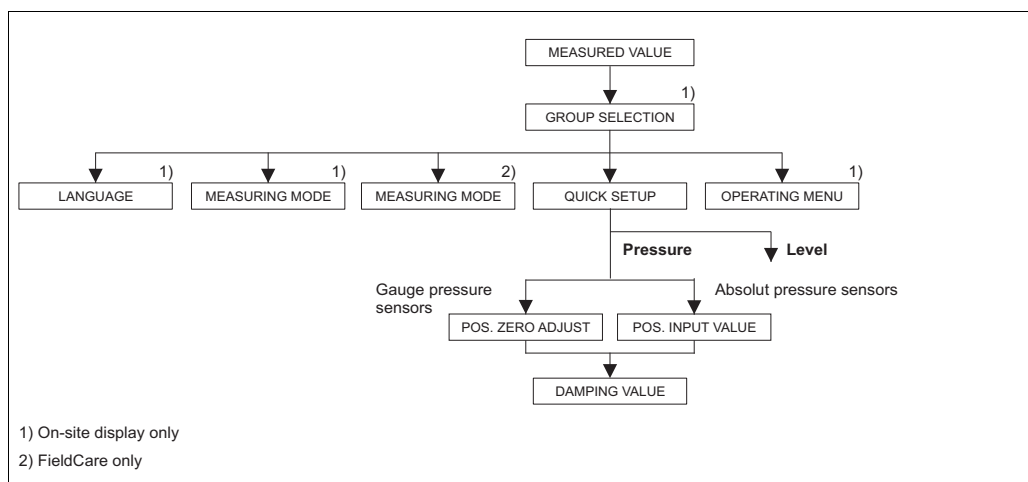

Fig. 19: Quick Setup menu for the "Pressure" measuring mode

Local operation	FieldCare
<b>Measured value display</b> Switch from the measured value display to the GROUP SELECTION with F.	<b>Measured value display</b> Select QUICK SETUP menu.
<b>GROUP SELECTION</b> Select the MEASURING MODE parameter.	<b>Measuring Mode</b> Select the Primary Value Type parameter.
MEASURING MODE Select "Pressure".	
<b>GROUP SELECTION</b> Select QUICK SETUP menu.	<b>Primary Value Type</b> Select "Pressure" option.
<b>POS. ZERO ADJUST</b> Due to orientation of the device, there may be a shift in the measured value. You correct the MEASURED VALUE via the POS. ZERO ADJUST parameter with the "Confirm" option, i.e. you assign the value 0.0 to the pressure present.	<b>POS. ZERO ADJUST</b> Due to orientation of the device, there may be a shift in the measured value. You correct the MEASURED VALUE via the POS. ZERO ADJUST parameter with the "Confirm" option, i.e. you assign the value 0.0 to the pressure present.

Local operation	FieldCare
<p><b>POS. INPUT VALUE</b> Due to orientation of the device, there may be a shift in the measured value. For the POS. INPUT VALUE parameter, specify the desired set point for the MEASURED VALUE.</p>	<p><b>POS. INPUT VALUE</b> Due to orientation of the device, there may be a shift in the measured value. For the POS. INPUT VALUE parameter, specify the desired set point for the MEASURED VALUE.</p>
<p><b>DAMPING VALUE</b> Enter damping time (time constant <math>\tau</math>). The damping affects the speed at which all subsequent elements, such as the onsite display, measured value and OUT Value of the Analog Input Block react to a change in the pressure.</p>	<p><b>DAMPING VALUE</b> Enter damping time (time constant <math>\tau</math>). The damping affects the speed at which all subsequent elements, such as the onsite display, measured value and OUT Value of the Analog Input Block react to a change in the pressure.</p>

For onsite operation, see also → [27](#), Section 6.2.3 "Function of the operating elements – onsite display connected" and → [40](#), Section 6.4 "Local operation – onsite display connected".

## 7.8 Scaling the OUT parameter

In the Analog Input Block, the input value or input range can be scaled in accordance with the automation requirements.

### Example:

The measuring range 0 to 500 mbar (0 to 7.5 psi) should be rescaled to 0 to 100 %.

- Select XD\_SCALE group.
  - For EU\_0, enter "0".
  - For EU\_100, enter "500".
  - For UNITS\_INDEX, enter "mbar".
- Select OUT\_SCALE group.
  - For EU\_0, enter "0".
  - For EU\_100, enter "10000".
  - For UNITS\_INDEX, select "%" for example.

The unit selected here does not have any effect on the scaling. This unit is not displayed on the onsite display or in the operating program such as FieldCare.

### Result:

At a pressure of 350 mbar (5.25 psi), the value 70 is output to a downstream block or to the PCS as the OUT value.

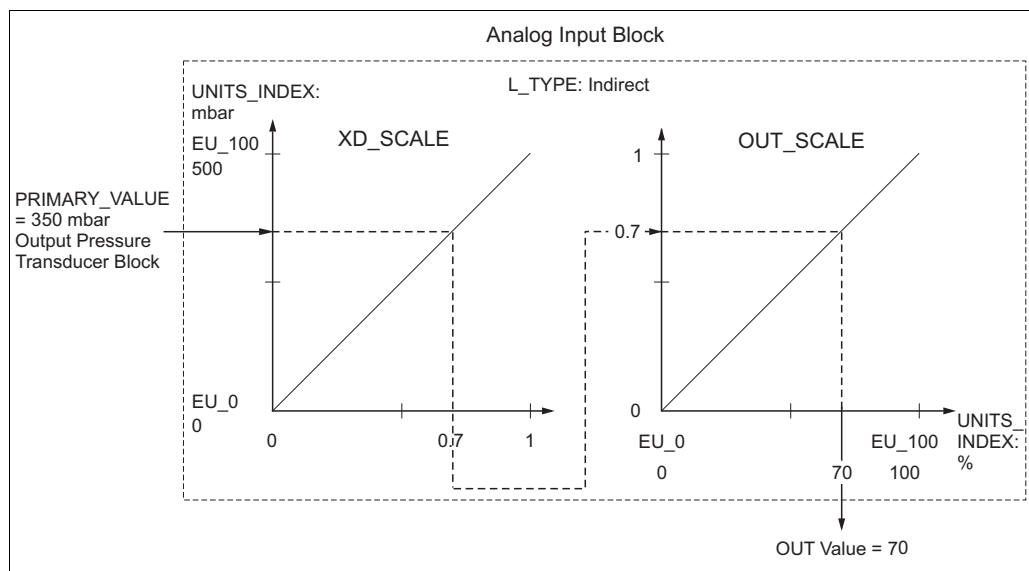

P01-xMx7xxxx-05-xx-xx-en-008

### ⚠ CAUTION

#### Note Dependencies when setting parameters!

- ▶ If you have selected the "Direct" mode for the L\_TYPE parameter, you cannot change the values and units for XD\_SCALE and OUT\_SCALE.
- ▶ The L\_TYPE, XD\_SCALE and OUT\_SCALE parameters can only be changed in the OOS block mode.
- ▶ Make sure that the output scaling of the Pressure Transducer Block SCALE\_OUT matches the input scaling of the Analog Input Block XD\_SCALE.

## 7.9 Configuring event behavior in accordance with FOUNDATION Fieldbus Specification FF912 Field Diagnostic Profile

The device complies with FOUNDATION Fieldbus Specification FF912. Among other things, this means that:

- The diagnostic category according to NAMUR Recommendation NE107 is transmitted via the fieldbus in a format that is independent of the manufacturer:
  - F: Failure
  - C: Function check
  - S: Out of specification
  - M: Maintenance required
- The user can change the diagnostic category of the event groups specified in accordance with the requirements of the particular application.
- Certain events can be separated from their group and handled separately:
  - e.g. 115: Sensor overpressure
  - e.g. 715: Sensor over temperature
- Additional information and troubleshooting measures are transmitted with the event message via the fieldbus.

### 7.9.1 Event groups

The diagnostic events are divided into 16 groups, depending on the source and the severity of the event. A default event category is assigned to each group at the factory. One bit of the assignment parameters belongs to every event group.

Event severity	Default event category	Event source	Bit	Events in this group
Highest severity	Failure (F)	Sensor	31	<ul style="list-style-type: none"> <li>■ 122: F&gt;Sensor not connected</li> <li>■ 716: F&gt;Process isolating diaphragm broken</li> </ul>
		Electronics	30	<ul style="list-style-type: none"> <li>■ 110: F&gt;Checksum error in EEPROM: configuration segment</li> <li>■ 113: F&gt;ROM failure in transmitter electronic</li> <li>■ 121: F&gt;Checksum error in factory segment of EEPROM</li> <li>■ 130: F&gt;EEPROM is defect.</li> <li>■ 131: F&gt;Checksum error in EEPROM: min/max segment</li> <li>■ 133: F&gt;Checksum error in History EEPROM</li> <li>■ 135: F&gt;Checksum error in EEPROM FF segment</li> <li>■ 728: F&gt;RAM error</li> <li>■ 729: F&gt;RAM error</li> <li>■ 736: F&gt;RAM error</li> </ul>
		Configuration	29	<ul style="list-style-type: none"> <li>■ Not used</li> </ul>
		Process	28	<ul style="list-style-type: none"> <li>■ Not used</li> </ul>

Event severity	Default event category	Event source	Bit	Events in this group
High severity	Check (C)	Sensor	27	<ul style="list-style-type: none"> <li>■ 101: C&gt;Sensor electronic EEPROM error</li> <li>■ 725: C&gt;Sensor connection error, cycle disturbance</li> <li>■ 747: C&gt;Sensor software not compatible to electronics</li> </ul>
		Electronics	26	<ul style="list-style-type: none"> <li>■ 703: C&gt;Measurement error</li> <li>■ 704: C&gt;Measurement error</li> <li>■ 705: C&gt;Measurement error</li> <li>■ 737: C&gt;Measurement error</li> <li>■ 738: C&gt;Measurement error</li> <li>■ 739: C&gt;Measurement error</li> <li>■ 742: C&gt;Sensor connection error (upload)</li> <li>■ 743: C&gt;Electronic PCB error during initialization</li> <li>■ 744: C&gt;Main electronic PCB error</li> <li>■ 746: C&gt;Sensor connection error - initializing</li> <li>■ 748: C&gt;Memory failure in signal processor</li> </ul>
		Configuration	25	<ul style="list-style-type: none"> <li>■ 106: C&gt;Downloading - please wait</li> <li>■ 613: C&gt;Simulation active</li> </ul>
		Process	24	<ul style="list-style-type: none"> <li>■ Not used</li> </ul>

Event severity	Default event category	Event source	Bit	Events in this group
Low severity	Out of specification (S)	Sensor	23	<ul style="list-style-type: none"> <li>■ 115: S&gt;Sensor overpressure</li> <li>■ 120: S&gt;Sensor low pressure</li> <li>■ 715: S&gt;Sensor over temperature</li> <li>■ 720: S&gt;Sensor under temperature</li> <li>■ 726: S&gt;Sensor temperature error - overrange</li> </ul>
		Electronics	22	<ul style="list-style-type: none"> <li>■ 717: S&gt;Transmitter over temperature</li> <li>■ 718: S&gt;Transmitter under temperature</li> </ul>
		Configuration	21	<ul style="list-style-type: none"> <li>■ 701: S&gt;Adjustment outside sensor nominal range</li> <li>■ 710: S&gt;Set span too small. Not allowed.</li> <li>■ 727: S&gt;Sensor pressure error - overrange</li> </ul>
		Process	20	<ul style="list-style-type: none"> <li>■ 740: S&gt;Calculation overflow, bad configuration</li> </ul>

Event severity	Default event category	Event source	Bit	Events in this group
Lowest severity	Maintenance required (M)	Sensor	19	<ul style="list-style-type: none"> <li>▪ 745: M&gt;Sensor data unknown</li> </ul>
		Electronics	18	<ul style="list-style-type: none"> <li>▪ 134: M&gt;EEPROM lifetime WARNING</li> <li>▪ 700: M&gt;Last configuration not stored</li> <li>▪ 702: M&gt;HistoROM data not consistent</li> </ul>
		Configuration	17	<ul style="list-style-type: none"> <li>▪ 116: M&gt;Download error, repeat download</li> <li>▪ 602: M&gt;Linearization curve not monoton</li> <li>▪ 604: M&gt;Linearization table invalid. Min. 2 points.</li> <li>▪ 706: M&gt;Configuration in HistoROM and device not identical.</li> <li>▪ 707: M&gt;X-VAL. (TAB_XY_VALUE) of lin. table out of edit limits</li> <li>▪ 711: M&gt;LRV or URV out of edit limits</li> <li>▪ 713: M&gt;100% POINT (LEVEL_100_PERCENT_VALUE) level out of edit limits</li> <li>▪ 719: M&gt;Y-VALUE (TAB_XY_VALUE) of lin. table out of edit limits</li> <li>▪ 721: M&gt;ZERO POSITION (LEVEL_OFFSET) level out of edit limits</li> <li>▪ 722: M&gt;EMPTY CALIB. (SCALE_OUT, EU_0) or FULL CALIB. (SCALE_OUT, EU_100) out of edit limits</li> <li>▪ 741: M&gt;TANK HEIGHT (LEVEL_TANK_HEIGHT) out of edit limits</li> <li>▪ 750: M&gt;Configuration not permitted</li> </ul>
		Process	16	<ul style="list-style-type: none"> <li>▪ 730: M&gt;Pmin ALARM WINDOW (PRESSURE_1_USER_LOW_LIMIT) undershot</li> <li>▪ 731: M&gt;Pmax ALARM WINDOW (PRESSURE_1_USER_HIGH_LIMIT) overshoot</li> <li>▪ 732: M&gt;Tmin ALARM WINDOW (TEMPERATURE_1_USER_LOW_LIMIT) undershot</li> <li>▪ 733: M&gt;Tmax ALARM WINDOW (TEMPERATURE_1_USER_HIGH_LIMIT) overshoot</li> </ul>

## 7.9.2 Assignment parameters

The event categories are assigned to the event groups via four assignment parameters. These parameters are located in the **RESOURCE (RB2)** Block:

- **FD\_FAIL\_MAP**: for event category **Failure (F)**
- **FD\_CHECK\_MAP**: for event category **Check (C)**
- **FD\_OFFSPEC\_MAP**: for event category **Out of Specification (S)**
- **FD\_MAINT\_MAP**: for event category **Maintenance Required (M)**

Each of these parameters comprises 32 bits with the following meaning:

- **Bit 0**: reserved by the Fieldbus Foundation. Is also set if 1 TRD is not in the AUTO mode.
- **Bits 1 to 15**: configurable area; certain diagnostic events can be assigned here irrespective of the event group they are in. They are not excluded from the event group and their behavior can be configured individually (→ [67](#)). In the case of Deltabar S, the following events can be assigned to the configurable area:
  - e.g. 115: Sensor overpressure
  - e.g. 715: Sensor over temperature
- **Bits 16 to 31**: standard area; these bits are permanently assigned to the event groups. If the bit is set to **1** this event group is assigned to the particular event category.

The factory setting of the assignment parameters is indicated in the following table. In the factory setting, there is a clear assignment between the event severity and the event category (e.g. the assignment parameter).



Factory setting of assignment parameters

Event severity	Standard area																Configurable area
	Highest severity				High severity				Low severity				Lowest severity				
Event source <sup>1)</sup>	S	E	C	P	S	E	C	P	S	E	C	P	S	E	C	P	
Bit	31	30	29	28	27	26	25	24	23	22	21	20	19	18	17	16	15...1
FD_FAIL_MAP	1	1	1	1	0	0	0	0	0	0	0	0	0	0	0	0	0
FD_CHECK_MAP	0	0	0	0	1	1	1	1	0	0	0	0	0	0	0	0	0
FD_OFFSPEC_MAP	0	0	0	0	0	0	0	0	1	1	1	1	0	0	0	0	0
FD_MAINT_MAP	0	0	0	0	0	0	0	0	0	0	0	0	1	1	1	1	0

1) S: Sensor; E: Electronics; C: Configuration; P: Process

Proceed as follows to change the diagnostic behavior of an event group:

1. Open the assignment parameter to which the group is currently assigned.
2. Change the bit of the event group from **1** to **0**. If using FieldCare, this is done via the FF912 module by disabling the appropriate check box (see the following example).
3. Open the assignment parameter to which the group should be assigned.
4. Change the bit of the event group from **0** to **1**. If using FieldCare, this is done via by enabling the appropriate check box (see the following example).

**Example**

The **Highest Severity / Electronics** group contains the events **131: Checksum error in EEPROM: min/max segment, among others**. These should no longer be categorized as **Failure (F)**, and should be categorized as **Check (C)** instead.

1. In the FieldCare navigation window navigate to **Expert → Field Device Diagnostic → Configuration**

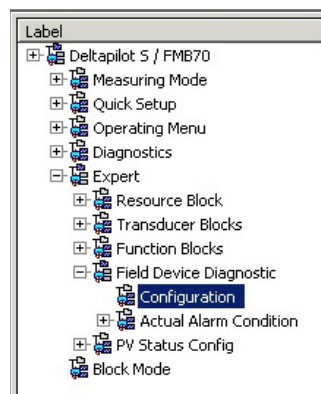

- In the **Failure** column search for the **Highest Severity Electronic** group and disable the associated check box (A). Enable the appropriate check box in the **Function** column (B). Please note that the "Accept" button must be pressed to confirm each entry.

Standard Area		Configurable Area		Status 1	Status 2	Simulation	Failure		Function Check		Out of Specification		Maintenance Required	
											Priority 0		Priority 0	
Bit#	Diagnostic Event	enable	mask				enable	mask	enable	mask	enable	mask	enable	mask
31	Highest Severity Sensor	<input checked="" type="checkbox"/>	<input type="checkbox"/>				<input type="checkbox"/>	<input type="checkbox"/>	<input type="checkbox"/>	<input type="checkbox"/>	<input type="checkbox"/>	<input type="checkbox"/>	<input type="checkbox"/>	<input type="checkbox"/>
30	Highest Severity Electronic	<input checked="" type="checkbox"/> (A)	<input type="checkbox"/>				<input type="checkbox"/> (B)	<input type="checkbox"/>	<input type="checkbox"/>	<input type="checkbox"/>	<input type="checkbox"/>	<input type="checkbox"/>	<input type="checkbox"/>	<input type="checkbox"/>
29	Highest Severity Configuration	<input checked="" type="checkbox"/>	<input type="checkbox"/>				<input type="checkbox"/>	<input type="checkbox"/>	<input type="checkbox"/>	<input type="checkbox"/>	<input type="checkbox"/>	<input type="checkbox"/>	<input type="checkbox"/>	<input type="checkbox"/>
28	Highest Severity Process	<input checked="" type="checkbox"/>	<input type="checkbox"/>				<input type="checkbox"/>	<input type="checkbox"/>	<input type="checkbox"/>	<input type="checkbox"/>	<input type="checkbox"/>	<input type="checkbox"/>	<input type="checkbox"/>	<input type="checkbox"/>
27	High Severity Sensor	<input type="checkbox"/>	<input type="checkbox"/>				<input checked="" type="checkbox"/>	<input type="checkbox"/>	<input type="checkbox"/>	<input type="checkbox"/>	<input type="checkbox"/>	<input type="checkbox"/>	<input type="checkbox"/>	<input type="checkbox"/>
26	High Severity Electronic	<input type="checkbox"/>	<input type="checkbox"/>				<input checked="" type="checkbox"/>	<input type="checkbox"/>	<input type="checkbox"/>	<input type="checkbox"/>	<input type="checkbox"/>	<input type="checkbox"/>	<input type="checkbox"/>	<input type="checkbox"/>
25	High Severity Configuration	<input type="checkbox"/>	<input type="checkbox"/>				<input checked="" type="checkbox"/>	<input type="checkbox"/>	<input type="checkbox"/>	<input type="checkbox"/>	<input type="checkbox"/>	<input type="checkbox"/>	<input type="checkbox"/>	<input type="checkbox"/>
24	High Severity Process	<input type="checkbox"/>	<input type="checkbox"/>				<input checked="" type="checkbox"/>	<input type="checkbox"/>	<input type="checkbox"/>	<input type="checkbox"/>	<input type="checkbox"/>	<input type="checkbox"/>	<input type="checkbox"/>	<input type="checkbox"/>
23	Low Severity Sensor	<input type="checkbox"/>	<input type="checkbox"/>				<input type="checkbox"/>	<input type="checkbox"/>	<input checked="" type="checkbox"/>	<input type="checkbox"/>	<input type="checkbox"/>	<input type="checkbox"/>	<input type="checkbox"/>	<input type="checkbox"/>
22	Low Severity Electronic	<input type="checkbox"/>	<input type="checkbox"/>				<input type="checkbox"/>	<input type="checkbox"/>	<input checked="" type="checkbox"/>	<input type="checkbox"/>	<input type="checkbox"/>	<input type="checkbox"/>	<input type="checkbox"/>	<input type="checkbox"/>
21	Low Severity Configuration	<input type="checkbox"/>	<input type="checkbox"/>				<input type="checkbox"/>	<input type="checkbox"/>	<input checked="" type="checkbox"/>	<input type="checkbox"/>	<input type="checkbox"/>	<input type="checkbox"/>	<input type="checkbox"/>	<input type="checkbox"/>
20	Low Severity Process	<input type="checkbox"/>	<input type="checkbox"/>				<input type="checkbox"/>	<input type="checkbox"/>	<input checked="" type="checkbox"/>	<input type="checkbox"/>	<input type="checkbox"/>	<input type="checkbox"/>	<input type="checkbox"/>	<input type="checkbox"/>
19	Lowest Severity Sensor	<input type="checkbox"/>	<input type="checkbox"/>				<input type="checkbox"/>	<input type="checkbox"/>	<input type="checkbox"/>	<input type="checkbox"/>	<input checked="" type="checkbox"/>	<input type="checkbox"/>	<input type="checkbox"/>	<input type="checkbox"/>
18	Lowest Severity Electronic	<input type="checkbox"/>	<input type="checkbox"/>				<input type="checkbox"/>	<input type="checkbox"/>	<input type="checkbox"/>	<input type="checkbox"/>	<input checked="" type="checkbox"/>	<input type="checkbox"/>	<input type="checkbox"/>	<input type="checkbox"/>
17	Lowest Severity Configuration	<input type="checkbox"/>	<input type="checkbox"/>				<input type="checkbox"/>	<input type="checkbox"/>	<input type="checkbox"/>	<input type="checkbox"/>	<input checked="" type="checkbox"/>	<input type="checkbox"/>	<input type="checkbox"/>	<input type="checkbox"/>
16	Lowest Severity Process	<input type="checkbox"/>	<input type="checkbox"/>				<input type="checkbox"/>	<input type="checkbox"/>	<input type="checkbox"/>	<input type="checkbox"/>	<input checked="" type="checkbox"/>	<input type="checkbox"/>	<input type="checkbox"/>	<input type="checkbox"/>

It must be ensured that the appropriate bit is set in at least one of the assignment parameters for each event group. Otherwise a category is not transmitted with the event via the bus. The control system will therefore generally ignore the presence of the event. The detection of diagnostic events and the transmission of the messages on the bus is configured on the FieldCare page **Expert → Field Device Diagnostic → Configuration**. The "Mask" column is used for the transmission of the message on the bus. It must be noted that device messages can still be transmitted by polling the active bits in Status 1 and 2. The mask check box acts as a negative check box, i.e. if a field is selected the associated events are not transmitted on the bus. The Resource Block must be set to the **Auto** mode to transmit status information on the bus.

### 7.9.3 Configurable area

The event category can be individually defined for the following events - irrespective of the event group to which they are assigned in the factory setting:

- **115:** Sensor overpressure
- **120:** Sensor low pressure
- **715:** Sensor over temperature
- **717:** Transmitter over temperature
- **718:** Transmitter under temperature
- **720:** Sensor under temperature
- **726:** Sensor temperature error-overrange
- **727:** Sensor pressure error-overrange
- **730:** LRV user limits exceeded
- **731:** URV user limits exceeded
- **732:** LRV-Temp. user limits exceeded
- **733:** URV-Temp. user limits exceeded
- **740:** Calculation Overflow, bad configuration

To change the event category, the event must first be assigned to one of the bits 1 to 15. The **FF912ConfigArea\_1** to **FF912ConfigArea\_15** parameters in the **DIAGNOSTIC (TRDDIAG)** Block are used for this purpose. The appropriate bit can then be set from **0** to **1** in the desired assignment parameter.

#### Example

Error **115 "Sensor overpressure"** should no longer be categorized as **Out of Specification (S)**, and should be categorized as **Function (C)** instead.

1. In the FieldCare navigation window navigate to **Expert → Field Device Diagnostic → Configuration**.

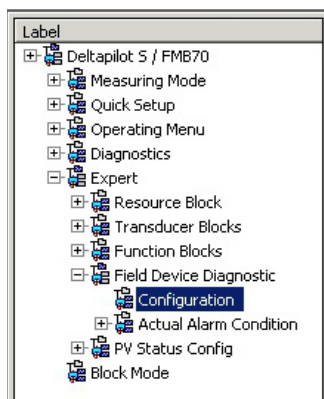

- Select the "Configurable area" tab. In the factory setting, all the bits in the **Configurable Area Bits** column have the value **not assigned** (A).

Standard Area		Configurable Area	Status 1	Status 2	Simulation	Failure		Function Check		Out of Specification		Maintenance Required	
Bit#	Diagnostic Event	(A) (B)	enable	mask	enable	mask	enable	mask	enable	mask	enable	mask	
15	not assigned	(A) (B)	<input type="checkbox"/>	<input type="checkbox"/>	<input type="checkbox"/>	<input type="checkbox"/>	<input type="checkbox"/>	<input type="checkbox"/>	<input type="checkbox"/>	<input type="checkbox"/>	<input type="checkbox"/>	<input type="checkbox"/>	
14	not assigned		<input type="checkbox"/>	<input type="checkbox"/>	<input type="checkbox"/>	<input type="checkbox"/>	<input type="checkbox"/>	<input type="checkbox"/>	<input type="checkbox"/>	<input type="checkbox"/>	<input type="checkbox"/>	<input type="checkbox"/>	
13	not assigned		<input type="checkbox"/>	<input type="checkbox"/>	<input type="checkbox"/>	<input type="checkbox"/>	<input type="checkbox"/>	<input type="checkbox"/>	<input type="checkbox"/>	<input type="checkbox"/>	<input type="checkbox"/>	<input type="checkbox"/>	
12	not assigned		<input type="checkbox"/>	<input type="checkbox"/>	<input type="checkbox"/>	<input type="checkbox"/>	<input type="checkbox"/>	<input type="checkbox"/>	<input type="checkbox"/>	<input type="checkbox"/>	<input type="checkbox"/>	<input type="checkbox"/>	
11	not assigned		<input type="checkbox"/>	<input type="checkbox"/>	<input type="checkbox"/>	<input type="checkbox"/>	<input type="checkbox"/>	<input type="checkbox"/>	<input type="checkbox"/>	<input type="checkbox"/>	<input type="checkbox"/>	<input type="checkbox"/>	
10	not assigned		<input type="checkbox"/>	<input type="checkbox"/>	<input type="checkbox"/>	<input type="checkbox"/>	<input type="checkbox"/>	<input type="checkbox"/>	<input type="checkbox"/>	<input type="checkbox"/>	<input type="checkbox"/>	<input type="checkbox"/>	
9	not assigned		<input type="checkbox"/>	<input type="checkbox"/>	<input type="checkbox"/>	<input type="checkbox"/>	<input type="checkbox"/>	<input type="checkbox"/>	<input type="checkbox"/>	<input type="checkbox"/>	<input type="checkbox"/>	<input type="checkbox"/>	
8	not assigned		<input type="checkbox"/>	<input type="checkbox"/>	<input type="checkbox"/>	<input type="checkbox"/>	<input type="checkbox"/>	<input type="checkbox"/>	<input type="checkbox"/>	<input type="checkbox"/>	<input type="checkbox"/>	<input type="checkbox"/>	
7	not assigned		<input type="checkbox"/>	<input type="checkbox"/>	<input type="checkbox"/>	<input type="checkbox"/>	<input type="checkbox"/>	<input type="checkbox"/>	<input type="checkbox"/>	<input type="checkbox"/>	<input type="checkbox"/>	<input type="checkbox"/>	
6	not assigned		<input type="checkbox"/>	<input type="checkbox"/>	<input type="checkbox"/>	<input type="checkbox"/>	<input type="checkbox"/>	<input type="checkbox"/>	<input type="checkbox"/>	<input type="checkbox"/>	<input type="checkbox"/>	<input type="checkbox"/>	
5	not assigned		<input type="checkbox"/>	<input type="checkbox"/>	<input type="checkbox"/>	<input type="checkbox"/>	<input type="checkbox"/>	<input type="checkbox"/>	<input type="checkbox"/>	<input type="checkbox"/>	<input type="checkbox"/>	<input type="checkbox"/>	
4	not assigned		<input type="checkbox"/>	<input type="checkbox"/>	<input type="checkbox"/>	<input type="checkbox"/>	<input type="checkbox"/>	<input type="checkbox"/>	<input type="checkbox"/>	<input type="checkbox"/>	<input type="checkbox"/>	<input type="checkbox"/>	
3	not assigned		<input type="checkbox"/>	<input type="checkbox"/>	<input type="checkbox"/>	<input type="checkbox"/>	<input type="checkbox"/>	<input type="checkbox"/>	<input type="checkbox"/>	<input type="checkbox"/>	<input type="checkbox"/>	<input type="checkbox"/>	
2	not assigned		<input type="checkbox"/>	<input type="checkbox"/>	<input type="checkbox"/>	<input type="checkbox"/>	<input type="checkbox"/>	<input type="checkbox"/>	<input type="checkbox"/>	<input type="checkbox"/>	<input type="checkbox"/>	<input type="checkbox"/>	
1	not assigned		<input type="checkbox"/>	<input type="checkbox"/>	<input type="checkbox"/>	<input type="checkbox"/>	<input type="checkbox"/>	<input type="checkbox"/>	<input type="checkbox"/>	<input type="checkbox"/>	<input type="checkbox"/>	<input type="checkbox"/>	

- Select one of these bits (here **Configurable Area Bit 15**, for instance) and select the **Sensor overpressure** (B) option from the associated picklist. Confirm your choice by pressing "Accept".
- Enable the check box for the bit concerned (here: **Configurable Area Bit 15**) (C). Confirm your choice by pressing "Accept".

**Additional information:**

The "Status 1" and "Status 2" tabs indicate whether an event is active.

Standard Area		Configurable Area	Status 1	Status 2	Simulation	Failure		Function Check		Out of Specification		Maintenance Required	
Bit#	Diagnostic Event		active	active	active	active	active	active	active	active	active	active	
31	Highest Severity Sensor		<input type="checkbox"/>	<input type="checkbox"/>	<input type="checkbox"/>	<input type="checkbox"/>	<input type="checkbox"/>	<input type="checkbox"/>	<input type="checkbox"/>	<input type="checkbox"/>	<input type="checkbox"/>	<input type="checkbox"/>	
30	Highest Severity Electronic		<input type="checkbox"/>	<input type="checkbox"/>	<input type="checkbox"/>	<input type="checkbox"/>	<input type="checkbox"/>	<input type="checkbox"/>	<input type="checkbox"/>	<input type="checkbox"/>	<input type="checkbox"/>	<input type="checkbox"/>	
29	Highest Severity Configuration		<input type="checkbox"/>	<input type="checkbox"/>	<input type="checkbox"/>	<input type="checkbox"/>	<input type="checkbox"/>	<input type="checkbox"/>	<input type="checkbox"/>	<input type="checkbox"/>	<input type="checkbox"/>	<input type="checkbox"/>	
28	Highest Severity Process		<input type="checkbox"/>	<input type="checkbox"/>	<input type="checkbox"/>	<input type="checkbox"/>	<input type="checkbox"/>	<input type="checkbox"/>	<input type="checkbox"/>	<input type="checkbox"/>	<input type="checkbox"/>	<input type="checkbox"/>	
27	High Severity Sensor		<input type="checkbox"/>	<input type="checkbox"/>	<input type="checkbox"/>	<input type="checkbox"/>	<input type="checkbox"/>	<input type="checkbox"/>	<input type="checkbox"/>	<input type="checkbox"/>	<input type="checkbox"/>	<input type="checkbox"/>	
26	High Severity Electronic		<input type="checkbox"/>	<input type="checkbox"/>	<input type="checkbox"/>	<input type="checkbox"/>	<input type="checkbox"/>	<input type="checkbox"/>	<input type="checkbox"/>	<input type="checkbox"/>	<input type="checkbox"/>	<input type="checkbox"/>	
25	High Severity Configuration		<input type="checkbox"/>	<input type="checkbox"/>	<input type="checkbox"/>	<input type="checkbox"/>	<input type="checkbox"/>	<input type="checkbox"/>	<input type="checkbox"/>	<input type="checkbox"/>	<input type="checkbox"/>	<input type="checkbox"/>	
24	High Severity Process		<input type="checkbox"/>	<input type="checkbox"/>	<input type="checkbox"/>	<input type="checkbox"/>	<input type="checkbox"/>	<input type="checkbox"/>	<input type="checkbox"/>	<input type="checkbox"/>	<input type="checkbox"/>	<input type="checkbox"/>	
23	Low Severity Sensor		<input type="checkbox"/>	<input type="checkbox"/>	<input type="checkbox"/>	<input type="checkbox"/>	<input type="checkbox"/>	<input type="checkbox"/>	<input type="checkbox"/>	<input type="checkbox"/>	<input type="checkbox"/>	<input type="checkbox"/>	
22	Low Severity Electronic		<input type="checkbox"/>	<input type="checkbox"/>	<input type="checkbox"/>	<input type="checkbox"/>	<input type="checkbox"/>	<input type="checkbox"/>	<input type="checkbox"/>	<input type="checkbox"/>	<input type="checkbox"/>	<input type="checkbox"/>	
21	Low Severity Configuration		<input type="checkbox"/>	<input type="checkbox"/>	<input type="checkbox"/>	<input type="checkbox"/>	<input type="checkbox"/>	<input type="checkbox"/>	<input type="checkbox"/>	<input type="checkbox"/>	<input type="checkbox"/>	<input type="checkbox"/>	
20	Low Severity Process		<input type="checkbox"/>	<input type="checkbox"/>	<input type="checkbox"/>	<input type="checkbox"/>	<input type="checkbox"/>	<input type="checkbox"/>	<input type="checkbox"/>	<input type="checkbox"/>	<input type="checkbox"/>	<input type="checkbox"/>	
19	Lowest Severity Sensor		<input type="checkbox"/>	<input type="checkbox"/>	<input type="checkbox"/>	<input type="checkbox"/>	<input type="checkbox"/>	<input type="checkbox"/>	<input type="checkbox"/>	<input type="checkbox"/>	<input type="checkbox"/>	<input type="checkbox"/>	
18	Lowest Severity Electronic		<input type="checkbox"/>	<input type="checkbox"/>	<input type="checkbox"/>	<input type="checkbox"/>	<input type="checkbox"/>	<input type="checkbox"/>	<input type="checkbox"/>	<input type="checkbox"/>	<input type="checkbox"/>	<input type="checkbox"/>	
17	Lowest Severity Configuration		<input type="checkbox"/>	<input type="checkbox"/>	<input type="checkbox"/>	<input type="checkbox"/>	<input type="checkbox"/>	<input type="checkbox"/>	<input type="checkbox"/>	<input type="checkbox"/>	<input type="checkbox"/>	<input type="checkbox"/>	
16	Lowest Severity Process		<input type="checkbox"/>	<input type="checkbox"/>	<input type="checkbox"/>	<input type="checkbox"/>	<input type="checkbox"/>	<input type="checkbox"/>	<input type="checkbox"/>	<input type="checkbox"/>	<input type="checkbox"/>	<input type="checkbox"/>	

Changing the error category for **Sensor overpressure** does not affect an error that already exists. The new category is only assigned if this error occurs again after the change has been made. The "Status 1" and "Status 2" tabs indicate whether an event is active.

Standard Area		Configurable Area		Status 1	Status 2	Simulation			
						Failure 	Function Check 	Out of Specification 	Maintenance Required 
Bit#	Diagnostic Event			active		active		active	
15	not assigned			<input type="checkbox"/>		<input type="checkbox"/>	<input type="checkbox"/>	<input type="checkbox"/>	<input type="checkbox"/>
14	not assigned			<input type="checkbox"/>		<input type="checkbox"/>	<input type="checkbox"/>	<input type="checkbox"/>	<input type="checkbox"/>
13	not assigned			<input type="checkbox"/>		<input type="checkbox"/>	<input type="checkbox"/>	<input type="checkbox"/>	<input type="checkbox"/>
12	not assigned			<input type="checkbox"/>		<input type="checkbox"/>	<input type="checkbox"/>	<input type="checkbox"/>	<input type="checkbox"/>
11	not assigned			<input type="checkbox"/>		<input type="checkbox"/>	<input type="checkbox"/>	<input type="checkbox"/>	<input type="checkbox"/>
10	not assigned			<input type="checkbox"/>		<input type="checkbox"/>	<input type="checkbox"/>	<input type="checkbox"/>	<input type="checkbox"/>
9	not assigned			<input type="checkbox"/>		<input type="checkbox"/>	<input type="checkbox"/>	<input type="checkbox"/>	<input type="checkbox"/>
8	not assigned			<input type="checkbox"/>		<input type="checkbox"/>	<input type="checkbox"/>	<input type="checkbox"/>	<input type="checkbox"/>
7	not assigned			<input type="checkbox"/>		<input type="checkbox"/>	<input type="checkbox"/>	<input type="checkbox"/>	<input type="checkbox"/>
6	not assigned			<input type="checkbox"/>		<input type="checkbox"/>	<input type="checkbox"/>	<input type="checkbox"/>	<input type="checkbox"/>
5	not assigned			<input type="checkbox"/>		<input type="checkbox"/>	<input type="checkbox"/>	<input type="checkbox"/>	<input type="checkbox"/>
4	not assigned			<input type="checkbox"/>		<input type="checkbox"/>	<input type="checkbox"/>	<input type="checkbox"/>	<input type="checkbox"/>
3	not assigned			<input type="checkbox"/>		<input type="checkbox"/>	<input type="checkbox"/>	<input type="checkbox"/>	<input type="checkbox"/>
2	not assigned			<input type="checkbox"/>		<input type="checkbox"/>	<input type="checkbox"/>	<input type="checkbox"/>	<input type="checkbox"/>
1	not assigned			<input type="checkbox"/>		<input type="checkbox"/>	<input type="checkbox"/>	<input type="checkbox"/>	<input type="checkbox"/>

The "Simulation" tab makes it possible to simulate an event.

Standard Area		Configurable Area		Status 1	Status 2	Simulation			
						Simulate En/Disable: <input type="text" value="Disabled"/>			
Bit#	Diagnostic Event	simulation	active	Bit#	Diagnostic Event	simulation	active		
31	Highest Severity Sensor	<input type="checkbox"/>	<input type="checkbox"/>	15	not assigned	<input type="checkbox"/>	<input type="checkbox"/>		
30	Highest Severity Electronic	<input type="checkbox"/>	<input type="checkbox"/>	14	not assigned	<input type="checkbox"/>	<input type="checkbox"/>		
29	Highest Severity Configuration	<input type="checkbox"/>	<input type="checkbox"/>	13	not assigned	<input type="checkbox"/>	<input type="checkbox"/>		
28	Highest Severity Process	<input type="checkbox"/>	<input type="checkbox"/>	12	not assigned	<input type="checkbox"/>	<input type="checkbox"/>		
27	High Severity Sensor	<input type="checkbox"/>	<input type="checkbox"/>	11	not assigned	<input type="checkbox"/>	<input type="checkbox"/>		
26	High Severity Electronic	<input type="checkbox"/>	<input type="checkbox"/>	10	not assigned	<input type="checkbox"/>	<input type="checkbox"/>		
25	High Severity Configuration	<input type="checkbox"/>	<input type="checkbox"/>	9	not assigned	<input type="checkbox"/>	<input type="checkbox"/>		
24	High Severity Process	<input type="checkbox"/>	<input type="checkbox"/>	8	not assigned	<input type="checkbox"/>	<input type="checkbox"/>		
23	Low Severity Sensor	<input type="checkbox"/>	<input type="checkbox"/>	7	not assigned	<input type="checkbox"/>	<input type="checkbox"/>		
22	Low Severity Electronic	<input type="checkbox"/>	<input type="checkbox"/>	6	not assigned	<input type="checkbox"/>	<input type="checkbox"/>		
21	Low Severity Configuration	<input type="checkbox"/>	<input type="checkbox"/>	5	not assigned	<input type="checkbox"/>	<input type="checkbox"/>		
20	Low Severity Process	<input type="checkbox"/>	<input type="checkbox"/>	4	not assigned	<input type="checkbox"/>	<input type="checkbox"/>		
19	Lowest Severity Sensor	<input type="checkbox"/>	<input type="checkbox"/>	3	not assigned	<input type="checkbox"/>	<input type="checkbox"/>		
18	Lowest Severity Electronic	<input type="checkbox"/>	<input type="checkbox"/>	2	not assigned	<input type="checkbox"/>	<input type="checkbox"/>		
17	Lowest Severity Configuration	<input type="checkbox"/>	<input type="checkbox"/>	1	not assigned	<input type="checkbox"/>	<input type="checkbox"/>		
16	Lowest Severity Process	<input type="checkbox"/>	<input type="checkbox"/>						

### 7.9.4 Transmission of independent event messages on the bus

#### Event priority

Event messages are only transmitted on the bus if their priority is between 2 and 15. Priority 1 events are displayed but are not transmitted on the bus. Events whose priority is 0 are ignored. All events are assigned the priority 0 in the factory setting. It is possible to change the priority individually for the four assignment parameters.

#### Example

The priority of the "Failure" category is to be set to "2".

1. In the FieldCare navigation window navigate to **Expert → Field Device Diagnostics → Configuration**

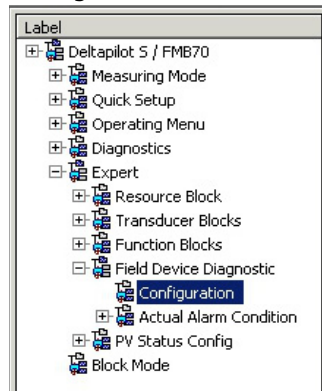

2. Select the "Standard area" tab and set the priority to "2" in the "Failure" column (D).

Standard Area		Configurable Area	Status 1	Status 2	Simulation				
		Failure  Priority 0	Function Check  Priority 0	Out of Specification  Priority 0	Maintenance Required  Priority 0				
Bit#	Diagnostic Event	enable	mask	enable	mask	enable	mask	enable	mask
31	Highest Severity Sensor	<input checked="" type="checkbox"/>	<input type="checkbox"/>	<input type="checkbox"/>	<input type="checkbox"/>	<input type="checkbox"/>	<input type="checkbox"/>	<input type="checkbox"/>	<input type="checkbox"/>
30	Highest Severity Electronic	<input checked="" type="checkbox"/>	<input type="checkbox"/>	<input type="checkbox"/>	<input type="checkbox"/>	<input type="checkbox"/>	<input type="checkbox"/>	<input type="checkbox"/>	<input type="checkbox"/>
29	Highest Severity Configuration	<input checked="" type="checkbox"/>	<input type="checkbox"/>	<input type="checkbox"/>	<input type="checkbox"/>	<input type="checkbox"/>	<input type="checkbox"/>	<input type="checkbox"/>	<input type="checkbox"/>
28	Highest Severity Process	<input checked="" type="checkbox"/>	<input type="checkbox"/>	<input type="checkbox"/>	<input type="checkbox"/>	<input type="checkbox"/>	<input type="checkbox"/>	<input type="checkbox"/>	<input type="checkbox"/>
27	High Severity Sensor	<input type="checkbox"/>	<input type="checkbox"/>	<input checked="" type="checkbox"/>	<input type="checkbox"/>	<input type="checkbox"/>	<input type="checkbox"/>	<input type="checkbox"/>	<input type="checkbox"/>
26	High Severity Electronic	<input type="checkbox"/>	<input type="checkbox"/>	<input checked="" type="checkbox"/>	<input type="checkbox"/>	<input type="checkbox"/>	<input type="checkbox"/>	<input type="checkbox"/>	<input type="checkbox"/>
25	High Severity Configuration	<input type="checkbox"/>	<input type="checkbox"/>	<input checked="" type="checkbox"/>	<input type="checkbox"/>	<input type="checkbox"/>	<input type="checkbox"/>	<input type="checkbox"/>	<input type="checkbox"/>
24	High Severity Process	<input type="checkbox"/>	<input type="checkbox"/>	<input checked="" type="checkbox"/>	<input type="checkbox"/>	<input type="checkbox"/>	<input type="checkbox"/>	<input type="checkbox"/>	<input type="checkbox"/>
23	Low Severity Sensor	<input type="checkbox"/>	<input type="checkbox"/>	<input type="checkbox"/>	<input type="checkbox"/>	<input checked="" type="checkbox"/>	<input type="checkbox"/>	<input type="checkbox"/>	<input type="checkbox"/>
22	Low Severity Electronic	<input type="checkbox"/>	<input type="checkbox"/>	<input type="checkbox"/>	<input type="checkbox"/>	<input checked="" type="checkbox"/>	<input type="checkbox"/>	<input type="checkbox"/>	<input type="checkbox"/>
21	Low Severity Configuration	<input type="checkbox"/>	<input type="checkbox"/>	<input type="checkbox"/>	<input type="checkbox"/>	<input checked="" type="checkbox"/>	<input type="checkbox"/>	<input type="checkbox"/>	<input type="checkbox"/>
20	Low Severity Process	<input type="checkbox"/>	<input type="checkbox"/>	<input type="checkbox"/>	<input type="checkbox"/>	<input checked="" type="checkbox"/>	<input type="checkbox"/>	<input type="checkbox"/>	<input type="checkbox"/>
19	Lowest Severity Sensor	<input type="checkbox"/>	<input type="checkbox"/>	<input type="checkbox"/>	<input type="checkbox"/>	<input type="checkbox"/>	<input type="checkbox"/>	<input checked="" type="checkbox"/>	<input type="checkbox"/>
18	Lowest Severity Electronic	<input type="checkbox"/>	<input type="checkbox"/>	<input type="checkbox"/>	<input type="checkbox"/>	<input type="checkbox"/>	<input type="checkbox"/>	<input checked="" type="checkbox"/>	<input type="checkbox"/>
17	Lowest Severity Configuration	<input type="checkbox"/>	<input type="checkbox"/>	<input type="checkbox"/>	<input type="checkbox"/>	<input type="checkbox"/>	<input type="checkbox"/>	<input checked="" type="checkbox"/>	<input type="checkbox"/>
16	Lowest Severity Process	<input type="checkbox"/>	<input type="checkbox"/>	<input type="checkbox"/>	<input type="checkbox"/>	<input type="checkbox"/>	<input type="checkbox"/>	<input checked="" type="checkbox"/>	<input type="checkbox"/>

#### Suppressing certain events

It is possible to suppress certain events during transmission on the bus using a "mask" check box. While these events are still displayed, they are not transmitted as alert objects on the bus. This mask check box can be found in FieldCare under **Expert → Field Device Diagnostic → Configuration**. The mask check box acts as a negative check box, i.e. if a field is selected the associated events are not transmitted on the bus.

### 7.9.5 Overview of the settings made and the current events

1. In the FieldCare navigation window navigate to **Diagnose → Alarm Indication (Polling)**

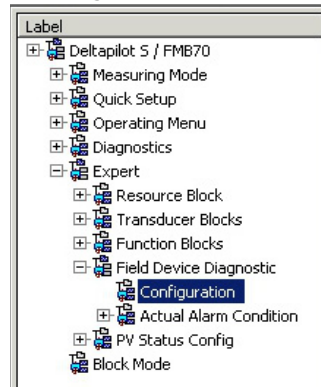

2. The following overview is displayed:
  - "Troubleshooting information" if an event has occurred
  - "Setting made" in the configurable area
  - "Current events" in the various categories

### 7.9.6 Information about the current events

1. In the FieldCare navigation window navigate to **Expert → Field Device Diagnostic → Actual Alarm Condition**

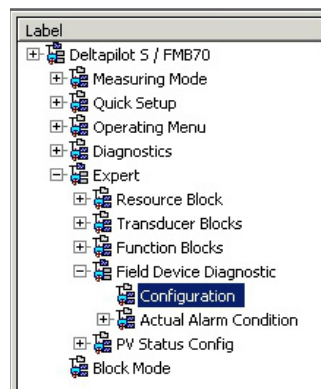

2. The following overview is displayed:
  - "Troubleshooting information" if an event has occurred
  - "FF912 Field Diagnostic Profile" version
  - "Information about the current events" in the various categories

### 7.9.7 Setting the status of the flexible alarms

The event category can be individually defined for the following events - irrespective of the event group to which they are assigned in the factory setting:

- 115: Sensor overpressure
- 120: Sensor low pressure
- 715: Sensor over temperature
- 717: Transmitter over temperature
- 718: Transmitter under temperature
- 720: Sensor under temperature
- 726: Sensor temperature error-overrange
- 727: Sensor pressure error-overrange
- 730: LRV user limits exceeded
- 731: URV user limits exceeded
- 732: LRV-Temp. user limits exceeded
- 733: URV-Temp. user limits exceeded

- **740:** Calculation Overflow, bad configuration

To change the assigned status (Bad, Uncertain, Good) of an event, select the desired status from the associated picklist.

### Example

The status of error 115 "Sensor overpressure" should no longer be indicated as "Uncertain" and should instead be indicated as "Bad".

1. In the FieldCare navigation window navigate to **Expert → Field Device Diagnostics → PV Status Config**

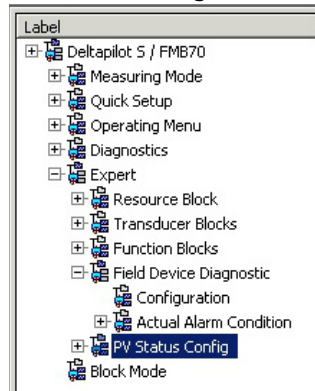

2. All the bits of the Status Select Events have the status "Uncertain" in the factory setting.

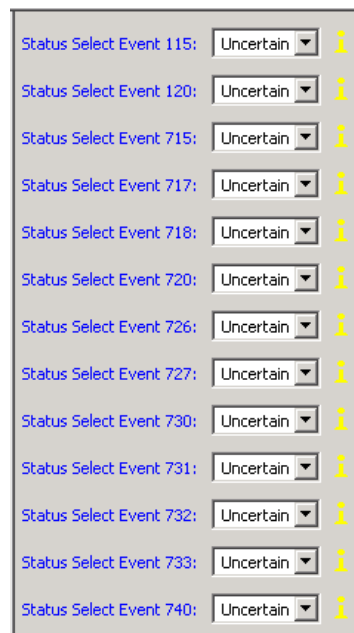

3. Select the "Bad" option for the "Status Select Event 115" row. Press Enter to confirm your entry.



## 8 Maintenance

Keep the pressure compensation and GORE-TEX® filter (1) free from contamination.

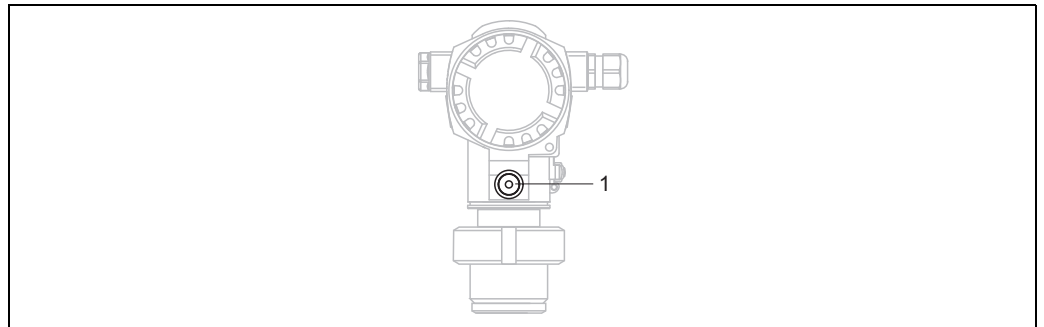

P01-FMB70xxx-17-xx-xx-xx-003

### 8.1 Exterior cleaning

Please note the following points when cleaning the device:

- The cleaning agents used should not attack the surface and the seals.
- Mechanical damage to the process isolating diaphragm, e.g. due to pointed objects, must be avoided.

## 9 Diagnostics and troubleshooting

### 9.1 Troubleshooting

#### 9.1.1 General errors

Error	Possible cause	Remedy
Device is not responding.	The supply voltage does not match the specifications on the nameplate.	Apply correct voltage.
	Supply voltage has incorrect polarity.	Reverse polarity of supply voltage.
	No contact between connecting cables and terminals.	Check the contacting of the cables and correct if necessary.
No display	Onsite display is set too bright or too dark.	<ul style="list-style-type: none"> <li>▪ Set the local display brighter by simultaneously pressing O and F.</li> <li>▪ Set the local display darker by simultaneously pressing S and F.</li> </ul>
	Connector for local display is not plugged in correctly.	Ensure connector is plugged in correctly.
	Onsite display is defective.	Replace onsite display.
Device measures incorrectly.	Configuration error.	Check and correct parameter configuration (see below).

#### 9.1.2 Displaying messages:

- Onsite display:
  - The measured value display shows the message with the highest priority. → See the "Priority" column.
  - The ALARM STATUS parameter displays all the messages pending in decreasing order of priority. You can scroll through all the messages pending using the S or O key.
- FieldCare:
  - The DIAGNOSTIC\_CODE/DIAGNOSE\_CODE parameter displays the message with the highest priority.
  - See the "Priority" column.
  - See also Section 9.6 "Response of outputs to errors".
- Diagnose Transducer Block (FF configuration program):
  - The DIAGNOSTIC\_CODE/DIAGNOSE\_CODE parameter displays the message with the highest priority. → See also Section 9.6 "Response of outputs to errors". Every message is also output as per the FOUNDATION Fieldbus Specification by means of the XD\_ERROR and BLOCK\_ERROR parameters in the Pressure, Service and DP Flow Block. Numbers are given for these parameters in the following table which are explained on 77.
- You can see a list of all the active alarms via the Diagnostic code/ACTUAL\_ALARM\_INFOS parameter.
- You can see a list of all the alarms that are no longer active (event log) via the Last Diag. Code/LAST\_ALARM\_INFOS parameter.

## 9.2 Diagnostic information on local display

### 9.2.1 Diagnostic message

Faults detected by the self-monitoring system of the measuring device are displayed as a diagnostic message in alternation with the measured value display.

#### Error categories

<b>F</b>	<p><b>"Failure"</b> A device error has occurred. The measured value is no longer valid.</p>
<b>C</b>	<p><b>"Check"</b> The device is in the service mode (e.g. during a simulation) or is performing a self-check.</p>
<b>S</b>	<p><b>"Out of specification"</b> The device is being operated:</p> <ul style="list-style-type: none"> <li>▪ Outside its technical specifications (e.g. during warmup or cleaning processes).</li> <li>▪ Outside the parameter configuration undertaken by the user (e.g. pressure outside of nominal operating range)</li> </ul>
<b>M</b>	<p><b>"Maintenance required"</b> Maintenance is required. The measured value is still valid.</p>

#### Diagnostic event and event text

The fault can be identified using the diagnostic event. The event text helps you by providing information about the fault.

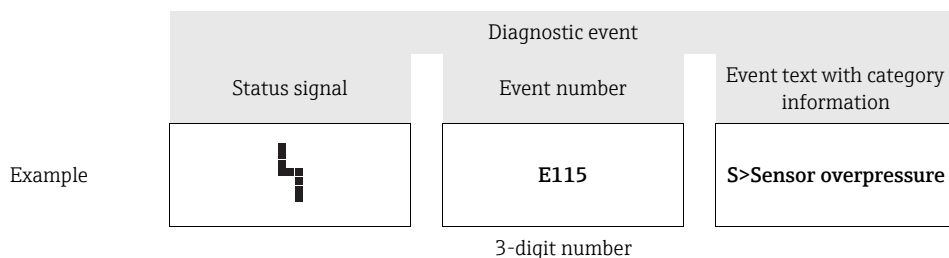

- If the device detects a defect in the onsite display during initialization, special error messages are generated. → For the error messages, → [75](#), Section 9.2.2 "Onsite display error messages".
- For support and further information, please contact Endress+Hauser Service.
- → See also Section 9.8, Section 9.9 and Section 9.10.
- If the category of a diagnostic event is being changed, an empty field might be displayed instead of "F, C, S, M".

### 9.2.2 Onsite display error messages

If the device detects a defect in the onsite display during initialization, the following error messages can be displayed:

Message	Measure
Initialization, VU Electr. Defect A110 Initialization, VU Electr. Defect A114 Initialization, VU Electr. Defect A281 Initialization, VU Checksum Err. A110 Initialization, VU Checksum Err. A112 Initialization, VU Checksum Err. A171	Exchange onsite display.

### 9.3 Diagnostic event in the operating tool

If a diagnostic event is present in the operating tool, the status signal appears in the top left status area along with the corresponding symbol for event behavior in accordance with NAMUR NE 107:

- Failure (F)
- Check (C)
- Maintenance required (M)
- Out of specification (S)

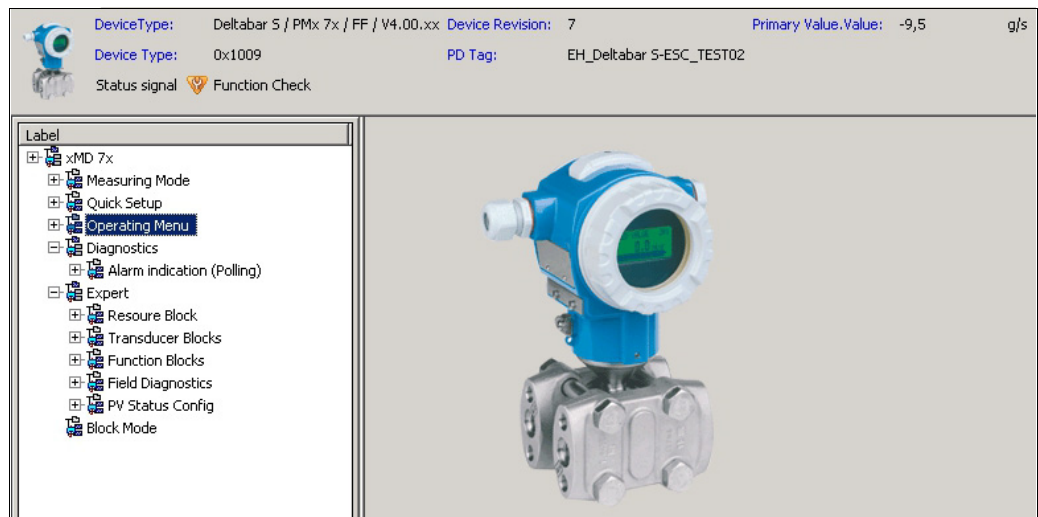

P01-xMx7xxxx-05-xx-xx-en-008

#### Calling up remedy information

1. Navigate to the "Diagnostics" menu. The diagnostic event along with text about the event is displayed in the "Actual diagnostics" parameter.
2. On the right in the display area, hover the cursor over the "Actual diagnostics" parameter. A tool tip with remedy information for the diagnostic event appears.

## 9.4 Diagnostic messages in the DIAGNOSTIC Transducer Block (TRDDIAG)

- The Actual Diagnostics parameter shows the message with the highest priority. Every message is also displayed as per the FOUNDATION Fieldbus Specification by means of the XD\_ERROR and BLOCK\_ERROR parameters.
- You can view the active alarm with the highest priority via the Diagnosis parameter.
- You can view the last alarm that is no longer active via the Last Diagnosis parameter.

### 9.4.1 Explanation of XD\_ERROR, BLOCK\_ERROR and response of outputs

Error type	Diagnostic Code	XD_ERROR Value Bit	XD_ERROR Text	BLOCK_ERROR Value Bit	BLOCK_ERROR Text	PRIMARY_VALUE (Status is set according to Operating Mode)	PRIMARY_VALUE_TYPE (Operating Mode)	TRANSDUCER Status Propagation (Impacted CHANNEL selection)
Alarm	747	17	General Error	0	Other	BAD_SENSOR_FAILURE	Pressure, Level, Flow	All
	707	18	Calibration Error	0	Other	BAD_NON_SPECIFIC	Level	Primary Value(1)
	711	18	Calibration Error	0	Other	BAD_NON_SPECIFIC	Level, Flow	Primary Value(1) Totalizer 1 (6)
	713	18	Calibration Error	0	Other	BAD_NON_SPECIFIC	Level	Primary Value(1)
	721	18	Calibration Error	0	Other	BAD_NON_SPECIFIC	Level	Primary Value(1)
	722	18	Calibration Error	0	Other	BAD_NON_SPECIFIC	Level	Primary Value(1)
	723	18	Calibration Error	0	Other	BAD_NON_SPECIFIC	Flow	Primary Value(1) Totalizer 1 (6)
	741	18	Calibration Error	0	Other	BAD_NON_SPECIFIC	Level	Primary Value(1)
	719	19	Configuration Error	0	Other	BAD_NON_SPECIFIC	Level	Primary Value(1)
	750	18	Calibration Error	0	Other	BAD_NON_SPECIFIC	Pressure, Level, Flow	Primary Value(1) Pressure(3) Maximum Pressure(4) Counter P > Pmax(5) Totalizer 1 (6)
	122	20	Electronics Failure	7	Sensor Failure	BAD_SENSOR_FAILURE	Pressure, Level, Flow	All
	101	20	Electronics Failure	0	Other	BAD_SENSOR_FAILURE	Pressure, Level, Flow	All
	716	20	Electronics Failure	0	Other	BAD_SENSOR_FAILURE	Pressure, Level, Flow	All
	725	20	Electronics Failure	0	Other	BAD_SENSOR_FAILURE	Pressure, Level, Flow	All
	704	20	Electronics Failure	7	Sensor Failure	BAD_DEVICE_FAILURE	Pressure, Level, Flow	All
	703	20	Electronics Failure	0	Other	BAD_DEVICE_FAILURE	Pressure, Level, Flow	All
	705	20	Electronics Failure	0	Other	BAD_DEVICE_FAILURE	Pressure, Level, Flow	All
	737	20	Electronics Failure	0	Other	BAD_DEVICE_FAILURE	Pressure, Level, Flow	All
	738	20	Electronics Failure	0	Other	BAD_DEVICE_FAILURE	Pressure, Level, Flow	All
	739	20	Electronics Failure	0	Other	BAD_DEVICE_FAILURE	Pressure, Level, Flow	All
	742	20	Electronics Failure	0	Other	BAD_DEVICE_FAILURE	Pressure, Level, Flow	All
	744	20	Electronics Failure	0	Other	BAD_DEVICE_FAILURE	Pressure, Level, Flow	All
	743	20	Electronics Failure	7	Sensor Failure	BAD_DEVICE_FAILURE	Pressure, Level, Flow	All
748	20	Electronics Failure	7	Sensor Failure	BAD_DEVICE_FAILURE	Pressure, Level, Flow	All	

Error type	Diagnostic Code	XD_ERROR Value Bit	XD_ERROR Text	BLOCK_ERROR Value Bit	BLOCK_ERROR Text	PRIMARY_VALUE (Status is set according to Operating Mode)	PRIMARY_VALUE_TYPE (Operating Mode)	TRANSDUCER Status Propagation (Impacted CHANNEL selection)
Alarm	113	20	Electronics Failure	0	Other	BAD_DEVICE_FAILURE	Pressure, Level, Flow	All
	728	20	Electronics Failure	0	Other	BAD_DEVICE_FAILURE	Pressure, Level, Flow	All
	729	20	Electronics Failure	0	Other	BAD_DEVICE_FAILURE	Pressure, Level, Flow	All
	736	20	Electronics Failure	0	Other	BAD_DEVICE_FAILURE	Pressure, Level, Flow	All
	110	23	Data Integrity Error	0	Other	BAD_DEVICE_FAILURE	Pressure, Level, Flow	All
	130	23	Data Integrity Error	0	Other	BAD_DEVICE_FAILURE	Pressure, Level, Flow	All
	131	23	Data Integrity Error	0	Other	GOOD	Pressure, Level, Flow	None
	132	23	Data Integrity Error	0	Other	BAD_DEVICE_FAILURE	Flow	Totalizer 1 (6)
	133	23	Data Integrity Error	0	Other	GOOD	Pressure, Level, Flow	None
	135	23	Data Integrity Error	0	Other	BAD_DEVICE_FAILURE	Pressure, Level, Flow	All
	121	23	Data Integrity Error	0	Other	BAD_DEVICE_FAILURE	Pressure, Level, Flow	All
Alarm/ Warning	115	17	General Error	0	Other	- BAD_NON_SPECIFIC - STATUS_UNCERTAIN - GOOD	Pressure, Level, Flow	Primary Value(1) Pressure(3) Maximum Pressure(4) Counter P > Pmax(5) Totalizer 1 (6)
	120	17	General Error	0	Other	- BAD_NON_SPECIFIC - STATUS_UNCERTAIN - GOOD	Pressure, Level, Flow	Primary Value(1) Pressure(3) Maximum Pressure(4) Counter P > Pmax(5) Totalizer 1 (6)
	717	17	General Error	0	Other	- BAD_NON_SPECIFIC - STATUS_UNCERTAIN - GOOD	Pressure, Level, Flow	All
	718	17	General Error	0	Other	- BAD_NON_SPECIFIC - STATUS_UNCERTAIN - GOOD	Pressure, Level, Flow	All
	720	17	General Error	0	Other	- BAD_NON_SPECIFIC - STATUS_UNCERTAIN - GOOD	Pressure, Level, Flow	Sensor Temperature(2)
	715	17	General Error	7	Sensor Failure	- BAD_NON_SPECIFIC - STATUS_UNCERTAIN - GOOD	Pressure, Level, Flow	Sensor Temperature(2)
	726	20	Electronics Failure	7	Sensor Failure	- BAD_NON_SPECIFIC - STATUS_UNCERTAIN - GOOD	Pressure, Level, Flow	All
	740	20	Electronics Failure	7	Sensor Failure	- BAD_NON_SPECIFIC - STATUS_UNCERTAIN - GOOD	Pressure, Level, Flow	All
	727	20	Electronics Failure	7	Sensor Failure	- BAD_NON_SPECIFIC - STATUS_UNCERTAIN - GOOD	Pressure, Level, Flow	All

Error type	Diagnostic Code	XD_ERROR Value Bit	XD_ERROR Text	BLOCK_ERROR Value Bit	BLOCK_ERROR Text	PRIMARY_VALUE (Status is set according to Operating Mode)	PRIMARY_VALUE_TYPE (Operating Mode)	TRANSDUCER Status Propagation (Impacted CHANNEL selection)
	730	19	Configuration Error	0	Other	GOOD	Pressure, Level, Flow	None
	731	19	Configuration Error	0	Other	GOOD	Pressure, Level, Flow	None
	732	19	Configuration Error	0	Other	GOOD	Pressure, Level, Flow	None
	733	19	Configuration Error	0	Other	GOOD	Pressure, Level, Flow	None
Warning	106	17	General Error	0	Other	STATUS_UNCERTAIN	Pressure, Level, Flow	All
	134	17	General Error	0	Other	GOOD	Pressure, Level, Flow	None
	116	17	General Error	0	Other	- BAD_NON_SPECIFIC - STATUS_UNCERTAIN - GOOD	Pressure, Level, Flow	All
	701	17	General Error	0	Other	UNCERTAIN_CONFIG_ERROR	Pressure, Level, Flow	All
	745	17	General Error	0	Other	STATUS_UNCERTAIN	Pressure, Level, Flow	All
	613	17	General Error	0	Other	UNCERTAIN_SIM	Pressure, Level, Flow	Primary Value(1) Maximum Pressure(4) Counter P > Pmax(5) Totalizer 1 (6)
	702	17	General Error	0	Other	GOOD	Pressure, Level, Flow	None
	710	18	Calibration Error	0	Other	GOOD	Pressure, Level, Flow	None
	602	19	Configuration Error	0	Other	UNCERTAIN_CONFIG_ERROR	Level	Primary Value(1)
	604	19	Configuration Error	0	Other	UNCERTAIN_CONFIG_ERROR	Level	Primary Value(1)
	746	20	Electronics Failure	0	Other	STATUS_UNCERTAIN	Pressure, Level, Flow	All
	102	23	Data Integrity Error	0	Other	GOOD	Pressure, Level, Flow	Maximum Pressure(4) Counter P > Pmax(5)
	700	23	Data Integrity Error	0	Other	STATUS_UNCERTAIN	Pressure, Level, Flow	All
706	23	Data Integrity Error	0	Other	GOOD	Pressure, Level, Flow	None	

## 9.5 Overview of diagnostic events

### 9.5.1 Failure (F)

Diagnostic Code	Error response	Message/description	XD_ERROR Value Bit	BLOCK_ERROR Value Bit	Cause	Measure	Priority
101	Alarm	F>Sensor electronic EEPROM error	20	0	<ul style="list-style-type: none"> <li>- Electromagnetic effects are greater than specifications in the technical data. (→ See Section 10.) This message normally only appears briefly.</li> <li>- Sensor defect.</li> </ul>	<ul style="list-style-type: none"> <li>- Wait a few minutes.</li> <li>- Restart the device. Perform reset (Code 62).</li> <li>- Block off electromagnetic effects or eliminate source of disturbance.</li> <li>- Replace sensor.</li> </ul>	19
110	Alarm	F>Checksum error in EEPROM: configuration segment	23	0	<ul style="list-style-type: none"> <li>- The supply voltage is disconnected when writing.</li> <li>- Electromagnetic effects are greater than specifications in the technical data. (→ See Section 10.)</li> <li>- Main electronics defect.</li> </ul>	<ul style="list-style-type: none"> <li>- Reestablish supply voltage. Perform reset (code 7864) if necessary and recalibrate the device.</li> <li>- Block off electromagnetic effects or eliminate sources of disturbance.</li> <li>- Replace main electronics.</li> </ul>	6
113	Alarm	F>ROM failure in transmitter electronic	20	0	<ul style="list-style-type: none"> <li>- Main electronics defect.</li> </ul>	<ul style="list-style-type: none"> <li>- Replace main electronics.</li> </ul>	1
121	Alarm	F>Checksum error in factory segment of EEPROM	23	0	<ul style="list-style-type: none"> <li>- Main electronics defect.</li> </ul>	<ul style="list-style-type: none"> <li>- Replace main electronics.</li> </ul>	5
122	Alarm	F>Sensor not connected	20	7	<ul style="list-style-type: none"> <li>- Cable connection sensor – main electronics disconnected.</li> <li>- Electromagnetic effects are greater than specifications in the technical data. (→ See Section 10.)</li> <li>- Main electronics defect.</li> <li>- Sensor defect.</li> </ul>	<ul style="list-style-type: none"> <li>- Check cable connection and repair if necessary.</li> <li>- Block off electromagnetic effects or eliminate source of disturbance.</li> <li>- Replace main electronics.</li> <li>- Replace sensor.</li> </ul>	14
130	Alarm	F>EEPROM is defect.	23	0	<ul style="list-style-type: none"> <li>- Main electronics defect.</li> </ul>	<ul style="list-style-type: none"> <li>- Replace main electronics.</li> </ul>	11
131	Alarm	F>Checksum error in EEPROM: min/max segment	23	0	<ul style="list-style-type: none"> <li>- Main electronics defect.</li> </ul>	<ul style="list-style-type: none"> <li>- Replace main electronics.</li> </ul>	9
133	Alarm	F>Checksum error in History EEPROM	23	0	<ul style="list-style-type: none"> <li>- An error occurred when writing.</li> <li>- Main electronics defect.</li> </ul>	<ul style="list-style-type: none"> <li>- Perform reset (code 7864) and recalibrate the device.</li> <li>- Replace main electronics.</li> </ul>	8
135	Alarm	F>Checksum error in EEPROM FF segment	23	0	<ul style="list-style-type: none"> <li>- Main electronics defect.</li> </ul>	<ul style="list-style-type: none"> <li>- Replace main electronics.</li> </ul>	10
703	Alarm	F>Measurement error	20	0	<ul style="list-style-type: none"> <li>- Fault in the main electronics.</li> <li>- Main electronics defect.</li> </ul>	<ul style="list-style-type: none"> <li>- Briefly disconnect device from the power supply.</li> <li>- Replace main electronics.</li> </ul>	24
705	Alarm	F>Measurement error	20	0	<ul style="list-style-type: none"> <li>- Fault in the main electronics.</li> <li>- Main electronics defect.</li> </ul>	<ul style="list-style-type: none"> <li>- Briefly disconnect device from the power supply.</li> <li>- Replace main electronics.</li> </ul>	23
716	Alarm	F>Process isolating diaphragm broken	20	0	<ul style="list-style-type: none"> <li>- Sensor defect.</li> </ul>	<ul style="list-style-type: none"> <li>- Replace sensor.</li> <li>- Reduce pressure.</li> </ul>	26



Diagnostic Code	Error response	Message/description	XD_ERROR Value Bit	BLOCK_ERROR Value Bit	Cause	Measure	Priority
725	Alarm	F>Sensor connection error, cycle disturbance	20	0	<ul style="list-style-type: none"> <li>– Electromagnetic effects are greater than specifications in the technical data. (→ See Section 10.)</li> <li>– Setscrew loose.</li> <li>– Sensor or main electronics defect.</li> </ul>	<ul style="list-style-type: none"> <li>– Block off electromagnetic effects or eliminate source of disturbance.</li> <li>– Retighten setscrew with 1 Nm (0.74 lbf ft) (see Section 4.4.5).</li> <li>– Replace sensor or main electronics.</li> </ul>	27
728	Alarm	F>RAM error	20	0	<ul style="list-style-type: none"> <li>– Fault in the main electronics.</li> <li>– Main electronics defect.</li> </ul>	<ul style="list-style-type: none"> <li>– Briefly disconnect device from the power supply.</li> <li>– Replace main electronics.</li> </ul>	2
729	Alarm	F>RAM error	20	0	<ul style="list-style-type: none"> <li>– Fault in the main electronics.</li> <li>– Main electronics defect.</li> </ul>	<ul style="list-style-type: none"> <li>– Briefly disconnect device from the power supply.</li> <li>– Replace main electronics.</li> </ul>	3
736	Alarm	F>RAM error	20	0	<ul style="list-style-type: none"> <li>– Fault in the main electronics.</li> <li>– Main electronics defect.</li> </ul>	<ul style="list-style-type: none"> <li>– Briefly disconnect device from the power supply.</li> <li>– Replace main electronics.</li> </ul>	4
737	Alarm	F>Measurement error	20	0	<ul style="list-style-type: none"> <li>– Fault in the main electronics.</li> <li>– Main electronics defect.</li> </ul>	<ul style="list-style-type: none"> <li>– Briefly disconnect device from the power supply.</li> <li>– Replace main electronics.</li> </ul>	22
738	Alarm	F>Measurement error	20	0	<ul style="list-style-type: none"> <li>– Fault in the main electronics.</li> <li>– Main electronics defect.</li> </ul>	<ul style="list-style-type: none"> <li>– Briefly disconnect device from the power supply.</li> <li>– Replace main electronics.</li> </ul>	21
739	Alarm	F>Measurement error	20	0	<ul style="list-style-type: none"> <li>– Fault in the main electronics.</li> <li>– Main electronics defect.</li> </ul>	<ul style="list-style-type: none"> <li>– Briefly disconnect device from the power supply.</li> <li>– Replace main electronics.</li> </ul>	25
742	Alarm	F>Sensor connection error (upload)	20	0	<ul style="list-style-type: none"> <li>– Electromagnetic effects are greater than specifications in the technical data. (→ See Section 10.) This message normally only appears briefly.</li> <li>– Cable connection sensor – main electronics disconnected.</li> <li>– Sensor defect.</li> </ul>	<ul style="list-style-type: none"> <li>– Wait a few minutes.</li> <li>– Perform reset (code 7864) and recalibrate the device.</li> <li>– Check cable connection and repair if necessary.</li> <li>– Replace sensor.</li> </ul>	20
743	Alarm	F>Electronic PCB error during initialization	20	7	<ul style="list-style-type: none"> <li>– Electromagnetic effects are greater than specifications in the technical data. (→ See Section 10.) This message normally only appears briefly.</li> <li>– Main electronics defect.</li> </ul>	<ul style="list-style-type: none"> <li>– Wait a few minutes.</li> <li>– Restart the device. Perform reset (Code 62).</li> <li>– Replace main electronics.</li> </ul>	15 / 16
744	Alarm	F>Main electronic PCB error	20	0	<ul style="list-style-type: none"> <li>– Electromagnetic effects are greater than specifications in the technical data. (→ See Section 10.)</li> <li>– Main electronics defect.</li> </ul>	<ul style="list-style-type: none"> <li>– Restart the device. Perform reset (Code 62).</li> <li>– Block off electromagnetic effects or eliminate source of disturbance.</li> <li>– Replace main electronics.</li> </ul>	12
747	Alarm	F>Sensor software not compatible to electronics	17	0	<ul style="list-style-type: none"> <li>– Sensor does not suit the device (electronic sensor nameplate).</li> </ul>	<ul style="list-style-type: none"> <li>– Replace sensor with a suitable sensor.</li> </ul>	18

Diagnostic Code	Error response	Message/description	XD_ERROR Value Bit	BLOCK_ERROR Value Bit	Cause	Measure	Priority
748	Alarm	F>Memory failure in signal processor	20	7	<ul style="list-style-type: none"> <li>- Electromagnetic effects are greater than specifications in the technical data. (→See Section 10.)</li> <li>- Main electronics defect.</li> </ul>	<ul style="list-style-type: none"> <li>- Block off electromagnetic effects or eliminate source of disturbance.</li> <li>- Replace main electronics.</li> </ul>	17

### 9.5.2 Check (C)

Diagnostic Code	Error response	Message/description	XD_ERROR Value Bit	BLOCK_ERROR Value Bit	Cause	Measure	Priority
106	Warning	C>Downloading - please wait	17	0	- Downloading.	- Wait for download to complete.	61
602	Warning	C>Linearization curve not monoton	19	0	- The linearization table is not monotonic increasing.	- Add to or correct linearization table. Then accept linearization table again.	67
604	Warning	C>Linearization table invalid. Min. 2 points.	19	0	Note! There is no min. span for the y-points as of software version "03.00.00".		
					- The linearization table has fewer than 2 points.	<ol style="list-style-type: none"> <li>1. Add to linearization table. Perform the linearization again if necessary.</li> <li>2. Correct the linearization table and accept it again.</li> </ol>	68
613	Warning	C>Simulation active	17	0	- Simulation is switched on, i.e. the device is not measuring at present.	- Switch off simulation.	70
701	Warning	C>Adjustment outside sensor nominal range	17	0	- The adjustment carried out would cause a breach of the nominal sensor range.	- Carry out calibration again.	63
704	Alarm	C>Measurement error	20	7	<ul style="list-style-type: none"> <li>- Fault in the main electronics.</li> <li>- Main electronics defect.</li> </ul>	<ul style="list-style-type: none"> <li>- Briefly disconnect device from the power supply.</li> <li>- Replace main electronics.</li> </ul>	13
707	Alarm	C>X-VAL. (TAB_XY_VALUE) of lin. table out of edit limits.	18	0	- At least one X-VALUE (TAB_XY_VALUE) in the linearization table is either below the value for SCALE_IN, EU_0/HYDR. PRESS. MIN. or LINEAR_LEVEL_MIN/MIN. LEVEL or above the value for SCALE_IN, EU_100/HYDR. PRESS. MAX. or LINEAR_LEVEL_MAX/HEIGHT MAX.	- Perform calibration again (→ See Operating Instructions BA00303P, parameter description, Section 5).	45
710	Warning	B>Set span too small. Not allowed.	18	0	<ul style="list-style-type: none"> <li>- Values for calibration (e.g. lower range value and upper range value) are too close together.</li> <li>- The sensor was replaced and the customer-specific configuration does not suit the sensor.</li> <li>- Unsuitable download carried out.</li> </ul>	<ul style="list-style-type: none"> <li>- Adjust calibration to suit sensor (→ see Operating Instructions BA00303P, parameter description, CAL_MIN_SPAN/MINIMUM SPAN parameter).</li> <li>- Adjust calibration to suit sensor.</li> <li>- Replace sensor with a suitable sensor.</li> <li>- Check configuration and perform download again.</li> </ul>	60

Diagnostic Code	Error response	Message/description	XD_ERROR Value Bit	BLOCK_ERROR Value Bit	Cause	Measure	Priority
711	Alarm	C>LRV or URV out of edit limits	18	0	<ul style="list-style-type: none"> <li>- Lower range value and/or upper range value undershoot or overshoot the sensor range limits.</li> <li>- The sensor was replaced and the customer-specific configuration does not suit the sensor.</li> <li>- Unsuitable download carried out.</li> </ul>	<ul style="list-style-type: none"> <li>- Reset the LRV and/or URV to suit the sensor. Pay attention to position adjustment.</li> <li>- Reset the LRV and/or URV to suit the sensor. Pay attention to position adjustment.</li> <li>- Replace sensor with a suitable sensor.</li> <li>- Check configuration and perform download again.</li> </ul>	37
713	Alarm	C>100% POINT (LEVEL_100_PERCENT_VALUE) level out of edit limits	18	0	<ul style="list-style-type: none"> <li>- The sensor was replaced.</li> </ul>	<ul style="list-style-type: none"> <li>- Carry out calibration again.</li> </ul>	46
719	Alarm	C>Y-VAL (TAB_XY_VALUE) of lin. table out of edit limits	19	0	<ul style="list-style-type: none"> <li>- At least one Y-VALUE (TAB_XY_VALUE) in the linearization table is below the SCALE_OUT, EU_0/TANK CONTENT MIN. or above the SCALE_OUT, EU_100/TANK CONTENT MAX.</li> </ul>	<ul style="list-style-type: none"> <li>- Carry out calibration again. (→ See Operating Instructions BA00303P, parameter description, Section 5).</li> </ul>	47
721	Alarm	C>ZERO POSITION (LEVEL_OFFSET) level out of edit limits	18	0	<ul style="list-style-type: none"> <li>- LEVEL MIN (LINEAR_LEVEL_MIN) or LEVEL MAX (LINEAR_LEVEL_MAX) has been changed.</li> </ul>	<ul style="list-style-type: none"> <li>- Perform reset (code 2710) and recalibrate the device.</li> </ul>	48
722	Alarm	C>EMPTY CALIB. (SCALE_OUT, EU_0) or FULL CALIB. (SCALE_OUT, EU_100) out of edit limits	18	0	<ul style="list-style-type: none"> <li>- LINEAR_LEVEL_MIN/LEVEL MIN or LINEAR_LEVEL_MAX/LEVEL MAX has been changed.</li> </ul>	<ul style="list-style-type: none"> <li>- Perform reset (code 2710) and recalibrate the device.</li> </ul>	49/50
723	Alarm	C>MAX. FLOW (SCALE_OUT, EU_100) out of edit limits	18	0	<ul style="list-style-type: none"> <li>- FLOW_TYPE/FLOW-MEAS. TYPE has been changed.</li> </ul>	<ul style="list-style-type: none"> <li>- Carry out calibration again.</li> </ul>	51
741	Alarm	C>TANK HEIGHT (LEVEL_TANK_HEIGHT) out of edit limits	18	0	<ul style="list-style-type: none"> <li>- LINEAR_LEVEL_MIN/LEVEL MIN or LINEAR_LEVEL_MAX/LEVEL MAX has been changed.</li> </ul>	<ul style="list-style-type: none"> <li>- Perform reset (code 2710) and recalibrate the device.</li> </ul>	52
746	Warning	C>Sensor connection error - initializing	20	0	<ul style="list-style-type: none"> <li>- Electromagnetic effects are greater than specifications in the technical data. (→ See Section 10.) This message normally only appears briefly.</li> <li>- Overpressure or low pressure present.</li> </ul>	<ul style="list-style-type: none"> <li>- Wait a few minutes.</li> <li>- Restart the device. Perform reset (Code 7864).</li> <li>- Block off electromagnetic effects or eliminate source of disturbance.</li> <li>- Reduce or increase pressure.</li> </ul>	28

Diagnostic Code	Error response	Message/description	XD_ERROR Value Bit	BLOCK_ERROR Value Bit	Cause	Measure	Priority
750	Warning	C>Configuration not permitted	18	0	<ul style="list-style-type: none"> <li>- By means of the operation profile, options were selected for the configuration of the device but the options do not suit one another. For example, if the option "1" (linearization table) was selected for LIN_TYPE and the unit "1347 (m<sup>3</sup>/s)" was selected for PRIMARY_VALUE_UNIT.</li> </ul>	<ul style="list-style-type: none"> <li>- Check configuration.</li> <li>- Perform reset (code 7864) and recalibrate the device.</li> </ul>	53

### 9.5.3 Maintenance required (M)

Diagnostic Code	Error response	Message/description	XD_ERROR Value Bit	BLOCK_ERROR Value Bit	Cause	Measure	Priority
102	Warning	M>Checksum error in EEPROM: peakhold segment	23	0	<ul style="list-style-type: none"> <li>– Main electronics defect. Correct measurement can continue as long as you do not need the peak hold indicator function.</li> </ul>	<ul style="list-style-type: none"> <li>– Replace main electronics.</li> </ul>	62
116	Warning	M>Download error, repeat download	17	0	<ul style="list-style-type: none"> <li>– The file is defect.</li> <li>– During the download, the data are not correctly transmitted to the processor, e.g. because of open cable connections, spikes (ripple) on the supply voltage or electromagnetic effects.</li> </ul>	<ul style="list-style-type: none"> <li>– Use another file.</li> <li>– Check cable connection PC – transmitter.</li> <li>– Block off electromagnetic effects or eliminate sources of disturbance.</li> <li>– Perform reset (code 7864) and recalibrate the device.</li> <li>– Repeat download.</li> </ul>	38
134	Warning	M>EEPROM lifetime WARNING	17	0	<ul style="list-style-type: none"> <li>– Writing too often to EEPROM.</li> </ul>	<ul style="list-style-type: none"> <li>– Reduce write accessing to EEPROM.</li> </ul>	65
700	Warning	M>Last configuration not stored	23	0	<ul style="list-style-type: none"> <li>– An error occurred when writing or reading configuration data or the power supply was disconnected.</li> <li>– Main electronics defect.</li> </ul>	<ul style="list-style-type: none"> <li>– Perform reset (code 7864) and recalibrate the device.</li> <li>– Replace main electronics.</li> </ul>	63
702	Warning	M>HistoROM data not consistent	17	0	<ul style="list-style-type: none"> <li>– Data were not written correctly to the HistoROM, e.g. if the HistoROM was detached during the writing process.</li> <li>– HistoROM does not have any data.</li> </ul>	<ul style="list-style-type: none"> <li>– Repeat upload.</li> <li>– Perform reset (code 7864) and recalibrate the device.</li> <li>– Copy suitable data to the HistoROM. (→ 44, Section 6.6.1 "Copying configuration data".)</li> </ul>	64
706	Warning	M>Configuration in HistoROM and device not identical	23	0	<ul style="list-style-type: none"> <li>– Configuration (parameters) in the HistoROM and in the device not identical.</li> </ul>	<ul style="list-style-type: none"> <li>– Copy data from the device to the HistoROM. (→ 44, Section 6.6.1 "Copying configuration data".)</li> <li>– Copy data from the HistoROM to the device. (→ 44, Section 6.6.1 "Copying configuration data".) The message remains if the HistoROM and the device have different software versions. The message disappears if you copy the data from the device to the HistoROM.</li> <li>– Device reset codes such as 1 or 40864 do not have any effect on the HistoROM. That means that if you perform a reset, the configurations in the HistoROM and in the device can be different.</li> </ul>	69

Diagnostic Code	Error response	Message/description	XD_ERROR Value Bit	BLOCK_ERROR Value Bit	Cause	Measure	Priority
740	Alarm/warning	M>Calculation overflow, bad configuration	20	7	<ul style="list-style-type: none"> <li>- Level measuring mode: the measured pressure has undershot the value for SCALE_IN, EU_0/HYDR. PRESS. MIN. or overshoot the value for SCALE_IN, EU_100/HYDR. PRESS MAX.</li> <li>- Level measuring mode: the measured level has undershot the value for LEVEL MIN or overshoot the value for LEVEL MAX</li> </ul>	<ul style="list-style-type: none"> <li>- Check configuration and recalibrate the device if necessary.</li> <li>- Select a device with a suitable measuring range.</li> <li>- Check configuration and recalibrate the device if necessary (→ see Operating Instructions BA00303P, parameter description, LEVEL MIN. parameter).</li> </ul>	29
745	Warning	M>Sensor data unknown	17	0	<ul style="list-style-type: none"> <li>- Sensor does not suit the device (electronic sensor nameplate). Device continues measuring.</li> </ul>	<ul style="list-style-type: none"> <li>- Replace sensor with a suitable sensor.</li> </ul>	66

### 9.5.4 Out of specification (S)

Diagnostic Code	Error response	Message/description	XD_ERROR Value Bit	BLOCK_ERROR Value Bit	Cause	Measure	Priority
115	Alarm/warning	S>Sensor overpressure	17	0	<ul style="list-style-type: none"> <li>- Overpressure present.</li> <li>- Sensor defect.</li> </ul>	<ul style="list-style-type: none"> <li>- Reduce pressure until message disappears.</li> <li>- Replace sensor.</li> </ul>	31
120	Alarm/warning	S>Sensor low pressure	17	0	<ul style="list-style-type: none"> <li>- Pressure too low.</li> <li>- Sensor defect.</li> </ul>	<ul style="list-style-type: none"> <li>- Increase pressure until message disappears.</li> <li>- Replace sensor.</li> </ul>	32
715	Alarm/warning	S>Sensor over temperature	17	7	<ul style="list-style-type: none"> <li>- The temperature measured in the sensor is greater than the upper nominal temperature of the sensor. (→ See also Operating Instructions BA00303P, parameter description for TEMPERATURE_1_SENSOR_LIMIT_HIGH/Tmax SENSOR)</li> <li>- Unsuitable download carried out.</li> </ul>	<ul style="list-style-type: none"> <li>- Reduce process temperature/ambient temperature.</li> <li>- Check configuration and perform download again.</li> </ul>	34
717	Alarm/warning	S>Transmitter over temperature	17	0	<ul style="list-style-type: none"> <li>- The temperature measured in the electronics is greater than the upper nominal temperature of the electronics (+88 °C (+190 °F)).</li> <li>- Unsuitable download carried out.</li> </ul>	<ul style="list-style-type: none"> <li>- Reduce ambient temperature.</li> <li>- Check configuration and perform download again.</li> </ul>	36
718	Alarm/warning	S>Transmitter under temperature	17	0	<ul style="list-style-type: none"> <li>- The temperature measured in the electronics is smaller than the lower nominal temperature of the electronics (-43 °C (-45 °F)).</li> <li>- Unsuitable download carried out.</li> </ul>	<ul style="list-style-type: none"> <li>- Increase ambient temperature. Insulate device if necessary.</li> <li>- Check configuration and perform download again.</li> </ul>	37
720	Alarm/warning	S>Sensor under temperature	17	0	<ul style="list-style-type: none"> <li>- The temperature measured in the sensor is lower than the lower nominal temperature of the sensor (→ see Operating Instructions BA00303P, parameter description, TEMPERATURE_1_SENSOR_LIMIT_LOW/Tmin SENSOR parameter).</li> <li>- Unsuitable download carried out.</li> <li>- Loose connection at sensor cable.</li> </ul>	<ul style="list-style-type: none"> <li>- Increase process temperature/ambient temperature.</li> <li>- Check configuration and perform download again.</li> <li>- Wait a short period of time and tighten the connection, or avoid loose connection.</li> </ul>	35



Diagnostic Code	Error response	Message/description	XD_ERROR Value Bit	BLOCK_ERROR Value Bit	Cause	Measure	Priority
726	Alarm/ warning	S>Sensor temperature error - overrange	20	7	<ul style="list-style-type: none"> <li>- Electromagnetic effects are greater than specifications in the technical data. (→See Section 10.)</li> <li>- Process temperature is outside permitted range.</li> <li>- Sensor defect.</li> </ul>	<ul style="list-style-type: none"> <li>- Block off electromagnetic effects or eliminate source of disturbance.</li> <li>- Check temperature present, reduce or increase if necessary.</li> <li>- If the process temperature is within the permitted range, replace sensor.</li> </ul>	33
727	Alarm/ warning	S>Sensor pressure error - overrange	20	7	<ul style="list-style-type: none"> <li>- Electromagnetic effects are greater than specifications in the technical data. (→ See Section 10.)</li> <li>- Pressure is outside permitted range.</li> <li>- Sensor defect.</li> </ul>	<ul style="list-style-type: none"> <li>- Block off electromagnetic effects or eliminate source of disturbance.</li> <li>- Check pressure present, reduce or increase if necessary.</li> <li>- If the pressure is within the permitted range, replace sensor.</li> </ul>	30
730	Alarm/ Warning	S>Pmin ALARM WINDOW (PRESSURE_1_USER_LOW_LIMIT) undershot	19	0	<ul style="list-style-type: none"> <li>- Pressure measured value has undershot the value specified for the PRESSURE_1_USER_LOW_LIMIT/Pmin ALARM WINDOW parameter.</li> <li>- Loose connection at sensor cable.</li> </ul>	<ul style="list-style-type: none"> <li>- Check system/pressure measured value.</li> <li>- Change value for PRESSURE_1_USER_LOW_LIMIT/Pmin ALARM WINDOW if necessary. (→ See also Operating Instructions BA00303P, parameter description)</li> <li>- Wait a short period of time and tighten the connection, or avoid loose connection.</li> </ul>	55
731	Alarm/ Warning	S>Pmax ALARM WINDOW (PRESSURE_1_USER_HIGH_LIMIT) overshoot	19	0	<ul style="list-style-type: none"> <li>- Pressure measured value has overshoot the value specified for the PRESSURE_1_USER_HIGH_LIMIT/Pmax ALARM WINDOW parameter.</li> </ul>	<ul style="list-style-type: none"> <li>- Check system/pressure measured value.</li> <li>- Change value for PRESSURE_1_USER_HIGH_LIMIT/Pmax ALARM WINDOW if necessary. (→ See also Operating Instructions BA00303P, parameter description)</li> </ul>	54
732	Alarm/ Warning	S>Tmin ALARM WINDOW (TEMPERATURE_1_USER_LOW_LIMIT) undershot	19	0	<ul style="list-style-type: none"> <li>- Temperature measured value has undershot the value specified for the TEMPERATURE_1_USER_LOW_LIMIT/Tmin ALARM WINDOW parameter.</li> <li>- Loose connection at sensor cable.</li> </ul>	<ul style="list-style-type: none"> <li>- Check system/temperature measured value.</li> <li>- Change value for TEMPERATURE_1_USER_LOW_LIMIT/Tmin ALARM WINDOW if necessary. (→ See also Operating Instructions BA00303P, parameter description)</li> <li>- Wait a short period of time and tighten the connection, or avoid loose connection.</li> </ul>	57



Diagnostic Code	Error response	Message/description	XD_ERROR Value Bit	BLOCK_ERROR Value Bit	Cause	Measure	Priority
733	Alarm/ Warning	S>Tmax ALARM WINDOW (TEMPERATURE_1_USER_HIGH_LIMIT) overshoot	19	0	– Temperature measured value has overshoot the value specified for the TEMPERATURE_1_USER_HIGH_LIMIT/Tmax ALARM WINDOW parameter.	<ul style="list-style-type: none"> <li>– Check system/temperature measured value.</li> <li>– Change value for TEMPERATURE_1_USER_HIGH_LIMIT/Tmax ALARM WINDOW if necessary. (→ See also Operating Instructions BA00303P, parameter description)</li> </ul>	56

## 9.6 Response of outputs to errors

The device makes a distinction between the output behavior "Alarm", "Warning" and "Error".  
 → See the following table and → 75, Section 9.2 "Diagnostic information on local display".  
 Certain problems can be assigned the "GOOD" status via FF communication, see Section 9.4.1.

Output	A (Alarm)	W (Warning)	E (Error: Alarm/Warning)
FOUNDATION Fieldbus	The process variable in question is transmitted with the status BAD.	Device continues measuring. The process variable in question is transmitted with the status UNCERTAIN.	For this error, you can enter whether the device should react as in the event of an alarm or as in the event of a warning. See appropriate column for "Alarm" or "Warning" (→ see Operating Instructions BA00303P, parameter description, REACTION_ON_ALARM_NR/SELECT_ALARM_TYPE parameter). The GOOD status can also be assigned to the individual error via the parameters FF912_STATUS_SELECT_1 to FF912_STATUS_SELECT_131.
Onsite display	<ul style="list-style-type: none"> <li>– The measured value and message are displayed alternately</li> <li>– Measured value display:  -symbol is permanently displayed.</li> </ul> <p>Message display</p> <ul style="list-style-type: none"> <li>– A + 3-digit number such as A122 and</li> <li>– Description</li> </ul>	<ul style="list-style-type: none"> <li>– The measured value and message are displayed alternately</li> <li>– Measured value display:  -symbol flashes.</li> </ul> <p>Message display:</p> <ul style="list-style-type: none"> <li>– W + 3-digit number such as W613 and</li> <li>– Description</li> </ul>	<ul style="list-style-type: none"> <li>– The measured value and message are displayed alternately</li> <li>– Measured value display: see corresponding "Alarm" or "Warning" column</li> </ul> <p>Message display:</p> <ul style="list-style-type: none"> <li>– E + 3-digit number such as E731 and</li> <li>– Description</li> </ul>
Remote operation (FF configuration program/FieldCare)	In the event of an alarm, the ALARM STATUS/ALARM_STATUS <sup>1)</sup> parameter displays a 3-digit number such as 122 for "Sensor connection error, incorrect data".	In the case of a warning, the ALARM STATUS/ALARM_STATUS <sup>1)</sup> parameter displays a 3-digit number such as 613 for "Simulation is active".	In the case of an error, the ALARM STATUS/ALARM_STATUS <sup>1)</sup> parameter displays a 3-digit number such as 731 for "Pmax ALARM WINDOW undershot".

1) FF configuration program: Diagnostic Transducer Block. Menu path FieldCare: OPERATING MENU → MESSAGES

### 9.6.1 Analog Input Block

If the Analog Input Block receives an input or simulation value with the status BAD, the Analog Input Block uses the failsafe mode defined in the FSAFE\_TYPE<sup>1</sup> parameter.

The following options are available by means of the FSAFE\_TYPE parameter:

- Last Good Value  
The last valid value is used for further processing with the status UNCERTAIN.
- Fail SafeValue  
The value specified by means of the FSAFE\_VALUE<sup>1</sup> parameter is used for further processing with the status UNCERTAIN.
- Wrong Value  
The current value is used for further processing with the status BAD.

Factory setting:

- FSAFE\_TYPE: FsafeValue
- FSAFE\_VALUE: 0

The failsafe mode is also activated if the "Out of Service" option was selected by means of the MODE\_BLK parameter, "Target" element.

1 These parameters are not available by means of the FieldCare operating program.

## 9.7 Confirming messages

Depending on the settings for the ALARM\_HOLD\_ON\_TIME/ALARM DISPL. TIME and ACKNOWLEDGE\_ALARM\_MODE/ACK. ALARM MODE parameters, the following measures should be taken to clear a message:

Settings <sup>1)</sup>	Measures
- ALARM_HOLD_ON_TIME// ALARM DISPL. TIME = 0 s - ACKNOWLEDGE_ALARM_MODE /ACK. ALARM MODE = off	- Rectify the cause of the message (see also Section 9.5).
- ALARM_HOLD_ON_TIME/ ALARM DISPL. TIME > n s - ACKNOWLEDGE_ALARM_MODE /ACK. ALARM MODE = off	- Rectify the cause of the message (see also Section 9.5). - Wait for the alarm display time to elapse.
- ALARM_HOLD_ON_TIME// ALARM DISPL. TIME = 0 s - ACKNOWLEDGE_ALARM_MODE /ACK. ALARM MODE = on	- Rectify the cause of the message (see also Section 9.5). - Confirm message using ACKNOWLEDGE_ALARM/ACK. ALARM parameter.
- ALARM_HOLD_ON_TIME/ ALARM DISPL. TIME > n s - ACKNOWLEDGE_ALARM_MODE /ACK. ALARM MODE = on	- Rectify the cause of the message (see also Section 9.5). - Confirm message using ACKNOWLEDGE_ALARM/ACK. ALARM parameter. - Wait for the alarm display time to elapse. If a message appears and the alarm display time elapses before the message has been acknowledged, the message will be cleared once it has been acknowledged.

1) FF configuration program: The parameters are in the Diagnostic Transducer Blocks.  
FieldCare: Menu path for ALARM DISPL. TIME and ACK. ALARM MODE: OPERATING MENU → DIAGNOSTICS → MESSAGES

## 9.8 Repair

The Endress+Hauser repair concept provides for measuring devices to have a modular design and also that the customer may carry out repairs →  92 "Spare Parts" on ).

- For certified devices, please consult the "Repair of Ex-certified devices" section.
- For more information on service and spare parts contact the Endress+Hauser Service.  
(→ See [www.endress.com/worldwide](http://www.endress.com/worldwide).)

## 9.9 Repair of Ex-certified devices

### **WARNING**

#### **Limitation of electrical safety due to incorrect connection!**

Risk of explosion!

When repairing Ex-certified devices, please note the following:

- Only specialist personnel or Endress+Hauser may undertake repairs of certified devices.
- Relevant standards, national hazardous area regulations and Safety Instructions and Certificates must be observed.
- Only genuine Endress+Hauser spare parts may be used.
- When ordering spare parts, please check the device designation on the nameplate. Identical parts may only be used as replacements.
- Electronic inserts or sensors already in use in a standard instrument may not be used as spare parts for a certified device.
- Carry out repairs according to the instructions. After repairs, the device must fulfill the requirements of the specified individual tests.
- A certified device may only be converted to another certified version by Endress+Hauser.
- All repairs and modifications must be documented.

## 9.10 Spare Parts

- Some replaceable measuring device components are identified by means of a spare part nameplate. This contains information about the spare part.
- All the spare parts for the measuring device along with the order code are listed in the W@M Device Viewer ([www.endress.com/deviceviewer](http://www.endress.com/deviceviewer)) and can be ordered. If available, users can also download the associated Installation Instructions.



Measuring device serial number:

- Located on the device and spare part nameplate.
- Can be read out via the "DEVICE SERIAL No" parameter in the "TRANSMITTER DATA" submenu.

## 9.11 Return

The measuring device must be returned if repairs or a factory calibration are required, or if the wrong measuring device has been ordered or delivered. According to legal regulations, Endress+Hauser, as a ISO-certified company, is required to follow certain procedures when handling returned products that are in contact with process fluids.

To ensure swift, safe and professional device returns, please read the return procedures and conditions on the Endress+Hauser website at [www.services.endress.com/return-material](http://www.services.endress.com/return-material).

## 9.12 Disposal

When disposing, separate and recycle the device components based on the materials.

## 9.13 Software history

Date	Software version	Software modifications	Documentation	
			Operating Instructions	Description of Device Functions
08.2008	03.00.zz	Original software. Compatible with: – FieldCare version 2.15.00	BA372P/00/EN/08.08 71066200	BA303P/00/EN/08.08 71076564
			BA372P/00/EN/06.09 71095403	BA303P/00/EN/06.09 71095456
			BA372P/00/EN/05.10 71111763	BA303P/00/EN/05.10 71111814
			BA00372P/00/EN/13.11 71139749	BA00303P/00/EN/13.11 71139808
			BA00372P/00/EN/14.12 71161913	BA00303P/00/EN/13.11 71139808
01.2013	04.00.zz	FF912 Field Diagnostic Profile Integration	BA00372P/00/EN/15.13 71207389	BA00303P/00/EN/14.13 71207399
			BA00372P/00/EN/16.14 71254283	BA00303P/00/EN/14.13 71254484
			BA00372P/00/EN/17.14 71270399	BA00303P/00/EN/15.14 71270408
			BA00372P/00/EN/18.16 71336350	BA00303P/00/EN/16.16 71336364

## 10 Technical data

For technical data, please refer to the Technical Information for Deltapilot S TI00416P.

# Index

## A

Assignment of Transducer Blocks (CHANNEL) ..... 33

## B

Block configuration, delivery status ..... 32

Block model, Deltapilot S ..... 30

## C

Cable specification ..... 21

CHANNEL-Parameter ..... 33

Current consumption ..... 21

## D

Designated use ..... 8

Device addressing ..... 30

Device identification ..... 30

Differential pressure measurement, Quick Setup menu ..... 59

Display ..... 23

## E

Electrical connection ..... 20

Error messages ..... 75

## F

Factory setting ..... 47

FOUNDATION Fieldbus system architecture ..... 28

## G

Grounding ..... 21

## H

Hazardous area ..... 9

HistoROM/M-DAT ..... 43

## I

Incoming acceptance ..... 13

Index tables ..... 35

## K

Keys, onsite, function ..... 26–27

Keys, position ..... 25

## L

Language, selection ..... 52

Level measurement ..... 55

Level measurement, Quick Setup menu ..... 57

Level Quick Setup menu ..... 57

Locking operation ..... 46

## M

Measuring mode, selection ..... 52

Menu structure ..... 40

Methods ..... 39

## N

Nameplate ..... 10

Number of devices ..... 29

## O

Onsite display ..... 23

Operating elements, function ..... 26–27

Operating elements, position ..... 25

Operational safety ..... 8

Overvoltage protection ..... 22

## P

Pipe mounting ..... 16

Position adjustment, FieldCare ..... 54

Position adjustment, onsite ..... 26

Position adjustment, onsite display, FieldCare ..... 54

Pressure Quick Setup menu ..... 59

Product safety ..... 9

## R

Repair ..... 92

Repair of Ex-certified devices ..... 92

Reset ..... 47

Returning devices ..... 92

Rotating the housing ..... 18

## S

Scaling the OUT value ..... 61

Scope of delivery ..... 12

Separate housing, assembly and mounting ..... 17

Shielding ..... 21

Sicherheitshinweise ..... 8

Simulation ..... 47

Software history ..... 93

Spare Parts ..... 92

Storage ..... 13

Supply voltage ..... 21

## T

Troubleshooting ..... 75

## U

Unlocking operation ..... 46

## W

Wall mounting ..... 16

Warnings ..... 75

Workplace safety ..... 8

---

---







[www.addresses.endress.com](http://www.addresses.endress.com)

---