

True RMS Digital Multimeters

EX350 Series

EX350 True RMS Digital Multimeter

EX355 True RMS Digital Multimeter with Temperature

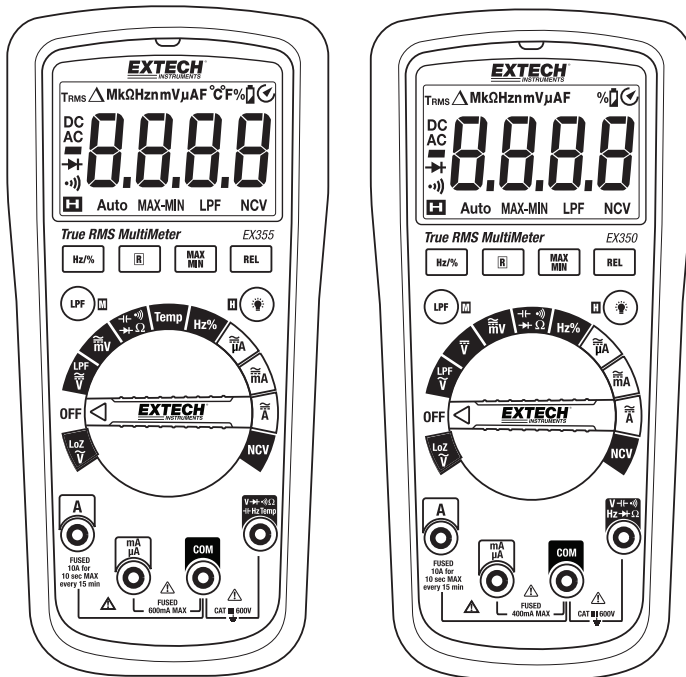

Table of Contents

1. INTRODUCTION	3
2. SAFETY INFORMATION	4
3. DESCRIPTIONS	6
4. OPERATION	9
Powering the Meter	9
Disable Auto Power OFF	9
Display Backlight	9
Data Hold	9
Voltage Measurements	10
10A AC/DC Current Measurements	12
mA/ μ A AC/DC Current Measurements	13
Non-Contact Voltage Detector	14
Resistance Measurements	15
Continuity Measurements	16
Capacitance Measurements	16
Lo Z AC Voltage Measurements	17
Variable Frequency Voltage Measurements	17
Diode Test	18
Temperature Measurements (EX355 only)	19
Hz and % Duty Cycle Test	20
Relative Mode	20
Max Min Mode	20
5. MAINTENANCE	21
6. SPECIFICATIONS	22

1. Introduction

Thank you for selecting the Extech EX350 Series Meter.

The EX350 Series are feature-packed True RMS digital multimeters. In addition to standard DMM features, they offer a Low Impedance (Lo Z) mode, Backlit LCD, Non-Contact Voltage Detector that safely senses electrical sources, Variable frequency voltage measurement, and Temperature (EX355).

This device is shipped fully tested and calibrated and, with proper use, will provide years of reliable service. Please visit our website (www.extech.com) to check for the latest version of this User Guide, Product Updates, Product Registration, and Customer Support.

Features

- 6000 count (EX355) or 4000 count (EX350) digital display
- Large backlit LED display
- True RMS ACV measurements
- Variable Frequency Voltage measurements
- Lo Z mode protects readings from ghost voltages
- Auto and Manual Range modes
- 0.5% DCV accuracy
- Auto Power OFF (APO) with disable function
- Temperature measurements (Model EX355 only) with included temperature probe
- 10A AC/DC current measurements
- Non-Contact Voltage Detector
- Visual and audible continuity measurement alert
- Low battery indicator
- CAT III 600V

2. Safety Information

To ensure the safe operation and service of the meter, follow these instructions closely. Failure to observe warnings can result in severe injury.



WARNINGS

WARNINGS identify hazardous conditions and actions that could cause BODILY HARM or DEATH.

- When handling test leads or probes, keep hands and fingers behind the finger guards at all times.
- Remove test leads from the meter before opening the battery compartment or meter housing.
- Use the meter only as specified in this User Guide or accompanying Quick Start to avoid compromising the protections provided by the meter.
- Be sure to use the proper terminals, switch positions, and ranges when taking measurements.
- Verify the meter's operation by measuring a known voltage. Have the meter serviced if the meter responds unusually or if there are questions regarding the meter's functional integrity.
- Do not apply more than the rated voltage, as marked on the meter, between terminals or between any terminal and earth ground.
- Replace blown fuses with fuses of the same type and rating as specified in this User Guide.
- Use caution working with voltages above 30 VAC RMS, 42 VAC peak, or 60 VDC. These voltages pose a shock hazard.
- To avoid misleading readings that could lead to electric shock and injury, replace the batteries as soon as the low battery indicator is displayed.
- Disconnect power to the circuit under test and discharge all high-voltage capacitors before testing resistance, continuity, diodes, or capacitance.
- Do not use the meter in the presence of explosive gas or vapor.
- To reduce risk of fire or electric shock, do not use the meter if it is wet and do not expose the meter to moisture.
- Individual protective equipment should be used if HAZARDOUS LIVE parts in the installation where measurements are to be carried out could be accessible.













CAUTIONS

CAUTIONS identify conditions and actions that could cause DAMAGE to the meter or equipment under test. Do not expose the meter to extremes in temperature or high humidity.

- Disconnect the test leads from the test points before changing the position of the function (rotary) switch.
- Do not expose the meter to extremes in temperature or to high humidity.
- Never set the meter to the resistance, diode, capacitance, or amp functions when measuring the voltage of a power supply circuit; this could result in meter damage and damage to the equipment under test.

Safety Symbols that are typically marked on meters and instructions

	This symbol, adjacent to another symbol, indicates the user must refer to the manual or user guide for further information.
	Risk of electrical shock
	Fuse symbol
	Equipment protected by double or reinforced insulation
	Low Battery symbol
	Conforms to EU directives
	Do not discard this product in household trash.
	AC measurement
	DC measurement
	Earth ground

PER IEC1010 OVERVOLTAGE INSTALLATION CATEGORY

OVERVOLTAGE CATEGORY I

Equipment of OVERVOLTAGE CATEGORY I is equipment for connection to circuits in which measures are taken to limit the transient over-voltages to an appropriate low level.

Note – Examples include protected electronic circuits.

OVERVOLTAGE CATEGORY II

Equipment of OVERVOLTAGE CATEGORY II is energy-consuming equipment to be supplied from the fixed installation.

Note – Examples include household, office, and laboratory appliances.

OVERVOLTAGE CATEGORY III

Equipment of OVERVOLTAGE CATEGORY III is equipment in fixed installations.

Note – Examples include switches in the fixed installation and some equipment for industrial use with permanent connection to the fixed installation.

OVERVOLTAGE CATEGORY IV

Equipment of OVERVOLTAGE CATEGORY IV is for use at the origin of the installation.

Note – Examples include electricity meters and primary over-current protection equipment

Display Icon Descriptions





- Auto: Automatic range mode
- **HOLD**: Display hold
- Δ : Relative mode
- **AC**: Alternating Current Measurements
- **DC**: Direct Current Measurements
- **8888**: Main display digits
- **A**: Amperes (Current)
- **V**: Volts (Voltage)
- **°C/°F**: Temperature units
- **F**: Farads (Capacitance measurement units)
- **Hz**: Hertz (Frequency measurements unit)
- **% Duty Cycle** (AC only)
- Ω (Ohms): Resistance measurement unit
- **LPF** Variable frequency voltage mode
- : Battery status icon
- - Minus (negative) sign
- **MAX-MIN** Peak Maximum and Minimum reading memory
- : Diode measurement mode
- : Continuity mode symbol
-  Auto Power Off enabled
- Prefixes: μ (micro: 10^{-6}), m (milli: 10^{-3}), n (nano: 10^{-9}), k (kilo: 10^3), M (mega: 10^6)

Fig 3-2 METER DISPLAY



Push-Button Descriptions

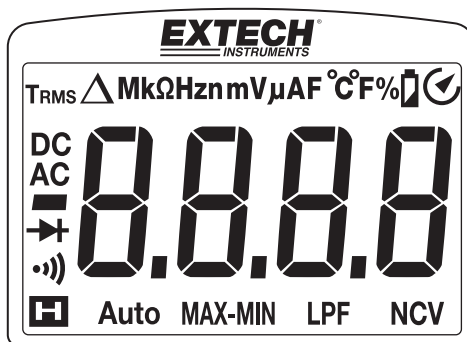

Press the **M** (MODE) button to perform the following:

Switch Position	MODE (M) Button Function
$V \approx$ (EX355)	AC \leftrightarrow DC
$mV \approx$	AC \leftrightarrow DC
μA mA $A \approx$	AC \leftrightarrow DC
$\Omega \leftarrow \rightarrow \right\rangle \rangle \rangle$	$\Omega \leftrightarrow \right\rangle \rangle \rangle \leftrightarrow \leftarrow \rightarrow \rightarrow \rightarrow$
TEMP (EX355)	$^{\circ}C \leftrightarrow ^{\circ}F$



Press and Hold **LPF** in the ACV function to select variable frequency tests.



Press **R** (Range) to switch from Auto to Manual Range. Hold to return to Auto Range.



Press activates Relative Δ mode.



Press to activate Max Min Mode



Press to turn HOLD on/off. Press and Hold to turn backlight on/off



Press to select Hz or % in AC Voltage or AC Current modes

4. Operation



CAUTION: Read and understand all of the Safety statements listed in the safety section of this manual prior to use.

Powering the Meter

1. Turn the rotary function switch to any position to power the meter. Check the batteries if the unit fails to power ON. Refer to the Maintenance section for battery and fuse replacements.
2. Turn the function switch to the OFF position to power OFF the meter.
3. The meter has an Auto Power OFF feature (APO) where the meter switches OFF after 15 minutes of inactivity. When APO is enabled, the APO icon  will show on the display when the meter is powered ON. To disable APO, refer to the next section.

Disable Auto Power OFF

The meter will auto power OFF after 15 minutes of inactivity. To defeat this feature, follow the steps below.

1. With the meter OFF, press and hold the **M** (MODE) button and, while continuing to hold, turn the rotary function switch to any position to power ON the meter.
2. The meter will beep 5 times.
3. Release the button.
4. APO will now be disabled until the next cycle of power.

Display Backlight

With the meter powered ON, press and hold the backlight button  for two seconds to switch the backlight ON or OFF. Note that excessive use of the backlight will shorten the battery life.

When the power supply voltage of the battery falls to 2.6V, the LCD backlight will be faint or unusable; the measurement function can be used normally however.

Data Hold

To freeze the LCD meter reading, press the **H** (HOLD) button. While data hold is active, the **H** display icon appears on the LCD. Press the **H** button to return to normal operation. The **H** icon will switch OFF.

Voltage Measurements



CAUTION: When connecting the test leads to the circuit or device under test, connect the black lead before the red; when removing the test leads, remove the red before the black lead.



For safety, be sure to measure a known voltage before using the instrument on an unknown circuit

AC Voltage Measurements

1. Insert the black test lead banana plug into the negative (COM) jack and the red test lead banana plug into the positive (V/ Ω) jack.
2. Turn the function switch to the $V\sim$ or the $mV\sim$ position.
3. Press the M button to select AC or DC (EX355 only)
4. The meter defaults to the Auto Range mode (Auto displayed on LCD). Press the R button to access the manual range mode. Press the R button to step through the ranges. Press and hold the R button to return to the Auto Range mode (Auto will be displayed).
5. Touch the test probe tips to the circuit under test.
6. Read the digital value of the measurement in the display. The display will also indicate the proper decimal point and measurement type/symbols.
7. Use the Hz/% button to view the frequency (Hz) or the duty cycle (%) of the measured voltage

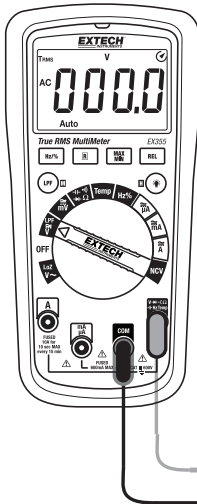

% Duty Cycle Note: Duty Cycle measurements are AC only for this meter. Measurement signals must be 'zero crossing' and must reach -0.7V for the meter to properly display Duty Cycle %.

Fig 4-1 AC VOLTAGE MEASUREMENTS

DC Voltage Measurements

1. Insert the black test lead banana plug into the negative (COM) jack and the red test lead banana plug into the positive (V/ Ω) jack.
2. Move the Function Switch to the **V** or **mV** position.
3. Press the **M** button to select **AC** or **DC**
4. Read the Warning and Caution statements at the beginning of this section to determine whether or not to use the test lead probe covers.
5. Touch the test probe tips to the circuit under test. Be sure to observe the correct polarity (red lead to positive, black lead to negative).
6. The meter defaults to the Auto Range mode (**Auto** displayed on LCD). Press the **R** button to access the manual range mode. Press the **R** button to step through the ranges. Press and Hold the **R** button to return to the Auto Range mode (**Auto** will be displayed).
7. Read the digital value of the measurement in the display. The display will also indicate the proper decimal point and measurement type/units symbols. If the polarity is reversed, the display will show (-) minus before the value.
8. The meter is capable of measuring DC voltages to 600V.

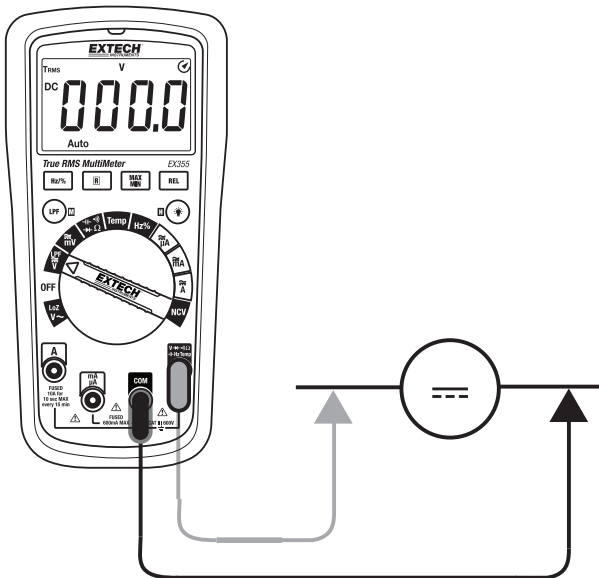

Fig 4-2 DC VOLTAGE MEASUREMENTS

10A AC/DC Current Measurements



WARNING: Do not handle the test leads above the finger/hand guard barrier.



CAUTION: Observe CAT III 600V with respect to Earth Ground.

1. Insert the black test lead into the **COM** terminal and the red test lead into the **A** terminal.
2. Turn the meter's function switch to the **A** position. The **A** symbol will appear on the display indicating Amperes (Amps).
3. Press the **M** button to select **AC** or **DC**.
4. The meter defaults to the Auto Range mode. When in Auto mode, the display shows the **Auto** icon. Press the **R** button to manually range the meter. Press the **R** button to step through the ranges. Press and Hold the **R** button to return to the Auto Range mode.
5. Current measurements must be taken in series with the circuit under test. See accompanying diagram.
6. Touch the black test lead to the negative side of the circuit and the red test lead to the positive side of the circuit.
7. Read the current measurement in the display represented by numerical digits and bar graph. The display will indicate the proper decimal point and value. In DC, if the polarity is reversed, the display will show (-) minus before the value.
8. For AC current, press the **Hz/%** button to view the frequency (Hz) or the duty cycle (%) of the measured current.

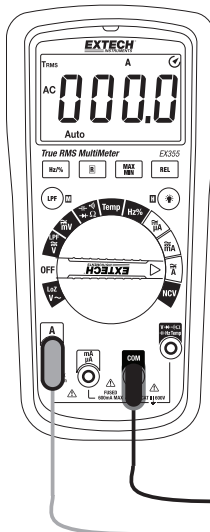

% Duty Cycle Note: Duty Cycle measurements are AC only for this meter. Measurement signals must be 'zero crossing' and must reach -0.7V for the meter to properly display Duty Cycle %.

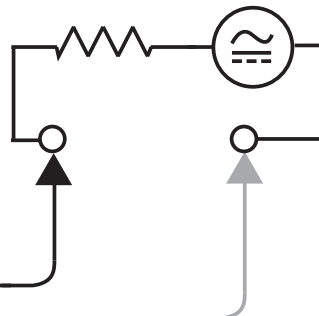

Fig 4-3 AC/DC 10A CURRENT MEASUREMENTS

mA/ μ A AC/DC Current Measurements



WARNING: Do not handle the test leads above the finger/hand guard barrier.



CAUTION: Observe CAT III 600V and with respect to Earth Ground.

1. Insert the black test lead into the **COM** terminal and the red test lead into the **mA/ μ A** terminal.
2. Turn the meter's function switch to the **mA** \approx or **μ A** \approx position. The **mA** or **μ A** units symbol will appear on the display.
3. The meter defaults to the Auto Range mode. When in Auto mode, the display shows the **Auto** icon. Press the **R** button to manually range the meter. Press the **R** button to step through the ranges. Press and Hold the **R** button to return to the Auto Range mode.
4. Press the **M** button to select **AC** or **DC**.
5. Current measurements must be taken in series with the circuit under test. See accompanying diagram.
6. Touch the black test lead to the negative side of the circuit and the red test lead to the positive side of the circuit.
7. Read the current measurement in the display represented by the numerical digits and the bar graph. The display will indicate the proper decimal point and value. In DC, if the polarity is reversed, the display will show (-) minus before the value.

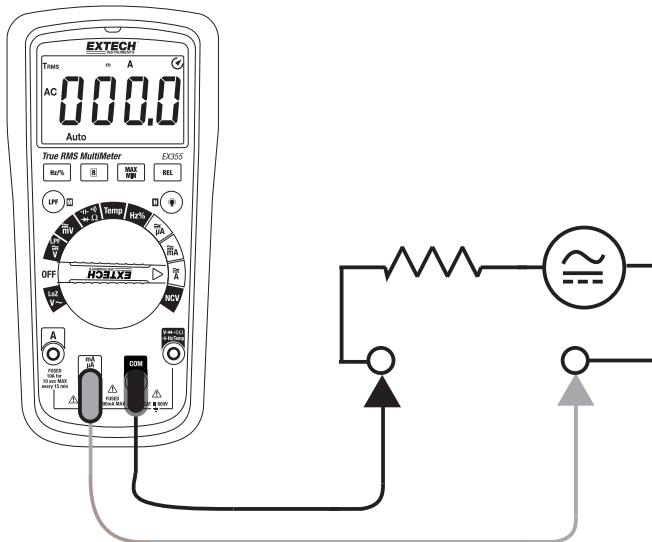

Fig 4-4 mA/ μ A AC/DC CURRENT MEASUREMENTS

Non-Contact Voltage Detector



WARNING: It is possible for voltage to be present in a circuit even if the meter does not beep or flash the NCV LED lamp at the top of the meter. Always verify meter operation on a known live AC current circuit and verify that the batteries are fresh before use.

The audible beeper sounds and the LED lamp at the top of the meter flashes when the meter senses an electrical voltage field.

If the meter does not emit a tone or flash the LED in this mode, there is still the possibility that voltage is present. Please use caution.

1. Turn the function switch to the NCV position to access the Non-Contact Voltage Detect mode.
2. EF is displayed when in this mode is selected.
3. To test, place the meter near a source of electrical energy. Note that the tip of the meter offers the highest sensitivity.
4. If a voltage is detected, the meter will beep, the NCV LED will flash and one or more “-“ will appear on the display. For higher detected voltages the beep and flash rate will increase and the number of “-“ will increase.

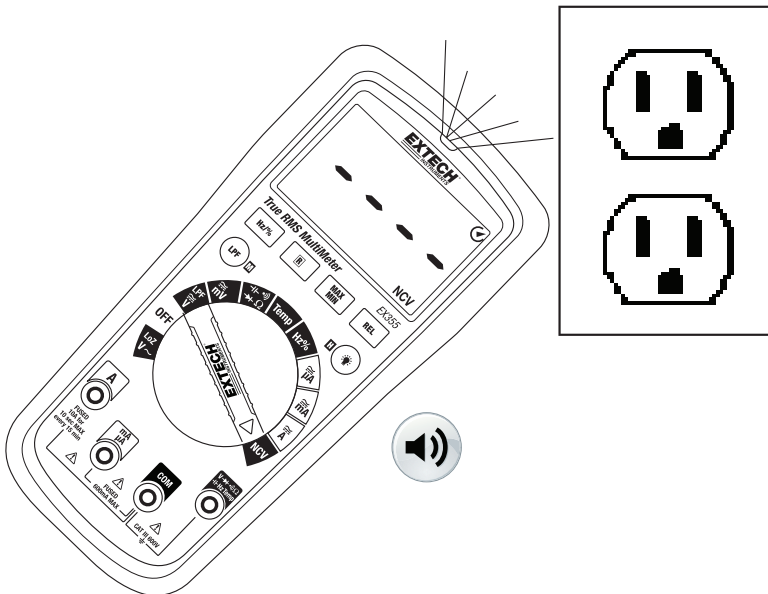

Fig 4-5 NON-CONTACT VOLTAGE DETECTOR

Continuity Measurements

1. Insert the black test lead into the negative COM terminal and the red test lead into the positive terminal.
2. Set the function switch to the))) position.
3. Use the **M** button to select the Continuity mode. Look for the Continuity icon))) on the display.
4. Touch the test probe tips across the wire or circuit under test.
5. The continuity threshold is between 10Ω and 100Ω . For measurements below 10Ω the buzzer will always sound. For measurements above 400Ω (600Ω for EX355) the OL will always display.

Capacitance Measurements

WARNING: To avoid electric shock, remove power to the circuit under test and discharge the capacitor under test before measuring. Do not test on circuits or devices where 60VDC or 30VAC is present.

1. Set the function switch to the ||| capacitance position.
2. Insert the black test lead banana plug into the negative **COM** jack and the red test lead banana plug into the positive ||| jack.
3. Press the **M** button to select the unit of measure symbol **F**.
4. Touch the test probe tips across the part under test.
5. Read the capacitance value in the display.
6. The display will indicate the proper decimal point and value.

Note: For large values of capacitance several seconds may be required before the reading stabilizes.

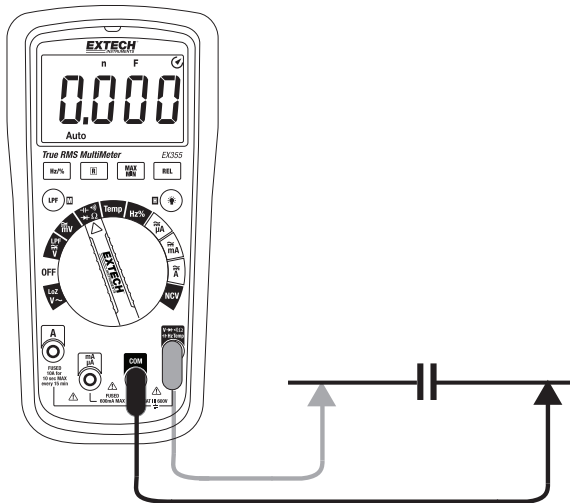

Fig 4-7 CAPACITANCE MEASUREMENTS

LoZ AC Voltage Measurements

When the function switch is turned to the **Lo Z** position, the meter applies a low input impedance circuit to the input terminals to eliminate stray or ghost voltages. Refer to the Voltage Measurements section earlier in this guide for Safety information and connection diagrams.

1. Insert the black test lead banana plug into the negative (COM) jack and the red test lead banana plug into the positive (V/ Ω) jack.
2. Move the Function Switch to the **Lo-Z** position.
3. Touch the test probe tips to the circuit under test.
4. The meter defaults to the Auto Range mode (Auto displayed on LCD). Manual range cannot be used in this mode.
5. Read the digital value of the measurement in the display. The display will also indicate the proper decimal point and measurement type/units symbols.

Variable Frequency Voltage Measurements

When the function switch is turned to the **LPF** position the meter can measure voltage on signals with varying frequency as in Variable Frequency Drives (VFD). Refer to the Voltage Measurements section earlier in this guide for Safety information and connection diagrams.

1. Insert the black test lead banana plug into the negative (COM) jack and the red test lead banana plug into the positive (V/ Ω) jack.
2. Move the Function Switch to the **LPF** position.
3. Select AC voltage
4. Press and Hold the **LPF** button for two seconds. The meter will beep and the **LPF** icon will appear on the display.
5. Touch the test probe tips to the circuit under test.
6. The meter defaults to the Auto Range mode. Manual range cannot be used in this mode.
7. Read the digital value of the measurement in the display. The display will also indicate the proper decimal point and measurement type/units symbols.

Diode Test

1. Insert the black test lead banana plug into the negative **COM** jack and the red test lead banana plug into the **→|** positive jack.
2. Turn the function switch to **→|** position. Use the **M** button to select the diode function if necessary (the diode and voltage symbols will appear on the LCD when in Diode test mode).
3. Touch the test probe tips to the diode or semiconductor junction under test. Note the meter reading.
4. Reverse the test lead polarity by reversing the red and black leads. Note this reading.
5. The diode or junction can be evaluated as follows:
 - If one reading displays a value (typically 0.400V to 0.900V) and reverse reading displays **OL**, the diode is good.
 - If both readings display **OL** the device is open.
 - If both readings are very small or '0', the device is shorted.

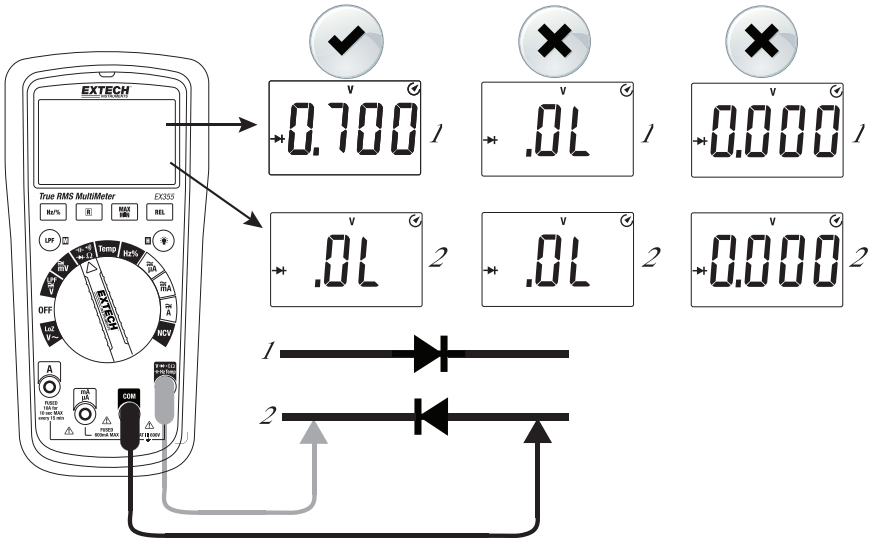

Fig 4-8 DIODE TESTING

Temperature Measurements (EX355 only)

1. Insert the supplied temperature probe into the **COM** (-) and positive (+) terminals observing correct polarity.
2. Turn the function switch to the **Temp** position. Use the **M** button to select the desired unit of measure.
3. Touch the temperature probe tip to the device under test or leave the temperature probe in the open air to measure ambient temperature.
4. Read the temperature measurement on the LCD.



Fig 4-9 TEMPERATURE MEASUREMENTS

Hz and % Duty Cycle Test

Hz and Duty Cycle % are available in the AC Voltage or AC Current functions or can be selected directly in the **Hz%** position of the function switch. Follow the AC voltage or AC Current procedures for operational details.

% Duty Cycle Note: Duty Cycle measurements are AC only for this meter. Measurement signals must be 'zero crossing' and must reach -0.7V for the meter to properly display Duty Cycle %.

Relative Mode

This function applies only to Voltage, Current, Temperature and Capacitance modes. In Relative mode a reference reading can be stored with which to compare subsequent readings. Press the **REL** button to store the displayed reading in memory, this becomes the reference. The symbol Δ will be displayed when the Relative mode is active. Subsequent readings will now be compared to the stored reference (Displayed Reading = Measurement minus Reference). Press the REL button again to exit the Relative mode; the Relative symbol will switch off.

Max Min Mode

Press the MAX MIN button to start recording the Max and Min measured values. The MAX icon will appear on the display. Press the MAX MIN button to step through and view the Max value, the Min value and the Max-Min value. Press and Hold the MAX MIN button for 2 seconds to exit the mode. Max Min is available for Voltage, Current, Resistance and Temperature. Manual range is automatically selected in this mode

5. Maintenance



WARNING: To avoid electrical shock, remove the test leads, disconnect the meter from any circuit and turn OFF the meter before opening the case. Do not operate with an open case.

Battery and Fuse Replacement

Battery Replacement

1. Remove the test leads from the meter.
2. Remove the meter's protective cover.
3. Remove the Phillips head screw that secures the battery compartment at the back of the meter.

Open the battery compartment and replace the two AA batteries observing correct polarity. Re-assemble the meter before use

Safety: Please dispose of batteries responsibly; never dispose of batteries in a fire, batteries may explode or leak. If the meter is not to be used for 60 days or more, remove the battery and store separately.

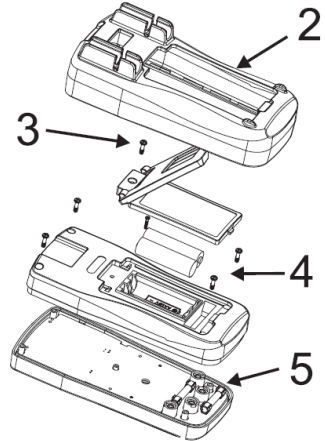

Fig 5-1 BATTERY AND FUSE REPLACEMENT

Fuse Replacement

The 600mA fuse can be replaced from the battery compartment.

4. To replace the 10A fuse, remove the four (4) screws that secure the meter housing. Remove the small Phillips screw in the battery compartment.
5. Replace the fuse with one of the same type and rating. Reassemble the meter before use.



Never dispose of used batteries or rechargeable batteries in household waste. As consumers, users are legally required to take used batteries to appropriate collection sites, the retail store where the batteries were purchased, or wherever batteries are sold.

Disposal: Do not dispose of this instrument in household waste. The user is obligated to take end-of-life devices to a designated collection point for the disposal of electrical and electronic equipment.

Cleaning and Storage

Periodically wipe the case with a damp cloth and mild detergent; do not use abrasives or solvents.

6. Specifications

ELECTRICAL SPECIFICATIONS

Accuracy is given as \pm (% of reading + least significant digit) at 23°C \pm 5°C with relative humidity lower than 80%. Accuracy is specified for a period of one year after calibration.

1. Temperature Coefficient is 0.1 x specified accuracy / °C, < 18°C (64.5°F), > 28°C (82.4°F)
2. AC Functionality: ACV and ACA specifications are AC coupled, True RMS, 45 to 400Hz; For non-sinusoidal waveforms, additional accuracy Crest Factor (C.F.) considerations exist as detailed below:

Add 3.0% for C.F. 1.0~2.0; Add 5.0% for C.F. 2.0~2.5; Add 7.0% for C.F. 2.5~3.0

Function	Range		Resolution	Accuracy
DC Voltage	EX350	EX355		
	40.00mV	600.0mV	10 μ V	\pm (0.7% + 5 digits)
	400.0mV	600.0mV	0.1mV	\pm (0.5% + 2 digits)
	4.000V	6.000V	1mV	\pm (0.5% + 3 digits)
	40.00V	60.00V	10mV	
	400.0V	600.0V	0.1V	
	600V	600V	1V	
<i>Input Impedance: 10M (1GΩ for mV range); Overload Protection: AC/DC 600V</i>				
AC Voltage	40.00mV	600.0mV	10 μ V	\pm (1.0% + 3 digits)
	400.0mV	600.0mV	0.1mV	
	4.000V	6.000V	1mV	\pm (0.8% + 3 digits)
	40.00V	60.00V	10mV	
	400.0V	600.0V	0.1V	
	600V	600V	1V	\pm (1.0% + 3 digits)
LPF	400.0V	600.0V	0.1V	\pm (4.0% + 3 digits)
LoZ	600V	600V	-----	\pm (1.2% + 5 digits)
Maximum input voltage: \pm 600Vrms Input impedance: 10M Ω for all ranges (ACV frequency response is 45~400Hz) Allow the meter to stabilize for 10 minutes after using LoZ (low impedance) mode Accuracy stated for 5 to 100% of range				

Function				
DC Current	Range		Resolution	Accuracy
μA	EX350	EX355	0.1μA	±(0.7%+2 digits)
	400.0μA	600.0μA		
	4000μA	6000μA		
mA	40.00mA	60.00mA	10μA	
	400.0mA	600.0mA	0.1mA	
A	4.000A	6.000A	1mA	
	10.00A	10.00A	10mA	
Overload protection: μA mA range: (F1) fuse (6.3×32)mm: FF 0.6A H 600V (CE) fast acting 10A range: (F2) fuse (6.3×32)mm: F 10A H 600V (CE) fast acting				
AC Current	Range		Resolution	Accuracy
μA	EX350	EX355	0.1μA	±(1.0%+3 digits)
	400.0μA	600.0μA		
	4000μA	6000μA		
mA	40.00mA	60.00mA	10μA	
	400.0mA	600.0mA	0.1mA	
A	4.000A	6.000A	1mA	
	10.00A	10.00A	10mA	
ACA Frequency Response: 45~400Hz				

Function	Range		Resolution	Accuracy
Resistance	EX350	EX355		
400.0Ω*	400.0Ω*	600.0Ω*	0.1Ω	±(1.0%+2 digits)
4.000kΩ	4.000kΩ	6.000kΩ	1Ω	±(0.8%+2 digits)
40.00kΩ	40.00kΩ	60.00kΩ	10Ω	
400.0kΩ	400.0kΩ	600.0kΩ	100Ω	
4.000MΩ	4.000MΩ	6.000MΩ	1kΩ	±(1.2%+3 digits)
40.00MΩ	40.00MΩ	60.00MΩ	10kΩ	±(1.5%+5 digits)
Range: The measured value = displayed value of measurement - the short-circuit value of the probe Open-circuit voltage is approx.: *1V; overload protection: 600V-PTC				

Capacitance	Range	Resolution	Accuracy
	6.000nF	1pF	In REL mode: ± (4%+10 digits)
	60.00n F to 600.0µF	10pF to 0.1µF	± (4%+5 digits)
	6.000mF to 60.00mF	1µF to 10µF	± 10%
Overload protection: 600V-PTC To optimize accuracy, if the measured capacitance is $\leq 1\mu\text{F}$ use the REL measurement mode			
Frequency	9.999Hz to 9.999MHz	0.001Hz to 0.001MHz	± (0.1%+5)
Duty Cycle	0.1%~99.9%	0.1%	Unspecified
Overload protection: 600V-PTC Input amplitude (a): (DC level is zero) $\leq 100\text{kHz}$: $100\text{mVrms} \leq a \leq 20\text{Vrms}$ $> 100\text{kHz} \sim 1\text{MHz}$: $200\text{mVrms} \leq a \leq 20\text{Vrms}$ $> 1\text{MHz}$: $500\text{mVrms} \leq a \leq 20\text{Vrms}$ $> 5\text{MHz} \sim 10\text{MHz}$: $900\text{mVrms} \leq a \leq 20\text{Vrms}$ Duty cycle%: Applies to frequency measurements only ($\leq 100\text{kHz}$) Frequency for Voltage or Current functions: Frequency $< 1\text{kHz}$ AC voltage: input amplitude of mV range $\geq 100\text{mV}$, input amplitude of V range \geq the range $\times 6\%$ AC current: input amplitude (a): 4000/6000µA, 400/600mA, 10A range: a \geq the range $\times 6\%$, 400/600µA, 40/60mA, 4/6A range: a \geq the range $\times 60\%$			

Function	Resolution	Remarks
Continuity	0.1Ω	Continuity threshold is 10Ω ~ 100Ω. For measurements $< 10\Omega$ the buzzer will sound. For measurements $> 400\Omega$ ($> 600\Omega$ EX355) the OL symbol will display.
Diode	1mV	Open-circuit voltage is approx.: 3.2V. Typical voltage of a silicon PN junction is in the range of: 0.5 to 0.8V

Temperature EX355	Range	Resolution	'Accuracy
°C	-40 to 0°C	1°C	±3 °C
	>0 to 100°C		± (1.0%+3)
	>100 to 1000°C		± (2.0%+3)
°F	-40 to 32°F	1°F	±5°F
	>32 to 212°F		± (1.5%+5)
	>212 to 1832°F		± (2.5%+5)

Type-K thermocouple probe required.

The maximum temperature range for the supplied probe is 230°C/446°F.

GENERAL SPECIFICATIONS

Display	EX350 4000 count, EX355 6000 count Multi-Function LCD
Over-range indication	"OL" is displayed
Conversion rate	2 to 3 updates per second
Maximum Voltage	600VAC RMS or 600V DC maximum applied to any terminal
Polarity indication	Automatic: positive implied, negative indicated (-)
Low battery indication	 is displayed.
Auto Power OFF	After 15 minutes (can be disabled by holding the M [MODE] button while turning the meter ON)

Operating Temperature and Humidity

-10~10°C (32 to 104°F)
0 to 30°C (30 to 86°F); <75%RH maximum
30 to 40°C (86 to 104°F); <50%RH maximum

Storage Temperature and Humidity

-10° to 50°C (14° to 122°F); <80%RH maximum (with battery removed)

Operating Altitude 2000m (6562')

Battery power (2) AA batteries (battery life 130 hours typical with alkaline battery types)

Fuse protection 10A terminal (F2): F 10A H 600V quick-break fuse (6.3x32) mm
mA, μ A terminal (F1): FF 600mA H 600V quick-break fuse (6.3x32) mm

Weight Including battery 407g (14.36oz)

Dimensions (W x H x D) 180 x 86 x 55.6 mm (7.1 x 3.4 x 2.2 in.)

Safety Standards Complies with CSA STD C22.2 NO.60101-1, 61010-2-030, IEC61010-2-033, CAT III 600V, Pollution Degree 2

EMC EN61326-1

For Indoor Use

Copyright © 2015 FLIR Systems, Inc.

All rights reserved including the right of reproduction in whole or in part in any form
ISO-9001 Certified

www.extech.com