

F30 Ex ic Adaptor

Accessory for F300 range of Megablocks

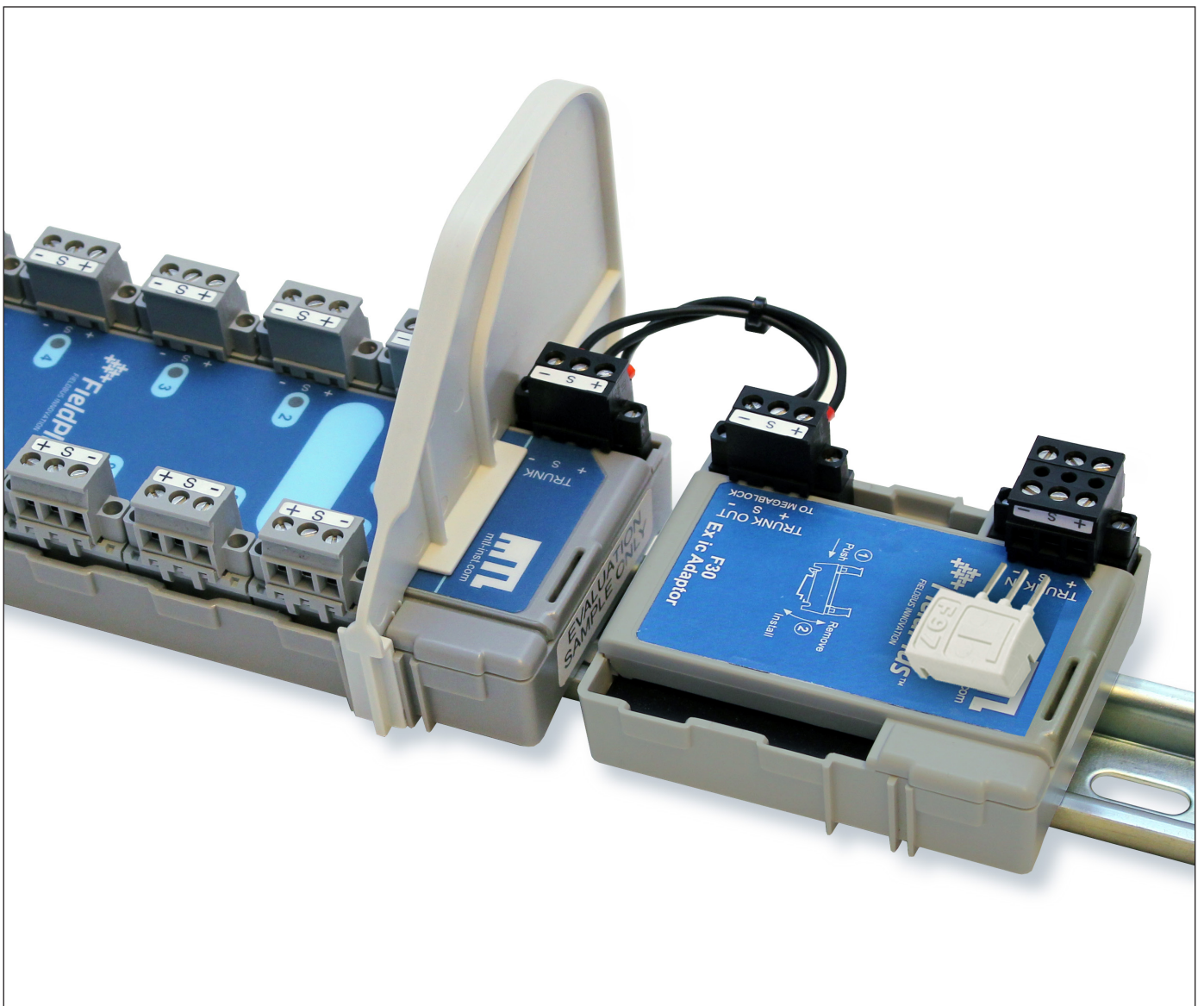

DECLARATION OF CONFORMITY

A printed version of the Declaration of Conformity has been provided separately within the original shipment of goods. However, you can find a copy of the latest version at <http://www.mtl-inst.com/certificates>

CONTENTS

	DECLARATION OF CONFORMITY	II
	GENERAL SAFETY INFORMATION	IV
1	OVERVIEW	1
2	DESCRIPTION	2
2.1	The Ex ic concept	2
2.2	The F30 adaptor	2
2.3	Power supplies	3
2.4	Host H1 control system	3
3	MECHANICAL	3
3.1	Enclosures	3
3.2	Installation	4
4	ELECTRICAL CONNECTIONS	5
4.1	Trunk connectors	6
4.2	Terminator	6
4.3	Trunk partition	7
4.4	IP30 cover for trunk terminals	7
4.5	Spur port connections	
4.6	Cable screen connections	7
4.7	Surge protection	8
4.8	Extending the fieldbus segment	9
5	TESTING	10
6	ROUTINE MAINTENANCE	10
7	ATEX SAFETY INSTRUCTIONS	11
7.1	General	11
7.2	Installation	11
7.3	Inspection and maintenance	11
7.4	Repair	12
7.5	Marking	12
8	Appendix 1 - Installation Drawing	13



GENERAL SAFETY INFORMATION

The following methods are used in this manual to alert the user to important information:-

	WARNING ! Warnings are provided to ensure operator safety and MUST be followed.
	CAUTION Cautions are provided to prevent damage to the instrument.
	NOTE These are used to give general information to ensure correct operation.

SAFETY INSTRUCTIONS FOR INSTALLATION AND OPERATING PERSONNEL

The operating instructions provided here contain **essential safety instructions** for installation personnel and those engaged in the operation, maintenance and servicing of the equipment.

	WARNING ! Failure to comply with these instructions can endanger the lives or health of personnel and risk damage to the plant and the environment.
	WARNING ! The responsibility for planning, installation, commissioning, operation and maintenance, particularly with respect to applications in explosion-hazard areas, lies with the plant operator.

Before commencing installation or commissioning:

- Read and understand the contents of this manual and the product datasheet
- Ensure installation and operating personnel have received adequate training for this task
- Ensure that any operating instructions are fully understood by the personnel responsible.
- Observe national and local installation and mounting regulations (e.g. IEC 60079-14).

	WARNING ! If these assemblies have been used previously in general electrical installations, they MAY NOT be used in explosion-hazard area applications.
---	---

During operation:

- Make the relevant instructions available at all times to the operating personnel.
- Observe safety instructions.
- Observe national safety and accident prevention regulations.
- Operate the equipment within its published specification.
- Servicing, maintenance work or repairs not described in this manual must not be performed without prior agreement with the manufacturer.
- Any damage to this equipment may render its explosion protection null and void.
- No changes to any of the components that might impair their explosion protection are permitted.

If any information provided here is not clear:

- Contact Eaton's MTL product line or one of its representatives.

NOTE Improper installation and operation of the enclosure can result in the invalidation of the guarantee.
--

F30 Ex ic Adaptor

F300 Fieldbus Device Couplers Accessory

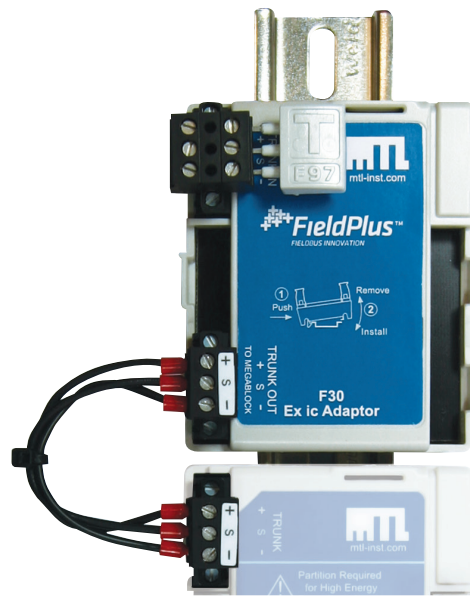

Figure 1.1 - F30 Ex ic Adaptor

1 OVERVIEW

This manual explains the installation and maintenance procedures for the F30 Ex ic Adaptor and should be read in conjunction with the product datasheet that contains the electrical data.

The F30 Ex ic Adaptor is an accessory that works with MTL F300 range of DIN-rail mounted, passive device couplers and extends their usage by enabling them to provide Ex ic spur connections in Zone 2 hazardous areas. The F300 device couplers provide a simple means of connecting a group of local field devices to the network trunk cable that carries the signal and provides the necessary power supply.

This manual also introduces the concept of the Ex ic intrinsic safety method of protection and explains how it applies to the F300 device couplers and the F30 Ex ic adaptor. Other topics will include the trunk power supply and suggested enclosures for housing the adaptor and hubs in the hazardous area.

NOTE

The user/installer should also refer to the following datasheets and installation manuals:

- *F300 range of Megablocks data sheet, EPS F300*
- *F300 range of Megablocks installation manual, INM F300*
- *918x Redundant Power Supply data sheets, EPS 918x*
- *Redundant Power Supply installation manuals, INM 918x in order to obtain details of their installation, operating parameters and usage.*

2 DESCRIPTION

2.1 The Ex ic concept

In May 2013 the Ex nL certification method was removed from the IEC60079-15 standard, and replaced by intrinsic safety method Ex ic in IEC60079-11. Although Ex ic and Ex nL are broadly similar, Ex ic brings with it additional requirements that are associated with the wider intrinsic safety approach.

Ex ic is a new level of protection under the intrinsic safety protection method, suitable for use in Zone 2 only, where Ex ic circuits may be 'live-worked' in the presence of a flammable atmosphere. It follows the same energy-limitation principles as all intrinsically safe circuits, but safety is maintained only in 'normal operation'.

Level of protection	Zone of use	
Ex ia	Zone 0	Safe with 2 faults
Ex ib	Zone 1	Safe with 1 fault
Ex ic	Zone 2	Safe with no faults (i.e. safe in normal operation)

To comply with the withdrawal of the Ex nL technique, the ATEX Ex nL marking has been removed from the F300 Megablocks.

2.2 The F30 adaptor

The F30 adaptor is connected in series with the trunk wiring to the Megablock (see Figure 2.1) and limits the voltage to ensure that the 'U_o' at the Megablock spurs is less than the 17.5V value required for compatibility with FISCO-certified instruments. Where the voltage arriving at the F30 is higher than this (for example, if the trunk cable is only short in length resulting in only a small voltage drop in the cable), the F30 regulates the voltage to less than 17.5V. Final current limiting for each spur is provided by the short-circuit limiting circuits built in to the F300 Megablock, for which Ex ic approval already exists. As a result, the combination of F30 and F300 meets the requirements for Ex ic voltage and current limitation.

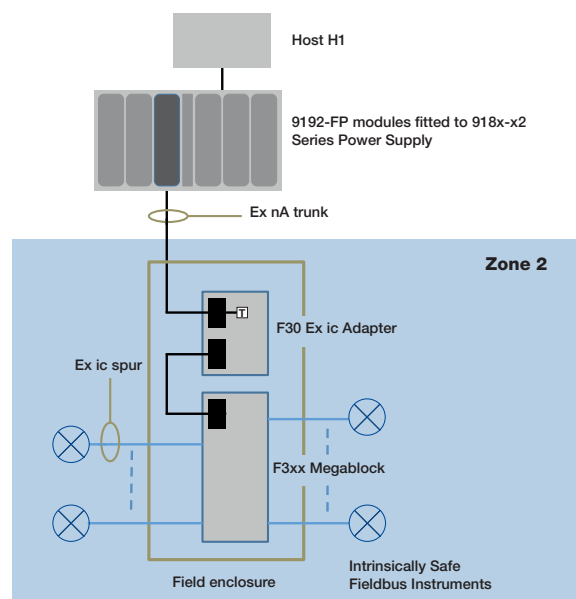

Figure 2.1 - Basic connection of F30 adaptor in trunk wiring to Megablock

The F30 is designed for use **only with** MTL F304, F308 and F312 Megablock types, typically providing up to **twelve** Ex ic spurs per fieldbus segment. These spurs may be all from one F312 Megablock in one enclosure, or distributed between two separate enclosures – see Section 4.7.

The spurs are compatible with FISCO and Entity certified fieldbus instruments, and where FISCO instruments are selected, cable parameter calculations are not required.

2.3 Power supplies

For Ex ic spur applications, the F30 and associated Megablock must be supplied by 9192-FP power supply modules in simplex or redundant configuration. The 9192-FP module has the necessary voltage limiting and is designed to fit on one of the backplanes from the 918x-x2 range of fieldbus power supply systems, all of which are capable of providing n+1 redundancy for maximum availability.

The 918x family of redundant power supplies contains a range of solutions to suit different host interfaces, consult Eaton for the model appropriate to the host and install the chosen model in accordance with the instructions provided with it.

2.4 Host H1 control system

In a typical network installation using the F30 Ex ic Adaptor, F300 Megablock and 9192-FP power supply module, the H1 interface of the host control system is electrically connected in parallel with the fieldbus trunk circuit. The H1 interface and host control system are not required to carry hazardous area certification in this application, but they must comply with electrical safety standards IEC61010 or IEC60950. Apparatus carrying a CE mark will comply with this requirement. This requirement also applies to any other apparatus that is connected electrically in parallel with the fieldbus trunk circuit.

3 MECHANICAL

3.1 Enclosures

An enclosure is required to house and protect the Megablock device coupler and the F30 Ex ic adaptor for field operation. The type of enclosure must be chosen to suit both the hazardous atmosphere likely to be encountered and the general conditions appropriate to its environmental exposure. For installation in hazardous areas, the enclosure must meet the requirements of a recognised method of protection according to IEC 60079-0, clause 1. In addition, the following conditions should always be considered to ensure safe and reliable operation.

- a) Prevent any form of pollution that could compromise the operation.
- b) Provide an adequate level of mechanical protection. This can be achieved by selecting a protected location, a suitable enclosure, or a combination of both.
- c) Ensure that all cable entries and connections are secure by making provision for the careful routing and securing of all cables.
- d) Provide adequate security against unauthorized interference.
- e) Conform to the permitted ambient operating temperature range of -40°C to $+70^{\circ}\text{C}$.

3.1.1 Outdoor mounting

In addition to the general requirements above, if the F30 and F300 Megablock is mounted in an outdoor location, use a suitable enclosure with a minimum of IP54 ingress protection. A higher level of ingress protection rating will be necessary if the working atmosphere is, or can be, corrosive, or if the enclosure is subject to wet or dusty environments.

Eaton has suitable enclosures that may be chosen from the FCS-8000 (GRP) or FCS-9000 (stainless steel) ranges. Refer to the table below to choose an appropriate size enclosure to accommodate the F300 range of Megablock models and F30 adaptor.

Enclosure model(s)	Will accommodate:
FCS-8504/ FCS-9504	F30 + F304 Megablock
FCS-8512/ FCS-9512	F30 + F308 Megablock
FCS-8524/ FCS-9524	2 x F30 + F312 Megablock x 2
FCS-8512	F30 + F312 Megablock
FCS-9542	F30 + F312 Megablock

3.2 Installation

Mounting orientation for the F30 adaptor is not important except that it must be mounted at the Trunk end of the F300 Megablock to facilitate the trunk wiring.

3.2.1 DIN-rail mounting

The F30 and F300 modules are designed for mounting on 35mm x 7.5mm T-section "top hat" DIN rail to EN50022 and use built-in DIN-rail clips to attach to the rail.

3.2.2 Mounting procedure

The modules are attached to the DIN rail using a "push-and-tilt" method- as illustrated on the body label and in Figure 3.1 below.

Tilt the module towards the trunk-connector side of the module and then engage the DIN-rail clips under the ledge of the DIN rail. Push the module against the edge of the rail then rotate the module until it sits flat onto the DIN rail, then release the pressure to allow the clips on the other side to engage.

3.2.3 Removal from DIN-rail

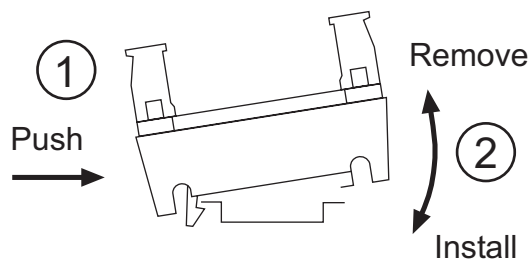

Figure 3.1 - DIN Rail Installation and Removal

Referring to Figure 3.1, push the module against the edge of the DIN rail, tilt the other side of the module up and away from the DIN rail, then release the side pressure to disengage the DIN rail clips from the DIN rail ledge.

4 ELECTRICAL CONNECTIONS

All terminals on the F30 Ex ic adaptor and F300 Megablock device coupler are pluggable, with securing screws. F300 range of Megablocks are available in a choice of screw terminal or spring clamp connectors, which are specified at the time of ordering; however, the F30 satisfies both screw terminal and spring clamp connector applications automatically because the 'Trunk In' connector will be transferred from the Megablock to the F30 during installation. The cable assembly between the F30 and the Megablock is preassembled and supplied with the F30.

Type	Conductor size
Screw terminals	0.14 to 2.5mm ²
Spring clamp terminals (-PC)	0.20 to 2.5mm ²

NOTE

A torque screwdriver set between 0.5- 0.6Nm is recommended for tightening all terminal screws.

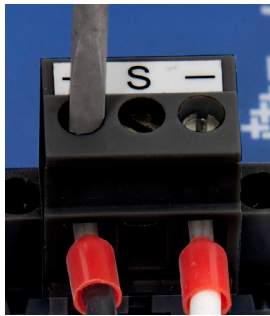

Figures 4.1 – Screw clamp terminals

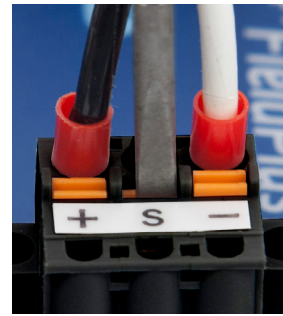

Figures 4.2 – Spring clamp terminals

NOTE

When wiring to spring-clamp terminals, use a screwdriver with a 3-4 mm blade to depress the spring-clamp button before inserting the termination cable. See Figure 4.2.

For reliable operation, the wire type and ferrule (if used) must be compatible with the spring clamp connector mechanism.

4.1 Trunk connectors

Before connecting the incoming fieldbus trunk cable carry out the following procedure. With F30 and F3xx Megablock installed similar to that shown in Figure 4.3a below, unscrew and remove the 'TRUNK' connector from the Megablock and install it on the F30 in the 'TRUNK IN' position. Take the link wire and connectors provided with the F30 and install them in the manner shown in Figure 4.3b. Ensure that the screws securing each connector are all tightened after this procedure.

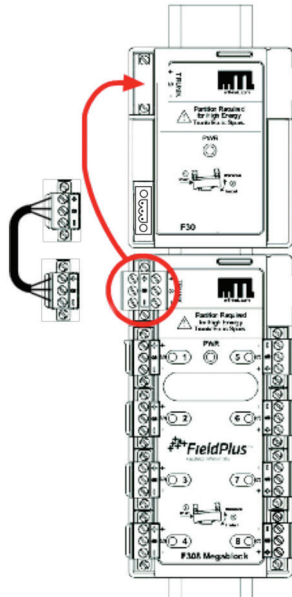

Figure 4.3a

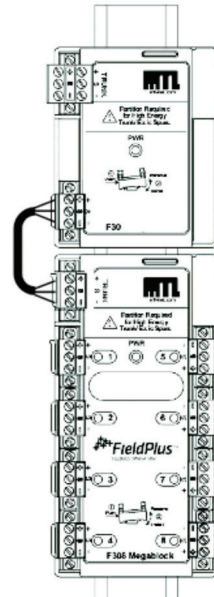
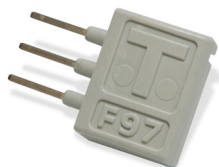

Figure 4.3b

The 'TRUNK' connector has two sets of (+), (-) and cable screen (S) connections that are linked internally. The second connection enables the user to extend the trunk to a second F30, as described later in Section 4.7, and avoids having to break the connection if an "upstream" F30 module needs to be removed.

The second connection is also used to install an F97 terminator (see Section 4.2 below) when the F30 is at the end of the segment. See also Section 4.5 for information on cable screen grounding.

4.2 Terminator



An F97 terminator (pictured) is provided with each F300 Megablock. This should now be installed on the F30 'TRUNK IN' connector, as mentioned above, in order to correctly terminate the bus. The terminator is inserted in the second ('inside') set of terminals on the trunk connector, which positions it over the body of the F30.

For screw terminals, loosen the screws, insert the terminator so that the moulded logo is visible and then tighten the screws. The F97 terminator has no specific polarity but inserting it with the 'T' visible clearly identifies the component, and its purpose.

When not in use, the F97 should be stored in the convenient storage slot provided in the F30 body close to the trunk connection.

	WARNING ! It is not permitted to connect or disconnect the trunk wiring in a hazardous area without a gas clearance certificate or unless the circuit to which it is connected has been de-energised.
---	--

4.3 Trunk partition

A trunk-spur partition* must be installed to provide the required 50mm separation between the non-intrinsically safe trunk terminals and the Ex ic spur terminals. See Figure 4.5.

** available in packs of five as Part No. F300-A01-5*

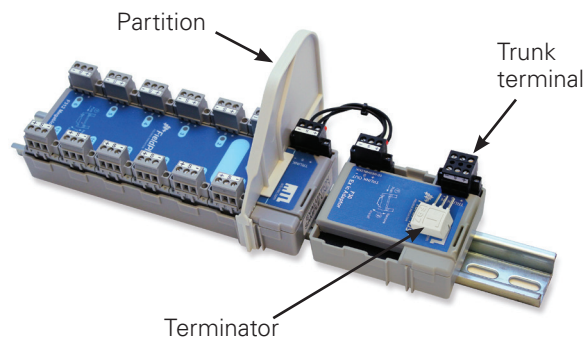

Figure 4.5: Trunk partition in position

Position the partition between the Trunk and spur connectors on the Megablock as shown in Figure 4.4 and locate the fingers into the channels on the sides of the device body. Press the partition onto the body until the fingers click into place at the bottom of the case- see Figure 4.5. The channels have different sizes so the partition cannot be installed backwards.

4.4 IP30 cover for trunk terminals

Where the F30 Adaptor and its associated Megablock are installed inside an enclosure, international standard IEC60079-14 requires the trunk connectors on the Adaptor and Megablock to have an additional cover. The cover must have an ingress protection rating of at least IP30, and have a warning label stating "Warning: non-intrinsically safe terminals protected by IP30 cover";

4.5 Spur port connections

Each spur port connector provides (+), (-) and cable screen (S) connections. See the next section for information on cable screen grounding.

4.6 Cable screen connections

The 'S' screen terminals for the trunk and the spurs are interconnected/communed within the F30 and F3xx Megablock and should be grounded at only one point for the whole segment (i.e. a single-point ground). The position recommended by Eaton for that connection is in the control room close to the power supply at the DCS, or else in accordance with local system practice.

4.7 Surge protection

Surge protection is available for the Trunk IN connector using the same FS32 component (see image) that is used to protect the Megablocks. The user is referred to the INM F300 manual for complete information on protecting the F3xx Ex ic spurs, but protection for the incoming Ex nA F30 trunk wiring is provided here.



Figure 4.6- FS32 surge protector

NOTE

Install the trunk-spur partition (Section 4.3) before mounting the FS32 surge protection modules adjacent to it.

A mounting bracket, known as a "grounding bar", should be fitted into the ready moulded position on the F30. Specify part number F300-BAR-5 (pack of 5) for this application. Consult also the installation manual for the F300 range of Megablocks for additional information.

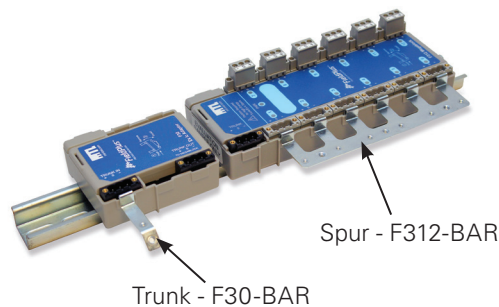

Figure 4.7- Typical grounding bars

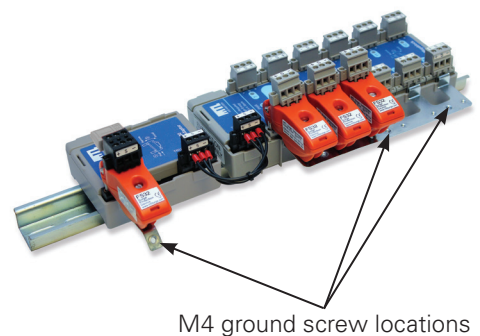

Figure 4.8- With some FS32 modules

1. Remove and retain the pluggable TRUNK IN terminal.
2. Locate the grounding bar lug in the moulded position on the side of the F30 and press it firmly into place- see Figure 4.7.
3. Use an M4 screw and ring terminal to connect the grounding bar to a suitable low-impedance ground point- see Figure 4.8.
4. Mount an FS32 into the empty Trunk socket and tighten its two plug screws, then tighten the central screw into the grounding bar.
5. Insert the pluggable Trunk terminal into the FS32 and tighten its securing screws.

4.8 Extending the fieldbus segment

Most applications will be satisfied by one F3xx Megablock, supplied via an F30, in a single enclosure; however, if necessary, it is possible to distribute the spurs between a maximum of two separate enclosures, as shown in Figure 4.7.

In this case, it should be noted that each enclosure will require an F30 to supply its associated Megablock because the onward trunk connection will still be rated Ex nA.

To extend the trunk connection to a second enclosure, follow these steps.

- Remove any F97 terminator that may be fitted on the trunk terminal of the first enclosure and store it in the slot provided on the F30.
- Use the available second set of terminals on the trunk connector in the first enclosure to onward connect the trunk wiring to the second enclosure- as shown in Figure 4.7.
- Fit an F97 terminator in the trunk connector in the second enclosure (as shown) to ensure the correct termination of the trunk wiring.

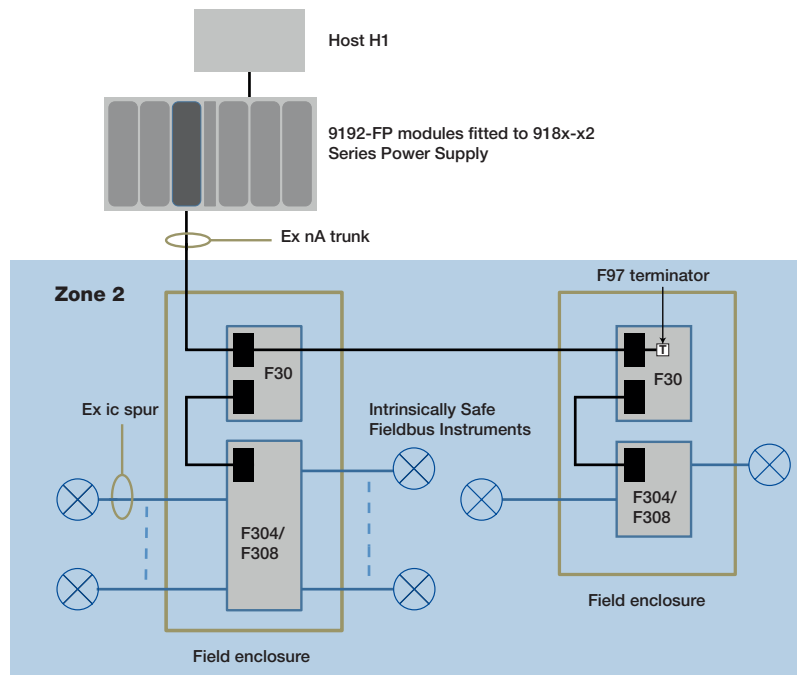



Figure 4.7 – Segment extension using 2 x F30 adaptors

5 TESTING

There are no specific field tests for the F30. Carry out the checks specified in the F300 range of Megablocks installation manual regarding the Power and Spur indicators to confirm correct operation.

6 ROUTINE MAINTENANCE

	WARNING ! Plastic parts can store static charge. Clean only with a damp cloth to prevent static build-up.
---	--

	WARNING ! It is not permitted to connect or disconnect the trunk wiring in a hazardous area without a gas clearance certificate or unless the circuit to which it is connected has been de-energised.
---	--

Check the general condition of the installation periodically to make sure that no deterioration has occurred. At least every two years (and more frequently for particularly harsh environments) check that:

- there is no appreciable build up of dust or dirt on the enclosure
- cables, wire connections, terminations, and screens are in good condition
- all enclosure fixing bolts and gland nuts are tight
- the F300 range of Megablocks has the green Power LED lit but that no red spur LEDs are lit
- there are no internal or external signs of damage or corrosion present

7 ATEX SAFETY INSTRUCTIONS

The following information is in accordance with the Essential Health and Safety Requirements (Annex II) of the EU Directive 2014/34/EU [the ATEX Directive- safety of apparatus] and is provided for those locations where the ATEX Directive is applicable.

7.1 General

a) This equipment must only be installed, operated and maintained by competent personnel. Such personnel shall have undergone training, which included instruction on the various types of protection and installation practices, the relevant rules and regulations, and on the general principles of area classification. Appropriate refresher training shall be given on a regular basis. [See clause 4.2 of EN 60079-17].

b) This equipment has been designed to provide protection against all the relevant additional hazards referred to in Annex II of the directive, such as those in clause 1.2.7.

c) This equipment has been designed to meet the requirements of EN 60079-15.

7.2 Installation

a) The installation must comply with the appropriate European, national and local regulations, which may include reference to the code of practice EN 60079-14. In addition, particular industries or end users may have specific requirements relating to the safety of their installations and these requirements should also be met. For the majority of installations the Directive 1999/92/EC [the ATEX Directive- safety of installations] is also applicable.

b) This apparatus may be installed in a safe area and also in a Zone 2 location providing that the relevant installation conditions are met. When mounted in a Zone 2 location the apparatus must be provided with an enclosure, which offers an additional degree of protection appropriate to the area classification.

c) Unless already protected by design, this equipment must be protected by a suitable enclosure against:

i) mechanical and thermal stresses in excess of those noted in the certification documentation and the product specification ii) aggressive substances, excessive dust, moisture and other contaminants.

	<p>WARNING !</p> <p>When installed in Zone 2 hazardous area, the F30 must be mounted in an enclosure that maintains an ingress protection of at least IP54. Installation must be in accordance with Control Drawing SCI-1073-refer to Appendix 1 at the back of this manual.</p>
---	--

7.3 Inspection and maintenance

a) Inspection and maintenance should be carried out in accordance with European, national and local regulations which may refer to the standard EN 60079-17. In addition specific industries or end users may have specific requirements which should also be met.

b) Access to the internal circuitry must not be made during operation.

7.4 Repair

This product cannot be repaired by the user and must be replaced with an equivalent certified product.

7.5 Marking

Each device is marked in compliance with the Directive.

This information applies to products manufactured during or after the year 2013.

Typical certification marking

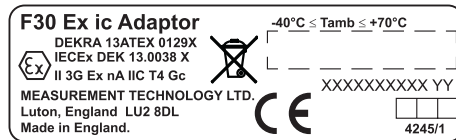

7.6 Special conditions for safe use

When installed in an explosive gas atmosphere, the Ex ic voltage limiter, type F30 Ex ic adaptor shall be placed in an enclosure that meets the requirements of an appropriate, recognized type of protection in accordance with EN 60079-0.

APPENDIX 1 INSTALLATION DRAWING

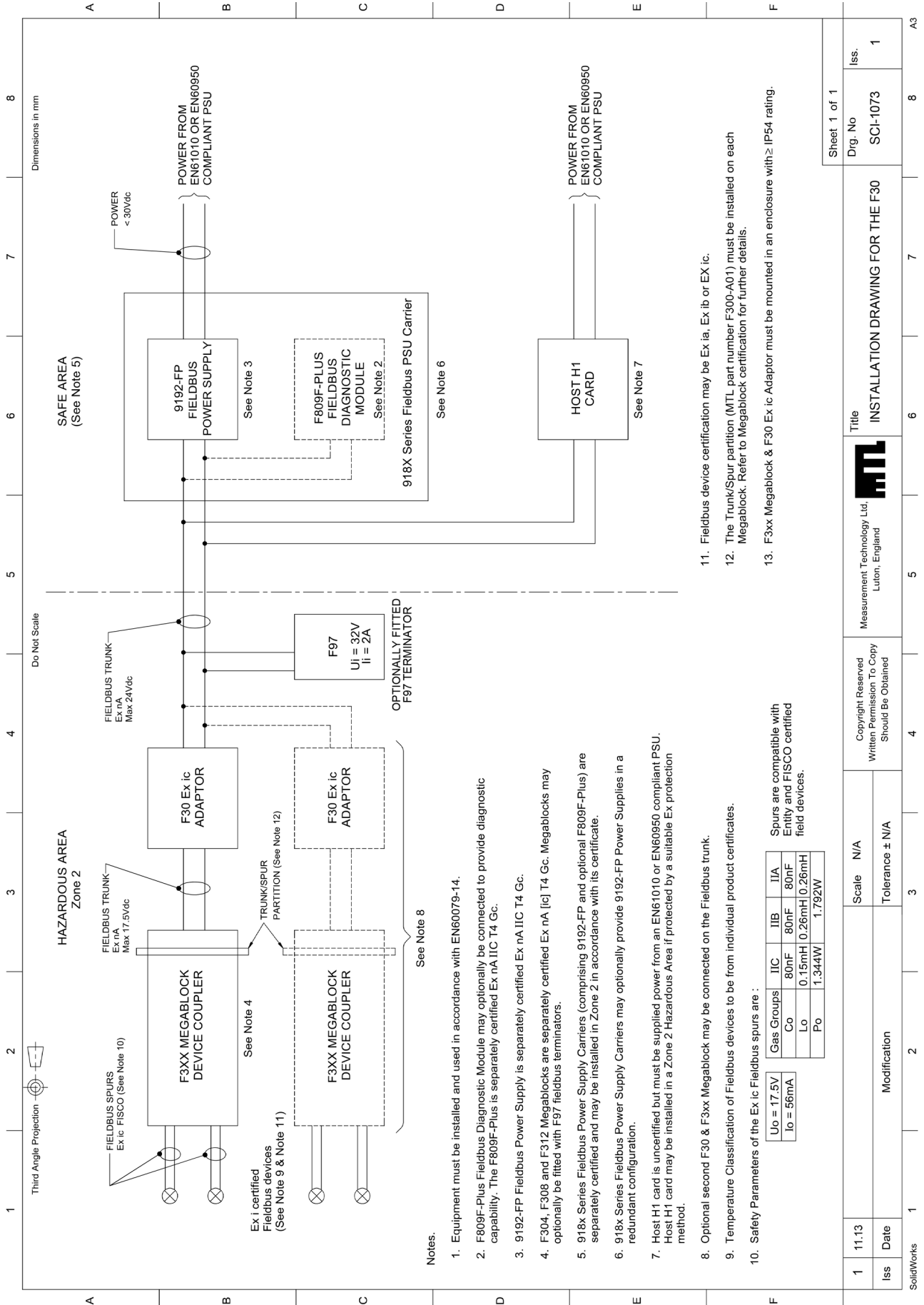

11. Fieldbus device certification may be Ex ia, Ex ib or EX ic.
12. The Trunk/Spur partition (MTL part number F300-A01) must be installed on each Megablock. Refer to Megablock certification for further details.
13. F3xx Megablock & F30 Ex ic Adaptor must be mounted in an enclosure with \geq IP54 rating.

1	11.13	Scale	N/A	Copyright Reserved Written Permission To Copy Should Be Obtained	Measurement Technology Ltd. Luton, England	Title	INSTALLATION DRAWING FOR THE F30	Sheet 1 of 1
Iss	Date	Modification	Tolerance \pm N/A				Drg. No	SCI-1073
SolidWorks							Iss.	1

AUSTRALIA

MTL Instruments Pty Ltd,
10 Kent Road, Mascot, New South Wales, 2020, Australia
Tel: +61 1300 308 374 Fax: +61 1300 308 463
E-mail: mtl-salesanz@eaton.com

BeNeLux

MTL Instruments BV
Ambacht 6, 5301 KW Zaltbommel
The Netherlands
Tel: +31 (0)418 570290 Fax: +31 (0)418 541044
E-mail: mtl.benelux@eaton.com

CHINA

Cooper Electric (Shanghai) Co. Ltd
955 Shengli Road, Heqing Industrial Park
Pudong New Area, Shanghai 201201
Tel: +86 21 2899 3817 Fax: +86 21 2899 3992
E-mail: mtl-cn@eaton.com

FRANCE

MTL Instruments sarl,
7 rue des Rosiéristes, 69410 Champagne au Mont d'Or
France
Tel: +33 (0)4 37 46 16 53 Fax: +33 (0)4 37 46 17 20
E-mail: mtlfrance@eaton.com

GERMANY

MTL Instruments GmbH,
Heinrich-Hertz-Str. 12, 50170 Kerpen, Germany
Tel: +49 (0)22 73 98 12-0 Fax: +49 (0)22 73 98 12-2 00
E-mail: csckerpen@eaton.com

INDIA

MTL India,
No.36, Nehru Street, Off Old Mahabalipuram Road
Sholinganallur, Chennai- 600 119, India
Tel: +91 (0) 44 24501660 /24501857 Fax: +91 (0) 44 24501463
E-mail: mtlindiasales@eaton.com

ITALY

MTL Italia srl,
Via San Bovio, 3, 20090 Segrate, Milano, Italy
Tel: +39 02 959501 Fax: +39 02 95950759
E-mail: chmninfo@eaton.com

JAPAN

Cooper Crouse-Hinds Japan KK,
MT Building 3F, 2-7-5 Shiba Daimon, Minato-ku,
Tokyo, Japan 105-0012
Tel: +81 (0)3 6430 3128 Fax: +81 (0)3 6430 3129
E-mail: mtl-jp@eaton.com

NORWAY

Norex AS
Fekjan 7c, Postboks 147,
N-1378 Nesbru, Norway
Tel: +47 66 77 43 80 Fax: +47 66 84 55 33
E-mail: info@norex.no

RUSSIA

Cooper Industries Russia LLC
Elektrozavodskaya Str 33
Building 4
Moscow 107076, Russia
Tel: +7 (495) 981 3770 Fax: +7 (495) 981 3771
E-mail: mtlrussia@eaton.com

SINGAPORE

Cooper Crouse-Hinds Pte Ltd
No 2 Serangoon North Avenue 5, #06-01 Fu Yu Building
Singapore 554911
Tel: +65 6 645 9888 Fax: +65 6 487 7997
E-mail: sales.mtlsing@eaton.com

SOUTH KOREA

Cooper Crouse-Hinds Korea
7F, Parkland Building 237-11 Nonhyun-dong Gangnam-gu,
Seoul 135-546, South Korea.
Tel: +82 6380 4805 Fax: +82 6380 4839
E-mail: mtl-korea@eaton.com

UNITED ARAB EMIRATES

Cooper Industries/Eaton Corporation
Office 205/206, 2nd Floor SJ Towers, off. Old Airport Road,
Abu Dhabi, United Arab Emirates
Tel: +971 2 44 66 840 Fax: +971 2 44 66 841
E-mail: mtlgulf@eaton.com

UNITED KINGDOM

Eaton Electric Ltd,
Great Marlings, Butterfield, Luton
Beds LU2 8DL
Tel: +44 (0)1582 723633 Fax: +44 (0)1582 422283
E-mail: mtlenquiry@eaton.com

AMERICAS

Cooper Crouse-Hinds MTL Inc.
3413 N. Sam Houston Parkway W.
Suite 200, Houston TX 77086, USA
Tel: +1 281-571-8065 Fax: +1 281-571-8069
E-mail: mtl-us-info@eaton.com